

Preface

Thank you for purchasing Hytera DMR Digital Portable Radio. As a product built to the DMR standard, it is endowed with ergonomic design, all-round digital functions and remarkable quality to refresh your experience and enable you to be responsive to emergent situations.

To derive optimum performance from your product, please read this manual and the supplied Safety Information Booklet carefully before use.

This manual is applicable to the following model:

PD70X

PD70XG



Instructional Icons

This radio is not intended for use by general population in an uncontrolled environment. It is only for occupational use and only applied to work-related conditions.

The radio must be only used by users, who are fully aware of the hazards of the exposure and who are able to exercise control over their RF exposure to qualify for the higher exposure limits.

The following icons are available through this manual:

Alert Icons



Caution: indicates situations that could cause damage to your product.



Note: indicates tips that can help you make better use of your product.

Function Icons



: indicates functions that are available on digital channel only.



: indicates functions that are available on analog channel only.

Functions marked with no function icons are available on both analog and digital channels.

Term Explanation

Key Operation

Short press: to press a key and release it quickly.

Long press: to press a key and remain holding it down for a predefined period (2 seconds by default).

Hold down: to press a key and remain holding it down.

Private Call

Private Call is a call initiated by a single user to another user.

Group Call

Group Call is a call initiated by a single user to a group.

All Call

All Call is a call initiated by a single user to all the other users on a channel.

Squelch

This technology can remove excessive background noises, improving your communication quality.

Copyright Information

Hytera and HYT are trademarks or registered trademarks of Hytera Communications Co., Ltd. (“Hytera”) in PRC and/or other countries or areas. Hytera retains the ownership of its trademarks and product names. All other trademarks and/or product names that may be used in this manual are properties of their respective owners.

The Hytera product described in this manual may include Hytera computer programs stored in memory or other media. Laws in PRC and/or other countries or areas protect the exclusive rights of Hytera with respect to its computer programs. The purchase of this product shall not be deemed to grant, either directly or by implication, any rights to the purchaser with respect to Hytera computer programs. Any Hytera computer programs may not be copied, modified, distributed, decompiled, or reverse-engineered in any manner without the prior written consent of Hytera.

The AMBE+2™ voice coding technology embodied in this product is protected by intellectual property rights including patent rights, copyrights and trade secrets of Digital Voice Systems, Inc.

This voice coding technology is licensed solely for use within this product. The user of this technology is explicitly prohibited from attempting to decompile, reverse engineer, or disassemble the Object Code or in any other way convert the Object Code into a human readable form.

U.S. Patent Nos. #6,912,495 B2, #6,199,037 B1, #5,870,405, #5,826,222, #5,754,974, #5,701,390, #5,715,365, #5,649,050, #5,630,011, #5,581,656, #5,517,511, #5,491,772, #5,247,579, #5,226,084 and #5,195,166.

Disclaimer

Hytera endeavors to achieve the accuracy and completeness of this manual, but no warranty of accuracy or reliability is given. All the specifications and designs are subject to change without prior notice due to continuous technology development. No part of this manual may be copied, modified, translated, or distributed in any manner without the express written permission of Hytera.

If you have any suggestions or would like to learn more details, please visit our website at: <http://www.hytera.cn>.

RF Energy Exposure Compliance

- Your radio is designed and tested to comply with a number of national and international standards and guidelines (listed below) regarding human exposure to radio frequency electromagnetic energy. This radio complies with the IEEE and ICNIRP exposure limits for occupational/controlled RF exposure environment at operating duty factors of up to 50% transmitting and is authorized by the FCC for occupational use only. In terms of measuring RF energy for compliance with the FCC exposure guidelines, your radio radiates measurable RF energy only while it is transmitting (during talking), not when it is receiving (listening) or in standby mode.
- The device complies with SAR and/or RF field strength limits of RSS-102 requirement.

Your radio complies with the following of RF energy exposure standards and guidelines

- United States Federal Communications Commission, Code of Federal Regulations; 47CFR part 2 sub-part J
- American National Standards Institute (ANSI)/Institute of Electrical and Electronic Engineers (IEEE) C95. 1-1992
- Institute of Electrical and Electronic Engineers (IEEE) C95. 1-1999 Edition
- International Commission on Non-Ionizing Radiation Protection (ICNIRP) 1998

Operational Instructions and Training Guidelines

- To ensure optimal performance and compliance with the occupational/controlled environment RF energy exposure limits in the above standards and guidelines, users should transmit no more than 50% of the time and always adhere to the following procedures; and should transmit no more than 50% of the time, although the hardware support transmission up to 100% of the time in analog mode and up to 50% in digital mode.

The radio may use Chest Pack(LCBN13) as optional assessor, The chest Pack provide an extra protection to the operator under RF exposure due to special measures taken during design and manufacturing process. Chest Pack is designed to allow the radio only stick to it with belt-clip.the belt-clip will provide necessary distance between antenna and operator's body. The operator should follow Chest Pack usage instruction to ensure compliance with RF energy exposure limits.

Transmit and Receive

To transmit (talk), push the Push-To-Talk (PTT) key; to receive, release the PTT key.

EU Regulatory Conformance

The equipment is in compliance with the essential requirements and other relevant provisions of the Directive 1999/5/EC.

CE 06780



Note: The above information is applicable to EU countries only.

FCC Licensing Information

Part 15 Compliance









This equipment has been tested and found to comply with the limits for a Class B digital device, pursuant to part 15 of the FCC Rules. These limits are designed to provide reasonable protection against harmful interference in a residential installation. This equipment generates, uses and can radiate radio frequency energy and, if not installed and used in accordance with the instructions, may cause harmful interference to radio communications. However, there is no guarantee that interference will not occur in a particular installation. If this equipment does cause harmful interference to radio or television reception, which can be determined by turning the equipment off and on, the user is encouraged to try to correct the interference by one or more of the following measures:

- ✚ Reorient or relocate the receiving antenna.
- ✚ Increase the separation between the equipment and receiver.
- ✚ Connect the equipment into an outlet on a circuit different from that to which the receiver is connected.
- ✚ Consult the dealer or an experienced radio/TV technician for help.

FCC Licensing Requirements

A license from Federal Communications Commission is required prior to use. Your dealer will program each radio with your authorized frequencies, signaling codes, etc., and will be there to meet your communications needs as your system expands. Contact your dealer for more information.

Contents

Checking Items in the Package	7
Product Overview	8
Product Controls	8
Programmable Keys	8
Before Use	10
Charging the Battery	10
Assembling the Accessories	11
Status Indication	13
LED Indicator	13
Basic Operations	14
Turning the Radio On/Off	14
Adjusting the Volume	14
Selecting a Zone	14
Selecting a Channel	14
Switching the Channel Mode	14
Call	15
Private Call 	15
Group Call 	15
All Call 	15
Calls on Analog Channels 	16
Functions and Operations	17
Adjust Power Level	17
Scan	17
Talk Around	18
Monitor 	18
Squelch Off 	18
Emergency	18
Adjust Squelch Level 	22
Battery Power Indicator	22
Man Down (optional)	22
Scrambler  /Encrypt 	23
Busy Channel Lockout	23

Time-out Timer (TOT)	23
Pseudo Trunking 	23
MIC AGC	24
Troubleshooting.....	25
Care and Cleaning	27
Optional Accessories.....	28

Checking Items in the Package

Please unpack carefully and check that all items listed below are received. If any item is missing or damaged, please contact your dealer.

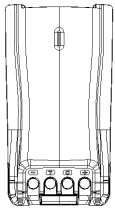

Battery

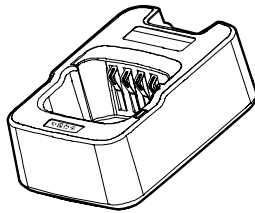

Charger

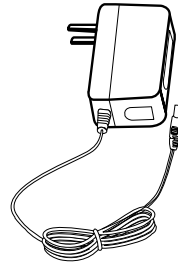

Power Adapter



Antenna

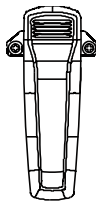

Belt Clip

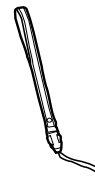

Strap

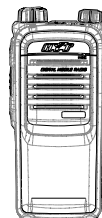

Radio Unit

Owner's Manual/ Safety Information Booklet



Note: The antenna may vary with different frequency bands. And the frequency band is marked on the label of antenna; if not, please refer to the label on the radio unit for frequency band information.

Product Overview

Product Controls

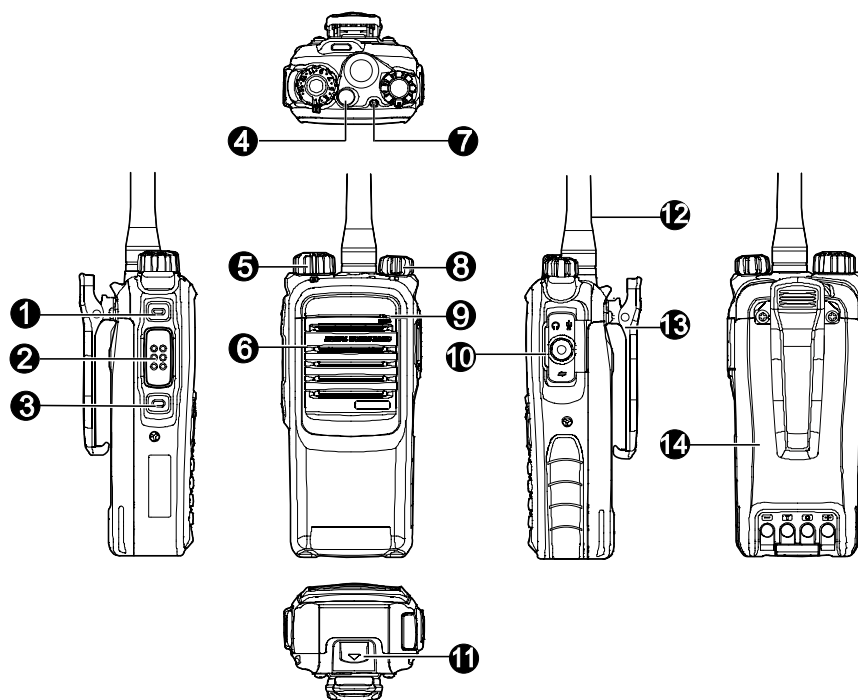







① SK1 (Side Key)	② PTT Key	③ SK2 (Side Key)	④ TK (Top Key)
⑤ Channel Selector Knob	⑥ Speaker	⑦ LED Indicator	⑧ Radio On-Off/Volume Control Knob
⑨ Microphone	⑩ Accessory Jack	⑪ Battery Latch	⑫ Antenna
⑬ Belt Clip	⑭ Battery		

Programmable Keys

For enhanced convenience, you may request your dealer to program the keys **SK1**, **SK2**, and **TK** as shortcuts to the functions listed below:

No.	Shortcut Keys	Description
1	Zone Up	To select a desired zone quickly
2	Zone Down	
3	Adjust Power Level	To adjust power level quickly

4	Talk Around	To directly communicate with other radios
5	Monitor 	To adjust the condition for incoming signal match
6	Monitor Momentary 	
7	Squelch Off 	To always unmute speaker no matter whether carrier is present or not
8	Squelch Off Momentary 	
9	Scan	To receive signals on other channels
10	Nuisance Temporary Delete	To temporarily ignore unwanted channel activity
11	Emergency	To summon help in emergent situations
12	Adjust Squelch Level 	To temporarily adjust the squelch threshold required for the radio to unmute
13	Battery Power Indicator	To indicate the battery strength
14	Man Down	To activate Emergency in the case that the radio is positioned aslant for a preset time period due to an unexpected situation
15	Scrambler  /Encrypt 	To encrypt your voice so as to guarantee privacy of your communication



Note:

- (1) Long and short press of a key can be assigned with different functions by your dealer.
- (2) The **TK** is programmed as the **Emergency** key by default, and is programmable by your dealer.

Before Use

Charging the Battery

Use only the charger and battery specified by Hytera. Charger LED can indicate the charging process.

Charge Diagram

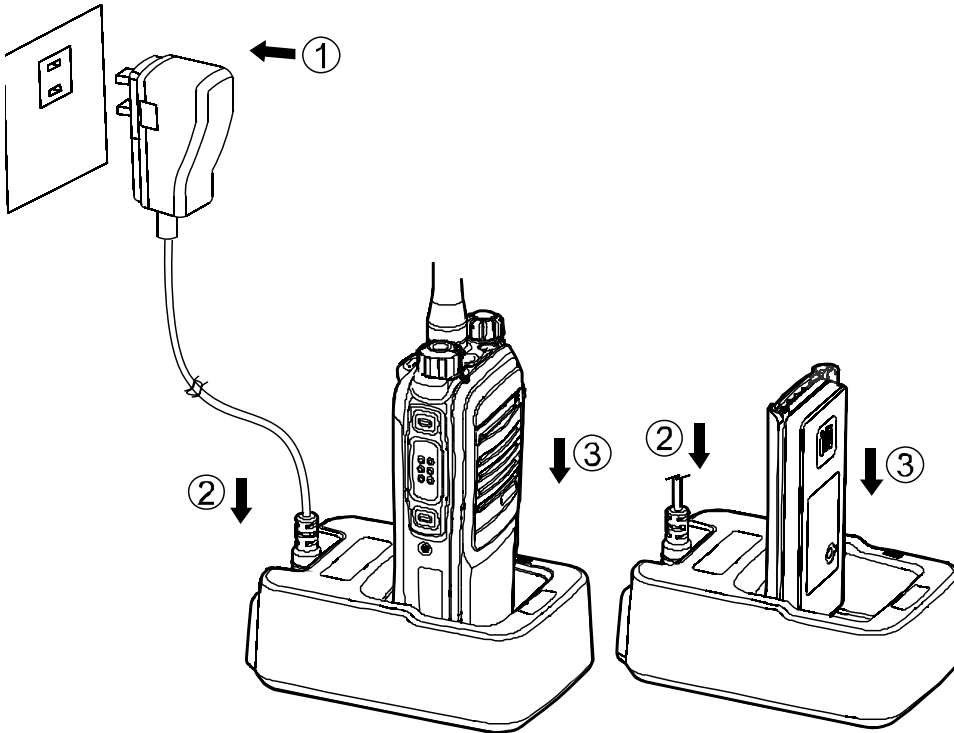

Procedures

1. Connect the power adapter to AC source. See arrow ①.
2. Plug the power adapter into the rear socket of the charger. See arrow ②.
3. Place the radio with the battery attached, or the battery alone, into the charger.
4. The charging process initiates when LED glows red, and is completed when LED glows green.



Note: To achieve optimal battery performance, please charge the battery for 5 hours before initial use.

Charge Indicator

LED Indicator	Charge Status
---------------	---------------

Red LED flashes slowly.	Standby (no load)
Red LED glows.	Charging
Orange LED glows.	90% charged
Green LED glows.	Fully charged
Red LED flashes rapidly.	Failure



Caution: Be sure to read the Safety Information Booklet, to get necessary safety information.

Assembling the Accessories

Attaching the Antenna

Turn the antenna clockwise to fasten it.

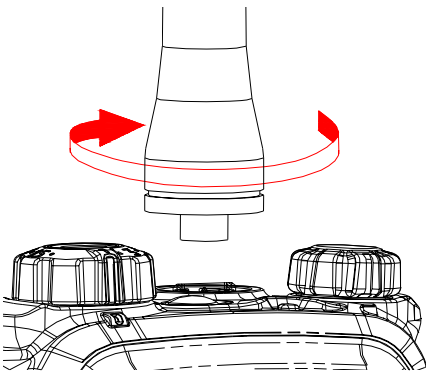

To remove the antenna, rotate it counter-clockwise.

Attaching the Battery

1. Insert the battery into top of the radio. See arrow ①.
2. Slightly press the bottom of the battery until a click is heard. See arrow ②.

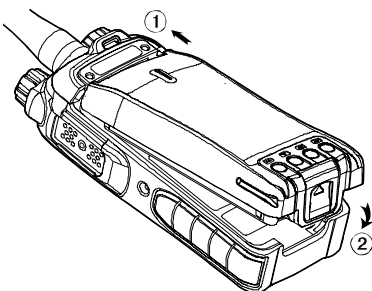

To remove the battery, turn off the radio first. Then slide the battery latch upwards to unlock the battery.

Attaching the Belt Clip

1. Remove the screws.
2. Align the screw holes on the belt clip with those on the radio's body, and then tighten the screws.

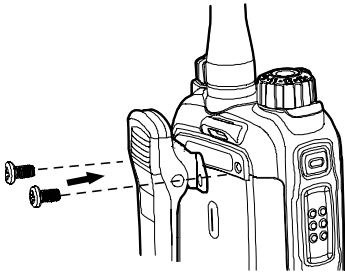

To remove the belt clip, loosen the screws.

Attaching the Audio Accessory/Programming Cable

1. Open the accessory jack cover as the arrow shown.
2. Align the plug with the accessory jack.
3. Tighten the screw on the plug.

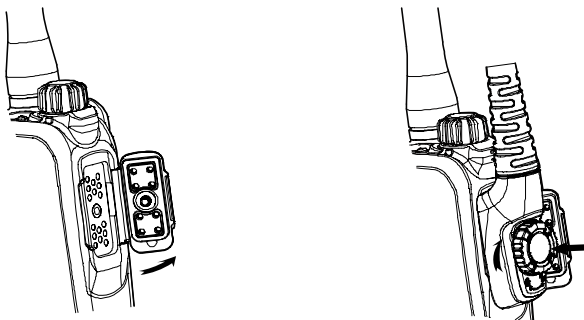

To remove accessories, loosen the screw.



Caution: When you are using an external accessory, waterproof performance of the radio may get affected.

Status Indication

LED Indicator

The top LED indicator will help you easily identify the current radio status.

LED Indicator	Radio Status
LED flashes green.	Powering on
LED glows red.	Transmitting
LED glows green.	Receiving
LED flashes green slowly.	Scanning
LED flashes orange rapidly.	Emergency
LED glows orange.	Call ended (within the preset time period)

Basic Operations

Turning the Radio On/Off

Rotate the **Radio On-Off/Volume Control** knob clockwise/counter-clockwise until a click is heard to turn the radio on/off.

Adjusting the Volume

After turning the radio on, rotate the **Radio On-Off/Volume Control** knob clockwise to increase the call volume, or counter-clockwise to decrease it.

Selecting a Zone

A zone is a group of channels exhibiting the same property, and is programmed by your dealer. The radio supports 3 zones: Zone 1, Zone 2 and Zone 3. Each zone contains 16 channels at most.

You may quickly toggle to your desired zone by pressing the programmed **Zone Up** or **Zone Down** key. In the process, you will hear one alert tone for Zone 1, two alert tones for Zone 2 and three alert tones for Zone 3.

Selecting a Channel

Rotate the **Channel Selector** knob to select a desired channel.

Switching the Channel Mode

Each channel can be programmed as either analog channel or digital channel. If the current zone includes both analog and digital channels, you may quickly switch between digital and analog through the **Channel Selector** knob.

Call

To ensure optimal volume of the receiving radio, hold the radio approximately 2.5 to 5 centimeters away from your mouth.

Private Call

Transmitting a Private Call

In standby mode, hold down the **PTT** key to transmit a Private Call to the Private Call contact preset for the current channel.



Note: Your dealer may preset a contact for each digital channel. The preset contact could be a Private Call contact, a Group Call contact or an All Call contact.

Receiving and Responding to a Private Call

When a Private Call is received, you can listen to it without any operation, and you may hold down the **PTT** key within the preset time period to call back.

Group Call

Transmitting a Group Call

In standby mode, hold down the **PTT** key to transmit a Group Call to the Group Call contact preset for the current channel.

Receiving and Responding to a Group Call

When a Group Call is received, you can listen to it without any operation, and you may hold down the **PTT** key within the preset time period to call back.

All Call

Transmitting an All Call

In standby mode, hold down the **PTT** key to transmit an All Call to the All Call contact preset for the current channel.



Note: You can transmit an All Call only when it is enabled by your dealer.

Receiving an All Call

When an All Call is received, you can listen to it without any operation.



Note: You cannot respond to an All Call.

Calls on Analog Channels



To transmit on an analog channel, hold down the **PTT** and speak into the microphone. To receive, release the **PTT** key.

Functions and Operations

Adjust Power Level

With this feature, you may switch power levels quickly. Generally, we recommend you to adopt low power for battery saving. However, if you cannot communicate with radios located at a distant place with low power, please select high power.

Operation:

Press the programmed **Adjust Power Level** key to switch between high power and low power (from low power to high power: a high-pitched tone sounds; from high power to low power: a low-pitched tone sounds).

Scan

This feature allows you to listen to communication activities on other channels so that you can keep a close track of your team members.

Operation:

1. To enable the feature, press the programmed **Scan** key in standby mode (a high-pitched tone sounds); or

Switch to a channel on which the feature “Auto Scan” is enabled via the programming software.

2. After the feature is enabled, your radio will scan according to the scan list set for the channel on which scanning starts. The scanning process is as follows:

- During scanning, the LED flashes orange.
- When activities are detected on a channel, the radio will stay on the channel to receive current activities, and the LED glows green.
- If you don't want to hear activities on the channel, press the programmed **Nuisance Temporary Delete** key to remove the channel from the scan list temporarily.
- If you want to continue staying on the channel, press the programmed **Monitor** or **Squelch Off**

key during scan stay.



3. To exit the scanning process, press the programmed **Scan** key again (a low-pitched tone sounds).

Talk Around

This feature allows you to continue communication even when the repeater malfunctions, or when your radio is out of the repeater's range but within the coverage range of other radios.

Operation:

Press the programmed **Talk Around** key to enable the feature (a high-pitched tone sounds). To disable the feature, press this key again (a low-pitched tone sounds).

Monitor

To adjust match conditions for signal receiving, you can enable the feature "Monitor".

Operation:

- ✧ Press the programmed **Monitor** key to enable the feature (a high-pitched tone sounds). To disable the feature, press this key again (a low-pitched tone sounds).
- ✧ Hold down the programmed **Monitor Momentary** key to enable the feature (a high-pitched tone sounds). To disable the feature, release this key (a low-pitched tone sounds).

Squelch Off

If the feature "Squelch Off" is enabled, the speaker will keep unmuted no matter whether carrier is present.

Operation:

- ✧ Press the programmed **Squelch Off** key to enable the feature, and the radio sounds background noise (a high-pitched tone sounds). To disable the feature, press this key again (a low-pitched tone sounds).
- ✧ Hold down the programmed **Squelch Off Momentary** key to enable the feature, and the radio sounds background noise (a high-pitched tone sounds). To disable the feature, release this key (a low-pitched tone sounds).

Emergency

In case of an emergency, you can use the feature to ask for help from your companion or control center. The Emergency process has the highest priority. You can make emergency operation even when your

radio is transmitting or receiving.

To enable the feature on a channel, an emergency system must be assigned to the channel via the programming software. In addition, the Emergency type, Emergency ID type and Emergency mode are settable via the programming software.

Emergency Type

For each Emergency mode, there are four Emergency types available. You can select one of them via your dealer:

Emergency Type	Description
Siren Only	In Emergency mode, the radio will sound shrill alarm tone.
Regular	In Emergency mode, the radio will give audible and visible indication.
Silent	In Emergency mode, the radio won't give any audible or visible indication.
Silent with Voice	In Emergency mode, the radio won't give any audible or visible indication, but will receive voice ACK from the companion or control center automatically.

Emergency ID Type





Your radio supports two Emergency ID types. You can select one of them via your dealer:

Emergency ID Type	Description
None	No signaling is used when the radio sends alarm information.
HDC1200	HDC1200 signaling is used when the radio sends alarm information.

Emergency Mode

Your radio supports three Emergency modes. You can select one of them via your dealer (Note: For the following operation methods, we take the “Regular” type as an example).

Emergency Mode	Description
Alarm 	In this mode, you can send alarm information to your

	companion or control center by pressing the programmed Emergency key, but you cannot talk with them.
Alarm with Call 	In this mode, you can send alarm information by pressing the programmed Emergency key. When the alarm tone disappears (None) or after the Emergency ID is sent (HDC1200), you can speak into the microphone, allowing your voice and background noise to be transmitted automatically (you do not need to hold down the PTT key).
Call Only	In this mode, press the programmed Emergency key to go to the Revert Channel, and speak into the microphone, allowing your voice and background noise to be transmitted automatically (you do not need to hold down the PTT key).

Operation Methods for Analog Emergency

■ Alarm (None & HDC1200)

Operation: Press the programmed **Emergency** key to send alarm information, and the LED glows red. (None: If "Local Emergency Alarm" is enabled via the programming software, an alarm tone will sound.)

The following methods are available for you to exit the Emergency mode:

1. Once the Alarm Cycles expire, the radio will exit the Emergency mode automatically.
2. Long press the programmed **Emergency** key.
3. Hold down the **PTT** key. The radio will transmit on the channel on which the radio operates before entering the Emergency mode. (HDC1200)

■ Alarm with Call (None & HDC1200)

Operation:

1. Press the programmed **Emergency** key to send alarm information, and the LED glows red. (None: If "Local Emergency Alarm" is enabled via the programming software, an alarm tone will sound.)
2. When the alarm tone disappears (None) or after the Emergency ID is sent (HDC1200), you can speak into the microphone to make an emergency call.
3. When the LED flashes orange, your radio is receiving.

Two methods are available for you to exit the Emergency mode:

1. After the preset Alarm Cycles and Voice Cycles expire, the radio will exit the Emergency mode automatically. (None)
2. Long press the programmed **Emergency** key.

■ Call Only (HDC1200)

Operation:

1. Press the programmed **Emergency** key to go to the Revert Channel, and the LED glows red.
2. If the feature “Alarm with Call to Follow” is enabled, you can speak into the microphone to make an emergency call when the LED glows red.
3. When the LED flashes orange, your radio is receiving.

To exit the Emergency mode, long press the programmed **Emergency** key.



Note: Your dealer may set the number of alarm cycles and alarm duration (None), number of polite retries and impolite retries (HDC1200), number of voice cycles, duration of each transmission and TX interval.



Operation Method for Digital Emergency

■ Call Only

Operation:

1. Press the programmed **Emergency** key to go to the Revert Channel.
2. If the feature “Alarm with Call to Follow” is enabled, you can speak into the microphone to make an emergency call when the LED glows red.
3. When the LED flashes orange, your radio is receiving.

If the preset Voice Cycles expire, you can hold down the **PTT** key to make the emergency call again (the LED glows red). After the emergency call is transmitted, please release the **PTT** key to receive.

To exit the Emergency mode, long press the programmed **Emergency** key.



Note: Your dealer may set the number of voice cycles, duration of each transmission and TX interval.

Adjust Squelch Level



This feature allows you to adjust the squelch threshold required for the radio to unmute.

Generally, “Tight” is used in high noise environment. It requires stronger signal for the radio to unmute.

If the squelch level is set to Open, the speaker will keep unmuted irrespective of the satisfaction of decoding conditions.

Operation:

Press the programmed **Adjust Squelch Level** key to switch among Tight, Open and Normal (from Tight to Open, a low-pitched tone and background sound are heard; from Open to Normal, a high-pitched tone is heard and the background sound disappears; from Normal to Tight, a high-pitched tone is heard).

Battery Power Indicator

This feature allows you to know the current battery strength.

Operation:

Hold down the programmed **Battery Strength Indicator** key, and the radio will give a specific indication to represent the current battery strength. Release the key to exit.

Indication	Battery Strength
Green LED glows.	High
Orange LED glows.	Medium
Red LED glows.	Low
Red LED glows and the low battery alert sounds.	Insufficient

Man Down (optional)

With this feature, your radio will alarm automatically to summon help from your companion if it is positioned aslant for a certain time period.

Operation:

- To enable the feature,
 - Press the programmed **Man Down** key (a high-pitched tone sounds); or
 - Turn on the radio if the feature is enabled via the programming software.
- Your radio will sound a pre-alert tone if it is positioned aslant for a preset time period, and will enter the Emergency mode if you do not place it vertically within such time period. To exit the Emergency mode, please place it upright.
- To disable the feature,
 - Press the programmed **Man Down** key (a low-pitched tone sounds).

Scrambler /Encrypt

The Scrambler/Encrypt feature can encrypt your audio signals to prevent eavesdropping. Thus privacy of your communication is guaranteed.

Operation:

- Press the programmed **Scrambler/Encrypt** key to enable Scrambler or Encrypt on the current channel (a high-pitched tone sounds); press the key again to disable the feature (a low-pitched tone sounds).
- If the Scrambler/Encrypt feature is enabled for a channel via the programming software, switch to the channel to enable the feature, or exit the channel to disable the feature.

Busy Channel Lockout

If enabled via the programming software, this feature can prevent your radio interfering with other transmitting radios on the same channel. If you hold down the **PTT** key while the channel is in use, your radio will keep beeping, alerting you to transmission prohibition. To stop beeping, please release the **PTT** key. When the channel is free, you can press and hold down the **PTT** key to transmit.

Time-out Timer (TOT)

The purpose of TOT is to prevent any user from occupying a channel for an extended period. If the preset time expires, the radio will automatically terminate transmission and keep beeping. To stop beeping, please release the **PTT** key. You must wait for a certain time period (preset by your dealer) to initiate another transmission.

If the pre-alert function is set by your dealer, your radio will alert you to the TOT expiration in advance.



Note: This feature is null in Emergency mode.

Pseudo Trunking

This feature can be enabled via the programming software. If your radio operates on a channel with this feature enabled and one time slot is already occupied, it can transmit and receive on the other free time slot, allowing you to communicate timely under emergent situations.

MIC AGC

If enabled via the programming software, your radio will process the audio signals during transmission, providing improved audio for the receiving radio.

Operating Modes

It 's designed to support multiple operating modes including:

- . MPT Trunked Mode
- . DMR/PDT Trunked Mode
- . DMR/PDT Digital Conventional Mode
- . Conventional Analog Mode

The PD70X/PD70XG portables can include all of these modes.

The PD70X/PD70XG supports a full range of advanced digital trunking features, including talk group calls, priority scanning, emergency calls, late call entry, and dynamic reconfiguration. It performs autonomous roaming for wide area applications. High quality voice coding and robust audio components assure speech clarity.

In the trunked modes, the user selects a communications "operating" system (i.e., DMR,PDT,MPT) and group. While communicating in a trunked mode, channel selection is transparent to the user and is controlled via digital communication with the system controller. This provides advanced programmable features and fast access to communication channels.

In Conventional Analog mode, the user selects a channel and communicates directly on that channel. A channel is a transmit/receive radio frequency pair.

The exact operation of the radio will depend on the operating mode, the radio is programming, and the particular radio system. Most features described in this manual can be enabled through programming. Then refer to the corresponding section(s) within this manual for feature and operation information.

Troubleshooting

Phenomena	Analysis	Solution
The radio can not be powered on.	The battery may be improperly installed.	Remove the battery and attach it again.
	The battery may run out.	Recharge or replace the battery.
	The battery may suffer from poor contact caused by dirtied or damaged battery contacts.	Clean the battery contacts. If the problem can not be solved, contact your dealer or authorized service center for inspection and repair.
During receiving signals, the voice is weak, discontinuous or totally inactive.	The battery strength may be too low.	Recharge or replace the battery.
	The volume may be set to a low level.	Increase the volume.
	The antenna may get loose or may be improperly installed.	Power off the radio, and re-install the antenna.
	The speaker may be blocked or damaged.	Clean surface of the speaker. If the problem can not be solved, contact your dealer or authorized service center for inspection and repair.
You can not communicate with other members.	The frequency or signaling may be inconsistent with that of other members.	Set your TX/RX frequency and signaling to the same as that of other members.
	The channel type (digital/analog) may be set inconsistently.	Make sure all members are on the same digital/analog channel.
	You may be too far away from the group members.	Move towards other members.

Irrelevant communication or noise is heard on the channel.	You may be interrupted by radios using the same frequency.	Change the frequency, or adjust the squelch level.
	The radio may be set with no signaling.	Set signaling for all member radios to avoid interference at the same frequency.
The noise is too loud.	You may be too far away from other members.	Move towards other members.
	You may be at an unfavorable position. For example, your communication may be blocked by high buildings or frustrated in the underground areas.	Move to an open and flat area, and restart the radio.
	You may suffer from external disturbance (such as electromagnetic interference).	Stay away from equipment that may cause interference.
The GPS cannot locate your position.	No GPS signal is received.	Move to an open and flat area, and restart the radio.

If the above solutions can not fix your problems, or you may have some other queries, please contact us or your local dealer for more technical support.

Care and Cleaning

To guarantee optimal performance as well as a long service life of the product, please follow the tips below.

Product Care

- Do not pierce or scrape the product with any edged instruments or hard objects.
- Keep the product far away from substances that can corrode the circuit.
- Do not hold the product by its antenna or earpiece cable directly.
- Attach the accessory jack cover when the product is not in use.

Product Cleaning

- Clean up the dust and fine particles on the product surface and charging piece with a clean and dry lint-free cloth or a brush regularly.
- Use neutral cleanser and a non-woven fabric to clean the keys, control knobs and front case long-time use. Do not use chemical preparations such as stain removers, alcohol, sprays or oil preparations, so as to avoid surface case damage. Make sure the product is completely dry before use.



Caution: Power off and remove the battery before cleaning.

Optional Accessories

The following items are the main optional accessories for the product, and please consult your local dealer for more other accessories.

			
<p>Remote Speaker Microphone (IP57) SM18N2</p>	<p>Earpiece with On-MIC PTT & Transparent Acoustic Tube EAN16</p>	<p>D-earset with In-Line Microphone EHN12</p>	<p>Earbud with On-MIC PTT ESN10</p>
			
<p>3-Wire Surveillance Earpiece with Transparent Acoustic Tube (beige) EAN18</p>	<p>Six-Unit Switching Power PS7002</p>	<p>Carrying Case (for thick battery) (leather) (swivel) LCY003</p>	<p>Chest Pack LCBN13</p>

 **Caution:** Use the accessories specified by Hytera only. If not, Hytera shall not be liable for any losses or damages arising out of use of unauthorized accessories.