



OWNER'S MANUAL

DIGITAL PORTABLE RADIO



is the trademark or registered trademark of Hytera Communications Corporation Limited.
© 2014 Hytera Communications Corporation Limited. All Rights Reserved.

Address: HYT Tower, Hi-Tech Industrial Park North, Beihuan
RD., Nanshan District, Shenzhen, China
Postcode: 518057
<http://www.hytera.com>

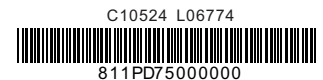

C10524 L06774

811PD7500000





Preface

Thanks for your favor in our product. This manual is helpful for you to quickly know how to use the product. For detailed features and operations, please refer to the Feature Book along with the product.

This manual is applicable to the following product:

PD75X Digital Portable Radio

Instructional Icons

-  : Indicates functions that are available on digital channel only.
-  : Indicates functions that are available on analog channel only.

Functions marked with neither the above icons are available on both analog and digital channels.

Disclaimer

Hytera Communications Corporation Limited (the Company) endeavors to achieve the accuracy and completeness of this manual, but no warranty of accuracy or reliability is given. All the specifications and designs are subject to change without notice due to continuous technology development. No part of this manual may be copied, modified, translated, or distributed in any manner without the express written permission of us.

We do not guarantee, for any particular purpose, the accuracy, validity, timeliness, legitimacy or completeness of the Third Party products and contents involved in this manual.

If you have any suggestions or would like to learn more details, please visit our website at: <http://www.hytera.com>.

RF Radiation Information

This product must be restricted to operations in an occupational/controlled RF exposure environment. Users must be fully aware of the hazards of the exposure and able to exercise control over their RF exposure to qualify for the higher exposure limits.

RF Radiation Profile

Radio Frequency (RF) is a frequency of electromagnetic radiation in the range at which radio signals are transmitted. RF technology is widely used in communication, medicine, food processing and other fields. It may generate radiation during use.

RF Radiation Safety

In order to ensure user health, experts from relevant industries including science, engineering, medicine and health work with international organizations to develop standards for safe exposure to RF radiation. These standards consist of:

- United States Federal Communications Commission, Code of Federal Regulations; 47CFR part 2 sub-part J;
- American National Standards Institute (ANSI)/Institute of Electrical and Electronic Engineers (IEEE) C95.1-1992;
- Institute of Electrical and Electronic Engineers (IEEE) C95.1-1999;
- International Commission on Non-Ionizing Radiation Protection (ICNIRP) 1998.

FCC Regulations

Federal Communication Commission (FCC) requires that all radio communication products should meet the requirements set forth in the above standards before they can be marketed in the U.S, and the manufacturer shall post a RF label on the product to inform users of operational instructions, so as to enhance their occupational health against exposure to RF energy.

FCC Statement

This equipment has been tested and found to comply with the limits for a Class B digital device, pursuant to part 15 of FCC Rules. These limits are designed to provide reasonable protection against harmful interference in a residential installation. This equipment generates and can radiate radio frequency energy. If not installed and used in accordance with the instructions, it may cause harmful interference to radio communications. However, there is no guarantee that

interference will not occur in a particular installation.

Verification of harmful interference by this equipment to radio or television reception can be determined by turning it off and then on. The user is encouraged to try to correct the interference by one or more of the following measures:

- Reorient or relocate the receiving antenna. Increase the separation between the equipment and receiver.
- Connect the equipment into an outlet on a different circuit to that of the receiver's outlet.
- Consult the dealer or an experienced radio/TV technician for help.

Operation is subject to the following two conditions:

- This device may not cause harmful interference.
- This device must accept any interference received, including interference that may cause undesired operation.

Note: Changes or modifications to this unit not expressly approved by the party responsible for compliance could void the user's authority to operate the equipment.

RF Exposure Compliance and Control Guidelines and Operating Instructions

To control your exposure and ensure compliance with the occupational/controlled environmental exposure limits, always adhere to the following procedures.

Guidelines:

- Do not remove the RF Exposure Label from the device.
- User awareness instructions should accompany device when transferred to other users.
- Do not use this device if the operational requirements described herein are not met.

Operating Instructions:

- Transmit no more than the rated duty factor of 50% of the time. To transmit (talk), push the Push-To-Talk (PTT) key. To receive calls, release the PTT key. Transmitting 50% of the time, or less, is important because the radio generates measurable RF energy only when transmitting (in terms of measuring for standards compliance).
- Keep the radio unit at least 2.5 cm away from the face. Keeping the radio at the proper distance is important as RF exposure decreases with distance from the antenna. The antenna should be kept away from the face and eyes.
- When worn on the body, always place the radio in a Hytera-approved holder, holster, case, or body harness or by use of the correct clip for this product. Use of non-approved accessories may result in exposure levels which exceed the FCC's occupational/controlled environmental RF exposure limits.

- Use of non-approved antennas, batteries, and accessories causes the radio to exceed the FCC RF exposure guidelines.
- Contact your local dealer for the optional accessories of the product.

EU Regulatory Conformance

As certified by the qualified laboratory, the product is in compliance with the essential requirements and other relevant provisions of the following directives: 2014/53/EU, 2006/66/EC, 2011/65/EU, and 2012/19/EU.

Please note that the above information is applicable to EU countries only.

Items in the Package

Please unpack carefully and check that all items listed below are received. If any item is missing or damaged, please contact your dealer.

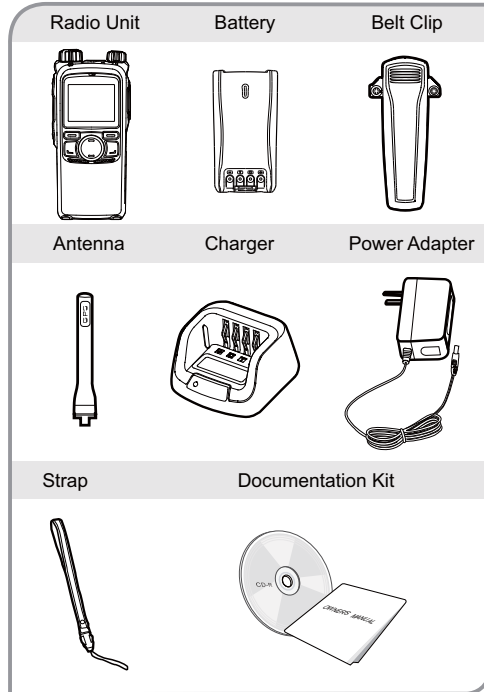

Note: The frequency band is marked on the label of antenna; if not, please refer to the label on the radio for frequency band information.

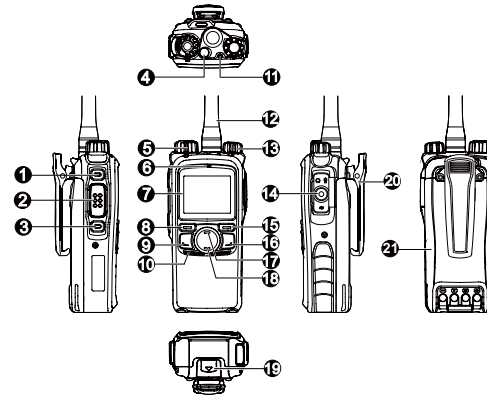

Product Overview

Product Control



No.	Part Name	No.	Part Name
1	SK1 (Side Key 1)	12	Antenna
2	PTT (Push-to-Talk) Key	13	Power On-Off/Volume Control Knob
3	SK2 (Side Key 2)	14	Accessory connector
4	TK (Top Key)	15	Back/Group Call Management Key
5	Group Call Selector knob	16	BackDial/End/Home Screen Key
6	Microphone	17	Up Key
7	LCD Display	18	Down Key
8	OK/Menu Key	19	Battery Latch
9	Answer/Redial/Call Key	20	Belt Clip
10	Speaker	21	Battery
11	LED Indicator	-	-

Programmable Keys

For enhanced convenience, you may request your dealer to program the TK (), SK1, SK2 and P1 () and P2 () as shortcuts to certain functions. Please refer to the corresponding Feature Book for more details.



Caution: The TK is programmed with emergency feature by default (short press: Emergency On; long press: Emergency Off). It is programmable by your dealer.

Before Use

Charging the Battery



Caution:

- Make sure the radio is powered off before charging. Read the Safety Information Booklet in advance to get necessary safety information.
- To achieve optimal battery performance, please charge the battery for at least 5 hours before initial use.

Please use the charger specified by the Company to charge the battery. Charging Diagram is listed below.

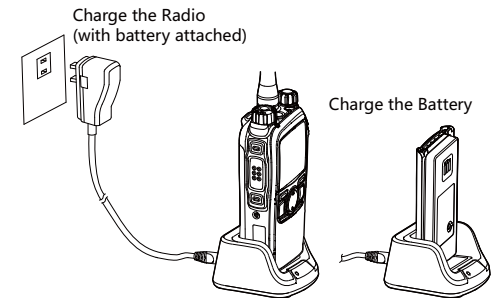

Charging Status Indication (on charger):

LED Indication	Charging Status
The LED Indicator flashes red slowly.	Standby (no load)
The LED Indicator glows red.	Charging
The LED Indicator glows orange.	90% charged
The LED Indicator glows green.	Fully charged
The LED Indicator flashes red rapidly.	Charging failed

Attaching the Battery

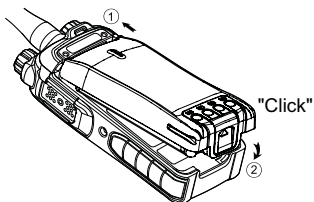

Note: To remove the battery, turn off the radio first. Then slide the battery latch upwards to unlock the battery and remove it.

Checking the Battery Power

You may check the current battery power by holding down the programmed **Battery Power Indicator** key preset by your dealer. And release the key to exit. Battery power indications are listed below:

LED Indication	Icon	Battery Power
The LED Indicator glows green.		High
The LED Indicator glows orange.		Medium
The LED Indicator glows red.		Low
The LED Indicator glows red and low battery alert beeps.		Under the low battery threshold. Please recharge or replace the battery for proper radio operation

Attaching the Antenna

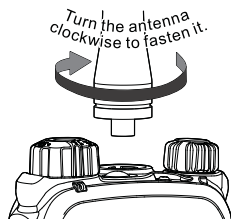

Caution: Do not hold the radio by its antenna, otherwise the performance and lifespan of the antenna will be reduced.

Attaching the Belt Clip

1. Loosen the screws from the back of the radio.
2. Align the screw holes of the belt clip with those on the radio's back, and then tighten the screws.

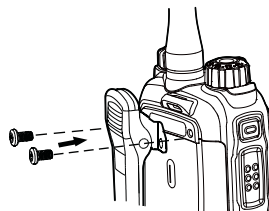

Attaching the Accessories

1. Open the accessory connector cover as shown below.

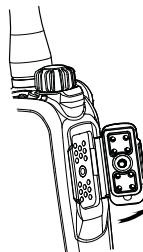

2. Align the accessory (such as an audio accessory, or a programming cable) plug with the accessory connector.



Caution: Do not scrape the silicone rubber surrounding the accessory connector screw hole, in order to ensure the waterproof performance of the radio.

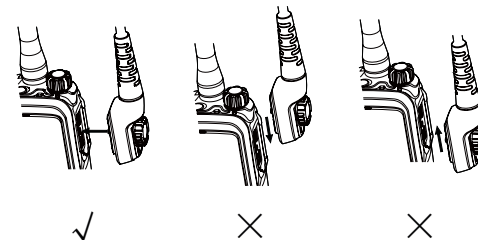



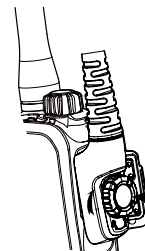























3. Tighten the screw on the accessory plug.



Status Indication

LCD Icon

Name	Icon	Radio Status
GPS Icon		The GPS feature is enabled, and valid GPS data is received.
		The GPS feature is enabled, but no valid GPS data is received.
Battery Power Icon		More bars indicate more battery power.
TX Power Icon		Low TX power for the current channel.
		High TX power for the current channel.
Accessory Icon		An accessory is connected.
Work Order Icon		One or more new work orders are received.
Operation Mode Icon	DM	Direct Mode: Under this mode, the radio communicates with other radios directly.
	RM	Repeater Mode: Under this mode, the radio communicates with other radios via a repeater.
Monitor Icon		The Monitor feature is enabled.
Emergency Icon		The Emergency mode (except secret emergency) is activated or an emergency alarm is received.
Roam Icon		The radio is roaming.
Scrambler/Encrypt Icon		The Scrambler/Encrypt feature is enabled.
Scan Icon		The radio is scanning.
		Scanning stays on a non-priority channel.
		Scanning stays on Priority Channel 1.
		Scanning stays on Priority Channel 2.

Name	Icon	Radio Status
VOX Icon		The VOX feature is enabled.
Missed Call Icon		Missed call(s).
Message Icon		Unread message(s)
		Inbox is full.
RSSI Icon		No signal.
		More bars indicate better signal strength.
Speaker Icon		The speaker is unmuted.
LQO Icon		The LQO feature is enabled.
Call/Contact Icon		<ul style="list-style-type: none"> Indicates Private Call during a call. Indicates Private Contact in the contact list.
		<ul style="list-style-type: none"> Indicates Group Call during a call. Indicates Group Contact in the contact list.
		<ul style="list-style-type: none"> Indicates All Call during a call. Indicates All Call Contact in the contact list.

LED Indicator

LED Indication	Radio Status
The LED indicator flashes green.	Powering on
The LED indicator glows green.	Receiving
The LED indicator glows red.	Transmitting

LED Indication	Radio Status
The LED indicator flashes orange slowly.	Scanning or Roaming
The LED indicator flashes orange rapidly.	Emergency
The LED indicator glows orange.	Call hung. During a call, you can hold down the PTT key to talk to the other party before the call hang time expires.

Menu Navigation

The following diagram outlines the menu structure of the radio. You can personalize menu option displayed in the radio via your dealer.

To select and confirm the options shown in the menu, press the **Menu** key to enter the main menu, and then press the **Up/Down** key to select the appropriate option, finally press the **OK** key. This manual only describes the paths to the menus in terms of menu operations, for example, to access the contact list, go to "Contact -> Contact List".

The radio supports menu reset function. If you do not operate the menu for a predefined time period set by the dealer, the radio will automatically return to the home screen. You may request your dealer to configure the auto reset time or disable the feature.

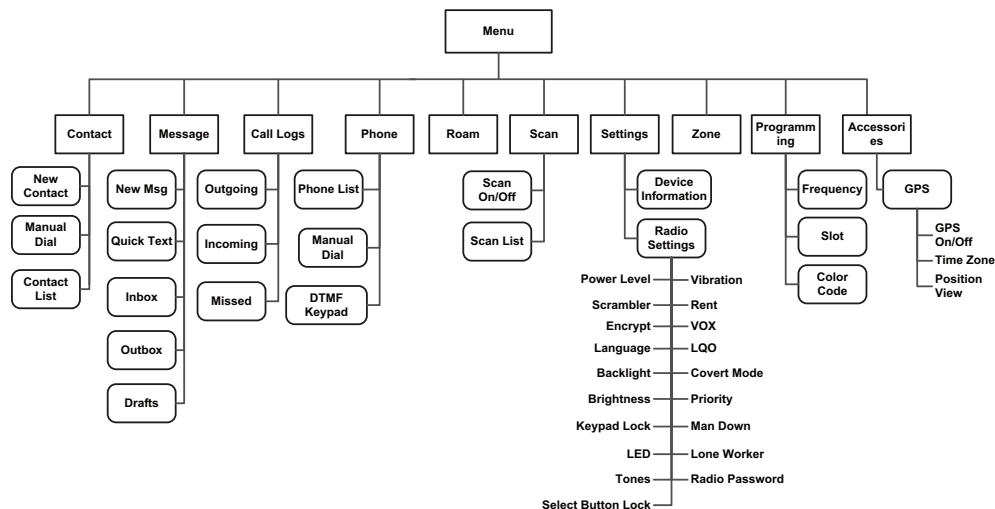

Basic Operation

Powering On/Off

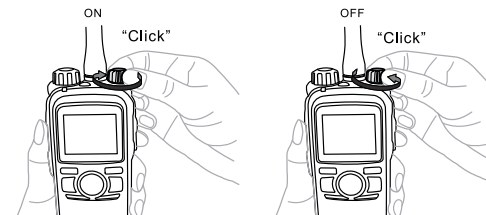

Adjusting the Volume

You can adjust the volume of output voice, alert tone and channel notification tone by rotating the **Volume Control Knob**. For other tones, the volume will be configured by the dealer.



Selecting a Zone

A zone is a group of channels exhibiting the same property, which is programmed by your dealer and can facilitate convenient management over the channels. The radio supports up to 64 zones, each with a maximum of 16 channels. You may select a zone through any of the following methods:

- Via the menu: Go to "Menu -> Zone", press the **Up/Down** key to select an appropriate zone, and then press the **OK** key to switch to the selected zone.
- Via Programmable Keys: You can toggle to the appropriate zone by pressing the programmed **Zone Up** or **Zone Down** key preset by your dealer.

Selecting a Channel

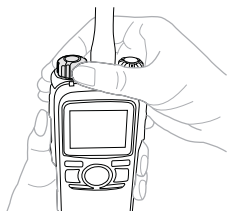

If the Channel Notify feature is enabled, you will hear the corresponding channel number when switching to any channel.

Managing the Contacts

You can have management of your contacts via the menu “Contact -> Contact List” in the radio. The contact list saves the information of private call, group call and all call contacts. You can access the “Contact List” menu via the “Contact” menu or by pressing the programmed **Contact List** key.

You can view contact details, edit or delete the private call contact in the “Contact List” menu. You can send to a private call contact the following commands: Alert Call, Radio Check, Remote Monitor, Radio Enable or Radio Disable. Please refer to Feature Book for details.

Call Services

After the radio is powered on, you can make and receive calls. To ensure optimal volume of the receiving radio, hold the palm microphone approximately 2.5 to 5 centimeters away from your mouth.

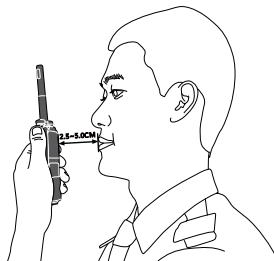

Private Call

Initiating a Private Call

When initiating a private call, the radio will display the icon . You can make a private call through the following ways:

Preset Contact

In the home screen, hold down the **PTT** key on the palm microphone to initiate a Private Call to the Private Call contact preset for the current channel.

You may request your dealer to preset a regular Private Call contact, Group Call contact or an All Call contact for each digital channel.

Contact List or Call Logs

1. Go to “Menu -> Contact” or “Menu -> Call Logs” and access the “Contact List” submenu.
2. Use the **Up/Down** key to select the private call contact you want to call.
3. Hold down the **PTT** key to initiate a Private Call.

Receiving and Responding to a Private Call

After receiving a private call, the radio will display the icon , then you can listen without any operation. You can hold down the **PTT** key to call back within the preset time. If you do not respond to it, the radio will provide appropriate indications.

Group Call

Initiating a Group Call

When initiating a group call, the radio will display the icon . You can make a group call through the following ways. The operation is similar to initiating a private call.

Preset Contact

In the home screen, hold down the **PTT** key on the palm microphone to initiate a Group Call to the Group Call contact preset for the current channel.

Contact List

1. Go to “Menu -> Contact -> Contact List”.
2. Use the **Up/Down** key to select the group call contact you want to call.
3. Hold down the **PTT** key to initiate a Group Call.

Receiving and Responding to a Group Call

After receiving a group call, the radio will display the icon . You can hold down the **PTT** key to call back within the preset time.

Call on Analog Channel (No Signaling)

On an analog channel, you can hold down the **PTT** key and talk to the microphone to transmit, and release the **PTT** key to receive.

Please refer to the corresponding Feature Book for operation description on how to make and receive calls on the analog channel with signaling.

Emergency Call

In case of an emergency, you can use this feature to ask for help from your companion or the control center. The Emergency Call has the highest priority which can terminate the ongoing calls with lower priorities on the current channel. You can make an emergency call even when your radio is transmitting or receiving.

This feature needs to be configured and enabled by your dealer. Please refer to the corresponding Feature Book for details.



This feature enables you to directly send a quick text message and to forward the messages in the Inbox, Outbox and Drafts.

Quick Text

The radio supports quick text message preset by your dealer. You can directly send the message or edit it prior to sending.

Inbox



The radio saves the received messages into the Inbox and marks every message with a corresponding icon to indicate its status.

-  : Read message
-  : Unread message

When the Inbox is full, the radio will display the icon  , and the earliest message will be overwritten by the latest one automatically.

Outbox

The radio saves the sent messages into the Outbox and marks every message with a corresponding icon to indicate its status.

-  : The message is sent successfully.
-  : The message is not sent successfully. In this case, you can resend it.

When the Outbox is full, the earliest message will be overwritten by the latest one automatically.

Troubleshooting

Phenomena	Analysis	Solution
The radio fails to power on.	The battery may be improperly installed.	Remove the battery and then reattach it.
	The battery power may be used up.	Recharge or replace the battery.
	The battery may be poorly connected due to dirtied or damaged battery contacts.	Clean the battery contacts. If the problem cannot be solved, contact your dealer or authorized service center for inspection and repair.
During receiving, the voice is weak, discontinuous or totally inactive.	The battery voltage may be low.	Recharge or replace the battery.
	The volume level may be low.	Increase the volume by rotating the Volume Control Knob .
	The antenna may be loosened or improperly installed.	Reattach the antenna after turning off the radio.
You cannot communicate with other members.	The speaker may be blocked or damaged.	Clean the surface of the speaker. If the problem cannot be solved, contact your dealer or authorized service center for inspection and repair.
	The frequency or signaling may not match that of other members.	Set your TX/RX frequency and signaling to the same as that of other members.
	The channel type (digital/analog) may be set inconsistently.	Make sure all members are on the same digital/analog channel.
Irrelevant communication or noise is heard on the channel.	You may be too far away from the group members.	Move towards other members.
	You may be interrupted by radios using the same frequency.	Change the frequency, or adjust the squelch level.
The noise is too loud.	The radio may be set with no signaling.	Set signaling for all member radios to avoid interference at the same frequency.
	You may be too far away from other members.	Move towards other members.
	You may locate in an unfavorable position. For example, your communication may be blocked by high buildings or frustrated in the underground areas.	Move to an open and flat area, and restart the radio to try again.
GPS positioning fails.	You may suffer from external disturbance (such as electromagnetic interference).	Stay away from equipment that may cause interference.
	GPS signals may not be received due to unfavorable position.	Move to an open and flat area to try again.
You cannot use the keys.	The keypad may fail to function temporarily.	Restart the radio.
The LCD does not display any information.	The LCD may fail to function temporarily.	Restart the radio.

If the above solutions cannot fix your problems, or you may have some other queries, please contact us or your local dealer for more technical support.

Care and Cleaning

To guarantee optimal performance as well as a long service life of the product, please follow the tips below.

Product Care

- Do not pierce or scrape the product.
- Keep the product far away from substances that can corrode the circuit.
- Do not hold the product by its antenna or earpiece cable directly.
- Attach the accessory connector cover when the accessory is not in use.

Product Cleaning



Caution: Turn off the product and remove the battery before cleaning.

- Clean up the dust and fine particles on the product surface and charging piece with a clean and dry lint-free cloth or a brush regularly.
- Use a non-woven cloth with neutral cleanser to clean the device after long-time use. Do not use chemical preparations such as stain removers, alcohol, sprays or oil preparations, so as to avoid potential damage on the surface.
- Make sure the product is completely dry before use.

Optional Accessories

Contact your local dealer for the optional accessories used with the product.



Caution: Use the accessories specified by Hytera only. If not,

Hytera shall not be liable for any losses or damages arising out of use of unauthorized accessories.