

Preface

Thanks for your favor in our product. This manual provides guidance for you to quickly know how to use the product. For detailed features and operations, see the *DMR Trunking Radio Feature Description and Operation Manual* along with the product.

To avoid bodily injury or property loss caused by misoperations, please carefully read the *Safety Information Booklet* before using the product.

This manual is applicable to the following product:

[PD98X/PD98XG Digital Trunking Portable Radio \(X may represent 2, 5, 6 or 8\)](#)

Copyright Information

Hytera is the trademark or registered trademark of Hytera Communications Corporation Limited (the Company) in PRC and/or other countries or areas. The Company retains the ownership of its trademarks and product names. All other trademarks and/or product names that may be used in this manual are properties of their respective owners.

The product described in this manual may include the Company's computer programs stored in memory or other media. Laws in PRC and/or other countries or areas protect the exclusive rights of the Company with respect to its computer programs. The purchase of this product shall not be deemed to grant, either directly or by implication, any rights to the purchaser regarding the Company's computer programs. Any of the Company's computer programs may not be copied, modified, distributed, decompiled, or reverse-engineered in any manner without the prior written consent of the Company.

Disclaimer

The Company endeavors to achieve the accuracy and completeness of this manual, but no warranty of accuracy or reliability is given. All the specifications and designs are subject to change without notice due to continuous technology development. No part of this manual may be copied, modified, translated, or distributed in any manner without the prior written consent of the Company.

We do not guarantee, for any particular purpose, the accuracy, validity, timeliness, legitimacy or completeness of the Third Party products and contents involved in this manual.

If you have any suggestions or would like to learn more details, please visit our website at:

<http://www.hytera.com>.

FCC Regulations

Federal Communication Commission (FCC) requires that all radio communication products should meet the requirements set forth in the FCC Radio Frequency (RF) exposure limits before they can be marketed in the U.S., and the manufacturer shall post an RF label on the product to inform users of operational instructions, so as to enhance their occupational health against exposure to RF energy.

Operational Instructions and Training Guidelines

To ensure optimal performance and compliance with the occupational/controlled environment requirements in the FCC RF exposure limits, users should transmit no more than 50% of the time and note the following cautions:

- RF energy will be generated only when the radio is transmitting.
- The radio must be at least 2.5 centimeters away from mouth during transmitting.

EU Regulatory Conformance

As certified by the qualified laboratory, the product is in compliance with the essential requirements and other relevant provisions of the following directives:

- 1999/5/EC or 2014/53/EU
- 2006/66/EC
- 2011/65/EU
- 2012/19/EU

Please note that the above information is applicable to EU countries only.

FCC Statement

Operation is subject to the following two conditions: 1. This device may not cause harmful interference, and 2. This device must accept any interference received, including interference that may cause undesired operation.

Note:” Changes or modifications to this unit not expressly approved by the party responsible for compliance could void the user’s authority to operate the equipment.”

Compliance with RF Exposure Standards

Hytera’s Is Digital Radio complies with the following RF energy exposure standards and guidelines:

- United States Federal Communications Commission, Code of Federal Regulations; 47 CFR § 1.1307, 1.1310 and 2.1093
- American National Standards Institute (ANSI) / Institute of Electrical and Electronic Engineers (IEEE) C95. 1:2005; Canada RSS102 Issue 5 March 2015.
- Institute of Electrical and Electronic Engineers (IEEE) C95.1:2005 Edition

RF Exposure Compliance and Control Guidelines and Operating Instructions

To control your exposure and ensure compliance with the occupational/controlled environment exposure limits always adhere to the following procedures.

Guidelines:

- Do not remove the RF Exposure Label from the device.
- User awareness instructions should accompany device when transferred to other users.
- Do not use this device if the operational requirements described herein are not met.

Operating Instructions:

- Transmit no more than the rated duty factor of 50% of the time. To transmit (talk), push the Push-To-Talk (PTT) button. To receive calls, release the PTT button. Transmitting 50 % of the time, or less, is important because this radio generates measurable RF energy exposure only when transmitting (in terms of measuring for standards compliance).
- Hold the radio in a vertical position in front of face with the microphone (and the other parts of the radio, including the antenna) at least one inch (2.5 cm) away from the nose. Keeping the radio at the proper distance is important because RF exposures decrease with distance from the antenna. Antenna should be kept away from eyes.
- When worn on the body, always place the radio in a Hytera’s approved clip, holder, holster, case, or body harness for this product. Using approved body-worn accessories is important because the use of Hytera’s or other manufacturer’s non-approved accessories may result in exposure levels, which exceed the FCC’s occupational/controlled environment RF exposure limits.

- Use only manufacturer's name approved supplied or replacement antennas, batteries, and accessories. Use of non-manufacturer-name approved antennas, batteries, and accessories may exceed the FCC RF exposure guidelines.

IC statement

The device has been tested and compliance with SAR limits, users can obtain Canadian information on RF exposure and compliance

Après examen de ce matériel aux conformité aux limites DAS et/ou aux limites d'intensité de champ RF, les utilisateurs peuvent sur l'exposition aux radiofréquences et la conformité and compliance d'acquérir les informations correspondantes

This device complies with Industry Canada licence-exempt RSS standard(s). Operation is subject to the following two conditions:

(1) this device may not cause interference, and

(2) this device must accept any interference, including interference that may cause undesired operation of the device.



Le présent appareil est conforme aux CNR d'Industrie Canada applicables aux appareils radio exempts de licence. L'exploitation est autorisée aux deux conditions suivantes : (1) l'appareil ne doit pas produire de brouillage, et (2) l'utilisateur de l'appareil doit accepter tout brouillage radioélectrique subi, même si le brouillage est susceptible d'en compromettre le fonctionnement

Contents

1. Items in the Package	1
2. Product Overview	2
2.1 Product Controls	2
2.2 LCD Icon.....	3
2.3 LED Indicator	5
3. Before Use	6
3.1 Attaching the Antenna.....	6
3.2 Installing the TF Card.....	6
3.3 Attaching the Battery.....	7
3.4 Attaching the Belt Clip.....	7
3.5 Attaching the Accessories.....	7
3.6 Charging the Battery	8
4. Basic Operations	10
4.1 Turning On/Off the Radio.....	10
4.2 Checking the Battery.....	10
4.3 Checking the Battery Power	10
4.4 Registering with BS.....	11
4.5 Adjusting the Volume	11
4.6 Inputting via Keypad	11
4.7 Locking or Unlocking Keys and Knobs.....	11
4.8 Selecting a Subgroup.....	12
4.9 Selecting a Group Contact.....	12
4.10 Creating a Private Contact.....	12
5. Call Services	13
5.1 Group Call.....	13
5.2 Private Call	14
5.3 Emergency Call	15
6. Message Services	16
7. Troubleshooting	17
8. Care and Cleaning	19
9. Optional Accessories	20

1. Items in the Package

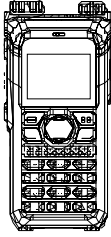
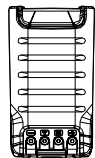
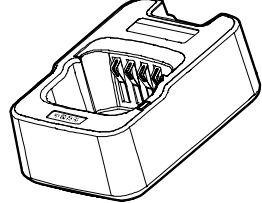
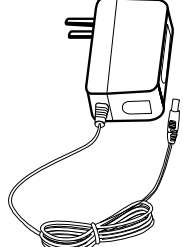
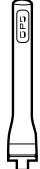
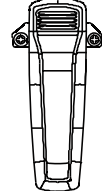
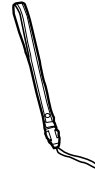
Please unpack carefully and check if all items listed below are received. If any item is missing or damaged, please contact your dealer.

		
Radio	Battery	Charger
		
Power Adapter	Antenna	Belt Clip
		
Strap	Documentation Kit	

Note

- The pictures in this manual are for reference only.
- The frequency band is marked on the label of antenna; if it is unavailable there, see the label on the radio.

2. Product Overview

2.1 Product Controls

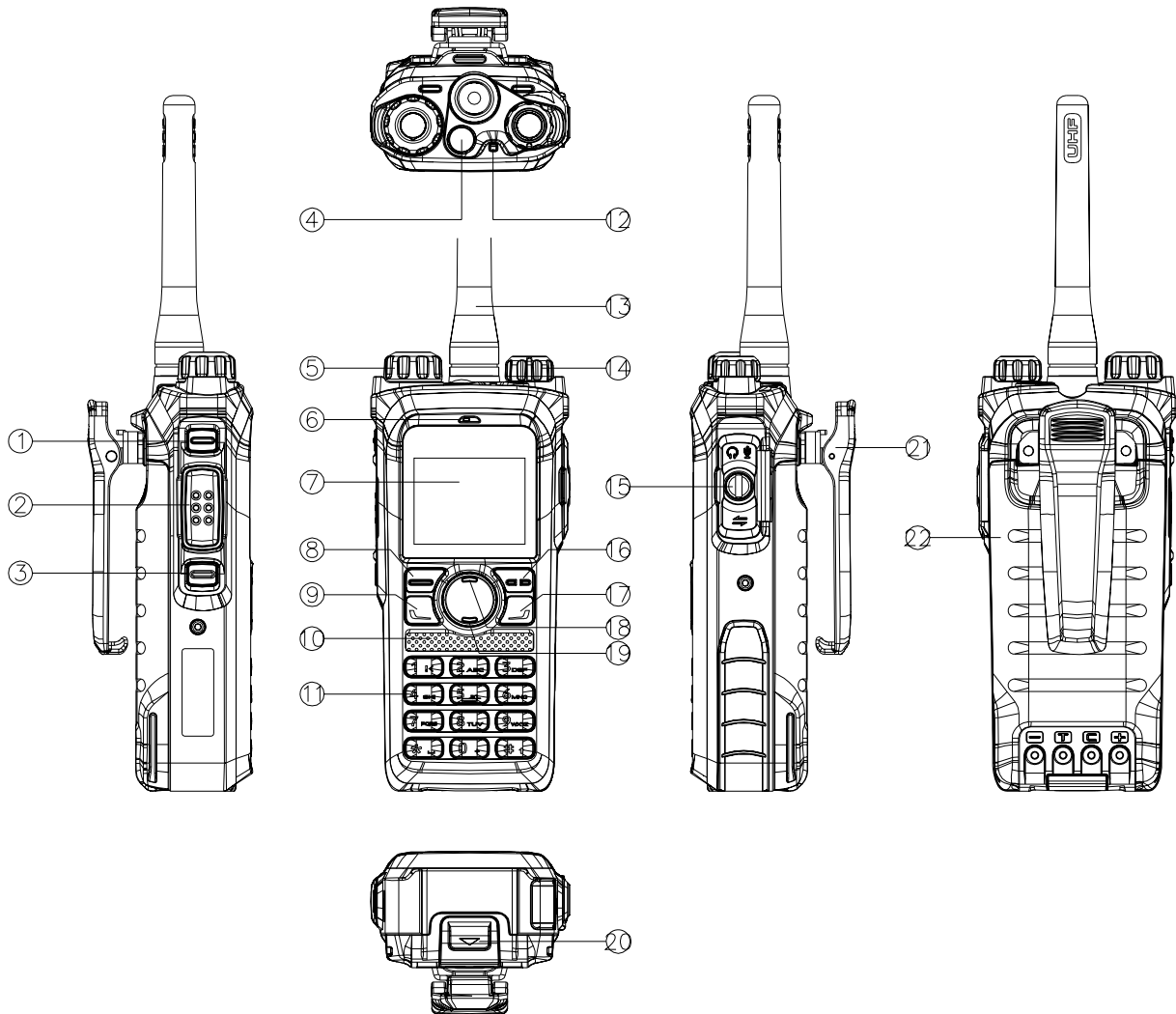











No.	Part Name	No.	Part Name
1	Side Key 1 (SK1)	12	LED Indicator
2	Push-to-Talk (PTT) Key	13	Antenna
3	Side Key 2 (SK2)	14	On-Off/Volume Control Knob
4	Top Key (TK)	15	Accessory Connector
5	Group Selector Knob	16	Back/Subgroup Key
6	Microphone	17	P2 Key
7	LCD Display	18	Up Key























No.	Part Name	No.	Part Name
8	OK/Menu Key	19	Down Key
9	P1 Key	20	Battery Latch
10	Speaker	21	Belt Clip
11	Numeric Keypad	22	Battery



Note

For enhanced convenience, you may request your dealer to program the **TK**, **SK1**, and **SK2** as shortcuts to radio features. For the detailed introduction, see the *DMR Trunking Radio Feature Description and Operation Manual* along with the product.

2.2 LCD Icon

Icon	Radio Status
	The DTMF keypad is enabled.
	The GPS feature is enabled, and the radio receives GPS data.
	The GPS feature is enabled, but the radio receives no GPS data.
	The number of bars (0–3) indicates the charge remaining in the battery.
	The radio is set at Low power.
	The radio is set at High power.
	An accessory is connected.
TM-DW	TM-DW: The radio registers with multiple base stations (BSs) connected via the network.
TM-DL	TM-DL: The radio registers with a single BS.
	The radio is roaming.
	The radio is hunting. This icon will not appear during the Background Hunt, HomeStation Hunt or Handover.
	The VOX feature is enabled.
	There is/are unread short message(s).

	The Inbox is full.
	There is/are unread status message(s)
	There is no signal in TM-DW mode.
	The number of bars (1–4) indicates the radio signal strength in TM-DW mode.
	There is no signal in TM-DL mode.
	The number of bars (1–4) indicates the radio signal strength in TM-DL mode.
	The speaker is unmuted.
	The radio operates in silent mode.
	The LQO feature is enabled.
	No TF card is detected.
	The radio is in emergency alarm mode.
	The Encrypt feature is enabled.
	The Call Divert feature is enabled.
	One or more work orders are received.
	The maximum number of saved work orders is reached.
	A half-duplex private call is in progress.
	A full-duplex private call is in progress.
	There is/are missed call(s).
	The Mode Automatic Switch feature is enabled.
	The BT feature is enabled.
	The wireless device is connected.
	A private call is in progress or a private contact is in the contact.
	A group call is in progress or a group contact is in the contact.

	An all call is in progress.
	An include call is in progress.

2.3 LED Indicator

LED Indication	Radio Status
Flashes green	Being turned on.
Flashes green slowly	Standby.
Glow green	Receiving.
Glow red	Transmitting.
Flashes red (on the calling radio)	Establishing a call.
Flashes orange rapidly (on the called radio)	Establishing a Full Off Air Call Set-Up (FOACSU) private call.
Flashes orange slowly	Hunting.
Glow orange	Call hang time: No voice is being transmitted or received on the traffic channel during a call. Within such a period, you can hold down the PTT key to speak.
Glow blue	The BT feature is being enabled.
Flashes blue every 3s	The BT feature is enabled, but no wireless device is connected.
Flashes blue every 1.5s	The wireless device is connected.
Flashes blue every 0.1s	The BT feature is being disabled.

3. Before Use

3.1 Attaching the Antenna

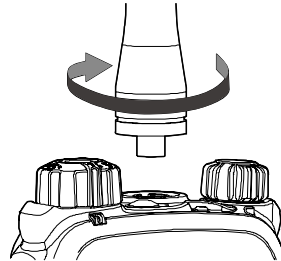

Caution

Do not hold the radio by its antenna; otherwise, the radio performance may be reduced and the life span of the antenna may be shortened.

3.2 Installing the TF Card

Install the TF card as follows if required:

Step 1 Loosen the screw fixing the TF card cover, remove the cover, and then place the card in the holder properly as shown below.

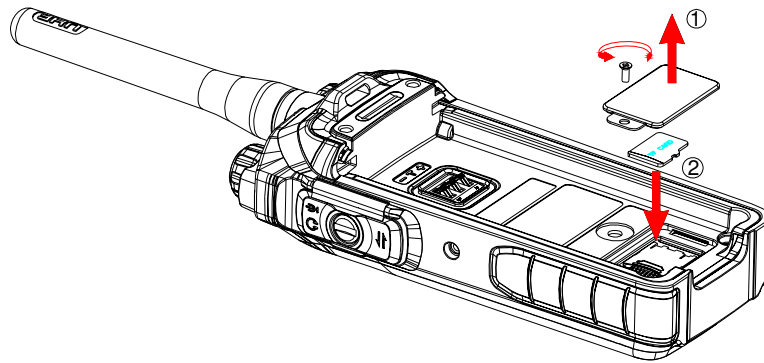

Step 2 Replace the cover and tighten the screw as shown below.

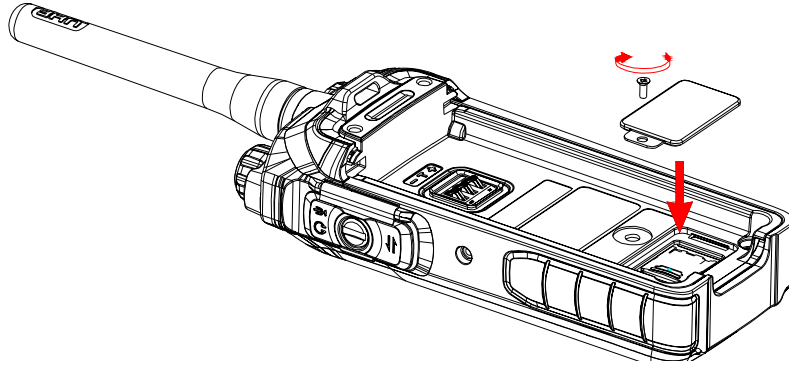

3.3 Attaching the Battery

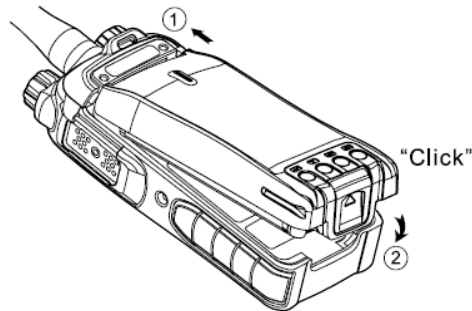

Note

To remove the battery, make sure that the radio is turned off, and then slide the battery latch upwards to unlock the battery.

3.4 Attaching the Belt Clip

Step 1 Unfasten the two screws on the back of the radio.

Step 2 Align the screw holes on the belt clip with those on the back of the radio, as shown below.

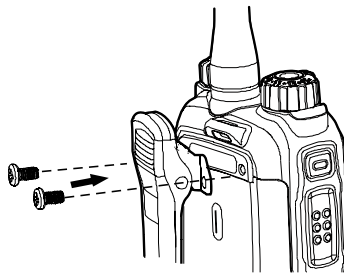

Step 3 Tighten the screws.

3.5 Attaching the Accessories

Caution

For optimal waterproof and dustproof performance:

- Do not scrape the silicone waterproof pad surrounding the screw hold of the accessory connector.
- Do close the accessory connector cover and fasten the screw after removing the accessory.

Step 1 Loosen the screw fixing the accessory connector cover, and open the cover as shown below.

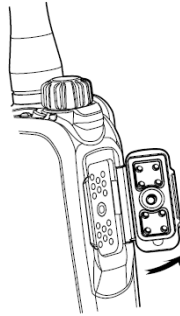

Step 2 Align the accessory (such as an audio accessory or a programming cable) plug with the accessory connector.

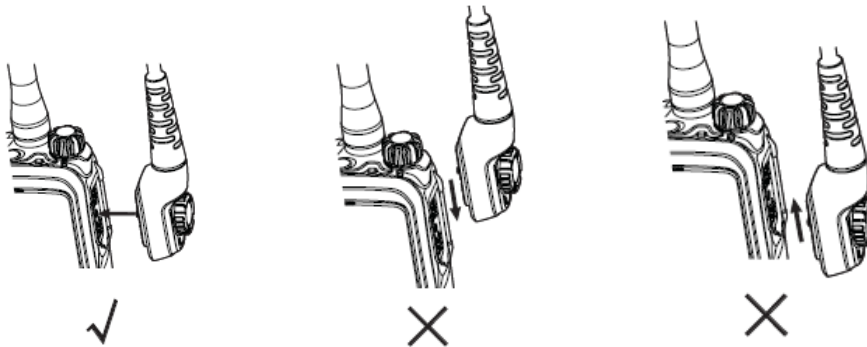

Step 3 Tighten the screw on the accessory plug.

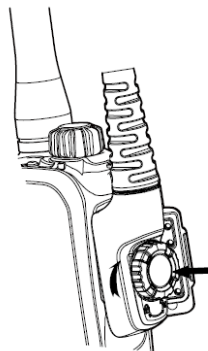

3.6 Charging the Battery

Caution

Use the charger specified by the Company to charge the battery.

Be sure to charge the battery fully before initial use, since reduction of state of charge (SoC) may lead to low battery alarm. You can charge the standalone battery or the radio with battery attached. It is

recommended that your radio remain powered off during charging.

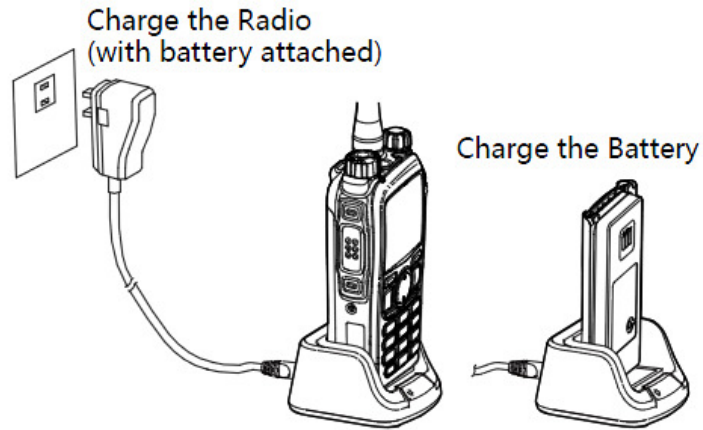

The LED indicator on the charger shows the charging status. For details, see the following table.

LED Indication	Charging Status
Flashes red slowly	The battery is inserted incorrectly.
Glowes red	The battery is charging.
Glowes orange	The battery is charged to 90% or more.
Glowes green	The battery is fully charged.
Flashes red rapidly	The battery fails to be charged.

4. Basic Operations

4.1 Turning On/Off the Radio

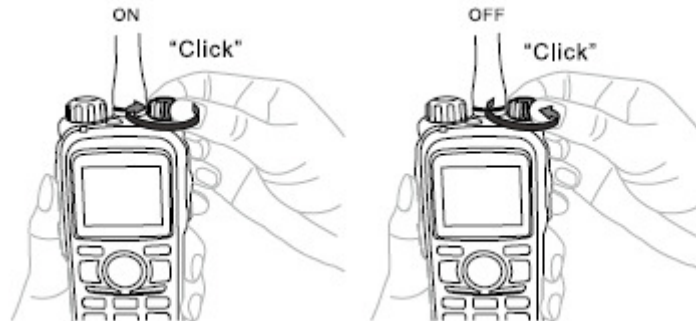

Note

Upon power-on, the radio automatically checks whether the battery is approved by the Company. If yes, "Certificated Battery" (for an anti-fake battery) or "Smart Battery" (for a smart battery) appears on the screen; if no, "Not Certificated Battery" appears.





4.2 Checking the Battery

Using a battery not approved by the Company makes the battery power indication inaccurate and reduces the radio performance.

To check the battery, go to "Menu -> Settings -> Radio Set -> Battery". If "Not Certificated Battery" appears, it is recommended that you replace the battery with one approved by the Company.

4.3 Checking the Battery Power

You can check the current battery power by holding down the **Battery Power Indicator** key programmed by your dealer, and release the key to exit. Battery power indications and alert tone are listed below:

LED Indication/Tone	Icon
The LED Indicator glows green.	
The LED Indicator glows orange.	
The LED Indicator glows red.	
The LED Indicator glows red and an alert tone sounds.	 The battery runs low. Please recharge or

LED Indication/Tone	Icon
	replace the battery for proper radio operation.

4.4 Registering with BS

Upon power-on, the radio automatically hunts the control channels to find an available BS for registration. During hunting, the radio displays "Out of Range" with the icon , the LED indicator flashes orange slowly, and the radio emits the hunt tone.





The radio automatically registers with the found BS for communication. If you want the radio to register with another BS, press the programmed **Manual Current Hunt** key to hunt again.

4.5 Adjusting the Volume



4.6 Inputting via Keypad

You can use the keypad to enter user aliases or IDs and text messages. Here are some useful tips:

- To switch the input method between alphabetic mode and numeric mode, press .
- To enter special characters, press  in the alphabetic mode or  in the numeric mode.
- To enter the space, press  in the alphabetic mode.

4.7 Locking or Unlocking Keys and Knobs

When the keypad is not in use, it is recommended that you lock it to avoid misoperations. To lock or unlock the keypad, do one of the following:

- Automatically lock or unlock the keypad

The Keypad Lock feature allows the keypad to be locked automatically if no operation is performed within the preset time period.

To enable or disable this feature, go to "Menu -> Settings -> Radio Set -> Keypad Lock", and then select "Enable" or "Disable".

- Manually lock or unlock the keypad

To manually lock or unlock the keypad, do one of the following on the home screen:

- Press the **Keypad Lock** key programmed by your dealer.
- Press the **OK/Menu** key and then press  .

Note

You can go to "Menu -> Settings -> Radio Set -> Optional Key" to set whether the following keys and knobs will be locked when the keypad is locked: **TK**, **P1**, **P2**, **SK1**, **SK2**, **Channel Selector** knob, **On-Off/Volume Control** knob, and **PTT**.

4.8 Selecting a Subgroup

A subgroup is a collection of groups. To select a subgroup, do as follows:

Step 1 Press the **OK/Menu** key or the programmed **Subgroup** key to access the "Subgroup" menu.

Step 2 Select the appropriate subgroup.

Step 3 Select "Set Default", and press the **OK/Menu** key.

4.9 Selecting a Group Contact

You can rotate the **Group Selector** knob to select an appropriate group contact. If no corresponding group contact is preset, the radio will emit a tone and display "No Group Program!" on the screen.

4.10 Creating a Private Contact

To add a new contact to the private contact list, go to "Menu -> Contact -> New Contact", enter the ID and alias of the new contact, and save it.

Note

- The ID and alias of a new contact must be unique.
- You can also save the IDs from the Call Logs into the contact list.

5. Call Services

After the radio is turned on and registered, you can make and receive calls. To ensure optimal voice quality of the receiving radio, keep the microphone about 2.5 to 5 centimeters away from your mouth when the radio is transmitting.

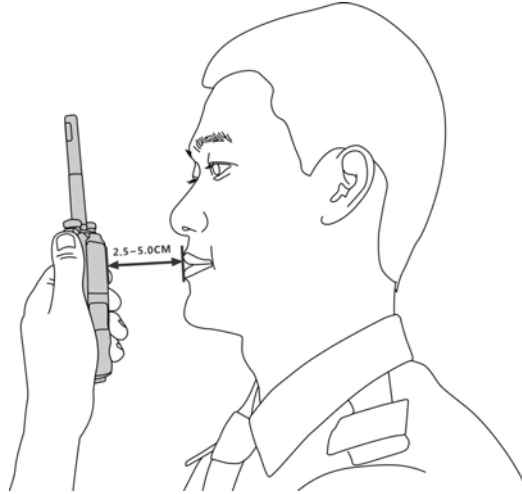

Note

If the radio does not register successfully or an empty group is selected by the **Group Selector** knob, the radio cannot initiate any call.

5.1 Group Call

A group call is a call from an individual user to a group of users. In a group call, both the calling party and called parties can speak.

5.1.1 Initiating a Group Call

You can hold down the **PTT** key to directly initiate a group call to the group contact selected by the **Group Selector** knob. In this case, the radio displays  on the screen.

For other ways to initiate a group call, see the *DMR Trunking Radio Feature Description and Operation Manual* along with the product.

Note

If your dealer assigns a group contact to the programmed **One Touch Call/Menu** key, you can initiate a group call to the designated group contact by pressing the key.

5.1.2 Answering a Group Call

You can answer a group call without any operation. After the group call is established successfully, the

radio emits a tone and displays  on the screen.

5.1.3 Ending/Exiting a Group Call

You can press  to end an outgoing group call or exit an incoming group call.

For other situations in which a group call is terminated, see the *DMR Trunking Radio Feature Description and Operation Manual* along with the product.

5.2 Private Call

A private call is a half-duplex or full-duplex call from an individual user to another individual user. You can go to "Menu -> Settings -> Radio Set -> Call Setup Mode" to switch the call setup mode between Half Duplex and Full Duplex. If your dealer associates the Call Setup Mode feature with a shortcut key, you can also press the shortcut key to switch the call setup mode.

5.2.1 Initiating a Private Call

Step 1 Go to "Menu -> Contact -> Favorites/Private Contact".

Step 2 Use the **Up** or **Down** key to select the contact to be called.

Step 3 Press the **PTT** key to initiate a private call.

In this case, the radio displays  on the screen.

For other ways to initiate a private call, see the *DMR Trunking Radio Feature Description and Operation Manual* along with the product.

Note



If your dealer assigns a private contact to the programmed **One Touch Call/Menu** key, you can initiate a private call to the designated contact by pressing the key.

5.2.2 Answering a Private Call

A half-duplex private call can be answered in Full Off Air Call Set-Up (FOACSU) or Off Air Call Set-Up (OACSU) manner, while a full-duplex private call can be answered only in FOACSU manner.

- FOACSU

When you receive a private call, the radio emits the incoming call tone and displays  on the screen.

You can press  or hold down the **PTT** key within the preset time period to answer the call. After the call is established successfully, the radio emits a tone and displays  on the screen. If you do not answer this call, the radio will display  on the screen to notify you of the missed call.

- OACSU

You can answer a private call without any operation. The call is established automatically, and the radio displays  on the screen.

5.2.3 Ending a Private Call

You can press  to end a private call.

For other situations in which a private call is terminated, see the *DMR Trunking Radio Feature Description and Operation Manual* along with the product.

5.3 Emergency Call

In case of emergency, you can use the Emergency Call feature to ask for help from your companion or the control center.

This feature needs to be enabled by your dealer. For details, see the *DMR Trunking Radio Feature Description and Operation Manual* along with the product.

6. Message Services

Message services allow you to edit a new message and send it directly or save it to the Drafts, directly send a quick text message, and forward the messages saved in the Inbox and Outbox.

New Message

New Message allows you to create a message. You can send the new message to a private contact or group contact, or save it to the Drafts.

Quick Text

Quick Text allows you to send the frequently used messages preset by your dealer. You can send the quick text message directly or edit it before sending it.

Status Message

Status Message allows you to directly send a status message preset by your dealer.

The status message contains the message text and message code, both of which are preset by your dealer. When a status message is sent, only the message code will be transmitted, to ensure communication privacy.

Inbox

The Inbox saves the received messages and marks each message with a corresponding icon to indicate its status.

When the Inbox is full, the earliest message will be overwritten by the latest one automatically.

Outbox

The Outbox saves the sent messages and marks each message with a corresponding icon to indicate its status.

When the Outbox is full, the earliest message will be overwritten by the latest one automatically.

Drafts

The Drafts saves the edited messages. When the Drafts is full, the earliest message will be overwritten by the latest one automatically.

If the message in the Drafts is sent successfully, it will be moved from the Drafts to the Outbox.

Otherwise, the message will remain in the Drafts and be saved into the Outbox as well.

7. Troubleshooting

Phenomena	Analysis	Solution
The radio cannot be turned on.	The battery may be installed improperly.	Remove and reattach the battery.
	The battery power may run out.	Recharge or replace the battery.
	The battery may suffer from poor contact caused by dirtied or damaged battery contacts.	Clean the battery contacts or replace the battery.
The radio cannot register.	The radio may not detect signals from the BS.	Make sure the radio is within the coverage of the BS.
	The radio may be unauthorized.	Contact the BS manager to check whether the radio is authorized in the network management system.
The radio registers repeatedly.	The signal may be discontinuous.	Make sure the radio is within the coverage of the BS.
The radio cannot establish a call.	The signal may be weak.	Make sure the radio is within the coverage of the BS.
The called party disconnects repeatedly during communication.	The signal may be discontinuous.	Make sure the radio is within the coverage of the BS.
During receiving, the voice is weak, discontinuous or totally inactive.	The battery power may be low.	Recharge or replace the battery.
	The volume level may be low.	Increase the volume by rotating the On-Off/Volume Control knob clockwise, or request your dealer to disable the Digital MIC AGC feature.
	The antenna may get loose	Turn off the radio, and remove and reattach the

Phenomena	Analysis	Solution
	or may be improperly installed.	antenna.
	The speaker may be blocked.	Clean the surface of the speaker.
You cannot communicate with other group members.	The signal may be weak.	Make sure you and the group members are within the communication range.
The voice is unclear.	The signal may be weak.	Make sure call participants are within the communication range.
The noise is too loud.	The signal may be weak.	Make sure call participants are within the communication range.
	You may locate in an unfavorable position. For example, your communication may be blocked by high buildings or frustrated in the underground areas.	Move to an open and flat area, and restart the radio to try again.
	You may suffer from external disturbance (such as electromagnetic interference).	Stay away from equipment that may cause interference.
You cannot use the keys.	The keypad may fail to function temporarily.	Restart the radio.
The LCD does not display any information.	The LCD may fail to function temporarily.	Restart the radio.

If the above solutions cannot fix your problems, or you may have some other queries, please contact us or your local dealer for more technical support.

8. Care and Cleaning

To guarantee optimal performance as well as a long service life of the product, please follow the tips below.

Product Care

- Do not pierce or scrape the product.
- Keep the product far away from substances that can corrode the circuit.
- Do not hold the product by its antenna or earpiece cable directly.
- Attach the accessory connector cover when the accessory is not in use.

Product Cleaning

Caution

Turn off the product and remove the battery before cleaning.

- Clean up the dust and fine particles on the product surface and charging piece with a clean and dry lint-free cloth or a brush regularly.
- Use neutral cleanser and a non-woven fabric to clean the keys, knobs and front case after long-time use. Do not use chemical preparations such as stain removers, alcohol, sprays or oil preparations, so as to avoid surface case damage.
- Make sure the product is completely dry before use.

9. Optional Accessories

Contact your local dealer for the optional accessories of the product.

Caution

Use the accessories specified by the Company only; otherwise, the Company shall not be liable for any loss or damage arising out of use of unauthorized accessories.