

# Hytera

*OWNER'S MANUAL*

*TETRA PORTABLE TERMINAL  
TETRA*



## Copyright Information

Hytera is the trademark or registered trademark of Hytera Communications Co., Ltd. (the Company) in PRC and/or other countries or areas. The Company retains the ownership of its trademarks and product names. All other trademarks and/or product names that may be used in this manual are properties of their respective owners.

## Disclaimer

The Company endeavors to achieve the accuracy and completeness of this manual, but no warranty of accuracy or reliability is given. All the specifications and designs are subject to change without notice due to continuous technology development. No part of this manual may be copied, modified, translated, or distributed in any manner without the express written permission of us.

We do not guarantee, for any particular purpose, the accuracy, validity, timeliness, legitimacy or completeness of the Third Party products and contents involved in this manual.

If you have any suggestions or would like to learn more details, please visit our website at: <http://www.hytera.com>.

## RF Radiation Information

This product must be restricted to operations in an Occupational/Controlled RF exposure Environments. Users must be fully aware of the hazards of the exposure and able to exercise control over their RF exposure to qualify for the higher exposure limits.

### RF Radiation Profile

Radio Frequency (RF) is a frequency of electromagnetic radiation in the range at which radio signals are transmitted. RF technology is widely used in communication, medicine, food processing and other fields. It may generate radiation during use.

## RF Radiation Safety

In order to ensure user health, experts from relevant industries including science, engineering, medicine and health work with international organizations to develop standards for safe exposure to RF radiation. These standards consist of:

- United States Federal Communications Commission, Code of Federal Regulations; 47CFR part 2 sub-part J;
- American National Standards Institute (ANSI)/ Institute of Electrical and Electronic Engineers (IEEE) C95. 1-1992;
- Institute of Electrical and Electronic Engineers (IEEE) C95. 1 – 1999;
- International Commission on Non-Ionizing Radiation Protection (ICNIRP) 1998;

## FCC Regulations

Federal Communication Commission (FCC) requires that all radio communication products should meet the requirements set forth in the above standards before they can be marketed in the U.S., and the manufacturer shall post a RF label on the product to inform users of operational instructions, so as to enhance their occupational health against exposure to RF energy.

## Operational Instructions and Training Guidelines

To ensure optimal performance and compliance with the occupational/controlled environment RF energy exposure limits in the above standards and guidelines, users should transmit no more than 50% of the time and always adhere to the following procedures:

- Your radio radiates measurable RF energy only while it is transmitting (during talking), not when it is receiving (listening) or in standby mode.
- Keep the radio at least 2.5 centimeters away from your body during transmission.

## EU Regulatory Conformance

As certified by the qualified laboratory, the product is in compliance with the essential requirements and other relevant provisions of the Directive 1999/5/EC. Please note that the above information is applicable to EU countries only.

# Contents



---

|                                     |           |
|-------------------------------------|-----------|
| <b>Document Conventions</b> .....   | <b>2</b>  |
| Instructional Conventions .....     | 2         |
| Notational Conventions .....        | 2         |
| Key Operation .....                 | 2         |
| Term Explanation .....              | 2         |
| <b>Items in the Package</b> .....   | <b>2</b>  |
| <b>Product Overview</b> .....       | <b>3</b>  |
| Product Controls .....              | 3         |
| Programmable Keys .....             | 3         |
| <b>Before Use</b> .....             | <b>3</b>  |
| Charging the Battery .....          | 3         |
| Assembling the Accessories .....    | 3         |
| <b>Status Indication</b> .....      | <b>4</b>  |
| Status Icon.....                    | 4         |
| LED Indicator.....                  | 5         |
| <b>Menu Navigation</b> .....        | <b>5</b>  |
| TMO Menu.....                       | 5         |
| DMO Menu.....                       | 5         |
| <b>Basic Operations</b> .....       | <b>6</b>  |
| Turning On/Off.....                 | 6         |
| Switching Operation Mode.....       | 6         |
| Adjusting the Call Volume .....     | 6         |
| Inputting through Keypad.....       | 6         |
| Locking/Unlocking the Keypad.....   | 6         |
| PIN Code Security and Changing..... | 6         |
| Managing the Contacts.....          | 6         |
| <b>Call Services</b> .....          | <b>6</b>  |
| TMO.....                            | 6         |
| DMO .....                           | 8         |
| <b>Message</b> .....                | <b>8</b>  |
| Status Message .....                | 8         |
| User Message .....                  | 8         |
| <b>Troubleshooting</b> .....        | <b>9</b>  |
| <b>Care and Cleaning</b> .....      | <b>9</b>  |
| <b>Optional Accessories</b> .....   | <b>10</b> |
| <b>Appendix</b> .....               | <b>10</b> |
| SSI&TSI Dialing Rules .....         | 10        |

## Document Conventions

For your better understanding of this manual, please read the following conventions first.

## Instructional Conventions

| Icon   | Description  |
|--|--|
|  <b>Note</b>    | Indicates references that can further describe the related topics.   |
|  <b>Caution</b> | Indicates situations that could cause data loss or equipment damage. |

## Notational Conventions

| Convention  | Description  |
|-------------|--|
| " "         | The quotation marks enclose the name of a software interface element. For example, click "OK".   |
| <b>Bold</b> | The text in boldface denotes the name of a hardware button. For example, press the <b>PTT</b> key.   |
| ->          | The symbol directs you to access a multi-level menu. For example, to select "New" from the "File" menu, we will describe it as follows: File -> New. |

## Key Operation

| Operation   | Definition   |
|-------------|--|
| Short press | To press a key and release it quickly.                             |
| Long press  | To press a key for the preset time (2s by default) and release it. |
| Hold        | To press a key and do not release it.                              |

## Term Explanation

| Term            | Description   |
|-----------------|---|
| Individual Call | A half-duplex or full-duplex call initiated by an individual user to another individual user. |
| Group Call      | A half-duplex call initiated by an individual user to a group.                                |

| Term                         | Description   |
|------------------------------|---|
| Half-duplex                  | Half-duplex communication is also called "two-way alternate communication". It indicates the communication is provided in both directions, but only one direction at a time, that is, only one party is allowed to transmit or receive at a time.   |
| Full-duplex                  | Full-duplex communication is also called "full-duplex synchronous communication". It indicates the communication is allowed in both directions simultaneously, that is, both parties can transmit and receive at the same time.   |
| Direct Mode Operation (DMO)  | DMO supports half-duplex operation and allows the terminals to communicate directly with each other, without using a TETRA network infrastructure. Thus functions that require network access, such as telephone call, will be unavailable.   |
| Trunked Mode Operation (TMO) | TMO supports either half-duplex or full-duplex operation and allows the terminals to communicate with each other via the TETRA network. Thus functions that require network access are available. To operate in TMO mode, the terminal must be granted authorization by your service provider, and must stay within the network coverage. |

## Items in the Package

Please unpack carefully and check that all items listed below are received. If any item is missing or damaged, please contact your dealer.

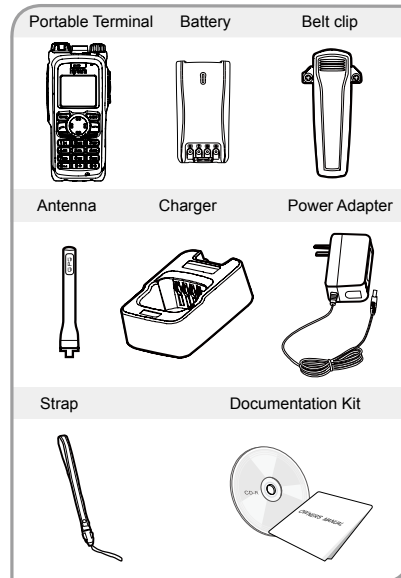

**Note** : The frequency band is marked on the label of antenna; if not, refer to the label on the terminal for frequency band information.

## Product Overview

### Product Controls

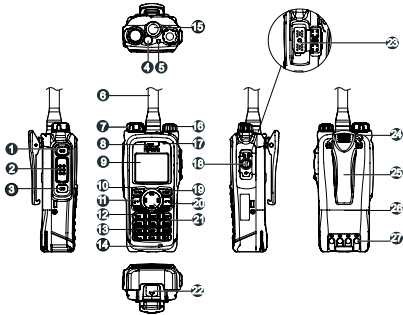

| No. | Part Name              | No. | Part Name                        |
|-----|------------------------|-----|----------------------------------|
| 1   | SK1 (Side Key 1)       | 15  | Antenna Connector                |
| 2   | PTT (Push-to-talk) Key | 16  | Power On-Off/Volume Control Knob |
| 3   | SK2 (Side Key 2)       | 17  | Half-duplex Microphone           |
| 4   | Emergency Key          | 18  | Accessory Contact Cover          |
| 5   | LED Indicator          | 19  | Options/Back Key                 |
| 6   | Antenna                | 20  | End Key                          |
| 7   | Group Selector Knob    | 21  | Navigation Key                   |
| 8   | Full-duplex Receiver   | 22  | Battery Latch                    |
| 9   | LCD Display            | 23  | Accessory Contact                |
| 10  | Func/OK Key            | 24  | Strap Hole                       |
| 11  | Answer/Call Key        | 25  | Belt Clip                        |
| 12  | Half-duplex Speaker    | 26  | Battery                          |
| 13  | Numeric Keypad         | 27  | Charging Piece                   |
| 14  | Full-duplex Microphone |     |                                  |

## Programmable Keys

For enhanced convenience, you can request your dealer to program the keys (SK1, SK2, navigation key, answer/call key, numeric keys 1-9, **[\*]** and **[#]**) as the shortcuts to needed menus and functions. For the detailed introduction, please read the corresponding TETRA Terminal Series Feature Book.

## Before Use

### Charging the Battery



**Caution:** Make sure the radio is powered off during charging.

Only use the charger and battery specified by the Company. The charger LED indicator will indicate the charging process. See the figure below showing the steps for charging.

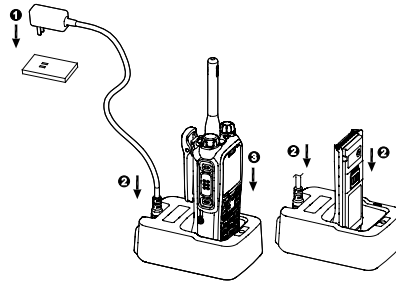

1. Connect the power adapter to AC socket. See arrow ①.
2. Plug the other end of the power adapter into the rear jack of charger. See arrow ②.
3. Place the terminal with the battery attached, or the battery alone, into the charger. See arrow ③.

During charging, the LED indicator on the charger will indicate the charging status. The charging begins when the charger LED glows red. When charging is complete, the charger LED glows green.

See the following table for details.



#### Note :

- To achieve optimal battery performance, please charge the battery for 5 hours before initial use.
- Be sure to read the Safety Information Booklet, to get necessary safety information.

| LED Indication      | Charging Status  |
|---------------------|------------------|
| Flashes red slowly  | Standby(no load) |
| Glows red           | Charging         |
| Glows orange        | 90% charged      |
| Glows green         | Fully charged    |
| Flashes red rapidly | Failure          |

## Assembling the Accessories

### Installing the SIM card

If a SIM card is required to realize the End-to-End Encryption (E2EE) feature which should be purchased separately, please install the SIM card first.

1. Turn off the terminal, and then slide the battery latch upwards to unlock the battery.
2. Loosen the screw fixing the SIM card cover, remove the cover, and then place the card in the holder properly as shown below.

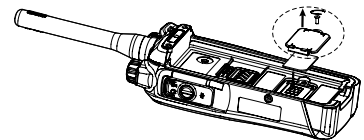

3. Replace the cover and tighten the screw as shown below.

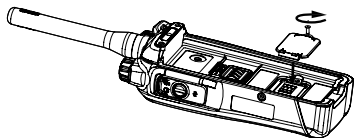

### Attaching the Antenna

Turn the antenna clockwise to fasten it.

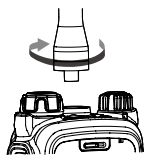

To remove the antenna, rotate it counter-clockwise.

### Attaching the battery

1. Fit the battery into the battery slot properly as shown by arrow ① below.
2. Slightly press the bottom of the battery until a click is heard as shown by arrow ② below.

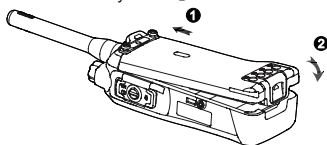

### Attaching the Belt Clip

1. Remove the two screws on the back of the terminal.
2. Align the screw holes on the belt clip with those on the terminal's body, and then tighten the screws as shown below.

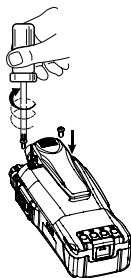

To remove the belt clip, loosen the screws. Please keep the screws properly. It is recommended to replace them to the terminal.

### Assembling the Audio Accessory/ Programming Cable

1. Loosen the screws on the accessory contact cover, and open the cover as shown below.



2. Align the pins on plug with the accessory contact.
3. Tighten the screws on the plug.

To remove the accessory, loosen the screw and pull out the plug.

After the above assembly procedure, the terminal is ready for use.



**Caution:** When you are using an external accessory, waterproof performance of the radio may get affected.

## Status Indication

### Status Icon

| Name                  | Icon | Indication   |
|-----------------------|------|--|
| Battery Strength Icon |      | The battery is low.  |
|                       |      | More bars indicate better battery strength.                                    |
| RSSI Icon             |      | The terminal has not registered with the network (applicable for TMO only).    |
|                       |      | More bars indicate better signal strength.                                     |
| Message Icon          |      | Unread message(s).   |
|                       |      | The Inbox is full.   |
| Operation Mode Icon   |      | The terminal is operating in TMO.  |
|                       |      | The terminal is operating in DMO.  |
|                       |      | The terminal is operating in fall-back mode.                                   |
| Profile Icon          |      | Silent   |
|                       |      | Normal   |
|                       |      | Vibration  |
| Accessory Icon        |      | The audio accessory is connected.  |
| GPS Icon              |      | A GPS module is connected and the valid GPS data is received.                  |
|                       |      | Valid GPS data can be received, and the audio accessory has been connected.    |
|                       |      | A GPS module is connected and no valid GPS data is received.                   |
|                       |      | No valid GPS data can be received, and the audio accessory has been connected. |

| Name                 | Icon | Indication  |
|----------------------|------|---|
| Call Icon            |      | A call is in progress.                                |
| Group Selection Icon |      | The terminal is selecting a talkgroup.                |
| Gateway Icon         |      | A gateway device is available and connected in DMO.   |
|                      |      | A gateway device is available but unconnected in DMO. |
| Repeater Icon        |      | A repeater is available and connected in DMO.         |
|                      |      | A repeater is available but unconnected in DMO.       |

## LED Indicator

| LED Indication       | Terminal Status      |
|----------------------|----------------------|
| Glowes red           | Transmitting         |
| Glowes green         | Receiving            |
| Flashes green slowly | Channel free in DMO. |
| Glowes orange.       | Channel busy in DMO  |

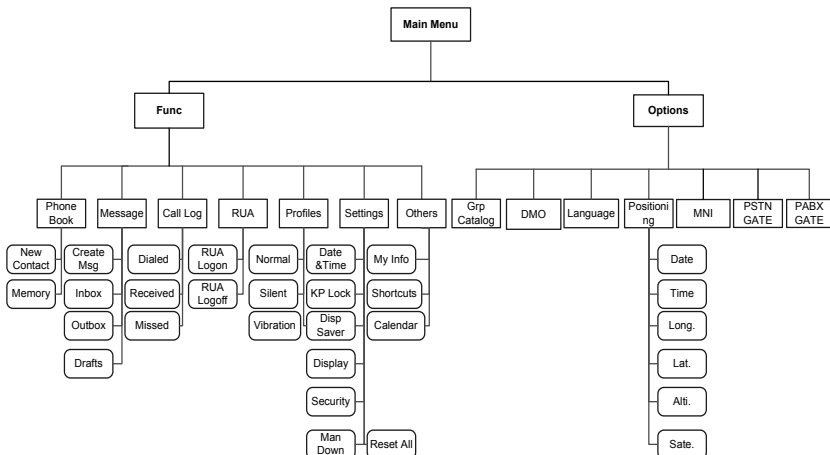

## DMO Menu

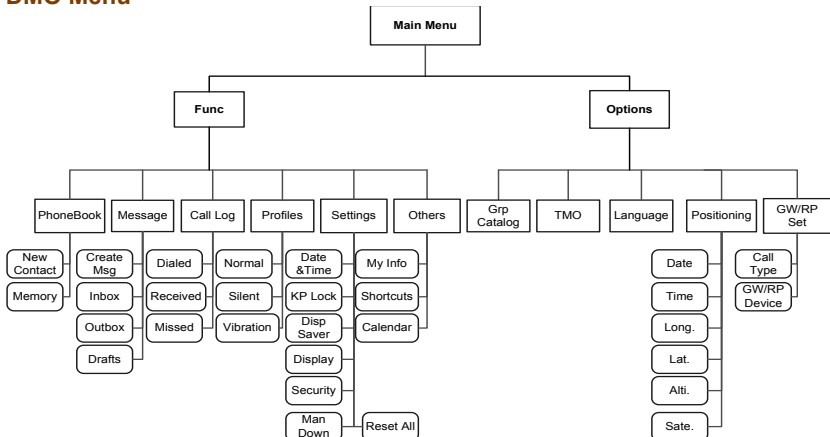

## Menu Navigation

The following menu lists show the full menus of the terminal in TMO and DMO. You can select your needed menus to be displayed via your dealer. To select and confirm the options in the menu, operate as follows: in the home screen, you can press the **Func/OK** key to enter the "Func" menu, or press the **Options/Back** key to enter the "Options" menu; then press the **Up/Down** key on the **Navigation** key to select the needed menu, finally press the **Func/OK** key to confirm. In sections introducing operations, a menu path is provided for your convenience, e.g. Message -> Create Msg.

## TMO Menu

## Basic Operations

---

### Turning On/Off

To turn on the terminal, rotate the **Power On-Off/Volume Control** knob clockwise. Then the LED indicator flashes green, and the terminal shows the power-up screen and sounds power-up alert. Upon successful powering on, the terminal enters the home screen. In TMO, after being turned on, the terminal will logon to the network. In DMO, the terminal will be ready for use after being turned on.

To turn off the terminal, rotate the **Power On-Off/Volume Control** knob counter-clockwise until a click is heard.

### Switching Operation Mode

This terminal can operate in either TMO or DMO. To switch the operation mode, press the **Options/Back** key in the home screen to enter the "Options" menu, and then select "TMO" or "DMO".

### Adjusting the Call Volume

Rotate the **Power On-Off/Volume Control** knob clockwise to increase the call volume, or counter-clockwise to decrease the volume. After the adjustment, the terminal will save the settings and return to the former screen automatically.

### Inputting through Keypad

You can use the numeric keypad to enter user alias and number, edit messages, etc. The terminal supports these input methods: English and Number. To switch the input method, press the **[#1]** key on the numeric keypad. In either input method, you can enter special characters and common punctuations by pressing **[1<]**, enter "\*" by pressing **[\*]** and enter a space by long pressing this key **[>]**. As for other language input methods (depending on your customization), operate accordingly.

### Locking/Unlocking the Keypad

To enable the keypad lock, enter the Func menu by pressing the **Func/OK** key in the home screen, and then go to "Settings -> KP Lock -> On". After this feature is enabled, keypad will get locked automatically when the preset time (preset by the dealer) expires. To unlock the keypad, press the **Func/OK** key and then **[\*]**.

Apart from locking the keypad via menu, you can lock the keypad quickly and temporarily by pressing the **Func/OK** key and then **[\*]** directly in the home screen.

### PIN Code Security and Changing

PIN code can prevent unidentified user from using your terminal. To enable or disable the PIN Code feature, enter the Func menu from the home screen by pressing the **Func/OK** key, then go to "Settings -> Security -> PIN Code". Every time you need to change the settings, it is required to input the PIN code first (default PIN code: 1234, preset by the dealer).

With this feature enabled, you will need to enter the correct PIN code prior to operating the terminal after turning it on. If you input the wrong code for continuous 3 times (predefined by the dealer), the terminal will be locked. In this case, you will need to enter the correct PUK code (default PUK code: 12345678) to reset the PIN code.

To change the PIN code, go to "Settings -> Security -> ChangePIN" from the home screen, and input the correct current PIN code prior to changing the code.

### Managing the Contacts

#### Contact List

To view the list, go to the "Func. -> PhoneBook" from the home screen.

#### New Contact

To add a new contact, you can enter the **Func** menu by pressing **Func/OK** key and go to "PhoneBook".

Then press the **Func/OK** key to enter "Options -> New Contact" to add a new contact: enter the contact's alias in the editing screen, and press the **Func/OK** key to enter the "Input No." screen to input the contact number. And press the **Func/OK** key again to select the call type ("Private No.", "PABX" or "PSTN"). Finally, press **Func/OK** key to confirm.

#### Viewing the Memory

To view the phonebook memory, you can enter the Func menu by pressing the **Func/OK** key, and go to "PhoneBook" menu; then press **Func/OK** to enter "Memory".

## Call Services

---

### TMO

#### Individual Call

In TMO, an individual call can be initiated either as a half-duplex call or full-duplex call, which can be received without pressing any key (Direct Signaling) or by pressing the **Answer/Call** key or **PTT** (Hook Signaling). Contact your dealer for such programming as well as more details.

#### Initiating an Individual Call

- Via Menu

In the home screen, press **Func/OK** key to enter the "PhoneBook" or "Call Log" submenu, and select a contact. Then press **PTT** to initiate a half-duplex call, or press **[>]** to initiate a full-duplex call.

- Via Manual Dial

In the home screen, to initiate a half-duplex individual call, input the number you want to call through the keypad, and then press **PTT**. To initiate a full-duplex individual call, input the number you want to call through



the keypad, and press **group** repeatedly to select the call type "Private No.". Then press  to initiate a full-duplex call.



#### Note:

- Entry of individual numbers must comply with the SSI&TSI dialing rules. See "SSI&TSI Dialing Rules" in "Appendix" for more details.
- Calls will end automatically if the predefined call timer expires.

### Answering an Individual Call

- Half-duplex Individual Call
  - » If it is an incoming call with Direct Signaling, there will be an alert tone to inform the called party that a call is received.
  - » If it is an incoming call with Hook Signaling, the terminal sounds alert and vibrates to inform the called party that there is an incoming call. And to receive the call, the **PTT** key or **Func/OK** key should be pressed.

To take the talk rights during the call, there are two situations: 1) if you have no pre-emptive priority, hold down **PTT** to talk after the talking party stops talking and releases its **PTT**; 2) if you have already been programmed with pre-emptive priority, hold down **PTT** to talk at any time.

- Full-duplex Individual Call
  - » If it is an incoming call with Direct Signaling, there will be an alert tone to inform the called party that a call is received.
  - » If it is an incoming call with Hook Signaling, the terminal sounds alert and vibrates to inform the called party that there is an incoming call. And to receive the call, the **PTT**, **Func/OK** key or  should be pressed.

After the call is established, both parties can talk at any time, with no need to use any key.

### Handling up/ Rejecting an Individual Call

When initiating the individual call, press the **Options/Back** key or  to terminate it.

In the presence of an incoming individual call, press the **Options/Back** key or  to reject it.

In the process of an individual call, any party can press



### Group Call

#### Initiating a Group Call

In the home screen, you can initiate a group call to the default group by pressing **PTT**. To call other groups, please do as follows:

1. In the home screen, rotate the **Group Call Selector** knob to select a group. Please perform this step as soon as the icon  appears; otherwise, you may fail to select.
2. Press the **Func/Ok** key to confirm your selection.
3. Press **PTT** to initiate a group call to this group.

#### Answering a Group Call

You can receive a group call without any operation. To take the talk rights during the call, there are two situations: 1) if you have no pre-emptive priority, hold down **PTT** to talk after the talking party stops talking and releases its **PTT**; 2) if you have already been programmed with pre-emptive priority, hold down **PTT** to talk at any time.

#### Hanging up a Group Call

The calling party can press  to exit a group call. And for the called parties in a group call, only those enabled with "Hang Up" feature (programmable by the dealer) can exit a group call.

### Telephone Call

The telephone call is a full-duplex individual call with Hook signaling. To initiate the call, follow the steps below.

#### Initiating a Telephone Call

1. Select a gateway.

In the home screen, press **Options/Back** key to enter the "PSTN GATE" or "PABX GATE" submenu. Select an appropriate gateway, and press **Func/OK** key to confirm.

2. Input a telephone number.

Return to the home screen by pressing . Input a PABX or PSTN number, which is composed of a prefix (specified by the gateway, please contact the system administrator) and the telephone number of the target contact.

3. Select a call type.

Select "PABX" or "PSTN" through the **Func/OK** key with the screen-icon **group**.

4. Press  to initiate the call.

To answer or hang up/reject the call; see the "Individual Call" in "TMO".

### Emergency Call

#### Initiating an Emergency Call

Press the **Emergency** key and you can initiate an emergency call to the predefined contact. Any individual contact, group contact, default group, PSTN or PABX contact can be predefined as the emergency contact. There are two levels for emergency call: emergency priority and pre-emptive priority 3, which can be programmed by your dealer. The emergency priority is endowed with the higher privilege; thus a call with such priority can break any other call with pre-emptive priority 3, as well as calls with lower priorities.

#### Answering an Emergency Call

The emergency call is always received automatically. During an emergency call, the calling party can talk with no need to use any key. If another member needs to talk, he/she should hold down **PTT** only after the talking party stops talking and releases its **PTT**.

#### Hanging up an Emergency Call

See the corresponding part of "Individual call" or "Group call" in accordance with the call type of the predefined contact.

## DMO

### Individual Call

In DMO, an individual call can be initiated only as a half-duplex call.

#### Initiating an Individual Call

In the home screen, directly input the number you want to call through the keypad, or press **Func/OK** key to enter the "PhoneBook" or "Call Log" submenu, and select a contact. Then press **PTT** to initiate the call.



**Note:** Entry of individual numbers must comply with the SSI&TSI dialing rules. See "SSI&TSI Dialing Rules" in "Appendix" for more details.

#### Answering an Individual Call

You can receive an individual call in DMO automatically. During the call, you can hold down **PTT** to talk after the initiating party stops talking and releases its **PTT**.

#### Hanging up an Individual Call

The calling party can press  to terminate the call. And the called party can press  to exit the call.

### Group Call

Group calls in DMO is the same as that in TMO. Please refer to operation method described in "Group Call" in the above "TMO" section.

### Emergency Call

In DMO, emergency calls are endowed with emergency priority only. Please refer to operation method described in "Emergency Call" in the above "TMO" section.

## Message

### Status Message

Status message, which should be programmed by your dealer only, can facilitate instant messaging of the frequently-used messages. You can only send or view rather than editing the status messages. When the message is sent successfully, the target terminal will receive either the status ID of the status message (if the message text has not been predefined via CPS) or the predefined text (if the message text has been predefined via CPS).



**Note:** The "Fixed Status Message" and the "Status Message" are predefined by the dealer via the CPS.

#### Sending a User Message

- Press the **Func/OK** key and navigate to "Message -> Create Msg -> StatusMsg -> Sel Msg". Select a desired status message, and press the **Func/OK** key to proceed. Choose either an individual or a group as the target contact, input the appropriate number and press **Func/OK** to send the message.
- Long press the programmed **Send StatusMsg** key to send the preset status message directly

#### Viewing the User Message

When the icon  appears in the status bar, it indicates there is/are unread message(s). Do as follows to view it:

- In the prompt screen for an unread message, press the **Func/OK** key to enter the Inbox, and press **Func/OK** key again to read.
- In the home screen, press the **Func/OK** key and navigate to "Message -> Inbox -> Inbox". Then you can view the unread message.

### User Message

#### TMO

#### Editing a User Message

Press the **Func/OK** key and navigate to "Message -> Create Msg -> User Msg". Press **Func/OK** again to edit a user message.

#### Sending a User Message

After editing, press **Func/OK** to confirm. Then select the target contact and decide whether to send it as a flash message.



**Note:** If the message is sent as a flash message, the receiving party can preview all the content in a predefined time period without any operation. Once the time period expires, the home screen will get restored, with the icon  displaying on the status bar.

#### Viewing the User Message

When the icon  appears in the status bar, it indicates there is/are unread message(s). Do as follows to view it:

- In the prompt screen for an unread message, press the **Func/OK** key to enter the Inbox, and press **Func/OK** key again to read.
- In the home screen, press the **Func/OK** key and navigate to "Message -> Inbox". Then you can press **Func/OK** key to view the unread message.

#### DMO

#### Editing a User Message

Press the **Func/OK** key and navigate to "Message -> Create Msg -> User Msg". Press **Func/OK** key again to edit a user message.

#### Sending a User Message

After editing, press **Func/OK** to confirm. Then choose either to send to an individual or to a group, and then input the target contact and press **Func/OK** key to send the message.

#### Viewing the User Message

Operate in the same way as that described in "Viewing the User Message" in the above "TMO" section.

## Troubleshooting

| Phenomenon   | Analysis   | Solution  |
|--|--|---|
| Terminals cannot be powered on.  | The battery power gets too low to supply the terminal.   | Charge for the battery.   |
| Network registration fails or network can not be found.  | The terminal is operating in DMO.  | Switch to TMO mode.   |
|  | The terminal gets out of the network coverage (in TMO).<br>The terminal is not granted network access.   | Check the signal strength. Make sure the terminal is within the network coverage.<br>Contact the network operator for the terminal authorization. |
| Calls cannot be initiated.   | The terminal or the called party is not within the network coverage.   | Check the signal strength. Make sure the terminal is within the network coverage.   |
|  | The terminal operates in an improper mode.   | Check the operation mode. Make sure the terminal works in the right mode.   |
| A group call can not be initiated or received.   | The terminal is not a member of the group.   | Check whether the terminal is a member of the group. If not, contact your dealer to add the terminal to the group.                                |
|  | The terminal is not authorized to access the target group.   | Contact the network operator for the terminal authorization.  |
| Calls are always interrupted.  | The current channel is assigned to emergency calls or other calls with higher priority.  | Wait until the channel becomes available and try again.   |
| A half-duplex call can not be established.   | The predefined time period for establishing a call expires.  | Make sure the call is established within the predefined time period.  |
|  | The channel is occupied by another terminal with higher call priority.   | Wait until the channel becomes available and try again.   |
|  | The channel resources are allocated to other services due to overloaded network.   | Wait until the channel becomes available and try again.   |
| Abnormal disconnection occurs during a call.   | The terminal gets out of the network coverage (in TMO).  | Check the signal strength. Make sure the terminal is within the network coverage.   |
|  | The terminal operates at an unfavorable position where communication may be blocked by high buildings or frustrated in the underground areas (in DMO). | Move to an open and flat area, and restart the terminal.  |
| As for the same status message ID, the content displayed at the receiving party is different from that of the sending party. | The parties have associated the same status message ID with different contents.  | Make sure the status message ID is associated with the same content.  |

If the above solutions can not fix your problems, or you may have some other queries, please contact us or your local dealer for more technical support.

## Care and Cleaning

To guarantee optimal performance as well as a long service life of the product, please follow the tips below.

### Product Care

- Do not pierce or scrape the product.
- Keep the product far away from substances that can corrode the circuit.
- Do not hold the product by its antenna or earpiece cable directly.
- Attach the accessory jack cover when the product is not in use.

### Product Cleaning



**Caution:** Power off the product before cleaning.

- Clean up the dust and fine particles on the product surface and charging piece with a clean and dry lint-free cloth or a brush regularly.
- Use neutral cleanser and a non-woven fabric to clean the keys, control knobs and front case after long-time use. Do not use chemical preparations such as stain removers, alcohol, sprays or oil preparations, so as to avoid surface case damage.
- Make sure the product is completely dry before use.

## Optional Accessories

The following items are the main optional accessories for the product, and please consult your local dealer for more other accessories.



**Caution:** Use the accessories specified by the Company only. If not, we shall not be liable for any losses or damages arising out of use of unauthorized accessories.

### Power Supply

MCA05 Battery Optimizing System

BL2505 Li-Ion Battery (2500mAh)

MCA06 MCU Multi-unit Rapid-rate Charger (for Li-Ion/Ni-MH batteries)

MCA08 MCU Multi-unit Rapid-rate Charger (for Li-Ion/Ni-MH batteries)

CH10A06 Dual-Pocket MCU Charger (for Li-Ion/Ni-MH battery)

CHV09 Vehicle Adapter for Charger

### Audio Accessory

ESN12 Earbud

EHN16 C-Earset

EHN17 Swivel Earset

EWN09 Wireless Surveillance Earpiece with Inductive Neckloop

EAN23 Remote Earset with Transparent Acoustic Tube

EAN17 3-Wire Surveillance Earpiece with Transparent Acoustic Tube (Beige)

EAN17 3-Wire Surveillance Earpiece with Transparent Acoustic Tube (Black)

SM18N5 Remote Speaker Microphone (IP67)

SM18N3 Remote Speaker Microphone (IP54)

ES-01 Receive-Only Earbud (used with SM18N3)

EH-01 Receive-Only C-Earset (used with SM18N3)

EH-02 Receive-Only Swivel Earset (used with SM18N3)

ES-02 Receive-Only Earpiece with Transparent Acoustic Tube (used with SM18N3)

### Others

LCY003 Leather Carrying Case for terminal with thin battery (swivel)

LCY006 Leather Carrying Case for terminal with thick battery (swivel)

PC36 Programming Cable (USB Port)

» MCC+MNC+SSI:

- 1) MCC must contain 3 digits. Add 0 before the first digit of MCC which is shorter than 3 digits;
- 2) MNC must contain 4 or 5 digits. When the MNC is shorter than 4 digits, add 0 before its first digit; when it is 5 digits long, use it directly;
- 3) SSI must be 8 digits long. Add 0 before the first digit of SSI which is shorter than 8 digits. For example, when MCC is 460, MNC is 20 and SSI is 504, you need to input 46000200000504.

## Appendix

### SSI&TSI Dialing Rules

In the TETRA system, subscribers are distinguished by different identities. Each subscriber is assigned with a unique short subscriber identity (SSI), which serves a part of the TETRA subscriber identity (TSI). And TSI is generally composed in this way: Mobile Country Code (MCC) + Mobile Network Code (MNC) + SSI. To initiate an individual call, please dial the SSI or TSI in compliance with the rules below.

- SSI Dialing

Make sure there are not more than 8 digits.

- TSI Dialing

» MNC+SSI:

- 1) Input the MNC as it is;
- 2) SSI must be 8 digits long. Add 0 before the first digit of SSI which is shorter than 8 digits. For example, when MNC is 20 and SSI is 504, you need to input 2000000504.

## **FCC Statement**

This equipment has been tested and found to comply with the limits for a Class B digital device, pursuant to part 15 of FCC Rules. These limits are designed to provide reasonable protection against harmful interference in a residential installation. This equipment generates and can radiate radio frequency energy and, if not installed and used in accordance with the instructions, may cause harmful interference to radio communications. However, there is no guarantee that interference will not occur in a particular installation. If this equipment does cause harmful interference to radio or television reception, which can be determined by turning the equipment off and on, the user is encouraged to try to correct.

The interference by one or more of the following measures:

- Reorient or relocate the receiving antenna. Increase the separation between the equipment and receiver.
- Connect the equipment into an outlet on a circuit different from that to which the receiver is connected.
- Consult the dealer or an experienced radio/TV technician for help

Operation is subject to the following two conditions: 1. This device may not cause harmful interference, and 2. This device must accept any interference received, including interference that may cause undesired operation.

Note:” Changes or modifications to this unit not expressly approved by the party responsible for compliance could void the user’s authority to operate the equipment.”

## **Compliance with RF Exposure Standards**

Hytera’s 2-way radio complies with the following RF energy exposure standards and guidelines:

- United States Federal Communications Commission, Code of Federal Regulations; 47 CFR §§ 1.1307, 1.1310 and 2.1093
- American National Standards Institute (ANSI) / Institute of Electrical and Electronic Engineers (IEEE) C95. 1-1992
- Institute of Electrical and Electronic Engineers (IEEE) C95.1-1999 Edition

## **RF Exposure Compliance and Control Guidelines and**

## **Operating Instructions**

To control your exposure and ensure compliance with the occupational/controlled environment exposure limits always adhere to the following procedures.

Guidelines:

- Do not remove the RF Exposure Label from the device.
- User awareness instructions should accompany device when transferred to other users.
- Do not use this device if the operational requirements described herein are not met.

Operating Instructions:

- Transmit no more than the rated duty factor of 50% of the time. To transmit (talk), push the Push-To-Talk (PTT) button. To receive calls, release the PTT button. Transmitting 50 % of the time, or less, is important because this radio generates measurable RF energy exposure only when transmitting (in terms of measuring for standards compliance).
- Hold the radio in a vertical position in front of face with the microphone (and the other parts of the radio, including the antenna) at least one inch (2.5 cm) away from the nose. Keeping the radio at the proper distance is important because RF exposures decrease with distance from the antenna. Antenna should be kept away from eyes.
- When worn on the body, always place the radio in a Hytera's approved clip, holder, holster, case, or body harness for this product. Using approved body-worn accessories is important because the use of Hytera's or other manufacturer's non-approved accessories may result in exposure levels, which exceed the FCC's occupational/controlled environment RF exposure limits.
- If you are not using a body-worn accessory and are not using the radio in the intended use position in front of the face, then ensure the antenna and the radio are kept at least 2.5 cm (one inch) from the body when transmitting. Keeping the radio at the proper distance is important because RF exposures decrease with increasing distance from the antenna.
- Use only manufacturer's name approved supplied or replacement antennas, batteries, and accessories. Use of non-manufacturer-name approved antennas, batteries, and accessories may exceed the FCC RF exposure guidelines.
- For a list of Hytera's approved accessories (see the user manual), or (visit the following website which lists approved accessories: [http: add website address](http://add website address)), or (The manufacturer should include the appropriate bracketed item{s} in the manual.)
- For a list of Hytera's approved accessories (see the user manual), or (visit the following website which lists approved accessories: [www.hytera.cn](http://www.hytera.cn))

## **IC statement**

The device has been tested and compliance with SAR limits, users can obtain Canadian information on RF exposure and compliance

Après examen de ce matériel aux conformité aux limites DAS et/ou aux limites d'intensité de champ RF, les utilisateurs peuvent sur l'exposition aux radiofréquences et la conformité and compliance d'acquérir les informations correspondantes