

## **Preface**

Thank you for purchasing Hytera RD98X series DMR digital repeater.

As a product built to the DMR standard, RD98X is endowed with ergonomic design, reliable performance and comprehensive digital functions to deliver an advanced communication solution. With RD98X, you can make use of digital advantages to top the competition!

To ensure you get maximum benefit from the product, please read this manual carefully before use.

## Icon Information

The following icons are available through this manual:



**Caution:** indicates situations that could cause damage to your repeater or bodily injury.



**Note:** indicates tips that can help you make better use of your repeater.

\* Indicates functions or parts that are not supported by the current version of the repeater, but will be available to future versions.

## Copyright Information

Hytera and HYT are the trademark or registered trademark of Shenzhen Hytera Communications Corporation Limited in PRC and other countries and/or areas. Hytera retains the ownership of its trademarks and product names. All other trademarks and/or product names that may be used in this manual are properties of their respective owners.

The Hytera product described in this manual may include Hytera computer programs stored in memory or other media. Laws in the PRC and/or other countries or areas preserve for Hytera exclusive rights for Hytera computer programs. The purchase of this product shall not be deemed to grant, either directly or by implication, any rights to the purchaser with respect to Hytera computer programs. Any Hytera computer programs may not be copied, modified, distributed, decompiled, or reverse-engineered in any manner without the prior written consent of Hytera.

## Disclaimer

Hytera endeavors to achieve the accuracy and completeness of this manual, but no warranty of accuracy or reliability is given. All the specifications and designs are subject to change without prior notice due to continuous technology development. No part of this manual may be copied, modified, translated, or distributed in any manner without the express written permission of Hytera.

If you have any suggestions or would like to learn more details, please visit us at:

<http://www.hytera.cn>.

## **RF Energy Exposure Compliance**

Your radio is designed and tested to comply with a number of national and international standards and guidelines (listed below) regarding human exposure to radio frequency electromagnetic energy. This radio complies with the IEEE and ICNIRP exposure limits for occupational/controlled RF exposure environment at operating duty factors of up to 50% transmitting and is authorized by the FCC for occupational use only. In terms of measuring RF energy for compliance with the FCC exposure guidelines, your radio radiates measurable RF energy only while it is transmitting (during talking), not when it is receiving (listening) or in standby mode.

### **Your radio complies with the following of RF energy exposure standards and guidelines**

- United States Federal Communications Commission, Code of Federal Regulations; 47CFR part 2 sub-part J
- American National Standards Institute (ANSI)/Institute of Electrical and Electronic Engineers (IEEE) C95. 1-1992
- Institute of Electrical and Electronic Engineers (IEEE) C95. 1-1999 Edition
- International Commission on Non-Ionizing Radiation Protection (ICNIRP) 1998

### **Operational Instructions and Training Guidelines**

- To ensure optimal performance and compliance with the occupational/controlled environment RF energy exposure limits in the above standards and guidelines, users should transmit no more than 50% of the time and always adhere to the following procedures:
- Gain of antenna must not exceed 6.5dBi.
- Mobile antenna Installation: Install the mobile antenna at least 350 cm away from your body, in accordance with the requirements of the antenna manufacturer/supplier.

### **Transmit and Receive**

To transmit (talk), push the Push-To-Talk (PTT) key; to receive, release the PTT key.

## **FCC Licensing Information**

### **Part 15 Compliance**

This equipment has been tested and found to comply with the limits for a Class B digital device, pursuant to part 15 of the FCC Rules. These limits are designed to provide

reasonable protection against harmful interference in a residential installation. This equipment generates, uses and can radiate radio frequency energy and, if not installed and used in accordance with the instructions, may cause harmful interference to radio communications. However, there is no guarantee that interference will not occur in a particular installation. If this equipment does cause harmful interference to radio or television reception, which can be determined by turning the equipment off and on, the user is encouraged to try to correct the interference by one or more of the following measures:

- \* Reorient or relocate the receiving antenna.
- \* Increase the separation between the equipment and receiver.
- \* Connect the equipment into an outlet on a circuit different from that to which the receiver is connected.
- \* Consult the dealer or an experienced radio/TV technician for help.

#### **FCC Licensing Requirements**

A license from Federal Communications Commission is required prior to use. Your dealer will program each radio with your authorized frequencies, signaling codes, etc., and will be there to meet your communications needs as your system expands. Contact your dealer for more information.

#### **EU Regulatory Conformance**

Hereby, Hytera Communications Corporation Ltd., declares that this device is in compliance with the essential requirements and other relevant provisions of Directive 1999/95/EC.

**CE 0678** 



Note: The above information is applicable to EU countries only.

# Contents

Checking Items in the Package .....	5
Repeater Overview .....	6
Front Panel .....	6
Rear Panel.....	7
Internal Parts .....	8
Installation.....	8
Installation Overview .....	9
Before Installation.....	9
Installation Requirements .....	10
Installation Steps .....	12
Electrical Connections .....	15
Power Supply Connections .....	15
RF Antenna Connections .....	16
Post-Installation Checklist.....	17
Status Indications.....	18
LCD Icons.....	18
LED Indicator.....	18
Basic Operations .....	19
Turning the Repeater On/Off.....	19
Adjusting the Volume.....	19
Adjusting Power Level.....	20
Backlight .....	20
Locking/Unlocking the Front Panel .....	20
Menu Navigation .....	21
Radio Info .....	21
Channel Info .....	22
Exit.....	22
Alarm Information .....	22
Over Temperature Alarm .....	23
Fan Failure Alarm .....	23
VSWR Alarm.....	24
Low Forward Power Alarm .....	25
Over/Low Voltage Alarm .....	25
Troubleshooting .....	27
Care and Cleaning.....	28
Optional Accessories .....	29

# Checking Items in the Package

Please unpack carefully and check that all items listed below are received. If any item is missing or damaged, please contact your dealer.

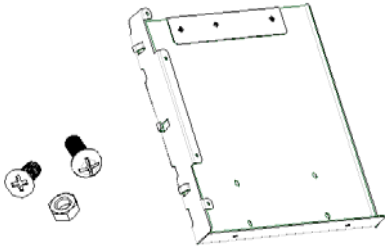

Duplexer Bracket & Screws

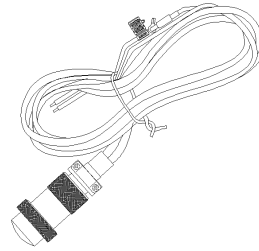

Power Cord

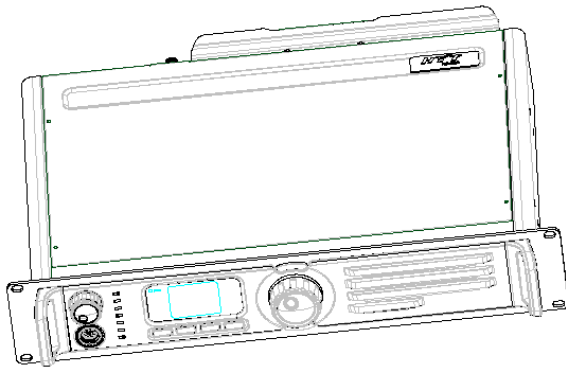

Repeater

Owner's Manual

# Repeater Overview

## Front Panel

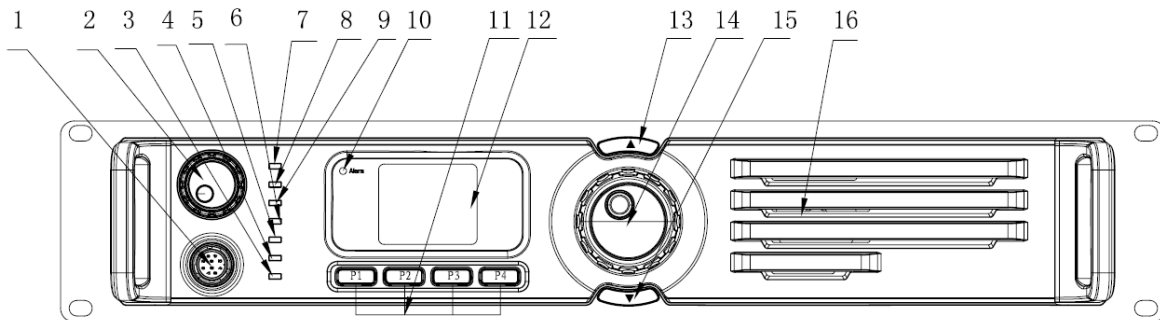

No.	Part Name	No.	Part Name
①	Accessory Jack	②	Volume Control Knob / Power Indicator
③	Repeater Mode Indicator	④	Analog Mode Indicator
⑤	Slot 2 RX Indicator	⑥	Slot 2 TX Indicator
⑦	Digital Mode Indicator	⑧	Slot 1 TX Indicator
⑨	Slot 1 RX Indicator	⑩	Alarm Indicator
⑪	Programmable Keys *	⑫	LCD Display
⑬	Channel Up Key *	⑭	Menu Navigation Knob
⑮	Channel Down Key *	⑯	Speaker

## Rear Panel

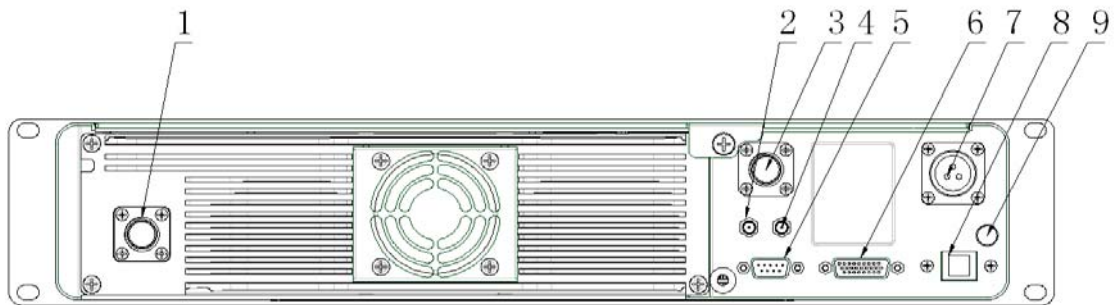

No.	Part Name	No.	Part Name
①	TX Antenna Connector	②	Optional Connector 1
③	RX/Duplex Antenna Connector	④	Optional Connector 2
⑤	Monitor/Test Jack	⑥	Accessory Jack
⑦	DC Power Inlet	⑧	Ethernet Port *
⑨	Ground Screw		



# Internal Parts

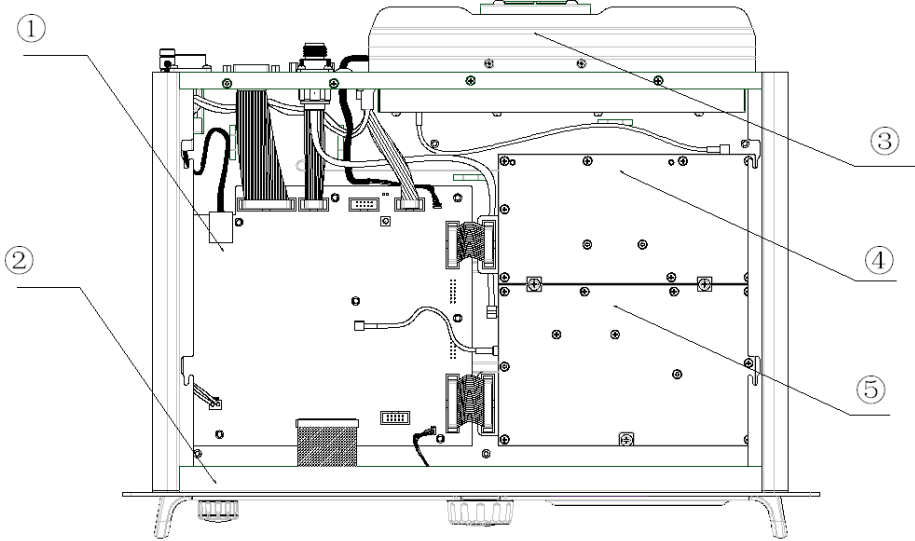

No.	Part Name	No.	Part Name
①	Baseband Module	②	Front Panel
③	RF PA Module	④	Excitor Module
⑤	RX Module		

# Installation

Proper installation can ensure optimum performance and reliability of the repeater. Be sure to read the following installation requirements and instructions carefully, before you install the repeater.

## Installation Overview

The information below is an overview for installing the repeater and auxiliary equipment.

- Unpack and inspect the equipment.
- Perform a pre-installation function check test of the equipment, and configure parameters.
- Pay particular attention to environmental conditions at the site, ventilation requirements, and grounding and lightning protection.
- Install the equipment at the site.
- Make necessary electrical and cabling connections, including the following:
  - DC power cord
  - Coaxial cables to TX and RX antennas (if you use two antennas)
- Perform a post-installation function check test of the equipment, to verify proper installation.

## Before Installation

Before you install the repeater at the site, you are suggested to power on the repeater and check it for proper operation.

### 1. Applying Power

Before applying power to the repeater, make sure the voltage of DC power supply or battery is compliant with the operating voltage range of the repeater. Then connect the DC power supply or battery to supply power to the repeater.

### 2. Verifying Proper Operation

Operation of the repeater can be indicated by the 8 LEDs located on the front panel. After proper operation is verified, you can configure parameters for the repeater.



Caution: Some repeater components can become extremely hot during operation. Turn off all power to and wait until the repeater is sufficiently cool before touching the repeater.

### 3. Configuring Parameters

You may customize repeater parameters such as TX/RX frequency, TX power and signalling, according to user needs. After configuration of parameters is complete, you may perform site installation.

## Installation Requirements

### 1. Environmental Conditions at Intended Installation Site

The repeater may be installed in any location suitable for electronic communication equipment, provided that the environmental conditions do not exceed the equipment specifications for temperature, humidity and air quality.

- Operating Temperature

-30°C to +60°C

This is the temperature measured in close proximity to the repeater. For example, if the repeater is mounted in a cabinet, the temperature within the cabinet is measured.

- Humidity

Humidity conditions should not exceed 95% relative humidity @ 50°C.

- Air Quality

For equipment operating in an area which is environmentally controlled and with the repeater rack mounted, the airborne particle level must not exceed 25µg/m<sup>3</sup>.

And for equipment operating in an area which is not environmentally controlled and with the repeater cabinet mounted, the airborne particle level must not exceed 90µg/m<sup>3</sup>.



Caution: If the repeater is to be installed in an area which is usually dusty, dirty, or does not meet the air quality requirements, then the air used to cool the repeater modules must be treated using appropriate filtering devices. Dust or dirt accumulated on the internal circuit boards and modules is not easily removed, and can cause malfunctions such as overheating and intermittent electrical connections.

### 2. Equipment Ventilation

The PA heatsink is equipped with a cooling fan used to provide forced convection cooling.

When planning the installation, observe the following ventilation guidelines:

- Customer supplied cabinets must be equipped with ventilation slots or openings for

air to enter and exit. If several repeaters are installed in a single cabinet, ensure ventilation openings surrounding each repeater allow for adequate cooling.

- All cabinets must have at least 10cm of open space between the air vents and any wall or other objects.
- When multiple cabinets (each equipped with several repeaters) are installed in an enclosed area, ensure appropriate ventilation and consider air conditioning or other climate control equipment, to satisfy the temperature requirements stated above.

### **3. Equipment Installation Methods**

The RD980 repeater may be mounted in a rack, bracket or cabinet, and may be placed on your desk.

### **4. Site Grounding and Lighting Protection**



Caution: Proper site grounding and lightning protection are vitally important considerations. Failure to provide proper lightning protection may result in permanent damage to the repeater.

The ground and lightning protection system is one of the most important considerations when designing a communication site. Proper grounding techniques and lightning protection are closely related, and the general category of site grounding may be divided into the following two sections:

#### **■ Electrical Ground**

Ground wires carrying electrical current from circuitry or equipment at the site are included in the category of electrical ground. Examples include the AC and DC power used to source equipment located at the site, and wires or cables connected to alarms or sensors located at the site.

#### **■ Lightning Ground**

Providing adequate lightning protection is critical to a safe reliable communication site. The repeater is equipped with a ground screw located on the rear panel. This screw is used to connect the repeater to the site grounding. All antenna cables, and AC and DC power cords, should be properly grounded and lightning protected by following the rules and guidelines provided in the above sections.

## Installation Steps

You will need a Philips screwdriver (cross head screwdriver), a Torx (T10) screwdriver and a spanner, to install the repeater.



Caution: Be sure to observe proper electrostatic discharge precautions if any part must be removed from the repeater.

The installation steps are as follows:

1. Mount the repeater in a rack, bracket or cabinet.
2. Connect accessories such as antenna cables and power cords to the repeater.

### If a duplexer needs to be mounted

If the repeater needs to work with a duplexer, you will need to implement the following installation steps prior to the above steps 1 and 2.

1. Loosen the three screws on the bracket with a Philips screwdriver.

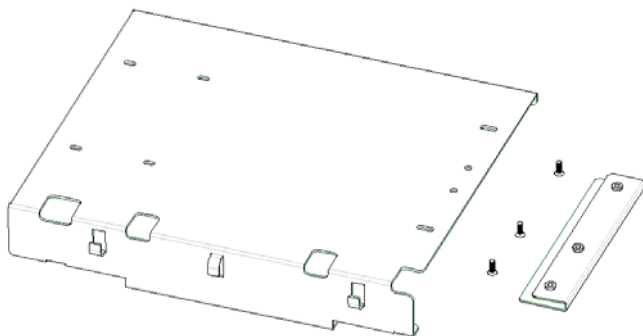

2. Install the optional duplexer and the bracket. Be sure to observe the specifications of the two antenna connectors on the duplexer, to determine which connector should be connected to the transmitter. Ensure the antenna connector connected to the transmitter is beside the rear panel of the repeater.

Take Hytera supplied duplexer as an example. If the transmitter is connected to the low cavity connector, the duplexer should be mounted with the front side facing upwards (see the following figure on the left); and if it is connected to the high cavity connector, the duplexer should be mounted with the front side facing downwards (see the following figure on the right).

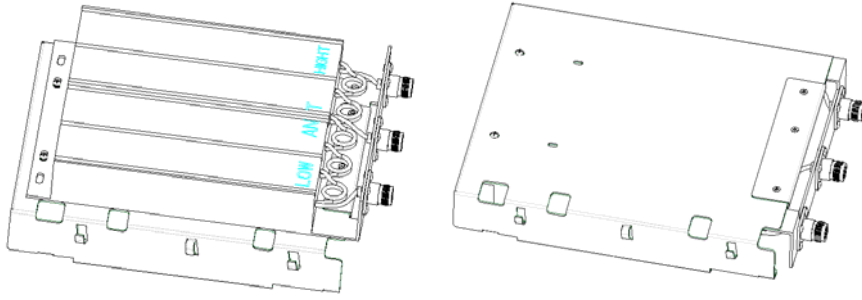

3. Loosen the screw at the back of the top cover, and then pull the top cover to remove it.

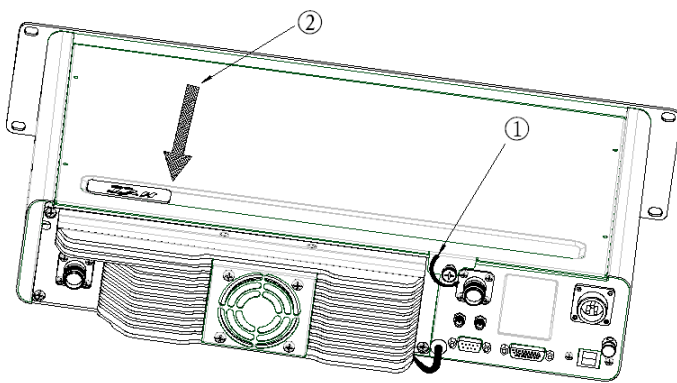

4. Loosen the 6 screws locking the PA heatsink, remove all power, data and RF cables from the PA, and finally remove the PA heatsink.

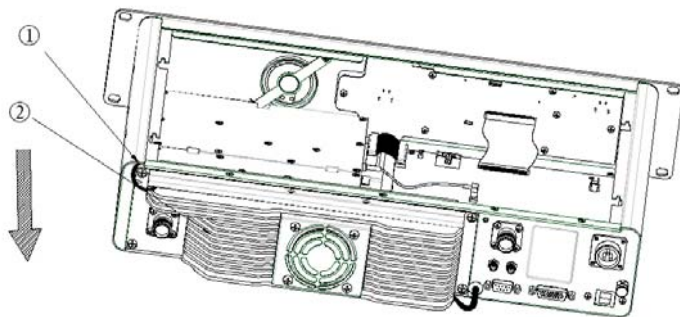

批注 [Iris1]: 优化箭头方向

5. Mount the duplexer, and fasten the 2 screws inside the housing and on the side panel respectively. Then mount the PA heatsink, and connect all the lines and cables.



Ensure RF cables are properly connected between the duplexer and RF connectors.

TX signal:

Excitor module -> PA module -> Duplexer TX connector -> Duplexer antenna connector ->

RX/duplex antenna connector (rear panel)

RX signal:

RX/duplex antenna connector (rear panel) -> Duplexer antenna connector -> Duplexer RX

connector -> RX module

### Diagrams of Assembled Unit

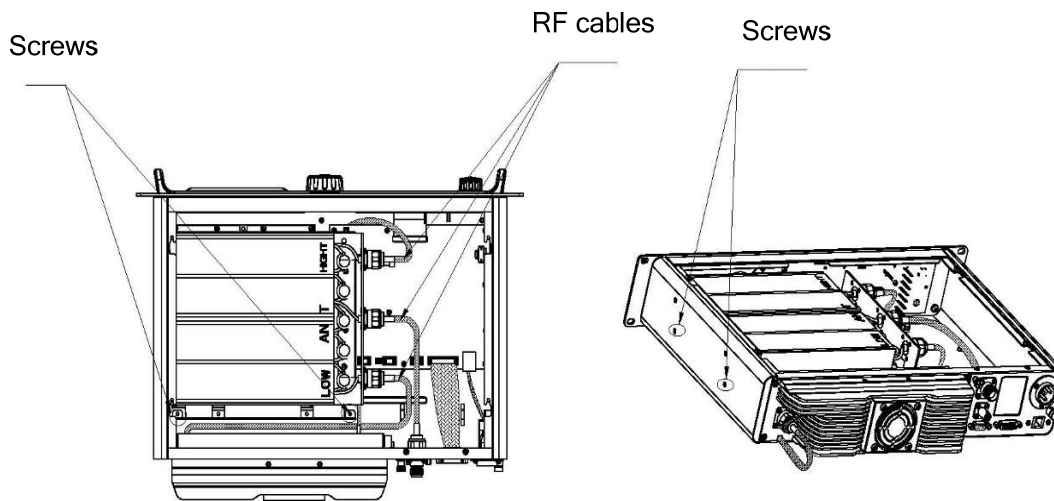

Duplexer Mounted with Front Side Facing Upwards

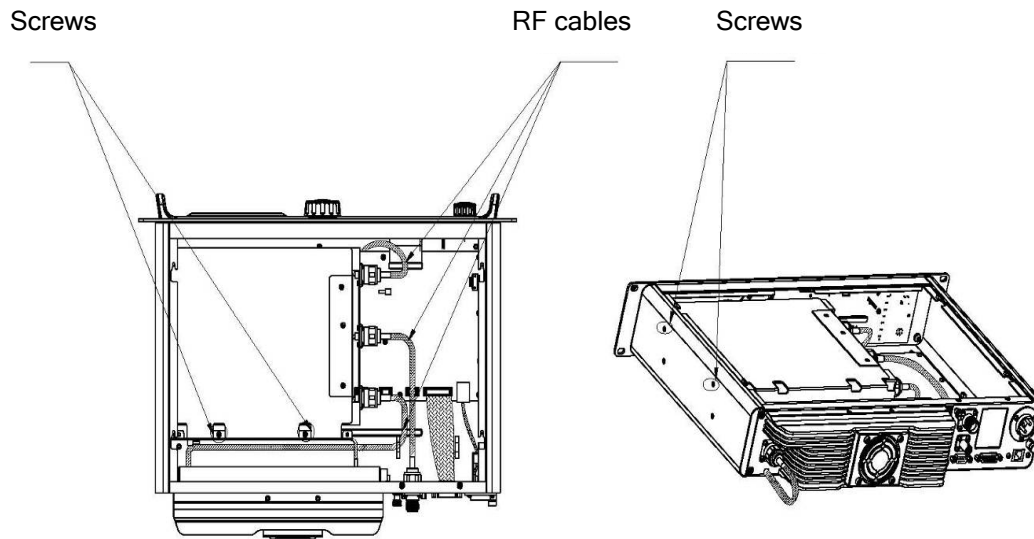

Duplexer Mounted with Front Side Facing Downwards

## Electrical Connections

After the repeater has been mechanically installed, electrical connections must be made.

This involves making the following connections:

- DC power cord
- Antenna cables

See the rear panel view for the positions of connectors.

### Power Supply Connections

#### 1. Ground Connection

The repeater is equipped with a ground screw located on the rear panel. Connect ground wires to the screw.

#### 2. DC Power Supply or Battery Backup Connection



The repeater may be connected to a regulated DC power supply or a backup battery.

The DC source or battery backup system is connected to the repeater through the DC power inlet at the rear of the repeater (see rear panel view).



Caution: Before you make the connection, ensure the DC power supply or battery backup system is capable of supplying a minimum of 200W. and check if the DC power supply has current limit. Since high current consumption is required for transmitting, improper setting of the current limit may cause transmission failure.



Caution: The repeater is to be connected to a battery that is in accordance with applicable electrical regulations for the end use country. If battery power is exhausted, you are recommended to charge the battery with an external charger. Remove the battery from the repeater when charging.

## RF Antenna Connections

TX and RX antennas are connected to two separate connectors (shown in the rear panel view), and there must be adequate isolation of 75 dB UHF or 85 dB VHF between them. If only one antenna through a duplexer is connected, at least 75 dB UHF or 85 dB VHF isolation between the TX and RX antenna ports is required.



Caution: Please ensure that all power is switched off before disconnecting the TX antenna.

### 1. Duplexer Selection

The selection of duplexer is critical to system performance. The use of a notch (band reject) duplexer is possible in some systems that are not located at high RF density sites. If the repeater is used in high RF density sites, the use of a pass-notch duplexer is recommended.

The duplexer must be able to handle at least 50W continuously. For the best system performance, the insertion loss should be less than 2dB.

## 2. Antenna Selection

The selection of antenna is also critical to system performance. The selected antenna must be 50 Ohm impedance and capable of at least 50W. High gain antennas may be used to increase system coverage. Please take note of licensing restrictions when selecting high gain antennas. Some services or regions may have antenna gain or system radiation limitations.

The antenna must be connected to the duplexer with a high grade 50 Ohm transmission line (e.g. Andrew HELIAX cables). The line must have connectors to match the connectors on the duplexer and antenna.



Caution: It is important that all antenna cables are grounded at the point they enter the building. All aspects of the antenna design must comply with the relevant local regulations.

# Post-Installation Checklist

After the repeater has been mechanically installed and all electrical connections have been made, power may now be applied and the repeater should be checked for proper operation.

## 1. Applying Power

Before applying power to the repeater, make sure all boards are securely seated in the appropriate connectors on the rear panel and all RF cables are securely connected.

Turn on the DC power source to supply power to the repeater.

## 2. Verifying Proper Operation

Operation of the repeater can be indicated by the 8 LEDs located on the front panel and also by LCD prompts.



Caution: Some repeater components can become extremely hot during operation. Turn off all power to and wait until the repeater is sufficiently cool before touching the repeater.

# Status Indications

## LCD Icons

The LCD of your repeater displays the repeater status and menu items. The following are the icons that appear on the display.

### ■ Standby Screen

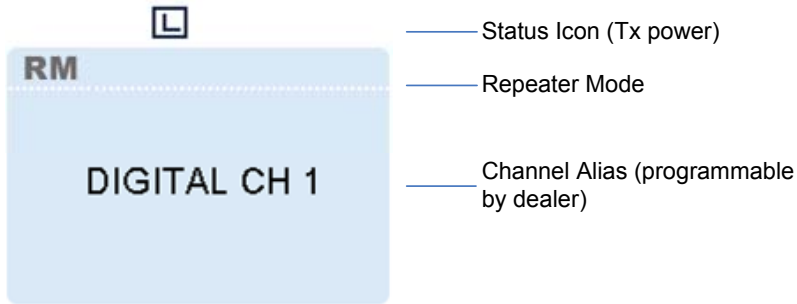

### ■ Status Icons

Icon Name	Icon	Repeater Status
Transmit Power Icons		Low TX power for the current channel
		High TX power for the current channel

## LED Indicator

LED Indicator	Repeater Status
Power Indicator glows green	Repeater being turned on
Alarm Indicator glows red	Repeater giving an alarm due to failure of some component (please observe the LCD prompt, and carry out troubleshooting as the "Alarm Information" section instructed.)
Repeater Mode Indicator glows green	Repeater operating in Repeater Mode (RM)
Repeater Mode Indicator is not lit	Repeater operating in Repeater Base Mode

	(RBM)
Slot 1 TX Indicator glows red	Repeater transmitting (analog) / repeater transmitting on slot 1 (digital)
Slot 1 TX Indicator flashes red	Busy channel lockout * / transmission time-out *
Slot 2 TX Indicator glows red	Repeater transmitting on slot 2 (digital)
Slot 2 TX Indicator flashes red	Busy channel lockout * / transmission time-out *
Slot 1 RX Indicator glows green	Repeater receiving (analog) / repeater receiving on slot 1 (digital)
Slot 1 RX Indicator flashes green	Monitoring *
Slot 2 RX Indicator glows green	Repeater receiving on slot 2 (digital)
Analog Mode Indicator glows yellow	Repeater operating in analog mode
Digital Mode Indicator glows blue	Repeater operating in digital mode

## Basic Operations

### Turning the Repeater On/Off

Connect the repeater to a DC source to turn the repeater on. At this time, the Power Indicator glows green and the repeater shows the power-up screen.

To turn the repeater off, disconnect it from the DC source.

### Adjusting the Volume



When the repeater operates in analog mode, rotate the **Volume Control** knob clockwise to increase the volume of speaker output audio, or counter-clockwise to decrease the volume.

When the repeater operates in digital mode, the speaker cannot output audio, and no

volume adjustment through the knob is available.

## Adjusting Power Level

You may request your dealer to set the TX power to high or low.

The LCD displays icon  for high power, and icon  for low power. High power can optimize coverage of the repeater, to communicate with farther terminals.

## Backlight

In insufficient light conditions, activating the backlight can illuminate the LCD and all the front panel keys, facilitating user operation.

You dealer may set the backlight to operate in any of the following modes:

- **Timed:** any key or knob operation or receiving/transmitting of signals can illuminate the backlight. If none of the above operations is made within the specified time period, the backlight will go out automatically.
- **Enable:** Since the repeater is powered on, the backlight will remain illuminated all the time.
- **Disable:** The backlight will always remain disabled.



Note: When an alarm indication occurs, the backlight will remain illuminated until the alarm disappears. Then it will recover the initial operation mode.

## Locking/Unlocking the Front Panel

Your dealer may lock all the front panel keys and knobs, to prevent accidental operation.



Note: To unlock the front panel, the repeater must be re-programmed by your dealer.

# Menu Navigation

## Main Menu

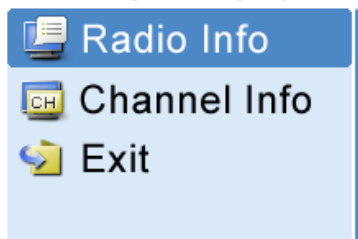

## Radio Info

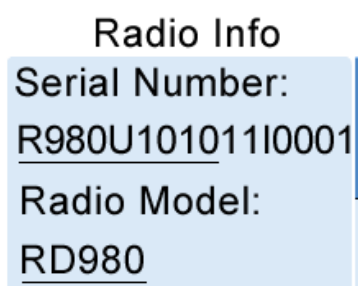

Under this menu, you can view the basic information of your repeater, including serial number, radio model, frequency range, firmware version and etc.

To access this menu:

1. In the home screen, press the **Menu Navigation** knob to enter the main menu.
2. Rotate the knob to select the "Radio Info" option.
3. Press the knob again to view basic information of the repeater.

Then you may rotate the knob to scroll up/down. To exit, just press the knob.

## Channel Info

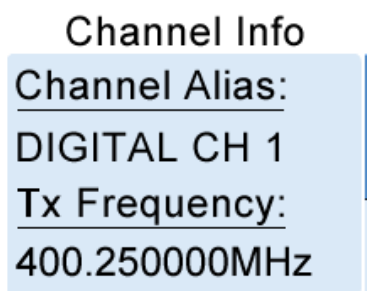

Under this menu, you can view some information of the current channel, including channel alias, TX/RX frequency, channel spacing (analog only), TX/RX CTCSS/CDCSS (analog only), color code (digital only) and etc.

To access this menu:

1. In the home screen, press the **Menu Navigation** knob to enter the main menu.
2. Rotate the knob to select the "Channel Info" option.
3. Press the knob again to view information of the current channel.

Then you may rotate the knob to scroll up/down. To exit, just press the knob.

## Exit

To exit from the main menu, rotate the **Menu Navigation** knob to select the "Exit" option, and then press the knob.

## Alarm Information

The repeater can automatically detect its operation status in real time, such as PA over-temperature, low forward power, high VSWR, high/low voltage and fan failure. When any of the above occurs, the LCD will give you a prompt, and the Alarm Indicator will glow red.

## Over Temperature Alarm

When temperature of the PA module exceeds the normal range, the Alarm Indicator will glow red and the LCD will display the prompt below:



Then the repeater will disallow transmission, and you will need to:

1. Check if the surface temperature of PA heatsink exceeds 80°C. If yes, implement the following steps 2 and 3 to locate the failure.



Caution: The PA heatsink can become extremely hot at this moment, so DO NOT touch the repeater. Use a digital thermometer with thermocouple to measure temperature.

2. Check if ambient temperature and equipment ventilation can satisfy the foregoing site installation requirements. If not, please improve environmental conditions at the site as soon as possible, by mounting air conditioning equipment or improving equipment ventilation.
3. Check if connection between the transmitter and RF or antenna cables is loose or lost. If yes, please secure the connection or replace the cables. Poor connection between them could result in very high TX power and thus high temperature of PA heatsink.
4. If you are unable to verify the above conditions, please contact your local dealer for technical support.

When temperature of the repeater drops into the normal operating range, the LCD prompt will disappear, and the Alarm Indicator will go out.

## Fan Failure Alarm

When the fan fails to work, the Alarm Indicator will glow red and the LCD will display the



prompt below:

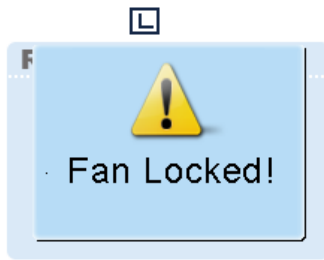

Then the repeater will automatically switch to low TX power, to protect the transmitter from overheating.

You will need to:

1. Check if the fan is blocked by any solid object. If yes, please remove it.
2. If you cannot solve the issue, please contact your local dealer for technical support.

When the fan recovers normal operation, the LCD prompt will disappear, and the Alarm Indicator will go out.

## VSWR Alarm

High VSWR (voltage standing wave ratio) at the TX antenna connector will result in damage to the PA, and even failure of the transmitter.

When the VSWR exceeds the normal range, the Alarm Indicator will glow red and the LCD will display the prompt below:



Then the repeater will automatically switch to low TX power.

You will need to:

1. Check if the TX frequency is within the frequency range of the antenna. If not, please contact your local dealer to replace the antenna. Improper antenna selection could

result in poor transmitting performance, and even damage to the transmitter.

2. Check if connection between the transmitter and RF or antenna cables is loose or lost.

If yes, please secure the connection or replace the cables.

3. If you cannot solve the issue, please contact your local dealer for technical support.

When the VSWR falls within the normal range, the LCD prompt will disappear, and the Alarm Indicator will go out.

## Low Forward Power Alarm

When the forward power is below the preset value, the Alarm Indicator will glow red and the LCD will display the prompt below:



Then the repeater may continue transmission or may terminate it, subject to repeater status currently detected.

You will need to:

1. Check if connection between the transmitter and RF or antenna cables is loose or lost.

If yes, please secure the connection or replace the cables.

2. If you cannot solve the issue, please contact your local dealer for technical support.

When the forward power is recovered to its normal value, the LCD prompt will disappear, and the Alarm Indicator will go out.

## Over/Low Voltage Alarm

When voltage is over or below the normal operating range (11V-15.6V) of the repeater, the Alarm Indicator will glow red and the LCD will display the prompt below:

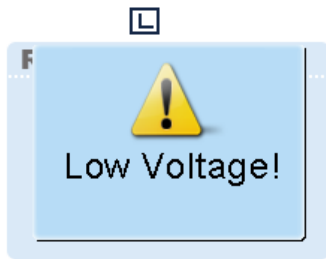

Low Voltage Alarm

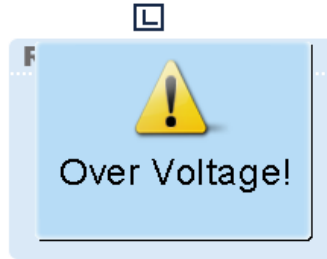

Over Voltage Alarm

Then the repeater will automatically shut off, but the LCD prompt will remain.

You will need to:

1. Use a voltmeter to check if the input voltage of DC power supply is normal, especially if the voltage will run below the normal range while transmitting. If yes, please replace the DC power supply or backup battery.
2. Check if connection between the repeater and the DC power cord is loose or lost. If yes, please secure the connection or replace the cable.
3. If you cannot solve the issue, please contact your local dealer for technical support.



Caution: If low voltage is detected when the repeater is powered by backup battery, you need to charge the battery with an external charger. Remove the battery from the repeater when charging.

When voltage falls within the normal range, the LCD prompt will disappear, and the Alarm Indicator will go out.

# Troubleshooting

Phenomena	Analysis	Solution
The repeater cannot be powered on.	<ul style="list-style-type: none"> <li>a. Power cord is not connected or is not securely connected to the outlet.</li> <li>b. Power cord fuse is damaged.</li> </ul>	<ul style="list-style-type: none"> <li>a. Properly connect the power cord and ensure secure connection.</li> <li>b. Check if the DC fuse has blown, and if yes, replace it with a new one.</li> </ul>
Group members cannot talk to each other, or the repeater cannot communicate with a subscriber radio.	<ul style="list-style-type: none"> <li>a. TX/RX frequency of the repeater is inconsistent with that of portable/mobile terminals.</li> <li>b. Failed to repeat useful signal due to strong interference signal.</li> <li>c. The group member is out of the coverage of the repeater.</li> </ul>	<ul style="list-style-type: none"> <li>a. Re-set frequencies.</li> <li>b. If you cannot remove or bypass the interference source, change to operate on other frequencies.</li> <li>c. Go within the coverage of the repeater.</li> </ul>
Group members cannot talk to each other, even though RX indication is given.	<ul style="list-style-type: none"> <li>a. Your ID is inconsistent with that of other group members.</li> <li>b. Inconsistent CTCSS/CDCSS.</li> </ul>	<ul style="list-style-type: none"> <li>a. Set your ID to the same as that of other members.</li> <li>b. Re-set CTCSS/CDCSS.</li> </ul>
Short communication range or poor audio	<ul style="list-style-type: none"> <li>a. Leakage of signal energy due to damaged connection cable.</li> <li>b. Loose connection between antenna connector and the cable, or loss of connection</li> <li>c. Invisible damage of cable.</li> <li>d. Duplexer is not properly set (if duplexer is mounted).</li> </ul>	<ul style="list-style-type: none"> <li>a. Replace the cable with a new one if necessary.</li> <li>b. Secure the connection or replace cable plug with a new one if necessary.</li> <li>c. Replace the cable with a new one.</li> <li>d. Contact the manufacturer or your dealer to re-set the duplexer.</li> </ul>

If the above solutions can not fix your problems, or you may have some other queries, please contact us or your local dealer for more technical support.

## Care and Cleaning

To guarantee optimal performance as well as a long service life of your repeater, please follow the tips below.

### Repeater Care

- Keep the repeater at a place of good ventilation and heat dissipation to facilitate normal work.
- Do not place irrelevant articles on top of the repeater to ensure optimal heat dissipation.
- Do not place the repeater in corrosive agents, solutions or water.







### Repeater Cleaning

- Clean up the dust and fine particles on the repeater parts with a clean and dry lint-free cloth or a brush regularly.
- Use a non-woven cloth with neutral cleanser to clean the keys, control knobs, LCD and jacks after long-time use. Do not use chemical preparations such as stain removers, alcohol, sprays or oil preparations. Make sure the repeater is completely dry before use.

**Caution:** Power off the repeater before cleaning.

# Optional Accessories

The following items are the main optional accessories for the repeater, and please consult your local dealer for more other accessories.

			
<p>Palm Microphone SM16A1 *</p>	<p>Desktop Microphone SM10A1 *</p>	<p>External Power Supply (320W, backup battery applicable) PS22002</p>	<p>Programming Cable (USB Port) PC37</p>
			
<p>Omni-directional Antenna</p>	<p>Directional Antenna</p>		



Note: Use the accessories specified by Hytera only. If not, Hytera shall not be liable for any losses or damages arising out of use of unauthorized accessories.