

Preface

Thank you for purchasing Hytera TC-508 portable radio. With simple appearance, reliable mechanics, practical functions and stable performance, it will refresh your communication experience!

To derive optimum performance from your product, please read this manual and the supplied Safety Information Booklet carefully before use.

Instructional Icons

This radio is not intended for use by general population in an uncontrolled environment. It is only for occupational use and only applied to work-related conditions.

The radio must be only used by users, who are fully aware of the hazards of the exposure and who are able to exercise control over their RF exposure to qualify for the higher exposure limits.

The following icons are available through this manual:



Caution: indicates situations that could cause damage to your radio.



Note: indicates tips that can help you make better use of your radio.

Term Explanation

Please pay your attention to the following key terms:

Key Operation

Short press: to press a key and release it quickly.

Long press: to press and hold down a key for above 1 second.

Hold down: to press a key and remain holding it down.

User Mode

Refers to the mode entered after you turn on the radio directly.

CTCSS/CDCSS

The signaling can help you prevent unwanted conversations at the same frequency.

Copyright Information

Hytera and HYT are trademarks or registered trademarks of Hytera Communications Co., Ltd. (“Hytera”) in PRC and/or other countries or areas. Hytera retains the ownership of its trademarks and product names. All other trademarks and/or product names that may be used in this manual are properties of their respective owners.

The Hytera product described in this manual may include Hytera computer programs stored in memory or other media. Laws in PRC and/or other countries or areas protect the exclusive rights of Hytera with respect to its computer programs. The purchase of this product shall not be deemed to grant, either directly or by implication, any rights to the purchaser regarding Hytera computer programs. Any Hytera computer programs may not be copied, modified, distributed, decompiled, or reverse-engineered in any manner without the prior written consent of Hytera.

Disclaimer

Hytera endeavors to achieve the accuracy and completeness of this manual, but no warranty of accuracy or reliability is given. All the specifications and designs are subject to change without prior notice due to continuous technology development. No part of this manual may be copied, modified, translated, or distributed in any manner without the express written permission of Hytera.

If you have any suggestions or would like to learn more details, please visit our website at:

<http://www.hytera.cn>.

RF Energy Exposure Compliance

- Your radio is designed and tested to comply with a number of national and international standards and guidelines (listed below) regarding human exposure to radio frequency electromagnetic energy. This radio complies with the IEEE and ICNIRP exposure limits for occupational/controlled RF exposure environment at operating duty factors of up to 50% transmitting and is authorized by the FCC for occupational use only. In terms of measuring RF energy for compliance with the FCC exposure guidelines, your radio radiates measurable RF energy only while it is transmitting (during talking in VOX and PTT mode), not when it is receiving (listening) or in standby mode.
- The device complies with SAR and/or RF field strength limits of RSS-102 requirement and contact information where the user can obtain Canadian information on RF exposure and compliance.

Your radio complies with the following of RF energy exposure standards and guidelines

- United States Federal Communications Commission, Code of Federal Regulations; 47CFR part 2 sub-part J
- American National Standards Institute (ANSI)/Institute of Electrical and Electronic Engineers (IEEE) C95. 1-1992
- Institute of Electrical and Electronic Engineers (IEEE) C95. 1-1999 Edition
- International Commission on Non-Ionizing Radiation Protection (ICNIRP) 1998

Operational Instructions and Training Guidelines

To ensure optimal performance and compliance with the occupational/controlled environment RF energy exposure limits in the above standards and guidelines, users should transmit no more than 50% of the time and always adhere to the following procedures:

Transmit and Receive

To transmit (talk), push the Push-To-Talk (PTT) key; to receive, release the PTT key.

EU Regulatory Conformance

The equipment is in compliance with the essential requirements and other relevant provisions of the Directive 1999/5/EC.

CE 0678



Note: The above information is applicable to EU countries only.

FCC Licensing Information

Part 15 Compliance

This equipment has been tested and found to comply with the limits for a Class B digital device, pursuant to part 15 of the FCC Rules. These limits are designed to provide reasonable protection against harmful interference in a residential installation. This equipment generates, uses and can radiate radio frequency energy and, if not installed and used in accordance with the instructions, may cause harmful interference to radio communications. However, there is no guarantee that interference will not occur in a particular installation. If this equipment does cause harmful interference to radio or television reception, which can be determined by turning the equipment off and on, the user is encouraged to try to correct the interference by one or more of the following measures:

- ✚ Reorient or relocate the receiving antenna.
- ✚ Increase the separation between the equipment and receiver.
- ✚ Connect the equipment into an outlet on a circuit different from that to which the receiver is connected.
- ✚ Consult the dealer or an experienced radio/TV technician for help.

FCC Licensing Requirements

A license from Federal Communications Commission is required prior to use. Your dealer will program each radio with your authorized frequencies, signaling codes, etc., and will be there to meet your communications needs as your system expands. Contact your dealer for more information.

Contents

Checking Items in the Package	6
Product Overview	7
Product Controls	7
Programmable Keys	8
Before Use	9
Charging the Battery	9
Assembling the Accessories	10
Status Indication	12
Basic Operations	13
Turning the Radio On/Off	13
Adjusting the Volume	13
Selecting a Channel	13
Transmitting / Receiving	13
Functions and Operations	14
CTCSS/CDCSS	14
Time-out Timer (TOT)	14
Adjust Power Level	14
Monitor	14
Squelch Off	15
Scan	15
VOX	16
Battery Strength Indicator	17
Low Battery Alert	17
Channel Lock	17
Battery Save	18
Busy Channel Lockout	18
Troubleshooting	19
Care and Cleaning	21
Optional Accessories	22

Checking Items in the Package

Please unpack carefully and check that all items listed below are received. If any item is missing or damaged, please contact your dealer.



Battery



Rapid-rate Charger (for Li-Ion battery)



Power Adapter



Antenna



Belt Clip



Strap

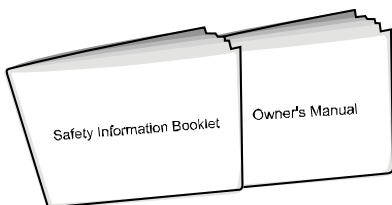

Manuals

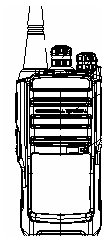

Radio



Note:

✚ The pictures above are for reference only.

Product Overview

Product Controls

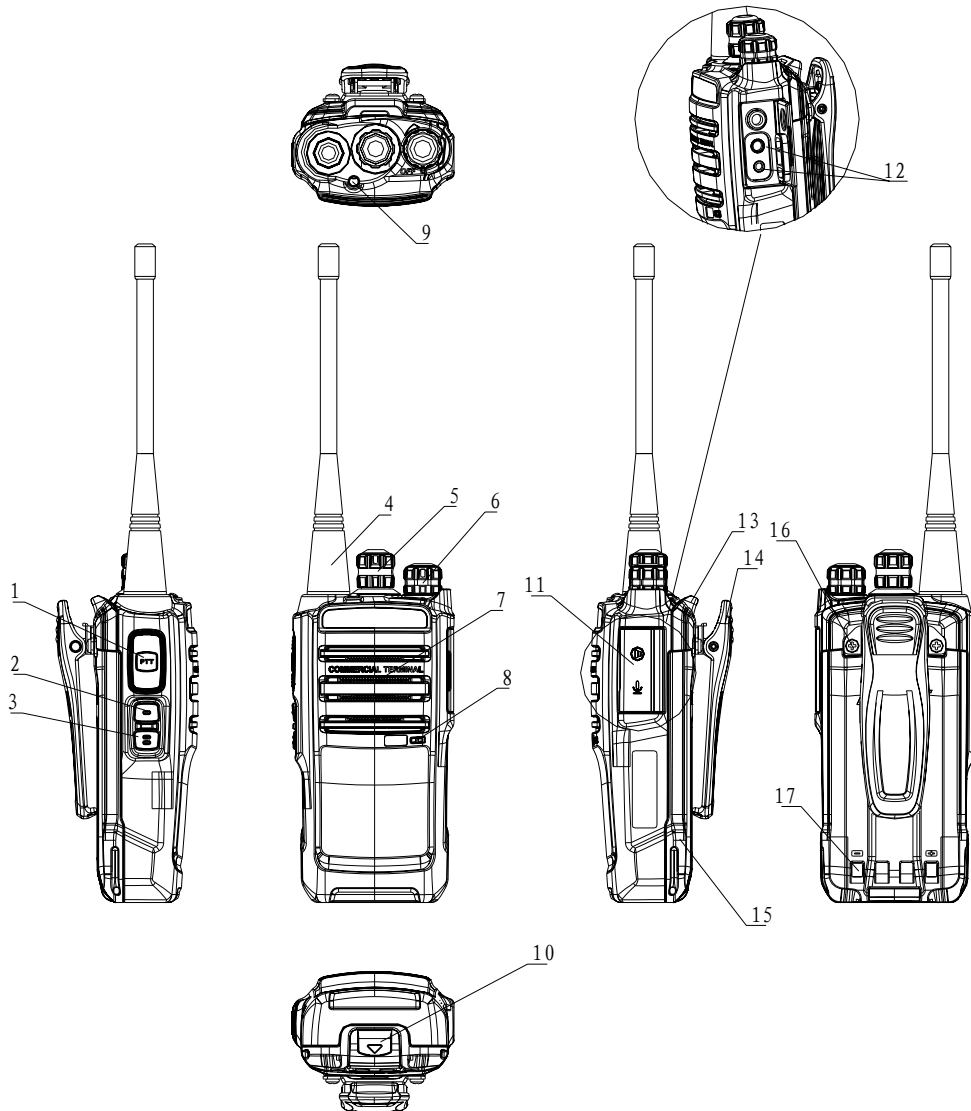

No.	Part Name	No.	Part Name	No.	Part Name
①	PTT Key	②	SK1 (programmable)	③	SK2 (programmable)
④	Antenna	⑤	Channel Selector Knob	⑥	Radio On-Off/Volume Control Knob
⑦	Speaker	⑧	Microphone	⑨	LED Indicator
⑩	Battery Latch	⑪	Accessory Jack Cover	⑫	Accessory Jack
⑬	Strap Hole	⑭	Belt Clip	⑮	Battery

⑩	Screw (Belt Clip)	⑪	Charging Piece		
---	-------------------	---	----------------	--	--

Programmable Keys

For enhanced convenience, you may request your dealer to program the keys **SK1** and **SK2** as shortcuts to the functions listed below:

No.	Shortcut Key	Function
1	Adjust Power Level	To adjust power level through one button press.
2	Monitor	To adjust the condition for incoming signal match
3	Monitor Momentary	
4	Squelch Off	To always unmute speaker no matter whether carrier is present or not
5	Squelch Off Momentary	
6	Scan	To listen to communication activities on other channels.
7	VOX	To make the radio transmit automatically when you speak.
8	Battery Strength Indicator	To indicate the battery strength
9	Channel Lock	The current channel will remain unchanged in case of rotating the Channel Selector knob accidentally.



Note: Long and short press of a key can be assigned with different functions by your dealer.

Before Use

Charging the Battery

Use only the charger and battery specified by Hytera. Charger LED can indicate the charging process.

■ Charge Diagram

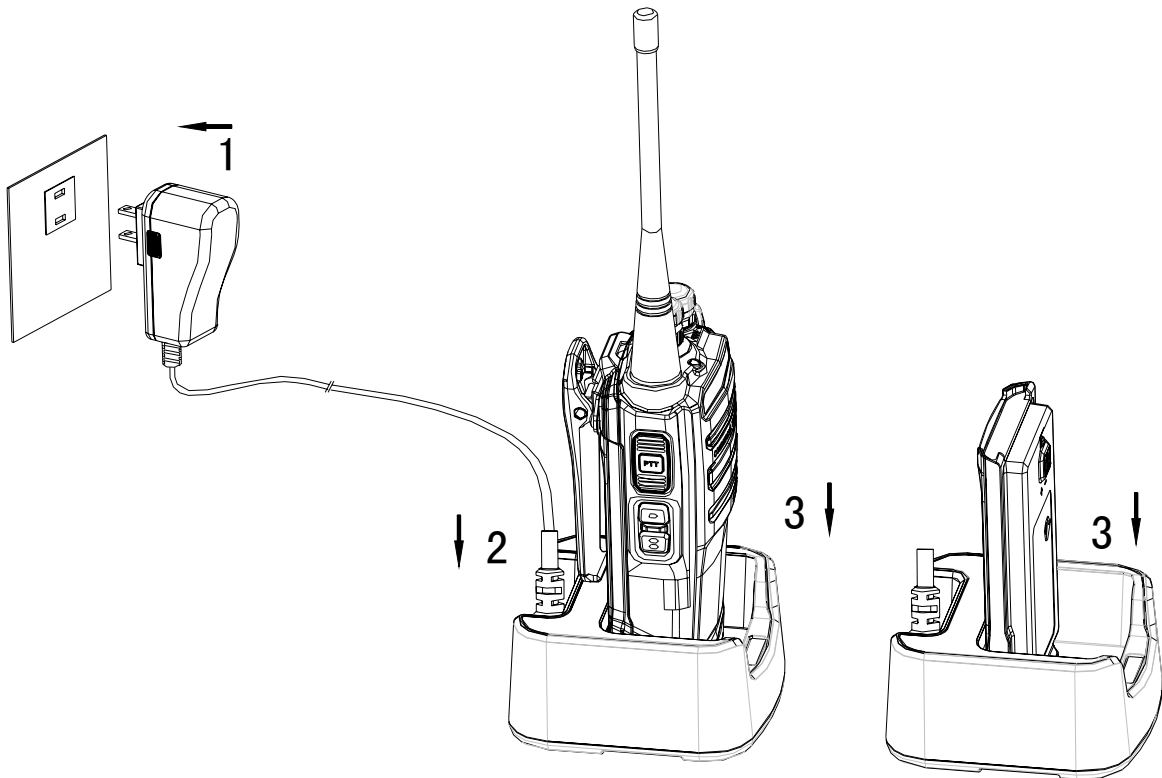

■ Procedures

1. Connect the power adapter to AC socket. See arrow 1.
2. Plug the power adapter into the rear jack of the charger. See arrow 2.
3. Place the radio with the battery attached, or the battery alone, into the charger. See arrow 3.
4. The charging process initiates when LED glows red, and is completed when LED glows green.



Note: To achieve optimal battery performance, please charge the battery for 5 hours before initial use.

Charge Indicator

LED Indicator	Charge Status
Red LED glows.	Charging
Orange LED glows.	Approximately charged completely

Green LED glows.

Fully charged

When battery power runs low, the LED will flash red, and the low-pitched tone will sound periodically. In this case, please replace or charge the battery.



Caution: Be sure to read the Safety Information Booklet, to get necessary safety information.

Assembling the Accessories

Assembling the Antenna

Turn the antenna clockwise to fasten it.

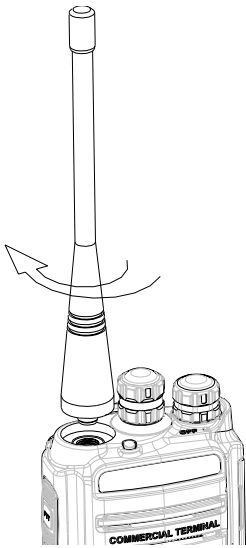

To remove the antenna, rotate it counter-clockwise.

Assembling the Battery

1. Slide the battery into the radio's slot.
2. Slightly press the bottom of the battery until a click is heard.

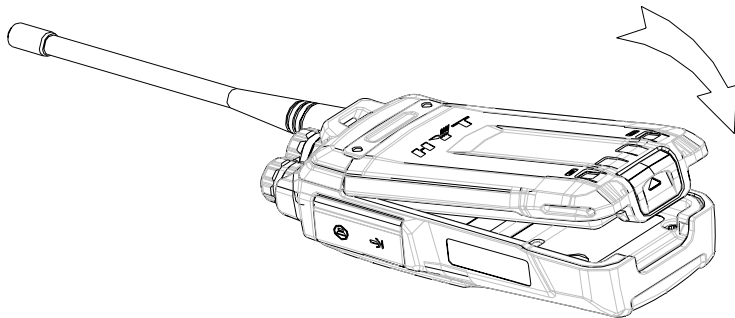

To remove the battery, turn off the radio first. Slide the battery latch upward to release the battery.

Assembling the Belt Clip

1. Remove the screws.
2. Align the screw holes on the belt clip with those on the radio's body, and then tighten the screws.

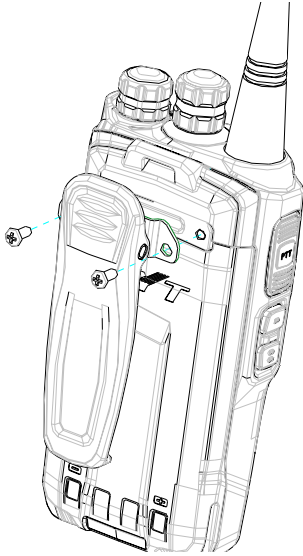

To remove the belt clip, loosen the screws.

Assembling the Audio Accessory/Programming Cable

1. Uncover the accessory jack.
2. Plug an audio accessory/programming cable into the accessory jack, and then tighten the screw.

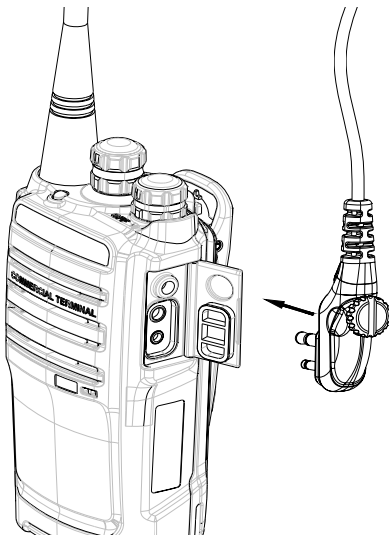

To remove the accessories, loosen the screw at first and pull out the plug.



Caution: When you are using an external accessory, waterproof performance of the radio may get affected.

Status Indication

The top LED indicator will help you easily identify the current status of your radio.

LED Indicator	Radio Status
Red LED glows.	Transmitting
Red LED flashes.	Low battery alert
Green LED glows.	Receiving
Green LED flashes.	Scanning

Basic Operations

Turning the Radio On/Off

Rotate the **Radio On-Off/Volume Control** knob clockwise/counter-clockwise until a click is heard to turn the radio on/off.

Adjusting the Volume

You may control the volume level using the **Radio On-Off/Volume Control** knob. After the radio is powered on, rotate the knob clockwise to increase the volume, or counter-clockwise to decrease the volume.

Selecting a Channel

The radio supports up to 16 channels. Rotate the **Channel Selector** knob to align your desired channel number with the white channel mark.



Note: When the radio is currently on a blank channel, it will sound beep tones continuously.



Transmitting / Receiving

To transmit audio signals, press and hold down the **PTT**, and speak into the microphone. During transmission, the LED glows red.

To receive, just release the **PTT**. When any audio signal is received, the LED glows green.



Note:

-  To ensure optimal volume of the receiving radio, hold the radio approximately 2.5 to 5 centimeters away from your mouth.
-  Communication range may get affected in rainy days or forest locations.

Functions and Operations

CTCSS/CDCSS

CDCSS/CTCSS can be used to prevent unwanted conversations at the same frequency. If CTCSS/CDCSS is set on a certain channel, you can only receive voice calls from radios with matching CTCSS/CDCSS. Otherwise you will receive voice calls from all users operating at the same frequency. You may request your dealer to program corresponding parameters on certain channels. For detailed operation method, please consult your dealer.

Time-out Timer (TOT)

The purpose of TOT is to prevent any user from occupying a channel for an extended period. When the preset time expires, the radio will automatically terminate transmission and keep beeping. To stop beeping, please release the **PTT** key. You must wait for a certain time period (preset by your dealer) to initiate another transmission.

If the pre-alert function is set by your dealer, your radio will alert you to the TOT expiration in advance.

Adjust Power Level

With this feature, you may switch power levels quickly. Generally, we recommend you to adopt low power for battery saving. However, if you cannot communicate with other radios located at a distant place with low power, please select high power.

Operation:

Press the programmed **Adjust Power Level** key to switch between high power and low power (from high power to low power: a low-pitched tone sounds; from low power to high power: a high-pitched tone sounds).

Monitor

This feature allows you to lower the conditions for incoming signal match.

Operation:

- Press the programmed **Monitor** key to activate this function (an alert tone sounds); press it again to deactivate the function (the alert tone sounds twice). Or

- Press and hold down the programmed **Monitor Momentary** key to activate this function (an alert tone sounds); release the key to exit (the alert tone sounds twice).

Squelch Off

This feature allows you to always unmute the speaker, no matter whether carrier is present or not.

Operation:

- Press the programmed **Squelch Off** key to activate this function; press the key again to deactivate it. Or
- Press and hold down the programmed **Squelch Off Momentary** key to activate this function; release the key to deactivate it.



Note: When this function is enabled on current channel, you will hear audio signals (if any); otherwise, background noise will be heard.

Scan

The feature allows you to listen to communication activities on other channels so that you can keep a close track of your team members. The scan list can be set by your dealer.

Operation:

1. To activate this function, you may
 - press the programmed **Scan** key; or
 - switch to a channel enabled with the auto scan feature (programmed by your dealer).





Note: The radio will not start scan if there are less than two channels in the scan list.

2. After the feature is enabled, your radio will scan according to the scan list set for the channel on which scanning starts. The scanning process is as follows:
 - The LED flashes green during scanning.
 - When communication activities are detected on a channel, the radio will stay on the channel to receive current activities. Meanwhile, the LED glows green.
 - If the Talk Back feature is enabled by your dealer, press and hold down the **PTT** to reply when the radio stays on a certain channel.
 - You can scan the frequently used channel if the priority scan feature is enabled. When scan stays on a non-priority channel, the radio will keep detecting activities on the priority channel.

Once any activity is detected, it will jump to the priority channel. For more information, please consult your dealer.

3. To exit the scanning process, you may
 - press the **Scan** key again, or
 - switch to a channel where the auto scan feature is disabled; or
 - turn the radio off.

**Note:**

-  The Scan Start Alert tone and the Scan End Alert tone can be enabled / disabled by the dealer.
-  During scanning, the following function keys (if programmed) are available: **PTT**, **Squelch Off**, **Squelch Off Momentary**, **Monitor** and **Monitor Momentary**.



VOX

This feature allows you to transmit your voice with no need to press the **PTT**. However, you must employ a dedicated earpiece to realize this function.

Operation:

1. Set the **PTT/VOX Switch** on the earpiece to VOX;
2. Plug the earpiece into the accessory jack;
3. Press the programmed **VOX** key to activate this function.
4. Speak into the microphone (on the earpiece) to transmit your voice, and transmission will stop automatically when you stop talking;
5. Power the radio off or press the **VOX** key again to deactivate this function.

**Note:**

-  If the **PTT/VOX Switch** on the earpiece is set to PTT, you can only transmit by pressing the external **PTT**, no matter whether VOX is activated.
-  When the **PTT/VOX Switch** is set to PTT, you are not allowed to switch it from PTT to VOX directly; otherwise, continuous transmission may occur. If continuous transmission occurs unexpectedly, you can restore the radio to normal operation by toggling the switch from VOX to PTT, or turning the radio off and back on.
-  You can select an appropriate VOX sensitivity according to the environment. If VOX is activated under heavy noise, continuously transmission may occur.

Battery Strength Indicator

This feature allows you to know the current battery strength.

Operation:

Press and hold down the programmed **Battery Strength Indicator** key, and the LED glows to indicate remaining battery strength by different colors. Release the key to exit. The following table lists different colors representing different battery strength levels

LED Indicator	Battery Strength
Green LED glows.	High
Orange LED glows.	Medium
Red LED glows.	Low

Low Battery Alert

This feature allows you to know the low battery status. When battery power runs low, the LED will flash red, and the low-pitched tone will sound periodically. In this case, please replace or charge the battery.



Note: When the battery strength is insufficient, the programmed **Battery Strength Indicator** key will become unavailable; when the battery strength is drained, transmission will be prohibited; if you press **PTT** in such situations, the radio will sound an alert to warn you.

Channel Lock

This feature can avoid unexpected channel change due to rotation of **Channel Selector** knob accidentally.

Operation:

Press the programmed **Channel Lock** key to enable the feature (an alert tone sounds); press the key again to deactivate it (the alert tone sounds twice). When this function is activated, the radio will stay on the current operating channel even if you rotate the **Channel Selector** knob.



Note: This function will be deactivated if the radio is powered off and back on, or it is programmed.

Battery Save

In Standby mode, when no signal is received / transmitted or no operation (key press) is performed for 10 seconds (programmable), the radio will automatically enter **Battery Save** mode to reduce power consumption. The radio may exit the **Battery Save** mode and get activated as soon as any key is pressed or any signal is received.

Busy Channel Lockout

If enabled via the programming software, this feature can prevent your radio interfering with other transmitting radios on the same channel. When the channel is already in use, the radio will keep beeping and return to RX mode upon pressing the **PTT** key. To stop beeping, please release the **PTT** key.

Troubleshooting

Phenomena	Analysis	Solution
The radio can not be powered on.	The battery may be improperly installed.	Remove the battery and attach it again.
	The battery may run out.	Recharge or replace the battery.
	The battery may suffer from poor contact caused by dirtied or damaged battery contacts.	Clean the battery contacts. If the problem can not be solved, contact your dealer or our authorized service center for inspection and repair.
During receiving signals, the voice is weak, discontinuous or totally inactive.	The battery strength may be too low.	Recharge or replace the battery.
	The volume may be set to a low level.	Increase the volume by rotating the Volume Control knob clockwise.
	The antenna may get loose or may be improperly installed.	Power off the radio, re-install the antenna and power on the radio again.
	The speaker may be blocked or damaged.	Clean surface of the speaker. If the problem can not be solved, contact your dealer or our authorized service center for inspection and repair.
You can not communicate with other members.	The frequency or signaling may be inconsistent with that of other members.	Set your TX/RX frequency and signaling to the same as that of other members.
	The Channel Lock feature is enabled unexpectedly and you operate on an undesired channel.	Exit the Channel Lock mode and switch to the desired channel.
	You may be too far away from the group members.	Move towards other members. And make sure that you are within the communication range.
Irrelevant communication activities or noises are heard on the channel.	You may be interrupted by radios using the same frequency.	Change the frequency, or adjust the squelch level.
	The radio may be set with no signaling.	Set signaling for all member radios to avoid interference at the same frequency.
The noise is too loud.	You may be too far away from other members.	Move towards other members, power off your radio and then restart it.
	You may be at an unfavorable position. For example, your communication may be blocked by high buildings or frustrated in the underground areas.	Move to an open and flat area, and restart the radio.
	You may suffer from external disturbance (such as electromagnetic interference).	Stay away from equipment that may cause interference.

If the above solutions can not fix your problems, or you may have some other queries, please contact us or your local dealer for more technical support.

Care and Cleaning

To guarantee optimal performance as well as a long service life of the product, please follow the tips below.

Product Care

- Do not pierce or scrape the product with any edged instruments or hard objects.
- Keep the product far away from substances that can corrode the circuit.
- Do not hold the product by its antenna or earpiece cable directly.
- Attach the accessory jack cover when the product is not in use.

Product Cleaning

- Clean up the dust and fine particles on the product surface and charging piece with a clean and dry lint-free cloth or a brush regularly.
- Use neutral cleanser and a non-woven fabric to clean the keys, control knobs and front case after long-time use. Do not use chemical preparations such as stain removers, alcohol, sprays or oil preparations, so as to avoid surface case damage. Make sure the product is completely dry before use.



Caution: Power off and remove the battery before cleaning.

Optional Accessories

The following items are the main optional accessories for the product, and please consult your local dealer for more other accessories.

			
Li-Ion Battery (1650mAh) BL1719	Li-Ion Battery (1300mAh) BL1301	Vehicle Power Adapter CHV09	Six-unit Switching Power PS7002
			
Earbud with in-Line PTT & VOX ESM11	Earbud with on-MIC PTT & VOX ESM12	D-earset with Boom MIC & VOX EHM16	D-earset with in-Line MIC & VOX EHM15
			
Nylon Carrying Case (non-swivel) (black) NCN001	Antenna		



Caution: Use the accessories specified by Hytera only. If not, Hytera shall not be liable for any losses or damages arising out of use of unauthorized accessories.