



Body Worn Camera
USER MANUAL

Preface

Welcome to the world of Hytera and thank you for purchasing this product. To derive optimum performance from the product, please carefully read this manual before use.

This manual is applicable to the following product:

[VM550 Body Worn Camera](#)

Icon Conventions

The following icons are available through this manual:

 **Note:** Indicates references that can further describe the related topics.

 **Caution:** Indicates situations that could cause data loss or equipment damage.

 **Warning:** Indicates situations that could cause minor personal injury.

Copyright Information

Hytera is the trademark or registered trademark of Hytera Communications Corporation Limited (the Company) in PRC and/or other countries or areas. The Company retains the ownership of its trademarks and product names. All other trademarks and/or product names that may be used in this manual are properties of their respective owners.

The product described in this manual may include the Company's computer programs stored in memory or other media. Laws in PRC and/or other countries or areas protect the exclusive rights of the Company with respect to its computer programs. The purchase of this product shall not be deemed to grant, either directly or by implication, any rights to the purchaser regarding the Company's computer programs. The Company's computer programs may not be copied, modified, distributed, decompiled, or reverse-engineered in any manner without the prior written consent of the Company.

Disclaimer

The Company endeavors to achieve the accuracy and completeness of this manual, but no warranty of accuracy or reliability is given. All the specifications and designs are subject to change without notice due to continuous technological development. No part of this manual may be copied, modified, translated, or distributed in any manner without the prior written consent of the Company.

We do not guarantee, for any particular purpose, the accuracy, validity, timeliness, legitimacy or completeness of the third-party products and contents involved in this manual.

If you have any suggestions or would like to receive more information, please visit our website at: <http://www.hytera.com>.

EU Regulatory Conformance

As certified by the qualified laboratory, the product is in compliance with the essential requirements and other relevant provisions of the following directives:

- 2006/66/EC
- 2011/65/EU
- 2012/19/EU
- 2014/53/EU

Please note that the above information is applicable to EU countries only.

FCC Statement

This equipment has been tested and found to comply with the limits for a Class B digital device, pursuant to Part 15 of the FCC Rules. These limits are designed to provide reasonable protection against harmful interference in a residential installation. This equipment generates uses and can radiate radio frequency energy and, if not installed and used in accordance with the instructions, may cause harmful interference to radio communications. However, there is no guarantee that interference will not occur in a particular installation. If this equipment does cause harmful interference to radio or television reception, which can be determined by turning the equipment off and on, the user is encouraged to try to correct the interference by one or more of the following measures:

- Reorient or relocate the receiving antenna.
- Increase the separation between the equipment and receiver.
- Connect the equipment into an outlet on a circuit different from that to which the receiver is connected.
- Consult the dealer or an experienced radio/TV technician for help.

Labelling requirements

This device complies with part 15 of the FCC Rules. Operation is subject to the following two conditions: (1) This device may not cause harmful interference, and (2) this device must accept any interference received, including interference that may cause undesired operation.

Information to User

Any Changes or modifications not expressly approved by the party responsible for compliance could void the user's authority to operate the equipment.

Specific Absorption Rate (SAR) information

This product meets the government's requirements for exposure to radio waves. The guidelines are

based on standards that were developed by independent scientific organizations through periodic and thorough evaluation of scientific studies. The standards include a substantial safety margin designed to assure the safety of all persons regardless of age or health.

Body-worn Operation

This device was tested for typical body-worn operations. To comply with RF exposure requirements, a minimum separation distance of 5mm for body worn must be maintained between the user's body, including the antenna. Third-party belt-clips, holsters, and similar accessories used by this device should not contain any metallic components. Body-worn accessories that do not meet these requirements may not comply with RF exposure requirements and should be avoided. Use only the supplied or an approved antenna.

IC Statement

This device complies with Industry Canada's licence-exempt RSSs. Operation is subject to the following two conditions:

- (1) This device may not cause interference; and
- (2) This device must accept any interference, including interference that may cause undesired operation of the device.

Le présent appareil est conforme aux CNR d'Industrie Canada applicables aux appareils radio exempts de licence. L'exploitation est autorisée aux deux conditions suivantes: (1) l'appareil ne doit pas produire de brouillage, et (2) l'utilisateur de l'appareil doit accepter tout brouillage radioélectrique subi, même si le brouillage est susceptible d'en compromettre le fonctionnement.

IC SAR Warning

The information listed above provides the user with information needed to make him or her aware of a RF exposure, and what to do to assure that this radio operates within the FCC exposure limits of this radio.

The device complies with RF specifications when the device used at 5mm from your body. Third-party belt-clips, holsters, and similar accessories used by this device should not contain any metallic components. Body-worn accessories that do not meet these requirements may not comply with RF exposure requirements and should be avoided.

RED Statement

1. Risk of explosion if battery is replaced by an incorrect type. Dispose of used batteries according to the instructions.
2. The product shall only be connected to a USB interface of version USB2.0.
3. Adapter shall be installed near the equipment and shall be easily accessible.
4. The operating temperature of the EUT can't exceed 55°C and shouldn't be lower than 0°C.
5. The plug considered as disconnect device of adapter.
6. The device complies with RF specifications when the device used at 5 mm form your body.

Hereby, Hytera Communications Corporation Limited declares that this product is in compliance with essential requirements and other relevant provisions of Directive 2014/53/EU. This product is allowed to be used in all EU member states.

1. Packing List

Please unpack carefully and check if all items listed below are received. If any item is missing or damaged, please contact your dealer.

No.	Name	Qty.
1	Body Worn Camera (RVM)	1
2	Battery	1
3	Belt Clip	1
4	USB Cable	1
5	Power Adapter	1
6	User Manual	1

 Note

Pictures listed in this manual are for reference only.

2. Product Overview

2.1 Product Controls

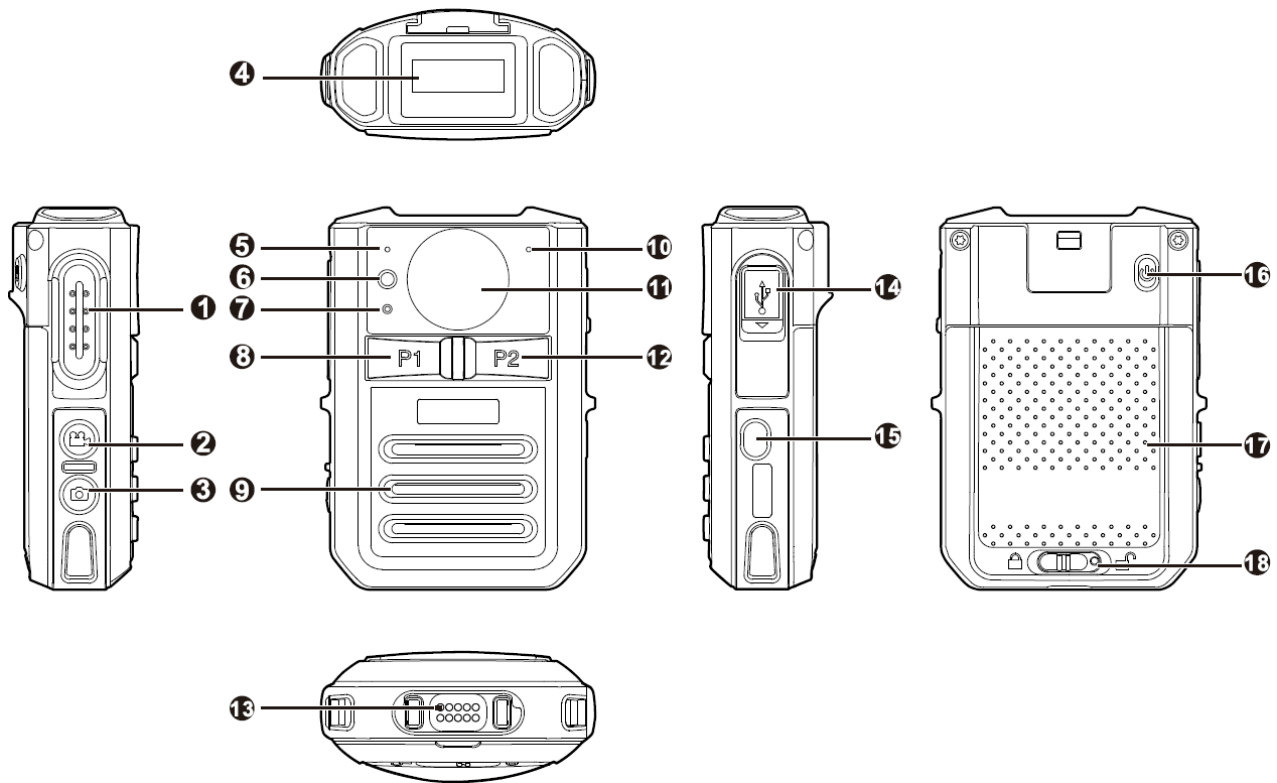















No.	Name	No.	Name
1	Push-to-Talk (PTT) Key	10	Audio/Video Recording Microphone
2	Video Recording Key	11	Camera
3	Photo Taking Key	12	P2 Key (Programmable key, default as the Audio Recording key)
4	OLED Display	13	Accessory Connector (10-pin)
5	Speaking Microphone	14	USB Connector
6	Camera Flash	15	Emergency Key
7	LED Indicator	16	Power On/Off Key
8	P1 Key (Programmable key, default as the Tagging key)	17	Battery



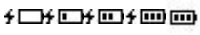













No.	Name	No.	Name
9	Speaker	18	Battery Latch

Note

The **P1** key and **P2** key can be programmed through the RVM Manager tool. Contact us or your local dealer to get the tool.

2.2 OLED Icons

Type	Icon	Description
WLAN		The product is connected to WLAN with very weak signal.
		The product is connected to WLAN with weak signal.
		The product is connected to WLAN with strong signal.
		The product is disconnected from WLAN.
		A problem occurred in WLAN connection.
		WLAN hotspot is enabled.
BT		BT feature is enabled.
		BT connection is established.
Charging		<ul style="list-style-type: none"> : The product is being charged under low battery. : The product is fully charged.
Battery Level		<ul style="list-style-type: none"> : Low battery. : Full battery.
Area/Group (Folder)		Displays the area of the current channel, or the group (folder) of the current contact in standby mode while connected to a portable radio. Only letters, digits and some special characters are supported.

Type	Icon	Description
Channel/Contact	CH D1	Displays the current channel, or the current contact in standby mode while connected to a portable radio. Only letters, digits and some special characters are supported.
Time	15:36	Displays the current time in standby mode while not connected to the portable radio.
Video Recording		Pre-recording mode
		Video recording mode
		Important video recording mode
		Post-recording mode
		Important post-recording mode
Audio Recording		Audio recording mode
		Important audio recording mode
TF Card		The remaining capacity of the TF card is less than 2 GB.
Photo Taking		Photo taking mode
Call		Individual call
		Group call
		All call
		Analog call
		Telephone call
		Emergency call
		Call out
		Call in

2.3 LED Indicators

Status	Description
--------	-------------

Status	Description
Glows red	<ul style="list-style-type: none"> ● The product is transmitting voice or emergency alarm. ● The product is being charged. ● The TF card is full. ● The product is being turned off.
Glows green	<ul style="list-style-type: none"> ● The product is receiving voice or emergency alarm. ● The product is fully charged. ● The product is being turned on.
Glows orange	Call hang time. You can press and hold the PTT key to speak.
Flashes orange rapidly	<ul style="list-style-type: none"> ● No voice transmission in emergency mode. ● The remaining capacity of the TF card is less than 2 GB.
Flashes red slowly	<ul style="list-style-type: none"> ● Flashes once every second: The product is recording a video. ● Flashes red once every five seconds: The battery runs low. Please recharge or replace the battery in time.
Flashes orange slowly	The product is recording an audio.
Flashes red and blue in turn	The product is pairing with other BT devices.
Flashes blue rapidly	BT connection is established.

2.4 Specifications

Body Worn Camera	
Dimensions (H×W×D)	25.7 mm×58 mm×86.5 mm
Weight (with battery)	≤145 g
Image Sensor	4-megapixel
Camera	Fixed angle, glass, diagonal 139°, horizontal 116°, vertical 60°.
Focus Range	0.1 m to infinity
Battery Life (continuous video recording)	<ul style="list-style-type: none"> ● ≥8h (480P 30 FPS) ● ≥7h (720P 30 FPS)

Body Worn Camera	
	<ul style="list-style-type: none"> ● ≥6h (1080P 30 FPS) ● ≥9h (audio recording)
Main Battery Capacity	2,500 mAh
Main Battery Charging Time	≤4 h
Standby Battery Capacity	0.8 mAh
RTC Hold Time	72 h (without main battery)
Display Size	0.9 inch
Display Resolution	128 × 32
Screen Type	Dot-matrix Monochrome OLED Display
TF Card Storage	<ul style="list-style-type: none"> ● Standard: 16 GB ● Optional: 32 GB/64 GB/128 GB
Video Format	MP4
Video Encoding Format	H.264
Video Resolution	480P (30 FPS), 720P (30/60 FPS), 1080P (30/60 FPS)
TF Card Recording Time	<p>Take the standard 16 GB storage as example.</p> <ul style="list-style-type: none"> ● >20 h (480P 30 FPS) ● >13 h (720P 30 FPS) ● >6.5 h (1080P 30 FPS)
Audio Format	AAC (Advanced Audio Coding)
Photo Format	JPG
Photo Resolution	<ul style="list-style-type: none"> ● 4608 × 3456 (16-megapixel) ● 3072 × 1728 (5-megapixel) ● 2304 × 1296 (3-megapixel)
Pre-recording Time	10s/20s
Post-recording Time	10s/20s/30s

Body Worn Camera	
Speaker Power	2 W
Microphone	Electret microphone ×2, Omni-directional: -44 dB
Connector	Micro USB port, 10-pin connector
Sensor	Accelerometer
Camera Flash	1 W
IP Class	MIL-STD-810G, IP67
Drop Resistance	1.5 m
ESD	<ul style="list-style-type: none"> ● ±6 kV (contact discharge) ● ±12 kV (air discharge)
Operating Temperature	0°C to +55°C
Storage Temperature	-40°C to +85°C
Compatible System	Windows XP/Windows 7/Windows 8/Windows 10
Wi-Fi (supporting AP mode and STA mode)	
Operation frequency	802.11b/802.11g/802.11n(HT20): 2,412 – 2,462 MHz
Maximum EIRP	Refer to the RF report
BT	BT4.0 (supporting voice, EDR and BLE)
BT-EDR	
Operation frequency	2,402 – 2,480 MHz
Maximum EIRP	Refer to the RF report
BT-BLE	
Operation frequency	2,402 – 2,480 MHz
Maximum EIRP	Refer to the RF report

Body Worn Camera	
Power Adapter	
Input	AC 110 – 240 V, 50 – 60 Hz
Output	DC 5 V, 1 A

3. Before Use

3.1 Attaching the Battery

ⓘ Warning

- Use only the Hytera standard or optional battery. Polarity reverse or use of other batteries may result in explosion and fire hazards.
 - The battery is applicable to a temperature range of 0°C to +55°C.
-

Attach the battery according to the steps shown in the following figure. To remove the battery, turn off the product and reverse the attaching steps.

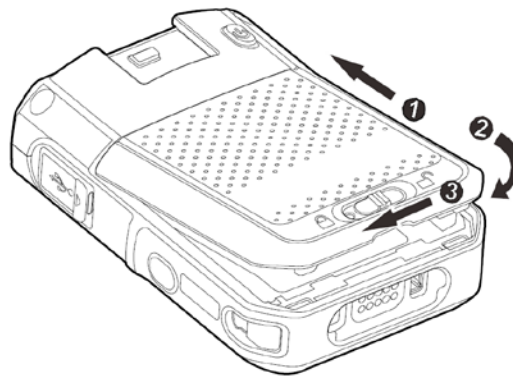

3.2 Attaching the Belt Clip

Attach the belt clip according to the steps shown in the left figure. To remove the belt clip, do as the steps shown in the right figure.

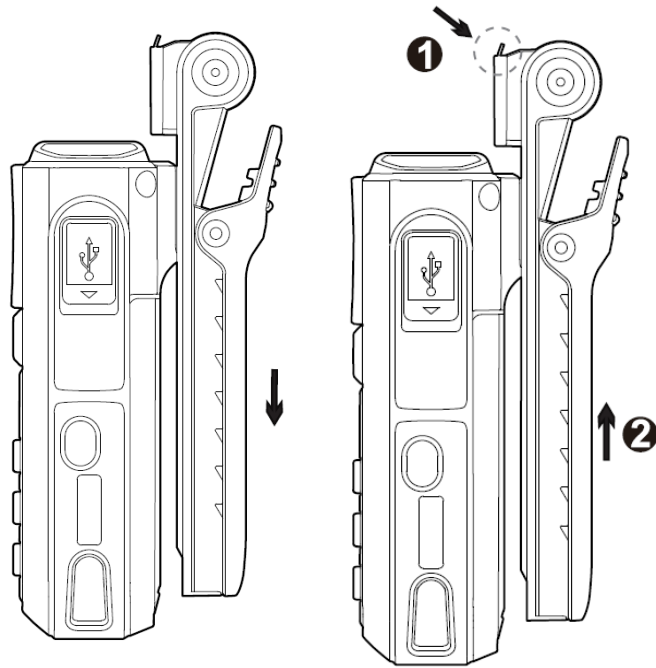

3.3 (Optional) Connecting the Accessory Cable

ⓘ Warning

Skip this section if you do not purchase the accessory cable.

Connect the cable to RVM as shown in the figure below. To disconnect the cable, press both sides of the cable connector with proper force and remove the connector.

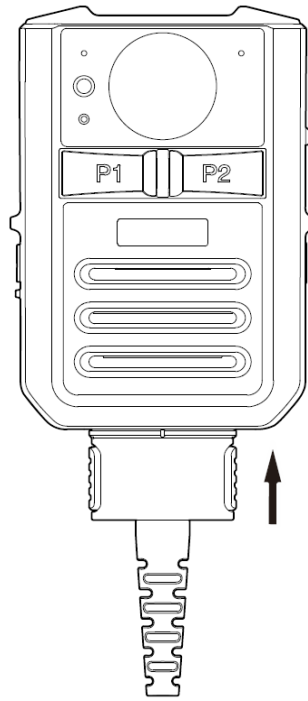

3.4 Charging the Product

Charge the product according to the steps shown in the following figure.

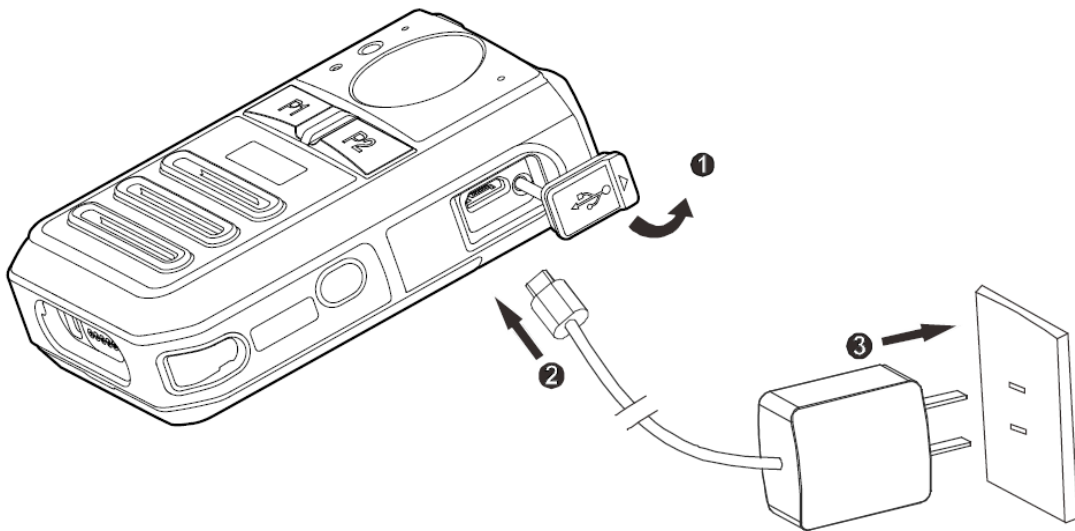

The LED indicator tells you the charging status of the product. See **2.3 LED Indicators** for details.

4. Basic Operations

4.1 Turning On and Turning Off the Product

Turning On the Product

In power-off mode, press and hold the **On/Off** key for three seconds to turn on the product.

Turning Off the Product

In power-on mode, press and hold the **On/Off** key for three seconds to turn off the product.

4.2 Entering BT Pairing

In power-off mode, press and hold the **On/Off** key for five seconds to start BT pairing.

4.3 One-touch Activation and Recording/Photo Taking

In power-off mode, press and hold the **Video Recording** key/**Photo Taking** key to turn on the product and record video or take photo; press the **Video Recording** key again to exit video recording.

4.4 Recording Videos

In power-on mode, press the **Video Recording** key to record video; press the key again to exit video recording.

Note

- The product supports loop recording. In loop mode, when the TF card is full and a new video is being recorded, the product automatically deletes the oldest video by date. You can program this feature through the RVM Manager.
 - If the post-event recording feature is enabled, the product automatically enters post-event recording mode after the recording is deactivated.
-

4.5 Pre- and Post-event Recording

The RVM is capable of pre- and post-event recording to ensure all interactions during an incident are captured. Pre-event recording allows officers to capture a period time of footage prior to an event that led them to press the record button, while post-event recording can add a period time of footage after

the recording is deactivated.

You can program the pre- and post-event recording features through the RVM Manager.

Pre-event Recording

In power-on mode, press and hold the **Video Recording** key to enter pre-event recording; press and hold the key again to exit.

In pre-event recording mode, the product loops to record video every 10 or 20 seconds according to the pre-recording time.

Post-event Recording

During video recording, press the **Video Recording** key to enter post-event recording.

In post-event recording mode, the product records video for another 10, 20 or 30 seconds according to the post-recording time.

To exit post-recording mode, do one of the followings:

- Press the **Video Recording** key to start normal video recording again; press the **Video Recording** key again to exit recording.
- Press the **Emergency** key or the **P1** key to start recording videos and tag the videos as critical evidence; press the **Video Recording** key to exit recording.
- The product automatically exits recording after the post-recording time ends.

4.6 Recording Audios

In power-on mode, press the **P2** key (default) to record audio; press the key again to exit audio recording.

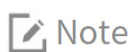

You can modify the method to start and exit audio recording through the RVM Manager.

4.7 Taking Photos

In power-on mode, press the **Photo Taking** key to take photo.

4.8 Recording Tagging

- During video or audio recording, press the **P1** key (default) to tag critical events; press the **P1** key (default) again to untag.

- In power-on mode, press the **Emergency** key to start recording videos and tag the videos as critical evidence; press and hold the **Emergency** key or press the **Video Recording** key to exit recording.
-

Note

You can modify the method to tag and untag recordings through the RVM Manager.

4.9 Taking Photos during Video Recording

During video recording, press the **Photo Taking** key to take photos.

4.10 Making Calls

When the product is connected to a portable radio through BT, you can use the product to make calls, answer calls, speak or terminate calls. You can program keys to make or answer a call through the RVM Manager.

- Making a call: Press the **PTT** key to start a call in the current channel or with the current contact.
- Answering a call: Press and hold the **P2** key (default) to answer a call.
- Speaking: Press and hold the **PTT** key to speak through the **Speaking Microphone**.
- Terminating a call: During an ongoing call, press and hold the **P2** key (default) to terminate the call.

4.11 Video Transmission

When the product is connected to a portable radio through BT, you can accept, refuse or terminate video transmission from other devices. The video transmitting features can be programmed through the RVM Manager.

- Accepting video transmission: Press and hold the **P1** key (default).
- Refusing video transmission: Press or press and hold the **P1/P2** key.
- Terminating video transmission: During the transmission, press and hold the **P1** key (default) to terminate.

4.12 Sending an Emergency Alarm

When the product is connected to a portable radio through BT, you can press the **Emergency** key to make an emergency alarm in case of emergencies. At this time, the product enters important video recording automatically. The emergency alarm has the highest priority. You can send an emergency alarm no matter whether the portable radio is transmitting or receiving. To cancel the emergency alarm,

press the **Emergency** key again.

Note

The method to send and cancel an emergency alarm can be set by your dealer.

4.13 Silent Mode

With this feature enabled, the product gives no alert tones, the indicator will not light up. You can program this feature through the RVM Manager.

In power-on mode, press and hold or press the **P1/P2** key to enable the Silent Mode; press and hold or press the **P1/P2** key again to disable the Silent Mode.

4.14 Flashlight

In power-on mode, press and hold the **Photo Taking** key for three seconds to turn on the flashlight; press and hold the **Photo Taking** key for three seconds again to turn off the flashlight.

4.15 Viewing Device Information

When the OLED screen is on, press and hold the **P1** key and **P2** key simultaneously for three seconds; the screen displays the device information, including device ID, storage, software version and etc.

5. Troubleshooting

Phenomena	Analysis	Solution
The product cannot be turned on.	The battery may be improperly attached.	Remove the battery and attach it again.
	The battery may run out.	Recharge or replace the battery.
	The battery and the charging probes are in poor contact due to dirtied or damaged battery contacts.	Clean the battery contacts.
BT connection cannot be established.	The product is out of the portable radio's communication coverage.	Make sure to use the product within the radio's communication coverage.
You hear noise during calls.		
The LED indicator does not glow red when you press and hold the PTT key.		
The volume is low when the product is used with a portable radio.	The speaking microphone and the speaker are blocked or damaged.	Clean the speaking microphone and the speaker.
The product cannot record video or audio.	The TF card is full.	Delete all data from the TF card after exporting the data.
The product cannot take photo.	The TF card is full.	Delete all data from the TF card after exporting the data.
	The total number of photos reaches the maximum (300).	Delete all photos from the TF card after exporting them.
The product cannot pre-record or post-record the video.	The pre-recording or post-recording feature is not enabled.	Enable the feature through the RVM Manager.

Phenomena	Analysis	Solution
The product gives no alert tone; the indicator does not light up.	The Silent Mode is enabled.	Disable the Silent Mode.
The product gives no response to operations.	The system has crashed.	Press the P1 key, the P2 key, and the Photo Taking key simultaneously to turn off the product, and then turn it on again.

If the above solutions cannot solve your problems, or you may have some other queries, please contact us or your local dealer for more technical support.

6. Care and Cleaning

To guarantee optimum performance as well as a long service life of the product, please follow the tips below.

Product Care

- Do not pierce or scrape the product.
- Keep the product away from substances that can corrode the circuitry.
- Do not hold the product by the connection cable.
- Attach the USB port cover when the USB port is not in use.

Product Cleaning

Caution

- Power off the product before cleaning.
 - Make sure the product is completely dry before use.
-

- Clean up the dust and fine particles on the product's surface with a clean and dry lint-free cloth or a brush regularly.
- Use neutral cleanser and a non-woven fabric to clean the keys and surface after long-time use. Do not use chemical preparations such as stain removers, alcohol, sprays or oil preparations, so as to avoid surface damage.

7. Optional Accessories

Caution

Use the accessories specified by the Company only; otherwise, we shall not be liable for any losses or damages arising out of the use of any unauthorized accessories.

Contact your local dealer for the optional accessories of the product.



is the trademark or registered trademark of Hytera Communications Corporation Limited.

©2018 Hytera Communications Corporation Limited. All Rights Reserved.

Address: Hytera Tower, Hi-Tech Industrial Park North, 9108# Beihuan Road, Nanshan District,
Shenzhen, People's Republic of China

Postcode: 518057

<http://www.hytera.com>