

Preface

Thanks for your favor in our product. To derive optimum performance from the product, please read this manual and the supplied Safety Information Booklet carefully before use.

This manual is applicable to the following model:

X1p U(2)

Instructional Icons

The following icons are available through this manual:

Alert Icons



Caution: indicates situations that could cause damage to your product.



Note: indicates tips that can help you make better use of your product.

Function Icons



: indicates functions that are available on digital channel only.



: indicates functions that are available on analog channel only.

Functions marked with no function icons are available on both analog and digital channels.

Term Explanation

Key Operation

Short press: to press a key and release it quickly.

Long press: to press a key and remain holding it down for a predefined period (2 seconds by default).

Hold down: to press a key and remain holding it down.

Private Call

Private Call is a call initiated by a single user to another user.

Group Call

Group Call is a call initiated by a single user to a group.

All Call

All Call is a call initiated by a single user to all the other users on a channel.

Squelch

This technology can remove excessive background noises, improving your communication quality.

Copyright Information

Hytera is the trademark or registered trademark of Hytera Communications Co., Ltd. (the Company) in PRC and/or other countries or areas. The Company retains the ownership of its trademarks and product names. All other trademarks and/or product names that may be used in this manual are properties of their respective owners.

The product described in this manual may include the Company's computer programs stored in memory or other media. Laws in PRC and/or other countries or areas protect the exclusive rights of the Company with respect to its computer programs. The purchase of this product shall not be deemed to grant, either directly or by implication, any rights to the purchaser regarding the Company's computer programs. Any of the Company's computer programs may not be copied, modified, distributed, decompiled, or reverse-engineered in any manner without the prior written consent of the Company.

The AMBE+2TM voice coding technology embodied in this product is protected by intellectual property rights including patent rights, copyrights and trade secrets of Digital Voice Systems, Inc. This voice coding technology is licensed solely for use within this product. The user of this technology is explicitly prohibited from attempting to decompile, reverse engineer, or disassemble the Object Code or in any other way convert the Object Code into a human readable form.

U.S. Patent Nos. #6,912,495 B2, #6,199,037 B1, #5,870,405, #5,826,222, #5,754,974, #5,701,390, #5,715,365, #5,649,050, #5,630,011, #5,581,656, #5,517,511, #5,491,772, #5,247,579, #5,226,084 and #5,195,166.

Disclaimer

The Company endeavors to achieve the accuracy and completeness of this manual, but no warranty of accuracy or reliability is given. All the specifications and designs are subject to change without notice due to continuous technology development. No part of this manual may be copied, modified, translated, or distributed in any manner without the express written permission of us.

If you have any suggestions or would like to learn more details, please visit our website at:

<http://www.hytera.com>.

RF Radiation Information

The radio is not intended for use by general population in an uncontrolled environment. It is only for occupational use and only applied to work-related conditions.

The radio must be only used by users, who are fully aware of the hazards of the exposure and who are able to exercise control over their RF exposure to qualify for the higher exposure limits.

RF Radiation Profile

Radio Frequency (RF) is a frequency of electromagnetic radiation in the range at which radio signals are transmitted. RF technology is widely used in communication, medicine, food processing and other fields. It may generate radiation during use.

RF Radiation Safety

In order to ensure user health, experts from relevant industries including science, engineering, medicine and health work with international organizations to develop standards for safe exposure to RF radiation.

These standards consist of:

- United States Federal Communications Commission, Code of Federal Regulations; 47CFR part 2 sub-part J;
- American National Standards Institute (ANSI)/Institute of Electrical and Electronic Engineers (IEEE) C95. 1-1992;
- Institute of Electrical and Electronic Engineers (IEEE) C95. 1 – 1999;
- International Commission on Non-Ionizing Radiation Protection (ICNIRP) 1998;

FCC Regulations

Federal Communication Commission (FCC) requires that all radio communication products should meet the requirements set forth in the above standards before they can be marketed in the U.S, and the manufacturer shall post a RF label on the product to inform users of operational instructions, so as to enhance their occupational health against exposure to RF energy.

FCC Statement

This equipment has been tested and found to comply with the limits for a Class B digital device, pursuant to part 15 of FCC Rules. These limits are designed to provide reasonable protection against harmful interference in a residential installation. This equipment generates and can radiate radio frequency energy and, if not installed and used in accordance with the instructions, may cause harmful interference to radio communications. However, there is no guarantee that interference will not occur in a particular

installation. If this equipment does cause harmful interference to radio or television reception, which can be determined by turning the equipment off and on, the user is encouraged to try to correct.

The interference by one or more of the following measures:

- Reorient or relocate the receiving antenna. Increase the separation between the equipment and receiver.
- Connect the equipment into an outlet on a circuit different from that to which the receiver is connected.
- Consult the dealer or an experienced radio/TV technician for help

Operation is subject to the following two conditions: 1. This device may not cause harmful interference, and 2. This device must accept any interference received, including interference that may cause undesired operation.

Note:” Changes or modifications to this unit not expressly approved by the party responsible for compliance could void the user’s authority to operate the equipment.”

Compliance with RF Exposure Standards

Hytera’s 2-way radio complies with the following RF energy exposure standards and guidelines:

- United States Federal Communications Commission, Code of Federal Regulations; 47 CFR §§ 1.1307, 1.1310, 2.1091 and 2.1093
- American National Standards Institute (ANSI) / Institute of Electrical and Electronic Engineers (IEEE) C95.1-1992
- Institute of Electrical and Electronic Engineers (IEEE) C95.1-1999 Edition

RF Exposure Compliance and Control Guidelines and Operating

Instructions

To control your exposure and ensure compliance with the occupational/controlled environment exposure limits always adhere to the following procedures.

Guidelines:

- Do not remove the RF Exposure Label from the device.
- User awareness instructions should accompany device when transferred to other users.
- Do not use this device if the operational requirements described herein are not met.

Operating Instructions:

- Transmit no more than the rated duty factor of 50% of the time. To transmit (talk), push the Push-To-Talk (PTT) button. To receive calls, release the PTT button. Transmitting 50 % of the time, or less, is important because this radio generates measurable RF energy exposure only when transmitting (in terms of measuring for standards compliance).
- Hold the radio in a vertical position in front of face with the microphone (and the other parts of the radio,

including the antenna) at least one inch (2.5 cm) away from the nose. Keeping the radio at the proper distance is important because RF exposures decrease with distance from the antenna. Antenna should be kept away from eyes.

- When worn on the body, always place the radio in a Hytera's approved clip, holder, holster, case, or body harness for this product. Using approved body-worn accessories is important because the use of Hytera's or other manufacturer's non-approved accessories may result in exposure levels, which exceed the FCC's occupational/controlled environment RF exposure limits.
- If you are not using a body-worn accessory and are not using the radio in the intended use position in front of the face, then ensure the antenna and the radio are kept at least 2.5 cm (one inch) from the body when transmitting. Keeping the radio at the proper distance is important because RF exposures decrease with increasing distance from the antenna.
- Use only manufacturer's name approved supplied or replacement antennas, batteries, and accessories. Use of non-manufacturer-name approved antennas, batteries, and accessories may exceed the FCC RF exposure guidelines.
- For a list of Hytera's approved accessories (see the user manual), or (visit the following website which lists approved accessories: [http: add website address](http://add website address)), or (The manufacturer should include the appropriate bracketed item{s} in the manual.)
- For a list of Hytera's approved accessories (see the user manual), or (visit the following website which lists approved accessories: www.hytera.cn)

IC statement

This device complies with Industry Canada licence-exempt RSS standard(s). Operation is subject to the following two conditions:

- (1) This device may not cause interference, and
- (2) This device must accept any interference, including interference that may cause undesired operation of the Device.

The device has been tested and compliance with SAR limits, users can obtain Canadian information on RF exposure and compliance

Le présent appareil est conforme aux CNR d'Industrie Canada applicables aux appareils radio exempts de licence. L'exploitation est autorisée aux deux conditions suivantes :

- (1) l'appareil n' doit pas produire de brouillage, et
- (2) l'utilisateur de l'appareil doit accepter tout brouillage radioélectrique subi, même si le brouillage est susceptible d'en compromettre le fonctionnement.

Après examen de ce matériel aux conformité aux limites DAS et/ou aux limites d'intensité de champ RF, les utilisateurs peuvent sur l'exposition aux radiofréquences et la conformité and compliance d'acquérir les informations correspondantes

Operational Instructions and Training Guidelines

To ensure optimal performance and compliance with the occupational/controlled environment RF energy exposure limits in the above standards and guidelines, users should transmit no more than 50% of the time and always adhere to the following procedures:









Your radio radiates measurable RF energy only while it is transmitting (during talking), not when it is receiving (listening) or in standby mode.







EU Regulatory Conformance

As certified by the qualified laboratory, the product is in compliance with the essential requirements and other relevant provisions of the Directive 1999/5/EC. Please note that the above information is applicable to EU countries only.

CE 0678 

Contents

FCC Statement	4
[REDACTED]	10
[REDACTED]	11
Product Controls	11
Programmable Keys	12
[REDACTED]	13
Charging the Battery	13
Assembling Accessories.....	14
[REDACTED]	16
LED Indicator	16
[REDACTED]	17
Turning the Radio On/Off.....	17
Adjusting the Volume.....	17
Selecting a Zone.....	17
Selecting a Channel.....	18
Switching the Channel Mode.....	18
Enabling/Disabling the Bluetooth.....	18
[REDACTED]	18
Private Call 	18
Group Call 	19
All Call 	19
Calls on Analog Channels 	19
[REDACTED]	20
Adjust Power Level.....	20
Scan.....	20
Talk Around	21
Monitor 	21
Squelch Off 	21
Adjust Squelch Level 	21
One Touch Call	22
Telemetry 	23

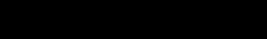
Roam 	23
Emergency	23
Man Down	27
Scrambler  /Encrypt 	27
Lone Worker	28
Battery Strength Indicator	28
Busy Channel Lockout	29
Time-out Timer (TOT)	29
Pseudo Trunking 	29
MIC AGC	29
Radio Registration Service 	29
GPS Revert 	30
	30
	32

Checking Items in the Package

Please unpack carefully and check that all items listed below are received. If any item is missing or damaged, please contact your dealer.

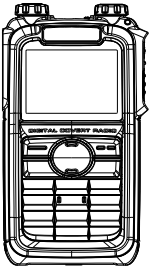

Radio Unit



Battery

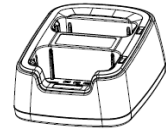

Charger

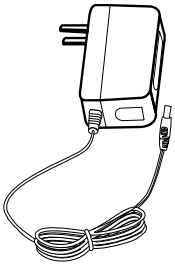

Power Adapter



Strap



Antenna



Manuals



Note: The antenna may vary with different frequency bands. And the frequency band is marked on the label of antenna; if not, please refer to the label on the terminal for frequency band information.

Product Overview

Product Controls

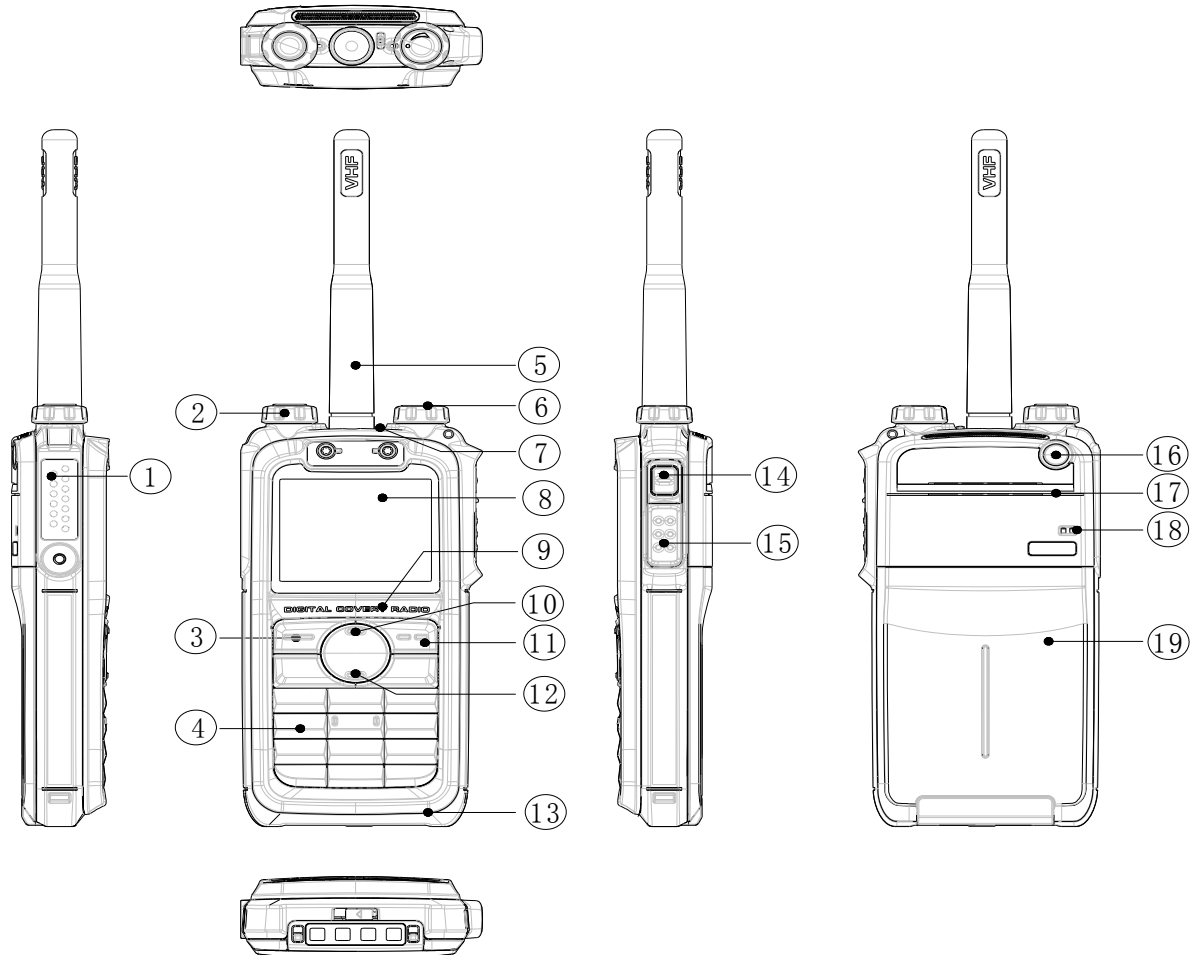









No.	Part Name	No.	Part Name
①	Accessory Jack	②	Radio On-Off/Volume Control Knob
③	OK/Menu Key	④	Numeric Keypad
⑤	Antenna	⑥	Channel Selector Knob
⑦	LED Indicator	⑧	LCD Display
⑨	Microphone 1	⑩	Up Key

⑪	Back Key	⑫	Down Key
⑬	Front cover	⑭	SK (Side Key)
⑮	PTT Key	⑯	TK (Top Key)
⑰	Speaker	⑱	Microphone 2
⑲	Battery		

Programmable Keys

For enhanced convenience, you may request your dealer to program the keys **SK** and **TK** as shortcuts to the functions listed below:

No.	Shortcut Key	Function
1	Zone Up	To select a desired zone quickly
2	Zone Down	
3	Adjust Power Level	To adjust power level quickly
4	Talk Around	To directly communicate with other radios
5	Monitor 	To adjust the condition for incoming signal match
6	Monitor Momentary 	
7	Squelch Off 	To always unmute speaker no matter whether carrier is present or not
8	Squelch Off Momentary 	
9	Scan	To receive signals on other channels
10	Nuisance Temporary Delete	To temporarily ignore unwanted channel activity
11	Emergency	To summon help in emergent situations
12	Adjust Squelch Level 	To temporarily adjust the squelch threshold required for the radio to unmute
13	Battery Strength Indicator	To indicate the battery strength
14	Man Down	To activate Emergency in the case that the

		radio is positioned aslant for a preset time period due to an unexpected situation
15	Scrambler  /Encrypt 	To encrypt your voice so as to guarantee privacy of your communication
16	Lone Worker	To protect the operators from accidents
17	One Touch Call 1-5	To make corresponding services
18	Telemetry 	To supervise remote devices
19	Roam 	To communicate between sites in the IP Multi-site Connect system.



Note:

- (1) Long and short press of a key can be assigned with different functions by your dealer.
- (2) The **TK** is programmed as the **Emergency** key by default, and is programmable by your dealer.

Before Use

Charging the Battery

Power off the radio before charging it.

Use only the charger and battery specified by Hytera. Charger LED can indicate the charging process.

Charging Diagram

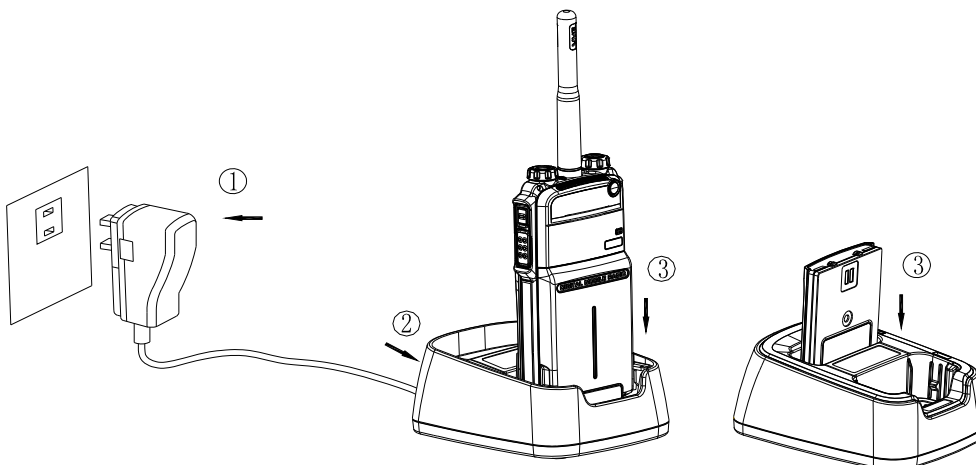

Procedures

1. Connect the power adapter to AC socket. See arrow ①.
2. Plug the power adapter into the rear jack of the charger. See arrow ②.
3. Place the radio with the battery attached, or the battery alone, into the charger.
4. The charging process initiates when LED glows red, and is completed when LED glows green.



Note: To achieve optimal battery performance, please charge the battery for 3 hours before initial use.

LED Indicator

LED Indicator	Charger Status
Red LED flashes slowly.	Standby (no load)
Red LED glows.	Charging
Orange LED glows.	90% charged
Green LED glows.	Fully charged
Red LED flashes rapidly.	Failure



Caution: Be sure to read the Safety Information Booklet, to get necessary safety information.

Assembling Accessories

Assembling the Antenna

Turn the antenna clockwise to fasten it.

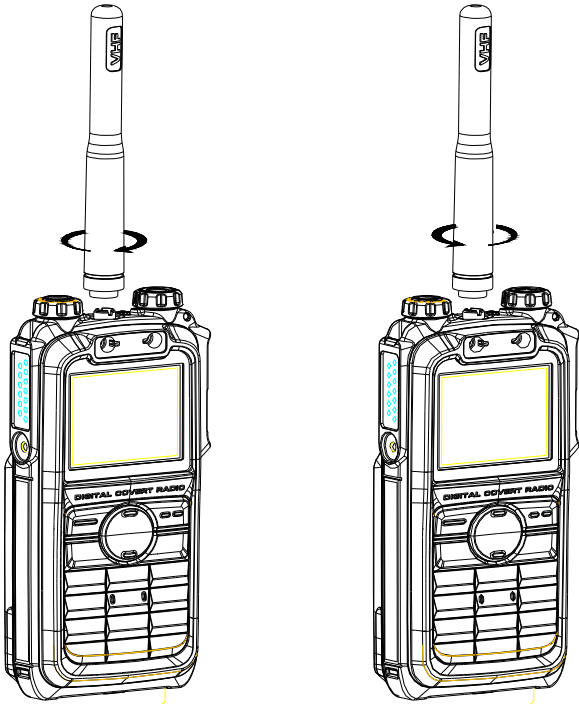

To remove the antenna, rotate it counter-clockwise.

Assembling the Battery

1. Insert the battery into top of the radio. See arrow ①.
2. Slightly press the bottom of the battery until a click is heard. See arrow ②.

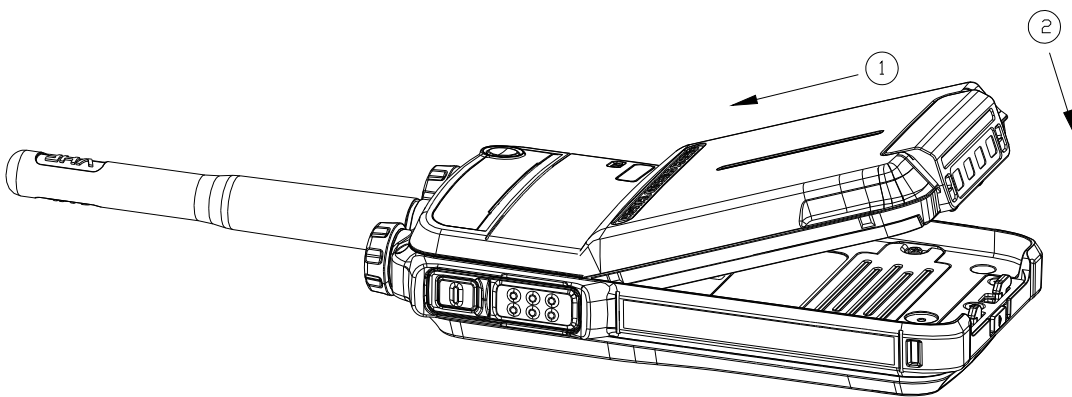

To remove the battery, turn off the radio first. Then push the lock to loosen the battery latch (as indicated by

①), and slide the battery latch upwards to unlock the battery.

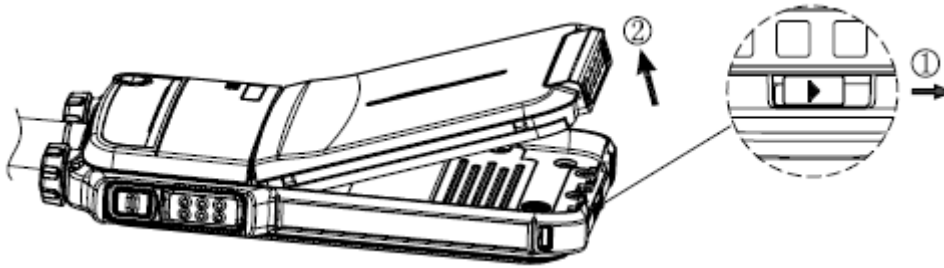

Assembling the Audio Accessory

1. Open the accessory jack cover as the arrow shown.
2. Align the plug with the accessory jack.
3. Tighten the screw on the plug.

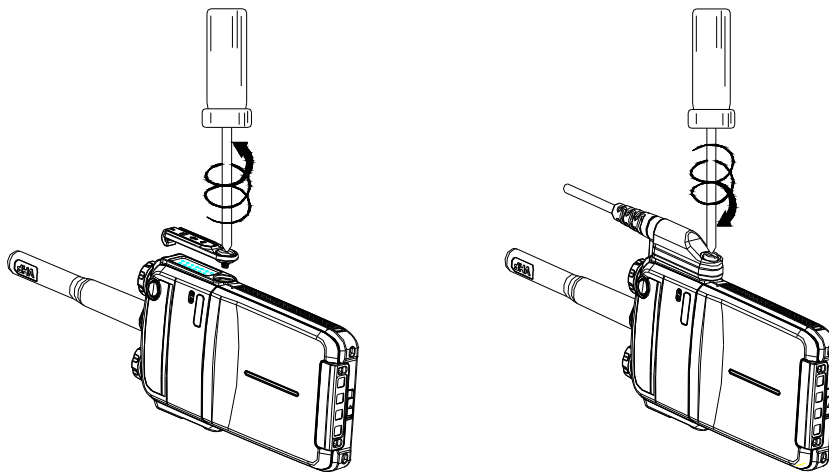

To remove accessories, loosen the screw.

 **Caution:** Please attach the accessory properly; otherwise, waterproof performance of the radio may get affected.

Status Indication

LED Indicator

The top LED indicator will help you easily identify the current radio status.

LED Indication	Radio Status
LED flashes green.	Powering on
LED glows red.	Transmitting
LED glows green.	Receiving

LED flashes orange slowly.	Scanning
LED flashes orange rapidly.	Emergency
LED glows orange.	After voice communication ends, you can hold down the PTT key to talk while the LED is glowing orange.
LED flashes red and blue.	Pairing the Bluetooth
LED flashes blue.	Paired successfully

Basic Operations

Turning the Radio On/Off

Rotate the **Radio On-Off/Volume Control** knob clockwise/counter-clockwise until a click is heard to turn the radio on/off.

Adjusting the Volume

After turning the radio on, rotate the **Radio On-Off/Volume Control** knob clockwise to increase the call volume, or counter-clockwise to decrease it.

Selecting a Zone

A zone is a group of channels exhibiting the same property, and is programmed by your dealer. The radio supports 3 zones: Zone 1, Zone 2 and Zone 3. Each zone contains 16 channels at most.

You may quickly toggle to your desired zone by pressing the programmed **Zone Up** or **Zone Down** key. In the process, you will hear one alert tone for Zone 1, two alert tones for Zone 2 and three alert tones for Zone 3.

Selecting a Channel

After turning the radio on, rotate the **Channel Selector** knob to select a desired channel.

Switching the Channel Mode

Each channel can be programmed as either analog channel or digital channel. If the current zone includes both analog and digital channels, you may quickly switch between digital and analog through the **Channel Selector** knob.

Enabling/Disabling the Bluetooth

Short press the SK key twice to enable/disable the Bluetooth. If it is enabled, the LED will flash blue.



Caution: Please use our POA43 Bluetooth earpiece.

To use the Bluetooth function properly, please arrange the radio by any of the following way:

- Wear the radio and the Bluetooth earpiece on the same side of your body, with the radio's front side facing your body. The distance between the radio and Bluetooth earpiece must not exceed 0.5m.
- Place the radio at a place no more than 2m away from the Bluetooth earpiece, with the radio's rear side facing the Bluetooth earpiece.

Call



Note:

Your dealer may preset a contact for each digital channel. The preset contact could be a Private Call contact, a Group Call contact or an All Call contact.

To ensure optimal volume of the receiving radio, hold the palm microphone approximately 2.5 to 5 centimeters away from your mouth.

Private Call



Transmitting a Private Call

In the standby mode, hold down the **PTT** key to transmit a Private Call to the Private Call contact preset for the current channel.

Receiving and Responding to a Private Call

When a Private Call is received, you can listen to it without any operation, and you may hold down the **PTT** key within the preset time period to call back.

Group Call

Transmitting a Group Call

In standby mode, hold down the **PTT** key to transmit a Group Call to the Group Call contact preset for the current channel.

Receiving and Responding to a Group Call

When a Group Call is received, you can listen to it without any operation, and you may hold down the **PTT** key within the preset time period to call back.

All Call

Transmitting an All Call

In standby mode, hold down the **PTT** key to transmit an All Call to the All Call contact preset for the current channel.



Note: You can transmit an All Call only when it is enabled by your dealer.

Receiving an All Call

When an All Call is received, you can listen to it without any operation.



Note: You cannot respond to an All Call.

Calls on Analog Channels

To transmit on an analog channel, hold down the **PTT** key and speak into the microphone. To receive, release the **PTT** key.

Functions and Operations

Adjust Power Level

With this feature, you may switch power levels quickly. Generally, we recommend you to adopt low power for battery saving. However, if you cannot communicate with radios located at a distant place with low power, please select high power.

Operation:

Press the programmed **Adjust Power Level** key to switch between high power and low power (from low power to high power: a high-pitched tone sounds; from high power to low power: a low-pitched tone sounds).

Scan

The Scan feature allows you to listen to communication activities on other channels so that you can keep a close track of your team members.

Operation:

1. To enable the feature, press the programmed **Scan** key in standby mode (a high-pitched tone sounds); or
Switch to a channel for which the feature “Auto Scan” is enabled via the programming software.
2. After the feature is enabled, your radio will scan according to the scan list set for the channel on which scanning starts. The scanning process is as follows:
 - During scanning, the LED flashes orange.
 - When activities are detected on a channel, the radio will stay on the channel to receive current activities, and the LED glows green.
 - If you don't want to hear activities on the channel, press the programmed **Nuisance Temporary Delete** key to remove the channel from the scan list temporarily.
 - If you want to continue staying on the channel, press the programmed **Monitor** or **Squelch Off** key during scan stay. 
3. To exit the scanning process, press the programmed **Scan** key again (a low-pitched tone sounds).

Talk Around

This feature allows you to continue communication even when the repeater malfunctions, or when your radio is out of the repeater's range but within the coverage range of other radios.

Operation:

Press the programmed **Talk Around** key to enable the feature (a high-pitched tone sounds). To disable the feature, press this key again (a low-pitched tone sounds).

Monitor

To adjust match conditions for signal receiving, you can enable the feature "Monitor".

Operation:

- ✧ Press the programmed **Monitor** key to enable the feature (a high-pitched tone sounds). To disable the feature, press this key again (a low-pitched tone sounds).
- ✧ Hold down the programmed **Monitor Momentary** key to enable the feature (a high-pitched tone sounds). To disable the feature, release this key (a low-pitched tone sounds).

Squelch Off

If the feature "Squelch Off" is enabled, your radio's speaker will keep unmuted no matter whether carrier is present.

Operation:

- ✧ Press the programmed **Squelch Off** key to enable the feature, and the radio sounds background noise (a high-pitched tone sounds). To disable the feature, press this key again (a low-pitched tone sounds).
- ✧ Hold down the programmed **Squelch Off Momentary** key to enable the feature, and the radio sounds background noise (a high-pitched tone sounds). To disable the feature, release this key (a low-pitched tone sounds).

Adjust Squelch Level

This feature allows you to adjust the squelch threshold required for the radio to unmute.

Generally, “Tight” is used in high noise environment. It requires stronger signal for the radio to unmute. If the squelch level is set to Open, the speaker will keep unmuted irrespective of the satisfaction of decoding conditions.

Operation:

Press the programmed **Adjust Squelch Level** key to switch among Tight, Open and Normal (from Tight to Open, a low-pitched tone and background sound are heard; from Open to Normal, a high-pitched tone is heard and the background sound disappears; from Normal to Tight, a high-pitched tone is heard).

One Touch Call

You can request your dealer to set the **One Touch Call** key. By pressing such programmed key, you can make corresponding services detailed as below:

- Services on the analog channel: to make a call to the 5-Tone or 2-Tone contact.
- Services on the digital channel:
 - To send message to the Group Call contact.
 - To send message or make control services to the Private Call contact.

The control services contain: Alert Call, Radio Check, Remote Monitor, Radio Enable or Radio Disable.

Alert Call

You can send an alert call to a Private Call contact. The called party will see the alert and can call you back.

Radio Check

You can send a Radio Check command to a Private Call contact, so as to confirm whether it is powered on or running on the current channel without disturbing it.

Remote Monitor

You can enable the microphone of a Private Call contact, and monitor its activities or background voices remotely.

Radio Enable

You can enable the radio of a Private Call contact remotely and allow it to be used normally.

Radio Disable

You can disable the radio of a Private Call contact remotely and disallow it to be used normally.

Telemetry



This feature allows you to remotely supervise the device connected with a radio. With this feature, you can control the device and view its status in the case that you are away from the device. The method for supervising the device is programmable by your dealer. The available methods are:

- To supervise the device via the radio

If a device is connected with a radio, you can use another radio to supervise the device. All the radios involved should be configured with the Telemetry feature. For example, the dealer enables the Telemetry feature for both Radio A and Radio B, and assign the Telemetry feature to the **SK** key on Radio A. To supervise the device C, connect it with Radio B, and press the **SK** key on Radio A.

- To supervise the device via a third-party software

If the Telemetry feature is enabled for the radio by your dealer, you can supervise the device connected with the radio via a third-party software.

Roam



This feature allows the radio to communicate between sites in the IP Multi-site Connect system. If enabled, the radio can communicate via any site in the IP Multi-site Connect system, thus ensuring seamless communication in the system.

Operation:

Press the programmed **Roam** key to enable or disable the feature.

Emergency

In case of an emergency, you can use the feature to ask for help from your companion or control center. The Emergency process has the highest priority. You can make emergency operation even when your radio is transmitting or receiving.

To enable the feature on a channel, an emergency system must be assigned to the channel via the programming software. In addition, the Emergency type, Emergency ID type and Emergency mode are settable via the programming software.

Emergency Type

For each Emergency mode, there are four Emergency types available. You can select one of them via

your dealer:

Emergency Type	Description
Siren Only	In Emergency mode, the radio will sound shrill alarm tone.
Regular	In Emergency mode, the radio will give audible and visible indication.
Silent	In Emergency mode, the radio won't give any audible or visible indication.
Silent with Voice	In Emergency mode, the radio won't give any audible or visible indication, but will receive voice ACK from the companion or control center automatically.



Emergency ID Type

Your radio supports two Emergency ID types. You can select one of them via your dealer:

Emergency ID Type	Description
None	No signaling is used when the radio sends alarm information.
HDC1200	HDC1200 signaling is used when the radio sends alarm information.

Emergency Mode

Your radio supports three Emergency modes. You can select one of them via your dealer (Note: For the following operation methods, we take the “Regular” type as an example).

Emergency Mode	Description
Alarm	In this mode, you can send alarm information to your companion or control center by pressing the programmed Emergency key, but you cannot talk with them.
Alarm with Call	In this mode, you can send alarm information by pressing the programmed Emergency key. When the alarm tone disappears (None) or after the Emergency ID is sent (HDC1200), you can speak into the microphone, allowing your

	voice and background noise to be transmitted automatically (you do not need to hold down the PTT key).
Call Only	In this mode, press the programmed Emergency key to go to the Revert Channel, and speak into the microphone, allowing your voice and background noise to be transmitted automatically (you do not need to hold down the PTT key).

Operation Methods for Analog Emergency



■ Alarm (None & HDC1200)

Operation: Press the programmed **Emergency** key to send alarm information, and the LED glows red. (None: If "Local Emergency Alarm" is enabled via the programming software, an alarm tone will sound.)

The following methods are available for you to exit the Emergency mode:

1. Once the Alarm Cycles expire, the radio will exit the Emergency mode automatically.
2. Long press the programmed **Emergency** key.
3. Hold down the **PTT** key. The radio will transmit on the channel on which the radio operates before entering the Emergency mode. (HDC1200)

■ Alarm with Call (None & HDC1200)

Operation:

1. Press the programmed **Emergency** key to send alarm information, and the LED glows red. (None: If "Local Emergency Alarm" is enabled via the programming software, an alarm tone will sound.)
2. When the alarm tone disappears (None) or after the Emergency ID is sent (HDC1200), you can speak into the microphone to make an emergency call.
3. When the LED flashes orange, your radio is receiving.

Two methods are available for you to exit the Emergency mode:

1. After the preset Alarm Cycles and Voice Cycles expire, the radio will exit the Emergency mode automatically. (None)
2. Long press the programmed **Emergency** key.

■ Call Only (HDC1200)

Operation:

1. Press the programmed **Emergency** key to go to the Revert Channel, and the LED glows red.
2. If the feature “Alarm with Call to Follow” is enabled, you can speak into the microphone to make an emergency call when the LED glows red.
3. When the LED flashes orange, your radio is receiving.

To exit the Emergency mode, long press the programmed **Emergency** key.



Note: Your dealer may set the number of alarm cycles and alarm duration (None), number of polite retries and impolite retries (HDC1200), number of voice cycles, duration of each transmission and TX interval.



Operation Method for Digital Emergency

■ Alarm

Operation: Press the programmed **Emergency** key to send alarm information. At this time, the LED glows red.

Two methods are available for you to exit the Emergency mode:

1. Once the Alarm Cycles expire, the radio will exit the Emergency mode automatically.
2. Long press the programmed **Emergency** key.

■ Alarm with Call

Operation:

1. Press the programmed **Emergency** key to send alarm information. At this time, the LED glows red.
2. When the LED solidly glows red, you can speak into the microphone to make an emergency call.
3. When the LED flashes orange quickly, you can receive. And when a call is received, the LED glows green solidly.
4. If the preset Voice Cycles expire, you can press the **PTT** key to make the emergency call again (the LED glows red). Release the **PTT** key to receive (the LED flashes orange quickly); when a call is received, the LED glows green solidly.

To exit the Emergency mode, long press the programmed **Emergency** key.

■ Call Only

Operation:

1. Press the programmed **Emergency** key to go to the Revert Channel.
2. If the feature “Alarm with Call to Follow” is enabled, you can speak into the microphone to make an emergency call when the LED glows red.
3. When the LED flashes orange, your radio is receiving.

If the preset Voice Cycles expire, you can hold down the **PTT** key to make the emergency call again (the LED glows red). After the emergency call is transmitted, please release the **PTT** key to receive.

To exit the Emergency mode, long press the programmed **Emergency** key.



Note: Your dealer may set the number of polite retries and impolite retries, number of voice cycles, duration of each transmission and TX interval.

Man Down

With this feature, your radio will alarm automatically to summon help from your companion if it is positioned aslant for a certain time period.

Operation:

1. To enable the feature,
 - Press the programmed **Man Down** key (a high-pitched tone sounds); or
 - Turn on the radio if the feature is enabled via the programming software.
2. Your radio will sound a pre-alert tone if it is positioned aslant for a preset time period, and will enter the Emergency mode if you do not place it vertically within such time period. To exit the Emergency mode, please place it upright.
3. To disable the feature,
 - Press the programmed **Man Down** key (a low-pitched tone sounds).

Scrambler /Encrypt

The Scrambler/Encrypt feature can encrypt your audio signals to prevent eavesdropping. Thus privacy of your communication is guaranteed.

Operation:

- Press the programmed **Scrambler/Encrypt** key to enable Scrambler or Encrypt on the current channel (a high-pitched tone sounds); press the key again to disable the feature (a low-pitched tone

sounds).

- If the Scrambler/Encrypt feature is enabled for a channel via the programming software, switch to the channel to enable the feature, or exit the channel to disable the feature.

Lone Worker

This feature is ideal for persons who work lonely. If you encounter an incident and cannot operate your radio within the preset time period, your radio will alarm automatically to summon help from your companion.

Operation:

1. To enable the feature,
Press the programmed **Lone Worker** key (a high-pitched tone sounds); or
Turn on the radio if the feature is enabled via the programming software.
2. If you cannot operate your radio within a preset response period, your radio will give alerts before this period expires (dependent on the settings by your dealer). At this time, you can terminate such alerts by rotating a knob or pressing a key. When the response period expires, your radio will trigger the current emergency system automatically.
3. To disable the feature,
Press the programmed **Lone Worker** key (a low-pitched tone sounds).



Note: If the Lone Worker feature is not disabled before your radio is powered off, it will remain enabled when powered on again.

Battery Strength Indicator

This feature allows you to know the current battery strength.

Operation:

Hold down the programmed **Battery Strength Indicator** key, and the radio will give a specific indication to represent the current battery strength. Release the key to exit.

Indication	Battery Strength
Green LED glows.	High
Orange LED glows.	Medium
Red LED glows.	Low

Red LED glows and the low battery alert sounds.	Insufficient
---	--------------

Busy Channel Lockout

If enabled via the programming software, this feature can prevent your radio interfering with other transmitting terminals on the same channel. If you hold down the **PTT** key while the channel is in use, your radio will keep beeping, alerting you to transmission prohibition. To stop beeping, please release the **PTT** key. When the channel is free, you can press and hold down the **PTT** key to transmit.

Time-out Timer (TOT)

The purpose of TOT is to prevent any user from occupying a channel for an extended period. If the preset time expires, the product will automatically terminate transmission and keep beeping. To stop beeping, please release the **PTT** key. You must wait for a certain time period (preset by your dealer) to initiate another transmission.

If the pre-alert function is set by your dealer, your radio will alert you to the TOT expiration in advance.



Note: This feature is null in Emergency mode.

Pseudo Trunking



If enabled via the programming software, If your radio operates on a channel with this feature enabled and one time slot is already occupied, it can transmit and receive on the other free time slot, allowing you to communicate timely under emergent situations.

MIC AGC

If enabled via the programming software, your product will process the audio signals during transmission, providing improved audio for the receiving product.

Radio Registration Service



If enabled via the programming software, your radio will automatically register in the system within a certain period after power-on. Then it can acquire online information of other radios via accessing specific

servers within the valid registration period.

GPS Revert

If enabled via the programming software, your registered radio will transfer its positioning information to the system when the system requires such information.

Troubleshooting

Phenomena	Analysis	Solution
The product can not be powered on.	The battery may be improperly installed.	Remove the battery and attach it again.
	The battery may run out.	Recharge or replace the battery.
	The battery may suffer from poor contact caused by dirtied or damaged battery contacts.	Clean the battery contacts. If the problem can not be solved, contact your dealer or authorized service center for inspection and repair.
During receiving signals, the voice is weak, discontinuous or totally inactive.	The battery strength may be too low.	Recharge or replace the battery.
	The volume may be set to a low level.	Increase the volume.
	The antenna may get loose or may be improperly installed.	Power off the product, and re-install the antenna.
	The speaker may be blocked or damaged.	Clean surface of the speaker. If the problem can not be solved, contact your dealer or authorized service center for inspection and repair.
You can not	The frequency or signaling	Set your TX/RX frequency and signaling to

communicate with other members.	may be inconsistent with that of other members.	the same as that of other members.
	The channel type (digital/analog) may be set inconsistently.	Make sure all members are on the same digital/analog channel.
	You may be too far away from the group members.	Move towards other members.
Irrelevant communication or noise is heard on the channel.	You may be interrupted by products using the same frequency.	Change the frequency, or adjust the squelch level.
	The product may be set with no signaling.	Set signaling for all member products to avoid interference at the same frequency.
The noise is too loud.	You may be too far away from other members.	Move towards other members.
	You may be at an unfavorable position. For example, your communication may be blocked by high buildings or frustrated in the underground areas.	Move to an open and flat area, and restart the product.
	You may suffer from external disturbance (such as electromagnetic interference).	Stay away from equipment that may cause interference.
The GPS cannot locate your position.	No GPS signal is received.	Move to an open and flat area, and restart the product.
The Bluetooth cannot be paired.	The battery power for the Bluetooth may run low.	Charge the Bluetooth.
	The Bluetooth may be too	Move the Bluetooth towards the product.

	far away from the product.	
--	----------------------------	--

If the above solutions can not fix your problems, or you may have some other queries, please contact us or your local dealer for more technical support.

Care and Cleaning

To guarantee optimal performance as well as a long service life of the product, please follow the tips below.

Product Care

- Do not pierce or scrape the product with any edged instruments or hard objects.
- Keep the product far away from substances that can corrode the circuit.
- Do not hold the product by its antenna or earpiece cable directly.
- Attach the accessory jack cover when the product is not in use.

Product Cleaning

- Clean up the dust and fine particles on the product surface and charging piece with a clean and dry lint-free cloth or a brush regularly.
- Use neutral cleanser and a non-woven fabric to clean the keys, control knobs and front case after long-time use. Do not use chemical preparations such as stain removers, alcohol, sprays or oil preparations, so as to avoid surface case damage. Make sure the product is completely dry before use.



Caution: Power off and remove the battery before cleaning.