ATTACHMENT E.

- USER'S MANUAL -



Type No. L17C00000

Model. L73D

Dual Function Monitor

User's Guide



U.S.A.

U.S.FEDERAL COMMUNICATIONS COMMISSION RADIO FREQUENCY INTERFERENCE STATEMENT INFORMATION TO THE USER

NOTE : This equipment has been tested and found to comply with the limits for a Class B digital device pursuant to Part 15 of the FCC Rules.

These limits are designed to provide reasonable protection against harmful interference in a residential installation.

This equipment generates, uses, and can radiate radio frequency energy and, if not installed and used in accordance with the instructions, may cause harmful interference to radio communications.

However, there is no guarantee that interference will not occur in a particular installation.

If this equipment does cause harmful interference to radio or television reception, which can be determined by turning the equipment off and on, the user is encouraged to try to correct the interference by one or more of the following measures:

- Reorient or relocate the receiving antenna.
- Increase the separation between the equipment and receiver.
- Connect the equipment into an outlet of a circuit different from that to which the receiver is connected.
- Consult the dealer or an experienced radio/TV technician for assistance.

Changes or modification not expressly approved by the party responsible for compliance could void the user's authority to operate the equipment.

Connecting of peripherals requires the use of grounded shielded signal cables.

DECLARATION OF CONFORMITY

WE **Hyundai ImageQuest CO., LTD.**
Ami-ri Bubal-Eub Ichon-Si Kyungki-Do
467-860 KOREA

declare under our sole responsibility that the product:

Kind of equipment : LCD MONITOR

Type-Designation : L17C00000

to which this declaration relates is in conformity with the following standard(s) or other normative document(s)

Safety : EN60950-1:2002
EMC : EN 55022/1998+A1:2000+A2:2003
EN 55024 :1998+A1:2001+A2:2003
EN 61000-3-2:2000
EN 61000-3-3:1995+A1:2001

following the provisions of the Low Voltage Directive 73/23/EEC, 93/68/EEC and the EMC Directive 89/336/EEC.

Accredited testlaboratory:
TÜV Rheinland
Am Grauen Stein
51105 Köln

KOREA / May 16, 2005

(Place and date of issue)

HONG KI, KIM 

(Name and signature of authorized person)

L73D 17" Dual Function Monitor

Contents

- 1. Introduction1/22
- 2. Safety Information1/22
- 3. Installing the monitor4/22
 - 3-1. Packing List4/22
 - 3-2. Selecting a suitable location5/22
 - 3-3. Connecting the monitor5/22
 - 3-4. Setting the refresh rate8/22
 - Preset Timing Table9/22
 - 3-5. User's Environment10/22



- 4. Adjusting the picture12/22
 - 4-1. Using the On Screen Display14/22
 - 4-2. Direct access buttons14/22
 - 4-3. OSD Adjustments15/22
- 5. Display power management18/22
 - Reducing power consumption18/22
- 6. Troubleshooting19/22
- 7. Specifications22/22



L73D

17" Dual Function Monitor

1. Introduction

This manual contains instructions for installing and operating Hyundai ImageQuest L73D.

Hyundai ImageQuest L73D is a highly ergonomic color display unit.

- 17" viewable SXGA LCD
- High quality screen re-scaling capability
- 100-240V AC input voltage
- VESA DPMS (Display Power Management Signaling)
- VESA DDC1/2B compatibility
- Advanced digital On-Screen-Display controls
- Digital Signal Input by DVI-1.0 Compatability
- Fast and accurate auto adjustment
- Most advanced image scaling
- Supporting VESA Flat Panel Monitor Physical Mounting Interface

2. Safety Information

This Monitor has been engineered and manufactured to assure your safety. You can prevent serious electrical shock and other hazards by keeping in mind the following:



Do not place anything wet on the monitor or the power cord. Never cover the ventilation openings with any material and never touch them with metallic or inflammable materials.

L73D 17" Dual Function Monitor

Avoid operating the monitor in extreme heat, humidity or areas affected by dust.
Temperature : 5~35°C
Humidity : 30~80RH

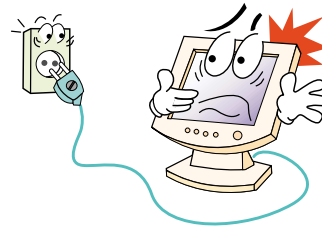

Be sure to turn the monitor off before plugging the power cord into the socket. Make sure that the power cord and the other cords are securely and rightly connected.

Overloaded AC outlets and extension cords are dangerous, as are frayed power cords and broken plugs, which may cause electric shock or fire. Call your service technician for replacement.

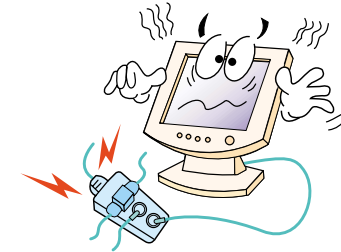

Do not use sharp tools such as a pin or a pencil near the monitor, as they may scratch the LCD surface.



Do not use a solvent, such as benzene, to clean the monitor, as it will damage the LCD surface.

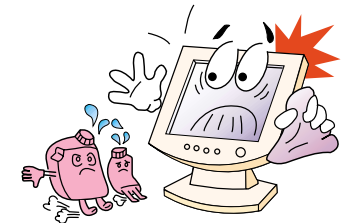

L73D

17" Dual Function Monitor

Cleaning and Maintenance

- To avoid risk of electric shock, do not disassemble the display unit cabinet. The unit is not user-serviceable. Remember to unplug the display unit from the power outlet before cleaning.
- Do not use alcohol (methyl, ethyl or isopropyl) or any strong dissolvent. Do not use thinner or benzene, abrasive cleaners or compressed air.
- Do not wipe the screen with a cloth or sponge that could scratch the surface.
- To clean your antistatic screen, use water and a special microfiber screen cleaning tissue used in optical lens cleaning, or lightly dampen a soft, clean cloth with water or a mild detergent.
- If the instructions above do not help in removing stains, contact an authorized service agent.

L73D

17" Dual Function Monitor

3. Installing the monitor

3-1. Packing List

The following items should be found in the packaging.

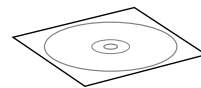

Compact Disc



Cable Holder

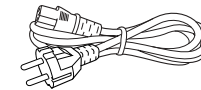

Power Cord

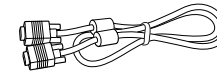

Signal Cable

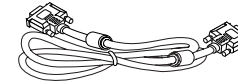

DVI-D Cable

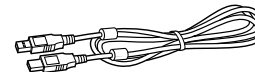

USB Cable

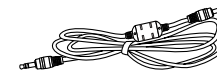

Audio Cable



UK



Japan



America/Canada



Europe



South Africa



Australia



Korea

- !** Above power cord can be changed upon different voltage areas. Please contact your dealer if anything is missing or damaged.
Other power cord except the cord packed in the product or longer than 3m may affect EMC of the product in operating condition.

L73D

17" Dual Function Monitor

3-2. Selecting a suitable location

- Place the monitor at least 30cm from other electrical or heat-emitting equipment and allow at least 10cm on each side for ventilation.
- Place the monitor in a position where no light shines directly onto or is reflected on the screen.
- To reduce eye strain, avoid installing the display unit against a bright background such as a window.
- Position the monitor so that the top of the screen is no higher than eye level.
- Position the monitor directly in front of you at a comfortable reading distance (around 45 to 90cm)

3-3. Connecting the monitor

- 15 pin D-sub / DVI-D

! Before you start cabling your monitor, check that the power is off on all units. To avoid any possibility of electric shock, always connect your equipment to properly earthed outlets.

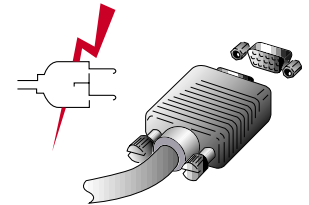

1. Insert the other 15-pin/DVI-D signal cable connector into the 15-pin VGA/DVI-D connection on your computer and screw it down.
2. Plug the power cord connection to connection on the monitor.
3. Plug the other end of the power cord to your computer's main supply or to a 100V-240V earthed electrical outlet.
4. Turn on the monitor using the power switch and check that the power LED is on. If not, repeat steps 1,2,3 and 4 or refer to the Troubleshooting section of this guide.

L73D

17" Dual Function Monitor

5. Turn on the power to the computer. The picture will appear within about 10 seconds. Adjust the picture to obtain optimum picture quality. See section Adjusting the picture in this guide for more information.

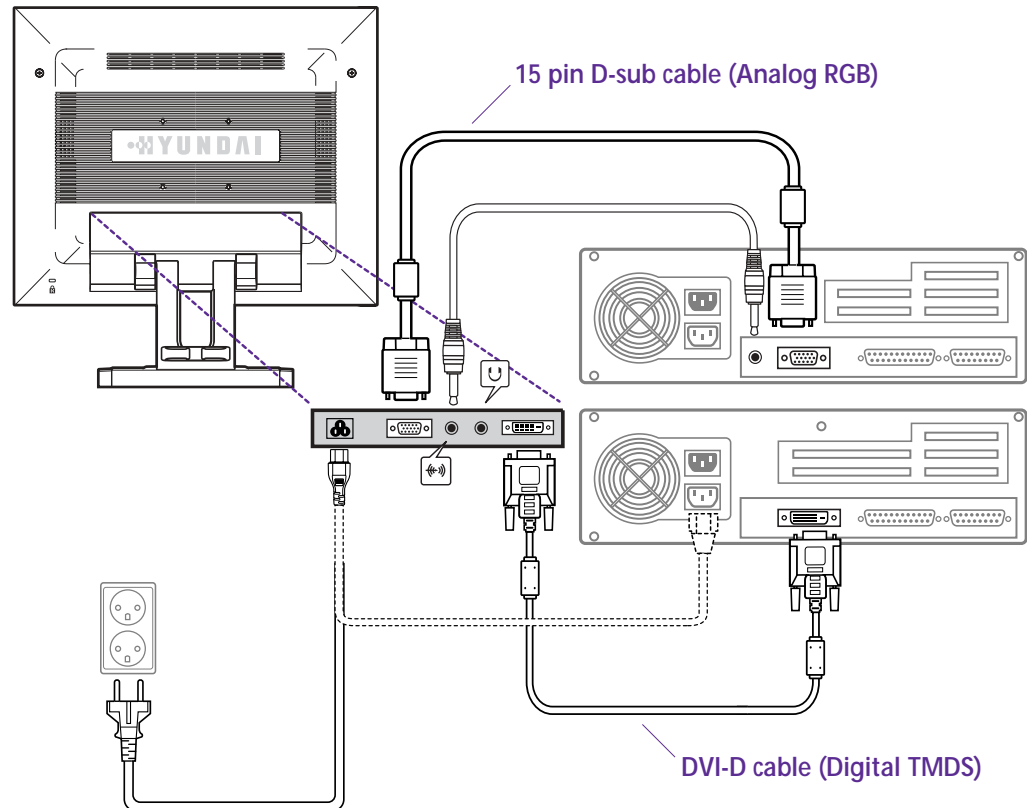

L73D 17" Dual Function Monitor

• USB hub / PC Audio

The USB hub(Bus-powered mode hub) have 1 upstream port and 2 downstream ports. The upstream port can be connected to the root hub of host PC or other downstream port. Two(2) downstream ports allow to connect another USB device such as USB mouse, joystick, printer etc.

- 1) The maximum supply current of downstream port is 500mA when bus-powered mode hub.
- 2) To activate the USB hub, your host system should have USB capability.

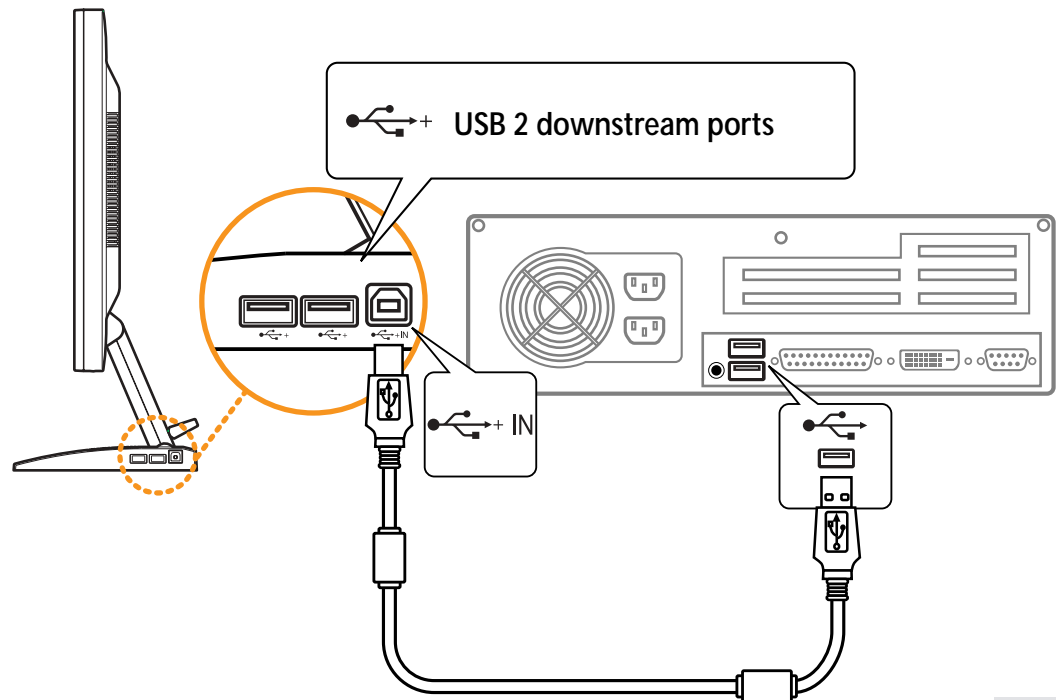

L73D

17" Dual Function Monitor

3-4. Setting the refresh rate

Follow the instructions below to set your refresh rate in Windows 98/ME/XP/2000.

1. Go to the configuration window(Start-Settings-Configuration window).
2. Double click on the 'Display' icon.
3. Click on the 'Settings' tab.
4. Click on the 'Advanced' button.
5. Click on 'Adapter' and select 60Hz from the list.
6. Click on 'Apply' to accept the selected value.



L73D

17" Dual Function Monitor

Preset Timing Table

! If the signal from the system doesn't equal to the preset timing mode, adjust the mode with reference to the user guide of videocard because the screen may not be displayed.

▶ DIGITAL R.G.B INPUT

No.	Resolution	Horizontal Frequency	Refresh rate
1	640 x 480	31.5 KHz	60 Hz
2	800 x 600	37.9 KHz	60 Hz
3	1024 x 768	48.4 KHz	60 Hz
4	1280 x 1024	63.9 KHz	60 Hz

The recommended setting is a resolution of 1280x1024 and a refresh rate of 60Hz.

▶ ANALOG R.G.B INPUT

No.	Resolution	Horizontal Frequency	Refresh rate
1	720 x 400	31.5 KHz	70 Hz
2	640 x 480	31.5 KHz	60 Hz
3	640 x 480	37.5 KHz	75 Hz
4	800 x 600	35.2 KHz	56 Hz
5	800 x 600	37.9 KHz	60 Hz
6	800 x 600	48.1 KHz	72 Hz
7	800 x 600	46.9 KHz	75 Hz
8	832 x 624	49.7 KHz	75 Hz
9	1024 x 768	48.4 KHz	60 Hz
10	1024 x 768	56.5 KHz	70 Hz
11	1024 x 768	60.0 KHz	75 Hz
12	1152 x 864	67.5 KHz	75 Hz
13	1280 x 1024	63.9 KHz	60 Hz
14	1280 x 1024	80.0 KHz	75 Hz

3-5. User's Environment

Recommended Ergonomic User's Environment

- Viewing angle of the monitor should be between -3~20 degree.

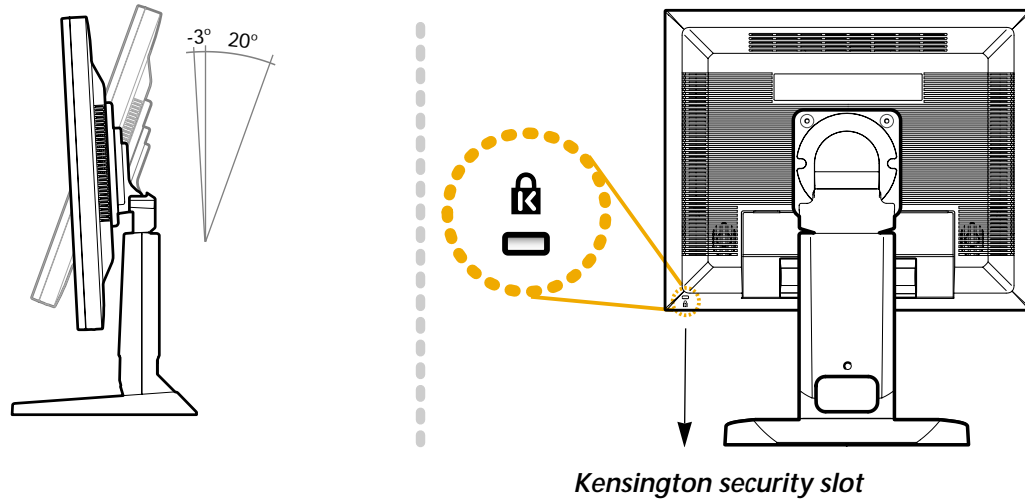

Kensington Security (Locking) Slot

- This display unit supports a Kensington-type security device to secure your monitor. Kensington lock is not included.
- To purchase and install the Kensington locking device, please refer to the following contact information.

*** Kensington Technology Group**

· Address : 2000 Alameda de las Pulgas 2F san mateo, California 94403-1289

· Tel : +1 650 572 2700 · Fax : +1 650 572 9675 · Web-site : www.kensington.com

L73D

17" Dual Function Monitor

VESA MOUNT'G

- This display unit supports VESA FPMPMI standard for 75mmx75mm screw mounting by giving 4 screw holes inside the base stand of the unit.
- For buying VESA Flat Panel Monitor Mounting Devices, please contact following information.

** Ergotron, Inc.*

*· Address : Ergotron Europe Kuiperbergweg 50 1101 AG Amsterdam The Netherlands
· Tel : +3 1 20 696 60 65 · Fax : +3 1 20 609 04 59 · E-mail : info.eu@ergotron.com*

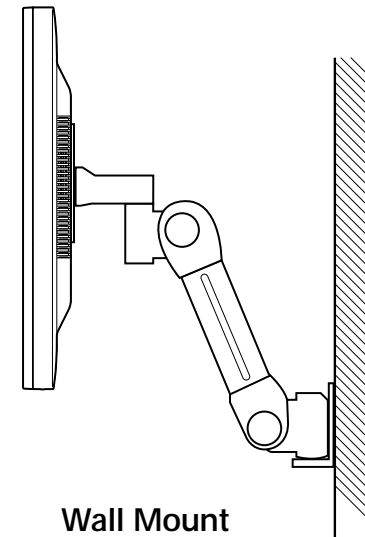
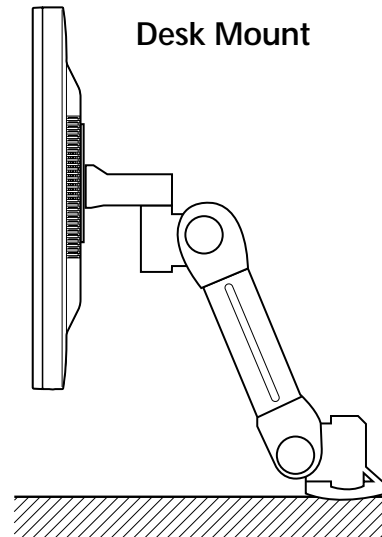

L73D 17" Dual Function Monitor

4. Adjusting the picture

You can adjust the screen display by using the buttons located below the screen.

► In case of applying Analog RGB Input



L73D 17" Dual Function Monitor

► In case of applying Digital TMDS Input

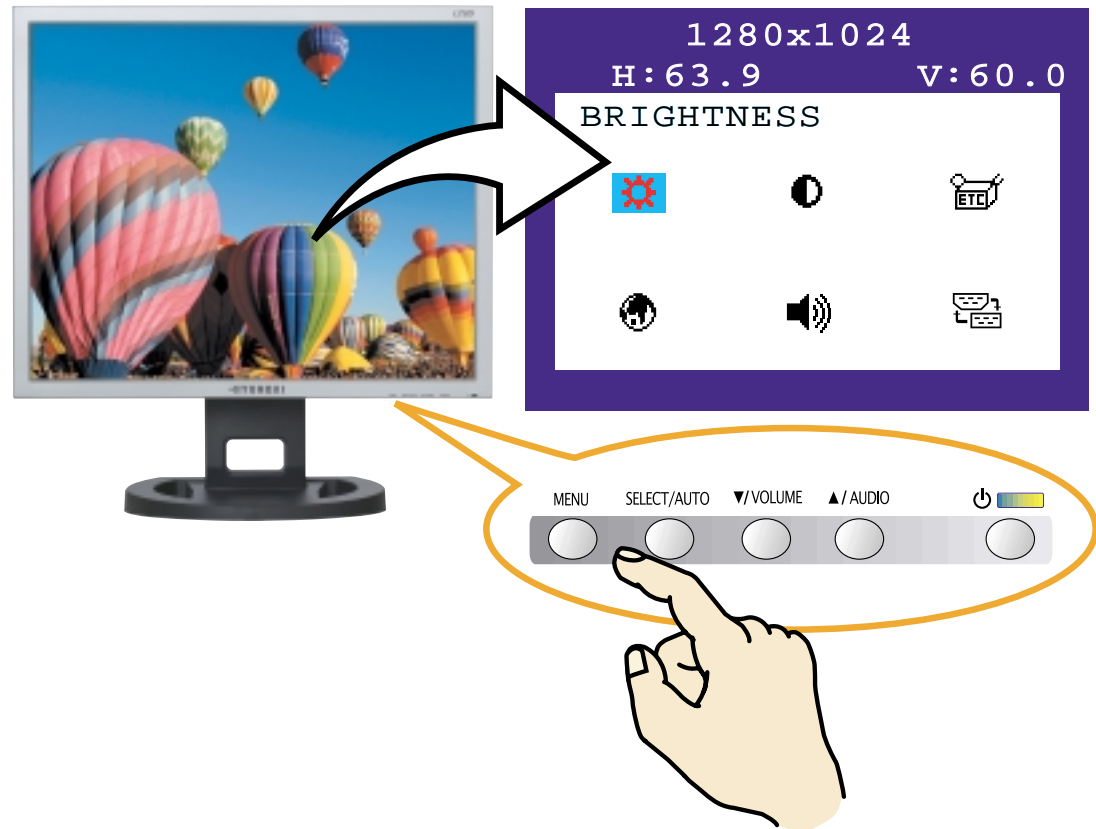

L73D

17" Dual Function Monitor

4-1. Using the On Screen Display

1. Push the MENU button to call the OSD to the screen. The resolution and frequency are displayed at the top of the menu box for your information.
2. Push the ▼ or ▲ button to choose the item you want to adjust. The selected item is highlighted.
3. Push the SELECT button to adjust the highlighted item.
4. Use the ▼ or ▲ button to adjust the selection.
5. Push the MENU button to return to the previous menu if you are in a submenu.
6. The display unit automatically saves the new settings in 1 second after your last adjustments and the menu disappears. You can also push the MENU button to make the menu disappear.

4-2. Direct access buttons

- AUTO** **AUTO ADJUST**
At first display a full screen such as Window's back ground.
Push the button SELECT(AUTO) to adjust the shape of screen automatically.
- VOLUME** **VOLUME**
Use the button ▼ to select the volume adjustment.
Adjust with ▼ or ▲ button.
- AUDIO** **AUDIO**
Push the button ▲ to choose audio on or off.

L73D

17" Dual Function Monitor

4-3. OSD Adjustments

The OSD adjustments available to you are listed below.



BRIGHTNESS

Adjust the brightness of the screen.



CONTRAST

Adjust the contrast of the screen.



COLOR CONTROL

Color temperature affects the tint of the image. With lower color temperatures the image turns reddish and with higher temperatures bluish.

There are three color settings available BLUISH, REDDISH or USER. With the USER setting you can set individual values for red, green and blue.



POSITION

H POSITION

Adjusts the horizontal position of the entire screen image.

V POSITION

Adjusts the vertical position of the entire screen image.

L73D

17" Dual Function Monitor

BACK

NEXT



CLOCK PHASE

PHASE

Adjust the noise of the screen image.

CLOCK

Adjust the horizontal size of the entire screen image.



MISCELLANEOUS

RECALL

Recall the saved color data.

OSD TIMER

You can set the displayed time of OSD Menu window on the screen by using this adjustment.

OSD POSITION

Adjust the OSD menu's horizontal or vertical position on the screen.

AUTO COLOR

Optimum color setting is auto programmed for user's convenience.



LANGUAGE

You can select the language in which adjustment menus are displayed. The following languages are available : English, French, German, Italian, Spanish, Swedish, Finnish, Danish, Portuguese, Dutch (Option Korean, Japanese, chinese, Russian)

Q17+

17" Dual Function Monitor

BACK

NEXT



AUDIO VOLUME

Adjust the audio volume level.

AUDIO

This menu is used to choose audio on or off.



AUTO ADJUST

You can adjust the shape of screen automatically at the full screen pattern.



INPUT SELECT

This menu used to choose the desired input signal source.
There are two available signal source.

- Analog R.G.B : 15 pin D-sub, Analog Signal
- Digital TMDS : 24 pin DVI-D, Digital Signal



In case of applying Digital TMDS Input, the functions of Color Control, Auto Adjust, Position, Clock Phase, Auto Color are not supported.

L73D

17" Dual Function Monitor

5. Display power management

Reducing power consumption

If the power management function of your computer is enabled, your monitor turns on and off automatically. You can control power management features from your computer.

Your computer may have power management features which enable the computer or monitor to enter a power saving mode when the system is idle. You can reactivate the system by pressing any key or moving the mouse.

Mode	LED	Power consumption
Normal	Blue	45 W(Max)
off	Orange	≤ 1 W(Typ, 230V AC)
Unplugged	Not illuminated	0 W

! The power button does not disconnect the monitor from the mains. The only way to isolate the monitor completely from the mains supply is to unplug the mains cable.

L73D

17" Dual Function Monitor

6. Troubleshooting

If your monitor is not functioning properly, you may be able to solve the problem by following the suggestions below :

Problem	Possible solution
Blank screen	<p>If the power LED is not lit, push the Soft power switch or check the AC cord to turn the monitor on. If the display unit is powered through the computer, check that the computer is switched on.</p> <p>The display unit might be in standby mode. Push one of the keyboard keys. Check that the keyboard is properly connected to the computer.</p> <p>Check that the signal cable connector is properly connected and that the connection pins are not bent or damaged. If the connector is loose, tighten the connector's screws.</p> <p>Check that the power cable is correctly connected to the display unit and to the power outlet.</p>
Error message: <i>Video mode not supported</i>	<p>Check the resolution and the frequency on the video port of your computer.</p> <p>Compare these values with the data in the Preset Timing Table.</p>
The display does not enter power management mode	<p>The video signal from the computer does not comply with VESA DPMS standard. Either the computer or the graphics adapter is not using the VESA DPMS power management function.</p>

L73D

17" Dual Function Monitor

Problem	Possible solution
Color defects	Check that the signal cable connector is properly connected and that the connection pins are not bent or damaged. Try another color temperature.
Size, position, shape or quality unsatisfactory	Adjust the picture characteristics as described in the section <i>OSD Adjustment(4-3)</i> .
Duplicated images	A problem with your graphics adapter or display unit. Contact your service representative.
Image is not stable	Check that the display resolution and frequency from your PC or graphic adapter is an available mode for your monitor. In your PC, you can check through Control panel, Display, Settings. If the setting is not correct, use your computer utility program to change the display settings.
Message : <i>No signal</i>	Check that the signal cable connector is properly connected and that the connection pins are not bent or damaged. If the connector is loose, tighten the connector's screws. Check that the computer is switched on.
The power LED is a orange color	To enter a power saving mode. You can reactivate the system by pressing any key or moving the mouse.

L73D

17" Dual Function Monitor

Problem	Possible solution
The power LED is a orange color	<p>LED Indicator can be orange color on changing of video mode or Input Signal.</p> <p>Check the Resolution and the frequency on the video part of your computer. Compare these values with the data in the Preset Timing Table.</p>

Contacting service

If the above troubleshooting hints do not help you find a solution to the problem, contact an authorized service agent. If the monitor is sent for service, use the original package if possible.

Unplug the display unit from the power outlet and contact a service agent when:

- The monitor does not operate normally according to the operating instructions.
- The monitor exhibits a distinct change in performance.
- The monitor has been dropped or the cabinet has been damaged.
- The monitor has been exposed to rain, or water or liquid has been spilled onto the monitor.

L73D

17" Dual Function Monitor

7. Specifications

LCD	17"viewable, Diagonal, A-Si TFT
Pixel pitch	0.264 x 0.264 mm
Display area	337.92 x 270.33 mm
Number of color	16,2 million colors
Input signals	R.G.B Analog, Digital TMDS(DVI-D)
Frequency rate	Horizontal : 31.0 to 80.0KHz, Vertical : 56 to 75Hz
Maximum bandwidth	135 MHz
Maximum resolution	R.G.B Analog : 1280 x 1024@75Hz Digital TMDS : 1280 x 1024@60Hz
Recommanded resolution	1280 x 1024@60Hz
Input voltage	100-240V AC, 1.0A
Power consumption	45W(Max)
Power management	VESA DPMS
Plug & Play	VESA DDC 1/2B
OSD menu	BRIGHTNESS, CONTRAST, COLOR CONTROL, POSITION, CLOCK-PHASE, MISCELLANEOUS, LANGUAGE, AUDIO, AUTO ADJUST, INPUT SELECT
Built in Speaker	2ch x 2watts/Ear phone Jack
VESA FPMPMI	75 x 75 mm screw mounting
Ergonomics, Safety and EMC	TCO FCC Class B, CE, cTÜVus, TÜV-GS
Operating Temperature	5 ~ 35°C
Weight	4.4Kg unpacked, 6.2Kg packed
Dimensions (W X H X D mm)	373X 420 X 200mm

- Specification is subject to change without notice for performance improvement.
- Hyundai ImageQuest's specification on "dead pixel" of LCD Panel applies to ISO 13406-2 Standard.