

ATTACHMENT E -1.

- USER'S MANUAL -

FCC Information

User Instructions

The Federal Communications Commission Radio Frequency Interference Statement includes the following warning :

NOTE : This equipment has been tested and found to comply with the limits for a Class B digital device pursuant to Part 15 of the FCC Rules.

These limits are designed to provide reasonable protection against harmful interference in a residential installation. This equipment generates, uses, and can radiate radio frequency energy and, if not installed and used in accordance with the instructions, may cause harmful interference to radio communications. However, there is no guarantee that interference will not occur in a particular installation.

If this equipment does cause harmful interference to radio or television receptions, which can be determined by turning the equipment off and on, the user is encouraged to try to correct the interference by one or more of the following measures :

- Reorient or relocate the receiving antenna.
- Increase the separation between the equipment and receiver.
- Connect the equipment into an outlet on a circuit different from that to which the receiver is connected.
- Consult the dealer or an experienced radio/TV technician for assistance.

User Information

Changes or modifications not expressly approved by the party responsible for compliance could void the user's authority to operate the equipment.

Connecting of peripherals requires the use of grounded shielded signal cables.

DECLARATION OF CONFORMITY

WE HYUNDAI ImageQuest CO., LTD.
Ami-ri Bubal-Eub Ichon-Si Kyungki-Do
467-860 KOREA

declare under our sole responsibility that the product:

Kind of equipment : LCD TV

Type-Designation : LT17AW000 / LT20A0000

to which this declaration relates is in conformity with the following standard(s) or other normative document(s)

Safety : EN 60950 : 2000
EMC : EN 55022 : 1998+A1 : 2000 Class B
EN 55024 : 1998+A1 : 2001
EN 61000-3-2 : 2000, EN 61000-3-3 : 1995+A1 : 2001

following the provisions of the Low Voltage Directive 73/23/EEC, 93/68/EEC and the EMC Directive 89/336/EEC.

Accredited testlaboratory:
TÜV Rheinland
Am Grauen Stein
51105 Köln

KOREA /MAY. 15, 2004
Place and date of issue

HONG KI, KIM
*(Name and signature of
authorized person)*

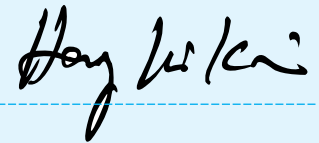

Important Tips

Image Retention effect(Image Sticking) —

1. Cause :

- Image Retention Effect could be come from displaying a still picture in certain period of time with at a certain area continuously, as the feature of LCD TV panel.
- This is the same matters to other companies' LCD TV panel products, too.

2. Prevention :

- To avoid this matter, use the product after reducing brightness and contrast, especially a still image is displaying for a long time. (Example : Contrast 25, Brightness 25 - See the page 34)
- Once Image retention occurs, change the mode into Video mode which displays more motion pictures. It will help reduce this matter, but cannot completely eliminate once it occurs. It makes the screen's brightness worse as displaying a fixed pattern often.

3. Solution :

- The temporary image sticking would decrease with displaying Full-White pattern after 10 hours.
- The permanent image sticking couldn't take off under the latest technology even though being in its manufacturer.

4. Notice :

- It is very important to notify every buyer/customer this information and All Branches/Buyers /Customers should be fully aware of this.
- Image Sticking in LCD TV panel products couldn't get the support from a manufacturer, and does not come under the warranty.

Second Tips —

• Pixel Defect :

LCD TV panel is made of a group of refined pixels (cells). The Panel, in which 99.9% of pixels have approved, is a normal product. Therefore, only a few of abnormal pixels may appear, however, this has no influence upon LCD TV panel performance.

* Specification on 'dead pixel' of LCD panel applies to ISO13406-2 Standard.

Image Sticking Precaution

Still Image Wide/4:3 in motion Image —

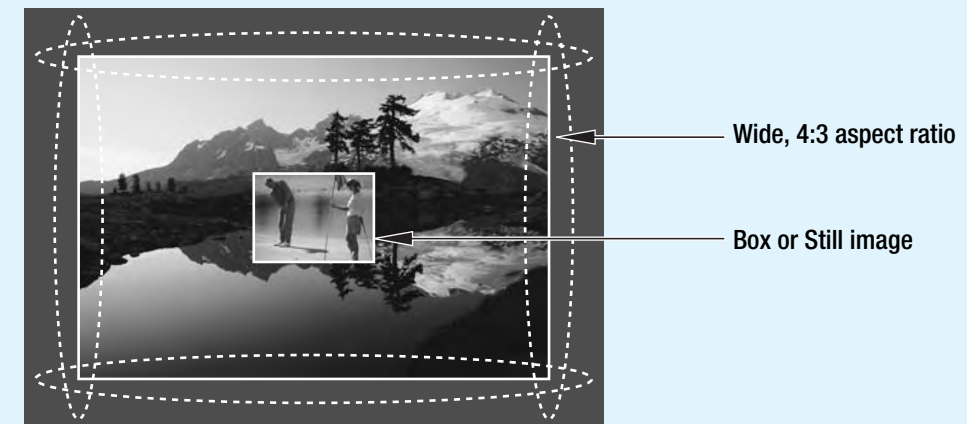

• Precaution :

- Image Sticking could be come from Still Image and Boundary line for a long time display and Brightness gap in Boundary.
- This Matter(Image Sticking) is same thing under the other LCD TV's Company.
- Still Image/Letter in watching TV also will be effect to Image sticking.
- *This matter(Image Sticking) is out of warranty.

Features

A Wide Array of Screen Settings

You can choose different screen settings depending on the type of program you are watching or the surrounding conditions (the lighting or the outside weather conditions).

You can switch among Dynamic, Mild and Standard, or you can configure the screen settings for yourself.

A Wide Array of Sound Settings

You can choose an optimal sound setting for the type of program you are watching.

You can switch among Standard, Music, Movie and News, or you can configure the settings for yourself.

다양한 화면 구현 기능

일반화면(4:3), 와이드(16:9), 줌 등 다양한 화면크기를 구현합니다.

PIP(Picture In Picture), POP(Picture Of Picture), Multi(9분할) 등 다양한 화면을 구현합니다.

V-Chip

The V-Chip feature locks out programs that are deemed inappropriate for children.

Closed Captions Function

This is to displays the closed captions that are broadcast with certain TV shows.

Surround Audio Function

You can listen to dynamic and surround sound only with ordinary speaker

Auto ON/OFF Function

This function allows you to turn on/off your LCD TV at the preset time.

Table of Contents

General Information

Safety Precaution	5
Contents of the Package	11
How to Use the Kensington Security Slot	12
How to Use the Rear Cap and Cable Holder	13
How to Adjust the View Angle	14
How To Install Wall Mount Support	15
How To Install Wall Mount Frame	16
Parts Names and Functions	17
Remote Control	19

Connections

Connecting Indoor/Outdoor TV Antenna(UHF/VHF)	23
Connecting to the Antenna Input Connection on the External Equipment	24
Before connecting the video connections to external devices	25
Connecting a VCR, Cable/Satellite Receiver	26
Connecting a DTV Receiver or DVD Player	27
Playing Back a Tape Recorded On a Camcorder	28
Connecting to a PC	29
Resolutions Supported in PC	30

Picture Setup

How to Select the Picture Mode	33
How to Set the Desired Picture	34
How to Set Noise Reduction	35
How to Set PIP [Mode]	36
How to Set POP [Mode]	36
How to Set Multi [Mode]	37
How to Select the Aspect Ratio	39

Sound Setup

How to Select the Volume, Balance and Mute	41
How to Set the Audio Mode(Equalize)	42

How to Set the Desired Audio	43
How to Listen to Stereo Sound / SAP	44
How to Select the Surround	44
How to Select the AVC(Auto Volume Control)	45

PC Setup

How to Select the Color Mode	47
How to Select the Auto Adjust	48
How to Set the Geometry	49

Channel Setup

How to Store Channel Automatically	51
How to Set Manual Store	52

Option Setup

Choosing Your Language	55
How to Set OSD(On-Screen-Display) Display Time	56
How to Select OSD the Background	57
How to Set Sleep Time	58
How to Set Clock	59
How to Set On /Off Time	60
Displaying Information	62
How to View Closed Captions	63
How to Select the V-Chip Control	64
How to Set the Desired V-Chip Control	65

Appendix



Glossary	69
Troubleshooting	71
Care and Cleaning	73
Product Specifications	74



Safety Precaution

The contents of this section are provided for the safety of users and their property. Please read the instructions carefully before using.

Safety instructions are divided into "Warning" and "Alert". Their meanings are as follows.

-  This icon is intended to alert the user to the presence of potential danger and important operating instructions.
-  **Warning** : When there is a possibility of serious injury or death if not observed.
-  **Alert** : When there is a possibility of slight injury or product damage if not observed.

WARNING

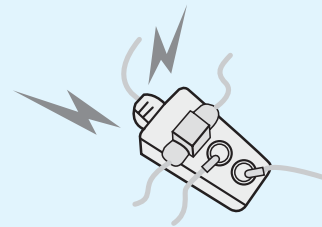

Do not connect multiple electrical appliances to a single outlet.
- It may cause a fire due to overheating from the outlet.

If there is a persistent accumulation of dusts or water on the plug, please make sure to wipe it off using a dry cloth.

- It may cause a fire or an electric shock.

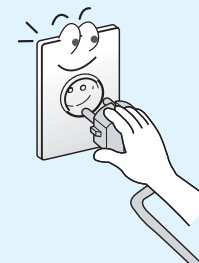

Firmly plug in the power cord so that it does not pull out.
- An unstable connection may cause fire.

Do not use a damaged power cord or plug, or loose outlet.

- They may cause electric shock or fire.

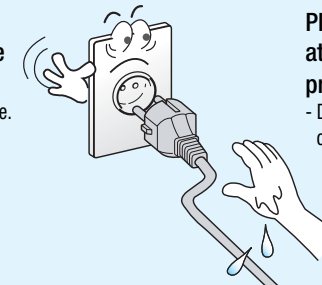

Never touch the power plug or outlet with wet hands.
- This may cause electric shock.

Please avoid touching the panel at the rear of LCD TV as it is producing high temperature.

- Direct contact with the hot surface may cause physical burns.

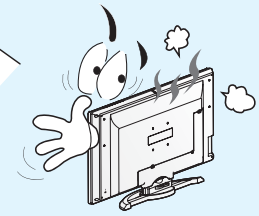

WARNING

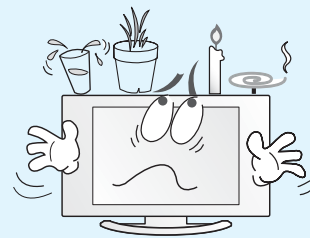

Do not put a water bowl, filled with liquids such as vases, candle, bug repellent, smoke, cigarette, plants, or heavy thing on the LCD TV.
- It may cause electric shock or fire and also heavy things may cause injury when they fall.

Do not install in a place where there is oil, smoke, excessive humidity, or where water may be sprinkled, dripped, splashed on it.

- This may cause electric shock or fire.

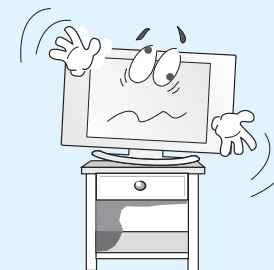

Do not install on an unstable place or small support.
- This may cause the LCD TV to fall, resulting in serious injury to a child or adult.

Do not use or store a flammable spray or inflammable things near the LCD TV.

- They may cause explosion or fire.

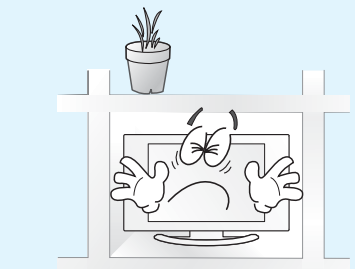

Do not install the LCD TV in a bookshelf, closet, or a place where there is poor air circulation.
- Fire may be caused due to the rise of internal temperature.



Safety PrecautionContinued from previous page

The contents of this section are provided for the safety of users and their property. Please read the instructions carefully before using.

GENERAL INFORMATION

GENERAL INFORMATION

Safety instructions are divided into "Warning" and "Alert". Their meanings are as follows.

- This icon is intended to alert the user to the presence of potential danger and important operating instructions.
- Warning** : When there is a possibility of serious injury or death if not observed.
- Alert** : When there is a possibility of slight injury or product damage if not observed.

WARNING

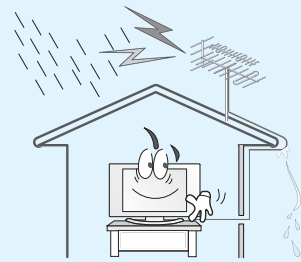

Make the antenna cable loop at the entrance of the building. Any necessary action such as making the antenna cable loop at the entrance of the building should be taken to prevent rainwater on the outdoor antenna cable from possibly running into the indoor.

- If raindrop gets into the LCD TV, it may cause a fire or an electric shock.

Never attempt to open, fix, or modify the LCD TV.

- When there is a need for fixing, call a service center. Fire or electric shock may be caused.



Do not put a metallic object like chopstick, wire, or puncher or inflammables like paper or a match in a vent, headphone jack, or AV jacks of the LCD TV.

- Electric shock or fire may be caused.

When the LCD TV produces abnormal noise, burning smell, or smoke, unplug the LCD TV immediately and call a service center.

- Electric shock or fire may be caused.

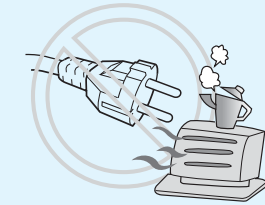

Ensure the power cord doesn't trail across any hot objects like a heater.

- This may cause a fire or an electric shock.

WARNING

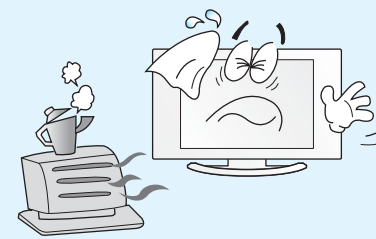

Any heat sources such as radiators and heat registers, etc. on or near the LCD TV.

- It may cause a fire.

Do not block ventilating slits.

- Blocking the ventilation slits prevents inner heat from escaping, which may lead to a fire.

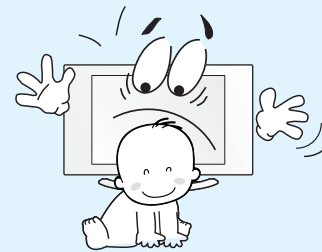
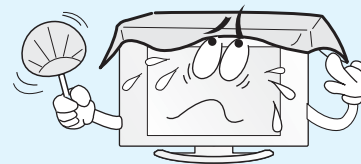

Do not install the product on the floor.

- If it falls over, your child may be injured.

Unplug the product during lightning or thunderstorms and never touch the antenna cable.

- It may cause a fire or an electric shock.

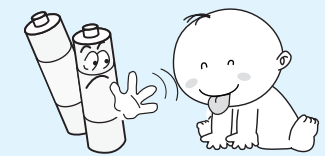

Keep the remote control batteries out of sight and out reach of children.

- If your child swallows a battery, see your doctor immediately.



Safety PrecautionContinued from previous page

The contents of this section are provided for the safety of users and their property. Please read the instructions carefully before using.

Safety instructions are divided into "Warning" and "Alert". Their meanings are as follows.

- This icon is intended to alert the user to the presence of potential danger and important operating instructions.
- Warning** : When there is a possibility of serious injury or death if not observed.
- Alert** : When there is a possibility of slight injury or product damage if not observed.

WARNING

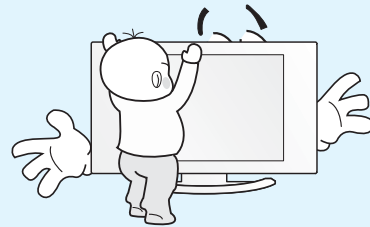

Do not allow children to climb or play on the LCD TV.

- If it falls over on children, it may cause serious injury.

Do not place toys and cookies, etc. on the LCD TV, which may attract children's attention. Children will climb on the LCD TV to reach whatever they have their eyes on.

- If it falls over on children, it may cause serious injury.

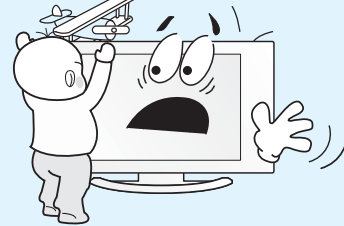

When cleaning the LCD TV, make sure to disconnect the power plug and use a dry, soft cloth for a cleanup.

- Please avoid using chemicals such as wax, benzene, alcohol, thinner, mosquito spray, air freshener, lubricant or synthetic detergent.

When replacing batteries, make sure to match the batteries to the (+) and (-) marks in the battery compartment.

- Mismatching of polarities may result in internal damage to batteries, fire due to leakage or contamination.

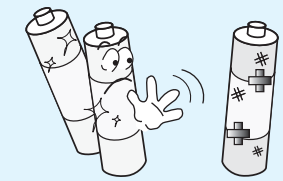
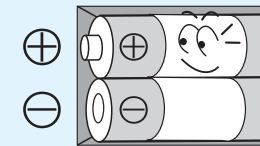

Always use the standard batteries and avoid using old batteries together with new ones.

- Otherwise it may result in internal damage to batteries, fire due to leakage or contamination.

ALERT

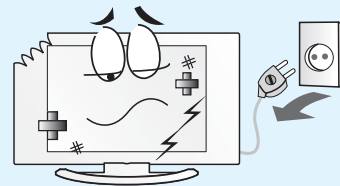

In the event of damaging or dropping the product, switch off the power and remove the plug.

- Using a damaged product may cause an electric shock or a fire.
- Contact your local service center.

Unplug when you do not use your LCD TV for a long time.

- If dust is stacked on the LCD TV, electric shock or fire may be caused from heat, fire, or deterioration of insulation.

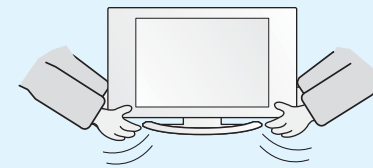

When moving the LCD TV, 2 or more people are advised to carry it.

- Injury or damage may be caused when the LCD TV falls.

Consult a service center or customer service for inside cleaning about once a year.

- When dust is piled inside the LCD TV for a long time, fire or malfunction may be caused.

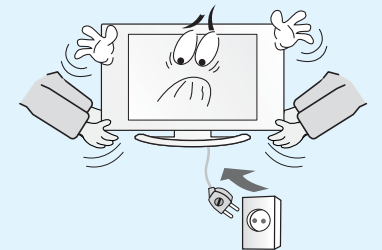

Before moving your LCD TV, ensure to switch off the power and unplug all the electrical cords and the external connection cords such as an antenna cable and other source connections, etc.

- An electrical cord(s) may be damaged resulting in a fire or an electrical shock.



GENERAL INFORMATION

Contents of the Package

To purchase additional parts, consult a distributor or selling agent.

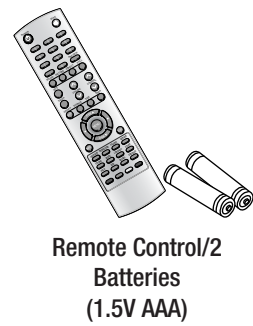

Remote Control/2
Batteries
(1.5V AAA)

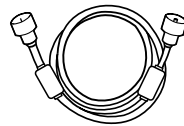

Antenna Cable

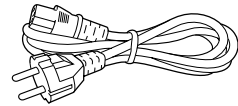

Power Cord

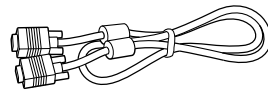

PC signal Cable(D-SUB)

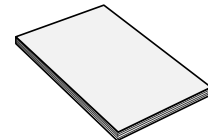

User's Guide

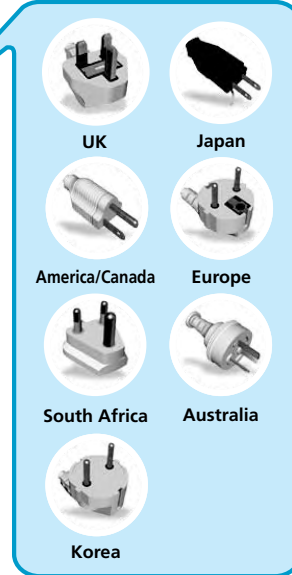

Separately Sold Products

If you want to purchase separately sold products, consult a service center, electronics shops, or parts seller.

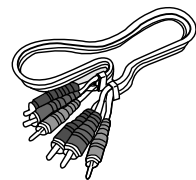

Component(Y, Pb, Pr) Cable

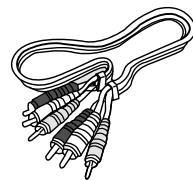

Composite(Video & Audio) Cable

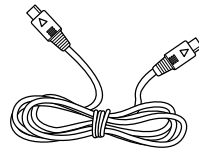

S-video cable

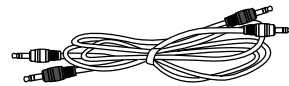

Audio Cable(DVD/DTV)

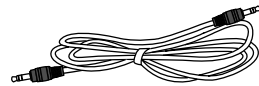

Audio Cable(PC)

How to Use the Kensington Security Slot

- This display unit supports a Kensington-type security device to secure your LCD TV. Kensington lock is not included.
- To purchase and install the Kensington locking device, please refer to the following contact information.

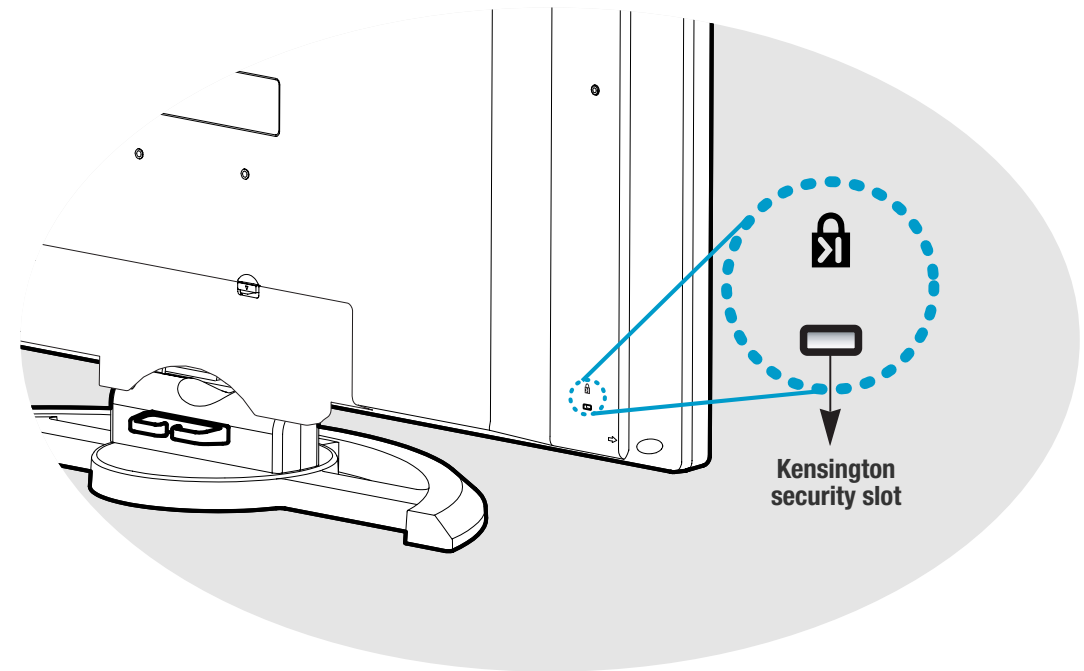

GENERAL INFORMATION

* Kensington Technology Group

- Address : 2000 Alameda de las Pulgas 2F san mateo, California 94403-1289
- Tel : +1 650 572 2700 • Fax : +1 650 572 9675
- Web-site : www.kensington.com



How to Use the Rear Cap and Cable Holder

The Rear Cap and Cable Holder allow you to organize the connection cables on the rear of the product.

1. 제품후면부의 2군데의 고정홀을 누른후 아래로 밀어내면 후면덮개가 분리됩니다.
2. Connect your cables to the terminals of the rear.
3. Organize the connected cables neatly using the Cable Holder.
4. Hook 체결부위를 8~10mm 이격된 상태로 위치시킨후 반듯이 위로 밀어 덮개를 닫아주세요.

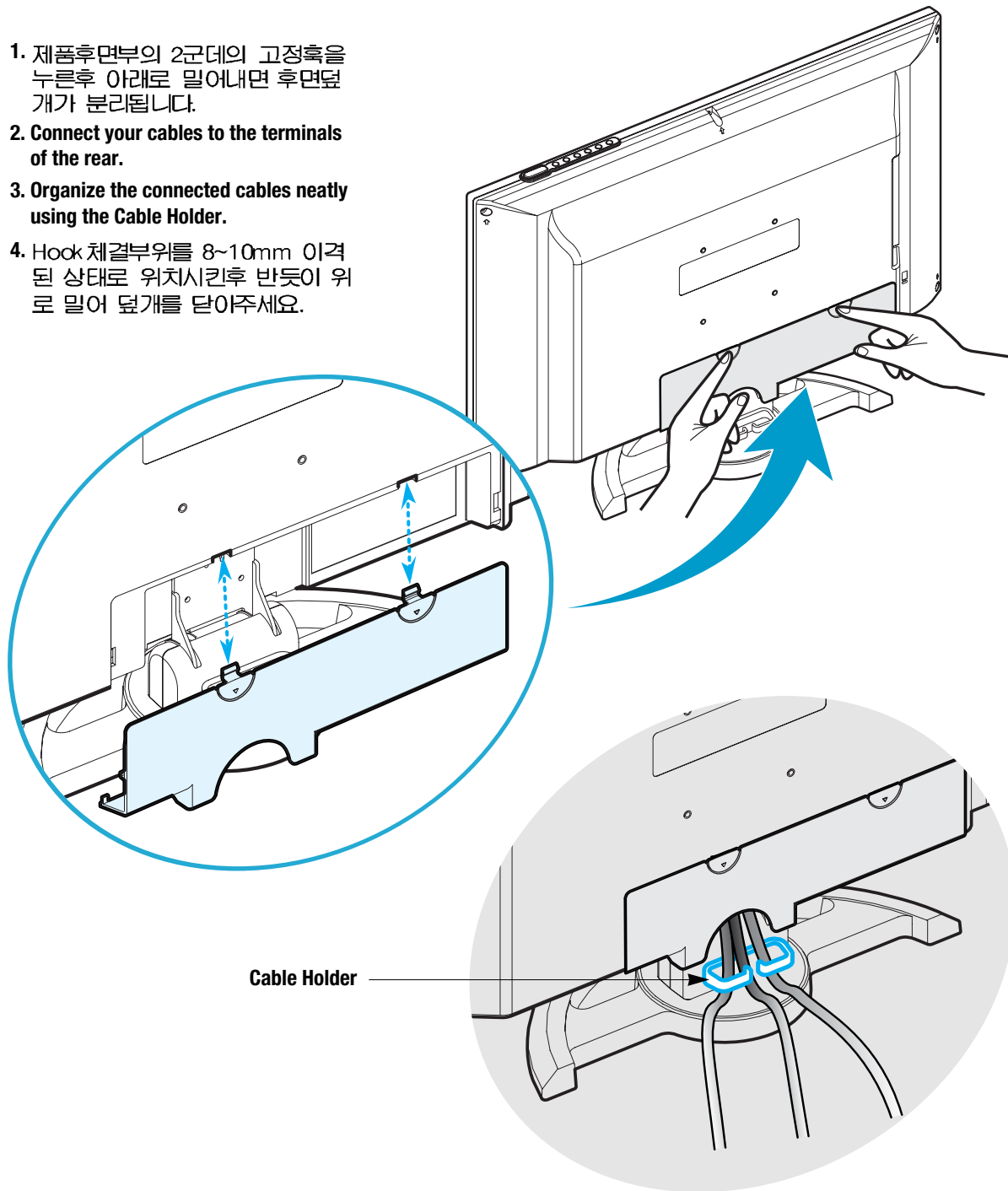

How to Adjust the View Angle

You can adjust the angle of the view for the desired view angle.

You can adjust any angle within a range of 30° to the left or right.

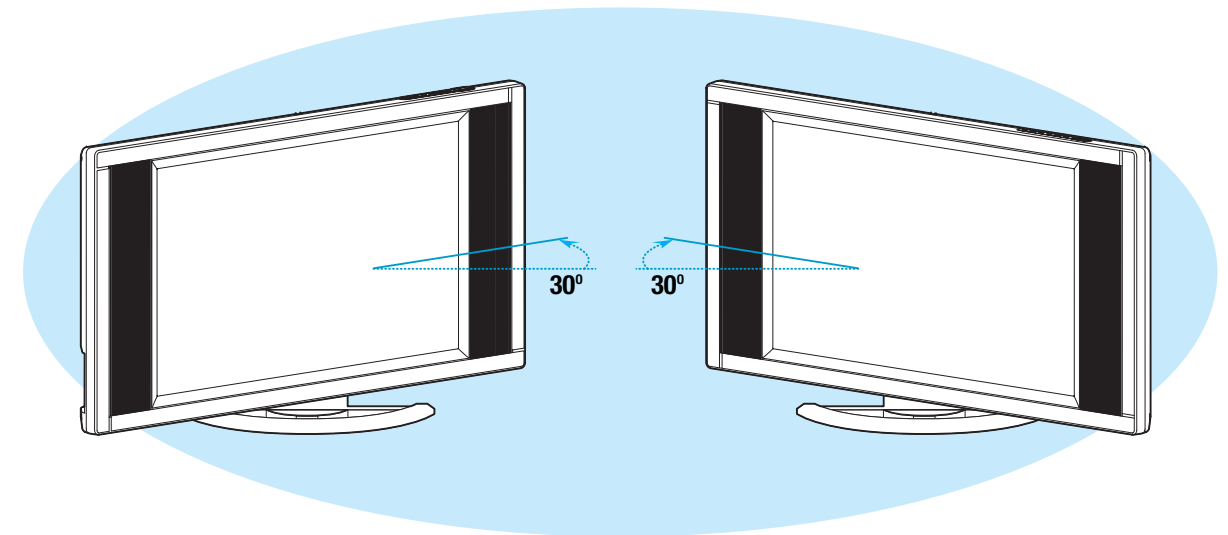

You can adjust the tilt of the TV from -5° to 10° after the installation.

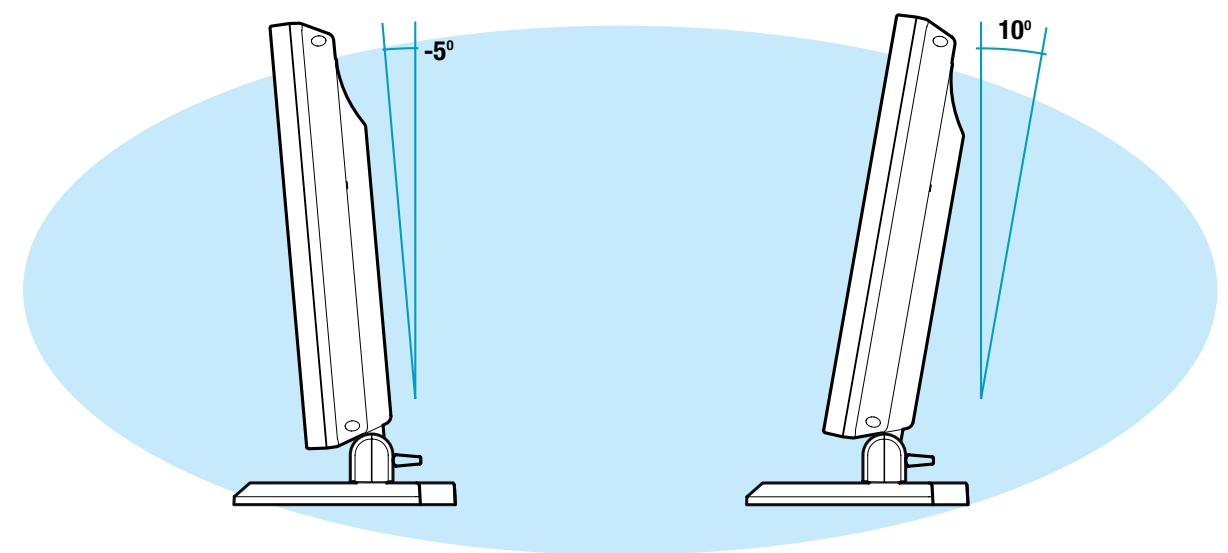



How To Install Wall Mount Support

1. Caution

1. Install on the vertical wall surface only.
2. Do not install on the following places to protect the performance of LCD TV and to prevent malfunction.
 - Near sprinkler Detector, · Near heating devices,
 - Places where vibration or shock may be applied, · Near high voltage electric power line
3. Install in a proper method with the structural materials of the wall.
If the wall is not strong enough to stand weight of TV set, reinforce the wall surface before installation.
4. Do not install within a wall.

2. Parts configuration chart

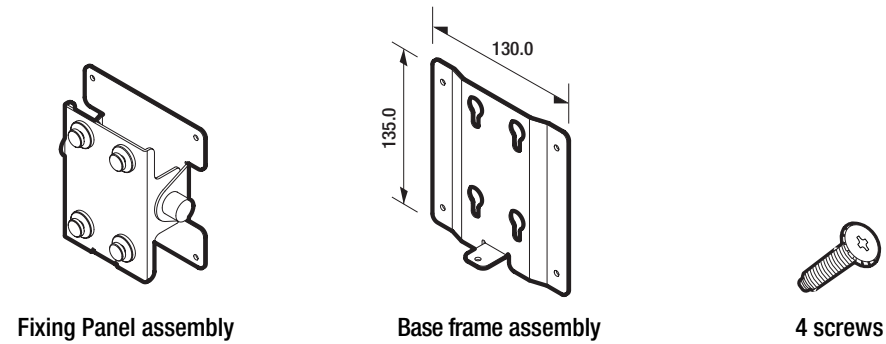

3. Angle Adjustment

The angle of LCD TV may be adjusted from -15 degree to 15 degree.

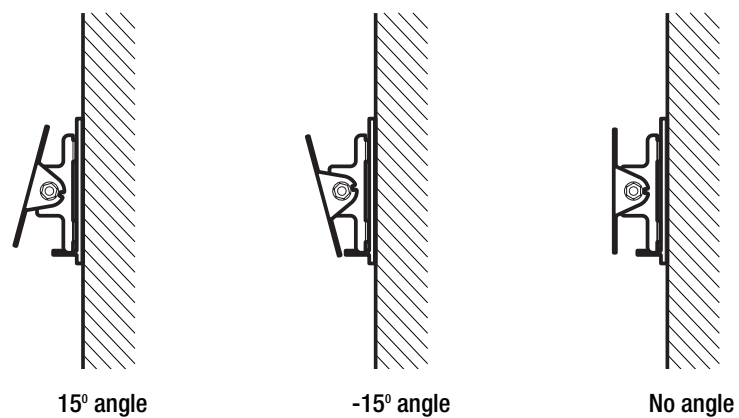

How To Install Wall Mount Frame

4. Installation Method

1. Unscrew screws fasted on 4 spots on the stand of LCD TV.

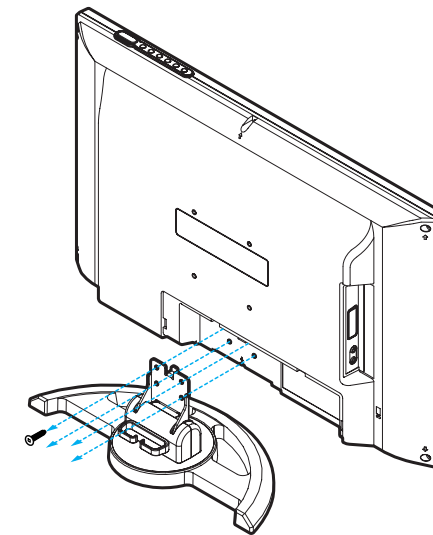

3. Fix the Base Frame Assy on the wall with screws or nails.

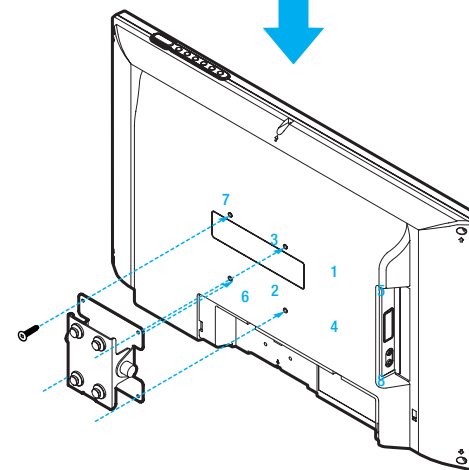
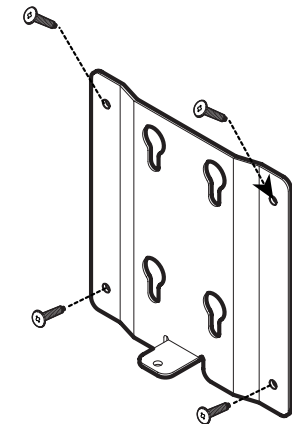

2. Fasten the Fixing Panel assembly on the back of LCD TV as shown on the picture.

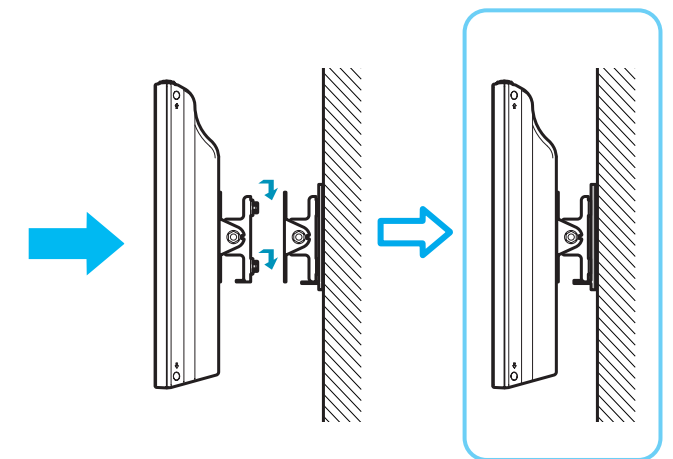

4. Hang the LCD TV assembled the Fixing Panel Assy on the Base Frame Assy. (If the LCD TV is lifted too much, the hanging Plastic may be separated)



Parts Names and Functions

Front View

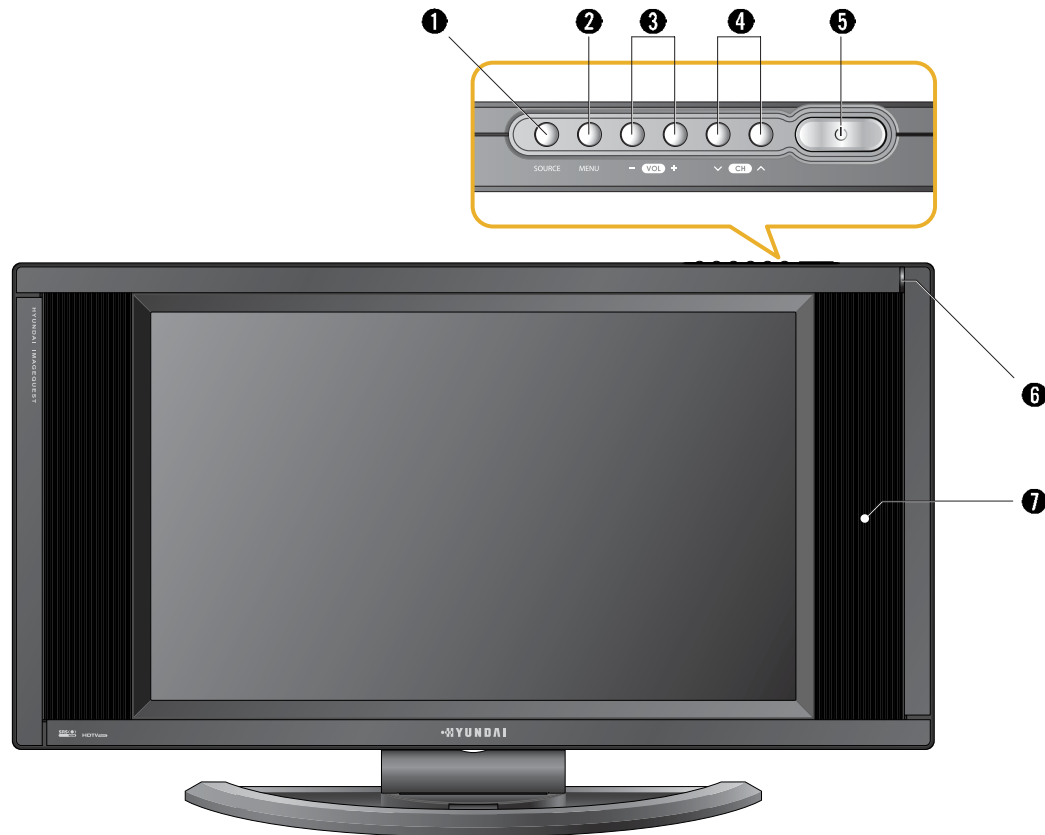

* 실제모양은 다소 차이가 있을 수 있습니다.

- 1 Source button**
Use this button to switch among inputs connected to the LCD TV.
- 2 Menu button**
Use this button to display or exit from menus.
- 3 Volume buttons**
Use these buttons for your desired sound level. These buttons also serve as the cursor of Select/Adjust when in Menu mode.
- 4 Channel buttons**
Use these buttons to change channels. These buttons also serve as the cursor of Down and Up buttons when in Menu mode.

- 5 Power button**
Use this button to turn on or off the LCD TV.
- 6 Remote sensor and power LED.**
- Point the remote control toward here.
- It displays standby or operation status.

7 Speaker

- Power Indicator Status -

Indicator	Status
Red	Stand-by
Green	Power on
Green blinking	Remote control

Rear View

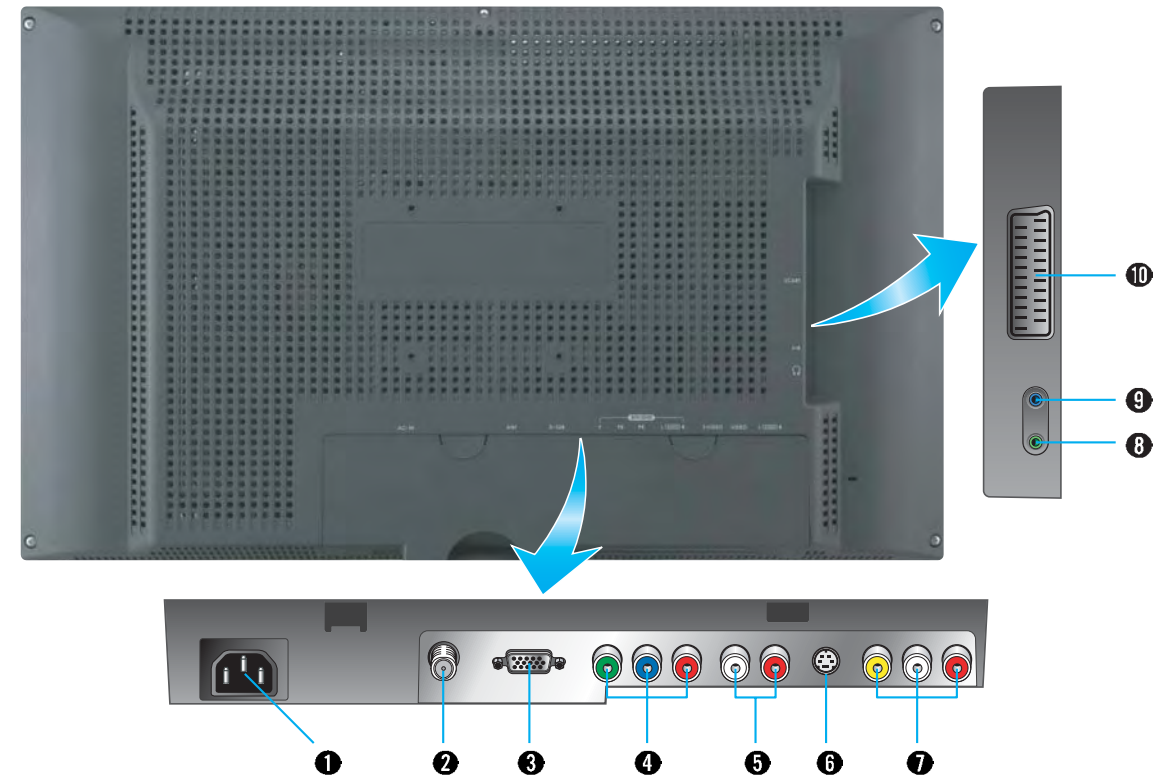

* 실제모양은 다소 차이가 있을 수 있습니다.

- 1 Power input terminal**
Power cord is connected here.
- 2 ANT. input**
This allows you to connect your antenna.
- 3 D-SUB input terminal**
Connect to the DTV Receiver with D-Sub terminal or to RGB output terminal of a PC.
- 4 Component input terminal for DVD or DTV**
Connect to the Component output terminal of DVD player/DTV receiver.
- 5 Audio input terminal for DVD or DTV**
Connect to the audio output terminal of DVD player/DTV receiver.

- 6 S-video input terminal**
Use this for the better video quality than Composite video input terminal.
- 7 Video and Audio Composite input terminal for VCR**
Connect to the Composite Video output terminal of VCR or DVD player.
- 8 Headphone Jack**
Connect to the Headphone.
- 9 Audio input Jack**
Connect to the audio output terminal of PC.
- 10 Scart input terminal - Not Use**
For the European area.



Remote Control

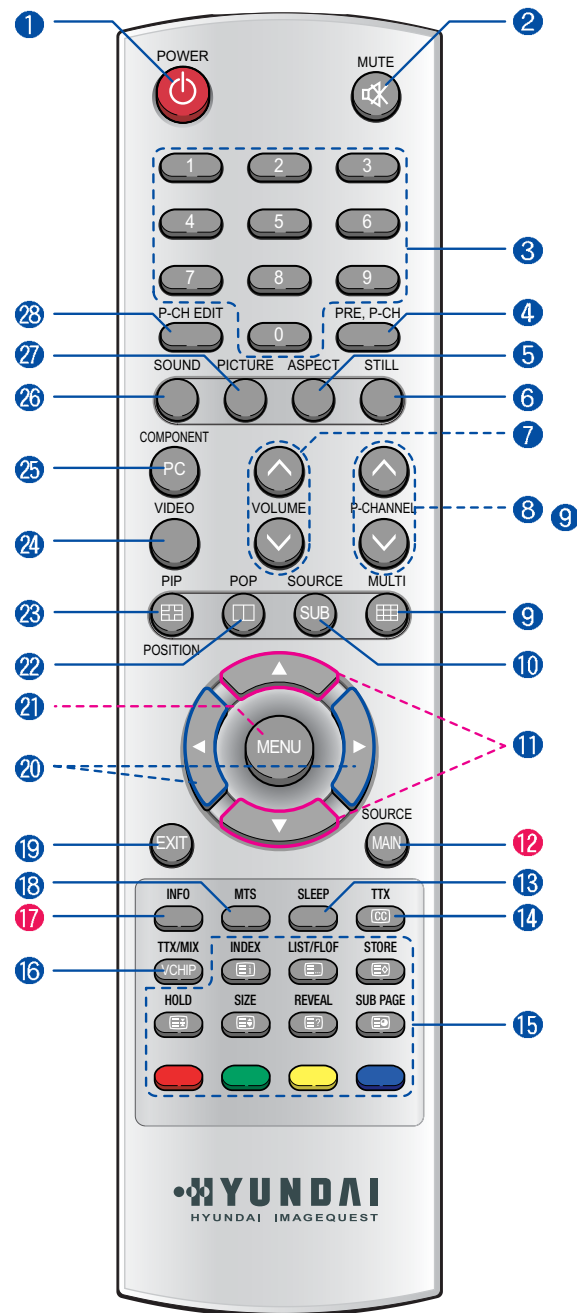

- 1 POWER/STANDBY**
Use this button to turn the TV set on or off.
- 2 MUTE**
Use this button to turn the sound off completely.
- 3 NUMERIC KEYS**
Use these buttons to select channels and input digit.
- 4 PRE, P-CH**
Use these buttons to return to the previous channel.
- 5 ASPECT RATIO**
Use this button to change the picture size. (This function is available only with the TV, Video, S-Vedio mode.)
- 6 STILL**
Use this button to freeze a picture.
- 7 VOLUME**
Use this button to control the volume level.
- 8 P-CHANNEL**
- Use this button to select channels.
- Use this button to jump back to TV mode from other mode.
- Use this button to turn the TV set on.
- 9 MULTI**
Use this button to select 9 partitions screens. (This function is available only with the TV, Video, S-Vedio mode.)
- 10 SOURCE**
Use this button to select the input source in sub picture.
- 11 UP/DOWN**
Use these buttons to move each item of menu you want to choose.
- 12 MAIN SOURCE**
- Use these buttons to display the available video source. (TV, VIDEO, S-VIDEO, COMPONENT, PC)
- 13 SLEEP**
Use this button to allow your TV to turn off automatically at designated time.
- 14 CC(Closed Caption)**
Use this button for Closed Caption On/Off.
- 15** The buttons are reserved for functions coming with later models and do not currently operate.
- 16 V-CHIP**
The V-Chip feature locks out programs that are deemed inappropriate for children.
- 17 INFORMATION**
Use this button to display picture mode, resolution or various program information.
- 18 MTS**
Use this button to display types of audio signals currently aired on TV. Or you can use this button to switch to other Sound Mode available.
- 19 EXIT**
Use this button to exit from a menu or function.
- 20 LEFT/RIGHT**
Use this button to select or adjust each item of menu.
- 21 MENU**
Use this button to bring up the OSD on the screen and jump back to the previous menu.
- 22 POP (Picture Of Picture)**
Use this button for POP On/Off. (This function is available only with the TV, Video, S-Vedio mode.)
- 23 PIP (Picture in Picture) / POSITION**
Use this button for POP On/Off or select position.
- 24 VIDEO**
Use this button to select Video or S-Video mode.
- 25 COMPONENT/PC**
Use this button to select Component or PC mode.
- 26 SOUND**
Use this button to select the status of sound.
- 27 PICTURE**
Use this button to select the status of picture.
- 28 P-CH EDIT**
Use this button to store or erase the desired channels.

How to Insert Batteries in Remote Control

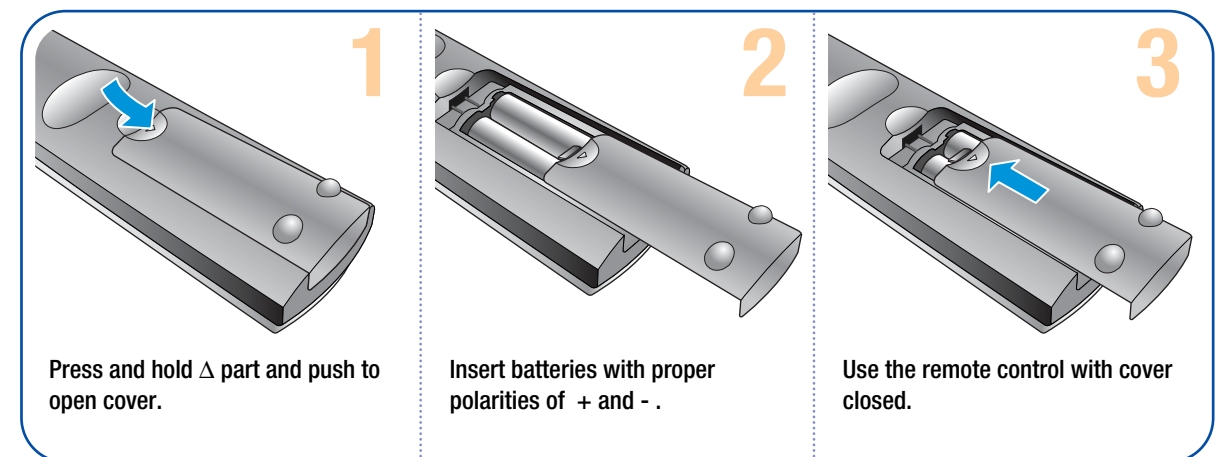

*Battery type : 1.5V/BP-2KM(AAA/LR03G)

Connections



- Connecting Indoor/Outdoor TV Antenna(UHF/VHF)23
- Connecting to the Antenna Input Connection
on the External Equipment24
- Before connecting the video connections to external devices25
- Connecting a VCR, Cable/Satellite Receiver26
- Connecting a DTV Receiver or DVD Player27
- Playing Back a Tape Recorded On a Camcorder28
- Connecting to a PC29
- Resolutions Supported in PC30



Connecting Indoor/Outdoor TV Antenna(UHF/VHF)

Connection Method

Ensure to connect an antenna cable to the antenna input connection.

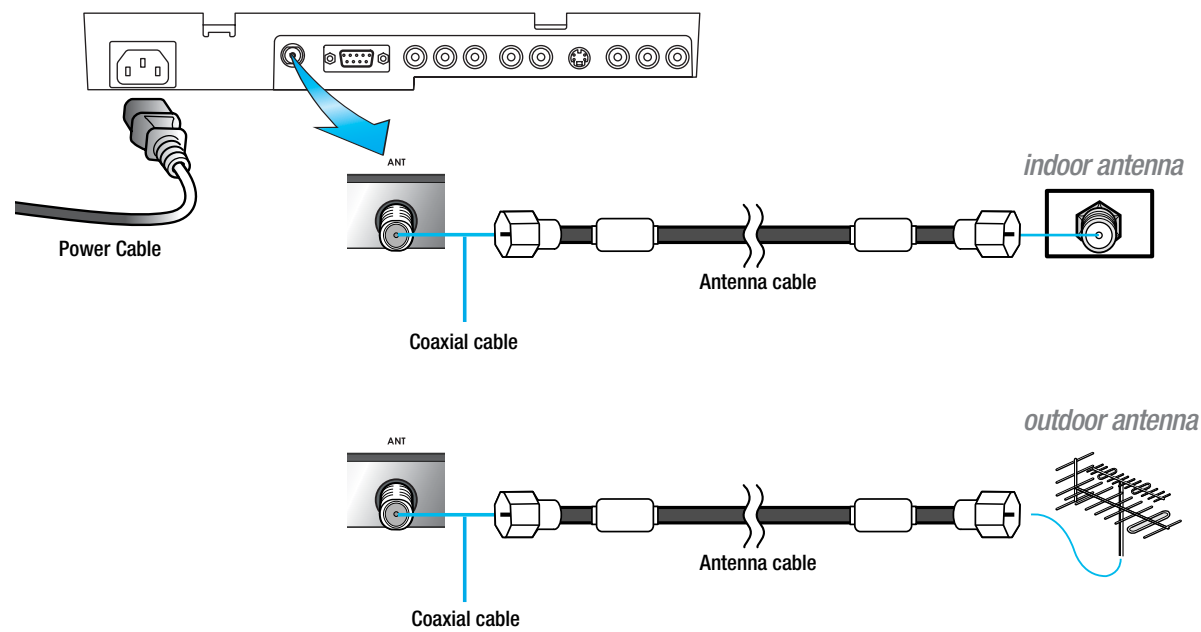

How to Watch

- 1 Turn on your LCD TV and press **MAIN** or **P-CHANNEL** on remote control unit to select TV.

You can select TV VIDEO S-VIDEO COMPONENT PC in order.

- 2 Press **P-CHANNEL** or Numeric keys to select the desired channels.

TIP

- When inserting a 75-ohm coaxial cable into the input connection, ensure the wire tip not to bend.
- If you experience poor signal reception, we recommend you purchase a signal amplifier for better picture quality.

Connecting to the Antenna Input Connection on the External Equipment

Connection Method

- 1 Connect an antenna cable to VCR/Cable/Satellite Receiver with the antenna input.
- 2 Use a coaxial cable to connect VCR/Cable/Satellite Receiver's antenna output to the antenna input on your LCD TV.

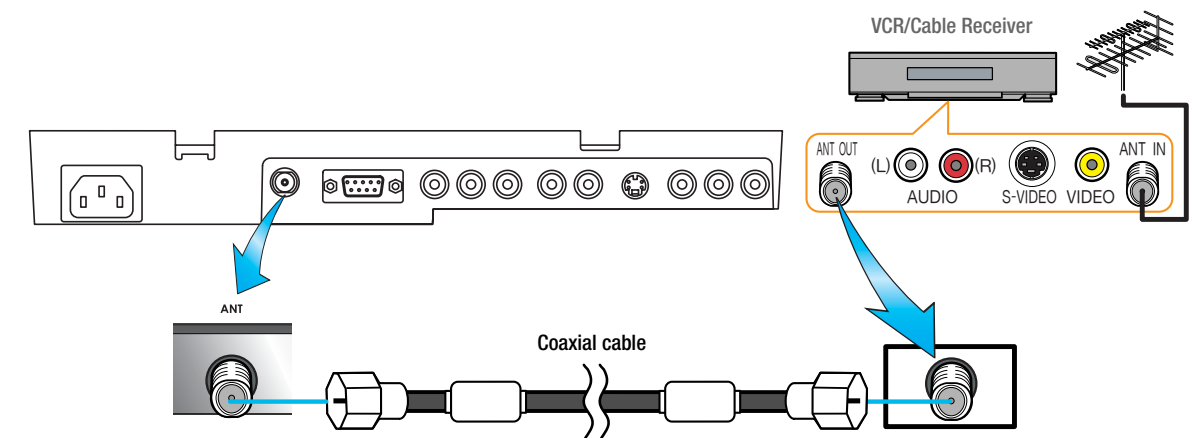



Before connecting the video connections to external devices

Please make sure to read the following information on connection to enjoy best picture quality.

Video/Audio connectors

Types of video/audio cable :

- ① 15-Pin D-Sub ② COMPONENT ③ S-VIDEO ④ COMPOSITE

Best picture quality is displayed in the following order.

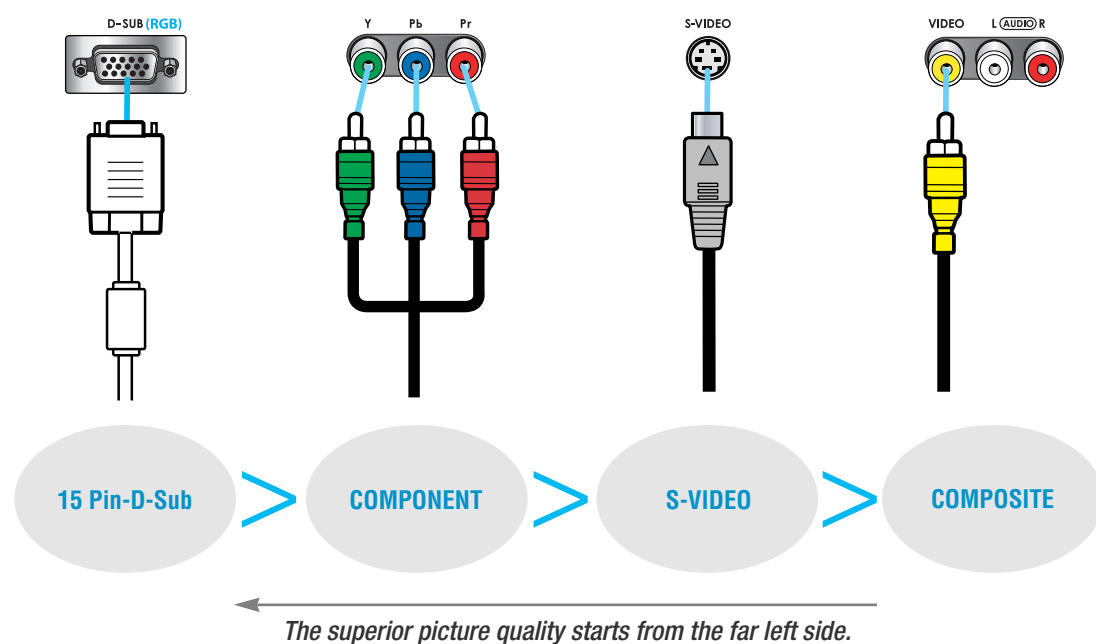

Connecting a VCR, Cable/Satellite Receiver

Connection Method

- 1 Connect Video/S-Video cable between Video/S-Video output terminal of VCR or Cable/Satellite receiver and Video/S-Video input terminal of LCD TV.
(Connect cables and terminal in the same colors)
- 2 Connect Audio cable (left:white color, right:red color) between Audio output terminal of VCR or cable/satellite receiver and Audio input terminal of LCD TV.
(Connect cables and terminal in the same colors)

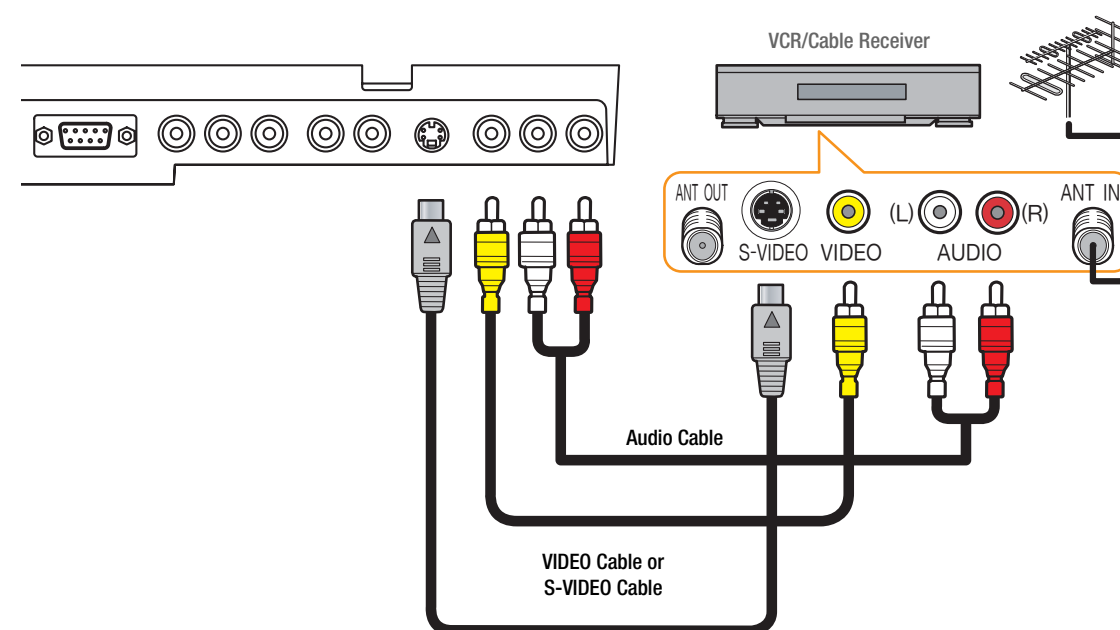

How to Watch

- 1 Turn on your LCD TV and press  on remote control unit to select Video or S-Video.
You can select ⇄ VIDEO ⇄ S-VIDEO ⇄ in order.
- 2 VCR play : Turn on the VCR and insert a tape and play it.
Cable/Satellite receiver : Turn on the receiver and select a channel.
Read a user manual of VCR, Cable/Satellite Receiver for more details.



Use S-video cables for better picture quality.



Connecting a DTV Receiver or DVD Player

Connection Method

- 1 Connect video cables(Y, Pb, Pr) between output terminals(Y, Pb, Pr) of DTV receiver or DVD player and the input terminals(Y, Pb, Pr) of DTV/DVD(480i/480p/720p/1080i) on the rear of LCD TV.
(Connect cables and terminal in the same colors)
- 2 Connect Audio cable between Audio output terminal of DTV receiver or DVD player and Audio input terminal for DTV/DVD Audio on the rear of LCD TV.
(Connect cables and terminal in the same colors)

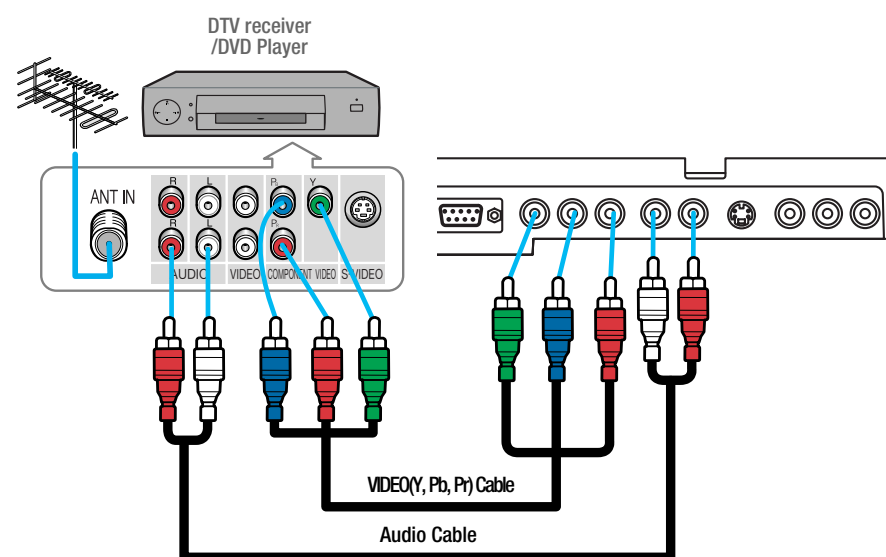

How to Watch

- 1 Turn on your LCD TV and press  on remote control unit to select DTV or DVD.
You can select \leftrightarrow COMPONENT \leftrightarrow PC \leftrightarrow in order.
- 2 Turn on a DTV receiver or DVD player and use it.
Read the user manual of DTV receiver or DVD player for more details.

TIP

- Output terminal mark(Y, Pb, and Pr) of DVD player may be written as Y, B-Y, R-Y/Y-Cb-Cr / Y-Pb-Pr. (It depends on DVD player)
- To watch digital broadcast, you have to separately purchase a digital set-top box and connect it to LCD TV.

Playing Back a Tape Recorded On a Camcorder

Connection Method

- 1 Connect Video cable between Video output terminal of Camcorder/Game player and Video input terminal of LCD TV.
(Connect cables and terminal in the same colors)
- 2 Connect Audio cable (left:white color, right:red color) between Audio output terminal of Camcorder/Game player and Audio input terminal of LCD TV.
(Connect cables and terminal in the same colors)

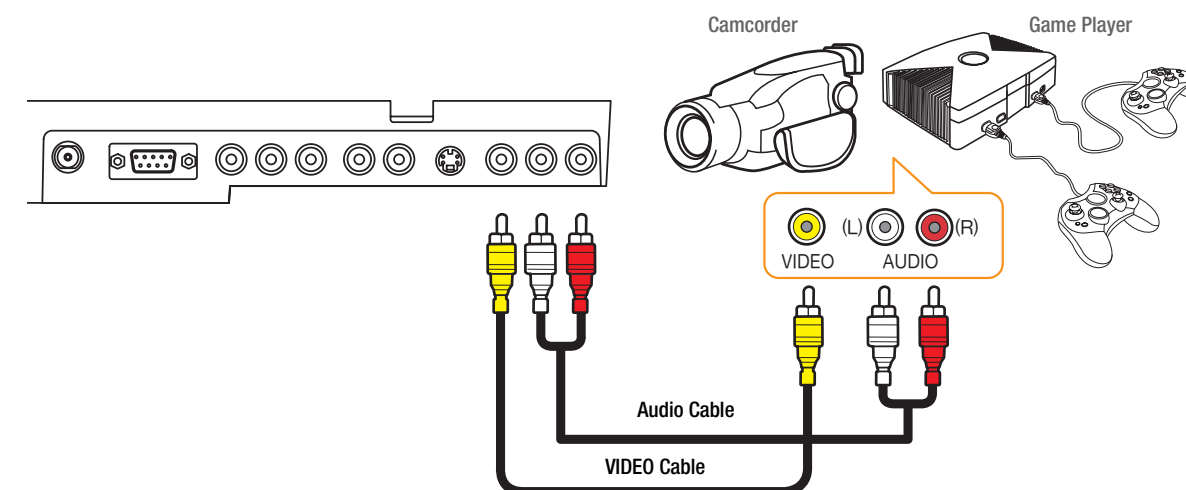

How to Watch

- 1 Turn on your LCD TV and press  on remote control unit to select Video.
You can select \leftrightarrow VIDEO \leftrightarrow S-VIDEO \leftrightarrow in order.
- 2 Turn on a Game player or Camcorder and use it.
Read the user manual of Game player or Camcorder for more details.



Connecting to a PC

Connection Method

- 1 Connect PC signal cable(15 pins D-SUB) between output terminal of PC and the D-SUB input terminal of a LCD TV.
- 2 Connect Audio cable between Audio output terminal of PC and Audio input terminal for PC of LCD TV. (Connect cables and terminal in the same colors)

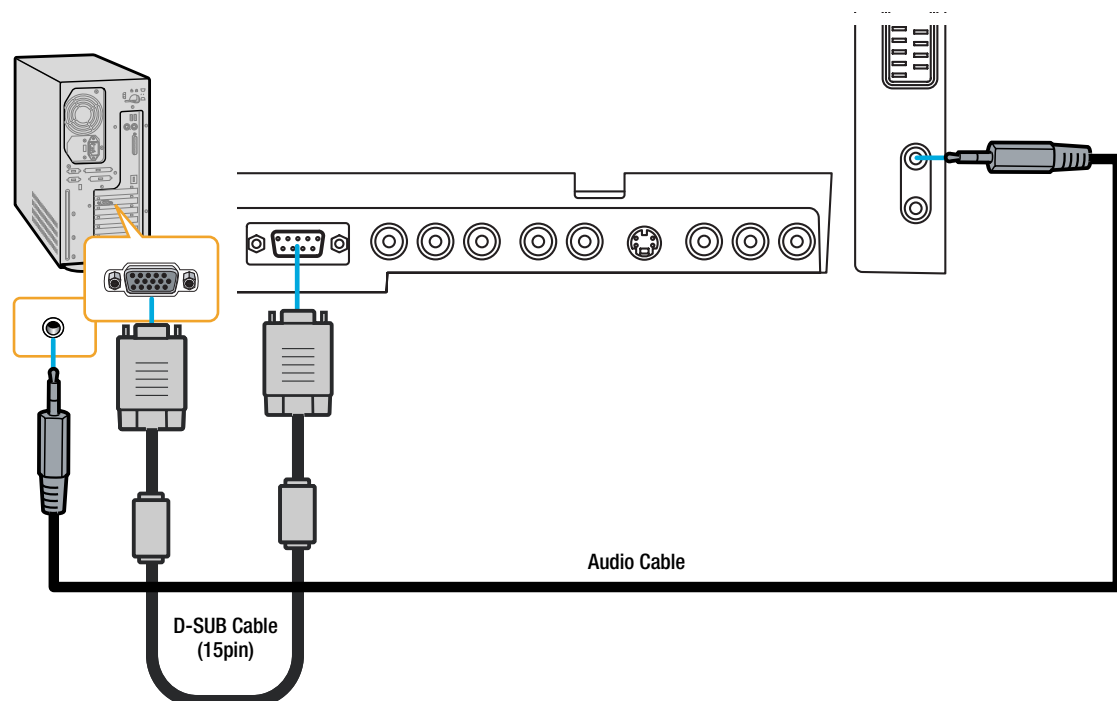

When Using as a PC Monitor

- 1 Turn on your LCD TV and press **COMPONENT** **PC** on remote control unit to select **PC**.
You can select **COMPONENT** **PC** in order.
- 2 Turn on the PC and use it. (Refer to next page on the back for the supported resolutions for PC)

TIP - This product supports plug-and-play function.
- We recommend the above method if the satellite receiver supports DTV signal with D-SUB(15 pin) cable for the better quality picture.

Resolutions Supported in PC

- HQL200NR

Resolution	Horizontal frequency(kHz)	Vertical frequency(Hz)
720 x 400	31.5	70.1
640 x 480	31.5	59.9
	37.9	72.8
800 x 600	37.9	60.3
	46.9	75
1024 x 768	48.4	60
	56.5	70.1
	60	75

- Recommended Resolution is 640x480@75Hz
- Max Resolution is 1024x768@75Hz

- HQL170WR

Resolution	Horizontal frequency(kHz)	Vertical frequency(Hz)
720 x 400	31.5	70.1
640 x 480	31.5	59.9
	37.9	72.8
800 x 600	37.9	60.3
	46.9	75
1024 x 768	48.4	60
	56.5	70.1
	60	75
1280 x 768	47.7	60

- Recommended Resolution is 1280x768@60Hz
- Max Resolution is 1280x768@60Hz

HYUNDAI LCD COLOR TV

Picture Setup



- How to Select the Picture Mode33
- How to Set the Desired Picture34
- How to Set Noise Reduction35
- How to Set PIP [Mode]36
- How to Set POP [Mode]36
- How to Set Multi [Mode]37
- How to Select the Aspect Ratio39



How to Select the Picture Mode

Users can adjust picture mode automatically according to the input mode(TV, Video, S-Video, Component).

1 Press Menu button.
Menu items appear on the screen.

1 Press Left and Right buttons to select "Picture icon".

2 Press Up and Down buttons to move to "Mode".

3 Press Left and Right buttons, then the menu changes in order below.
⇒ DYNAMIC ⇒ MILD ⇒ STANDARD ⇒ USER ⇒

EXIT Press MENU button after the setting is done, and Menu goes to the previous menu.
If the EXIT button is pressed, the menu disappears.

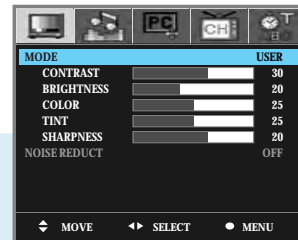
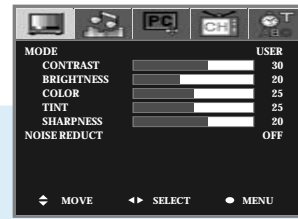

DYNAMIC : For a clear display.

MILD : For a soft display.

STANDARD : For a general contents, It fits most video contents.

USER : When the user wants to set the values → [see the next page](#)

How To Directly Select Picture Mode : Press button.

- Users can select ⇒ Dynamic ⇒ Mild ⇒ Standard ⇒ User ⇒ in order.

TIP

Adjustments menu may be different according to the input source.
PC 모드에서 Picture 모드 셋팅은 47페이지 참조

How to Set the Desired Picture

Users can manually adjust the picture in their own ways.

1 Press Menu button.
Menu items appear on the screen.

1 Press Left and Right buttons to select "Picture icon".

2 Press Up and Down buttons to move to "MODE".

3 Press Left and Right buttons to select "USER".

4 Press Up and Down buttons to choose one of the items listed.

5 Press Left and Right buttons to adjust.

EXIT Press MENU button after the setting is done, and Menu goes to the previous menu.
If the EXIT button is pressed, the menu disappears.

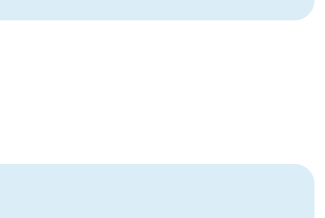
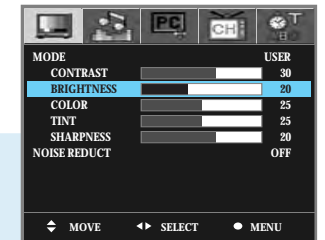
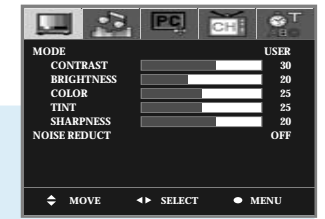

CONTRAST : Adjust the brightness and darkness of object and background.

BRIGHTNESS : Adjust the brightness of the entire picture.

COLOR : Adjust colors into deeper or lighter colors.

TINT : Adjust colors naturally.

SHARPNESS : Adjust clarity of outline of objects.

TIP

COLOR, TINT, SHARPNESS is not applied to PC, Component mode.



How to Set Noise Reduction

Noise Reduction is to eliminate some noise on the screen and It is not applied to Component and PC mode.



Press Menu button.
Menu items appear on the screen.

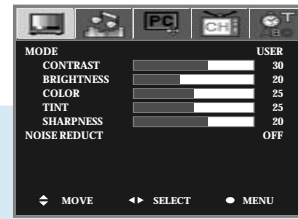

1 Press Left and Right buttons to select "Picture icon".



2 Press Up and Down buttons to move to "NOISE REDUCT".

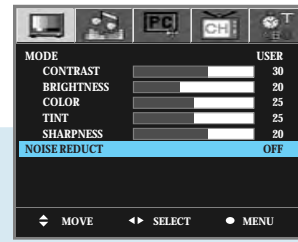

3 Press Left and Right buttons, then the menu changes in order below.
⇒ OFF ⇒ MIDDLE ⇒ STRONG ⇒



Press MENU button after the setting is done, and Menu goes to the previous menu.
If the EXIT button is pressed, the menu disappears.

- OFF : For a normal screen.
- MIDDLE : For a reduced noise on the screen.
- STRONG : For a reduced a lot of noise on the screen.

TIP

In the noise reduction, the more you reduce the screen noise, the more sharpness level of the picture may become degrade.

How to Set PIP [Mode]

- You can watch another device's image in the PIP while watching the main image.
- This function is available only with the remote control.



Press the PIP button.
You will see the PIP at the upper left corner.



Press the PIP button, then position changes in order below.
⇒ Left Up ⇒ Right Up ⇒ Right Down
⇒ Left Down ⇒ OFF ⇒



Press the SOURCE button, then PIP input source changes in order below.
⇒ TV ⇒ VIDEO ⇒ S-VIDEO ⇒

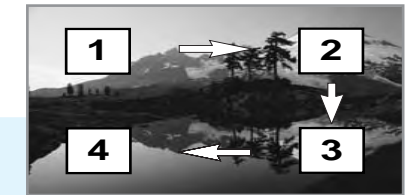

To deselect PIP function,
Press EXIT button.

How to Set POP [Mode]

- You can watch another device's image in the POP while watching TV, VIDEO, S-VIDEO mode in the main image.
- This function is available only with the remote control.



Press the POP button.
You will see the POP at the Right.



Press the SOURCE button, then POP input source changes in order below.
⇒ TV ⇒ VIDEO ⇒ S-VIDEO ⇒



To deselect POP function,
Press POP button once more or Press EXIT button.

TIP

- Main and sub pictures cannot have the same input source.
- In case of TV mode, you can change the PIP TV channel by "P-CHANNEL" Button.
- In case of TV mode, you can change the POP TV channel by "P-CHANNEL" Button.



How to Set Multi [Mode]

- You can watch another device's image in the MULTI while watching TV, VIDEO, S-VIDEO mode in the main image.
- This function is available only with the remote control.



Press the MULTI button.
You will see the Multi screen of nine screens.
연속동작을 9단계로 순차적으로 볼 수 있습니다.

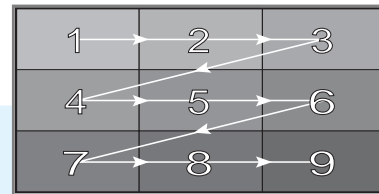

To deselect Multi function,
Press MULTI button once more or Press EXIT button.

TIP

- In case of TV mode, you can change the multi TV channel.
- You cannot change the multi input source.

Supported PIP Table

PIP : 0 → Supported, X → Not Supporte

Sub \ Main	TV	Video	S-Video	Component	PC
TV	X	0	0	0	0
Video	0	X	0	0	0
S-Video	0	0	X	0	0
Component	X	X	X	X	X
PC	X	X	X	X	X

Supported POP Table

PIP : 0 → Supported, X → Not Supporte

Sub \ Main	TV	Video	S-Video	Component	PC
TV	X	0	0	X	X
Video	0	X	0	X	X
S-Video	0	0	X	X	X
Component	X	X	X	X	X
PC	X	X	X	X	X

TIP

- PIP, POP, MULTI 기능은 전원 ON/OFF시 기억되지 않습니다.
- PIP, POP, MULTI 기능 동작시 V-CHIP기능은 지원되지 않으며 V-CHIP이 동작중에는 PIP, POP, MULTI기능은 지원되지 않습니다.
- PIP, POP, MULTI 기능 동작시 CLOSED CAPTION 기능은 지원되지 않습니다.
- 주화면이 PC/COMPONENT 입력모드일때 POP기능은 지원되지 않습니다.
- PIP, POP 기능에서 PC/COMPONENT입력모드는 부화면으로 사용할 수 없습니다.
- PC/COMPONENT입력모드에서는 MULTI 기능은 지원되지 않습니다.
- MULTI 기능 동작시 STILL기능은 지원되지 않습니다.
- PIP기능시 부화면의 사이즈는 변경되지 않습니다.
- SWAP기능은 지원하지 않습니다.

How to Freeze Picture

The user can temporarily stop the playing picture.

STILL



Press Still button.
Playing picture is stopped.
* In PIP/POP mode, the main picture stops.

To deselect Still function.
Press Still button once more.



How to Select the Aspect Ratio

- Users can adjust Aspect Ratio as users want.
- This function is available only with the remote control.

ASPECT



Press the ASPECT button, then Aspect Ratio changes in order below.

⇒ NORMAL ⇒ Zoom ⇒ 16:9 ⇒ (HQL200NR)

⇒ NORMAL ⇒ Panorama ⇒ Zoom ⇒ 16:9 ⇒ (HQL170WR)

Normal

General broadcast picture size.

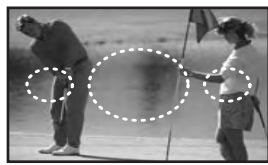

Normal

General broadcast picture is adjusted to 15:9.

16:9

General broadcast picture is adjusted to 16:9.



Panorama

Picture size for panorama video.

Zoom

Zoom in 4:3 in vertical direction. (This mode is recommended in letter box format.)



Zoom

Zoom in 4:3 in vertical direction. (This mode is recommended in letter box format.)

4:3

General broadcast picture size.



TIP

This function is available only in TV, VIDEO, S-VIDEO mode.
This function is not available in PIP, POP, MULTI mode.

Audio Setup



- How to Select the Volume, Balance and Mute41
- How to Set the Audio Mode(Equalize)42
- How to Set the Desired Audio43
- How to Listen to Stereo Sound / SAP44
- How to Select the Surround44



How to Select the Volume, Balance and Mute

- Users can adjust the volume and Balance of left and right speakers.



Press Menu button.
Menu items appear on the screen.

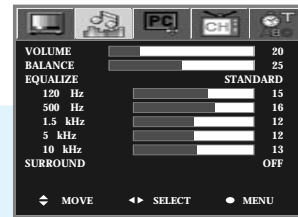

1



Press Left and Right buttons to select
"Audio icon".

2



Press Up and Down buttons to move to
"VOLUME or BALANCE".

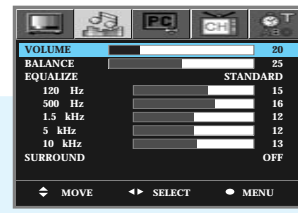

3



Press Left and Right buttons to adjust.



Press MENU button after the setting is done, and Menu goes to the previous menu.
If the EXIT button is pressed, the menu disappears.

How To Select the Mute : Press  button.

Playing sound is Stopped.
To deselect Mute function, Press MUTE button once more.

TIP

본제품은 AVC (Auto Volume Control) 기능을 기본적으로 탑재하여 각 채널의 음량크기를 자동적으로 비슷하게 조절해 줍니다.

How to Set the Audio Mode(Equalize)

Users can adjust sound mode automatically as users want.



Press Menu button.
Menu items appear on the screen.

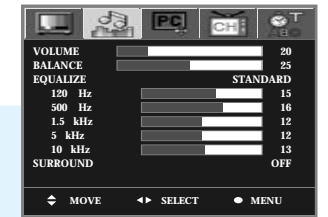

1



Press Left and Right buttons to select
"Audio icon".

2



Press Up and Down buttons to move to
"EQUALIZE".

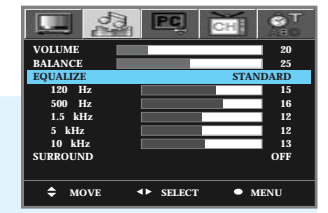

3



Press Left and Right buttons, then the menu
changes in order below.

⇒STANDARD ⇒MUSIC ⇒MOVIE ⇒NEWS ⇒USER ⇒



Press MENU button after the setting is done, and Menu goes to the previous menu.
If the EXIT button is pressed, the menu disappears.

STANDARD : For the general sound. This fits most audio contents.
MUSIC : For enjoying original sound.
MOVIE : For grandiose sound.
NEWS : For the clear sound.
USER : When the user wants to set the value → see the next page

How To Directly Select Sound Mode : Press  button.



Users can select ⇒STANDARD ⇒MUSIC ⇒MOVIE ⇒NEWS ⇒USER ⇒ in order.





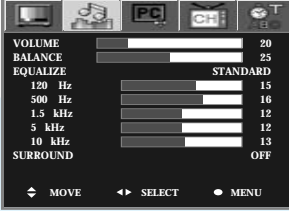

How to Set the Desired Audio



Users can manually adjust the sound in their own ways.

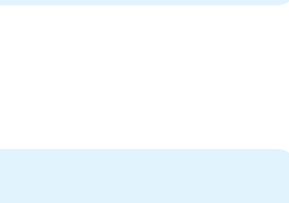

- 1**  Press Left and Right buttons to select "Audio icon".

 - 2**  Press Up and Down buttons to move to "EQUALIZE".

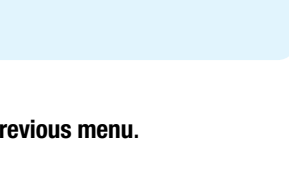
 - 3**  Press Left and Right buttons to select "USER".



 - 4**  Press Up and Down buttons to choose one of the items listed.
⇒ 120 Hz ⇒ 500 Hz ⇒ 1.5 kHz ⇒ 5 kHz ⇒ 10 kHz ⇒

 - 5**  Press Left and Right buttons to adjust.

- EXIT**  Press **MENU** button after the setting is done, and Menu goes to the **previous menu**.
If the **EXIT** button is pressed, the menu disappears.

How to Listen to Stereo Sound / SAP

- Depending on the particular program being broadcast, you can listen to stereo, mono, or a Secondary Audio Program. (SAP audio is usually a foreign-language translation. Sometimes SAP has unrelated information like news or weather.)
- This function is available only with the remote control.

- MTS**  Press the MTS button.
User can select ⇒ MONO ⇒ STEREO ⇒ SAP ⇒ in order.
- MONO** : Choose Mono for channels that are broadcasting in mono, or if you are having difficulty receiving a stereo signal.



STEREO : Choose Stereo for channels that are broadcasting in stereo.



SAP : Choose SAP to listen to the Secondary Audio Program, which is usually a foreign-language translation.

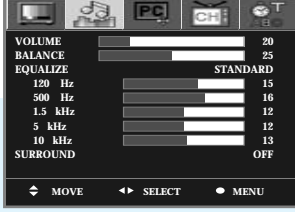

How to Select the Surround

You can listen to dynamic and surround sound only with ordinary speaker.

- 1**  Press Left and Right buttons to select "Audio icon".

 - 2**  Press Up and Down buttons to move to "SURROUND".

 - 3**  Press Left and Right buttons to select "ON/OFF".

- EXIT**  Press **MENU** button after the setting is done, and Menu goes to the **previous menu**.
If the **EXIT** button is pressed, the menu disappears.

HYUNDAI LCD COLOR TV

PC Setup



How to Select the Color Mode47
How to Select the Auto Adjust48
How to Set the Geometry49



How to Select the Color Mode

This function is available only with the PC mode.

MENU

Press Menu button.
Menu items appear on the screen.

1 Press Left and Right buttons to select "Picture icon".

2 Press Up and Down buttons to move to "Mode".

3 Press Left and Right buttons, then the menu changes in order below.
⇒ COOL ⇒ WARM ⇒ STANDARD ⇒ USER ⇒

Press **MENU** button after the setting is done, and Menu goes to the previous menu.
If the **EXIT** button is pressed, the menu disappears.

COOL : For colors with bluish tone.

WARM : Warm colors with reddish tone.

STANDARD : Color for general picture.

USER : When the user wants to set the values → [see the 34 page](#)

PICTURE

How To Directly Select Picture Mode : Press **PICTURE** button.

- Users can select ⇒Cool ⇒ Warm ⇒ Standard ⇒User ⇒, when the input mode is PC mode.

How to Select the Auto Adjust

- Horizontal/Vertical positions are automatically adjusted.
- This function is available only with the PC mode.

MENU

Press Menu button.
Menu items appear on the screen.

1 Press Left and Right buttons to select "PC icon".

2 Press Up and Down buttons to move to "Auto Adjust".

3 Press Left and Right buttons to "Auto Adjust", then it will be adjusted the screen.

Press **MENU** button after the setting is done, and Menu goes to the previous menu.
If the **EXIT** button is pressed, the menu disappears.



How to Set the Geometry

- This is to reduce image retention and noise.
- This function is available only with the PC mode.



Press **Menu** button.
Menu items appear on the screen.

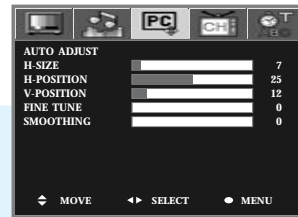

1



Press **Left** and **Right** buttons to select
“**PC icon**”.

2



Press **Up** and **Down** buttons to choose
one of the items listed.

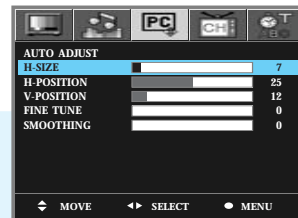

3



Press **Left** and **Right** buttons to adjust.



Press **MENU** button after the setting is done, and Menu goes to the **previous menu**.
If the **EXIT** button is pressed, the menu disappears.

H-SIZE : To adjust the horizontal size of the picture.
H-POSITION : To adjust the horizontal position of the picture.
V-POSITION : To adjust the vertical position of the picture.
FINE TUNE : To adjust to eliminate the shake of picture.
SMOOTHING : To change viewing point at high resolution(Upper VGA)

Channel Setup



How to Store Channel Automatically	51
How to Set Manual Store	52



How to Store Channel Automatically

- When you start using your TV for the first time, you must select your country to auto store.
- You can scan channels available to you automatically.

1 Press Menu button.
Menu items appear on the screen.

2 Press Left and Right buttons to select "Channel icon".

3 Press Up and Down buttons to move to "Country".

4 Press Left and Right buttons, then the menu changes in order below.
⇒ USA ⇒ KOREA ⇒

5 Press Up and Down buttons to move to "Auto Store".

6 Press Left and Right buttons to select "Auto Store", then it will be stored the searched channels. After completing channel searching, it will return to the first stored channel.

7 Press MENU button after the setting is done, and Menu goes to the previous menu. If the EXIT button is pressed, the menu disappears.

TIP

If you press the MENU button in the middle of Auto Store, the first stored channel will be displayed, and the Auto Store stops.

How to Set Manual Store

This function allows you to manually add or delete the desired channels while watching a program. If the signal is weak or distorted, you may have to fine tune the channel manually.

1 Press Menu button.
Menu items appear on the screen.

2 Press Left and Right buttons to select "Channel icon".

3 Press Up and Down buttons to move to "Channel No".

4 Press Left and Right buttons to change the channel, then the menu change in order below.
⇒ TV : CH 2~69 ⇒ CATV : CH 1, 14~125 ⇒
User cannot use number (0~9) button.

5 Press Up and Down buttons to move to "Channel Edit".

6 Press Left and Right buttons to select "Stored/Erased", Channel Number is current channel.

*Go to step 6,
If the signal of current channel is weak or distorted.*

7 Press Up and Down buttons to move to "Fine Tune".

8 Press Left and Right buttons to adjust. The fine tuned channels are automatically stored.

Press MENU button after the setting is done, and Menu goes to the previous menu. If the EXIT button is pressed, the menu disappears.

How To Directly Select ADD/ERASE Channel : Press button.

The selection will switch whenever you press the Add/Delete button on the remote control.