

ATTACHMENT E.

- USER'S MANUAL -

Service Center

USA
AVC Tech
777 Mark St., Wood Dale, IL 60191
Tel : 800-568-0060 or 630-595-0123
Fax : 800-784-9422 or 630-595-2345
e-mail : service@hyundaimonitor.com

NEW ZEALAND
TRANSTECH DISTRIBUTORS Ltd.
PO Box 12985 Penrose,
Auckland New Zealand
Tel : 09-571-0775
Fax : 09-571-0776
e-mail : LouisG@Transtech.co.nz
WWW : www.transtech.co.nz

AUSTRALIA
Thomas Electronics Australia Pty Ltd.
3 Sheridan Close
Milperra NSW 2214, Australia
Tel : +61 2 9773 7400
Fax : 61 2 9773 7177
Attn : Ms. Shiely Poniman

GERMANY
Hyundai ImageQuest Europe GmbH
Geheimrat Hummel Platz 2
65239, Hochheim, Germany
Tel : 06146 / 904 444
Fax : 06146 / 904 410
e-mail : service@hyundaiq.de
WWW : www.hyundaiq.com

JAPAN
Hyundai ImageQuest JAPAN
Shin-Hibiya Bldg, East 5F 1-3-6
Uchisaiwai-Cho, Chiyoda-ku,
Tokyo, Japan 100-0011
Tel : 03-5157-2286
Fax : 03-5157-2284
e-mail : pjkim@iqt.co.kr
C/S P.J.Kim

www.hyundaiQ.com



User's Guide

Digital

MODELS : A261 | A321 | A421S | A421H



FCC Information

User Instructions

The Federal Communications Commission Radio Frequency Interference Statement includes the following warning :

NOTE : This equipment has been tested and found to comply with the limits for a Class B digital device pursuant to Part 15 of the FCC Rules.

These limits are designed to provide reasonable protection against harmful interference in a residential installation. This equipment generates, uses, and can radiate radio frequency energy and, if not installed and used in accordance with the instructions, may cause harmful interference to radiocommunications. However, there is no guarantee that interference will not occur in a particular installation.

If this equipment does cause harmful interference to radio or television receptions, which can be determined by turning the equipment off and on, the user is encouraged to try to correct the interference by one or more of the following measures :

- Reorient or relocate the receiving antenna.
- Increase the separation between the equipment and receiver.
- Connect the equipment into an outlet on a circuit different from that to which the receiver is connected.
- Consult the dealer or an experienced radio/TV technician for assistance.

User Information

Changes or modifications not expressly approved by the party responsible for compliance could void the user's authority to operate the equipment. Connecting of peripherals requires the use of grounded shielded signal cables.

Important Tip

Image Retention Effect (Image Sticking)

1. Cause :

- Image Retention Effect may come from displaying a still picture in certain period of time with at a certain area continuously, as the feature of LCD panel or Plasma display panel. This is caused due to brightness degradation. Many LCD manufacturers are trying to overcome this limitation.

2. Prevention

- To avoid this matter, use the product after reducing brightness and contrast, especially when a still image is displaying for a long time. (Contrast 50/Brightness 50 - [See 34 page](#))
Once image retention occurs, use the mode that displays more motion pictures. It will help reduce this matter.

3. Solution

- The temporary image sticking would decrease with displaying Full-White pattern during 10 hours.
 - * The permanent image sticking could not take off under the latest technology.
This method may be used to eliminate a temporary retained image that occurs after displaying a still image for a certain period of time. Since it may take several minutes to several hours to remove image sticking, it is recommendable to display motion pictures during 2~3 minutes every hour when keeping displaying a still image. As image sticking is influenced by the brightness of a still image being displayed and its display time, it is recommended that you reduce the brightness of the screen when displaying a still image for a long time.

* Image Sticking does not come under the warranty.



Image Sticking Precaution

When watching a still Image within motion pictures and Panorama/Wide/4:3 screen

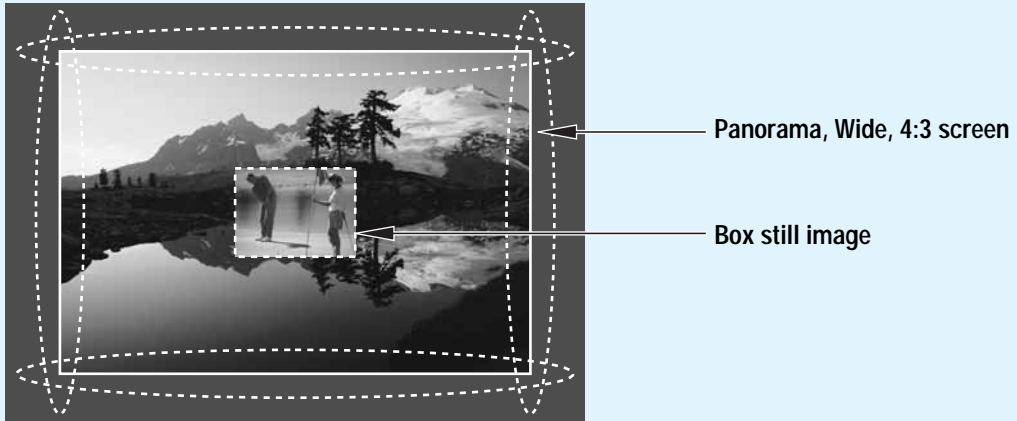

Panorama, Wide, 4:3 screen

Box still image

1. Note :

- When the central area of the screen and the screen edges are fixed, the different brightness level of the edges may cause image retention on the edges when watching for a long time
- This phenomenon is the same matter to other LCD manufacturers. Please do not watch a still image for a long time.
- If you watch a still image for a long time, this may damage your TV.

* This matter does not come under the warranty.

Features

A Wide Array of Screen Settings

You can choose different screen settings depending on the type of program you are watching or the surrounding conditions (the outside weather conditions). You can switch among Standard, Dynamic, Movie, and Mild options or you can configure the screen settings for yourself.

A Wide Array of Sound Settings

You can choose an optimal sound setting for the type of program you are watching. You can switch among Standard, News, Music, and Sport options or you can configure the sound settings for yourself.

Favorite Channel Memory

You can memorize the channels you are watching frequently.

SRS TrueSurround XT

You can enjoy dynamic and surround sound with ordinary speakers.

A Variety of Aspect Ratios

You can adjust the screen size at your preference.

Auto On/Off Function

This function allows you to turn on or off your TV at the preset time.

Game Prevention Function

This function is designed to prevent a VCR or game player from being connected to the TV.



Table of Contents

General Information

Safety Precaution5
 Contents of the Package9
 Products Sold Separately9
 Kensington Lock Anti-theft Device11
 How to Mount and Detach The Speakers12
 How to Install Desktop Stand13
 How to Use Speakers14
 How to Install Wall Hanger Support16
 How to Install Wall Mount Frame17
 How to adjust the view angle18
 Parts Names and Functions19
 Remote Control23

Connections

Before Connecting the Video/Audio Connections to External Devices...25
 How to Connect a VCR/Cable Receiver26
 How to Connect a DTV Receiver or DVD Player27
 How to Connect a Camcorder/Game Player28
 How to Connect to a PC29
 HDMI Connection31
 How to Connect an External Visual Device33

Picture Setup

How to Select the Picture Mode34
 How to Set the Desired Picture35
 How to Adjust the Color Temperature of the Screen36
 How to Select the Aspect Ratio37
 How to Watch the PIP39
 How to Set the INPUT for the Sub-Picture40
 How to Noise Reduct42

Sound Setup

How to Select the Audio Mode43
 How to Adjust the Desired Audio Mode44
 How to Use the Automatic Volume Control45
 How to Select MTS(Multi-Channel Sound)46

How to Listen to SRS TruSurround XT (Surround)47
 How to Set the Output of Subwoofer48
 How to Set the Audio Output49

Channel Setup

How to Store Channels Automatically50
 How to Add/Erse Channels Manually51
 How to Set Favorite Channels52
 How to Fine Tune Channel Reception53
 How to the LNA (Low-Noise-Amplifier) Feature54

Function Setup

How to Choose Your Language55
 How to Set Clock, On/Off Time, Sleep Time56
 How to Set the Geometry in PC Mode58
 How to Set Key Lock59
 Using the Pixel Shift / Full white.....61
 How To Set Block Program62
 How to View Closed Captions64

Appendix

How to Use an External Device Using the Remote Control ...66
 Glossary69
 Troubleshooting72
 Care and Cleaning74
 Product Specifications75



Safety Precaution

The contents of this section are provided for the safety of users and their property. Please read the instructions carefully before using.

Outdoor Antenna Grounding

If an outside antenna or cable system is connected to the TV, be sure the antenna or cable system is grounded so as to provide some protection against voltage surges and built-up static charges. Section 810 of the National Electrical Code, ANSI/NFPA No.70-1984, provides information about proper grounding of the mast and supporting structure, grounding of the lead-in wire to an antenna discharge unit, size of grounding conductors, location of antenna discharge unit, connection to grounding electrodes, and requirements for the grounding electrode.

Example of Grounding According to National Electrical Code Instruction

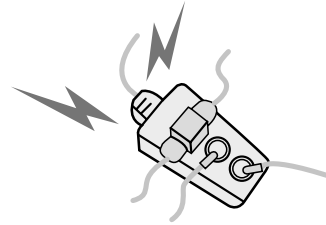
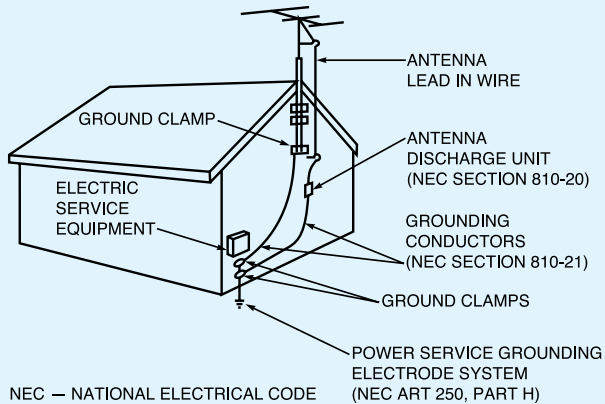

Do not connect multiple electrical appliances to a single outlet.

- It may cause a fire due to overheating from the outlet.

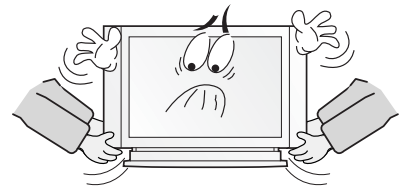

Make sure to remove the speakers before moving the TV with speakers mounted on it.

- When the speakers are detached from the unit while carrying it, this may cause damage to the unit or personal injury.

Do not use or store a flammable spray or inflammable things near the TV.

- They may cause explosion or fire.

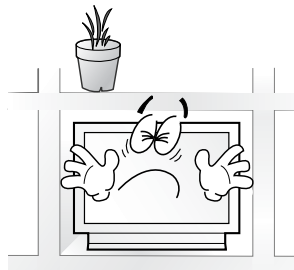
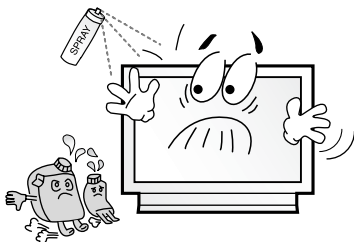

Do not install the TV in a bookshelf, closet, or a place with poor air circulation.

- Fire may be caused due to the rise of internal temperature.

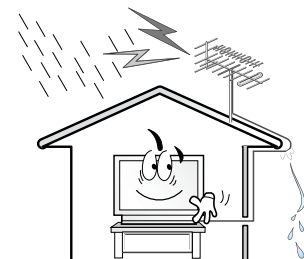

Any necessary action such as making the antenna cable loop at the entrance of the building should be taken to prevent rainwater on the outdoor antenna cable from possibly running indoor.

- If raindrop gets into the TV, it may cause a fire or an electric shock.

If there is a persistent accumulation of dusts or water on the plug, please make sure to wipe it off using a dry cloth.

- It may cause a fire or an electric shock.

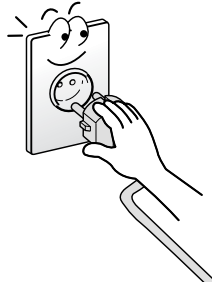

Firmly plug in the power cord so that it does not pull out.

- An unstable connection may cause fire.

Do not use a damaged power cord or plug, or loose outlet.

- It may cause electric shock or fire.

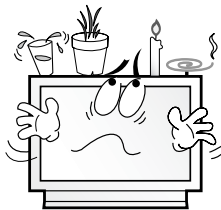
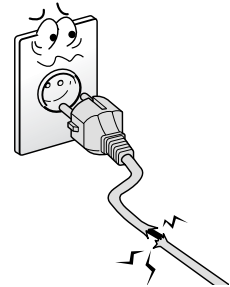

Do not put a water bowl, vase, candle, bug repellent, smoke, cigarette, plants, or heavy thing on the TV.

- It may cause electric shock or fire and also heavy things may cause injury when they fall.

Do not install in a place where there is oil, smoke, excessive humidity, or where water may be sprinkled on it.

- This may cause electric shock or fire.

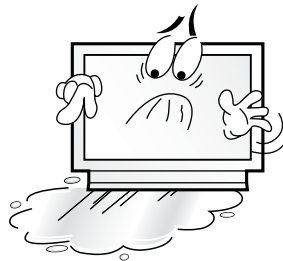

Do not install on an unstable place or small support.

- This may cause the TV to fall, resulting in serious injury especially to children.

Never attempt to open, fix, or modify your TV.

- When there is a need for fixing, call a service center. Fire or electric shock may be caused.

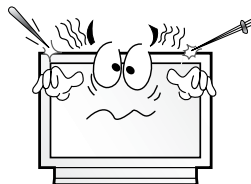
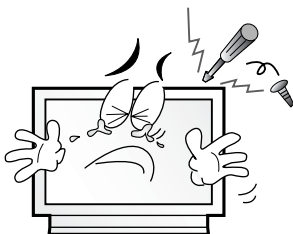

Do not put a metallic object like chopstick, wire, or puncher or inflammables like paper or a match in a vent, headphone jack, or AV jacks of the TV.

- Electric shock or fire may be caused.

When the TV produces abnormal noise, burning smell, or smoke, unplug the TV immediately and call a service center.

- Electric shock or fire may be caused.

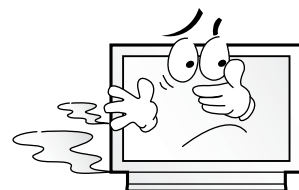



Safety PrecautionContinued from previous page

The contents of this section are provided for the safety of users and their property. Please read the instructions carefully before using.

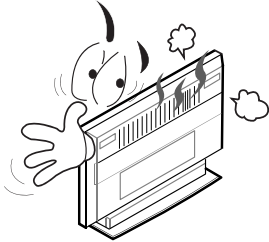

Please avoid touching the panel at the rear of TV as it is producing high temperature.
- Direct contact with the hot surface may cause physical burns.



Do not place any heat sources such as radiators and heat registers, etc. near the TV.
- It may cause a fire.

Do not block ventilating slits with a table cloth.
- Blocking the ventilation slits may produce internal heat increase, resulting in a fire.

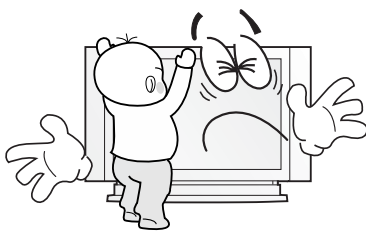
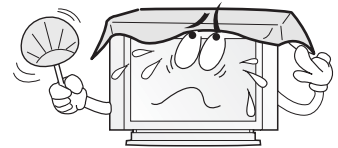

Do not allow children to climb or play on the TV.
- This may cause the TV to fall resulting in serious injury.

Do not place toys and cookies, etc. on the TV, which may attract children's attention.
- This may cause the TV to fall, resulting in serious injury.

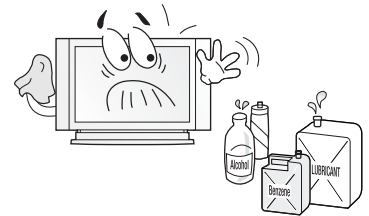
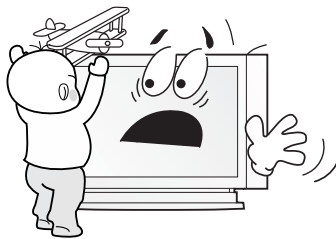

When cleaning the TV, make sure to disconnect the power plug and use a dry, soft cloth for a cleanup.
- Please avoid using chemicals such as wax, benzene, alcohol, thinner, mosquito spray, air freshener, lubricant or synthetic detergent.

Unplug when you do not use your TV for a long time.
- If dust is stacked on the TV, electric shock or fire may be caused from heat, fire, or deterioration of insulation.

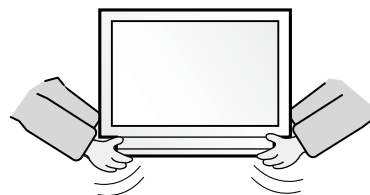
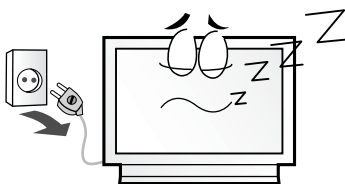

When moving the TV, two or more people are advised to carry it.
- This may cause damage to the unit or personal injury.

Never touch the power plug or outlet with wet hands.
- This may cause electric shock.

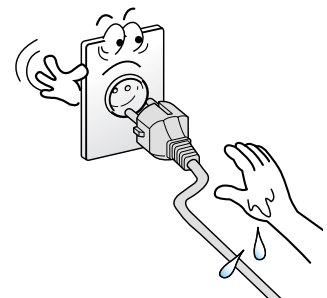

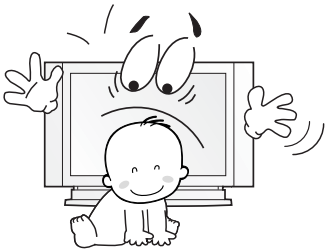

Do not install the product on the floor.
 - This may cause the TV to fall resulting in serious injury.

Unplug the product during lightning or thunderstorms and never touch the antenna cable.

- It may cause a fire or an electric shock.

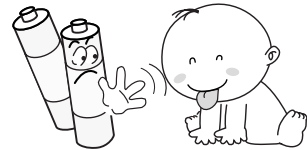
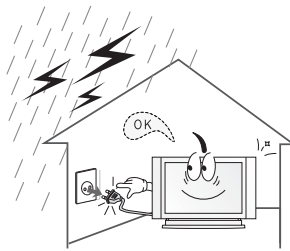

Keep the remote control batteries out of sight and out reach of children.

- If your child swallows a battery, see your doctor immediately.

When replacing batteries, make sure to match the batteries to the (+) and (-) marks in the battery compartment.

- Mismatching of polarities may result in internal damage to batteries, fire due to leakage or contamination.

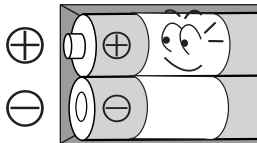
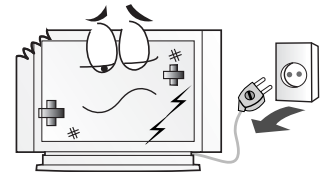
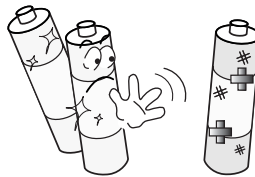

Always use the standard batteries and avoid using old batteries together with new ones.

- Otherwise it may result in internal damage to batteries, fire due to leakage or contamination.

In the event of damaging or dropping the product, switch off the power and remove the plug.

- Using a damaged product may cause an electric shock or a fire.
 - Contact your local service center.

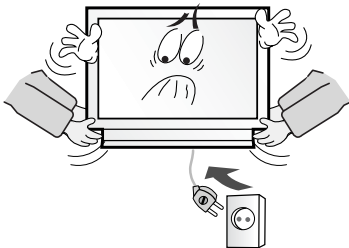

Before moving the product, ensure to switch off the power and unplug all the electrical cords and the external connection cords such as an antenna cable and other source connections, etc.

- Electrical cords may be damaged, resulting in a fire or an electrical shock.

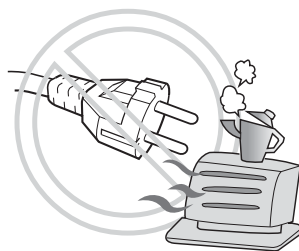

Ensure the power cord doesn't trail across any hot objects like a heater.

- This may cause a fire or an electric shock.

Consult a service center or customer service for inside cleaning about once a year.

- When dust is piled inside the TV for a long time, fire or malfunction may be caused.

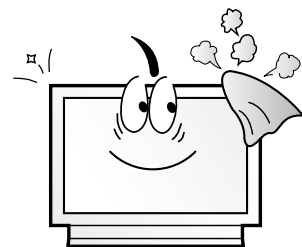



Contents of the Package

When opening the package, please ensure to check the following accessories provided.

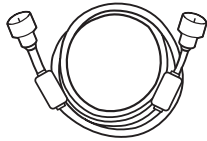

Antenna Cable
(coaxial cable)

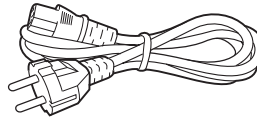

Power Cord

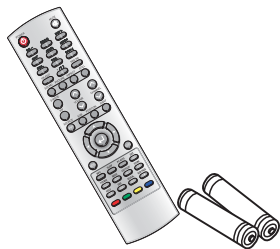

Remote Control & 2 batteries
(1.5V AAA)

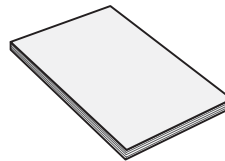

User's Guide

Products Sold Separately - For A261/A321 Model only

If you want to purchase separately sold products, consult a service center, electronics shops, or parts seller.



HDMI cable

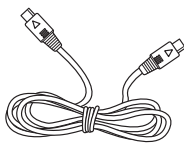

S-video Cable

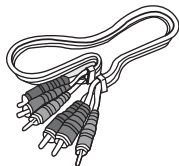

Component Cable
(Y, Pb, Pr)

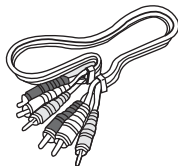

Composite Cable
(Video/Audio)

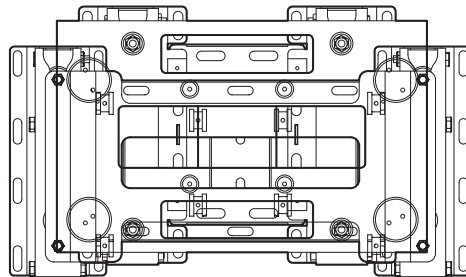

Wall Mounting Support

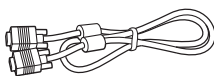

PC signal Cable (D-SUB)

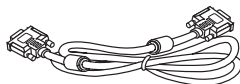

DVI PC video(digital) cable

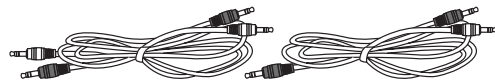

Audio Cable (DVI/DVD)

Audio Cable (PC)

Products Sold Separately - For A421S/A421H Model only

If you want to purchase separately sold products, consult a service center, electronics shops, or parts seller.

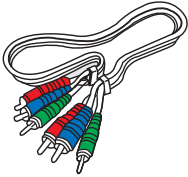

Component(Y, Pb, Pr) cable

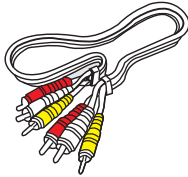

Composite(Video & Audio) cable

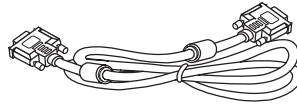

DVI PC video(digital) cable



HDMI cable

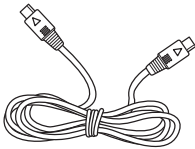

S-video cable

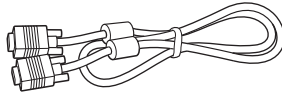

PC signal cable



Audio Cable (DVI/DVD)



Audio Cable (PC)

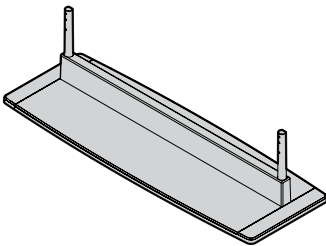

Desk type stand



speaker

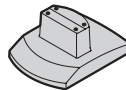

Desk type speaker stand

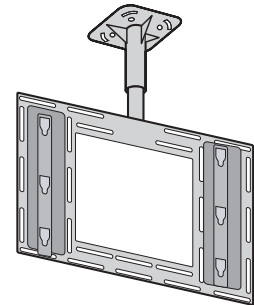

Ceil mounting frame

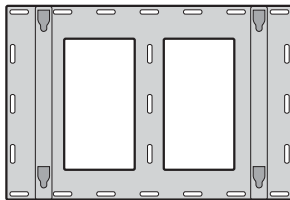

Wall mounting frame

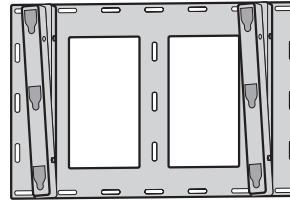

Adjustable wall mounting frame



Kensington Lock Anti-theft Device - For A261/A321 Model only

- This display unit supports Kensington standard security lock to prevent theft.
- You should purchase the Kensington lock device personally, if you need. The security lock is available at an electronics shop.
- For more information, please refer to the following contact information..

* Kensington Technology Group

- Address : 2000 Alameda de las Pulgas 2F san mateo, California 94403-1289
- Tel : +1 650 572 2700 • Fax : +1 650 572 9675 • Web-site : www.kensington.com

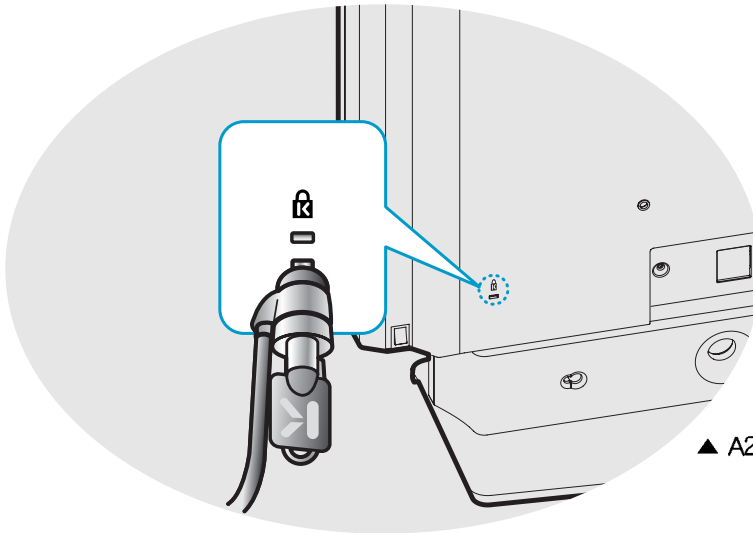

▲ A261/A321 Model

How to Mount and Detach The Speakers - For A261/A321 Model only

You can attach the speakers to the base of the unit or use them separately.

How to mount the speakers onto the base of the unit

1. Tilt the unit backward until its base faces to yourself (See next page How to Adjust the View Angle).
2. Prepare your right speaker first. Remove the tube of hooks and verify that the hooks place in the upright position.
3. Align the right speaker hooks with the cavity holes marked with "SPEAKER" under the base.
4. Slide the right speaker inward till the tension hooks are securely locked as shown in Figure below.
5. Repeat step 2~4 for the left speaker.

※ The right and left speakers are labeled R (Right) and L (Left) on their rear, respectively.

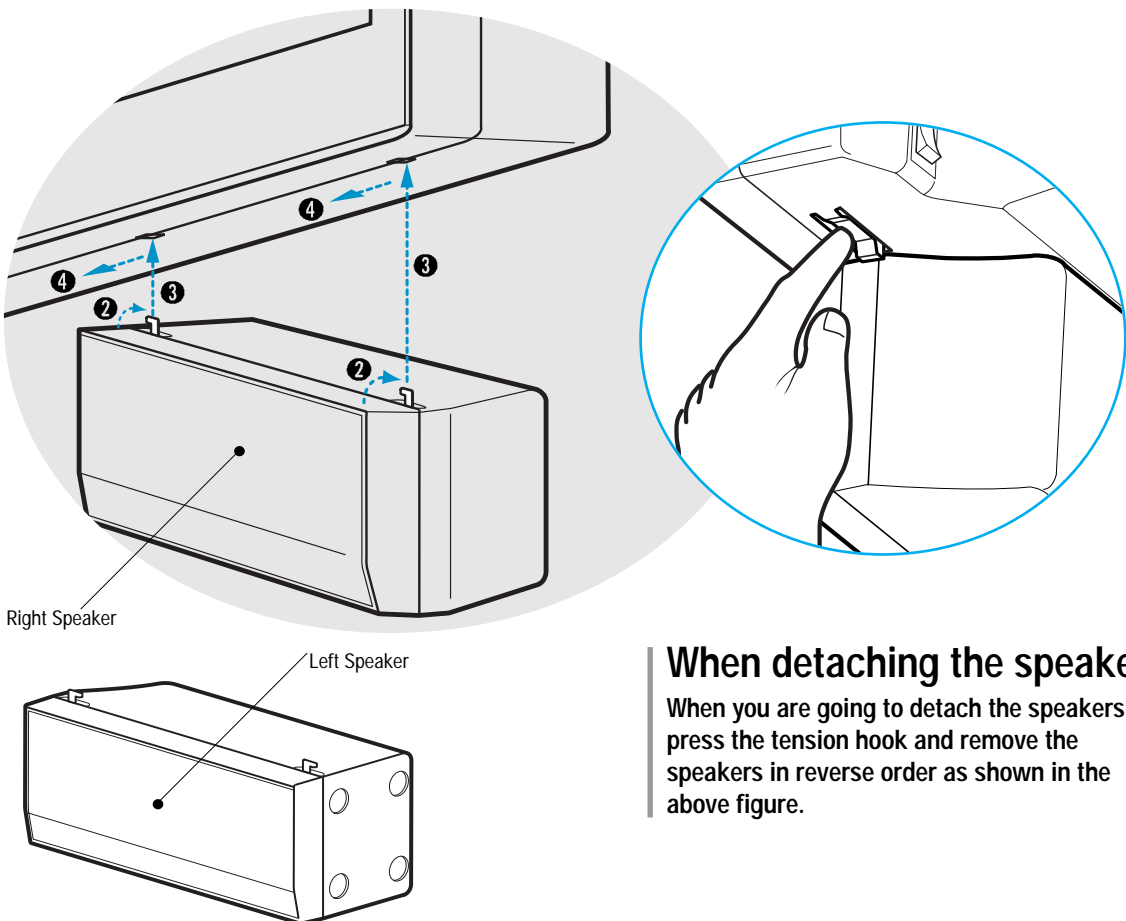

When detaching the speakers

When you are going to detach the speakers, press the tension hook and remove the speakers in reverse order as shown in the above figure.

WARNING

The provided speakers are designed for this product only. It is recommended not to connect the speakers to other device. When connecting other amplifier, the amplifier output should be within 10W. The output that exceeds 10W may cause fire.

ALERT

Make sure to remove the speakers before moving the TV. When the speakers are detached from the unit while carrying it, this may cause damage to the unit or personal injury.



How to adjust the view angle - For A261/A321 Model only

You can adjust the panel downward or upward at a 0~15 degree angle.

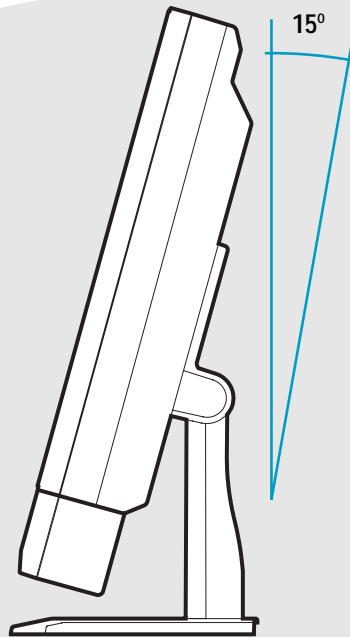

How To Install Desktop Stand - For A421S/A421H Model only

1. Place the TV body on a flat desk or a shelf. Clean the surface of the desk or the shelf in order to prevent scratch on the product.
2. Align the stand with TV body below and fasten the stand bars using 4 fixing screws.
3. After the assembly is over, stand the assembled product at a desired place.

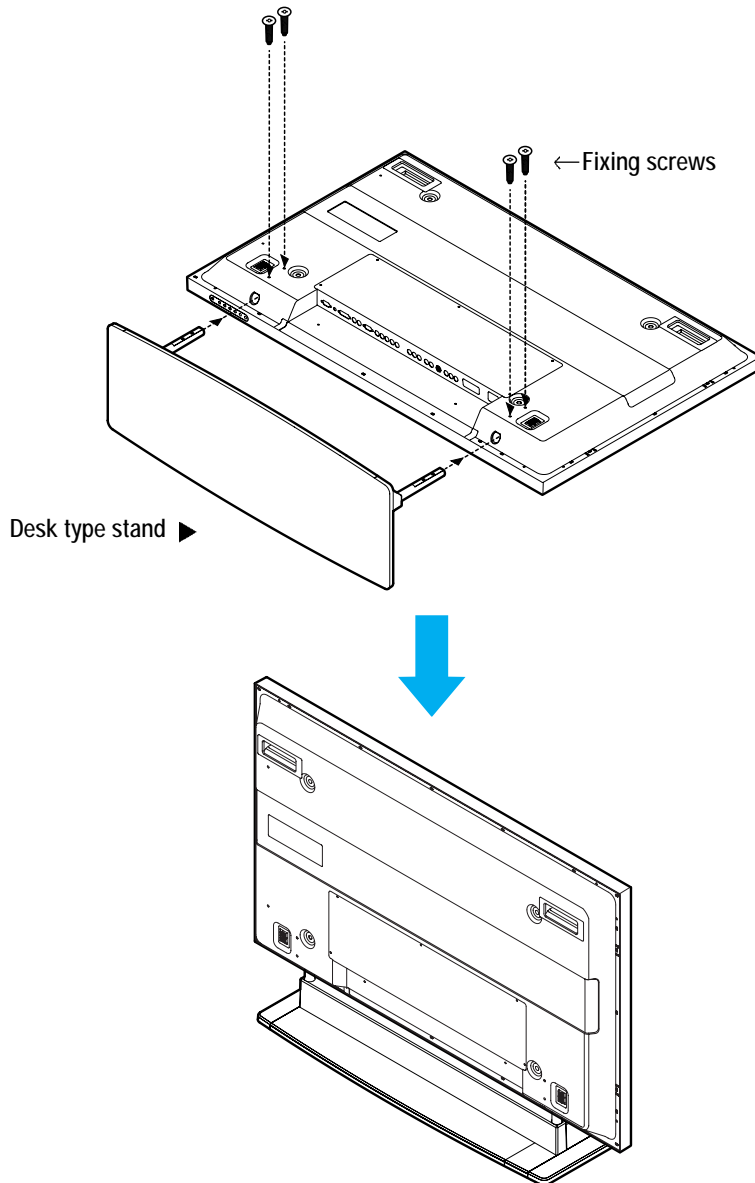

Warning : Do not install at an unstable place or on a small support.
(When a child plays around the product and touch it, TV may fall and injure the child.)



How To Use Speakers (Standing Type) - For A421S/A421H Model only

Parts configuration chart

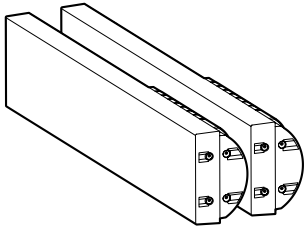

2 Speakers (left and right)

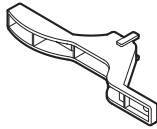

4 brackets



16 fixing screws



2 sets of speaker cables
(left and right)

Assembly and Connection Method

1

Insert brackets into the grooves on the rear of speakers and fasten them with fixing screws. (Left and right side each)

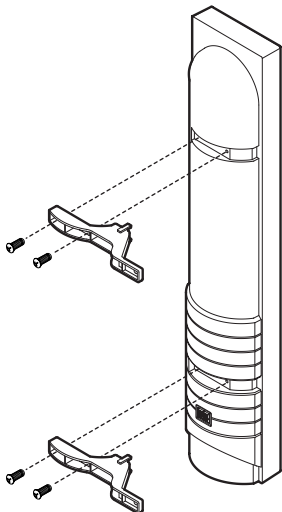

2

Fasten 1 with TV body using fixing screws. (Left and right side each)

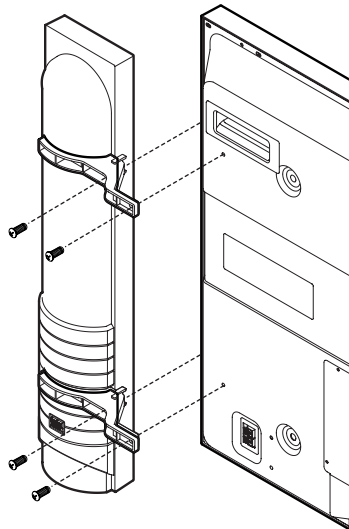

3

Connect speaker cables between terminals on the rear of speakers with speaker connection terminals on the rear of TV. (Connect cables and terminals in the same color)

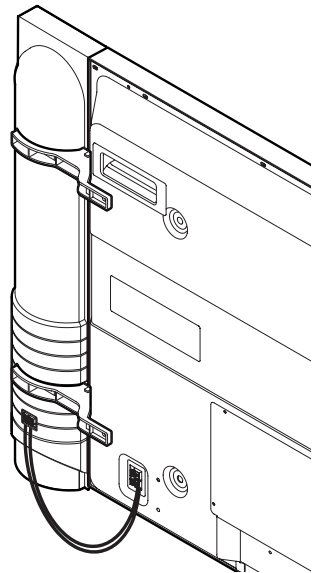

WARNING

Do not move the product holding the speakers. Always use handles on the TV. (Brackets connecting TV and speakers may be damaged.)

How To Use Speakers (Desk Type) - For A421S/A421H Model only

Parts configuration chart

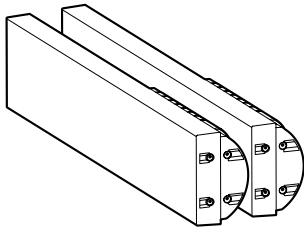

2 Speakers (left and right)

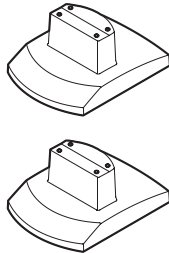

2 Speaker-stands (left and right)



8 fixing screws



2 sets of speaker cables (left and right)

Assembly and Connect method

1

Insert speaker-stands in the groove on the bottom of speakers and fasten them using fixing screws. (Left and right side each)



2

Upright 1 and place them on the desired place left and right of TV. (Left and right side each)



3

Connect speaker cables between terminals on the rear of speakers and speaker connection terminals on the rear of TV. (Connect cables and terminals with the same color)

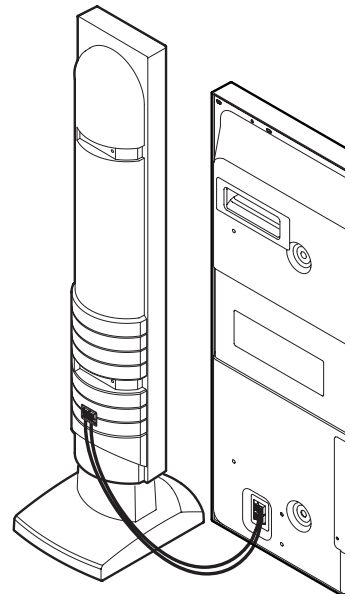
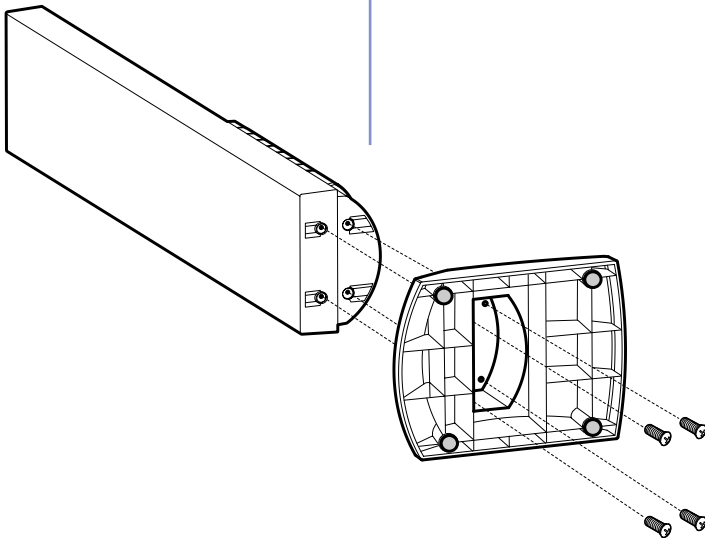



Parts Names and Functions - For A261/A321 Model only

Front View

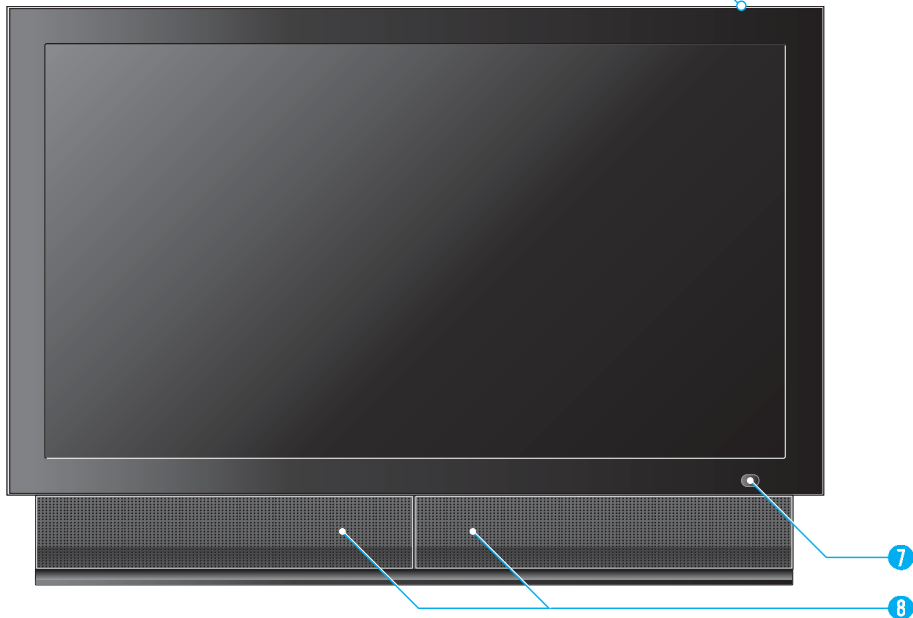
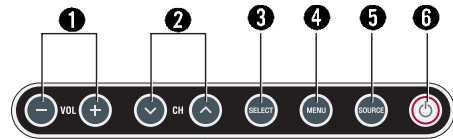

* This product image may be a bit different from the actual product.

❶ Volume buttons

Use these buttons for your desired sound level. These buttons also serve as the cursor of Select/Adjust when in Menu mode.

❷ Channel buttons

Use these buttons to change channels. These buttons also serve as the cursor of Down and Up buttons when in Menu mode.

❸ Select button

Use this button to select each item of menu.

❹ Menu button

Use this button to display or exit from menus.

❺ Source button

Use this button to switch among inputs connected to the TV.

❻ Power button

Use this button to turn on or off the TV.

❼ Remote sensor and power LED.

- Point the remote control toward here.
- It displays standby or operation status.

- Power Indicator Status -

Indicator	Status
Red	Standby
Green	Power on

❽ Speakers

See page 12 for information on how to mount speakers.

Rear View

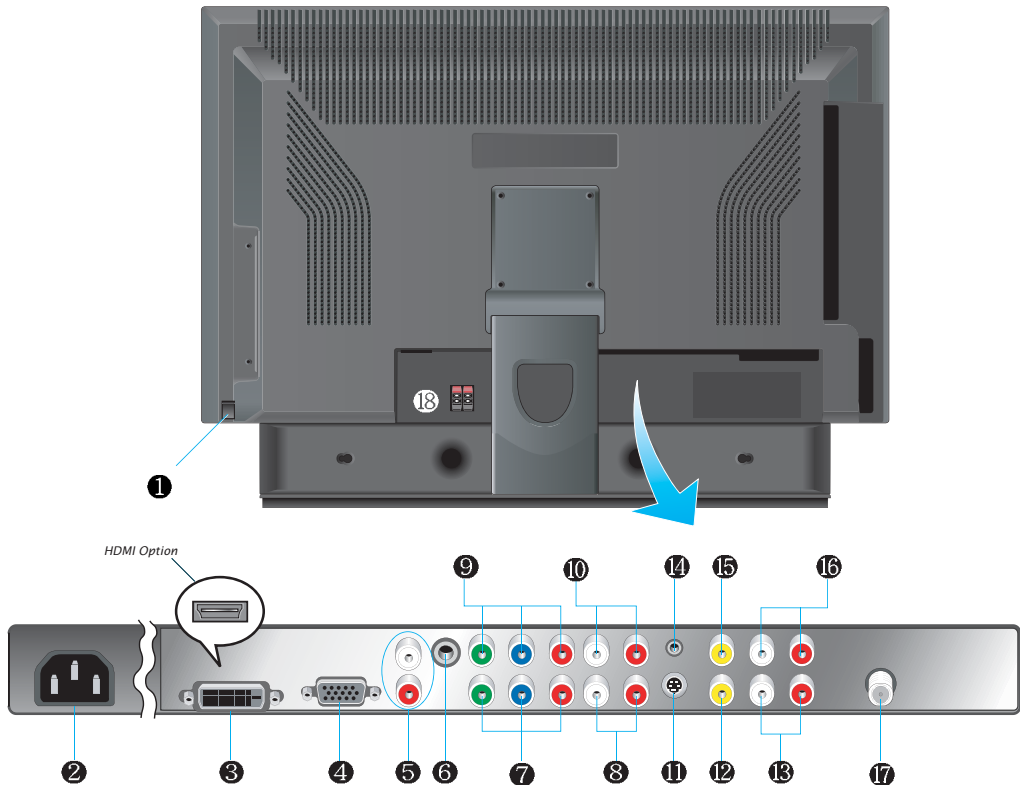

* This product image may be a bit different from the actual product.

- | | | |
|--|--|---|
| <ul style="list-style-type: none"> 1 Power switch
Use this switch to turn on/off power. 2 Power (AC) input terminal
Connect the power cord to this terminal. 3 HDMI (or DVI) Video input terminal 4 D-SUB input terminal 5 HDMI (or DVI)/D-SUB Audio input terminal 6 Subwoofer output terminal
When producing bass, connect the cable to the woofer with *AMP. 7 Component 2 Video input terminal | <ul style="list-style-type: none"> 8 Component 2 Audio input terminal 9 Component 1 Video input terminal 10 Component 1 Audio input terminal 11 S-Video input terminal 12 Video input terminal 13 S-Video/Video Audio input terminal 14 RS-232 input terminal
Connect to the RS-232 terminal of a PC to check its service. 15 Monitor Video output terminal 16 Monitor Audio output terminal 17 Antenna input terminal | <ul style="list-style-type: none"> 18 Speaker terminal
Connect your speaker jacks |
|--|--|---|