

ATTACHMENT E.

- USER'S MANUAL -



FCC Information

User Instructions

The Federal Communications Commission Radio Frequency Interference Statement includes the following warning :

NOTE : This equipment has been tested and found to comply with the limits for a Class B digital device pursuant to Part 15 of the FCC Rules.

These limits are designed to provide reasonable protection against harmful interference in a residential installation. This equipment generates, uses, and can radiate radio frequency energy and, if not installed and used in accordance with the instructions, may cause harmful interference to radiocommunications. However, there is no guarantee that interference will not occur in a particular installation.

If this equipment does cause harmful interference to radio or television receptions, which can be determined by turning the equipment off and on, the user is encouraged to try to correct the interference by one or more of the following measures :

- Reorient or relocate the receiving antenna.
- Increase the separation between the equipment and receiver.
- Connect the equipment into an outlet on a circuit different from that to which the receiver is connected.
- Consult the dealer or an experienced radio/TV technician for assistance.

User Information

Changes or modifications not expressly approved by the party responsible for compliance could void the user's authority to operate the equipment. Connecting of peripherals requires the use of grounded shielded signal cables.

Important Tip

Image Retention Effect (Image Sticking)

1. Cause :

- Image Retention Effect may come from displaying a still picture in certain period of time with at a certain area continuously, as the feature of LCD panel. This is caused due to brightness degradation. Many LCD manufacturers are trying to overcome this limitation.

2. Prevention

- To avoid this matter, use the product after reducing brightness and contrast, especially when a still image is displaying for a long time. (Contrast 50/Brightness 50 - [See 32 page](#))
Once image retention occurs, use the mode that displays more motion pictures. It will help reduce this matter.

3. Solution

- The temporary image sticking would decrease with displaying Full-White pattern during 10 hours.
* The permanent image sticking could not take off under the latest technology.
This method may be used to eliminate a temporary retained image that occurs after displaying a still image for a certain period of time. Since it may take several minutes to several hours to remove image sticking, it is recommendable to display motion pictures during 2~3 minutes every hour when keeping displaying a still image. As image sticking is influenced by the brightness of a still image being displayed and its display time, it is recommended that you reduce the brightness of the screen when displaying a still image for a long time.

* Image Sticking does not come under the warranty.



Image Sticking Precaution

When watching a still Image within motion pictures and Panorama/Wide/4:3 screen

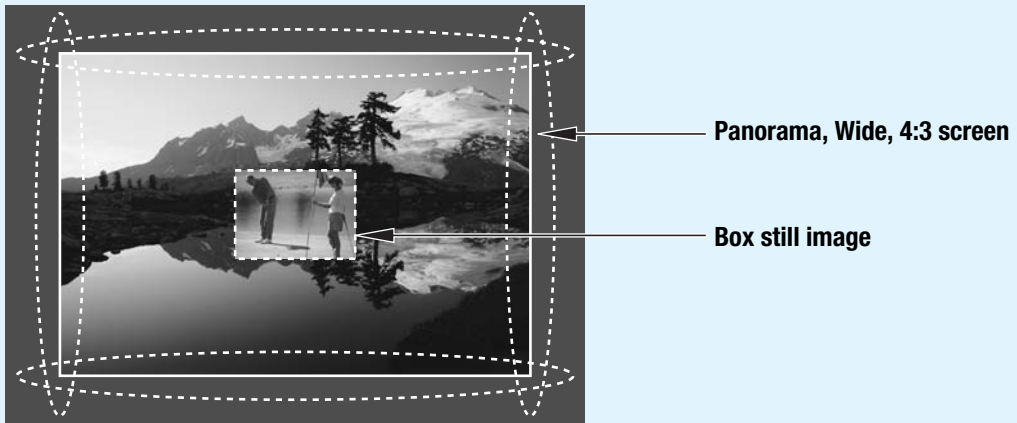

1. Note :

- When the central area of the screen and the screen edges are fixed, the different brightness level of the edges may cause image retention on the edges when watching for a long time
- This phenomenon is the same matter to other LCD manufacturers. Please do not watch a still image for a long time.
- If you watch a still image for a long time, this may damage your TV.

* This matter does not come under the warranty.

Features

Integrated HDTV

An HDTV has a built-in ATSC digital tuner. It does not need a separate set-top box to receive over-the-air DTV signal.

Dual Scan/Multi-Viewing

You can program analog TV broadcasting and digital TV broadcasting automatically at the same time for multi-viewing.

A Wide Array of Screen Settings

You can choose different screen settings depending on the type of program you are watching or the surrounding conditions (the outside weather conditions). You can switch among Standard, and Mild options or you can configure the screen settings for yourself.

A Wide Array of Sound Settings

You can choose an optimal sound setting for the type of program you are watching. You can switch among custom Standard, movies, Music, and Speech options or you can configure the sound settings for yourself.

Favorite Channel Memory

You can memorize the channels you are watching frequently.

SRS TrueSurround XT

You can enjoy dynamic and surround sound with ordinary speakers.

Dolby-Digital

When receiving digital broadcast signal, you can enjoy dynamic and surround sound with two ordinary speakers just like Dolby 5.1.

A Variety of Aspect Ratios

You can adjust the screen size at your preference.

Auto On/Off Function

This function allows you to turn on or off your TV at the preset time.

Game Prevention Function

This function is designed to prevent a VCR or game player from being connected to the TV.



Table of Contents

General Information

Safety Precaution	5
Contents of the Package	9
Products Sold Separately	9
Kensington Lock Anti-theft Device	10
How to Mount and Detach The Speakers	11
How to adjust the view angle	12
Parts Names and Functions	13
Remote Control	17

Connections

How to Watch Both Analog and Digital Broadcasts with a Single Antenna	19
How to Watch Both Analog and Digital Broadcasts with Two Antennas	20
Before Connecting the Video/Audio Connections to External Devices... ..	21
How to Connect a VCR/Cable Receiver	22
How to Connect a DTV Receiver or DVD Player	23
How to Connect a Camcorder/Game Player	24
How to Connect to a PC	25
HDMI Connection	27
How to Connect an External Visual Device	29
How to Use Digital Sound	30

Picture Setup

How to Select the Picture Mode	31
How to Set the Desired Picture	32
How to Adjust the Color Temperature of the Screen	33
How to Select the Aspect Ratio	34
How to Watch the PIP	36
How to Set the INPUT for the Sub-Picture	37
How to Reduce Noise	39

Sound Setup

How to Select the Audio Mode	40
How to Adjust the Desired Audio Mode	41
How to Use the Automatic Volume Control	42

How to Select MTS(Multi-Channel Sound)	43
How to Listen to SRS TruSurround XT (Surround)	44
How to Set the Output of Subwoofer	45
How to Set the Audio Output	46
How to Set the Digital Audio Output	47
How to Set Audio Language	48

Channel Setup

How to Store Channels Automatically	49
How to Add/Eraser Channels Manually	50
How to Set Favorite Channels	51
How to Fine Tune Channel Reception	52
How to the LNA (Low-Noise-Amplifier) Feature	53

Function Setup

How to Choose Your Language	54
How to Set Clock, On/Off Time, Sleep Time	55
How to Set the Geometry in PC Mode	57
How to Set Key Lock	58
How To Set Block Program	60
How to View Closed Captions	62

DTV Setup

How to Use the Current Channel Guide	64
How to Reserve TV Programs Using the Total Channel Guide	64
How to Use TV Program Reservation	65
How to Check or Cancel a Scheduled TV Program	66

How to Use Memory Mode

Appendix

How to Use an External Device Using the Remote Control	75
Glossary	78
Troubleshooting	81
Care and Cleaning	83
Product Specifications	84



Safety Precaution

The contents of this section are provided for the safety of users and their property. Please read the instructions carefully before using.

Outdoor Antenna Grounding

If an outside antenna or cable system is connected to the TV, be sure the antenna or cable system is grounded so as to provide some protection against voltage surges and built-up static charges. Section 810 of the National Electrical Code, ANSI/NFPA No.70-1984, provides information about proper grounding of the mast and supporting structure, grounding of the lead-in wire to an antenna discharge unit, size of grounding conductors, location of antenna discharge unit, connection to grounding electrodes, and requirements for the grounding electrode.

Example of Grounding According to National Electrical Code Instruction

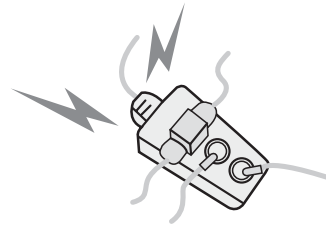
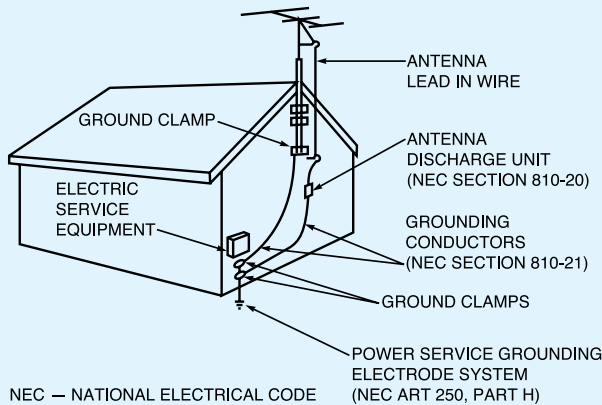

Do not connect multiple electrical appliances to a single outlet.

- It may cause a fire due to overheating from the outlet.

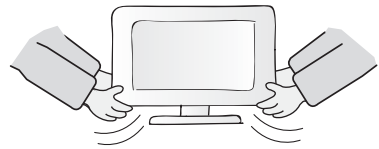

Make sure to remove the speakers before moving the TV with speakers mounted on it.

- When the speakers are detached from the unit while carrying it, this may cause damage to the unit or personal injury.

Do not use or store a flammable spray or inflammable things near the TV.

- They may cause explosion or fire.

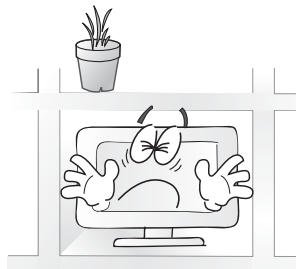
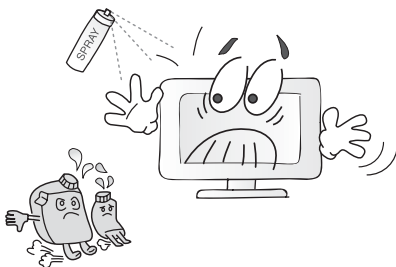

Do not install the TV in a bookshelf, closet, or a place where there is poor air circulation.

- Fire may be caused due to the rise of internal temperature.

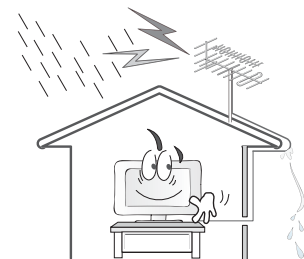

Any necessary action such as making the antenna cable loop at the entrance of the building should be taken to prevent rainwater on the outdoor antenna cable from possibly running into the indoor.

- If raindrop gets into the LCD TV, it may cause a fire or an electric shock.

If there is a persistent accumulation of dusts or water on the plug, please make sure to wipe it off using a dry cloth.

- It may cause a fire or an electric shock.

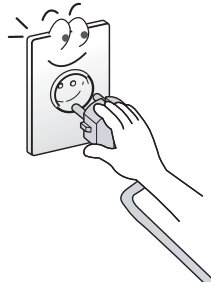

Firmly plug in the power cord so that it does not pull out.

- An unstable connection may cause fire.

Do not use a damaged power cord or plug, or loose outlet.

- It may cause electric shock or fire.

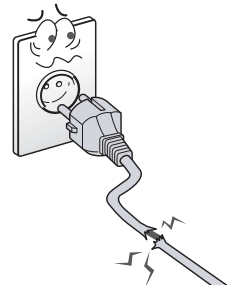

Do not put a water bowl, vase, candle, bug repellant, smoke, cigarette, plants, or heavy thing on the TV.

- It may cause electric shock or fire and also heavy things may cause injury when they fall.

Do not install in a place where there is oil, smoke, excessive humidity, or where water may be sprinkled on it.

- This may cause electric shock or fire.

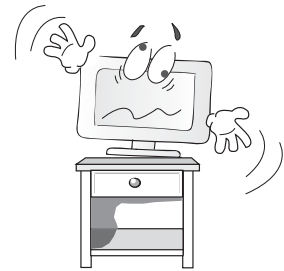

Do not install on an unstable place or small support.

- This may cause the TV to fall, resulting in serious injury to a child or adult.

Never attempt to open, fix, or modify your TV.

- When there is a need for fixing, call a service center. Fire or electric shock may be caused.



Do not put a metallic object like chopstick, wire, or puncher or inflammables like paper or a match in a vent, headphone jack, or AV jacks of the TV.

- Electric shock or fire may be caused.

When the TV produces abnormal noise, burning smell, or smoke, unplug the TV immediately and call a service center.

- Electric shock or fire may be caused.





Safety PrecautionContinued from previous page

The contents of this section are provided for the safety of users and their property. Please read the instructions carefully before using.

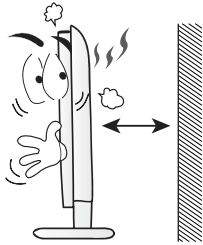

Keep the TV at least 10cm away from the wall for ventilation.
- Fire may be caused due to the rise of inner temperature.



Do not place any heat sources such as radiators and heat registers, etc. near the TV.
- It may cause a fire.

Do not block ventilating slits with a table cloth.
- Blocking the ventilation slits may produce inner heat increase, resulting in a fire.

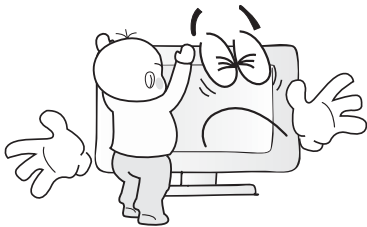

Do not allow children to climb or play on the TV.
- If it falls over on children, it may cause serious injury.

Do not place toys and cookies, etc. on the TV, which may attract children's attention.
- If it falls over on children, it may cause serious injury.

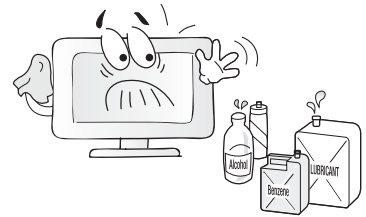

When cleaning the TV, make sure to disconnect the power plug and use a dry, soft cloth for a cleanup.
- Please avoid using chemicals such as wax, benzene, alcohol, thinner, mosquito spray, air freshener, lubricant or synthetic detergent.

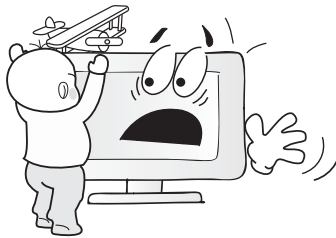

Unplug when you do not use your TV for a long time.
- If dust is stacked on the TV, electric shock or fire may be caused from heat, fire, or deterioration of insulation.

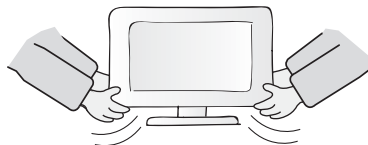

Consult a service center or customer service for inside cleaning about once a year.
- When dust is piled inside the TV for long time, fire or malfunction may be caused.



When moving the TV, two or more people are advised to carry it.
- Injury or damage may be caused when the TV falls.



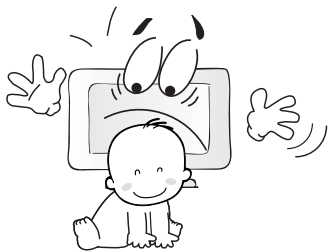

Do not install the product on the floor.
- If it falls over, your child may be injured.

Unplug the product during lightning or thunderstorms and never touch the antenna cable.

- It may cause a fire or an electric shock.

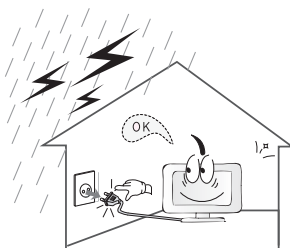

Keep the remote control batteries out of sight and out reach of children.

- If your child swallows a battery, see your doctor immediately.

When replacing batteries, make sure to match the batteries to the (+) and (-) marks in the battery compartment.

- Mismatching of polarities may result in internal damage to batteries, fire due to leakage or contamination.

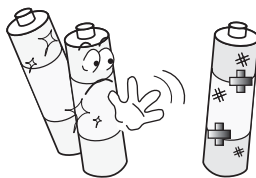
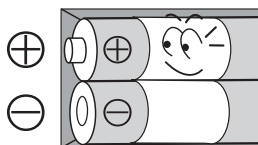

Always use the standard batteries and avoid using old batteries together with new ones.

- Otherwise it may result in internal damage to batteries, fire due to leakage or contamination.

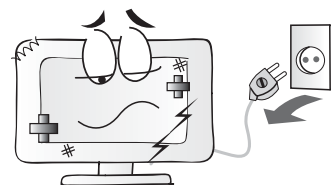

In the event of damaging or dropping the product, switch off the power and remove the plug.

- Using a damaged product may cause an electric shock or a fire.
- Contact your local service center.

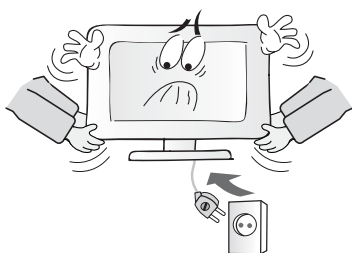

Before moving the product, ensure to switch off the power and unplug all the electrical cords and the external connection cords such as an antenna cable and other source connections, etc.

- An electrical cord(s) may be damaged, resulting in a fire or an electrical shock.

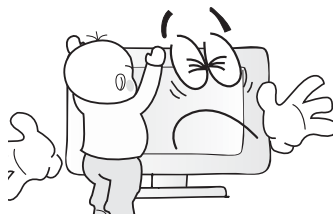

Ensure the power cord doesn't trail across any hot objects like a heater.

- This may cause a fire or an electric shock.

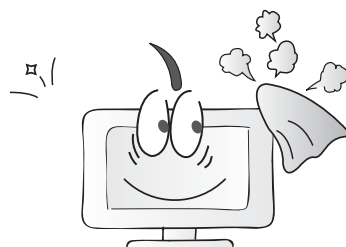

Consult a service center or customer service for inside cleaning about once a year.

- When dust is piled inside the PDP for long time, fire or malfunction may be caused.



Contents of the Package

When opening the package, please ensure to check the following accessories provided.

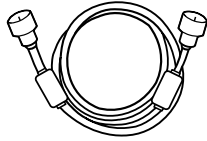

Antenna Cable
(coaxial cable)

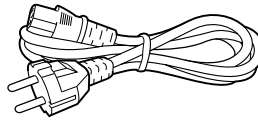

Power Cord

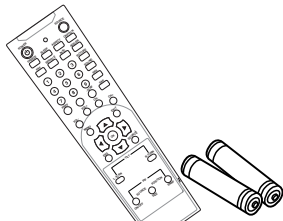

Remote Control & 2 batteries
(1.5V AAA)

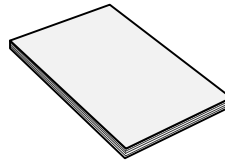

User's Guide

Products Sold Separately

If you want to purchase separately sold products, consult a service center, electronics shops, or parts seller.



HDMI cable

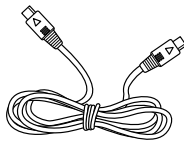

S-video Cable

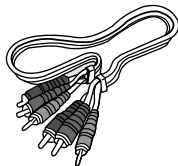

Component Cable
(Y, Pb, Pr)

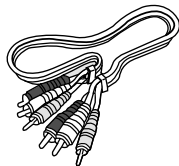

Composite Cable
(Video/Audio)

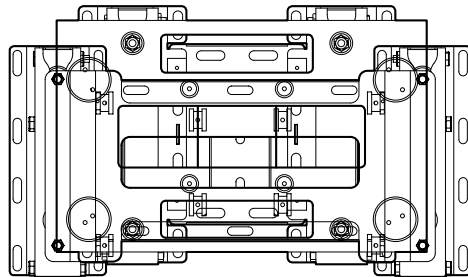

Wall Mounting Support

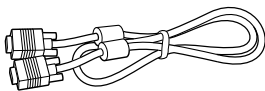

PC signal Cable (D-SUB)

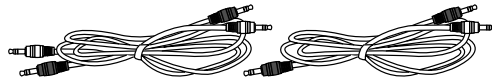

Audio Cable (DIV/DVD)

Audio Cable (PC)

Parts Names and Functions - For Q40* Model only

Front View

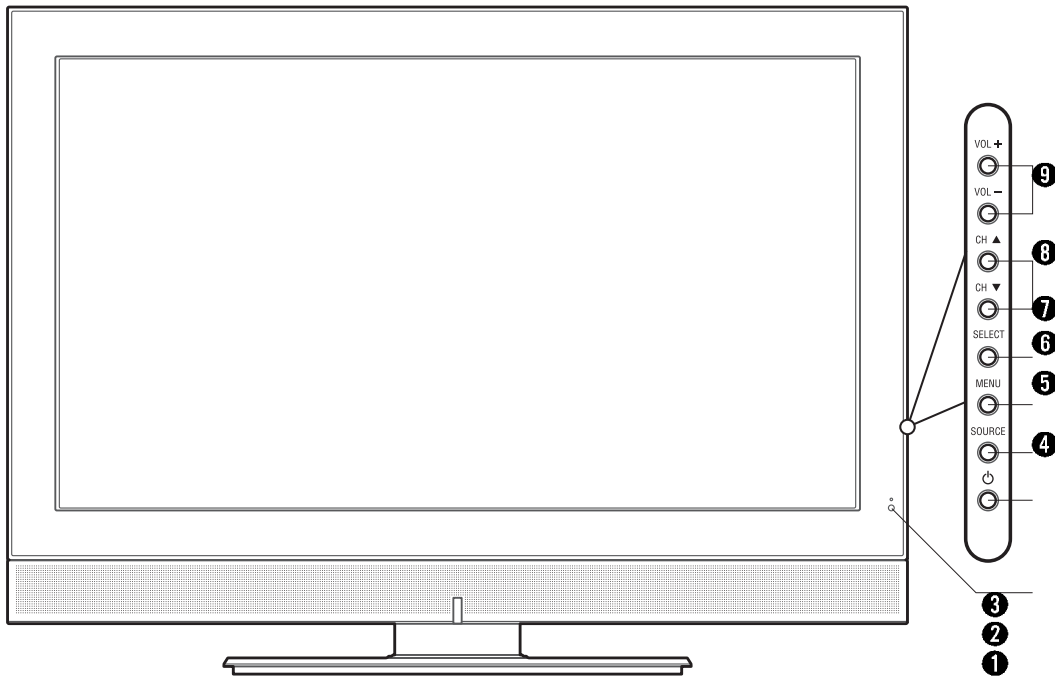

* This product image may be a bit different from the actual product.

1 Speaker

2 Power switch

Use this switch to turn on/off power.

3 Remote sensor and power LED.

- Point the remote control toward here.
- It displays standby or operation status.

- Power Indicator Status -

Indicator	Status
Red	Standby
Green	Power on

4 Power button

Use this button to turn on or off the TV.

5 Source button

Use this button to switch among inputs connected to the TV.

6 Menu button

Use this button to display or exit from menus.

7 Select button

Use this button to select each item of menu.

8 Channel buttons

Use these buttons to change channels. These buttons also serve as the cursor of Down and Up buttons when in Menu mode.

9 Volume buttons

Use these buttons for your desired sound level. These buttons also serve as the cursor of Select/Adjust when in Menu mode.



Rear View

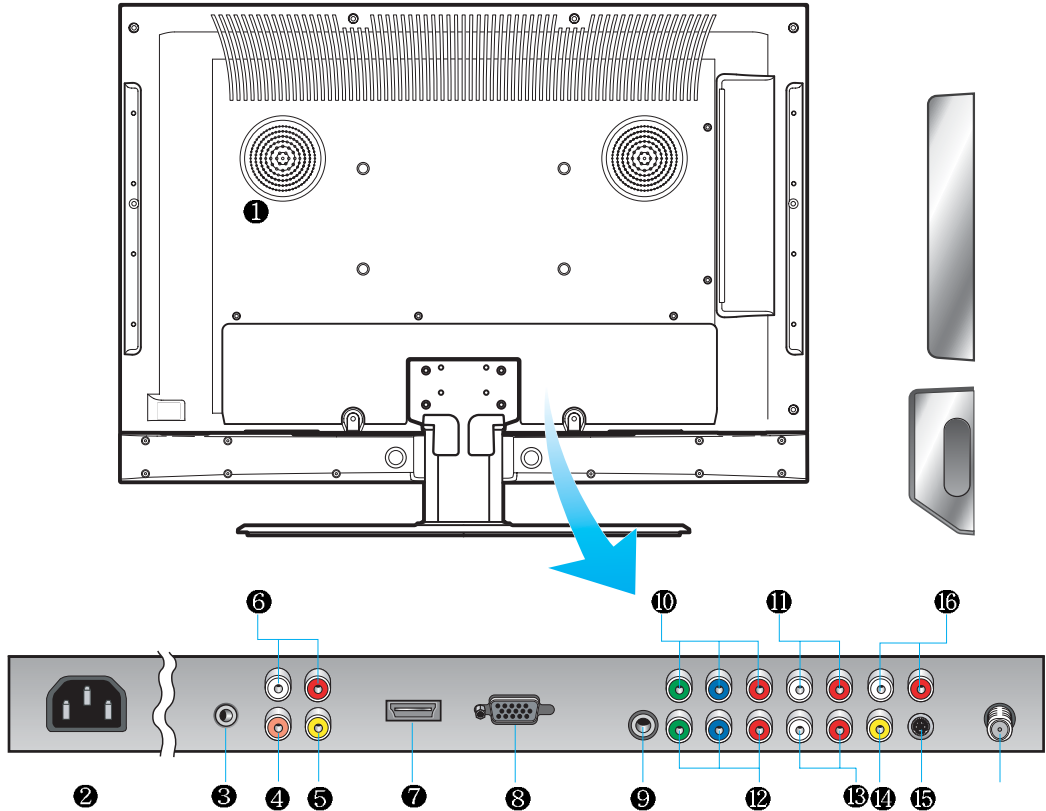

* This product image may be a bit different from the actual product.

- 1 Power Switch**
use this switch to tum on/off power
- 2 Power(AC) Input terminal**
Connect the power cord to this terminal.
- 3 RS-232 input terminal**
Connect to the RS-232 terminal of a PC to check its service.
- 4 S/P DiF optical digital audio output terminal**
- 5**
- 6**
- 7**
- 8 D-SUB input terminal**
- 9 D-SUB Audio input terminal**
- 10 Component 1 Video input terminal**
- 11 Component 1 Audio input terminal**
- 12 Component 2 Video input terminal**
- 13 Component 2 Audio input terminal**
- 14 Video input terminal**
- 15 S-Video input terminal**
- 16 S-Video/Video Audio input terminal**
- 17 Antenna (Analog/DTV) input terminal**

Rear View

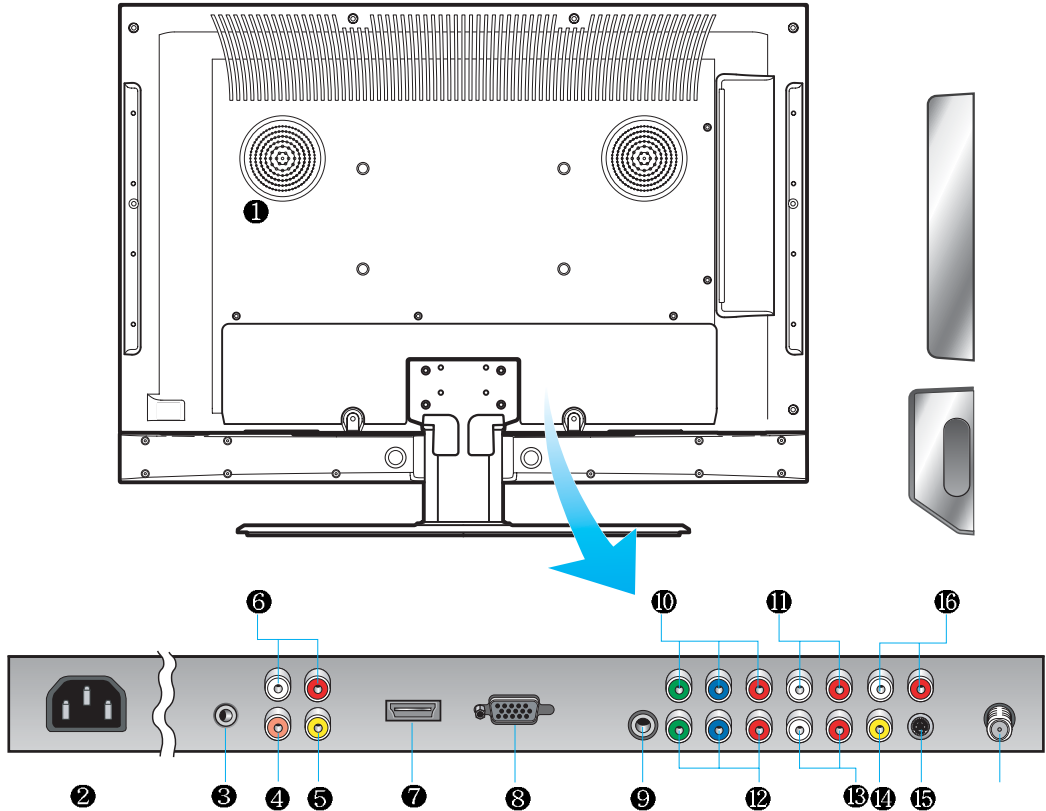

* This product image may be a bit different from the actual product.

- ① Power Switch
use this switch to turn on/off power
- ② Power(AC) Input terminal
Connect the power cord to this terminal.
- ③ RS-232 input terminal
Connect to the RS-232 terminal of a PC to check its service.
- ④ S/P DiF optical digital audio output terminal
- ⑤
- ⑥
- ⑦
- ⑧ D-SUB input terminal
- ⑨ D-SUB Audio input terminal
- ⑩ Component 1 Video input terminal
- ⑪ Component 1 Audio input terminal
- ⑫ Component 2 Video input terminal
- ⑬ Component 2 Audio input terminal
- ⑭ Video input terminal
- ⑮ S-Video input terminal
- ⑯ S-Video/Video Audio input terminal
- ⑰ Antenna (Analog/DTV) input terminal



Remote Control

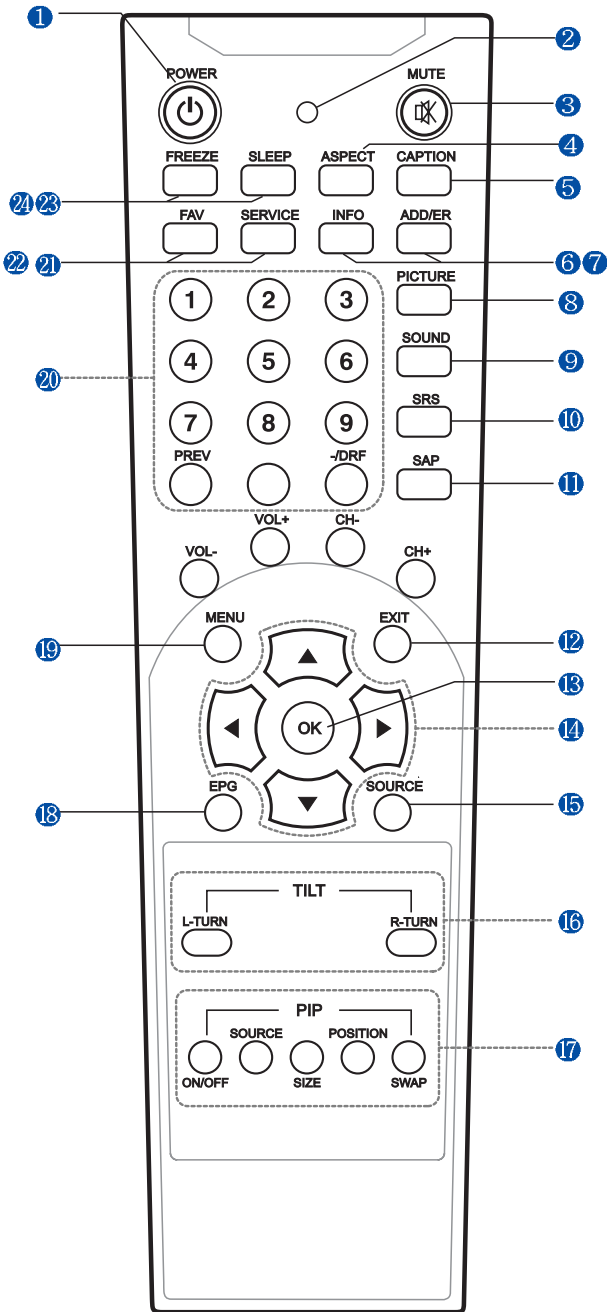

- 1. POWER/STANDBY
- 2. POWER LED
- 3. MUTE
- 4. ASPECT
- 5. CAPTION
- 6. ADD/ERASE
Use this button to add or erase channels.
- 7. INFOMATION
Use this button to display resolution or various program
- 8. PICTURE
- 9. SOUND
- 10. SRS
Use this button to select 3D surround sound.
- 11. SAP
- 12. EXIT
- 13. MENU SELECTION
Use this button to select menu item
- 14. LEFT/RIGHT MOVE/ADJUST
Use these buttons to move between menu items or to adjust each item.
- 15. SOURCE
- 16. TILT
- ON/OFF
:
- SIZE
: Use this button to select the size of sub-picture.
- SIZE
: Use this button to select the size of sub-picture.
- POSITION
: Use this button to select the position of sub-picture.
- SWAP
: Use this button to swap main and sub-picture.

18. EPG

19. MENU

Use this button to call the OSD to the screen.

20. NUMERIC KEYS

21. SERVICE

22. FAV

23. SELLP

24. FREEZE

How to Insert Batteries in Remote Control



* Battery type :1.5V/AAA



How to Watch Both Analog and Digital Broadcasts with a Single Antenna

You can watch both analog and digital broadcasts by connecting a single antenna.

Connection Method

- ➔ Make sure that the antenna cable is connected to ANT (ATV/DTV).
- Antenna or Cable service without a cable box connections
- For optimum picture quality, adjust antenna direction if need,

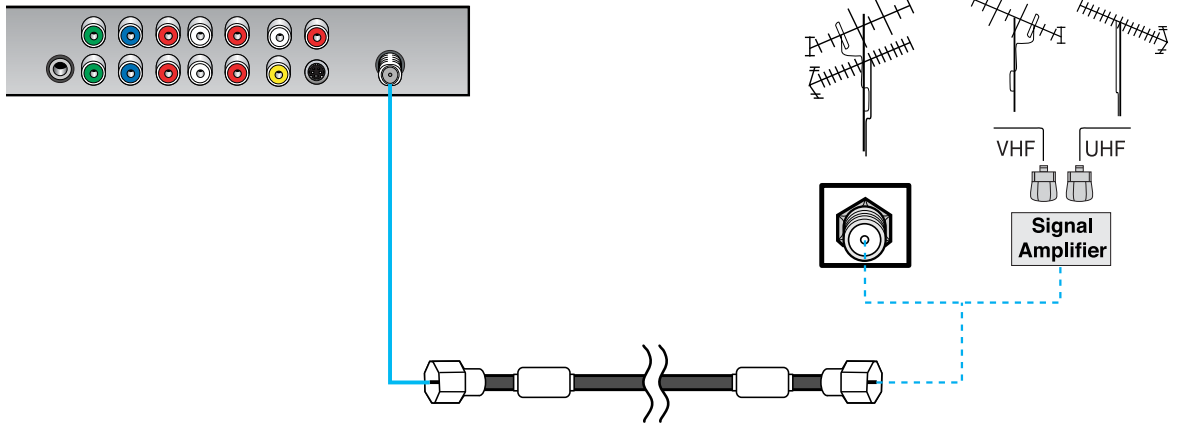

TIP

- When inserting a 75 Ω ohm coaxial cable into the input connection, ensure the wire tip not to bend.
- If you experience poor signal reception, we recommend you purchase a signal amplifier for better picture quality.

How to Watch

- 1 Turn on TV to activate Auto Channel (See page 49) to memorize the available channels.
- 2 Press **SOURCE** INPUT on remote control.
- 3 Press **Left/Right/Up/Down** to move to Analog TV or Digital TV and press **OK** to select.
- 4 Press **1 2 3** button or **CH-** button to select the desired channels.

Ex.) When you want to watch cable channel number 120, press +100 + 2 + 0 the digit buttons.

DTV
ANALOG TV
DTV
VIDEO
S-VIDEO
COMP 1
COMP 2
PC
DVI
MEMORY
↕ MOVE
⬅ SELECT

Before Connecting the Video/Audio Connections to External Devices...

Please make sure to read the following information on connection to enjoy best picture quality.

Video/Audio connectors

Types of video/audio cable :

- ① HDMI ② 15-Pin D-Sub ③ COMPONENT ④ S-VIDEO ⑤ COMPOSITE

Best picture quality is displayed in the following order.

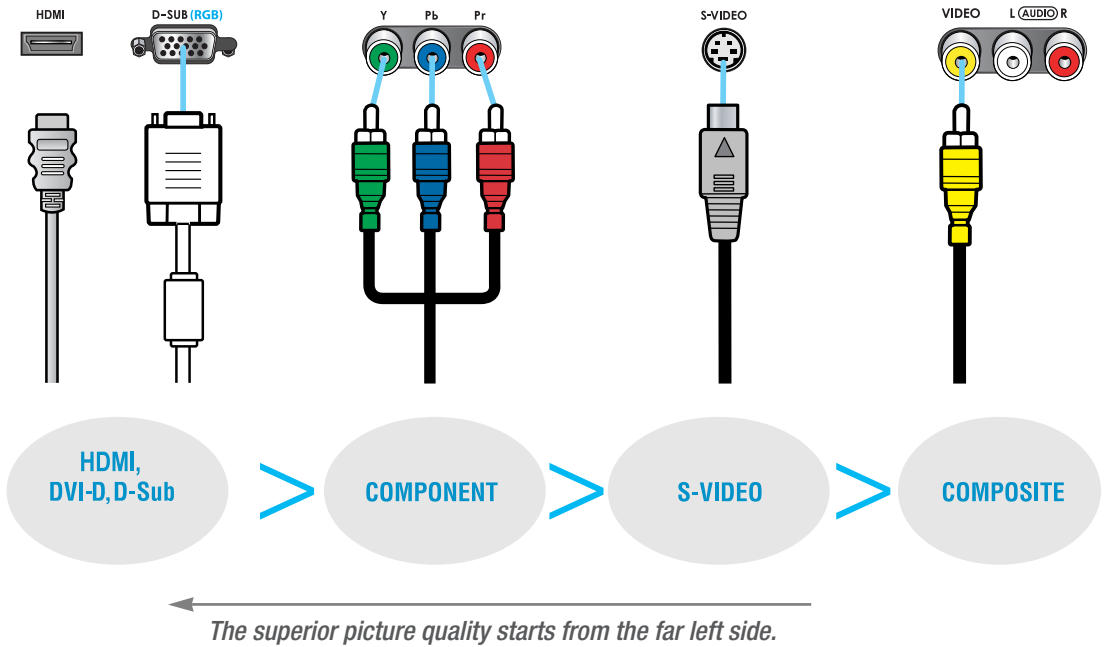

TIP

- When connecting an external device, ensure to read the connecting device's manual. The location or the number of the terminals on the external device may be different depending on its model.
- Connect a **HDMI (or DVI)** connection to the output of DVD, cable receiver or satellite receiver. Connecting a **HDMI (or DVI)** connection to a PC may result in a message, "Unknown Signal".
- Do not power on until all necessary connections are made. If power is given before connections completed, this may damage the product.
- Make sure to match the cable in color with the terminal.
- Make sure to check the type of terminals to be connected.





How to Connect a VCR/Cable Receiver

Connection Method

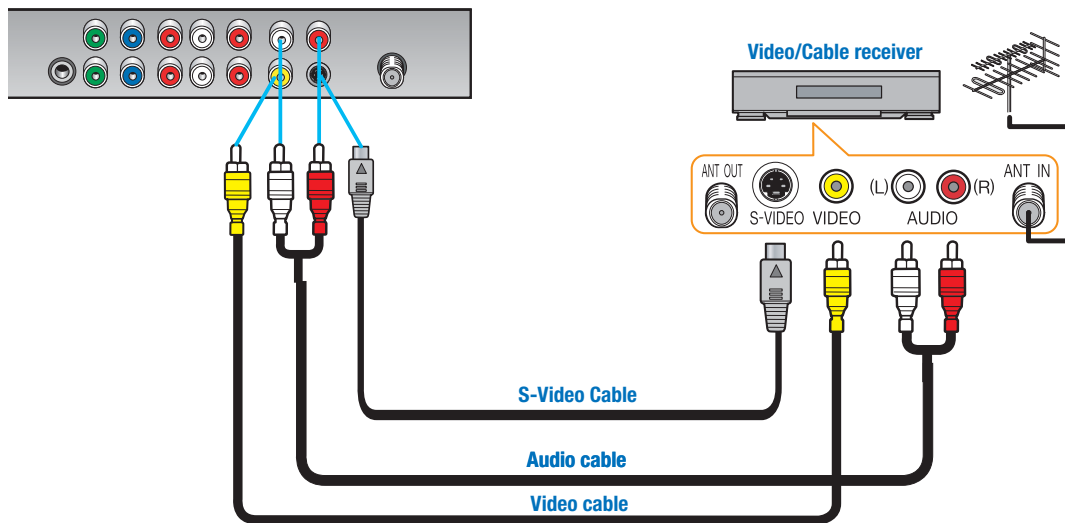
- 1 Connect the Video cable or S-Video cable between Video/S-Video output terminal of VCR or Cable receiver and Video/S-Video input terminal of TV. (Connect the jacks to terminals in the same color.)
- 2 Connect the Audio cable (Left: white, Right: red) between Audio output terminal of VCR or cable receiver and Audio input terminal of TV. (Connect the jacks to terminals in the same color.)



How to Watch

- 1 Turn on TV to press **SOURCE**  on remote control.
- 2 Press  to move to Video or S-Video and press  to select.
For more information, read the user's guide of VCR or cable receiver.

VIDEO
ANALOG TV
DTV
VIDEO
S-VIDEO
COMP 1
COMP 2
PC
DVI
MEMORY
↕ MOVE
← SELECT



To enjoy better picture quality, use the S-Video cable rather than the composite cable.



How to Connect a DTV Receiver or DVD Player

Connection Method

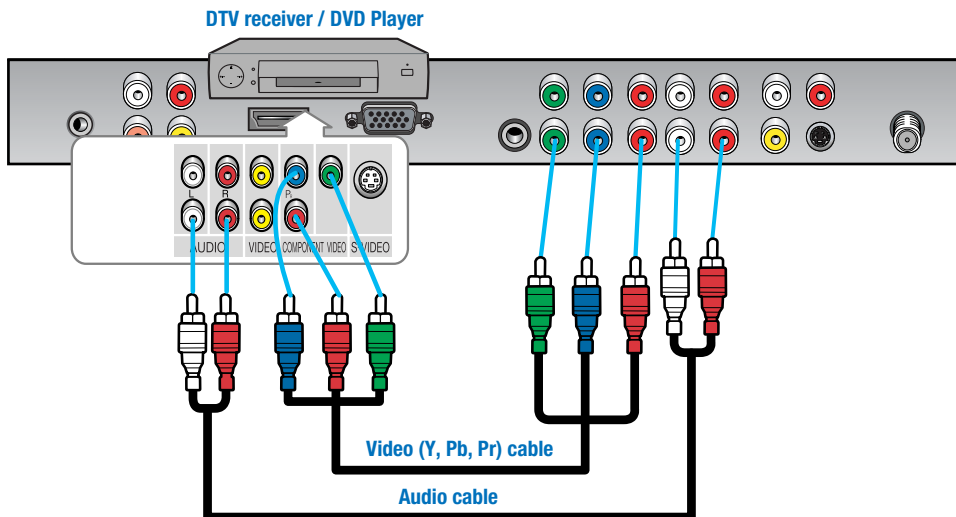
- 1 Connect the Video cable (Y, Pb, Pr) between output terminals (Y, Pb, Pr) of DTV receiver or DVD player and the input terminals (Y, Pb, Pr) of DTV/DVD (480i/480p/720p/1080i) on the rear of TV. (Connect the jacks to terminal in the same color.)
- 2 Connect the Audio cable between Audio output terminal of DTV receiver or DVD player and Audio input terminal for DTV/DVD Audio on the rear of TV. (Connect the jacks to terminals in the same color.)



How to Watch

- 1 Turn on TV and press SOURCE  on remote control.
- 2 Press  to move Component 1 or Component 2 and press  to select.

For more information, read the user's guide of DTV receiver or DVD player.

COMP 1
ANALOG TV
DTV
VIDEO
S-VIDEO
COMP 1
COMP 2
PC
DVI
MEMORY
↔ MOVE
← SELECT

TIP

- Output terminal mark (Y, Pb, and Pr) of DVD player may be indicated as Y, B-Y, R-Y/Y-Cb-Cr /Y-Pb-Pr according to the type of DVD player models.
- If your DVD player or Set Top Box supports **HDMI (or DVI) /D-SUB**, see Connecting to a PC (page 25) for connection. You can enjoy more clear picture quality.



How to Connect a Camcorder/Game Player

Connection Method

- 1 Connect the Video/S-Video cable between Video/S-Video output terminal of Camcorder/Game player and Video/S-Video input terminal of TV. (Connect cables and terminal in the same colors.)
- 2 Connect the Audio cable (Left-white, Right-red) between Audio output terminal of Camcorder/Game player and Audio input terminal of TV. (Connect the jacks to terminals in the same color.)

CONNECTIONS

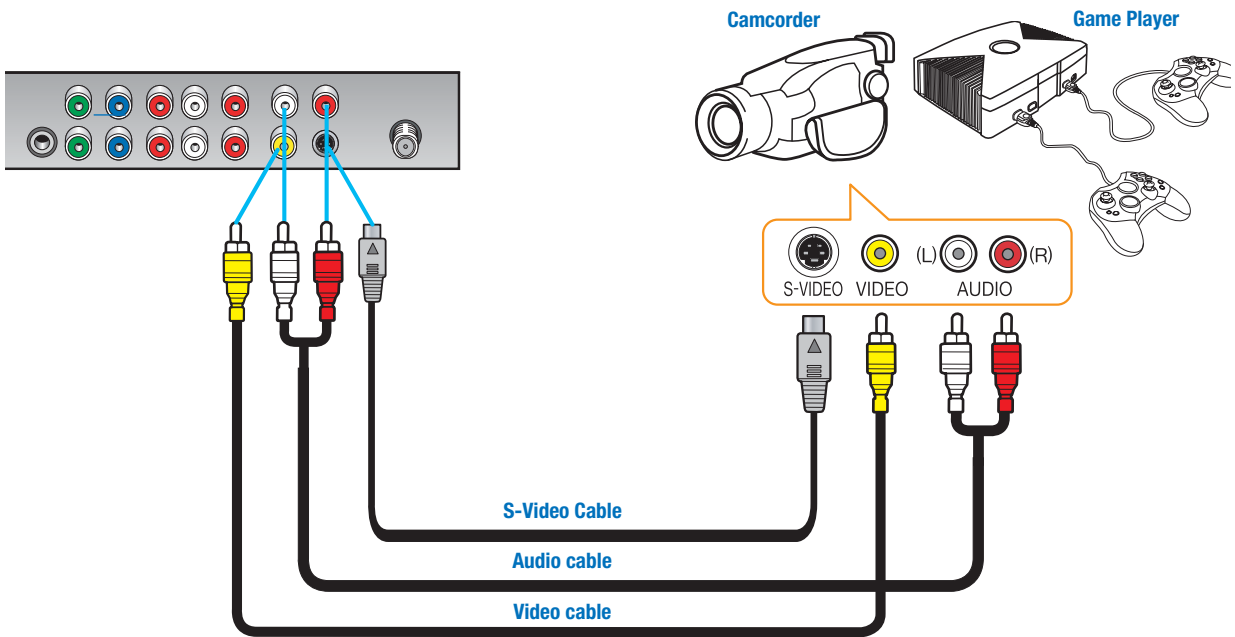

How to Watch

- 1 Turn on TV and press **SOURCE** on remote control.
- 2 Press to move Video or S-Video and press **OK** to select.

For more information, read the user's guide of Game player or Camcorder.

VIDEO
ANALOG TV
DTV
VIDEO
S-VIDEO
COMP 1
COMP 2
PC
DVI
MEMORY
↔ MOVE
← SELECT

How to Connect to a PC

Connection Method

- 1 Connect the PC signal cable (15-pin D-sub) between the output terminal of PC and the D-sub input terminal of TV.
- 2 Connect the Audio cable between Audio output terminal of PC and Audio input terminal for PC on the rear of TV. (Connect the jacks to terminals in the same color.)

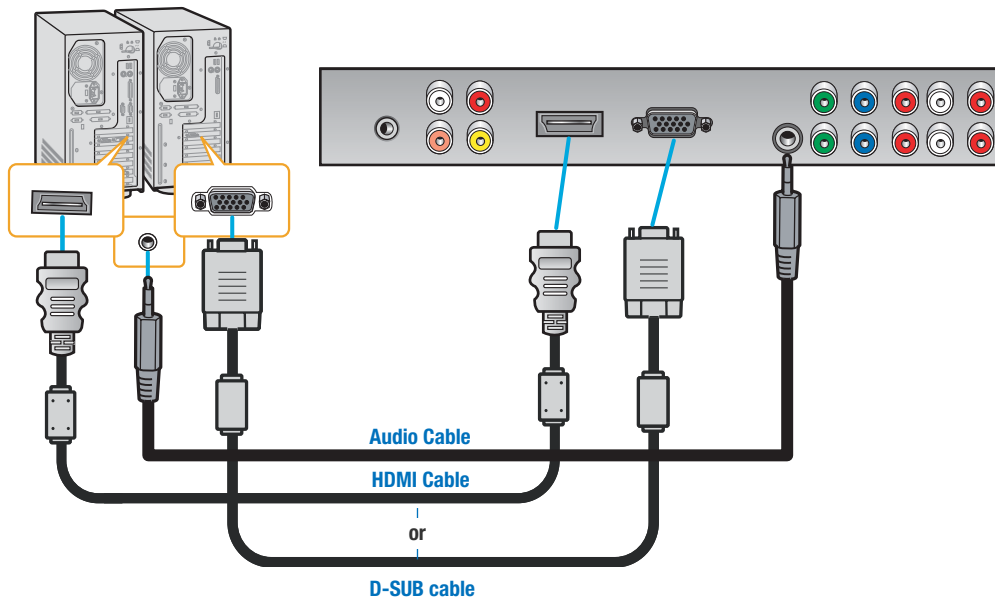

When Using as a PC Monitor

- 1 Turn on TV and press **SOURCE** on remote control.
- 2 Press **← →** to move to PC or HDMI (or DVI) and then press **OK** to select.

PC
ANALOG TV
DTV
VIDEO
S-VIDEO
COMP 1
COMP 2
PC
DVI
MEMORY
↕ MOVE
↵ SELECT

TIP

- If you use the **HDMI (or DVI)** connection, you can enjoy better picture quality.
- This product supports Plug-and-Play function.
- We recommend the above method if the DVD player or set top box supports DTV signal with **HDMI (or DVI)/D-Sub (15 pin)** cable for the better picture quality.
- If you input an unsupported resolution in PC or **HDMI (or DVI)** mode, the screen won't be displayed properly.



Resolutions Supported in PC

Resolution	Horizontal frequency	Vertical frequency
640 x 480	31.47	59.94
	37.50	75.00
720 x 400	31.47	70.08
800 x 600	37.88	60.32
	46.88	75.00
1024 x 768	48.36	60.00
	56.50	70.10
	60.02	75.03

HDMI Connection - For HDMI Model only

HDMI *1 (High Definition Multi media Interface) is the first all digital consumer electronics A/V interface that supports uncompressed standard. The HDMI terminal supports both video and audio information. To the HDMI*1 input terminal, you can connect an EIA/CEA-861/861B*2 compliant consumer electronic device, such as a Set Top Box or DVD player with HDMI or DVI output terminal. Input a High-bandwidth Digital Content Protection (HDCP) high-definition picture source to this HDMI terminal, so you can display the high-definition pictures on this TV in the digital form.

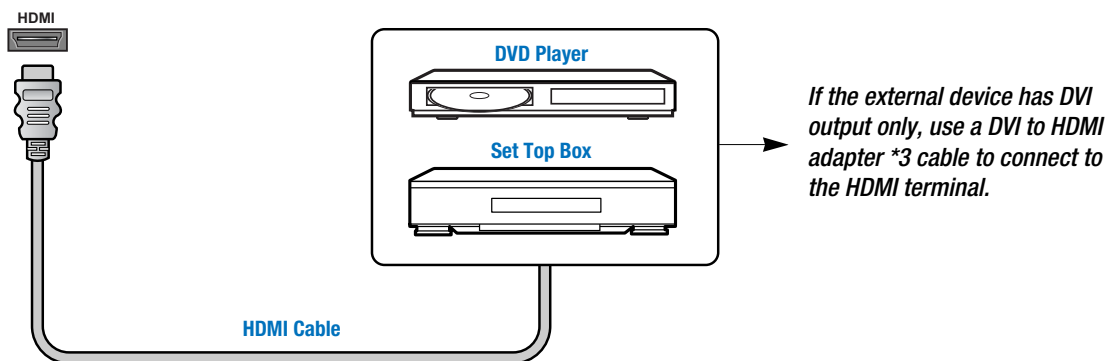

Compatible VIDEO Signal

Resolution	No. of dots(HXV)	Vertical scanning frequency(Hz)
1080i	1920 X 1080i	59.94/60
480p	720 X 480p	59.94/60
	640 X 480p	59.94/60
720p	1280 X 720p	59.94/60

This input terminal is not intended for use with computers.









Compatible sampling frequency of AUDIO signal through HDMI (L.PCM) : 48kHz / 44.1kHz / 32 kHz

Notes:

- This HDMI connector is Type A.
- If you connect an equipment without a digital output terminal, connect to the COMPONENT VIDEO, S VIDEO or VIDEO input terminal on the TV so you can enjoy an analog signal.
- The DIGITAL IN terminal can only be used with 1080i, 480i or 480p picture signals. Set the Digital Set -Top -BoxDIGITAL OUT terminal Output setting to 1080i, 480i or 480p. For detailed information, refer to the Digital Set -Top -Box instruction manual. If you cannot display the picture because your Digital Set -Top -Box does not have a DIGITAL OUT terminal Output setting, use the component Video Input (or the S Video Input or Video Input). In this case the picture will be displayed as an analog signal.

How to Watch

- 1 Turn on TV and Press  on remote control.
- 2 Turn on TV and Press  on the remote control
- 3 press  button and press up/down button to move to external input
- 4 press  button or 
- 5 Press  button to get the HDMI input

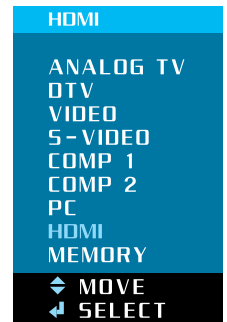

TIP

- *1 HDMI, the HDMI logo and High-Definition Multimedia Interface are trademarks or registered trademarks of HDMILicensing LLC.
 - *2 EIA/CEA-861/861B profiles compliance covers profiles for transmission of uncompressed digital video including high bandwidth digital content protection.

How to Connect an External Visual Device

You can connect your TV to other visual device to record TV programs to VCR.

Connection Method

- 1** Connect the Composite Video cable between Video input terminals of an external device and the Video output terminals for Video on the rear of TV. (Connect the jacks to terminals in the same color.)
- 2** Connect the Audio cable between Audio input terminal (Left-white, Right-red) of an external device and Audio output terminal for Video on the rear of TV. (Connect the jacks and terminals in the same color.)
- 3** For more information, read the user's guide of an external device.

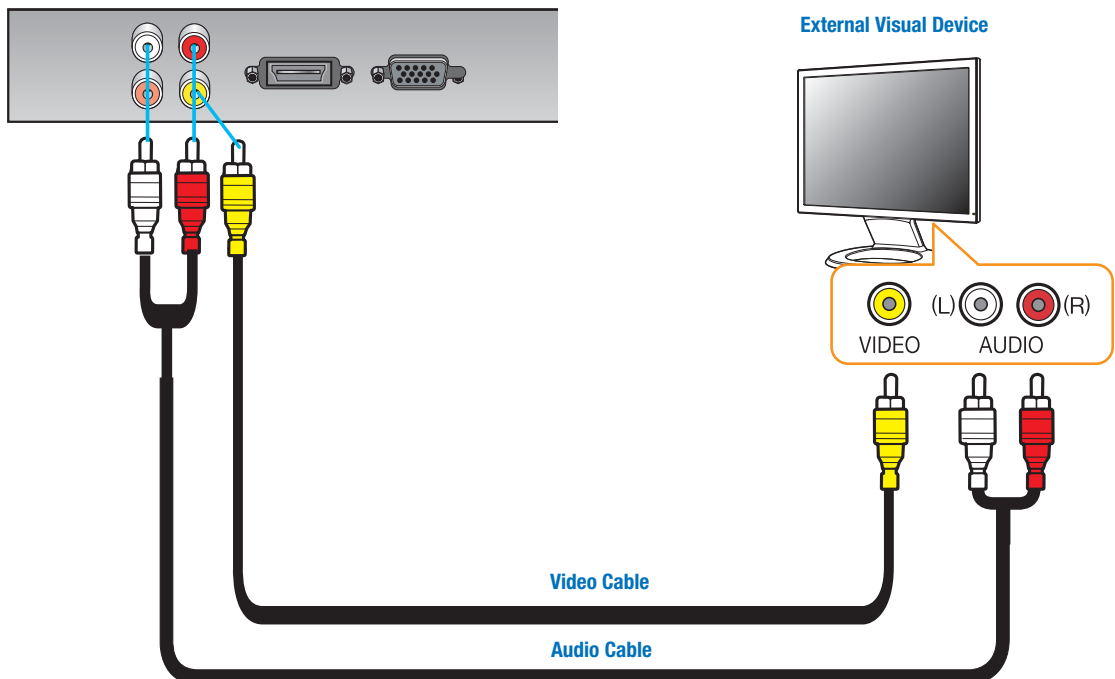

Video and Audio outputs are available only when watching an Analog TV, Digital TV or VCR. This is not supported in the Input Mode of Component, HDMI (or DVI) /D-SUB or S-Video.



How to Use Digital Sound

Connection Method

- 1 Connect the coaxial cable to the digital audio output terminal for coaxial cable or SPDIF optical digital audio output terminal on the rear of TV.
- 2 Select Digital Sound Output. (See page 46~47)
- 3 For more information, read the user's guide of the external sound device.

CONNECTIONS

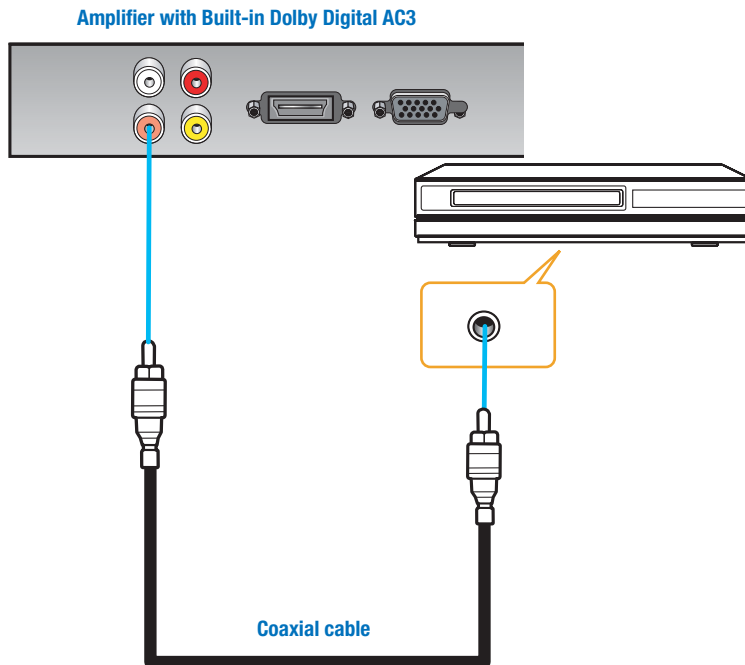

Digital Audio Output is available when watching a digital TV program.

How to Select TUNER MODE

You can choose the RF-input between off-air and cable.



Press Menu button.
Menu items appear on the screen.

1



Press up or down button to move to "channel"
Press **OK** or **▶** buttons to select "channel"



2



Press up or down button to move to Tuner Mode
Press **OK** or **▶** buttons to select Tuner Mode

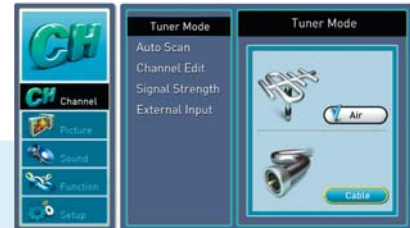

3



Press up or down button to move to Air / Cable
and Press **↵** buttons to select item you want.

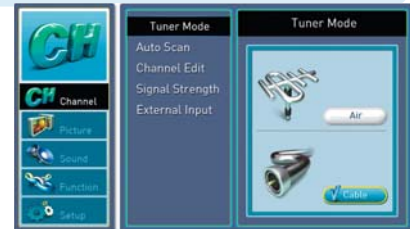

Press MENU button after the setting is done,
and Menu goes to the previous menu.
If the EXIT button is pressed, the menu will appear.



How to Select TUNER MODE

You can choose the RF-input between off-air and cable.

CHANNEL



Press Menu button.
Menu items appear on the screen.

1



Press up or down button to move to "channel"
Press or buttons to select "channel"



2



Press up or down button to move to Tuner Mode
Press or buttons to select Tuner Mode

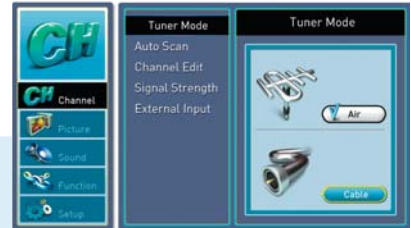

3



Press up or down button to move to Air / Cable
and Press buttons to select item you want.



Press MENU button after the setting is done,
and Menu goes to the previous menu.
If the EXIT button is pressed, the menu will appear.

How to Store Channels Automatically

- Your TV can memorize and store all of the available analog/digital broadcast signals for both “off-air” (antenna) and cable channels.
- Before your television can begin memorizing the available channels, make sure to specify the type of the signal source (antenna or cable) connected to your TV.



Press Menu button.
Menu items appear on the screen.



1



Press Up or Down buttons to move to “channel”.
Press button or button to select “channel”.

2



Press Up or Down button to move to “AUTO SCAN”.



- AIR ONLY : Watching the analog over-the-air and digital over-the-air signals via ANT input port.
- CABLE ONLY : Watching the Cable and digital cable signals via ANT input port.

3



Press button and Auto Scan is Activated
***CABLE BAND NOTE :** STD (Standard), HRC (HRC band), IRC (IRC band)
(For further band information, contact your cable service provider.)



TIP

- In the middle of AUTO SCAN, if you press button once, AUTO SCAN is interrupted. Press the Menu button to exit. Then the original channel is returned.
- If you have changed the connection of an antenna or cable, perform AUTO SCAN again.



How to Add/Eraser Channels Manually

Users can add or erase the desired channels.

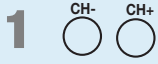

Press ▲\▼ channel buttons or the number buttons on remote control to view the channels that will be added or erased.



Add the channel by pressing the ADD/ERASE button.
Press the ADD/ERASE button to erase the channel

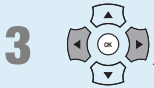

Press Left and Right buttons to set YES/NO.

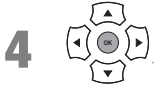

Press OK button to set.



CHANNEL



When you wish to restore any digital channels that have been deleted, you need to perform AUTO SCAN again. If you want to directly use the number buttons for storing, contact your local broadcasting company or cable company for the required channel digits. Unlike an analog broadcast, a digital broadcast uses virtual channels, not fixed channels. For more information on virtual channels, see page 62.

How to Set Channel Edit and Favorite Channels

Users can store frequently watched channels to quickly access a preferred channel.



Press Menu button.
Menu items appear on the screen.

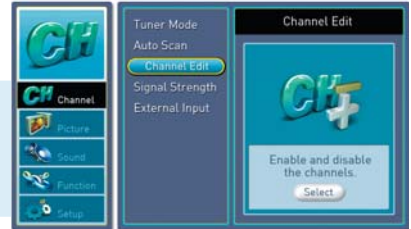

1



Press Up or Down buttons to move to "channel".
Press **OK** button or **▶** to select "channel".

2



Press Up or Down button to move to "channel edit".
Press **OK** button or **▶** to select "channel edit".

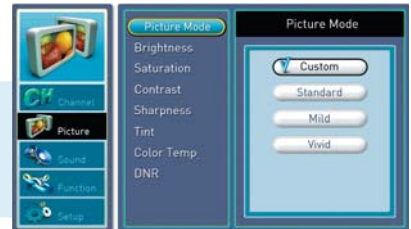

3



Press **OK** button to "select".

You can channel and Favorite-channels by pressing add/erase, Up/Down, left/right and **OK** buttons.



Press MENU or exit button after the setting is done, and you can save the channels you select.



The Favorite function is available only with remote control.



How to See Signal Strength

The function is only for DTV channel.



Press menu button.
menu items appear on the screen.

1



Press Up or Down button to move to "channel".
Press or button to select "channel".



2



Press Up or Down button to move to "signal strength".
Press or button to select "signal strength"
then the signal strength of antenna appears
on the screen.

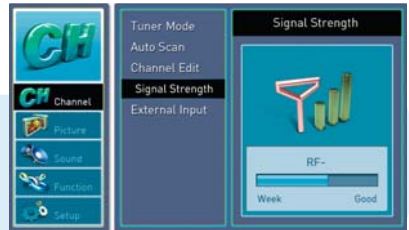

Press Menu button after the setting is done.
menu goes to the previous menu
If the Exit button is pressed, the menu will disappear.

How to Set The Input Mode



Press Menu button.
Menu items appear on the screen.



1



Press Up or Down button to move to "channel".
Press or button to select "channel".

2



Press Up or Down button to move to "external input".
Press or button to select "external input".

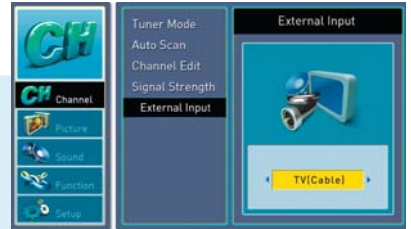

3



Press left or right button to set input mode
Whenever press left/right button to set input mode
Changes in following order.
⇒ TV(Air/Cable) ⇒ AVI(CVBS) ⇒ AVI(S-Video) ⇒ Ypbpr1
⇒ Ypbpr2 ⇒ HDMI ⇒ VGA



Press Menu button after the setting is done, and Menu goes to the previous Menu.
If the Exit button is prested, the menu will appear.

You can set the input mode quickly using the remote control press the button

Whenever press this button, the input mode changes if following order
⇒ TV(Air/Cable) ⇒ AVI(CVBS) ⇒ AVI(S-Video) ⇒ Ypbpr1
⇒ Ypbpr2 ⇒ HDMI ⇒ VGA



The Favorite function is available only with remote control.



How to Select the Picture Mode

Users can automatically adjust the picture mode according to the input mode.



Press Menu button.
Menu items appear on the screen.

1



Press Up or Down button to move to picture.
Press or button to select picture.

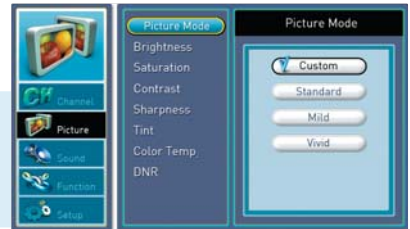

2



Press Up or Down button to move to picture mode
Press or button to select

3



Whenever you press Up or Down button, the mode changes in following order.
⇒ Custom ⇒ Standard ⇒ Mild ⇒ Vivid

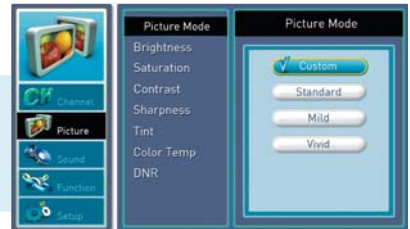

Press MENU button after the setting is done, and Menu goes to the previous menu.
If the EXIT button is pressed, the menu will disappear.

CUSTOM : When the user wants to directly set the values ➔ [See the next page](#)

STANDARD : Most video contents are appropriate to this mode.

MILD : Soft display.

VIVID: Clear and Vivid display

How to Directly Select Picture Mode : Press **Picture** button.

- Whenever press this button the mode changes in following arder. ⇒ Custom ⇒ Standard ⇒ Mild ⇒ VIVID.







- The adjustment of Contrast, Brightness, Sharpness, Saturation and Tint is allowed only in the Custom mode.



How to Set the Desired Picture



Users can manually adjust their desired picture.



- MENU**



Press Menu button.
Menu items appear on the screen.
- 1** 

Press Up or Down button to move to picture
Press  or  button to select picture mode.
- 2** 

Press Up or Down button to move to picture mode
Press  button or  to select picture mode
- 3** 

Press Up or Down button to move to custom and
Press  button to make a selection
- 4** 

Press  button or  to move to picture mode.
- 5** 

Press  button to select "Brightness".
Brightness appears on the right.
- 6** 

Press Left or Right button to adjust.
- EXIT**

Press MENU button after the setting is done, and Menu goes to the previous menu.
If the EXIT button is pressed, the menu disappears.



PICTURE

BRIGHTNESS : Adjust the brightness of the entire picture.
SATURATION : Adjust colors into deeper or lighter colors.
CONTRAST : Adjust the brightness and darkness of object and background.
SHARPNESS : Adjust clarity of outline of objects.
TINT : Adjust colors naturally.
COLOR TEMP : Whenever You Press left or right button, the mode changes in following order COOL ⇄ NORMAL ⇄ WARM
DNR : Reduce the Digital Noise in the DTV mode.

TIP SHARPNESS, COLOR, TINT are not applied to PC and HDMI (or DVI) modes.



How to Select the Aspect Ratio

Users can manually adjust size of the screen.



Press **Aspect** button.
Menu items appear on the screen.

Whenever you press aspect button the mode changes in following order.
⇒ WIDE ⇒ NORMAL ⇒ ZOOM

How to Select the Audio Mode

Users can adjust sound mode automatically as they want.



Press **Menu** button.
Menu items appear on the screen.

1



Press **Up** or **Down** button to move to sound .
Press **OK** or **▶** button to select sound .



2



Press **Up** or **Down** button to move to sound mode
Press **OK** or **▶** button to select sound mode.

3



Mode is selected.
Whenever you press **Up** or **Down** button,
the mode changes in following order.
⇒ CUSTOM ⇒ STANDARD ⇒ MOVIES
⇒ MUSIC ⇒ SPEECH



Press **MENU** button after the setting is done, and Menu goes to the previous menu.
If the **EXIT** button is pressed, the menu will disappear.

CUSTOM : When the user wants to set the value. ➔ See the next page
STANDARD : General sound mode. This fits most audio contents.
MOVIES : For enjoying vivid sound.
SPEECH : For enjoying clear sound.
MUSIC : For enjoying original sound.

How to Directly Select Sound Mode : Press **SOUND** button.

Users can select ⇒ Custom ⇒ Standard ⇒ Movies ⇒ Music ⇒ Speech

How to Adjust the Desired Audio Mode

Users can adjust sound mode manually as they want.



Press Menu button.
Menu items appear on the screen.



1



Press Up or Down button to move to sound
Press **OK** or **▶** button to move to sound

2



Press Up or Down button to move to sound mode
Press **OK** button or **▶** to select



3



Press Up or Down button to move to custom
and press **OK** button to make a selection

4



Press Up or Down to select items
(Table, Boss and blance)

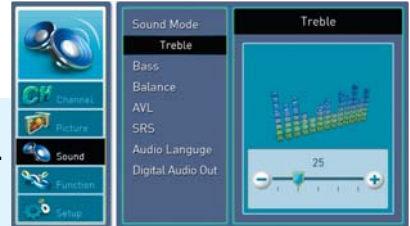

5



Press **OK** or **▶** button to select items
Move between the items listed using UP or Down button.
Adjust the level of the item selected using
Left or Right button.



Press MENU button after the setting is done, and Menu goes to
the previous menu.
If the EXIT button is pressed, the menu disappears.

TREBLE: Adjusts the range size of high sound.

BASS: Adjusts the range size of low sound.

BALANCE : Adjusts the balance of left and right speakers.



How to Use the Automatic Volume Control

With this Automatic Volume Level Control, everything you watch will always maintain the volume level that you decide. Basically it is set to "off"



Press Menu button.
Menu items appear on the screen.

1



Press Up or Down button to move to sound .
Press or button to select sound .



2



Press Up or Down button to move to AVL.
Press or button to select AVL.

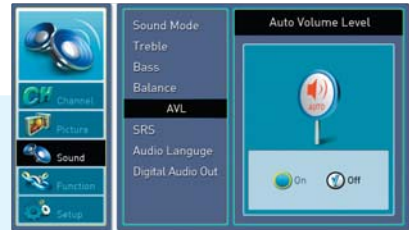

3



Press or button to set to on/off.
Press button to set to on/off.



Press MENU button after the setting is done, and Menu goes to the previous menu.
If the EXIT button is pressed, the menu will disappear.

How to Listen to SRS TruSurround XT (Surround)

Users can enjoy spectacular 3D sound.



Press Menu button.
Menu items appear on the screen.

1



Press Up or Down button to move to sound.
Press or button to select sound.



2



Press Up or Down button to move to SRS.
Press or button to select SRS.



3



Press Left and Right buttons to set to 'OFF/Tresurround XT'.



Press MENU button after the setting is done, and Menu goes to the previous menu.
If the EXIT button is pressed, the menu will disappear.



is a trademark of SRS Labs, Inc.
TruSurround XT technology is incorporated under
license from SRS Labs, Inc.

TIP

The SRS TruSurround XT function is activated only when the audio input signal is Stereo.



How to Set Audio Language

While watching a digital program, you can listen to foreign language if the program is supported with foreign language.



Press Menu button.
Menu items appear on the screen.



1



Press Up or Down button to move to sound .
Press or button to select sound .

2



Press Up or Down button to move to 'AUDIO LANGUAGE'.
Press or button to select 'AUDIO LANGUAGE'.



3



Whenever you press Left or Right button,
the mode shifts in following order.
⇒ ENGLISH ⇒ SPANISH ⇒ FRANCE



Press MENU button after the setting is done, and Menu goes to the previous menu.
If the EXIT button is pressed, the menu will disappear.

How to Directly Select Audio Language : Press the button.

- Whenever you press this button, the mode shifts ⇒ MONO ⇒ STEREO ⇒ SAP in order when receiving analog signals.
- You can select one of the languages listed you prefer when receiving digital signals.



- If you want to see language information while watching a digital channel, press the button to display language information that is currently received.

How to Set the Digital Audio Output

The digital audio output terminal allows you to enjoy digital sound. (For more details, see page 30)



Press Menu button.
Menu items appear on the screen.



1



Press Up or Down button to move to sound .
Press or button to select sound.

2

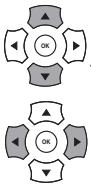

Press Up and Down buttons to move to
“DIGITAL AUDIO OUT”
Press or buttons to select Digital Audio out.
Whenever you press Left or Right button, the mode
shifts in following order.
⇒ Dolby ⇒ PCM

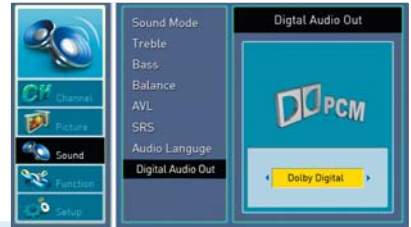

Press MENU button after the setting is done, and Menu goes to the previous menu.
If the EXIT button is pressed, the menu will disappear.

Manufactured under license from Dolby Laboratories.
“Dolby” and the double-D symbol are trademarks of Dolby Laboratories.



How to Set Auto Lock

This function is used to prevent from using the control buttons on the front top of the TV or from connecting external devices to the TV. You make sure to set a PIN number to use this function.



Press Menu button.
Menu items appear on the screen.

1



Press Up or Down button to move to function .
Press or button to select function .

2



Press Up or Down buttons to move to "AUTO LOCK".
Press or button to select "AUTO LOCK".

3



Then the Enter PIN number window appears.
The default is 4 digits (0-0-0-0).

4



- To set Key Lock :
Press Up or Down button to move to "SET BLOCKING".
Press or button to select "SET BLOCKING"

5



Press Up or Down button to move to "ON/OFF".
Press or button to select "SET BLOCKING"

6



- To set Channel blocking :
Press Up or Down button to move to "CHANNEL BLOCKING".
Press button to select "CHANNEL BLOCKING".

7



Then the AUX BLOCK items appear.
Press Up and Down buttons to move to the item you want.
Press button to set to "LOCK/UNBAK".
If the item is set to ON, such item is disabled.

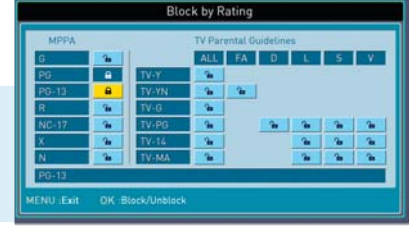

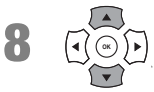

SOUND

Continued from previous page.... (Set the Lock External Signal function.)

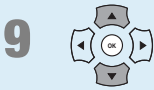

- To set block by rating :
Press Up or Down button to move to "block by rating".
Press  button to select "block by rating".



- To update DTV rating :
Press Up or Down button to move to "setup code".
Press  button to select "block by rating".



Press Up or Down button to select "SETUP CODE".
Press  button to select "SETUP CODE"
Then the Enter PIN number window appears.

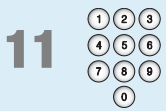

Enter a 4- digit PIN number.
When the Confirm PIN number window appears,
enter the PIN number again



Press MENU button after the setting is done, and Menu goes to the previous menu.
If the EXIT button is pressed, the menu will appear.

TIP

- The Lock External SIGNAL function is designed to prevent a VCR or game player from being connected to the TV.
- If you forgot your PIN number, Enter a 4-digit number (2-5-0-1) in the pin number window.
- The Key Lock function will be disengaged when you turn off and then on AC power or when a power failure happens.



How To Set Block By Rating

This(V-Chip) is used to block program viewing based on the ratings sent by the broadcasting station. The default setting is to allow all programs to be viewed. Viewing can be blocked by the type of program and by the categories chosen to be blocked.

V-Chip rating and categories

Rating guidelines are provided by broadcasting stations. Most television programs and television movies can be blocked by TV Rating and/or Individual Categories. Movies that have been shown at the theaters or direct-to-video movies use the Movie Rating System (MPAA) only.

Ratings for Movies previously shown in theaters :

Movie Ratings :	- Blocking Off	(Permits all programs)
	- G	(General audience)
	- PG	(Parental guidance suggested)
	- PG-13	(Parents strongly cautioned)
	- R	(Restricted)
	- NC-17	(No one 17 and under admitted)
	- X	(Adult only)

If you set PG-13 : G and PG movies will be available , PG-13, R, NC-17 and X will be blocked.

Ratings for Television programs including made-for-TV movies :

- TV-G	(General audience)
- TV-PG	(Parental guidance suggested)
- TV-14	(Parents strongly cautioned)
- TV-MA	(Mature audience only)
- TV-Y	(All children)
- TV-Y7	(Children 7 years older)

TV Rating Children :	- Age	(applies to TV-Y, TV-Y7)
	- Fantasy Violence	(applies to TV-Y7)

TV Rating General :	- Age	(applies to TV-G, TV-PG, TV-14, TV-MA)
	- Dialogue-sexual dialogue	(applies to TV-PG, TV-14)
	- U Language-adult language	(applies to TV-PG, TV-14, TV-MA)
	- Sex-sexual situations	(applies to TV-PG, TV-14, TV-MA)
	- Violence	(applies to TV-PG, TV-14, TV-MA)

Continued on next page

..... Continued from previous page.



Press Menu button.
Menu items appear on the screen.

1



Press Up or Down button to move to Auto Lock.
Press **OK** or **▶** button to select Auto Lock.
The message "Enter PIN" will appear.



2



Enter your 4-digit PIN number.

3



Press Up or Down button to move to "BLOCK BY RATING" and press **OK** buttons to mode a selection.
The new screen will appear.



4



Press Up/Down and left/right buttons to select the items (MPAA and TV Parental midelines)

5



Press up/down and left/right buttons to select the item
Press **OK** button to mode a selection.



Press MENU button after the setting is done,
and Menu goes to the previous menu.
If the EXIT button is pressed, the menu will disappear.



How to View Closed Captions

Choices in the closed caption menu are : CC Mode, Priority (Analog caption or Digital caption), and Option.

1. CC MODE :

ON : Captioning information is always shown, when available.

OFF : No captioning information is displayed.

2. PRIORITY :

You can choose whether the TV uses digital or analog captions for digital TV programs that have both or either.

- **ANALOG (CAPTION)** : You can select a closed caption mode, which is the mode, or source, used for displaying captioning information for analog channels or digital channels, if available.

• CAPTION :

The form for the words that scroll across the bottom of the TV screen : usually the audio portion of the program provided for the hearing impaired.

CC 1 : For video related information that can be displayed. Script can be in any language.

CC 2/3/4 : Other modes used for video related information.

• TEXT :

The term for the words that appear in a large black frame and almost cover the entire screen : Usually message provided by the broad caster.

T 1 : Blanks out a large portion of the picture on the television screen, and display program guide or any other information currently being transmitted.

T 2/3/4 : other modes that display information and blank out a large portion of the picture of the TV screen.

- **DIGITAL (CAPTION)** : You can select a closed caption, service mode(1-7) for digital channels.

The service modes support MPEG-2 based transport sources Service 1 and Service2 are the primary and secondary languages, respectively.

Service3 and service4.5.6 are additional caption sources that may be available.

Continued on next page

..... Continued from previous page.

3. OPTION :

Customized closed captioning for the digital caption by choosing the settings for the following options :

1) cc Background

COLOR : Set the color of the cc Background AUTO -> BLACK -> WHITE -> RED -> GREEN -> BLUE -> YELLOW -> MARGENTA -> CYAN

OPACIFY : Specify the opacity for the - AUTO -> SOLED -> FIASHUNG -> TRANSLUCENT -> TRANSPARE

2) Caption Text

CAPTION SIZE : Set the size of the words - AUTO -> SMALL -> STANDARD -> LARGE

CAPTION STYLE : Set the style of the words - AUTO -> STYLE1 -> STYLE2 -> STYLE3 -> STYLE4 -> STYLE5 -> STYLE6 -> STYLE7.

TEXT COLOR : Choose a color for the text - AUTO -> BLACK -> WHITE -> RED -> GREEN -> BLUE -> YELLOW -> MARGENTA -> CYAN

TEXT OPACIFY : Specify the opacity for the text - AUTO -> SOLED -> FIASHUNG -> TRANSLUCENT -> TRANSPARENT

EDGE STYLE : Select Edge style for the text - AUTO -> NONE -> RASIED -> DEPRESSED -> UNIFORM -> DROP -> SHADOW

EDGE COLOR : Select Edge color for the text - AUTO -> BLACK -> WHITE -> RED -> GREEN -> BLUE -> YELLOW -> MARGENTA -> CYAN

ITALIC : Convert the text in to italic - AUTO -> ON -> OFF

UNDERLINE : Add the underline to the text - AUTO -> ON -> OFF



Press Menu button.
Menu items appear on the screen.

1



Press Up or Down button to move to function and press or to select function



2



Press Up and Down buttons to move to "CAPTION" and press or button to make a selection.

3



Display MODE is highlighted.
Press Left and Right buttons to select "OFF" or ALWAYS ON".
Sub menu item are activated.



4



Press Up or Down button to move the item
Press Left or Right button to select the item.



5



To select caption option
Press Up or Down button to move to caption option.
Press **OK** or **▶** button to select caption option.



6



Press left/right buttons to select Auto/Option and
press **OK** to select make a selection.
If caption option selected options, CC Background
and caption Text are highlighted When selecting the CC Background
and caption text, press **OK** button.

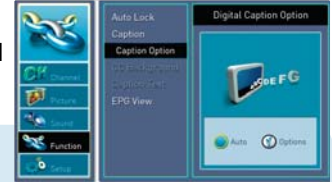

7



Press Up or Down button to move between the items
(cc Background and Caption text)
Press left/right **OK** buttons to select the item

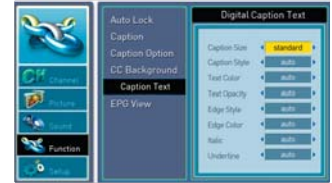
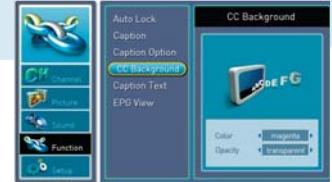

8



Then you can choose the CC Background and
caption text by pressing up/down and left/Right buttons.



Press MENU button after the setting is done,
and Menu goes to the previous menu.
If the EXIT button is pressed, the menu will disappear.

FUNCTION

How to Set the EPG View



- This service is only for DTV mODEL.



Press Menu button.
Menu items appear on the screen.



1



Press Up or Down button to move to function.
Press  or  button to select function.



2



Press Up or Down button to move to EPG View
Press  or  button to select EPG View

3



Press  or  button to see the EPG
Then you can get information on the broadcast
time and program.



Press MENU button after the setting is done,
and Menu goes to the previous menu.
If the EXIT button is pressed, the menu will appear.



How to Set Date / Time

- Yes can automatically turn on or off the TV at a present time, To do this, you must set the time it you wish to use the automatic on or off timers



Press Menu button.
Menu item appear on the screen.



1



Press Up or Down button to move to setup
Press **OK** or **▶** button to select setup

2



Press Up or Down button to move to "DATE/TIME"
Press **OK** or **▶** button to select "DATE/TIME"



3



Press Up or Down button to move to manual manually.
Press **OK** button to set the current "DATE/TIME"
Press Up/Down and Left/Right buttons to set year, month, day, Hour, Minute and AM/PM

4



After setting,
Press **OK** or **▶** button to exit



5



"AUTO" is only for DTV mode.
If you select "AUTO".
Press **OK** or **▶** button to select function

6



Press Up/Down or left/right buttons to timezone
Whenever you press the buttons, timetone is changed in following order
Pacifc ⇨ Mountain ⇨ Central ⇨ Eastern ⇨ Alaska ⇨ Hawaii ⇨ Atalamic

7



Press Up or Down button to move to "DAYLIGHT SAVING"
Press **OK** or **▶** button to select "DAYLIGHT SAVING"

8



Press Up or Down button to select observe/Do not observe
Press **OK** or **▶** button to make a selection.



Press MENU button after the setting is done,
and Menu goes to the previous menu.
If the EXIT button is pressed, the menu disappears.



SETUP

How to Set Power on Time



Press Menu button.
Menu items appear on the screen.



1



Press Up or Down button to move to setup
Press **OK** or **▶** button to select setup.

2



Press Up/Down button to select power on time
Press **OK** or **▶** button to select power on time.



3



Press **OK** button to activate power on time
whenever you press left and right button, the mode
shifts in following order
OFF → DAILY → ONCE

If you select once or daily in the "ACTIVATE"
You can set time and channel

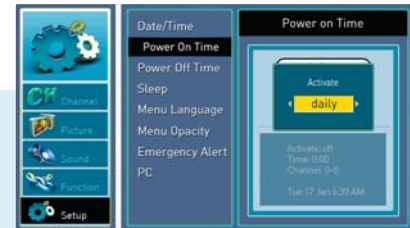

4



Press up/down button to select Time
Press **OK** button to set Time
Press Left or Right button to move between Hour,
minute and AM/PM and Press up or down buttons
to set Hour, minute and AM/PM

5



Press Up/Down buttons to select channel
Press **OK** button to set channel.
Press numeric key to set channel number
Press **OK** button to set.



Press MENU button after the setting is done,
and Menu goes to the previous menu.
If the EXIT button is pressed, the menu will appear.



How to Set Power Off Time



Press Menu button.
Menu items appear on the screen.

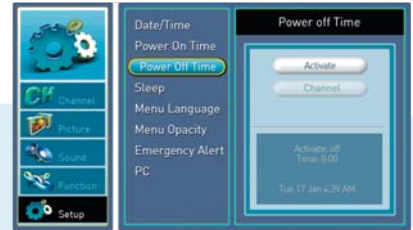

1



Press Up or Down button to move to setup
Press or button to select setup.

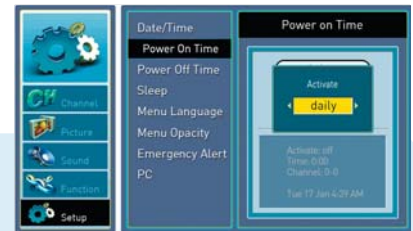

2



Press Up/Down button to move to power off time
Press or button to select power off time.

3



Press button to activate power off time
whenever you press left and right button, the mode
shift in following order
OFF ⇌ DAILY ⇌ ONCE

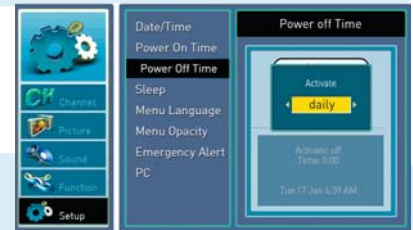

If you select once or daly in the "ACTIVATE"
You can set time.

4



Press Up/Down buttons to select time
Press button to set time.
Press Left or Right button to move between
Hour, minute and AM/PM
Press Up or Down buttons to set
Hour, minute and AM/PM.
Press button to set



Press MENU button after the setting is done,
and Menu goes to the previous menu.
If the EXIT button is pressed, the menu will appears.

How to Set Sleep Time



Press Menu button.
Menu items appear on the screen.



1



Press Up or Down button to move to setup
Press or button to set sleep time.



2



Press Up or Down button to move to sleep time
Press or button to set sleep time.

3



Press up or down button to set sleep time
whenever you press up or down button the mode
shifts in following order
OFF ⇨ 15 MINUTES ⇨ 30 MINUTES ⇨ 60 MINUTES
⇨ 90 MINUTES ⇨ 120 MINUTES

4



Press button to set.



Press MENU button after the setting is done,
and Menu goes to the previous menu.
If the EXIT button is pressed, the menu will disappear.

How to Directly Set the sleep timer : Press the button.

- Whenever press this button, the mode shifts off ⇨ 15 ⇨ 30 ⇨ 60 ⇨ 90 ⇨ 120 minutes



How to Choose Menu Language



Users can select their language preference in order to display main menus and sub menus, etc.



Press Menu button.
Menu items appear on the screen.

1





Press Up or Down button to move to setup.
Press  or  button to select setup.



2



Press up/down button to move to menu language
Press  or  button to select menu language



3



Press  or  button to set language
Whenever you press Left or Right button,
the mode shifts in following order.
⇒ ENGLISH ⇒ FRANÇAIS ⇒ ESPAÑOL ⇒



Press MENU button after the setting is done, and Menu goes to the previous menu.
If the EXIT button is pressed, the menu will appear.

How to Set Menu Opacity



Users can select their language preference in order to display main menus and sub menus, etc.



Press Menu button.
Menu items appear on the screen.

1





Press Up or Down buttons to move to setup .
Press  or  button to select setup



2



Press Up or Down button to move to move to menu opacity
Press  or  button to select menu opacity

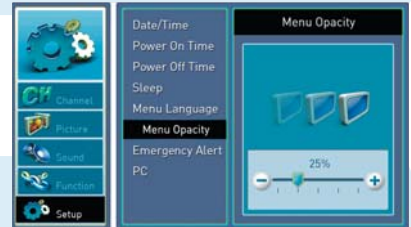

3



Press left or right to set menu opacity you want



Press MENU button after the setting is done, and Menu goes to the previous menu.
If the EXIT button is pressed, the menu will disappear.





How to Set Emergency Alert



Press Menu button.
Menu items appear on the screen.

1



Press Up or Down buttons to move to setup .
Press  or  button to select setup

2



Press Up or Down button to move to Emergency Alert.
Press  or  button to select Emergency Alert.

3























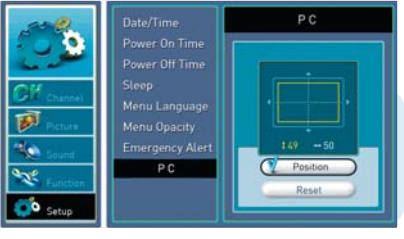

Press Up or Down button to move to Low/medium
Press left or right button to select present/discard.

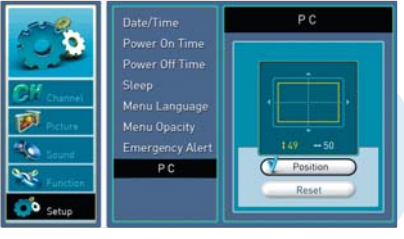

Press MENU button after the setting is done, and Menu goes to the previous menu.
If the EXIT button is pressed, the menu will appear.

How to Set the Geometry in PC Mode

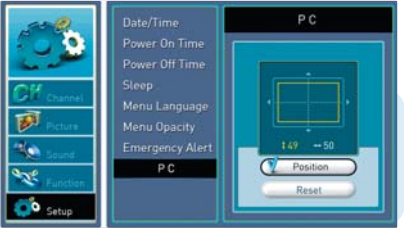
This function is only available in PC mode.

<p>MENU</p> 	<p>Press Menu button. Menu item appear on the screen.</p>	
<p>1</p> 	<p>Press Up or Down button to move to setup. Press  or  button to select setup.</p>	
<p>2</p> 	<p>Press Up or Down buttons to move to "PC". Press  or  button to select "PC".</p>	
<p>3</p> 	<p>Press Up or Down button to move to setup. Press  or  button to select</p>	
<p>4</p> 	<p>Press Up and Down buttons to adjust v-position Press  or  button to adjust h-position After setting press  button to exit</p>	
<p>5</p> 	<p>Press Up and Down buttons to move to "AUTO" Press  or  button to adjust h/V-position auto</p>	
<p>EXIT</p> 	<p>Press MENU button after the setting is done, and Menu goes to the previous menu. If the EXIT button is pressed, the menu disappears.</p>	

H. POSITION : To adjust the horizontal position of the picture.
V. POSITION : To adjust the vertical position of the picture.

TIP If the display input signal (resolution) has been changed, the picture will be automatically optimized.



VCR Setting Number Table

MAKER	Setting Number	MAKER	Setting Number
AIWA	001		036, 037, 044, 046, 101, 129, 131, 138,
AKAI	016, 043, 046, 124, 125, 146		152, 153, 157
AM PRO	072	FISHER	003, 008, 009, 010
ANAM	031	FUNAI	001
AUDIO DYNAMICS	012, 023, 039, 043	GE	031, 072, 144, 147, 151, 156
BROOK SONIC	035, 037, 044, 129, 152	GO VIDEO	040, 132, 136
CANON	028, 031	GOLDSTAR / LG	012, 101, 123, 163, 114
CAPEHART	108	HARMAN KARDON	012, 045
CRAIG	003, 040	HITACHI	001, 026, 137, 150, 156, 163
CURTIS MATHES	031, 156	HUGHES	163
DEAWOO	005, 007, 010, 108, 110, 112, 116, 117,	INSTANTREPLAY	031
	119	JCL	031
DAYTRON	108	JCPENNY	012, 040, 066, 101, 156, 163
DIMENSIA	156	JENSEN	043
DBX	012, 023, 039, 043	JVC	012, 031, 043, 130, 150
DYNATECH	001, 053	KENWOOD	001, 014, 023, 047
ELECTROHOME	059	LLOYD	001
EMERSON	001, 006, 017, 025, 027, 029, 031, 035,	LXI	001, 003, 009, 017

MAKER	Setting Number	MAKER	Setting Number
MAGIN	040	SAMSUNG	032, 034, 040, 104, 112, 113, 115, 120,
MAGNAVOX	001, 031, 067, 068, 154		122, 125, 159
MARANTZ	012, 023, 031, 067, 067, 069	SANSUI	022, 043
MARTA	101	SANYO	003, 007, 010, 014, 102, 134
MATSUI	027, 030	SCOTT	017, 037, 044, 112, 129, 131, 159
MEI	031	SEARS	003, 008, 009, 010, 014, 017, 081, 101
MEMOREX	001, 003, 010, 014, 031, 053, 072, 101		163
	102, 134, 139	SHARP	031, 053, 054
MGA	045, 046, 059	SHINTOM	024
MINOLTA	156, 163	SIGNATURE	001
MITSUBISHI	045, 046, 051, 059, 061, 162, 163	SONY	003, 031, 052, 056, 057, 058, 155
MTC	001, 040	SOUNDESIGN	001
MULTITECH	001, 024	STS	163
NEC	012, 023, 039, 043	SYLVANIA	001, 031, 059, 067
NORDMENDE	043	SYMPHONIC	001
OPTONICA	053, 054	TANDY	001, 010
PANASONIC	031, 066, 070, 133, 161	TATUNG	023, 039, 043
PENTAX	031, 156, 163	TEAC	001, 023, 039, 043
PHILCO	001, 031, 067	TECHNICS	031, 070
PHILIPS	001, 031, 054, 067, 071, 101	TEKNIKA	001, 019, 031, 101
PILOT	101	TMK	006
PIONEER	021, 163	TOSHIBA	008, 042, 047, 059, 082, 112, 131, 163
PORTLAND	108	TOTEVISION	040, 101
QUARTZ	002, 014	UNITECH	040
QUASAR	031, 066, 070, 133, 161	VECTOR RESEARCH	012
RADIO SHACK	123	VIDEO CONCEPTS	001, 012, 046
RCA	001, 031, 040, 140, 144, 147, 151, 156	VIDEOSONIC	040
	163	WARDS	001, 003, 017, 024, 031, 040, 053, 054,
REALISTIC	001, 003, 008, 010, 014, 031, 040, 053,		131, 163
	054, 101	YAMAHA	001, 012, 039, 043
RICO	058	ZENITH	001, 056, 058, 072, 080, 101
SALORA	014		

DVD Setting Number Table

MAKER	Setting Number	MAKER	Setting Number
AIWA	020, 029	HYUNDAI	067
AKAI	027, 034, 042, 049, 068, 069	JVC	005, 015, 081
AKIRA	033	KENWOOD	010, 060, 062, 065
ALBA	029, 033, 042, 056	LOGIX	034, 067
ALPINE	009	MAGNAVOX	005, 008, 038, 048, 057, 071
APEX DIGITAL	024, 075, 076	MATSUI	001, 029
CALIFORNIA AUDIO	001	MICROSOFT	006
DAEWOO	004, 034, 046	mitsubishi	032, 042, 057
DAEWOO INTERNATIONAL	033	MIZUDA	071
DANSAI	004, 067	NAD	057, 063, 077
DENON	019, 030, 043, 044, 065, 226	ONKYO	005, 016, 207
FISHER	001	ORION	029
FUNAI	029	PANASONIC	001, 003, 039, 051, 054, 065, 079
GE	035, 056	PHILIPS	005, 038, 048, 080
GOLDSTAR / LG	014, 063, 078, 028, 041	PIONEER	073, 055, 057
HARMAN KARDON	217	PROSCAN	006, 035
HITACHI	011, 013, 021, 022	QUASAR	001

MAKER	Setting Number	MAKER	Setting Number
RCA	035	TENSAI	001, 027
SAMSUNG	013, 040, 047, 065	THOMSON	006, 012
SANSUI	004, 029, 049	TOSHIBA	005, 038, 060, 206
SANYO	023, 029, 052, 069	UNIVERSUM	014, 042, 063
SHARP	017, 029, 060	YAMAHA	039, 045, 059, 065, 079
SONY	007, 013, 037, 050, 053, 074	ZENITH	005, 014, 028, 041, 063
TECHNICS	001, 051, 054, 065, 079		



AMP Setting Number Table

MAKER	Setting Number	MAKER	Setting Number
ADCOM	146, 149, 227, 244	mitsubishi	253
AMC	083, 084	Meridian	067
ARCAM	100	NAD	128
AUDIO FILE	093, 098	NAKAMICHI	072, 212, 234, 235
AUDIO TECHNICA	221	NILES	236
AIWA	111, 114, 117, 156, 170, 199, 203, 219, 231, 241, 254	ONKYO	094, 116, 209, 211
AKAI	181, 233	OPTIMUS	121, 125, 140, 181
ANAM	180	PANASONIC	131, 200
BOSE	064, 137, 219	PARASOUND	085, 086, 090
B & K	150, 152	PHILIPS	126, 136, 186, 197
CARVER	098, 107, 126, 129, 160, 163, 220, 245, 249	PIONEER	081, 093, 132, 138, 165, 189, 195, 201, 210, 230
CLARION	151, 169	QUASAR	131
DENON	101, 133, 191, 202, 246, 247	RCA	109, 166
FISHER	107, 129, 157, 163, 176	REALISTIC	103, 122, 123, 124, 172, 174, 177, 179, 180
FOSGATE AUDIONICS	248	ROTEL	204, 218, 239
GE	123, 216	SANSUI	075, 126, 139, 196, 197, 214
HARMAN KARDON	073, 195, 248, 249	SANYO	157, 129
HAITAI	119	SAMSUNG	068
HITACHI	088	SCOTT	180, 190
JCPENNY	109, 178	SHARP	096, 125, 151, 161, 169, 182, 193
JENSEN	099	SHERWOOD	089, 127
KENWOOD	096, 104, 119, 125, 148, 151, 163, 171, 173, 242	SONY	097, 117, 147, 183, 188, 192, 200, 237, 238, 253
KRELL	223	SOUNDSTREAM	197
LEXICON	215, 250	SYMPHONIC	124
LUXMAN	066, 120, 205, 229	TEAC	062, 102, 159, 180
LXI	117, 123	TECHNICS	131, 165, 184, 200, 202
MAGNAVOX	126, 162, 185, 186, 224	TOSHIBA	175
MARANTZ	074, 105, 126, 128, 139, 155, 162, 186, 232	WARDS	163
MONDIAL	069, 225	YAMAHA	092, 120, 125, 166, 169, 216, 240
MCS	178	ZENITH	061, 222

CATV Setting Number Table

MAKER	Setting Number	MAKER	Setting Number
HAMLIN	015, 022	PIONEER	007, 026, 027
JERROLD / G.I	010, 025	SCIENTIFIC/ATLANTA	001, 006, 013
OAK	008, 016, 023	ZENITH	004

Glossary 1

Component video	Component video is sent through three cables: two color shade (chrominance) signals and one brightness (luminance) signal. Component video achieves greater color accuracy than composite video or S-VIDEO by splitting chrominance into two separate portions.
Composite video	Composite video is sent through a single cable. Composite video combines the color shade (chrominance) and brightness (luminance) information into one video signal.
S-VIDEO	S-VIDEO requires a single cable, which carries the brightness (luminance) and color (chrominance) signals of the picture separately. S-VIDEO provides better resolution than composite video, which carries the signals together.
480i	Provides 480 lines of resolution. Displays images using interlaced scanning, which first transmits all the odd lines on the TV screen and then the even lines.
480p	Provides 480 lines of resolution. Displays images using progressive scanning, which transmits each line from top to bottom.
720p	Provides 720 lines of resolution. Displays images using progressive scanning, which transmits each line from top to bottom.
1080i	Provides 1080 lines of resolution. Displays images using interlaced scanning, which first transmits all the odd lines on the TV screen and then the even lines. 1080i is one of the formats used by HDTV (High Definition TV).
Digital television (DTV)	A new technology for transmitting and receiving broadcast television signals. DTV provides higher resolution and improved sound quality over analog television.
HDTV(High Definition TV)	HDTV is a new kind of digital TV, creating a high quality picture, high definition. The HDTV provides a theater-like screen with an aspect ratio of 16:9. Supports 720p or higher.
SDTV(Standard Definition TV)	SDTV is a new kind of standard definition digital TV, having a range of lower resolution than the HDTV. Supports 480i.
Cable Broadcast Receiver (Converter)	A device that receives cable broadcasting. Connecting it to your TV set allows you to watch a various channels.
Satellite Broadcasting	Provides crisp picture and clear audio quality throughout the country via a satellite.
VHF/UHF	VHF (Very High Frequency) is the part of the frequency spectrum from 30 to 300 megahertz. UHF (Ultra High Frequency) is the part of the frequency spectrum from 300 to 3,000 megahertz.



Glossary 2

- DVD** DVD (Digital Versatile Disc) is an optical disc that can store a huge volume of multimedia such as video, game, and audio application, etc.
- Coaxial Cable** Coaxial cable is the kind of rounded copper cable, which is generally used for TV antenna.
- Aspect ratio** Refers to the ratio between the width and height of the screen. This TV has a 16:9 (widescreen) aspect ratio, as opposed to a 4:3 aspect ratio.
- Picture Mode** Picture Mode features the optimal picture quality. There are Standard-Dynamic-Movie-Mild- Custom features in order. "CUSTOM" allows you to adjust Contrast, Brightness, Sharpness, Color and Tint.
- Sound Mode** Sound Mode features the optimal sound quality. There are Standard-News-Music-Sports- Custom features in order. "CUSTOM" allows you to adjust high frequency sound, middle frequency sound and low frequency sound.
- Digital Broadcasting** Video and Audio signals digitized and transmitted by broadcasting companies complying with the new digital television standard developed by the ATSC (Advanced Television System Committee). Digital Broadcasting technology provides multimedia services including a variety of additional services as well as high-definition quality picture.
- Analog Broadcasting** ATSC-based Video and Audio signals transmitted by broadcasting companies.
- SRS TruSurround TX** A well-recognized 3D sound technology developed by US SRS Labs, Inc. This technology delivers the ultimate audio experience only with two speakers as if through multi-channel speakers.
- Dolby Digital** Formerly known as AC-3, Dolby Digital is a digital audio coding technique that reduces the amount of data needed to produce high quality sound.
- Mono** Audio signals are produced through a single channel. It is difficult to experience a spectacular sound since audio signals are reproduced with a single speaker.
- Stereo** Audio signals are produced through two channels. A spectacular sound is reproduced with two separated speakers.
- Widescreen** Term given to picture displays with a wider aspect ratio than NTSC 4:3. Digital HDTV is 16:9 widescreen. Most motion pictures also have a widescreen aspect ratio, some even wider than 16:9.
- External source** Refers source signals that come from other external devices such as a VCR, camcorder and DVD player, etc. than a TV set.

Glossary 3

- MTS** A bilingual service provided when an overseas film, foreign drama or overseas news, etc. is aired. You can select one of two choices: mother tongue and foreign language. Or you can listen to both languages at the same time.
- DVI** Digital Visual Interface is a specification for digital signals. This interface using TMDS transmission reduces the loss of signal, allowing to enjoy a clear and crisp image.
- HDMI** HDMI (High-Definition Multimedia Interface) is the first and only industry-supported, uncompressed, all-digital audio/video interface. HDMI provides an interface between any audio/video source, such as a set-top box, DVD player, or A/V receiver and an audio and/or video monitor, such as a digital television (DTV), over a single cable.
- Virtual channels** There is a new numbering system for DTV channels. The system, called the “DTV virtual channels,” gives a number for each DTV program service, and almost always uses the analog NTSC channel number as the first number for that station. The use of virtual channels allows stations to use the same channel number “brand” for both NTSC and DTV. The printed listing services have not yet changed their format to show only the DTV virtual channel numbering system. So in the example, the station is using RF Channel 38 for DTV and is transmitting DTV programs with virtual channel numbers 15.n. The 15.n is short hand for 15.1, and 15.2 and 15.3, etc., as there can be more than one DTV program lineup from the station. So, 15.1 is the first DTV program lineup, 15.2 is the second, 15.3 is the third. Some DTV stations may have only one virtual channel, others perhaps as many as six.



Troubleshooting

Installation Problems

Symptom	Possible solution
How can I install an antenna?	Refer to pages 19~20.
TV screen is not clear after installing an indoors antenna.	Indoors antenna may experience poor reception due to surrounding buildings. Please install an outdoors antenna or wireless antenna.
How can I view cable broadcasting?	Please install a cable broadcasting receiver (Converter).

Picture Problems

Symptom	Possible solution
Neither picture nor sound comes up.	Check whether power is on. Check whether the power is cut or whether power cord is properly connected. Try to plug another product's power cord to the outlet the TV is plugged into.
Picture turns on slowly after power is on.	This symptom is not a malfunction. This delay is designed to prevent the distorted and noisy picture when power is on. However, if the picture does not appear more than 5 minutes after power is on, call a service center.
Picture is distorted or frozen while watching digital broadcasting.	This symptom may be caused by weak reception. Contact your local station or cable company.
Input Source information only appears on black screen.	Check whether your TV is properly connected to external devices.
Poor reception on some channels.	Check whether you selected proper channels. Try re-orienting your antenna.
Black and white on some channels.	Check other channels for black and white screen. Adjust colour.
TV won't turn on.	Ensure the power cord is plugged. Adjust brightness.
Screen is too bright or too dark.	Ensure to use the remote control or power button on the product to turn off your TV. If

Auto On does not work.

you unplug the power cord, the stand-by consumption power becomes 0 (zero), which causes the programmed time to be erased.

After setting the time, I turned TV off and turn it on. The programmed information has been erased.

Ensure to use the remote control or power button on the product to turn off your TV. If you unplug the power cord, the stand-by consumption power becomes 0 (zero), which causes the programmed time to be erased.

Sound Problems

Symptom

Possible solution

Too much noise occurs.

Check whether the audio setting is in the Stereo mode. In the Stereo mode, the sound may be distorted in the area where experiences poor reception or is located far away from a TV broadcasting station.

No sound while viewing a cable channel

Make sure an audio or audio/video component is securely inserted into the appropriate jacks. Check other channels for sound. Check the volume settings on the cable broadcasting receiver.

Picture is OK but sound does not come out.

Try to press volume up/volume down buttons of your remote control.
Try to press MUTE buttons of your remote control.

One of the speakers does not produce sound.

Select sound balance and make proper adjustment. (Page 39)
Check the speaker connection cables.

General

Symptom

Possible solution

Remote control won't work.

Check whether there is a blocking object between the remote control and TV. Make sure your TV is Power On. (In case of normal, LED on the front panel is in Red.) Check whether batteries are inserted with proper polarities(+, -). When the batteries are worn out, replace with new ones.

Where does the S-Video cable plug in for audio output?

Connect the two Audio jacks from the S-Video cable to the left and right ports on the Composite.

Strange noises are heard.

Ticking noise during or after watching is caused by the change of ambient environment such as humidity and temperature, which is characterized by plastic products. Strange ticking noise occurs because a signal is suddenly transmitted to the TV panel. So, this is not a malfunction.

I tried to use the TV screen as a PC monitor but it doesn't work.

Adjust the resolution referring to the standard signal mode table. Check the specification of your video card installed in your PC. If your video card does not work in supported hardware. Try upgrading the video card's driver.



Care and Cleaning

Cabinet Cleaning

Wipe a soft dry cloth.

Do not use inflammables like Benzene or Thinner, or wet clothes.
Do not scratch the panel of PDP with a fingernail or pointed object.



Screen Cleaning

Clean the screen with a soft cloth moistened in mild glass detergent and dry with a soft cloth.

Never use any solvent on the screen such as Acetone, Benzene, or Thinner, etc.

Cleaning Inside

When the inside needs to be cleaned, contact a service center or distribution agent where the item is purchased.

It is recommended cleaning is complete before the rainy season.

Product Specifications

Model		LT26AW001	LT32DW002	LT37DW000
Input	S-Video	1EA (A/V audio common)	1EA (A/V audio common)	1EA (A/V audio common)
	Video (RCA)	1EA (Audio included)	1EA (Audio included)	1EA (Audio included)
	Component(Y/Cb/Cr)	2EA (Audio included)	2EA (Audio included)	2EA (Audio included)
	Antenna	1EA	1EA	1EA
	PC Connection jack	D-SUB	D-SUB	D-SUB
	Max. resolution	1024 X 768 @ 75 Hz	1024 X 768 @ 85 Hz	1024 X 768 @ 85 Hz
	Audio	L/R	L/R	L/R
	HDMI-HDCP	1EA	1EA	1EA
Memory Slot		No	No	No
Output	Video	1EA	1EA	1EA
	Audio	2EA (L/R, SPDIF)	2EA (L/R, SPDIF)	2EA (L/R, SPDIF)
TV/Video	Color system	NTSC M	NTSC M	NTSC M
	Sound system	FM	FM	FM
	Video system	Component, S-Video, Composite, PC, HDMI	Component, S-Video, Composite, PC, HDMI	Component, S-Video, Composite, PC, HDMI
Power	Supply	AC 100 - 240 V, 50/60 Hz	AC 100 - 240 V, 50/60 Hz	AC 100 - 240 V, 50/60 Hz
	Consumption power	Typical 130W	Typical 150W	Typical 170W
	Stand-by power	Typical 5W	Typical 2W	Typical 5W
Dimension (W x D x H mm - Stand included)		684 x 194 x 541.5	460 x 230 x 485	939 x 310 x 728
Weigh (Stand included)		12.2 Kg	16.1 Kg	25.5Kg
Control type		Remote control, Key control	Remote control, Key control	Remote control, Key control

- The above specifications may be subject to change without prior notice.