

HYUNDAI

Colour Television

Owner's Manual

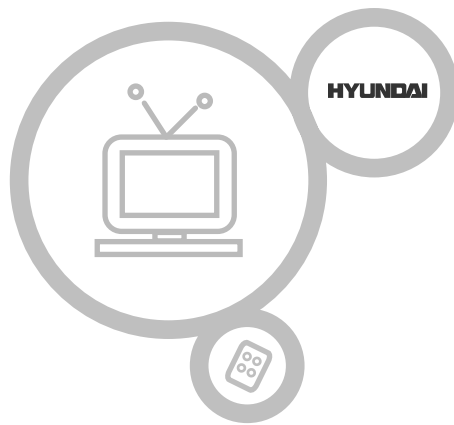

HLT-2310 / 3010

Please read this manual carefully before operating your set.
Retain it for future reference.

See the label attached on the back cover and quote this information to your dealer when you require service.

P/NO : MAN04HY0002

Warning



CAUTION
RISK OF ELECTRIC SHOCK
DO NOT OPEN



WARNING:

TO REDUCE THE RISK OF ELECTRIC SHOCK DO NOT REMOVE COVER (OR BACK). NO USER SERVICE-ABLE PARTS INSIDE. REFER TO QUALIFIED SERVICE PERSONNEL.



The lightning flash with arrowhead symbol, within an equilateral triangle, is intended to alert the user to the presence of uninsulated "dangerous voltage" within the product's enclosure that may be of sufficient magnitude to constitute a risk of electric shock to persons.



The exclamation point within an equilateral triangle is intended to alert the user to the presence of important operating and maintenance (servicing) instructions in the literature accompanying the appliance.

WARNING:

TO PREVENT FIRE OR SHOCK HAZARDS, DO NOT EXPOSE THIS PRODUCT TO RAIN OR MOISTURE.

NOTE TO CABLE/TV INSTALLER:

This reminder is provided to call the CATV system installer's attention to Article 820-40 of the National Electric Code (U.S.A.). The code provides guidelines for proper grounding and, in particular, specifies that the cable ground shall be connected to the grounding system of the building, as close to the point of the cable entry as practical.

REGULATORY INFORMATION

This equipment has been tested and found to comply with the limits for a Class B digital device, pursuant to Part 15 of the FCC Rules. These limits are designed to provide reasonable protection against harmful interference in a residential installation. This equipment generates, uses and can radiate radio frequency energy and, if not installed and used in accordance with the instructions, may cause harmful interference to radio communications. However, there is no guarantee that interference will not occur in a particular installation. If this equipment does cause harmful interference to radio or television reception,

which can be determined by turning the equipment off and on, the user is encouraged to try to correct the interference by one or more of the following measures:

- Reorient or relocate the receiving antenna.
- Increase the separation between the equipment and receiver.
- Connect the equipment into an outlet on a circuit different from that to which the receiver is connected.
- Consult the dealer or an experienced radio/TV technician for help.

Any changes or modifications not expressly approved by the party responsible for compliance could void the user's authority to operate the equipment.

Important safeguards for you and your new product

Your product has been manufactured and tested with your safety in mind. However, improper use can result in potential electrical shock or fire hazards. To avoid defeating the safeguards that have been built into your new product, please read and observe the following safety points when installing and using your new product, and save them for future reference.

Observing the simple precautions discussed in this booklet can help you get many years of enjoyment and safe operation that are built into your new product.

This product complies with all applicable U.S. Federal safety requirements, and those of the Canadian Standards Association.

1. Read Instructions

All the safety and operating instructions should be read before the product is operated.

2. Follow Instructions

All operating and use instructions should be followed.

3. Retain Instructions

The safety and operating instructions should be retained for future reference.

4. Heed Warnings

All warnings on the product and in the operating instructions should be adhered to.

5. Cleaning

Unplug this product from the wall outlet before cleaning. Do not use liquid cleaners or aerosol cleaners. Use a damp cloth for cleaning.

6. Water and Moisture

Do not use this product near water, for example, near a bath tub, wash bowl, kitchen sink, or laundry tub, in a wet basement, or near a swimming pool.

7. Accessories Carts and Stands

Do not place this product on a slippery or tilted surface, or on an unstable cart, stand, tripod, bracket, or table. The product may slide or fall, causing serious injury to a child or adult, and serious damage to the product. Use only with a cart, stand, tripod, bracket, or table recommended by the manufacturer, or sold with the product. Any mounting of the product should follow the manufacturer's instructions, and should use a mounting accessory recommended by the manufacturer.

8. Transporting Product

A product and cart combination should be moved with care. Quick stops, excessive force, and uneven surfaces may cause the product and cart combination to overturn.



9. Attachments

Do not use attachments not recommended by the product manufacturer as they may cause hazards.

10. Ventilation

Slots and openings in the cabinet are provided for ventilation and to ensure reliable operation of the product and to protect it from overheating, and these openings must not be blocked or covered. The openings should never be blocked by placing the product on a bed, sofa, rug, or other similar surface. This product should not be placed in a built-in installation such as a bookcase or rack unless proper ventilation is provided or the manufacturer's instructions have been adhered to.

11. Power Sources

This product should be operated only from the type of power source indicated on the marking label. If you are not sure of the type of power supply to your home, consult your product dealer or local power company. For products intended to operate from battery power, or other sources, refer to the operating instructions.

12. Power-Cord Polarization

This product is equipped with a three-wire grounding type plug, a plug having a third (grounding) pin. This plug will only fit into the grounding-type power outlet. This is a safety feature. If you are unable to insert the plug into the outlet, contact your electrician to replace your obsolete outlet. Do not defeat the safety purpose of the grounding-type plug.

13. Power-Cord Protection

Power-supply cords should be routed so that they are not likely to be walked on or pinched by items placed upon or against them, paying particular attention to cords at plugs, convenience receptacles, and the point where they exit from the product.

14. Outdoor Antenna Grounding

If an outside antenna or cable system is connected to the product, be sure the antenna or cable system is grounded so as to provide some protection against voltage surges and built-up static charges. Article 810 of the National Electrical Code (U.S.A.), ANSI/ NFPA 70 provides information with regard to proper grounding of the mast and supporting structure, grounding of the lead-in wire to an antenna discharge unit, size of grounding conductors, location of antenna-discharge unit, connection to grounding electrodes, and requirements for the grounding electrode.

Example of Grounding According to National Electrical Code Instructions

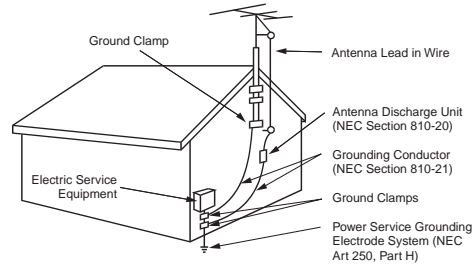

NEC - National Electrical Code

15. Lightning

For added protection for this product (receiver) during a lightning storm, or when it is left unattended and unused for long periods of time, unplug it from the wall outlet and disconnect the antenna or cable system. This will prevent damage to the product due to lightning and power-line surges.

16. Power Lines

An outside antenna system should not be located in the vicinity of overhead power lines or other electric light or power circuits, or where it can fall into such power lines or circuits. When installing an outside antenna system, extreme care should be taken to keep from touching such power lines or circuits as contact with them might be fatal.

17. Overloading

Do not overload wall outlets and extension cords as this can result in a risk of fire or electric shock.

18. Object and Liquid Entry

Never push objects of any kind into this product through openings as they may touch dangerous voltage points or short-out parts that could result in

a fire or electric shock. Never spill liquid of any kind on the product.

19. Servicing

Do not attempt to service this product yourself as opening or removing covers may expose you to dangerous voltage or other hazards. Refer all servicing to qualified service personnel.

20. Damage Requiring Service

Unplug this product from the wall outlet and refer servicing to qualified service personnel under the following conditions:

- If the power-supply cord or plug is damaged.
- If liquid has been spilled, or objects have fallen into the product.
- If the product has been exposed to rain or water.
- If the product does not operate normally by following the operating instructions. Adjust only those controls that are covered by the operating instructions as an improper adjustment of other controls may result in damage and will often require extensive work by a qualified technician to restore the product to its normal operation.
- If the product has been dropped or the cabinet has been damaged.
- If the product exhibits a distinct change in performance.

21. Replacement Parts

When replacement parts are required, be sure the service technician has used replacement parts specified by the manufacturer or have the same characteristics as the original part. Unauthorized substitutions may result in fire, electric shock, or other hazards.

22. Safety Check

Upon completion of any service or repairs to this product, ask the service technician to perform safety checks to determine that the product is in proper operating condition.

23. Wall or Ceiling Mounting

The product should be mounted to a wall or ceiling only as recommended by the manufacturer. The product may slide or fall, causing serious injury to a child or adult, and serious damage to the product.

24. Heat

The product should be situated away from heat sources such as radiators, heat registers, stoves, or other products (including amplifiers) that produce heat.

Warnings	2	AVL (Auto Volume Leveler) Stereo/Dual/NICAM reception	
Safety Instructions	3-4		
Contents	5		
Location and function of controls	6-9		
Remote control handset			
Battery installation			
Front panel			
Back panel			
Installation	10		
Connection to External equipment	11-14		
Connecting to an Inside Antenna Setup			
Connecting to an Outdoor Antenna Setup			
VCR Setup			
Cable TV Setup			
External A/V Source Setup			
DVD Setup			
DTV Setup			
PC Setup			
Basic operation	15		
On and Off / Programme selection			
Volume adjustment			
On screen language selection (option)			
On screen menus	16		
Menu selection			
Picture adjustment	17-18		
PSM (Picture Status Memory)			
Manual Picture Control			
Picture Format			
Sound adjustment	19-21		
SSM (Sound Status Memory)			
Balance			
		Setting up TV stations	22-23
		Memorizing the Channels with Auto	
		Add/Delete Channels with Manual	
		Fine Tuning Adjustment	
		Favorite Channels Setup	
		Time Menu	24-25
		Clock	
		On/Off Time	
		Auto sleep / Sleep timer	
		Special Menu	26
		CSM (Colour Status Memory)	
		Caption	
		Caption/Text	
		Lock Menu	27-28
		Lock Menu options	
		Lock Menu Setup	
		RGB-PC Menu	29
		PC Setup	
		PIP (Picture-In-Picture) Feature	30-31
		Watching PIP	
		Moving the PIP	
		Swapping the PIP	
		Selecting a Input Signal Source for the PIP	
		Programme selection for sub picture	
		Programme scan	
		External Control Device Setup	32-39
		Displayable Monitor Specification	40
		Troubleshooting Check list	43

Location and function of controls

Remote control handset

- All the functions can be controlled with the remote control handset.
- Some functions can also be adjusted with the buttons on the front panel of the set.
- Before you use the remote control handset, please install the batteries.

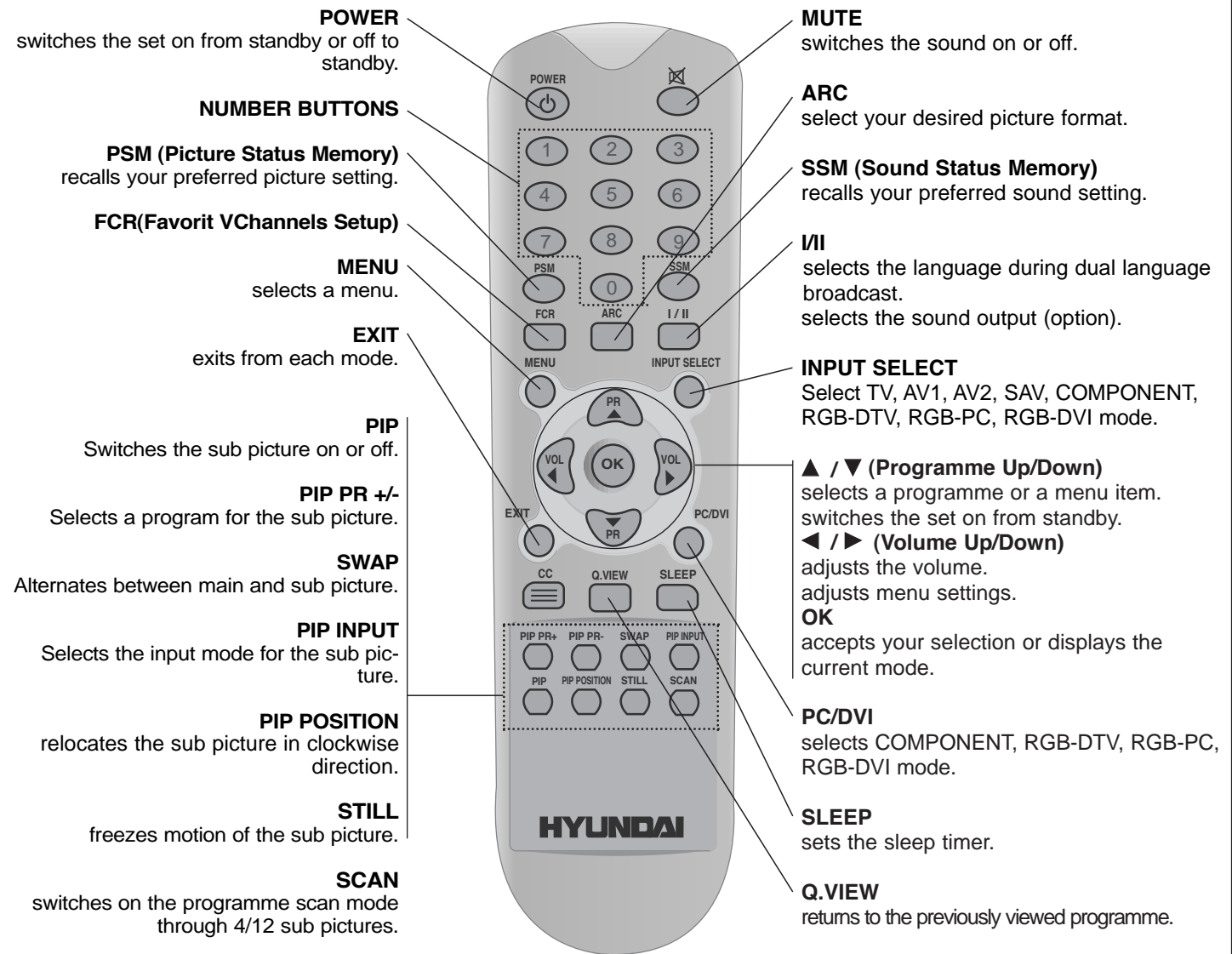

Location and function of controls

Battery installation

- Your remote control handset is powered by two AAA type batteries.

1

To insert batteries, turn the remote control handset over and remove the battery cover.

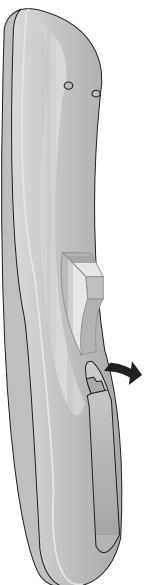
**2**

Put the two batteries into the compartment observing battery polarity.

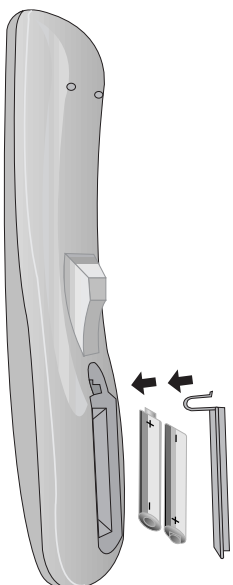
**3**

Replace the cover.

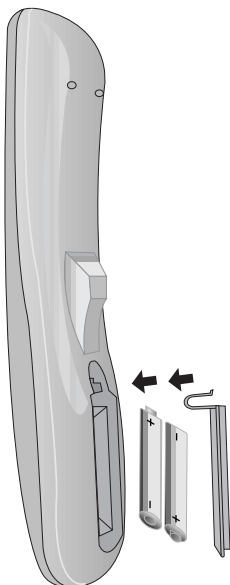

To avoid damage from possible battery leakage, remove the batteries if you do not plan to use the remote control handset for an extended period time. Do not use batteries of differing age or type. Always discard of batteries safely.

Location and function of controls

Front panel

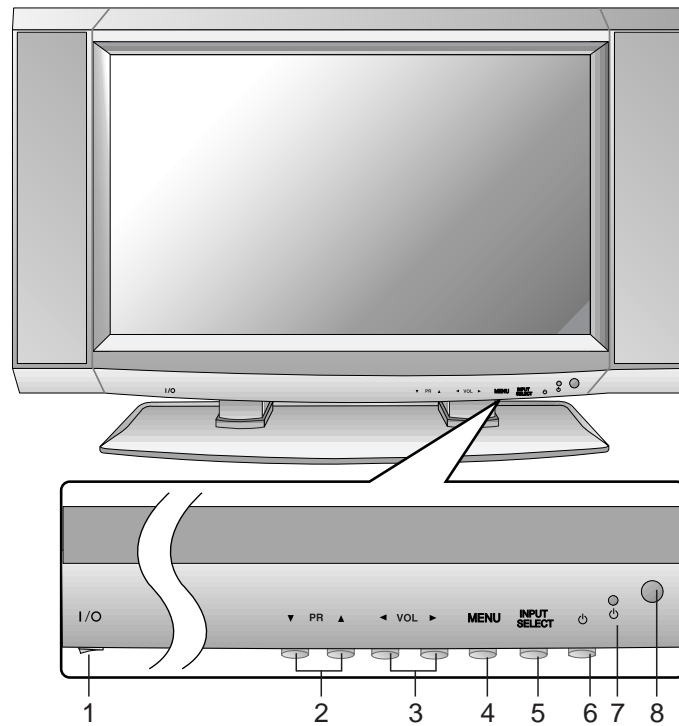

1. MAIN POWER

switches the set on or off.

2. ▲ / ▼ (Programme Up/Down)

selects a programme or a menu item.
switches the set on from standby.

3. ◀ / ▶ (Volume Down/Up)

adjusts the volume.
adjusts menu settings.

4. MENU

selects a menu.

5. INPUT SELECT

selects **TV, AV1, AV2, S-Video, Component, RGB-DTV, RGB-PC, RGB-DVI** mode.
switches the set on from standby.

6. POWER (I / ⏻)

switches the set on from standby or off to standby.

7. POWER/STANDBY INDICATOR (Ⓞ)

illuminates red in standby mode.
illuminates green when the set is switched on.

8. REMOTE CONTROL SENSOR

Location and function of controls

Back panel

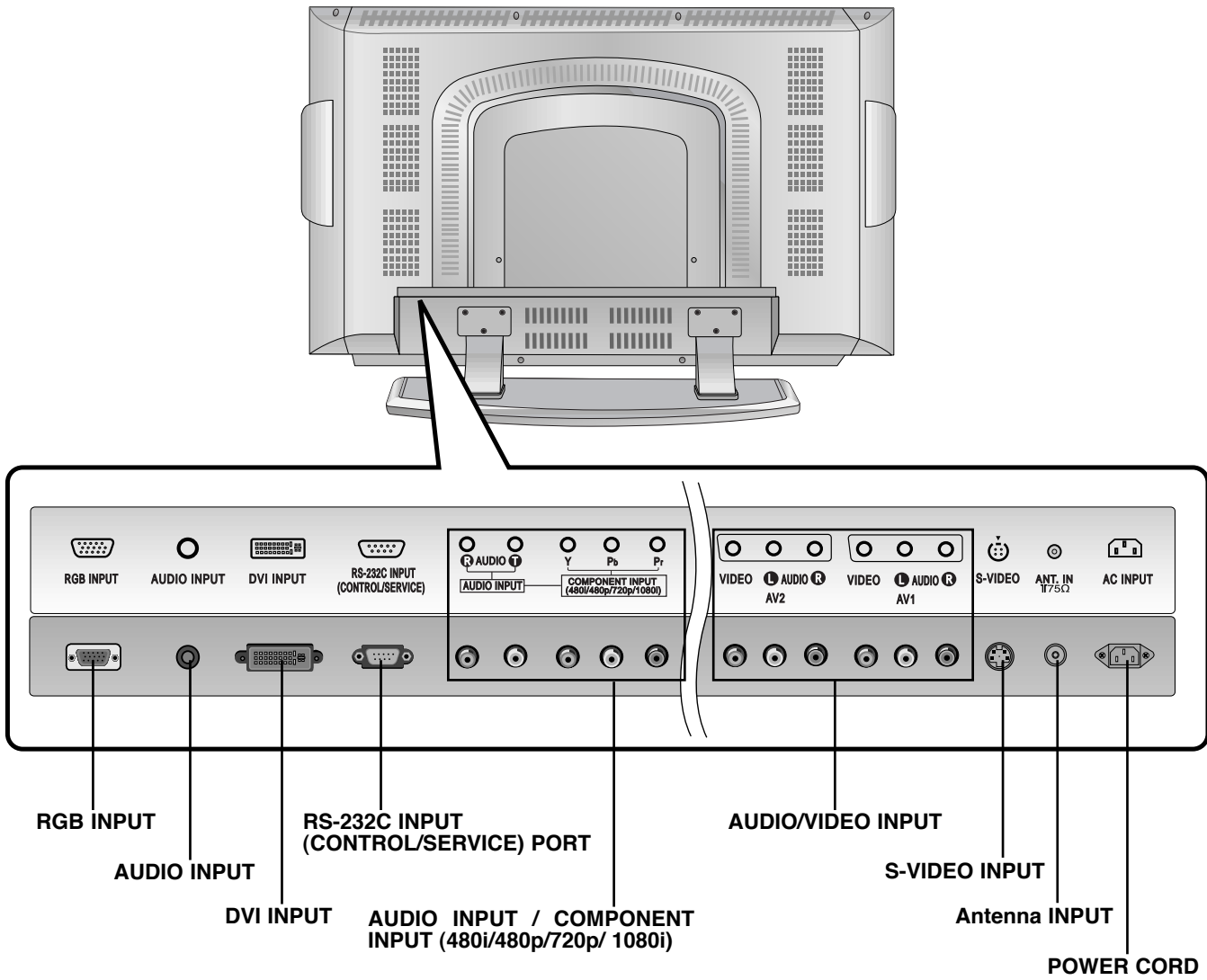

Installation

Power

This set operates on an AC mains supply, the voltage is as indicated on the label on the back cover. Never apply DC power to the set. In the event of thunderstorms or power-cuts, please pull out the aerial and mains plugs.

Warning

To prevent fire or shock hazard, do not expose the set to rain or moisture. Do not rub or strike the Active Matrix LCD with anything hard as this may scratch, mar, or damage the Active Matrix LCD permanently.

Service

Never remove the back cover of the set as this can expose you to very high voltage and other hazards. If the set does not operate properly, unplug it and call your dealer.

Aerial

Connect the aerial cable to the socket marked 75Ω on the back cover. For the best reception an outdoor aerial should be used.

Location

Position your set so that no bright light or sunlight falls directly onto the screen. Care should be taken not to expose the set to any unnecessary vibration, moisture, dust or heat. Also ensure that the set is placed in a position to allow a free flow of air. Do not cover the ventilation openings on the back cover.

Cleaning

Unplug the set before cleaning the face of the LCD Screen. Dust the set by wiping the screen and the cabinet with a soft, clean cloth. If the screen requires additional cleaning, use a clean, damp cloth. Do not use liquid cleaners or aerosol cleaners.

Connecting to an Inside Antenna Setup

- Typical wall antenna jack used in apartment buildings, connect the antenna cable as shown below. (Use the correct type of antenna cable for the type of wall antenna jack.)

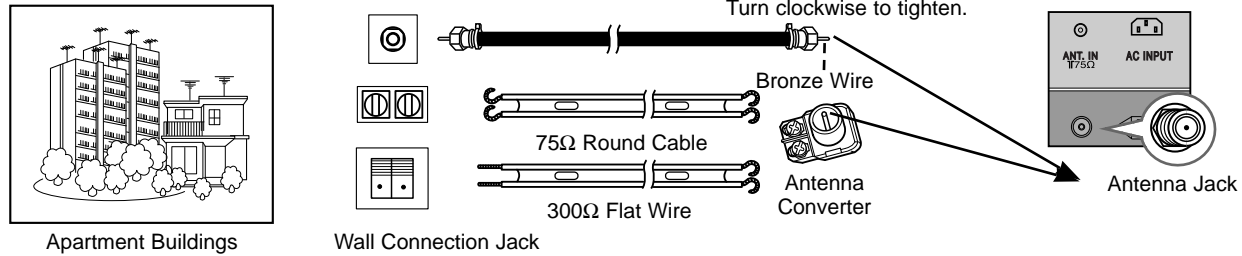

- If you have a 75Ω round cable, insert the bronze wire and then tighten the connection nut. If you have a 300Ω flat wire, connect the twisted wire to the antenna converter and then connect the converter to the antenna jack on the TV.
- If using 75Ω round cable, do not bend the bronze wire. It may cause poor picture quality.

Connecting to an Outdoor Antenna Setup

- This type of antenna is commonly used in single family dwellings.

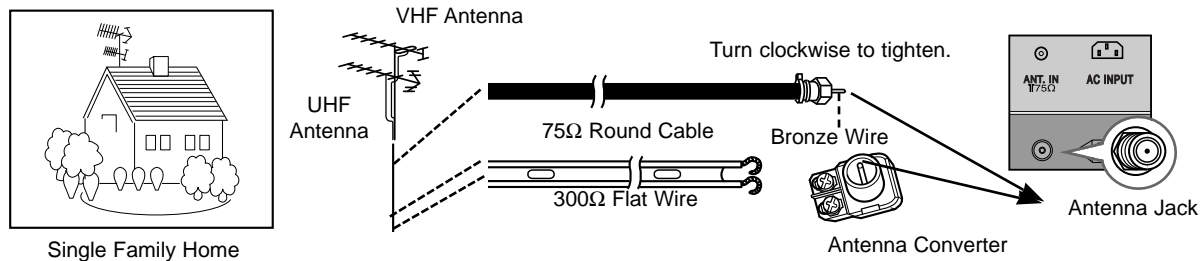

- In poor signal areas, to get better picture quality, install a signal amplifier to the antenna as shown to the right.
- If signal needs to be split for two TVs, use an antenna signal splitter for connection.

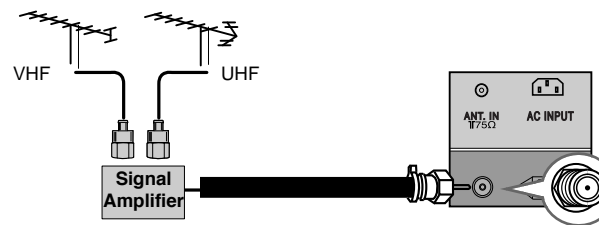

Connection to External equipment

VCR Setup

- In Video mode, TV automatically reverts to TV mode if the fcr button or flashbk buttons are pressed.

Connection 1

Set VCR switch to 3 or 4 and then tune TV to the same channel number.

Connection 2

1. Connect the audio/video output jacks on VCR to the corresponding input jacks on the TV. When connecting the TV to a VCR, match the jack colors (Video = yellow, Audio Left = white, and Audio Right = red).
2. Insert a video tape into the VCR and press PLAY on the VCR. (Refer to the VCR owner's manual.)
3. Use the **INPUT SELECT** button on the remote control to select **AV1** or **AV2**. (If connected to S-VIDEO on side panel, select the **S-Video** external input source.)

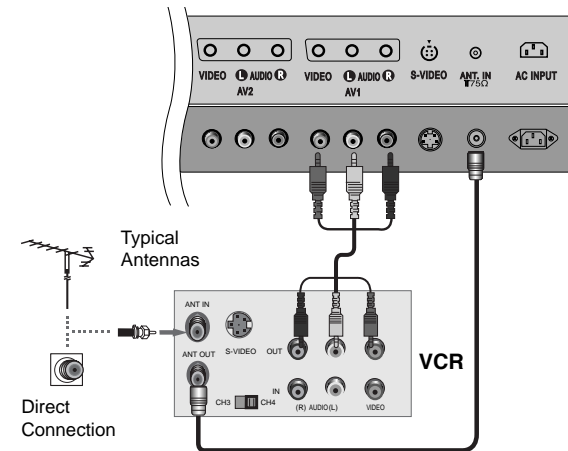

Cable TV Setup

- After subscribing to a local cable TV service and installing a converter, you can watch cable TV programming.
- For further cable TV information, contact a local cable service provider.

Connection 1

1. Select 3 or 4 with channel switch on cable box.
2. Tune the TV channel to the same selected output channel of cable box.
3. Select channels at the cable box or with the cable box remote control.

Connection 2

1. Connect the audio/video output jacks on Cable Box to the corresponding input jacks on the TV. When connecting the TV to Cable Box, match the jack colors (Video = yellow, Audio Left = white, and Audio Right = red).
2. Use the **INPUT SELECT** button on the remote control to select **AV1** or **AV2**.
3. Select channels with the cable box remote control.

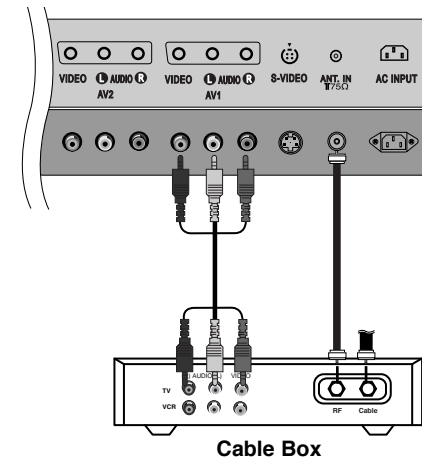

External A/V Source Setup

Connections

Connect the audio/video output jacks on the external A/V equipment to the corresponding input jacks on the TV. When connecting the TV to external A/V equipment, match the jack colors (Video = yellow, Audio Left = white, and Audio Right = red).

Viewing Setup

1. Turn on the external A/V equipment.
2. Use the **INPUT SELECT** button on the remote control to select **AV1** or **AV2**.
3. Operate the corresponding external equipment. Refer to external equipment operating guide.

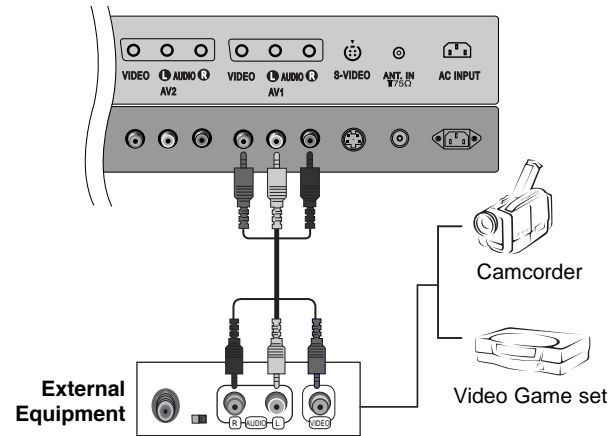

DVD Setup

Connections

Connect the DVD video outputs to the COMPONENT (Y, P_B, P_R) jacks and connect the DVD audio outputs to the AUDIO jacks.

Viewing Setup

1. Turn on the DVD player, insert a DVD.
2. Use the **INPUT SELECT** or **PC/DVI** button on the remote control to select **RGB-DVI**.
3. Refer to the DVD player's manual for operating instructions.

Component Input ports

To get better picture quality, connect a DVD player to the component input ports as shown below.

Component ports of the TV	Y	P _B	P _R
---------------------------	---	----------------	----------------

Video output ports of DVD player	Y	P _b	P _r
	Y	B-Y	R-Y
	Y	C _b	C _r
	Y	P _B	P _R

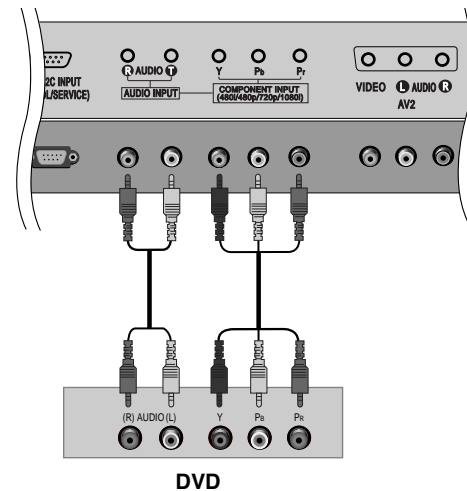

Connection to External equipment

DTV Setup

- To watch digitally broadcast programs, purchase and connect a digital set-top box.

Connections

Connect the digital set-top box video outputs to the COMPONENT (Y, PB, PR) jacks and connect the digital set-top box audio outputs to the AUDIO jacks.

Viewing Setup

1. Turn on the digital set-top box. (Refer to the owner's manual for the digital set-top box.)
2. Use the **INPUT SELECT** or **PC/DVI** button on the remote control to select **RGB-DTV**.

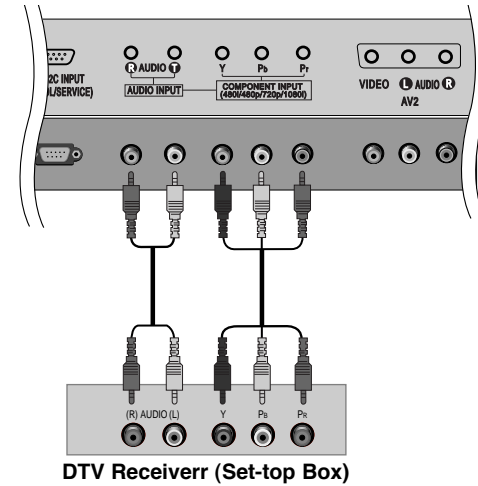

PC Setup

- After setup, be sure to select RGB-PC source on TV.

Connections

1. Set the monitor output resolution on the PC before connecting to the TV.
2. Connect the TV to the PC with the PC cable.
3. Connect the PC audio output to the TV's PC SOUND input.

Viewing Setup

1. Turn on the PC.
2. Use the **INPUT SELECT** or **PC/DVI** button on the remote control to select **RGB-PC**.

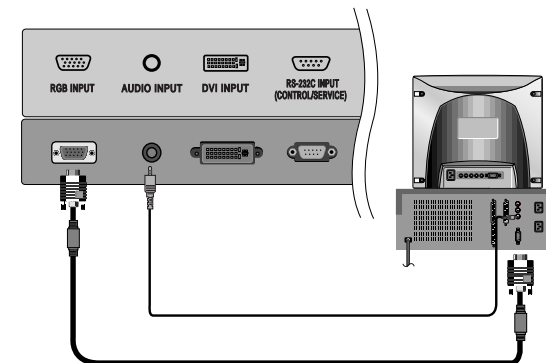

1

On and Off

Press the main power button to switch the set on.

If the set is in standby mode, press the **POWER**, **▲ / ▼**, **INPUT SELECT**, **PC/DVI** or **NUMBER** buttons on the remote control handset to switch it on fully.

Press the **POWER** button on the remote control handset.

The set reverts to standby mode.

Press the main power button again to switch the set off.

2

Programme selection

You can select a programme number with the **▲ / ▼** or **NUMBER** buttons.

3

Volume adjustment

Press the **◀ / ▶** button to adjust the volume.

If you want to switch the sound off, press the **MUTE** button. You can cancel it by pressing the **MUTE**, **◀ / ▶**, **SSM** or **I/II** button.

4

On screen language selection (option)

Press the **MENU** button and then use **▲ / ▼** button to select the **SPECIAL** menu.

Press the **▶** button and then use **▲ / ▼** button to select **Language**.

Press the **▶** button and then use **▲ / ▼** button to select your desired language. All the on screen displays will appear in the selected language.

Repeatedly press the **MENU** button to return to normal TV viewing.

On screen menus

Menu selection

- The dialogue between you and your set takes place on screen with an operator menu. The buttons required for the operating steps are also displayed.

1
Press the **MENU** button and then use **▲ / ▼** button to display each menu.

2
Press the **▶** button and then use **▲ / ▼** button to select a menu item.

3
Press the **▶** button to display the sub menu or the pull-down menu.

4
Change the setting of an item in the sub or pull-down menu with **◀ / ▶** or **▲ / ▼**.

You can move to the higher level menu with **◀** button and to move to the lower level menu press the **▶** button.

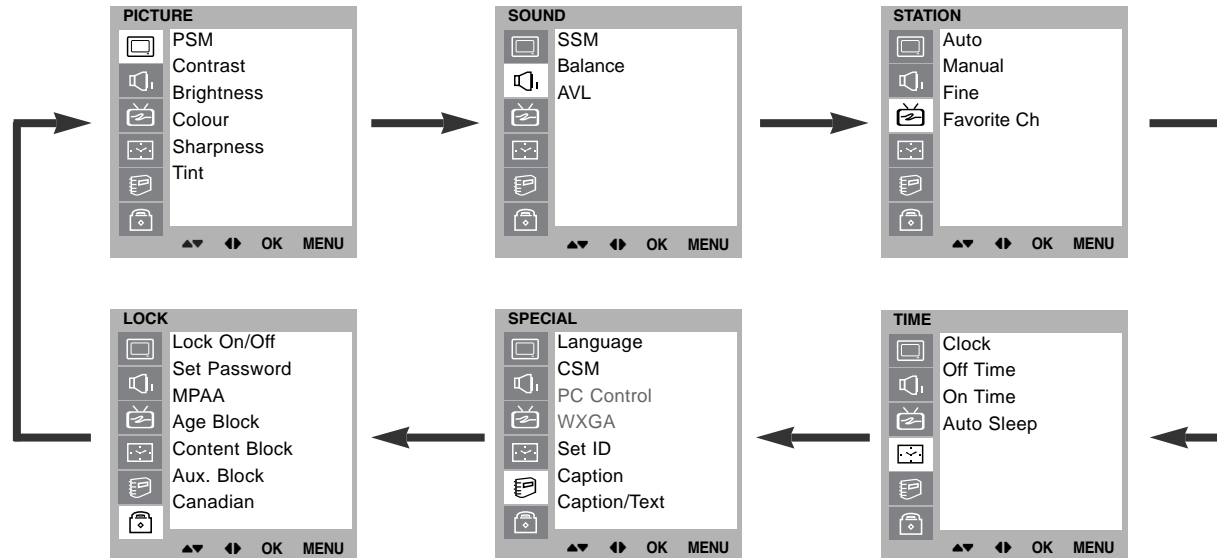

Picture adjustment

PSM (Picture Status Memory)

Press the **MENU** button and then use **▲ / ▼** button to select the PICTURE menu.

Press the **▶** button and then use **▲ / ▼** button to select **PSM**.

Press the **▶** button and then use **▲ / ▼** button to select a picture setting on the **PSM** pull-down menu.

Repeatedly press the **MENU** button to return to normal TV viewing.

You can also recall a desired picture (**Dynamic, Standard, Mild** or **User**) with **PSM** button on the remote control. The picture **Dynamic, Standard** and **Mild** are programmed for good picture reproduction at the factory and cannot be changed.

Manual Picture Control

Press the **MENU** button and then use **▲ / ▼** button to select the PICTURE menu.

Press the **▶** button and then use **▲ / ▼** button to select the desired picture option.

Press the **▶** button and then use **◀ / ▶** button to make appropriate adjustments.

You can adjust picture contrast, brightness, colour, sharpness and tint (NTSC input only) to the levels you prefer.

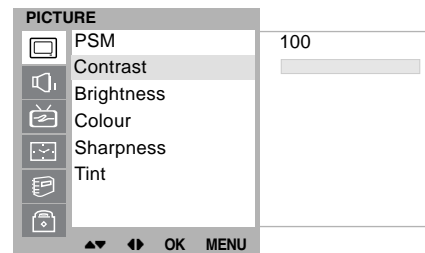
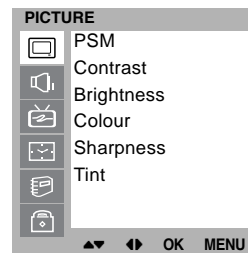
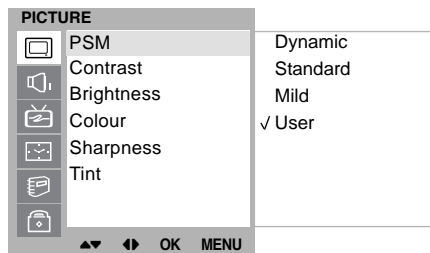
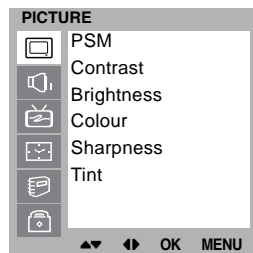

Picture adjustment

Picture Format

Picture format

You can watch TV in various picture formats; 16:9, 4:3, Zoom, Panorama. Repeatedly press the **ARC** button to select your desired picture format.

1. Press the **ARC** button to select a desired picture format.
 - Each press of **ARC** button changes the screen display as shown below.
 - You can also select **16:9**, **4:3**, **Zoom**, **Panorama** in the SCREEN menu.

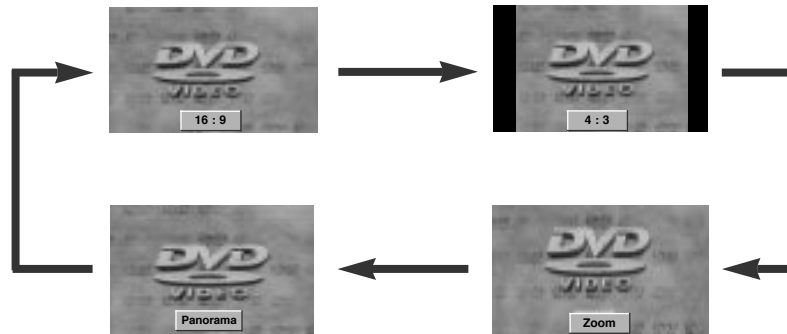

Sound adjustment

SSM (Sound Status Memory)

Press the **MENU** button and then use **▲ / ▼** button to select the **SOUND** menu.

Press the **▶** button and then use **▲ / ▼** button to select **SSM**.

Press the **▶** button and then use **▲ / ▼** button to select a sound setting on the **SSM** pull-down menu.

Repeatedly press the **MENU** button to return to normal TV viewing.

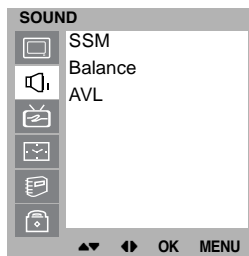

Sound Frequency Adjustment

- Press the **▶** button in **User**.
- Select a sound band by pressing the **◀ / ▶** button.
- Make appropriate sound level with the **▲ / ▼** button.
- Press the **OK** button to store it for the sound **User**.

The display **Stored** will appear.

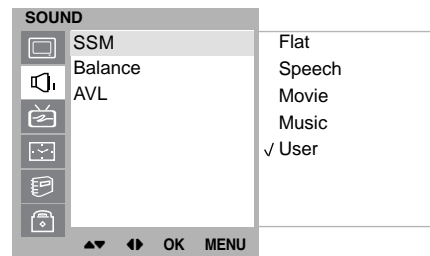

You can also recall a desired sound (**Flat, Speech, Movie, Music** or **User**) with **SSM** button on the remote control. The sound **Flat, Speech, Movie** and **Music** are programmed for good sound reproduction at the factory and cannot be changed.

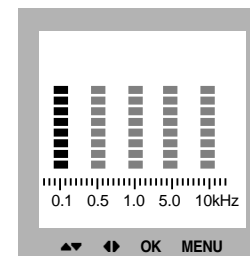

Sound adjustment

Balance

Press the **MENU** button and then use ▲ / ▼ button to select the SOUND menu.

Press the ► button and then use ▲ / ▼ button to select the desired sound item.

Press the ► button and then use ◀ / ▶ button to make appropriate adjustments.

Repeatedly press the **MENU** button to return to normal TV viewing.

AVL (Auto Volume Leveler)

Press the **MENU** button and then use ▲ / ▼ button to select the SOUND menu.

Press the ► button and then use ▲ / ▼ button to select **AVL**.

Press the ► button and then use ▲ / ▼ button to select **On** or **Off**.

Repeatedly press the **MENU** button to return to normal TV viewing.

This feature maintains an equal volume level; even if you change channels.

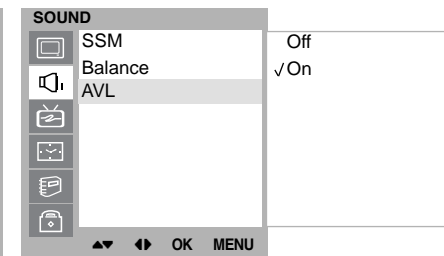
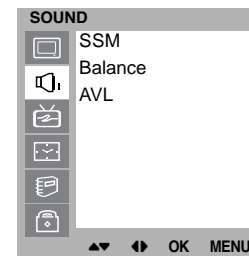
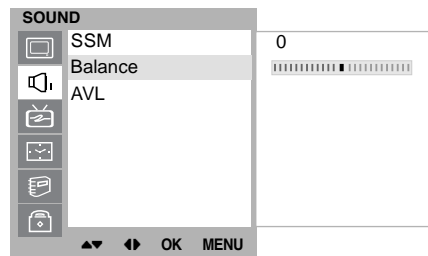
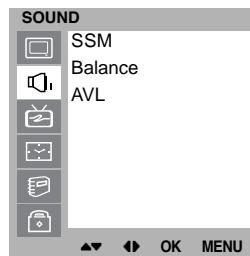

Stereo/Dual/NICAM reception

In AV mode, you can select output sound for the left and right loudspeakers.

Repeatedly press the **III** button to select the sound output.

L+R :Audio signal from audio L input is sent to left loudspeaker and audio signal from audio R input is sent to right loudspeaker.

L+L : Audio signal from audio L input is sent to left and right loudspeakers.

R+R : Audio signal from audio R input is sent to left and right loud-speakers.

Mono sound selection

In stereo reception if the stereo signal is weak, you can switch to mono by pressing the **III** button twice. In mono reception the depth of sound is improved. To switch back to stereo, press the **III** button twice again.

Language selection for dual language broadcast

If a programme received in two languages (dual language), you can switch to **DUAL I**, **DUAL II** or **DUAL I+II** by pressing the **III** button repeatedly.

DUAL I sends the primary broadcast language to the loudspeakers.

DUAL II sends the secondary broadcast language to the loudspeakers.

DUAL I+II sends a separate language to each loudspeaker.

If your set is equipped with the receiver for NICAM reception, the high quality NICAM (Near Instantaneous Companding Audio Multiplex) digital sound can be received.

Sound output can be selected according to the type of received broadcast as follows by pressing the **III** button repeatedly.

When NICAM mono is received, you can select **NICAM MONO** or FM MONO.

When NICAM stereo is received, you can select **NICAM STEREO** or FM MONO. If the stereo signal is weak, switch to FM mono.

When NICAM dual is received, you can select **NICAM DUAL I**, **NICAM DUAL II** or **NICAM DUAL I+II** or **MONO**. When FM mono is selected the display **MONO** appears on the screen.

Setting up TV stations

Memorizing the Channels with Auto

- For Auto to work, the programming source must be connected to the TV and the TV must be receiving programming signals either over-the-air or from a cable-type service provider.

1. Press the **MENU** button and then use ▲ / ▼ button to select the Station menu.
2. Press the ► button and then use ▲ / ▼ button to select **Auto**.
3. Press the ► button to begin the channel search.
 - Wait for auto program to complete the channel search cycle before choosing a channel. The TV scans for over-the-air channels and then channels provided by a cable service.

NOTES

- When the channel search is complete, use the ▲ / ▼ buttons to review the memorized channels.
- If you press the **OK** button in Auto, the function will stop and only channels programming up to that time will remain.
- Auto function can memorize only the channels which are being received at that time.

Add/Delete Channels with Manual

- You can manually include or erase individual channels.

1. Press the **MENU** button and then use ▲ / ▼ button to select the Station menu.
2. Press the ► button and then use ▲ / ▼ button to select **Manual**.
3. Press the ► button and then use ▲ / ▼ button to select a channel you want to add to memory or erase.
4. Press the ▼ button and then use ◀ / ▶ button to select **Memory** (add) or **Erase** (delete).
5. Press the **exit** button to save and return to TV viewing. The current channel is added to Memory or Erased from the channel list.

The display **Stored** will appear.

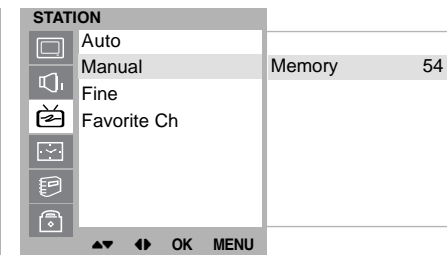
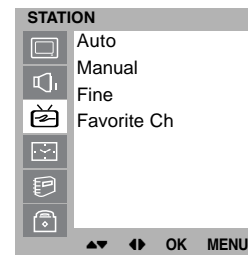
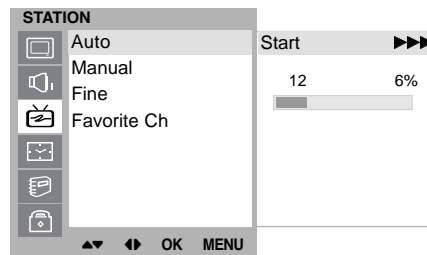
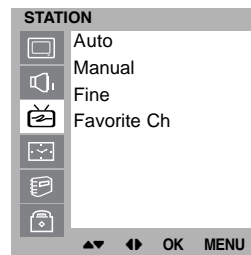

Fine Tuning Adjustment

- This function adjusts the pictures stability and condition when it is poor.

1. Press the **MENU** button and then use ▲ / ▼ button to select the Station menu.
2. Press the ► button and then use ▲ / ▼ button to select **Fine**.
3. Use the ◀ / ▶ button to adjust the picture to your preference.
4. Press the **EXIT** button to save and return to TV viewing.

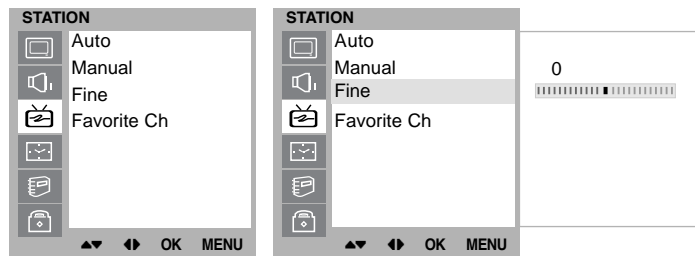

Favorite Channels Setup

- Favorite Channel lets you quickly tune in up to 5 channels of your choice without having to wait for the TV to scan through all the in-between channels.

1. Press the **MENU** button and then use ▲ / ▼ button to select the Station menu.
2. Press the ► button and then use ▲ / ▼ button to select **Favorite ch..**
3. Press the ► button and then use ▲ / ▼ button to select the first favorite channel position.
4. Use the ◀ / ▶ button to set the desired channel number for first favorite channel.
5. Repeat steps 3 to 4 to memorize other channels.
6. Press the **OK** button to save.

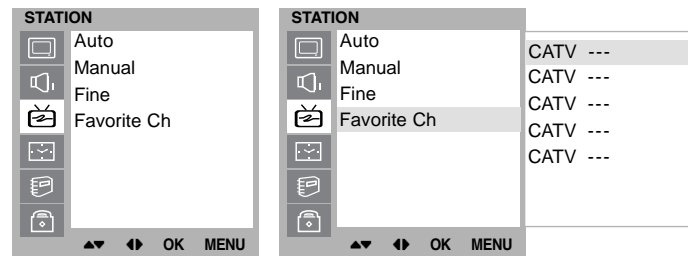

Time Menu

Clock

You must set the time correctly before using on/off time function.

Press the **MENU** button and then ▲ / ▼ button to select the TIME menu.

Press the ► button and then ▲ / ▼ button to select **Clock**.

Press the ► button and then ▲ / ▼ button to adjust the hour.

Press the ► button and then ▲ / ▼ button to adjust the minute.

Press the **MENU** or **OK** button to save.

On/Off Time

The off timer automatically switches the set to standby at the preset time.

Press the **MENU** button and then ▲ / ▼ button to select the TIME menu.

Press the ► button and then ▲ / ▼ button to select **Off Time** or **On Time**.

Press the ► button and then ▲ / ▼ button to select **On**.

To cancel **Off/On Time** function, press the ▲ / ▼ button to select **Off**.

Press the ► button and then ▲ / ▼ button to adjust the hour.

Press the ► button and then ▲ / ▼ button to adjust the minute.

Only On time function; Press the ► button and then ▲ / ▼ button to adjust volume level and programe number.

Press the **MENU** or **OK** to save.

Note :

- In the event of power interruption (disconnection or power failure), the clock must be reset.
- Two hours after the set is switched on by the on time function it will automatically switch back to standby mode unless a button has been pressed.
- Once the on or off time is set, these functions operate daily at the preset time.
- Off Timer function overrides On Timer function if they are set to the same time.
- The set must be in standby mode for the On Timer to work.

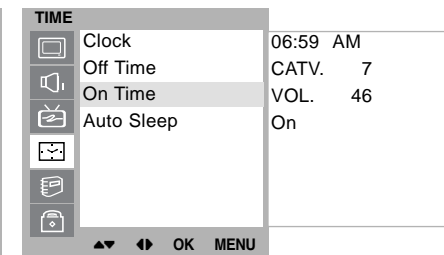
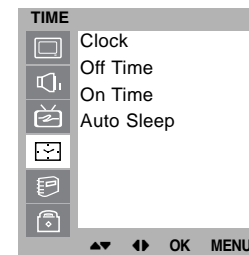
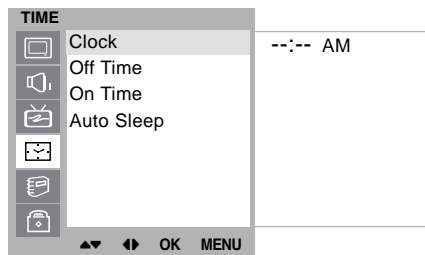
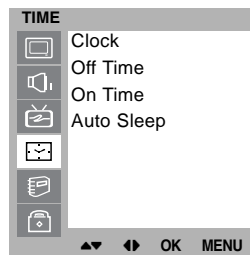

Auto sleep

If you select **On** on the **Auto Sleep** menu, the set will automatically switch itself to standby mode approximately ten minutes after a TV station stops broadcasting.

Press the **MENU** button and then **▲ / ▼** button to select the **TIME** menu.

Press the **▶** button and then **▲ / ▼** button to select **Auto Sleep**.

Press the **▶** button and then **▲ / ▼** button to select **On** or **Off**.

Press the **MENU** or **OK** button to save.

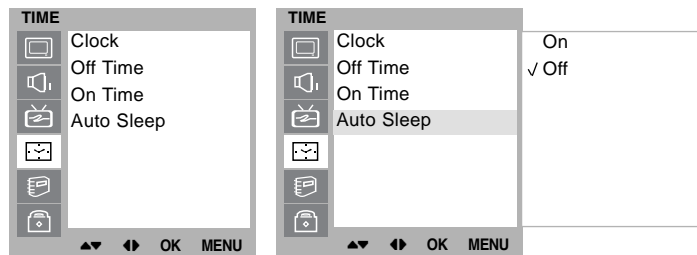

Sleep timer

You don't have to remember to switch the set off before you go to sleep. The sleep timer automatically switches the set to standby after the preset time has elapsed. Press the **SLEEP** button to select the number of minutes. The display ' **⓪ ---** ' will appear on the screen, followed by **10, 20, 30, 60, 90, 120, 180** and **240**. The timer begins to count down from the number of minutes selected.

Note :

- To view the remaining sleep time, press the **SLEEP** button once.
- To cancel the sleep time, repeatedly press the **SLEEP** button until the display ' **⓪ ---** ' appears.
- When you switch the set off, the set releases the preset sleep time.

Special Menu

CSM (Colour Status Memory)

To initialize values (reset to default settings), select the **Normal** option.

Press the **MENU** button and then **▲ / ▼** button to select the SPECIAL menu.

Press the **▶** button and then **▲ / ▼** button to select **CSM**.

Press the **▶** button and then **▲ / ▼** button to select the desired colour temperature.

Press the **MENU** button to save.

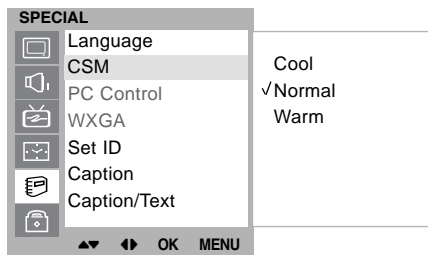

Caption

Use the **CC** button repeatedly to select Captions.

EZ Mute shows the selected captions option (if available on program) when the TV sound is muted.

Press the **MENU** button and then use **▲ / ▼** button to select the SPECIAL menu.

Press the **▶** button and then use **▲ / ▼** button to select **Caption**.

Press the **▶** button and then use **▲ / ▼** button to select **Off, On** or **Ez Mute**.

Press the **MENU** or **OK** button to save.

Note : It's not available in Component and RGB-PC modes.

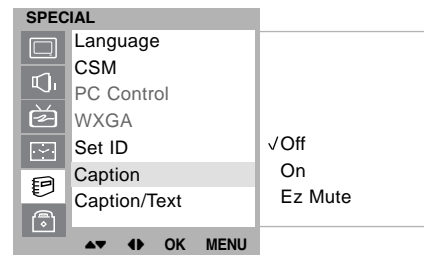

Caption/Text

Press the **menu** button and then use **▲ / ▼** button to select the SPECIAL menu.

Press the **▶** button and then use **▲ / ▼** button to select **Caption/Text**.

Use the **◀ / ▶** button to select your caption selection. Your choices are: **CC1, CC2, CC3, CC4, Text 1, Text 2, Text3** and **Text4**.

Press the **EXIT** button to save and return to TV viewing.

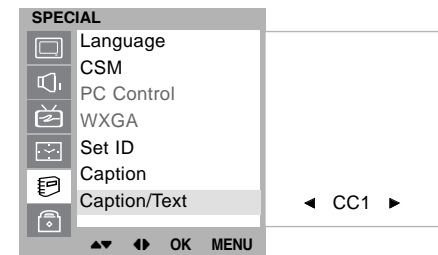

Lock Menu Options

Parental Control can be used to block specific channels, ratings and other viewing sources.

The Parental Control Function (V-Chip) is used to block program viewing based on the ratings sent by the broadcast station. The default setting is to allow all programs to be viewed. Viewing can be blocked by the type of program and by the categories chosen to be blocked. It is also possible to block all program viewing for a time period. To use this function, the following must be set :

1. Ratings and categories to be blocked.
2. Set a password
3. Enable the lock

V-Chip rating and categories

Rating guidelines are provided by broadcast stations. Most television programs and television movies can be blocked by TV Rating and/or Individual Categories. Movies that have been shown at the theaters or direct-to-video movies use the Movie Rating System (MPAA) only.

For Movies previously shown in theaters :

Movie Ratings :

- Unblocked
- G and Above (general audience)
- PG and Above (parental guidance suggested)
- PG-13 and Above (13 years and older)
- R and above (restricted)
- NC-17 and Above (18 years and older)
- X (adult)

If you set PG-13 and Above : G and PG movies will be available , PG-13, R, NC-17 and X will be blocked.

For Television programs including made-for-TV movies:

General TV Ratings:

- Unblocked
- TV-G and Above (general audience) (individual categories do not apply)
- TV-PG and Above (parental guidance suggested)
- TV-14 and Above (14 years and older)
- TV-MA (mature audience)

Children TV Ratings:

- Unblocked
- TV-Y and Above (youth) (individual content categories do not apply)
- TV-Y7 (youth, 7 years and older)

Content Categories:

- Dialog - sexual dialogue (applies to TV-PG and Above, TV-14)
- Language - adult language (applies to TV-PG and Above, TV-14 and Above, TV-MA)
- Sex scenes - sexual situations (applies to TV-PG and Above, TV-14 and Above, TV-MA)
- Violence (applies to TV-PG and Above, TV-14 and Above, TV-MA)
- F Violence - fantasy violence (applies only to TV-Y7)
- No Rating (blocks all viewing)

For Canadian English/French language rating system:

Canadian English language rating system:

- C (Children)
- C8+ (8 years and up)
- G (General programming. Suitable for all audiences.)
- PG (Parental guidance suggested)
- 14+ (Viewers 14 years and older)
- 18+ (Adult programming)

Canadian French language rating system:

- G (General)
- 8 ans+ (8 years and older)
- 13 ans+ (13 years and older)
- 16 ans+ (16 years and older)
- 18 ans+ (Adults only)

Lock Menu

Lock Menu Setup

1. Press the **MENU** button and then use **▲ / ▼** button to select the LOCK menu. Then, press the **▶** button.
 - If **Lock** is already set, enter the password requested.
 - The TV is set with the initial password "0-0-0-0".
2. **Setting Lock on/off:**

Press the **▲ / ▼** button to select **Lock on/off**.

Use the **◀ / ▶** button to select **on** or **off**.
3. **Set password:**

Press the **▲ / ▼** button to select **Set password**.

Press the **▶** button and then enter a four digit password.
Enter it again when requested.
4. Press the **▲ / ▼** button to select type of blocking to be set .
5. Press the **▶** button and then use **▲ / ▼** button to select type of ratings to block .
 - **Age block**, **Content block**, and **Canadian** menus, also have sub menus. So, repeat steps 4 and 5 in the sub menu, to set the types of blocking and ratings.

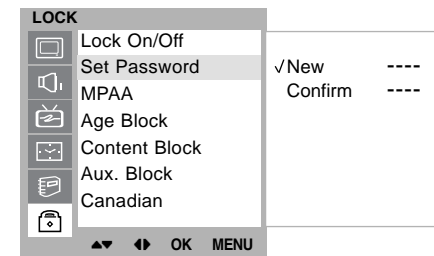
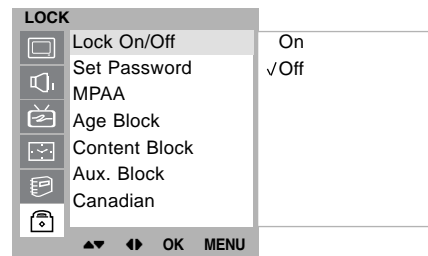
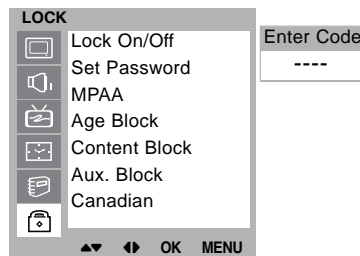

PC Setup

You can adjust horizontal/vertical position, clock, phase, and auto-configure, reset as you prefer.

Press the **MENU** button and then **▲ / ▼** button to select the SPECIAL menu.

Press the **▶** button and then **▲ / ▼** button to select the desired picture item.

Press the **◀ / ▶** button to make appropriate adjustments.

H-Position / V-Position

This function is to adjust picture to left/right and up/down as you prefer.

Clock

This function is to minimize any vertical bars or stripes visible on the screen background. And the horizontal screen size will also change.

Phase

This function allows you to remove any horizontal noise and clear or sharpen the image of characters.

WXGA

To see a normal picture, match the resolution of RGB mode and selection of XGA mode.

Auto-configure

This function is for the automatic adjustment of the screen position, clock and phase. The displayed image will disappear for a few seconds while the Auto-configuration is in progress.

Reset

This function allows you to return to the good picture reproduction programmed at the factory and cannot be changed.

Note : Some signal from some graphics boards may not function properly. If the results are unsatisfactory, adjust your monitor's position, clock and phase manually.

Press the **OK** button to store it for the PC monitor picture. Press the **EXIT** button to return to PC mode.

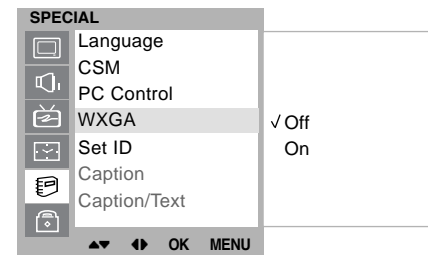
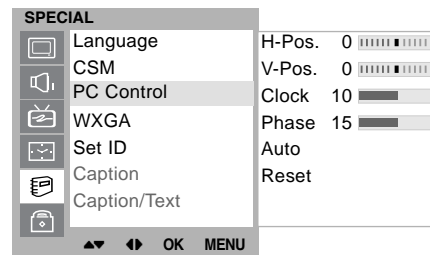
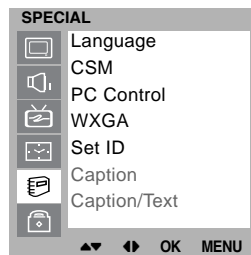

PIP (Picture-In-Picture) Feature

- PIP lets you view 2 different inputs (sources) on your monitor screen at the same time. One source will be large, and the other source will show a smaller inset image.

Watching PIP

Press the **PIP** button to show the sub picture.

- Each press of **PIP** button changes the screen display as shown below.

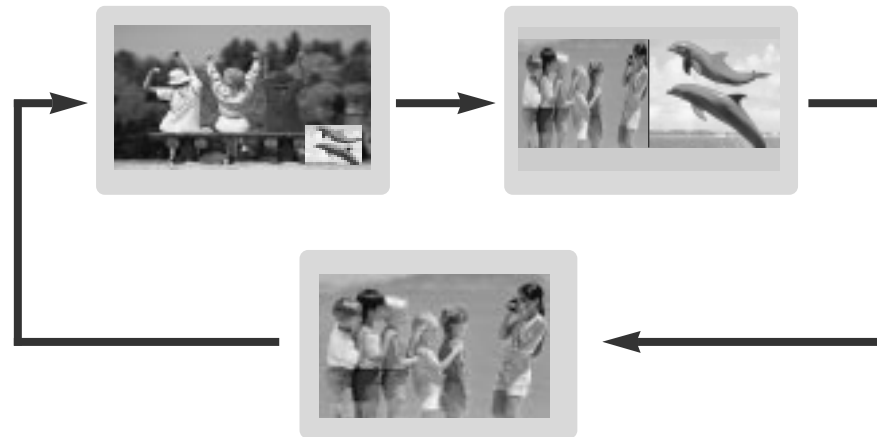

Moving the PIP

Press the **PIP POSITION** button.

Press the **PIP POSITION** button repeatedly until desired position is achieved. The sub pictures move clockwise.



PIP (Picture-In-Picture) Feature

Swapping the PIP

Press the **SWAP** button to exchange the main and sub pictures.

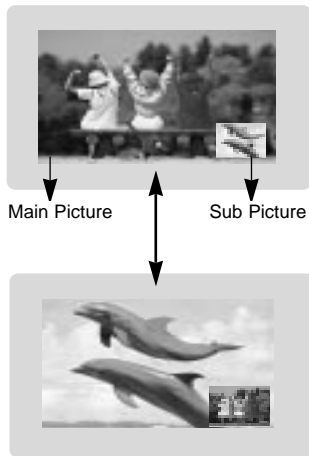

Selecting a Input Signal Source for the PIP

Use the **PIP INPUT** button to select the input source for the sub picture.



Programme selection for sub picture

Press the **PIP PR +/-** button. The selected programme number is displayed just below the programme number of main picture.

Programme scan

This function enables you to search all the stored stations on 4 or 12 sub pictures and see your favourite station by exchanging the main and sub pictures.

Press the **SCAN** button repeatedly to select POP4/POP12. The selected sub or main pictures search all the stored stations. Press the **EXIT** button to switch off sub or main pictures.



External Control Device Setup

- Connect the RS-232C input jack to an external control device (such as a computer or an A/V control system) and control the set's functions externally.

How to connect external control equipment

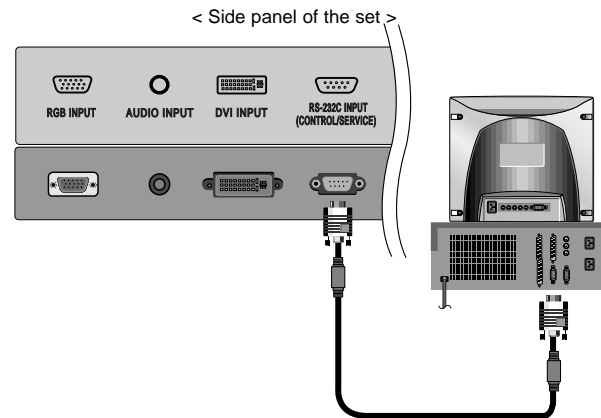

Connect the serial port of the control device to the RS-232C jack on the set.

RS-232C connection cables are not supplied with the Monitor.

The Monitor remote control and front panel controls (except main power) will not be functional if the set is controlled by a PC computer or other external device.

Type of connector; D-Sub 9-pin male

No.	Pin name
1	No connection
2	RXD (Receive data)
3	TXD (Transmit data)
4	DTR (DTE side ready)
5	GND
6	DSR (DCE side ready)
7	RTS (Ready to send)
8	CTS (Clear to send)
9	No Connection

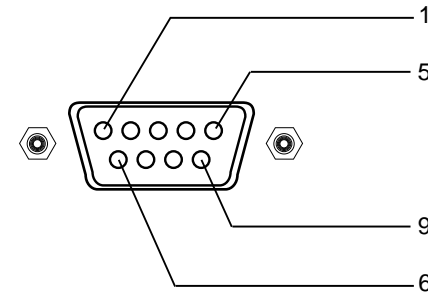

Communication Parameters

- Baud rate : 115200 bps (UART)
- Data length : 8 bits
- Parity : None
- Stop bit : 1 bit
- Communication code : ASCII code

Set ID

Press the **MENU** button and then use ▲ / ▼ button to select the SPECIAL menu.

Press the ► button and then use ▲ / ▼ button to select **Set ID**.

Press the ► button and then use ◀ / ▶ button to adjust **Set ID** to choose the desired monitor ID number.

The adjustment range of **Set ID** is 1 ~ 99.

Use this function to specify a monitor ID number.

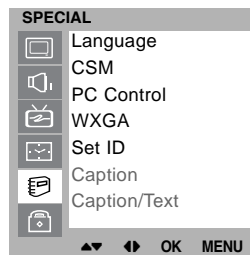

Command Reference List

	COMMAND 1	COMMAND 2	DATA (Hexadecimal)
01. Power	k	a	0 ~ 1
02. Input Select	k	m	0 ~ 7
03. Aspect Ratio	k	q	0 ~ 5
04. Screen Mute	k	b	0 ~ 1
05. Volume Mute	k	c	0 ~ 1
06. Volume Control	k	i	0 ~ 64
07. Contrast	k	d	0 ~ 64
08. Brightness	k	e	0 ~ 64
09. Colour	k	f	0 ~ 64
10. Tint	k	l	0 ~ 64
11. Sharpness	k	g	0 ~ 64
12. Remote control lock mode	k	p	0 ~ 1
13. PIP/Twin	k	r	0 ~ 2
14. PIP position	k	s	0 ~ 3
15. Balance	k	j	0 ~ 64
16. Colour temperature	k	u	0 ~ 2
17. PIP input source	k	y	0 ~ 4
18. SSM	k	h	1 ~ 5
19. AVL	k	k	0 ~ 1
20. Auto Sleep	k	n	0 ~ 1
21. Horizontal Shift	k	v	0 ~ C6
22. Vertical Shift	k	w	0 ~ 27
23. Auto Configure	k	~	1
24. Reset	k	!	1
25. On screen language selection	k	^	0 ~ 4
26. Programme Selection	k	%	0 ~ 1
27. Programme Number input	k	\$	0~64(100PR) 0~C7(200PR)
28. PSM	k	t	0 ~ 3

03. Aspect Ratio (Command2 : q) (Main picture format)

- ▶ To adjust the screen format.
You can also adjust the screen format using the ARC (Aspect Ratio Control) button on remote control handset.

Transmission

```
[k][q][ ][Set ID][ ][Data][Cr]
```

Data 0 : 16:9	3 : Zoom
1 : 14:9	4 : Panorama
2 : 4:3	5 : Auto

Acknowledgement

```
[q][ ][Set ID][ ][OK][Data][x]
```

* Using the PC input, you select either 16:9 or 4:3 screen aspect ratio.

04. Screen Mute (Command2 : b)

- ▶ To select screen mute on/off.

Transmission

```
[k][b][ ][Set ID][ ][Data][Cr]
```

Data 0 : Screen mute off (Picture on)
1 : Screen mute on (Picture off)

Acknowledgement

```
[b][ ][Set ID][ ][OK][Data][x]
```

05. Volume Mute (Command2 : c)

- ▶ To control volume mute on/off.
You can also adjust mute using the MUTE button on remote control handset.

Transmission

```
[k][c][ ][Set ID][ ][Data][Cr]
```

Data 1 : Volume mute on (Volume off)
0 : Volume mute off (Volume on)

Acknowledgement

```
[c][ ][Set ID][ ][OK][Data][x]
```

06. Volume Control (Command2 : i)

- ▶ To adjust volume.
You can also adjust volume with the volume buttons on remote control handset.

Transmission

```
[k][i][ ][Set ID][ ][Data][Cr]
```

Data Min : 0 ~ Max : 64

- Refer to 'Real data mapping 1'. See page 38.

Acknowledgement

```
[i][ ][Set ID][ ][OK][Data][x]
```

07. Contrast (Command2 : d)

- ▶ To adjust screen contrast.
You can also adjust contrast in the PICTURE menu.

Transmission

```
[k][d][ ][Set ID][ ][Data][Cr]
```

Data Min : 0 ~ Max : 64

- Refer to 'Real data mapping 1'. See page 38.

Acknowledgement

```
[d][ ][Set ID][ ][OK][Data][x]
```

08. Brightness (Command2 : e)

- ▶ To adjust screen brightness.
You can also adjust brightness in the PICTURE menu.

Transmission

```
[k][e][ ][Set ID][ ][Data][Cr]
```

Data Min : 0 ~ Max : 64

- Refer to 'Real data mapping 1'. See page 38.

Acknowledgement

```
[e][ ][Set ID][ ][OK][Data][x]
```

09. Colour (Command2 : f)

- ▶ To adjust the screen color.
You can also adjust color in the PICTURE menu.

Transmission

[k][f][][Set ID][][Data][Cr]

Data Min : 0 ~ Max : 64

- Refer to 'Real data mapping 1'. See page 38.

Acknowledgement

[f][][Set ID][][OK][Data][x]

10. Tint (Command2 : l)

- ▶ To adjust the screen tint.
You can also adjust tint in the PICTURE menu.

Transmission

[k][l][][Set ID][][Data][Cr]

Data Red : 0 ~ Green : 64

- * Refer to 'Real data mapping 1'. See page 38.

Acknowledgement

[l][][Set ID][][OK][Data][x]

11. Sharpness (Command2 : g)

- ▶ To adjust the screen sharpness.
You can also adjust sharpness in the PICTURE menu.

Transmission

[k][g][][Set ID][][Data][Cr]

Data Min: 0 ~ Max: 64

- Refer to 'Real data mapping 1'. See page 38.

Acknowledgement

[g][][Set ID][][OK][Data][x]

12. Remote Control Lock Mode (Command2 : p)

- ▶ To lock the remote control and front panel controls on the set

Transmission

[k][p][][Set ID][][Data][Cr]

Data 0: off 1: on

Acknowledgement

[p][][Set ID][][OK][Data][x]

- If you're not using the remote control, use this mode.
When main power is on/off, remote control lock is released.

13. PIP / Twin (Command2 : r)

- ▶ To control the PIP (Picture In picture) or TWIN picture.
You can also control the PIP/TWIN picture using the PIP or TWIN button on the remote control handset or in the WINDOW menu.

Transmission

[k][r][][Set ID][][Data][Cr]

Data 0: off 2: DW
1: PIP

Acknowledgement

[r][][Set ID][][OK][Data][x]

14. PIP Position (Command2 : s)

- ▶ To select sub picture position for PIP.
You can also adjust the sub picture position using POSITION on the remote control handset or in the WINDOW menu.

Transmission

[k][s][][Set ID][][Data][Cr]

Data 0: Right down on screen
1: Left down on screen
2: Left up on screen
3: Right up on screen

Acknowledgement

[s][][Set ID][][OK][Data][x]

15. Balance (Command2 : j)

- ▶ To adjust balance.
You can also adjust balance in the SOUND menu.

Transmission

Data Min: 0 ~ Max: 64

- Refer to 'Real data mapping 1'. See page 38.

Acknowledgement

16. Colour Temperature (Command2 : u)

- ▶ To adjust colour temperature.
You can also adjust Color Temp. in the PICTURE menu.

Transmission

Data 0: Cool 1: Normal 2: Warm

Acknowledgement

17. PIP Input Select (Command2 : y)

- ▶ To select input source for sub picture in PIP/Twin picture mode.

Transmission

Data 0 : TV	3 : S-Video
1 : AV1	4 : Component(480i)
2 : AV2	

Acknowledgement

- * In Component 480i for main picture, you can select RGB and DVi for sub picture.

*** Real data mapping 1**

```
0 : Step 0
⋮
A : Step 10 (SET ID 10)
⋮
F : Step 15 (SET ID 15)
10 : Step 16 (SET ID 16)
⋮
64 : Step 100
```

*** Real data mapping 2**

```
0 : -10
5 : -9
A : -8
⋮
2D : -1
32 : 0
37 : +1
⋮
5F : +9
64 : +10
```

18. SSM (Command2 : h)

- ▶ To select sound mode.

Transmission

Data 1 : Flat	4 : Music
2 : Speech	5 : User
3 : Movie	

Acknowledgement

19. AVL (Command2 : k)

- ▶ To keeps on an equal volume level even if you change programmes.

Transmission

Data 0: Off 1: On

Acknowledgement

External Control Device Setup

20. Auto Sleep (Command2 : n)

- ▶ If there is no input signal, the set turn off automatically after 10 minutes.

Transmission

```
[k][n][ ][Set ID][ ][Data][Cr]
```

Data 0: Off 1: On

Acknowledgement

```
[n][ ][Set ID][ ][OK][Data][x]
```

21. Horizontal Shift (Command2 : v)

- ▶ To adjust picture to left/right as you prefer.

Transmission

```
[k][v][ ][Set ID][ ][Data][Cr]
```

Data 0 : 0~c6

Acknowledgement

```
[v][ ][Set ID][ ][OK][Data][x]
```

22. Verical Shift (Command2 : w)

- ▶ To adjust picture to up/down as you prefer.

Transmission

```
[k][w][ ][Set ID][ ][Data][Cr]
```

Data 0 : 0 ~ 27

Acknowledgement

```
[w][ ][Set ID][ ][OK][Data][x]
```

23. Auto Configure (Command2 : ~)

- ▶ To adjust picture position and minimize image shaking automatically. It works only in RGB (PC) mode.

Transmission

```
[k][~][ ][Set ID][ ][Data][Cr]
```

Data 1: Auto Configure start

Acknowledgement

```
[~][ ][Set ID][ ][OK][Data][x]
```

24. Reset (Command2 : !)

- ▶ To return to the good picture reproduction programmed at the factory and cannot be changed.

Transmission

```
[k][!][ ][Set ID][ ][Data][Cr]
```

Data 1 : Reset start

Acknowledgement

```
[!][ ][Set ID][ ][OK][Data][x]
```

25. On screen language selection (Command2 : ^)

- ▶ To select your desired language.

Transmission

```
[k][^][ ][Set ID][ ][Data][Cr]
```

Data 0 : English
1 : German
2 : French

3 : Italy
4 : Spain

Acknowledgement

```
[^][ ][Set ID][ ][OK][Data][x]
```

Displayable Monitor Specification

RGB Mode / DVI Mode

MODE	Resolution	Horizontal Frequency (KHz)	Vertical Frequency (Hz)
DOS	720X400	31.469	70.08
		37.927	85.03
VGA	640X480	31.500	60.00
		37.500	67.00
		37.861	72.80
		37.500	75.00
		43.269	85.00
SVGA	800X600	35.156	56.25
		37.879	60.31
		48.077	72.18
		46.875	75.00
		53.674	85.06
XGA	1024X768	48.363	60.00
		56.476	70.06
		60.023	75.02
		68.677	84.99
SXGA	1152X864	54.348	60.05
		67.500	75.00
WXGA	1280X768	47.700	60.00
		56.500	70.00
		60.150	75.00
SXGA	1280X1024	63.981	60.02
MAC	832X624	49.725	74.55

(Synchronization input form : separate)

Note:

- If the set is cold, there may be a small "flicker" when the set is switched on. This is normal, there is nothing wrong with the set.
- If possible, use the VESA 1,024x768@60Hz video mode to obtain the best image quality for your LCD monitor. If used to PC vertical frequency 85Hz, some noise can be seen when PIP is on. In this case, set the PC vertical frequency to 60Hz. The set has been pre-adjusted to the mode VESA 1,024x768@60Hz.
- Some dot defects may appear on the screen, like Red, Green or Blue spots. However, this will have no impact or effect on the monitor performance.
- Do not press the LCD screen with your finger for a long time as this may produce some temporary distortion effects on the screen.
- When the PC screen appears on the set, a message may appear on the screen, and the message will differ according to the Window system version (Win98, 2000). If a message appears click "Next" until the message finishes.
- If the message "**Out Of Range**" appears on the screen, adjust the PC as in the 'Displayable Monitor Specification' section.

NOTE

NOTE

