



INSTRUCTION MANUAL

HF/VHF/UHF ALL MODE TRANSCEIVER
IC-706MKII

This device complies with Part 15 of the FCC rules. Operation is subject to the following two conditions: (1) This device may not cause harmful interference, and (2) this device must accept any interference received, including interference that may cause undesired operation.

IMPORTANT

Read this instruction manual carefully before attempting to operate the transceiver.

Save this instruction manual. This instruction manual contains important safety and operating instructions for the IC-706MKIIG.

PRECAUTIONS

⚠ WARNING HIGH VOLTAGE! NEVER attach an antenna or internal antenna connector during transmission. This may result in an electrical shock or burn.

⚠ NEVER apply AC to the [DC13.8V] socket on the transceiver rear panel. This could cause a fire or ruin the transceiver.

⚠ NEVER apply more than 16 V DC, such as a 24 V battery, to the [DC13.8V] socket on the transceiver rear panel. This could cause a fire or ruin the transceiver.

⚠ NEVER let metal, wire or other objects touch any internal part or connectors on the rear panel of the transceiver. This will cause electric shock.

⚠ NEVER expose the transceiver to rain, snow or any liquids.

NEVER allow children to play with the transceiver.

AVOID using or placing the transceiver in areas with temperatures below -10°C ($+14^{\circ}\text{F}$) or above $+60^{\circ}\text{C}$ ($+140^{\circ}\text{F}$). Be aware that temperatures on a vehicle's dashboard can exceed 80°C , resulting in permanent damage to the transceiver's front panel if left there for extended periods.

AVOID placing the transceiver in excessively dusty environments or in direct sunlight.

AVOID placing the transceiver against walls or putting anything on top of the transceiver. This will obstruct heat dissipation.

During mobile operation, **DO NOT** operate the transceiver without running the vehicle's engine. When transceiver power is ON and your vehicle's engine is OFF, the vehicle's battery will soon become exhausted.

Make sure the transceiver power is OFF before starting the vehicle. This will avoid possible damage to the transceiver by ignition voltage spikes.

During maritime mobile operation, keep the transceiver and microphone as far away as possible from the magnetic navigation compass to prevent erroneous indications.

BE CAREFUL! The heatsink will become hot when operating the transceiver continuously for long periods.

BE CAREFUL! If a linear amplifier is connected, set the transceiver's RF output power to less than the linear amplifier's maximum input level, otherwise, the linear amplifier will be damaged.

Use Icom microphones only (supplied or optional). Other manufacturer's microphones have different pin assignments and connection to the IC-706MKIIG may damage the transceiver.

Beat signals may be heard on some frequencies. These will occur as a result of circuit construction.

For U.S.A. only

Caution: Changes or modifications to this transceiver, not expressly approved by Icom Inc., could void your authority to operate this transceiver under FCC regulations.

EXPLICIT DEFINITIONS

The explicit definitions described below apply to this instruction manual.

WORD	DEFINITION
⚠ WARNING	Personal injury, fire hazard or electric shock may occur.
CAUTION	Equipment damage may occur.
NOTE	If disregarded, inconvenience only. No risk of personal injury, fire or electric shock.

TABLE OF CONTENTS

IMPORTANT	i	5 MEMORY AND SCAN OPERATION	39–44
PRECAUTIONS	i	■ Memory channels	39
EXPLICIT DEFINITIONS	i	■ Memory channel selection	39
TABLE OF CONTENTS	ii	■ Memory clearing	39
UNPACKING	ii	■ Memory/call programming	40
1 PANEL DESCRIPTION	1–8	■ Frequency transferring	41
■ Front panel	1	■ Memory names	41
■ Function switches	3	■ Memo pads	42
■ Rear and side panels	5	■ Scan types	43
■ Function display	7	■ Preparation	43
■ Microphone (HM-103)	8	■ Programmed scan operation	44
2 INSTALLATION AND CONNECTIONS ...	9–14	■ Memory scan operation	44
■ Unpacking	9	■ Select memory scan operation	44
■ Grounding	9	■ Priority watch	44
■ Antenna	9	6 REMOTE JACK (CI-V) INFORMATION ...	45–46
■ Installation	10	7 SET MODE	47–55
■ Required connections	11	■ General	47
■ Advanced connections	12	■ Quick set mode items	48
■ Power supply connections	13	■ Initial set mode items	50
■ External antenna tuners and linear amplifier	14	8 MAINTENANCE	56
3 FREQUENCY SETTING	15–19	■ Fuse replacement	56
■ When first applying power (CPU resetting)	15	■ Memory backup	56
■ Initial settings	15	■ Cleaning	56
■ VFO description	16	9 TROUBLESHOOTING	57–58
■ Frequency setting	17	10 OPTIONAL INSTALLATIONS/SETTINGS ...	59–62
■ Mode selection	19	■ Opening the transceiver case	59
4 RECEIVE AND TRANSMIT	20–38	■ UT-102 VOICE SYNTHESIZER UNIT	59
■ Functions for receive	20	■ CR-282 HIGH-STABILITY CRYSTAL UNIT	60
■ Functions for transmit	25	■ IF filters	60
■ Split frequency operation	29	■ UT-106 DSP RECEIVER UNIT	61
■ Tone squelch operation	31	■ MB-72 CARRYING HANDLE	61
■ Tone scan operation	31	■ AT-180 internal switch description	62
■ One-touch repeater	32	11 INTERNAL VIEWS	63
■ Auto repeater function	32	12 OPTIONS	64–65
■ Functions for CW	33	13 SPECIFICATIONS	66
■ Functions for RTTY	35	14 MENU GUIDE	67–68
■ Packet operation	37		
■ SWR	38		

UNPACKING

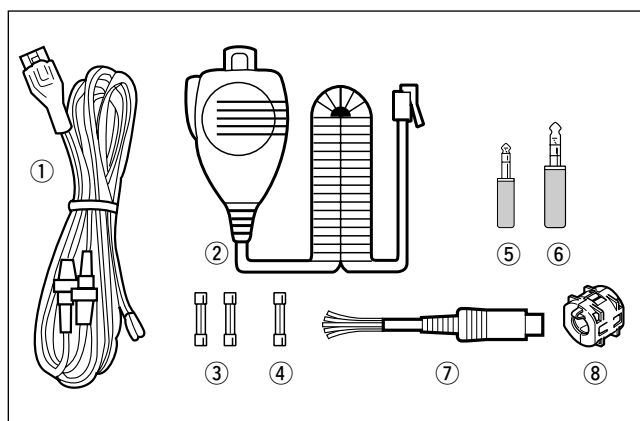

Accessories included with the IC-706MKIIG:

	Qty.
① DC power cable*	1
② Hand microphone (HM-103)	1
③ Spare fuse (30 A)	2
④ Spare fuse (4 A)	1
⑤ RTTY key plug	1
⑥ Electronic keyer plug	1
⑦ ACC cable	1
⑧ Ferrite bead**	1

*OPC-639 for Europe versions (differs from the diagram at left), OPC-025D for other versions.

**Not supplied with some versions.

Front panel

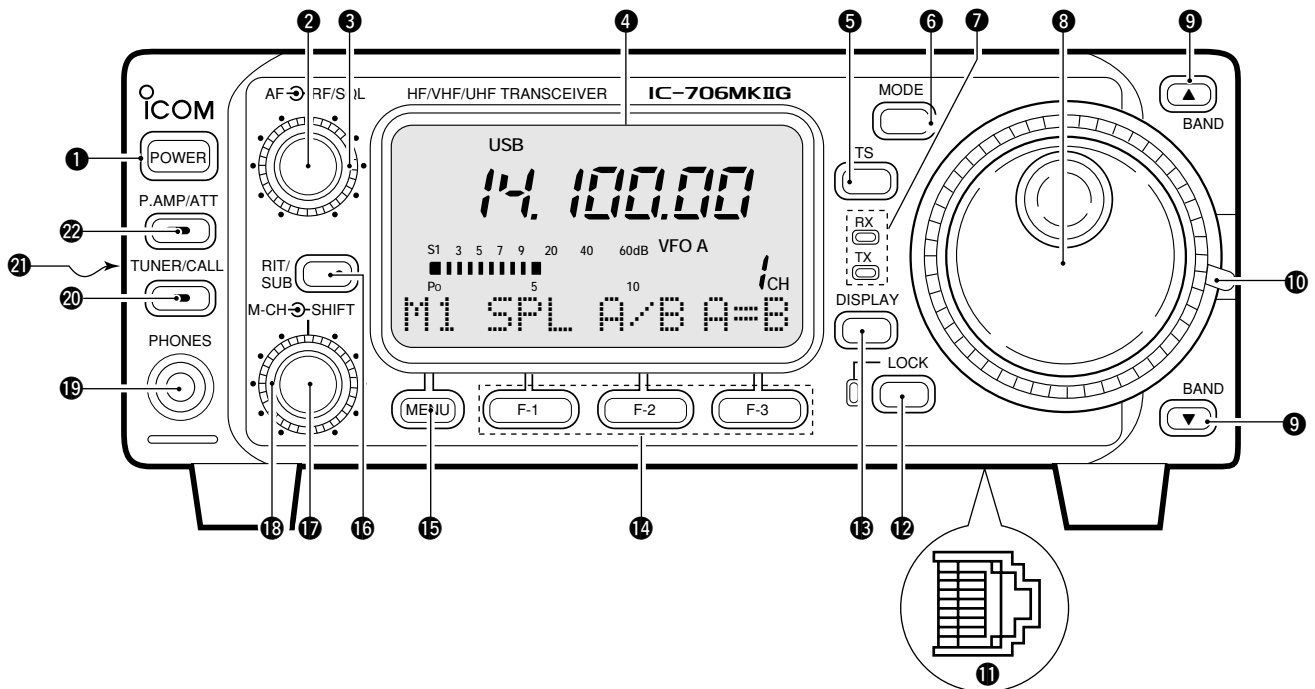

1 POWER SWITCH [POWER] (p. 15)

- Turns power ON and OFF.
- Push momentarily to turn power ON.
- Push for 2 sec. to turn power OFF.

2 AF GAIN CONTROL [AF] (inner control; p. 15)

- Rotate clockwise to increase the audio output from the speaker; rotate counterclockwise to decrease the audio output from the speaker.

3 RF GAIN CONTROL/SQUELCH CONTROL [RF/SQL] (outer control; p. 22)

- ➔ Adjusts the squelch threshold level (to mute noise when receiving no signal) in all modes.
- ➔ This control can be used for RF gain control to adjust receiver gain manually.
 - RF gain selection can be set in initial set mode (p. 50).
 - RF gain is usable in SSB/CW/RTTY modes only.

4 FUNCTION DISPLAY

- Shows the operating frequency, dot matrix indications, selected memory channel, etc. See p. 7 for details.

5 TUNING STEP SWITCH [TS] (pgs. 17, 18)

- ➔ Push momentarily to cycle between 1 Hz/10 Hz, programmable and 1 MHz tuning steps.
 - 1 and 10 Hz steps are only available in SSB, CW and RTTY modes; 1 MHz steps are only available in FM, WFM and AM modes.
- ➔ Push for 2 sec. to toggle between 1 and 10 Hz steps, or; when the programmable tuning steps is indicated, push for 2 sec. to enter programmable tuning step mode.

6 MODE SWITCH [MODE] (p. 19)

- ➔ Push momentarily to cycle through the operating modes:
 USB/LSB ↻ CW/CW \square ↻ RTTY/ \square RTTY ↻
 ↻ FM/WFM/AM
- ➔ Push and hold for 2 sec. to toggle between the following operating modes:
 USB ↔ LSB
 CW ↔ CW \square
 RTTY ↔ \square RTTY
 FM → WFM → AM → FM, etc.

7 RECEIVE/TRANSMIT INDICATORS [RX]/[TX]

- [RX] lights green while receiving (and squelch opens); [TX] lights red while transmitting.

8 MAIN DIAL

- Changes the displayed frequency, selects initial set mode items, etc.

9 UP/DOWN (BAND) SWITCHES [▲/▼(BAND)]

- ➔ Push to select a band.
 - Can also be used to advance quick set mode items, initial set mode items, etc.
- ➔ Push and hold to scroll through the bands continuously.

10 MAIN DIAL TENSION LATCH

- Selects the main dial tension.
- 2 positions are available.

11 MICROPHONE CONNECTOR (p. 8)

- Modular-type microphone connector—connects the supplied microphone (HM-103).
 - The optional OPC-589 can be used to connect an 8-pin microphone such as the SM-8 or SM-20, if desired.
 - A microphone connector is also available on the rear

panel. DO NOT connect 2 microphones simultaneously.

12 LOCK SWITCH [LOCK]

- ➔ Push momentarily to turn the dial lock function ON and OFF.
 - The dial lock function electronically locks the main dial.
- ➔ When the optional UT-102 VOICE SYNTHESIZER UNIT is installed (p. 52), push for 2 sec. to have the frequency, etc. announced.
 - UT-102 operation can be adjusted in initial set mode (pgs. 53, 54).



Lights while the lock function is activated.

13 DISPLAY SWITCH [DISP] (p. 68)

- ➔ Push momentarily to select one of the three menu sets: M1 to M4, S1 to S4 and G1 to G4.
- ➔ Push for 2 sec. to select quick set mode.

14 FUNCTION SWITCHES [F1]/[F2]/[F3] (pgs. 3, 4, 68)

- Push to select the function indicated in the dot matrix display above these switches.
- Functions vary depending on the menu set selected.

15 MENU SWITCH [MENU] (p. 68)

- ➔ Push this switch one or more times to select menus within a menu set (M, S or G), or push to advance through the quick set mode and initial set mode displays.
- ➔ Push and hold to jump between two different function menu sets.

16 RIT/SUB DIAL SWITCH [RIT/SUB] (p. 20)

- ➔ Push to toggle the RIT or SUB DIAL function ON and OFF—initial set mode is used to select the desired action*.
 - Lights green when the SUB DIAL function is ON; lights red when the RIT function is ON.
 - Use the [M-CH] control to vary the RIT frequency or SUB DIAL frequency (see above).
- ➔ When the RIT function is ON, push for 2 sec. to add or subtract the shifted frequency to the operating frequency.



Lights red while the RIT function is activated; green while the SUB DIAL function is activated.

*Even if RIT is selected in initial set mode, RIT cannot be selected when operating AM, FM or WFM modes.

17 SHIFT CONTROL [SHIFT] (outer control; p. 20)

- Shifts the center frequency of the receiver's IF passband.
- Rotate the control clockwise to shift the center frequency higher, or rotate the control counterclockwise to shift the center frequency lower.
 - When the graphic menu display (G2) is selected, the IF passband is graphically displayed and changes in accordance with the [SHIFT] control (see p. 20).

18 M-CH CONTROL [M-CH] (inner control)

- ➔ When the RIT or SUBDIAL functions are OFF, rotate to select a memory channel number (p. 35).
- ➔ Shifts the receive frequency while the RIT function is ON in SSB, CW and RTTY modes (see below and p. 20).
 - RIT variable range is ± 9.99 kHz
- ➔ Changes the operating frequency in the selected tuning steps while the SUB DIAL function is ON (p. 18).

19 HEADPHONE JACK [PHONES] (p. 12)

- Accepts headphones with 4–16 Ω impedance.
- When headphones are connected, no receive audio comes from the speaker.
 - When the PHONES/SPEAKER switch on the back of the front panel is set to the [SPEAKER] position, an external speaker can be connected. This is convenient for mobile or outdoor operation.

20 TUNER/CALL SWITCH [TUNER/CALL]

- (pgs. 26, 27)
- ➔ During HF/50 MHz operation, push this switch momentarily to toggle the automatic antenna tuner function ON/OFF.
 - An optional antenna tuner must be connected.
 - ➔ During HF/50 MHz operation, push this switch for 2 sec. to manually tune the antenna.
 - An optional antenna tuner must be connected.
 - ➔ During 144/430 MHz operation, push this switch momentarily to select the call channel (or the previous channel/frequency when the call channel is already selected). (p. 39)
 - “C1” is the 144 MHz call channel and “C2” is the 430 MHz call channel.



Lights while the automatic tuning function is activated.

21 FRONT PANEL LATCH (p. 10)

Pull away from the transceiver (towards yourself when looking at the front of the transceiver) to detach the front panel from the main body of the transceiver.

22 PREAMP/ATTENUATOR SWITCH [P.AMP/ATT]

- (p. 21)
- ➔ Push momentarily to turn the preamp ON or OFF.
 - ➔ Push and hold to turn the 20 dB attenuator ON; push momentarily to turn the attenuator OFF.
 - Lights green when the preamp is ON; lights red when the 20 dB attenuator is ON.

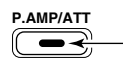

Lights green while the preamp is activated; lights red while the attenuator is activated.

Function switches

◇ M1 FUNCTIONS

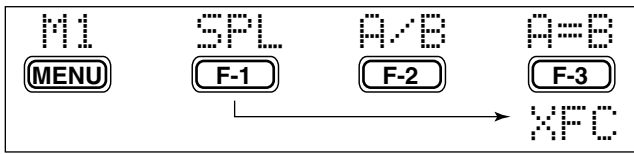

SPLIT OPERATION (p. 29)

SPL (F-1) Toggles the split function ON and OFF.
 • “**SPL**” appears when the split function is ON.
 • The function of [F-3] changes to XFC when the split function is ON.

VFO A/B SELECTION (p. 16)

A/B (F-2)
 ➔ Toggles between VFO A and VFO B in VFO mode.
 ➔ Toggles between transmission VFO and reception VFO during split operation.
 ➔ Toggles between the transmit and receive frequencies (and modes) of memory channels when the split function is turned ON.

VFO EQUALIZATION (p. 16)

A=B (F-3) Equalizes the frequency and operating mode of the two VFO's.
 • The rear (undisplayed) frequency and operating mode are equalized to the front (displayed) VFO frequency and operating mode.

TRANSMIT FREQUENCY CHECK (p. 29)

XFC (F-3) Appears when the split function is turned ON—monitors the transmit frequency when pushed and held.
 • While pushed, the transmit frequency can be changed with the main dial.

◇ M2 FUNCTIONS

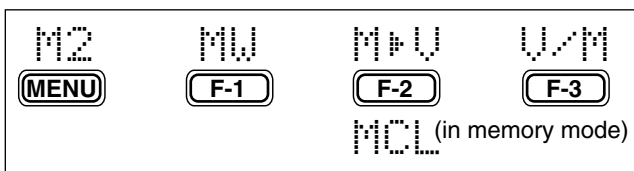

MEMORY WRITE (p. 40)

MW (F-1) Stores the displayed frequency and operating mode into the displayed memory channel.

MEMORY TRANSFER (p. 41)

M+V (F-2) Transfers the frequency and operating mode in the selected memory channel to a VFO.

VFO/MEMORY (p. 39)

V/M (F-3) Toggles between VFO and memory modes.

MEMORY CLEAR (p. 39)

MCL (F-2) Clears the selected memory channel's contents.
 • “**BLANK**” appears.

◇ M3 FUNCTIONS

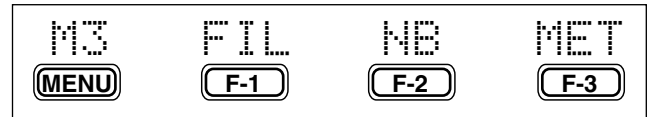

NARROW FILTER (p. 23)

FIL (F-1) Toggles the narrow filter (or wide filter—push for 2 sec.) ON and OFF.
 • “**N**” appears when the narrow filter is ON; “**W**” appears when the wide filter is ON.
 • An optional narrow filter and presetting in initial set mode (p. 51) is necessary to use the following:
 CW/RTTY narrow: FL-100, FL-101 or FL-232
 SSB narrow: FL-223
 SSB wide: FL-103

NOISE BLANKER (p. 21)

NB (F-2) Turns the noise blanker ON and OFF.
 • The noise blanker does not function in FM and WFM modes; the “AM Noise blanker” item in initial set mode must be set to ON for the noise blanker to work in AM mode (p. 53).

METER SELECTION (p. 25)

MET (F-3) Selects the type of meter displayed (during transmit) in the function display.
 • Power, ALC or SWR metering can be selected.
 • Only an S-meter is available for receive.

◇ M4 FUNCTIONS

DURING SSB/AM OPERATION:

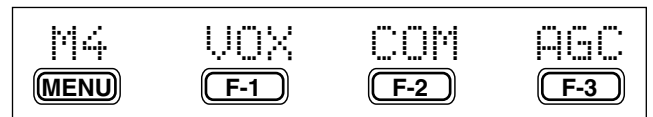

DURING CW OPERATION:

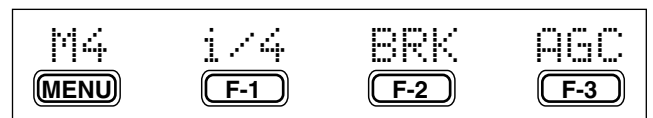

DURING RTTY OPERATION:

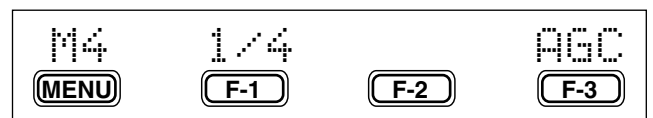

DURING FM OPERATION:

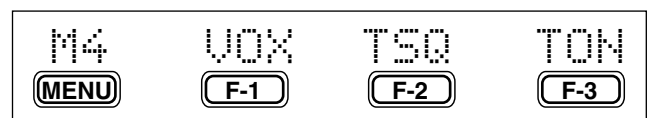

VOX FUNCTION (p. 26)

VOX Toggles the VOX function ON and OFF.
 •The [VOX GAIN] and [ANTI VOX] are available on the side panel.
 •VOX delay can be set in quick set mode (p. 48).

F-1

SPEECH COMPRESSOR (p. 26)

COM Toggles the speech compressor ON and OFF.
 •The [COMP GAIN] control is available on the side panel.

F-2

AGC (p. 21)

AGC Changes the time constant of the AGC circuit.

F-3

BREAK-IN (p. 33)

BRK Selects semi break-in, full break-in (QSK) and break-in OFF
 •“BK” or “F-BK” appears when selecting semi break-in or full break-in, respectively.
 •An external switch, such as a foot switch, is necessary to connect to the ACC socket (pin 3, pin 7 or RTTY SEND—see p. 35) to use no break-in operation.

F-2

1/4 FUNCTION (p. 36)

1/4 Toggles the 1/4 function ON and OFF.
 •When the 1/4 function is ON, a bar appears under the 1/4 indication and fine tuning can be used.

F-1

TONE SQUELCH (p. 31)

TSQ Toggles the tone squelch function ON and OFF (a tone squelch frequency must be selected in Quick Set mode).
 •“FM-TSQL” appears when the function is ON.

F-2

REPEATER TONE OPERATION (p. 30)

TON Toggles the subaudible tone encoder for repeater use ON and OFF.
 •“FM-T” appears when the function is ON.
 Transmits a 1750 Hz tone burst when pushed and held during transmission.
 •Tone frequencies or tone burst can be set in initial set mode (p. 49).

F-3

◇ S1 FUNCTIONS

S1 (MENU)	MW (F-1)	MPW (F-2)	MPR (F-3)
----------------------------	---------------------------	----------------------------	----------------------------

MW **MEMORY WRITE (p. 40)**
 Stores the displayed frequency and operating mode into the displayed memory channel.

F-1

MPW **MEMO PAD WRITE (p. 42)**
 Stores the displayed frequency and operating mode into a memo pad.

F-2

MPR **MEMO PAD READ (p. 42)**
 Calls up a memo pad.

F-3

◇ S2 FUNCTIONS

S2 (MENU)	SON (F-1)	PRI (F-2)	V/M (F-3)
SEL (in memory mode)			

SON **SCAN (p. 44)**
 Starts and stops the scan function.

F-1

PRI **PRIORITY WATCH (p. 44)**
 Starts and stops priority watch.

F-2

SEL **SELECT SCAN (p. 44)**
 Toggles the select setting ON and OFF for the selected memory channel.

F-2

V/M **VFO/MEMORY (p. 44)**
 Toggles between VFO and memory modes.

F-3

◇ S3 FUNCTIONS

S3 (MENU)	7 (F-1)	50 (F-2)	144 (F-3)
----------------------------	--------------------------	---------------------------	----------------------------

QUICK BAND CHANGE FUNCTION (p. 19)
 This item provides access to the band stacking register. By default the 7, 50 and 144 MHz bands are displayed. Push [F-1] to [F-3] for 2 sec. to select a new band if desired.
 •A mode is memorized along with the frequency for each band.

◇ S4 FUNCTIONS (may be optional for some ver.)

S4 (MENU)	ANF (F-1)	NR (F-2)	NRL (F-3)
----------------------------	----------------------------	---------------------------	----------------------------

ANF **AUTOMATIC NOTCH FILTER (p. 24)**
 This function automatically attenuates beat tones, tuning signals, etc., even if they are moving.

F-1

NR **NOISE REDUCTION (p. 24)**
 This function reduces noise components and picks out desired signals which are buried in the noise.

F-2

NRL **NOISE REDUCTION DISPLAY (p. 24)**
 This displays the noise reduction level when using the noise reduction function.

F-3

■ Rear and side panels

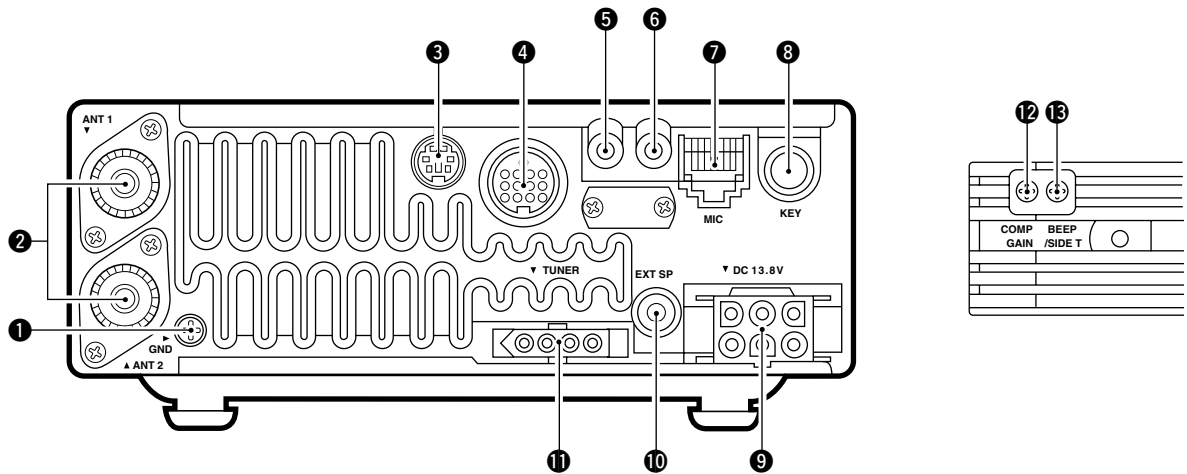

1 GROUND TERMINAL [GND] (p. 9)

Connect this terminal to a ground to prevent electrical shocks, TVI, BCI and other problems.

2 ANTENNA CONNECTORS [ANT 1], [ANT 2] (p. 11)

Accept a 50 Ω antenna with an PL-259 type plug.

- [ANT 1] is for connection to an HF/50 MHz antenna.
- [ANT 2] is for connection to 144 MHz antenna.
- These connectors are switched above or below 60 MHz.

3 DATA JACK [DATA] (p. 12)

6-pin min DIN jack to connect a TNC, etc. for packet operation.

4 ACCESSORY SOCKET [ACC] (p. 6)

Enables connection to external equipment such as a TNC for data communications, a linear amplifier or an automatic antenna selector/tuner, etc.

- See page at right for socket information.

5 RTTY JACK [RTTY] (p. 35)

Connects an external terminal unit for RTTY (FSK) operation.

- The keying polarity and mark/shift frequencies can be selected in quick set mode (p. 48).

6 CI-V REMOTE CONTROL JACK [REMOTE] (p. 45)

Designed for use with a personal computer for remote operation of transceiver functions.

7 MICROPHONE CONNECTOR [MIC] (p. 11)

Accepts the supplied microphone (connected in parallel with the front panel's [MIC] connector).

- See pgs. 1 and 2 for microphone notes.
- See p. 8 for microphone connector information.

8 ELECTRONIC KEYER JACK [KEY] (p. 33)

Accepts a paddle to activate the internal electronic keyer.

- Selection between the internal electronic keyer and straight key operation can be made in quick set mode. (p. 49)

When connecting a straight key

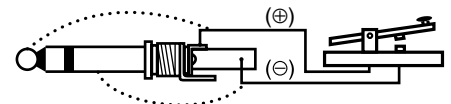

When connecting a paddle

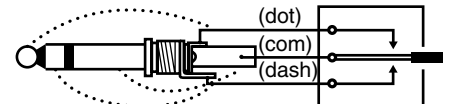

9 DC POWER SOCKET [DC13.8V] (p. 13)

Accepts 13.8 V DC through the supplied DC power cable.

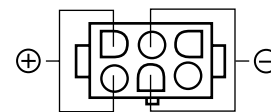

Rear panel view

10 EXTERNAL SPEAKER JACK [EXT SP] (p. 12)

Accepts a 4–16 Ω speaker.

11 TUNER CONTROL SOCKET [TUNER] (p. 12)

Accepts the control cable from an optional AH-3 HF AUTOMATIC ANTENNA TUNER.

12 SPEECH COMPRESSION LEVEL CONTROL [COMP GAIN] (p. 26)

Adjusts the compression level.

- This control is available only when the speech compressor is ON.

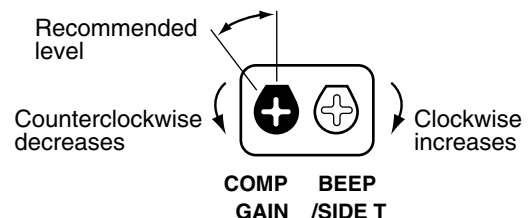

13 BEEP/SIDETONE CONTROL [BEEP/SIDETONE]

Adjusts the beep tone and CW side tone audio levels.

TECHNICAL INFORMATION

• ACC SOCKET

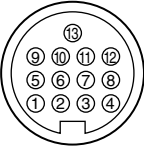
ACC	PIN #	NAME	DESCRIPTION	SPECIFICATIONS	COLOR
 <p>Rear panel view</p>	1	8 V	Regulated 8 V output.	Output voltage : 8 V ±0.3 V Output current : Less than 10 mA	brown
	2	GND	Connects to ground.	—————	red
	3	HSEND	Input/output pin (HF/50 MHz). Goes to ground when transmitting. When grounded, transmits (connected to 8V line thru 2.2 kΩ resistance/144 MHz operation).	Ground level : -0.5 V to 0.8 V Input current : Less than 20 mA (HF/50 MHz bands)	orange
	4	BDT	Data line for the optional AT-180.	—————	yellow
	5	BAND	Band voltage output. (Varies with amateur band)	Output voltage : 0 to 8.0 V	green
	6	ALC	ALC voltage input.	Control voltage : -4 to 0 V Input impedance : More than 10 kΩ	blue
	7	VSEND	Input/output pin (144 MHz). Goes to ground when transmitting. When grounded, transmits (connected to 8V line thru 2.2 kΩ resistance/HF•50 MHz operation).	Ground level : -0.5 V to 0.8 V Input current : Less than 20 mA (144 MHz band)	purple
	8	13.8 V	13.8 V output when power is ON.	Output current : Max. 1 A	gray
	9	TKEY	Key line for the AT-180.	—————	white
	10	FSKK	RTTY keying input. Connected in parallel to the [RTTY] jack.	Ground level : -0.5 to 0.8 V Input current : Less than 10 mA	black
	11	MOD	Modulator input.	Input impedance : 10 kΩ Input level : Approx. 100 mV rms	pink
	12	AF	AF detector output. Fixed, regardless of [AF] position.	Output impedance : 4.7 kΩ Output level : 100 to 350 mV rms	light blue
	13	SQLS	Squelch output. Goes to ground when squelch opens.	SQL open : Less than 0.3 V/5 mA SQL closed : More than 6.0 V/100 μA	light green

• When connecting the ACC conversion cable (OPC-599)

Color refers to the cable strands of the supplied cable.

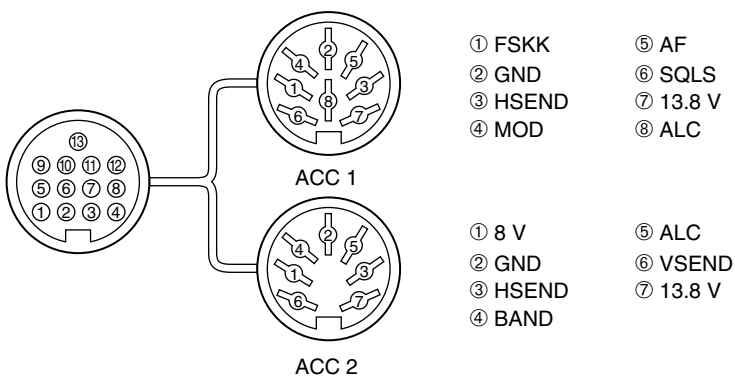

■ Function display

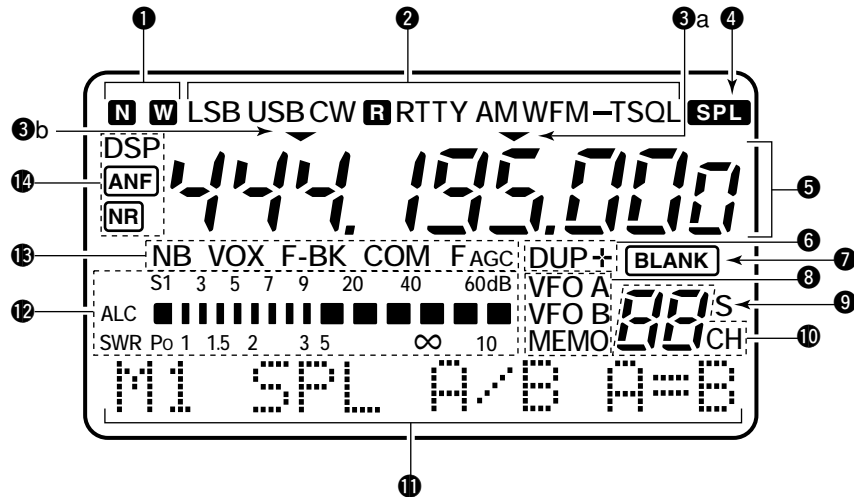

① NARROW/WIDE FILTER INDICATORS

- ➔ “N” appears when selecting AM narrow or FM narrow modes.
- ➔ When installing an optional narrow filter, narrow mode can be selected in CW, RTTY and SSB modes.
 - When the SSB wide filter is installed, “W” appears during wide mode selection.

② MODE INDICATORS

Show the operating mode.

③ PROGRAMMABLE/1 MHz TUNING STEP INDICATORS

- ➔ ③a appears when the programmable tuning step is selected.
- ➔ ③b appears when the 1 MHz tuning step is selected.

④ SPLIT INDICATOR

Shows that the split frequency function is activated.

⑤ FREQUENCY READOUT

- Shows the operating frequency.
- “C” appears in place of the 1 Hz digit when the call channel is selected.

⑥ DUPLEX INDICATORS

- ➔ “DUP+” appears during plus duplex operation.
- ➔ “DUP-” appears during minus duplex operation.

⑦ BLANK INDICATOR

- Shows that the displayed memory channel is not programmed.
- This indicator appears both in VFO and memory modes.

⑧ VFO/MEMORY INDICATORS

VFO A or B appears when VFO mode is selected; MEMO appears when memory mode is selected.

⑨ SELECT INDICATOR

Shows that the displayed memory channel is designated as a select memory channel.

⑩ MEMORY CHANNEL NUMBER READOUT

Shows the selected memory channel number.

⑪ DOT MATRIX INDICATORS

These alphanumeric readouts show a variety of information such as current functions of the “F” keys [F1] to [F3], memory channel names, set mode items, etc. See p. 68 for an overview of these indicators.

⑫ METER READOUTS

- ➔ Functions as an S-meter while receiving.
- ➔ Functions as a power, ALC or SWR meter while transmitting.

Note: The SWR meter does not function in the 144 MHz band.

⑬ FUNCTION INDICATORS

- ➔ “NB” appears when the noise blanker is activated.
- ➔ “VOX” appears when the VOX function is selected.
- ➔ “F-BK” appears when full break-in operation is selected and only “BK” appears when semi break-in operation is selected.
- ➔ “COM” appears when the speech compressor is activated.
- ➔ “FAGC” appears when the fast AGC function is selected.

⑭ DSP INDICATORS

Appear when the optional DSP unit is installed and activated.

■ Microphone (HM-103)

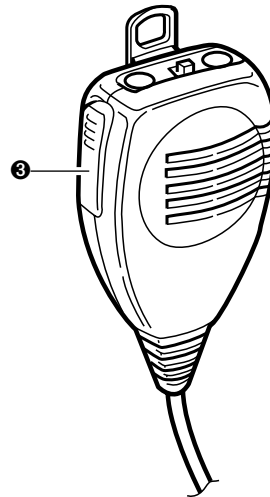
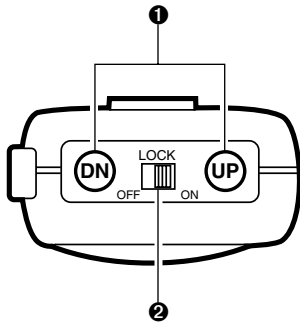

① UP/DOWN SWITCHES [UP]/[DN]

Change the operating frequency.

- Push and hold to change the frequency continuously.
- Tuning step is 50 Hz when no TS indicator appears.

② LOCK SWITCH [LOCK]

Locks the [UP]/[DN] switches.

③ PTT SWITCH [PTT]

Push and hold to transmit; release to receive.

TECHNICAL INFORMATION

• MICROPHONE CONNECTOR

- ① +8 V DC output
- ② Frequency up/down
- ③ AF output
- ④ PTT
- ⑤ GND (microphone ground)
- ⑥ Microphone input
- ⑦ GND
- ⑧ Squelch switch

PIN NO.	FUNCTION	DESCRIPTION
1	+8 V DC output	Max. 10 mA
2	Frequency up	Ground
	Frequency down	Ground through 470 Ω
8	Squelch open	"LOW" level
	Squelch closed	"HIGH" level

Rear panel view

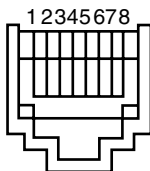

Caution: DO NOT short pin 1 to ground as this can damage the internal 8 V regulator.

• HM-103 SCHEMATIC DIAGRAM

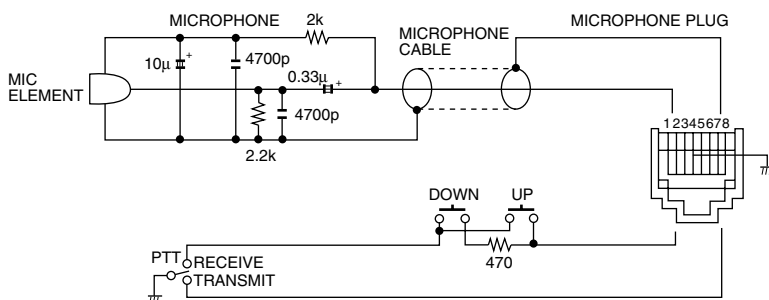

■ Unpacking

After unpacking, immediately report any damage to the delivering carrier or dealer. Keep the shipping cartons.

For a description and a diagram of accessory equipment included with the IC-706MKIIG, see UNPACKING on p. ii of this manual.

■ Grounding

To prevent electrical shock, television interference (TVI), broadcast interference (BCI) and other problems, ground the transceiver through the GROUND terminal on the rear panel.

For best results, connect a heavy gauge wire or strap to a long earth-sunk copper rod. Make the distance between the GROUND terminal and ground as short as possible.

⚠ WARNING: NEVER connect the [GND] terminal to a gas or electric pipe, since the connection could cause an explosion or electric shock.

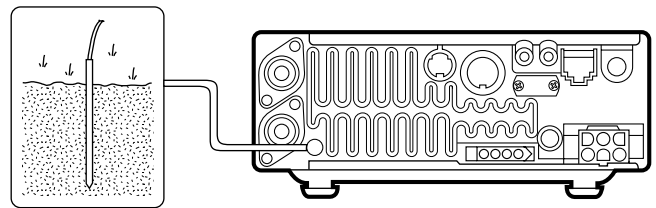

■ Antenna

Select antenna(s), such as a well-matched 50 Ω antenna, and feedline. The transmission line should be a coaxial cable. 1.5 : 1 or better of Voltage Standing Wave Ratio (VSWR) is recommended for your required band. Of course, the transmission line should be a coaxial cable.

ANTENNA SWR
Each antenna is tuned for a specified frequency range and SWR may be increased out-of-range. When the SWR is higher than approx. 2.0:1, the transceiver's power drops to protect the final transistors. In this case, an optional antenna tuner is useful to match the transceiver and antenna. Low SWR allows full power for transmitting even when using the antenna tuner. The IC-706MKIIG has an SWR meter to monitor the antenna SWR continuously.

CAUTION: Protect your transceiver from lightning using a lightning arrestor.

PL-259 CONNECTOR INSTALLATION EXAMPLE

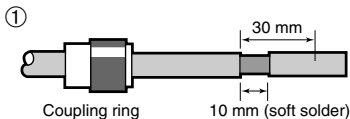

Slide the coupling ring down. Strip the cable jacket and soft solder.

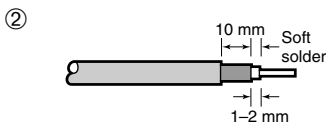

Strip the cable as shown at left. Soft solder the center conductor.

(10 mm ≈ 3/8 in)



Slide the connector body on and solder it.

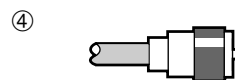

Screw the coupling ring onto the connector body.

■ Installation

◇ Single body mounting

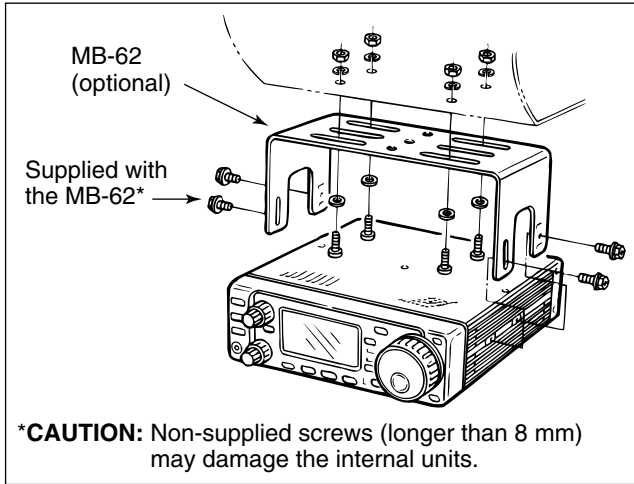

◇ Stand

To raise the stand:

With the transceiver upside down, pull the stand towards the rear panel and then upwards, as illustrated below.

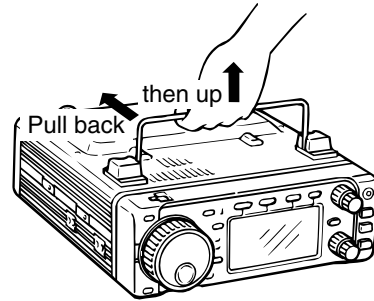

◇ Front panel separation

- ① While pulling the panel release button towards you, slide the front panel to the right (fig. 1).
- ② Attach the optional OPC-581 to the main body and tighten the supplied screw as in fig. 2.
- ③ Attach the other end of the OPC-581 to the detached front panel as in fig. 3.

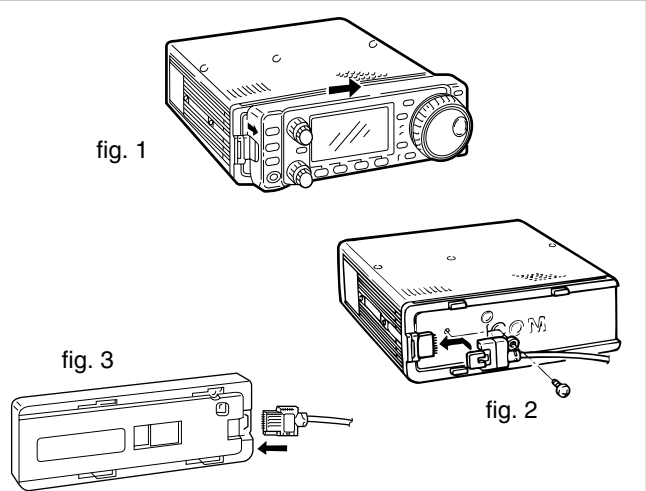

◇ Front panel mounting

- ① Attach the MB-63 to a flat surface using the two supplied screws (fig. 1).
- ② Fix the detached front panel to the MB-63 as illustrated in fig. 2.

Be careful of the orientation of the MB-63, otherwise, the front panel may become attached in the opposite direction.

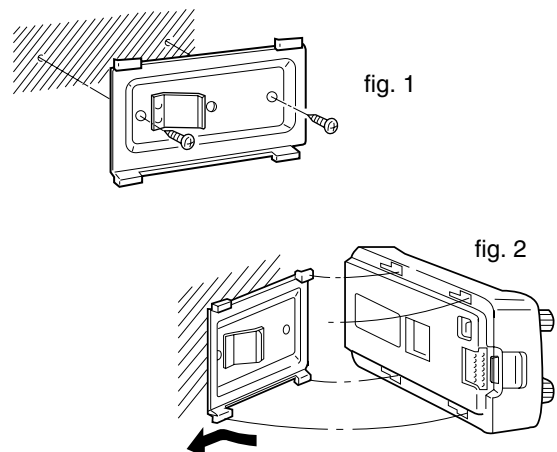

■ Required connections

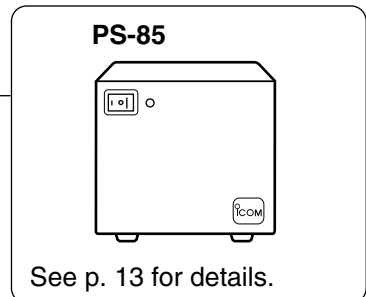
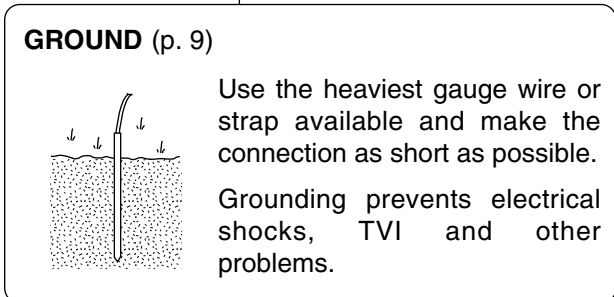
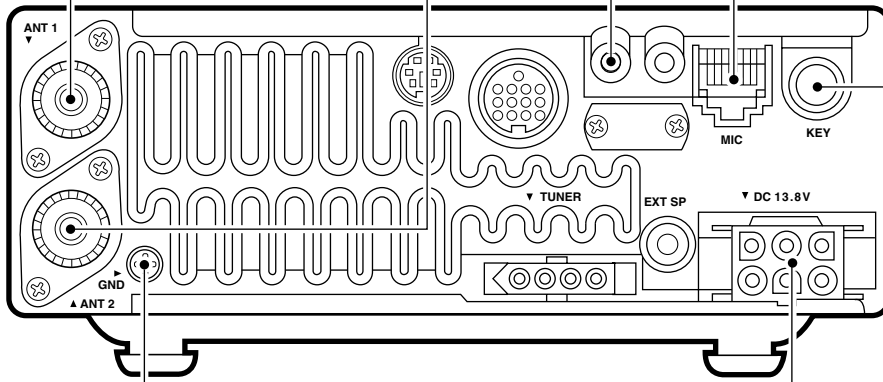
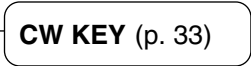
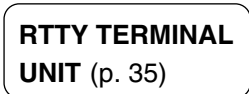
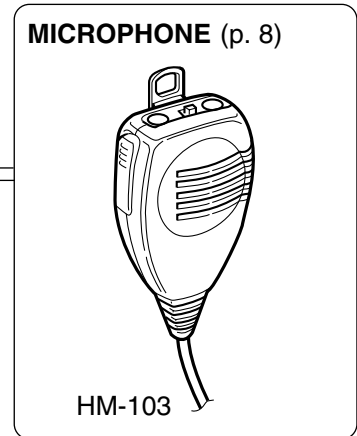
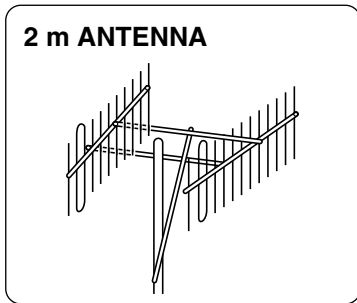
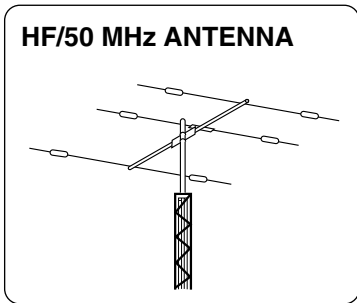
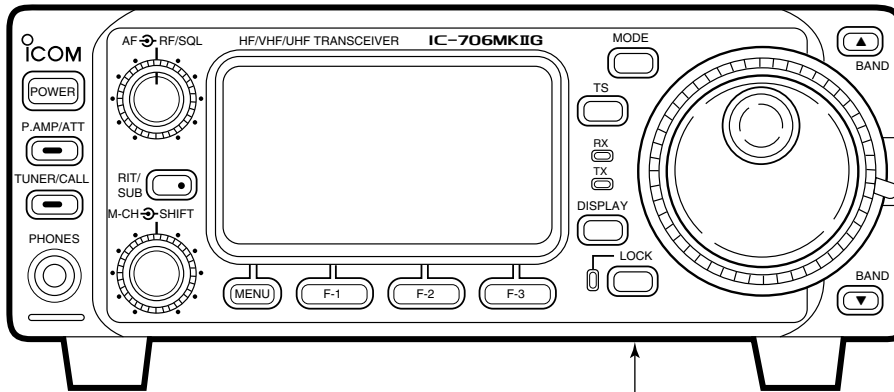

Advanced connections

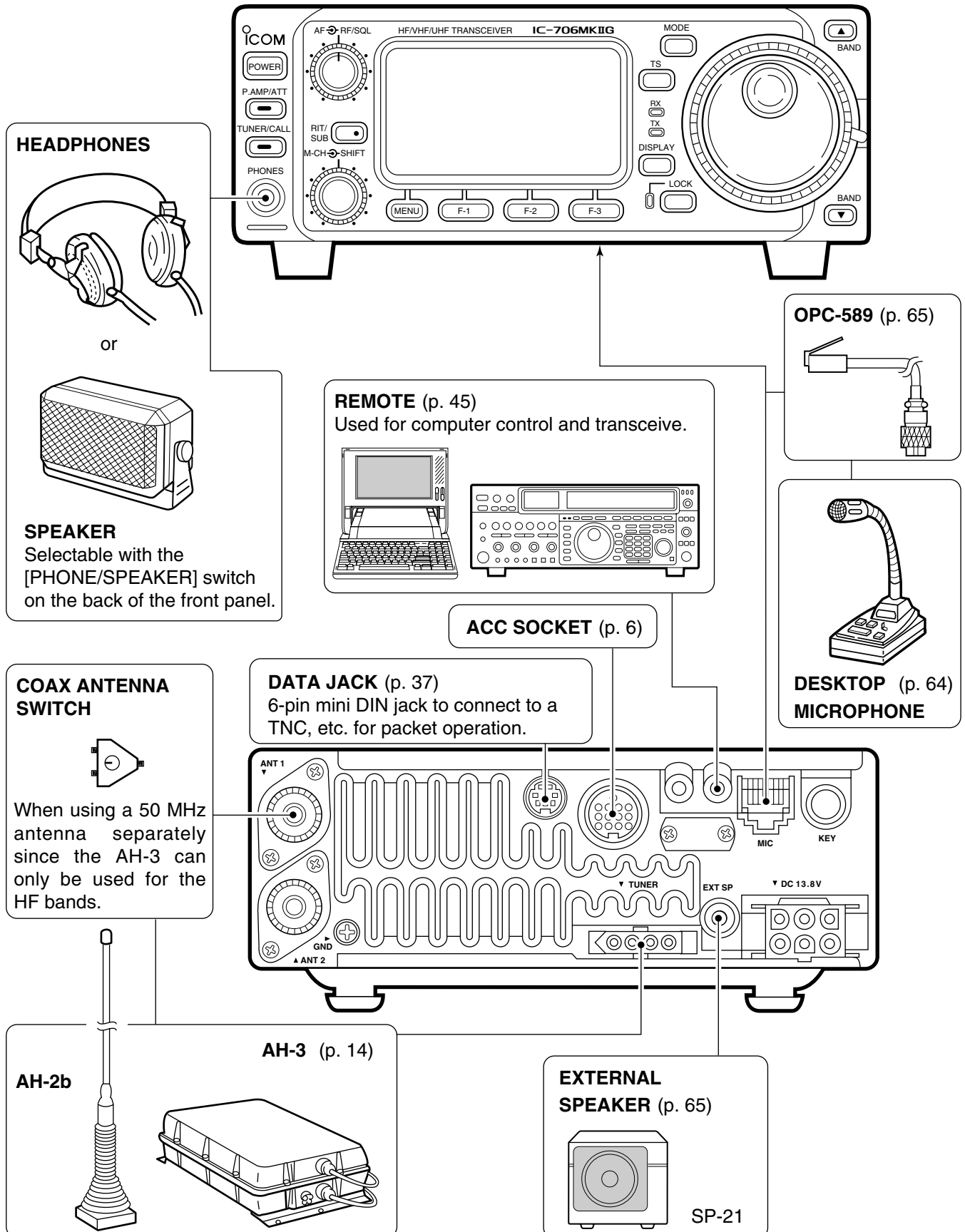

■ Power supply connections

Use the optional PS-125 / PS-85 DC POWER SUPPLY when operating the IC-706MKIIG with AC power. Refer to the diagram below for connection.

CAUTION: Before connecting the DC power cable, check the following important items. Make sure:

- The [POWER] switch is OFF.
- Output voltage of the power source is 12–15 V when you use a non-Icom power supply.
- DC power cable polarity is correct.
Red : positive (+) terminal
Black : negative (–) terminal

CONNECTING THE PS-125 / PS-85 DC POWER SUPPLY

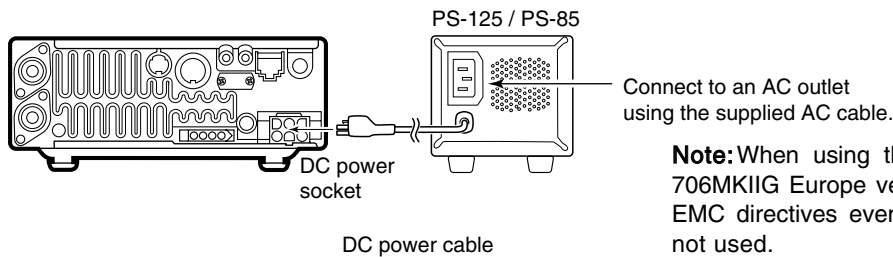

Note: When using the PS-125, the IC-706MKIIG Europe version complies with EMC directives even if the OPC-639 is not used.

CONNECTING A NON-ICOM DC POWER SUPPLY

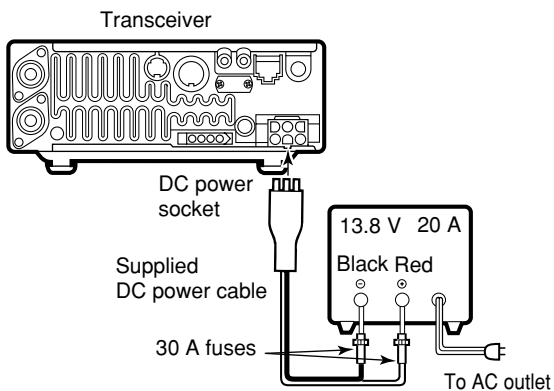

CONNECTING A NON-ICOM DC POWER SUPPLY (For Europe versions)

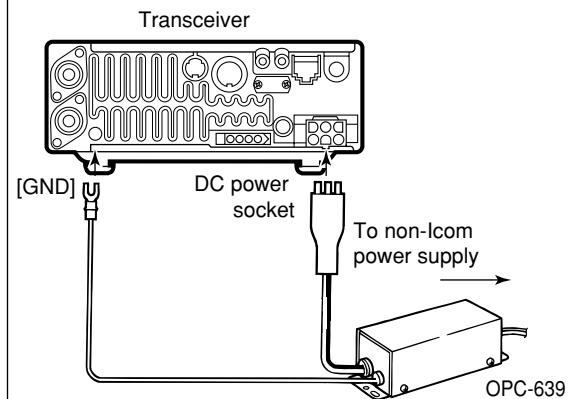

CONNECTING A VEHICLE BATTERY

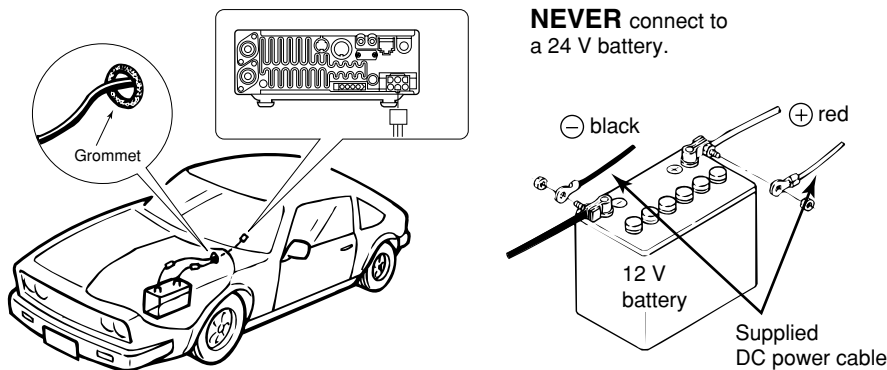

NEVER connect to a 24 V battery.

Note: Use terminals for the cable connections.

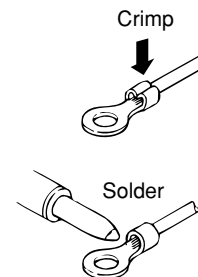

External antenna tuners and linear amplifier

CONNECTING THE AH-4

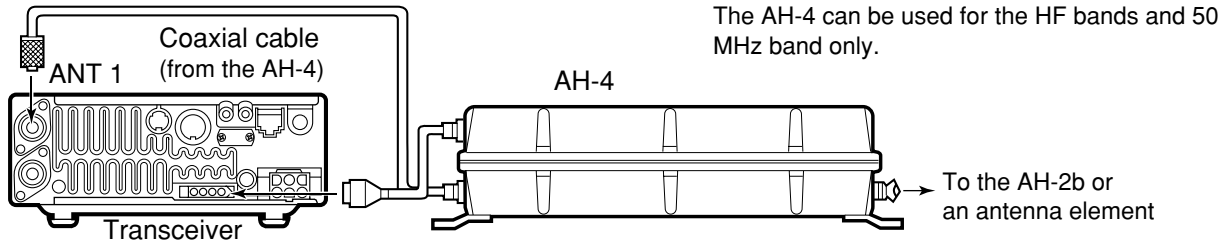

CONNECTING THE AT-180

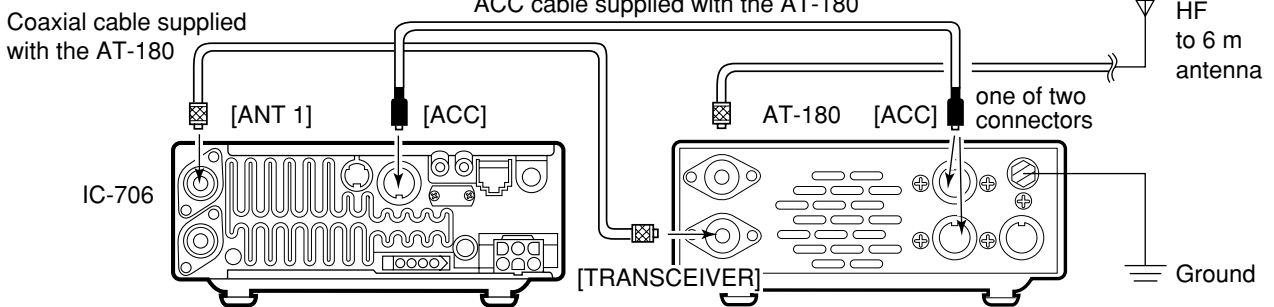

Note:

- Turn the IC-706MKIIG's power OFF when connecting the AT-180, otherwise, the CPU may malfunction and the AT-180 may not function properly.
- The OPC-742 is required when using **both** the AT-180 and a 2 m linear amplifier.

Do not connect [ANT 2] to the AT-180. When using an HF to 2 m wide antenna, use a duplexer between the AT-180 and antenna since 2 m signals do not pass through the AT-180.

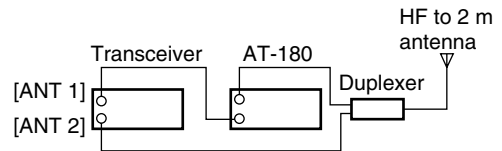

CONNECTING THE IC-PW1

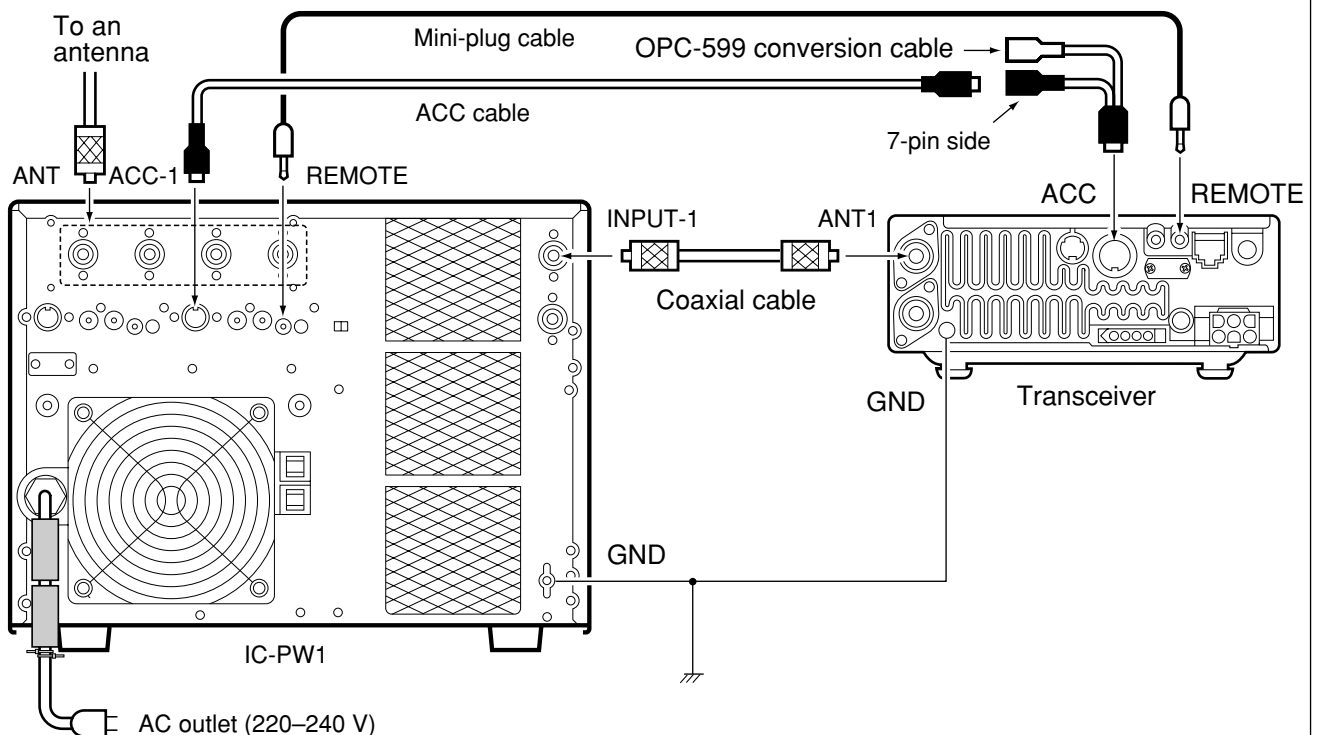

3

FREQUENCY SETTING

■ When first applying power (CPU resetting)

Before first applying power, make sure all connections required for your system are complete by referring to section 2. Then, reset the transceiver using the following procedure.

Note: Resetting *clears* all programmed contents in memory channels and returns all initial set mode and quick set mode contents to their default values.

- ① Make sure the transceiver power is OFF.
- ② While pushing [▲] and [▼], push [POWER] to turn power ON.
 - The internal CPU is reset.
 - The transceiver displays as shown at right when resetting is complete.

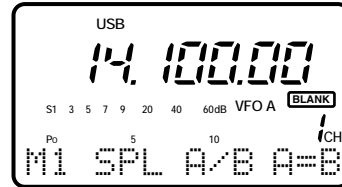
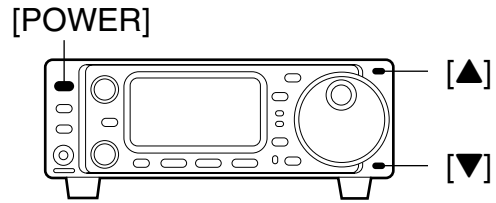

The transceiver displays its initial frequency and mode.

◇ M1 display selection

If you can't figure out how to return to the M1 display: While pushing [MENU], turn power ON.

■ Initial settings

After resetting the transceiver, set controls and switches as shown in the diagram below.

CCW: counterclockwise

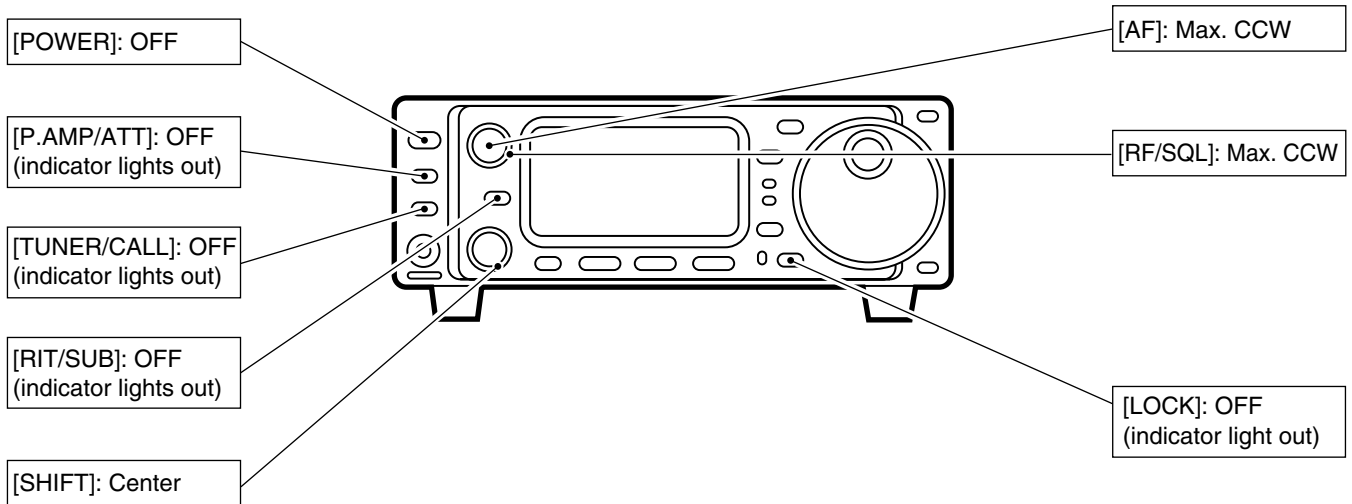

Turn power ON, then check the display. If any of the following indicators appear, turn them OFF as follows:

- Tuning step indicators, ▼, (SSB, CW or RTTY): Push [TS].
- MHz tuning step indicator, ▼, (FM, WFM or AM): Push [TS].
- 1 Hz frequency readout (SSB, CW or RTTY): Push and hold [TS].
- Memory mode indicator, MEMO: Use [(F-3)U/M] in the M2 display (p. 68).
- Split indicator, SPL: Use [(F-1)SPL] in the M1 display (p. 68).

VFO description

VFO is an abbreviation of Variable Frequency Oscillator, and traditionally refers to an oscillator. The IC-706MKIIG's VFO can store a frequency and an operating mode.

You can call up a desired frequency to a VFO with the memo pad-read switch (p. 42) or with the memory transfer switch (p. 42). You can also change the frequency with the main dial and select an operating mode with the [MODE] switch or call up previously accessed frequency and modes with the band stacking register (p. 19).

The IC-706MKIIG has two VFOs, specially suited for split frequency operation. The VFOs are called VFO A and VFO B. You can use the desired VFO to call up a

frequency and operating mode for operation.

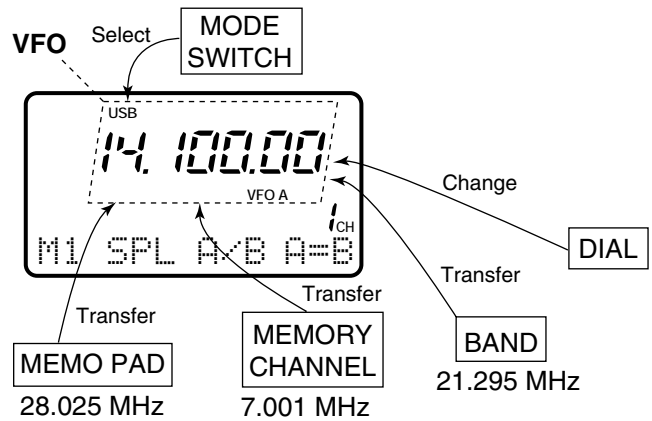

The differences between VFO and memory mode

VFO MODE

Each VFO shows a frequency and operating mode. If the frequency or operating mode is changed, the VFO automatically memorizes the new frequency or operating mode.

When the VFO is selected from another VFO or memory mode, the last-used frequency and operating mode for that VFO appear.

[EXAMPLE]

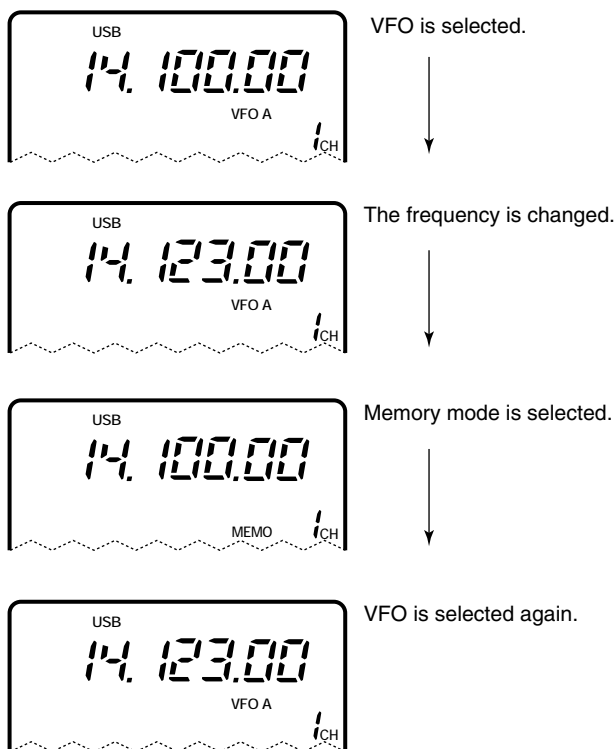

Changed frequency (14.123 MHz) appears.

MEMORY MODE (pgs. 39–42)

Each memory channel shows a frequency and operating mode like a VFO. Even if the frequency or mode is changed, the memory channel does not memorize the new frequency or memory mode.

When a memory channel is selected from another memory channel or VFO mode, the memorized frequency and operating mode appear.

[EXAMPLE]

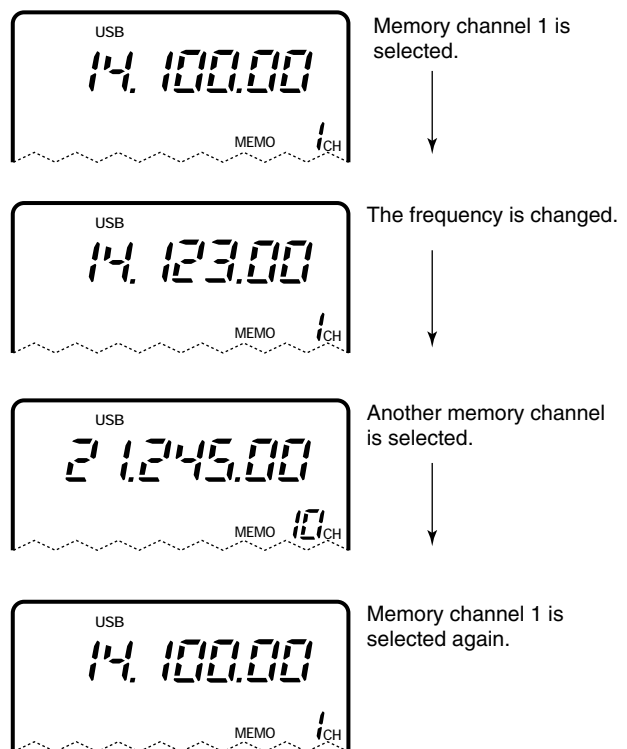

Changed frequency (14.123 MHz) does not appear and memorised frequency (14.100 MHz) appears instead.

■ Frequency setting

•Band selection

All HF ham bands, the 50 MHz band, the 144 MHz band and a general coverage receiver band are included in the IC-706MKIIG.

Push [(▲)BAND]/[(▼)BAND] to select the desired band.

•Pushing [(▲)BAND]/[(▼)BAND] continuously scrolls through the available bands.

Note: The band stacking register can also be used to select bands. Refer to p. 19.

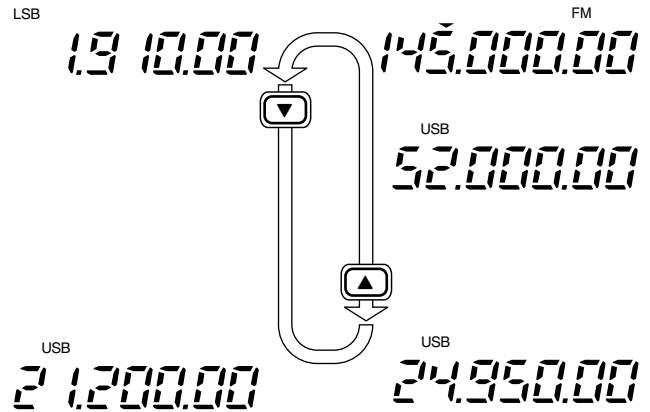

•Programmable tuning steps

Programmable tuning steps are available to suit your operating requirements.

These tuning steps are:

- Independently selectable for each mode
- Selectable from 0.01 (FM/WFM/AM only), 0.1, 1, 5, 9, 10, 12.5, 15, 20 and 100 kHz

- ① Push [TS] one or more times until the programmable tuning step indicator, “▼,” appears above the 1 kHz digit.
 - Rotating the main dial changes the frequency according to the set tuning step.
- ② Push [TS] for 2 sec. while the programmable tuning step indicator appears to enter the tuning step selection mode.
 - Rotate DIAL appears.
- ③ Rotate the main dial to set the desired tuning step.
 - Change the mode and select tuning steps for other modes, if desired.
- ④ Push [TS] to exit the tuning step selection mode.
- ⑤ Rotate the main dial to change the frequency according to the set tuning step.

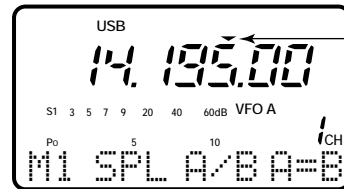

Programmable tuning step indicator

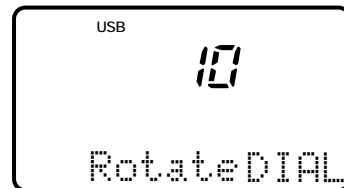

10 kHz tuning step is selected for USB operation.

•1 Hz and 10 Hz tuning steps

When neither the quick tuning step or programmable tuning step, “▼,” appear, rotating the main dial changes the frequency in increments of 1 or 10 Hz. These tuning steps are only available in SSB, CW and RTTY modes.

- ① Select SSB, CW or RTTY mode if necessary.
- ② Push [TS] for 2 sec. to toggle between the 1 and 10 Hz step settings.
 - When the 1 Hz step is selected, the 1 Hz digit appears in the frequency indication; when the 10 Hz step is selected, the 1 Hz digit disappears from the frequency indication.

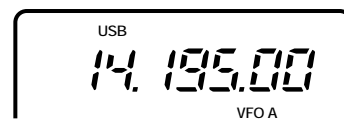

Rotating the main dial changes the frequency in 10 Hz steps.

Push [TS] for 2 sec.

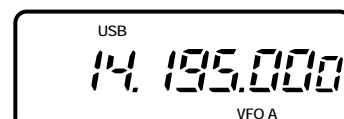

Rotating the main dial changes the frequency in 1 Hz steps.

•1 MHz quick tuning step

The quick tuning step function allows you to change the frequency in 1 MHz steps when rotating the main dial. This function is only available in FM, WFM and AM modes.

- ① Select FM, WFM or AM mode if necessary.
- ② Push [TS] momentarily to toggle between the 1 MHz tuning step and the programmable tuning step.
 - “▼” appears above the 1 MHz indicator when the 1 MHz tuning step is selected.
 - When the 1 MHz tuning step is selected, slow rotation of the main dial changes the frequency in 1 MHz steps and fast rotation of the main dial changes the frequency in 5 MHz steps.

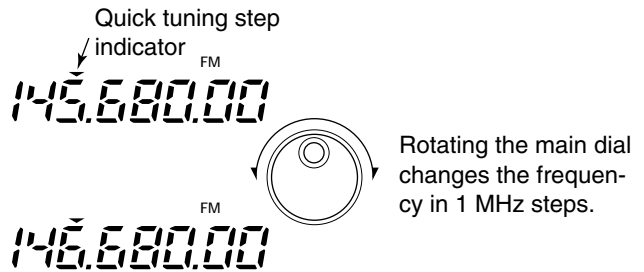

[TS] SWITCH FLOW CHART

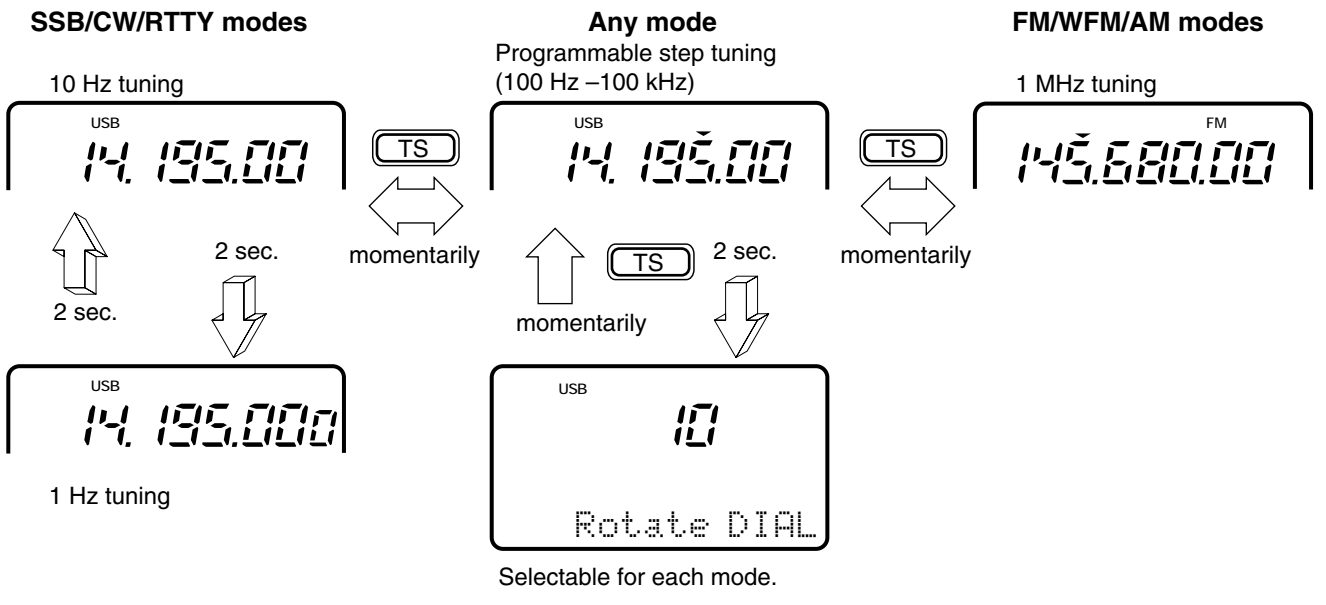

•Sub dial function

The sub dial function allows you to change the operating frequency using the [M-CH] control. This gives you more control in tuning since the [M-CH] knob is detented—each click changes the frequency according to the set tuning step. This function is always available in FM, WFM and AM modes. However, in SSB, CW and RTTY modes, the set mode item “Sub dial function,” must be set to “FrEq.”

- ① Push [RIT/SUB] to turn the sub dial function ON.
 - The [SUB] indicator lights green; if it lights red, the RIT function is activated—sub dial function must be set in initial set mode in this case.
- ② Rotate [M-CH] to change the operating frequency according to the set tuning steps.
- ③ Push [RIT/SUB] again to turn the function OFF.
 - The [SUB] indicator turns off.

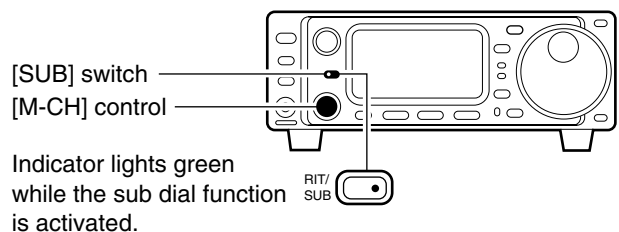

•Quick band change function

The quick band change function automatically stores the last frequency and mode used for each band in a band stacking register. This is convenient for contest operation, etc. The tables below show the quick band change default settings for each band.

- ① Select 53.
 - Push [DISPLAY] when M or G is displayed.
 - Push [MENU] twice to select 53.
- ② Push [F-1]–[F-3] to select a band stacking register.
 - The default settings for [F-1]–[F-3] are 7, 144 and 430 MHz bands, respectively.
- ③ To change the settings for [F-1]–[F-3] from their defaults, push [F-1]–[F-3] for 1 sec. one or more times to until the desired band appears in the display above the corresponding switch.
 - The last-used frequency and mode for the selected band are displayed.

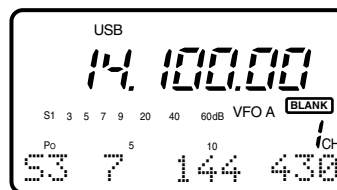

Display shows the default bands for the quick band change function.

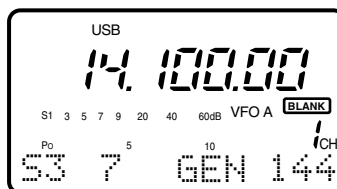

Display shows [F-2] has been changed from its default of the 50 MHz band to the general receiver band.

BAND	FREQUENCY	MODE
1.9 MHz	1.91000 MHz**	CW
3.5 MHz	3.56000 MHz	LSB
7 MHz	7.06000 MHz	LSB
10 MHz	10.13000 MHz	CW
14 MHz	14.10000 MHz	USB
General*	15.10000 MHz	USB

*General refers to the general coverage receiver (GEN in the display) and the range varies according to version.

** 1.83000 MHz for Italy version (#10,#20).

BAND	FREQUENCY	MODE
18 MHz	18.15000 MHz	USB
21 MHz	21.30000 MHz	USB
24 MHz	24.95000 MHz	USB
28 MHz	28.60000 MHz	USB
50 MHz	50.10000 MHz	USB
144 MHz	145.00000 MHz	FM
430 MHz	433.00000 MHz	FM

■ Mode selection

The following modes are available in the IC-706MKIIG:

SSB (LSB/USB), CW, CW-**□** (CW reverse), FM, WFM (receive only), AM, RTTY and **□**RTTY (RTTY reverse).

To select the desired mode of operation push [MODE] one or more times, then push [MODE] for 2 sec., if necessary. See the diagram at right for the order of selection.

•The selected mode is indicated in the function display.

Note: If a desired mode cannot be selected, it may be hidden using Initial Set mode (p. 50).

OPERATING MODE SELECTION

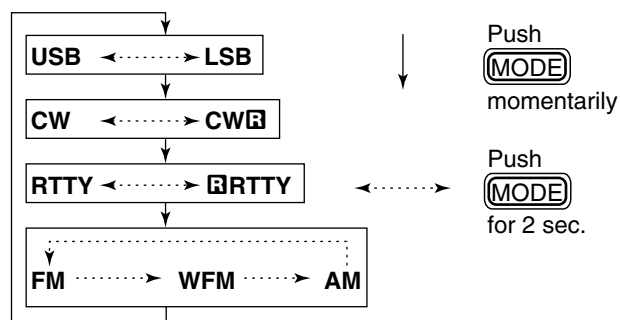

■ Functions for receive

◇ IF shift function

The IF shift function electronically changes the pass-band frequency of the IF (intermediate frequency) and cuts out higher or lower frequency components of the IF to reject interference. The function shifts the IF frequency up to ± 1.2 kHz in 15 Hz steps in SSB/CW/RTTY modes and up to ± 250 Hz in 3 Hz steps in CW-**N**/RTTY-**N** modes. The IF shift is not available in FM and AM modes.

- ① Adjust the [SHIFT] control for a minimum interference signal level.
 - The audio tone may be changed while the IF shift is in use.
- ② Set the shift control to its center position when there is no interference.

•Graphic display

The IF shift is displayed graphically (for about 1 sec.) each time the shift control is rotated.

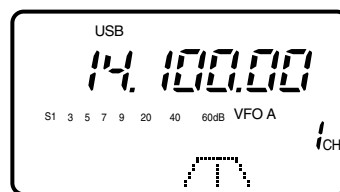
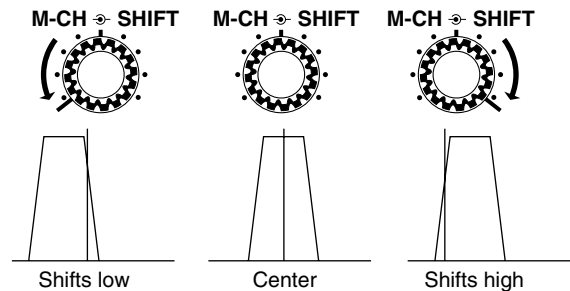

◇ RIT function

The RIT (Receive Incremental Tuning) function compensates for off-frequencies of communicating stations. The function shifts the receive frequency up to ± 9.99 kHz in 10 Hz steps without moving the transmit frequency. The [SUB/RIT] switch in Initial Set Mode must be set to RIT mode in advance (p. 51).

- ① Push [RIT].
 - The [RIT] indicator lights red.
- ② Rotate the [M-CH] control to cancel the off-frequencies.
 - The transmit frequency is not shifted.
- ③ To cancel the RIT function, push [RIT] again.
 - The [RIT] switch indicator goes out.

•Calculate function

The shift frequency of the RIT function can be added/subtracted to the displayed frequency.

While the RIT indicator is lit, push and hold [RIT] for 2 sec.

Note: The RIT function is not available in FM, WFM or AM modes regardless of the Initial Set mode setting (p. 51).

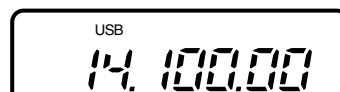
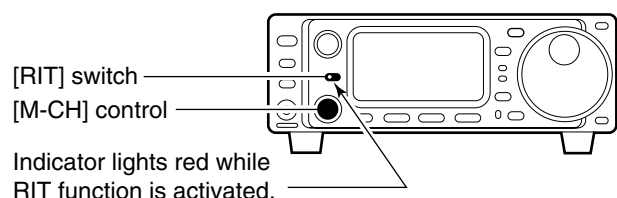

 Push for 2 sec.

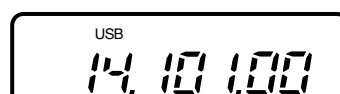

◆ Noise blanker

The *noise blanker* reduces pulse-type noise such as that generated by automobile ignition systems. This function is not effective for FM modes or for non pulse-type noise. If you don't want to use the noise blanker for AM communications, the "AM noise blanker" item in Initial Set mode must be turned OFF (ON is the default setting—p. 53).

- ① Select M3.
 - Push [DISPLAY] 1 or 2 times when S or G is displayed, until M is displayed.

- Push [MENU] one or more times to select M3.
- ② Push [(F-2)NB] to toggle the noise blanker ON and OFF.
 - "NB" appears when the noise blanker is turned ON.

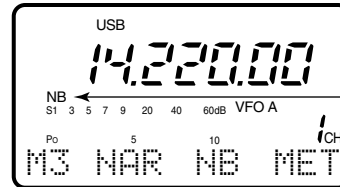

Appears when the noise blanker is turned ON.

◆ AGC time constant

The *AGC* (Automatic Gain Control) controls receiver gain to produce a constant audio output level even when the received signal strength is varied by fading, etc. Use AGC slow for normal phone operation; AGC fast for receiving data and searching for signals. AGC time constant cannot be changed in FM mode.

- ① Select M4.
 - Push [DISPLAY] 1 or 2 times when S or G is displayed.
 - Push [MENU] one or more times to select M4.
- ② Push [(F-3)AGC] to toggle the AGC time constant between fast and slow.
 - "FAGC" appears when the fast time constant is selected.



Appears when AGC fast is selected.

◆ Preamp and attenuator

The *preamp* amplifies received signals in the front end circuit to improve the S/N ratio and sensitivity. Turn this function ON when receiving weak signals.

The *attenuator* prevents desired signals from distorting when very strong signals are near the desired frequency or when very strong electric fields, such as from broadcasting stations, are near your location.

Push [P.AMP/ATT] momentarily to turn the preamp ON and OFF; push and hold to turn the attenuator ON.

- Lights green when the preamp is ON; lights red when the 20 dB attenuator is ON.
- Only one of these functions can be activated at a time.



Lights green while the preamp is activated; lights red while the attenuator is activated.

◆ Peak meter hold

INITIAL SET MODE

The peak meter hold function freezes the highest displayed bar segment in any meter function for about 0.5 sec. so that you can more easily read the meter. This function can be turned ON and OFF in initial set mode (see p. 51).

[EXAMPLE]:

S1 3 5 7 9 20 40 60dB Initial reception of a signal results in an S-meter reading of 40 dB.

S1 3 5 7 9 20 40 60dB The highest indicated bar remains displayed for about 0.5 sec. even when the signal strength decreases.

◇ RF gain and squelch

The IC-706MKIIG uses the same control, [RF/SQL], to adjust one of either the RF gain or the squelch. [RF/SQL] adjusts either the RF gain or the squelch depending on the operating mode selected and the condition of the RF gain item in initial set mode (p. 51; also see the table at right).

The *RF (Radio Frequency) gain* is used to adjust the receiver gain.

- This control should be set to the 11 o'clock position for normal use.
- Shallow rotation moves the S-meter to the right indicating the signal strength which can be received.

The *SQUELCH* removes noise output from the speaker (closed condition) when no signal is received. The squelch is particularly effective for FM. It is also available for the other modes.

- When operating in FM, first rotate the control fully counterclockwise. Then, rotate the control clockwise to the point where the noise just disappears. This is the best position. The squelch does not open for weak signals when it is set too deep.
- A segment appears in the S-meter to indicate the S-meter squelch level.

Ⓢ [RF/SQL] control priority

Initial set mode setting	USB, LSB, CW, RTTY	AM, FM, WFM
SQL * ¹	SQL	SQL
AUTO	RF GAIN	SQL
RF • SQL * ²	RF/SQL	RF/SQL

*¹Default; *²Default for USA version.

Note: The recommended position for RF gain is the 11 o'clock position since this sets RF gain to the max.

When set to AUTO, SQL is active in FM/WFM/AM; RF is active in SSB/CW/RTTY.

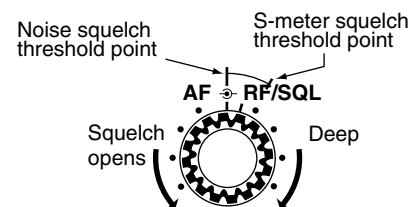
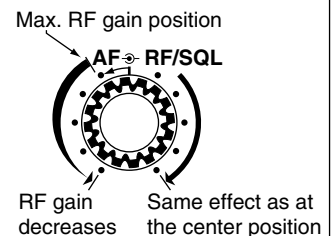

◇ Simple band scope

This function allows you to visually “sweep” an area surrounding the set frequency for other signals. Detected signals are indicated graphically in the dot matrix section of the display.

- ① Set a mode and frequency.
- ② Select G1.
 - Push [DISPLAY] 1 or 2 times if M or S appears.
 - Push [MENU] one or more times to select G1.
- ③ Push [F-1] one or more times to select the desired steps.
 - Each dot corresponds to a step for the indicated frequency.
 - 0.5, 1, 2, 5, 10, 20 and 100 kHz can be set for the scope step.
- ④ Push [F-3] to start the sweep.
 - “_____” (below SUP) flashes while sweeping.
 - The receive audio is muted while sweeping.
- ⑤ Rotate the main dial if you want to monitor the displayed signals.
 - The sweep marker indicates the location of the displayed frequency in the sweep readout.
 - If the displayed frequency is outside of the sweep readout (determined by the sweep width), the sweep marker flashes.
- ⑥ Push [F-2] to return the frequency to the start of a sweep.
 - The sweep marker moves back to the center position.

Note: Use the attenuator or turn OFF the preamp when using the band scope on a band containing a lot of noise.

1k _____ SUP

2k _____ SUP

Select sweep width ([F-1])

2k [dotted area] SUP

Start sweep ([F-3])

2k [dotted area] SUP
↑ sweep marker

Sweep is finished ([F-3] again)

2k [dotted area] SUP

Move sweep marker (main dial)

2k [dotted area] SUP

Returns to previous frequency ([F-2])

◇ Optional filter selection

Two optional filters can be installed in the IC-706MKIIG.

Narrow filters help reject interference from adjacent signals and obtain good selectivity.

Wide filters provide improved audio for SSB operation when no interfering signals are present.

Consult the table below to select a filter most suitable for your operating needs.

Narrow filters for AM/FM modes are standard.

FILTER PRESETTING:

After you install a filter (see p. 60 for installation), you must specify the installed filter in initial set mode (item 19 "OPT. FIL 1" or item 20 "OPT. FIL 2"; see p. 51).

FILTER ON/OFF:

- ① Select M3.
 - Push [DISPLAY] 1 or 2 times if G or S appears.
 - Push [MENU] one or more times to select M3.
- ② Push [(F-1)FIL] momentarily to select the narrow filter; for 2 sec. to select the wide filter.
 - **N** appears when the narrow filter is selected; **W** appears when the wide filter is selected.

Note: When selecting the narrow filter, the graphic passband is narrowed (see diagram below).

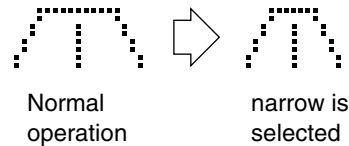

Filter variations

Name	Mode	Band width
FL-101*	CW, RTTY	250 Hz/−6 dB
FL-232*	CW, RTTY	350 Hz/−6 dB
FL-100*	CW, RTTY	500 Hz/−6 dB
FL-223*	SSB, CW, RTTY	1.9 kHz/−6 dB
FL-272	SSB, CW, RTTY	2.4 kHz/−6 dB
FL-103*	SSB, CW, RTTY	2.8 kHz/−6 dB
FL-94	AM, FM	8 kHz/−6 dB

*Optional filter.

Optional filter installation and selection tables

SSB

FIL 1 FIL 2	No optional filter	FL-100	FL-101	FL-103	FL-223	FL-232
No optional filter	W: --- M: FL-272 N: ---	W: --- M: FL-272 N: ---	W: --- M: FL-272 N: ---	W: FL-103 M: FL-272 N: ---	W: --- M: FL-272 N: FL-223	W: --- M: FL-272 N: ---
FL-100	W: --- M: FL-272 N: ---	W: --- M: FL-272 N: ---	W: --- M: FL-272 N: ---	W: FL-103 M: FL-272 N: ---	W: --- M: FL-272 N: FL-223	W: --- M: FL-272 N: ---
FL-101	W: --- M: FL-272 N: ---	W: --- M: FL-272 N: ---	W: --- M: FL-272 N: ---	W: FL-103 M: FL-272 N: ---	W: --- M: FL-272 N: FL-223	W: --- M: FL-272 N: ---
FL-103	W: FL-103 M: FL-272 N: ---	W: FL-103 M: FL-272 N: ---	W: FL-103 M: FL-272 N: ---	W: FL-103 M: FL-272 N: ---	W: FL-103 M: FL-272 N: FL-223	W: FL-103 M: FL-272 N: ---
FL-223	W: --- M: FL-272 N: FL-223	W: --- M: FL-272 N: FL-223	W: --- M: FL-272 N: FL-223	W: FL-103 M: FL-272 N: FL-223	W: --- M: FL-272 N: FL-223	W: --- M: FL-272 N: FL-223
FL-232	W: --- M: FL-272 N: ---	W: --- M: FL-272 N: ---	W: --- M: FL-272 N: ---	W: FL-103 M: FL-272 N: FL-223	W: --- M: FL-272 N: FL-223	W: --- M: FL-272 N: ---

Table key:

- W—wide position
- M—medium (normal) position
- N—Narrow position

CW, RTTY

FIL 1 FIL 2	No optional filter	FL-100	FL-101	FL-103	FL-223	FL-232
No optional filter	W: --- M: FL-272 N: ---	W: --- M: FL-272 N: FL-100	W: --- M: FL-272 N: FL-101	W: FL-103 M: FL-272 N: ---	W: --- M: FL-272 N: FL-223	W: --- M: FL-272 N: FL-232
FL-100	W: --- M: FL-272 N: FL-100	W: --- M: FL-272 N: FL-100	W: FL-272 M: FL-272 N: FL-101	W: FL-103 M: FL-272 N: FL-100	W: FL-272 M: FL-272 N: FL-100	W: FL-272 M: FL-272 N: FL-232
FL-101	W: --- M: FL-272 N: FL-101	W: FL-272 M: FL-100 N: FL-101	W: --- M: FL-272 N: FL-101	W: FL-103 M: FL-272 N: FL-101	W: FL-272 M: FL-272 N: FL-101	W: FL-272 M: FL-272 N: FL-101
FL-103	W: FL-103 M: FL-272 N: ---	W: FL-103 M: FL-272 N: FL-100	W: FL-103 M: FL-272 N: FL-101	W: FL-103 M: FL-272 N: ---	W: FL-103 M: FL-272 N: FL-223	W: FL-103 M: FL-272 N: FL-223
FL-223	W: --- M: FL-272 N: FL-223	W: FL-272 M: FL-223 N: FL-100	W: FL-272 M: FL-223 N: FL-101	W: FL-103 M: FL-272 N: ---	W: --- M: FL-272 N: FL-223	W: FL-272 M: FL-272 N: FL-232
FL-232	W: --- M: FL-272 N: FL-232	W: FL-272 M: FL-100 N: FL-232	W: FL-272 M: FL-232 N: FL-101	W: FL-103 M: FL-272 N: FL-232	W: FL-272 M: FL-272 N: FL-232	W: --- M: FL-272 N: FL-232

AM	Normal	FL-94
	Narrow	FL-272
FM	Normal	FL-23+SFPC455E
	Narrow	FL-94

■ DSP Functions (may require an optional unit depending on version—see p. 61)

◇ ANF (Automatic Notch Filter) function

This function automatically attenuates beat tones, tuning signals, etc., even if they are moving. The automatic notch filter functions in SSB, FM and AM modes.

- ① Select S4 (DSP menu).
 - Push [DISPLAY] 1 or 2 times when M or G is displayed.
 - Push [MENU] one or more times to select S4.
- ② Push [(F-1)ANF] to toggle the automatic notch filter ON and OFF.
 - “DSP” and “ANF” appear when the function is ON.

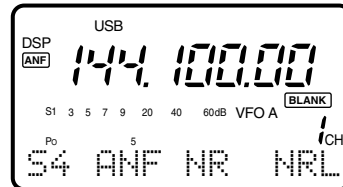

◇ NR (Noise Reduction) function

This function reduces noise components and picks out desired signals which are buried in noise. The received AF signals are converted to digital signals and then the desired signals are separated from the noise. The noise reduction function is available for all operating modes.

- ① Select S4 (DSP menu).
 - Push [DISPLAY] 1 or 2 times when M or G is displayed.
 - Push [MENU] one or more times to select S4.
- ② Push [(F-2)NR] to toggle the noise reduction function ON and OFF.
 - “DSP” and “NR” appear when the function is ON.
- ③ Push [(F-3)NRL] to toggle the noise reduction level indication ON and OFF.
- ④ Rotate the [M-CH] control to set the noise reduction level.
 - Set the control for maximum readability. Deep rotation results in audio signal masking or distortion.

☞ **NOTE:** Pushing [(F-3)NRL] automatically turns the noise reduction function ON, however, the transceiver maintains the ON/OFF condition when pushing [(F-2)NR].

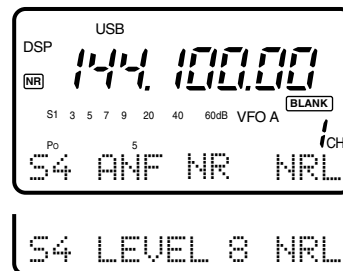

■ Functions for transmit

◇ Output power and mic gain

•Setting output power

- ① Push [DISPLAY] for 2 sec. to select quick set mode.
- ② Push [MENU] one or more times to select Q1 RF POWER.
- ③ Rotate the main dial to select the desired output.
 - Output power is displayed in 11 steps (L, 1–9 and H) but is continuously selectable.
- ④ Push [DISPLAY] to exit quick set mode.

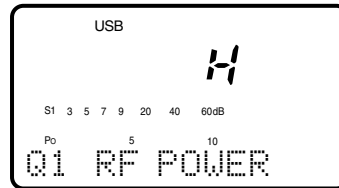

Maximum output power is selected.

•Available power

BAND	SSB/CW/RTTY/FM	AM*
HF	5–100 W	4–40 W
50 MHz	5–100 W	4–40 W
144 MHz	2–20 W	2–8 W

*Carrier power

•Setting microphone gain

Microphone gain must be adjusted properly so that your signal does not distort when transmitted.

- ① Select SSB or another phone mode.
- ② Push [DISPLAY] for 2 sec. to select quick set mode.
- ③ Push [MENU] one or more times to select Q2 MIC GAIN.
 - The ALC meter is selected automatically when operating in SSB mode.
- ④ While speaking into the microphone adjust the mic gain so that the ALC meter does not peak past the ALC zone.
- ⑤ Push [DISPLAY] to exit quick set mode.

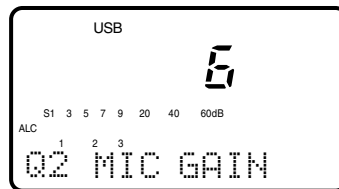

Microphone gain is set to 6.

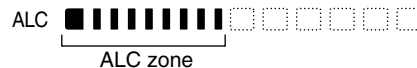

◇ Meter function

The bar meter in the function display acts as an S-meter (for relative signal strength, except in WFM mode) during receive and can be selected for one of three types during transmit.

- ① Select M3.
 - Push [DISPLAY] 1 or 2 times when S or G appears.
 - Push [MENU] one or more times to select M3.
- ② Push [(F-3)MET] one or more times to select the desired meter function.
 - The display indication changes as in the table at right.

DISPLAY INDICATION	MEASUREMENT
Po	Indicates the relative RF output power.
ALC	Indicates the ALC level. When the meter movement shows the input signal level exceeds the allowable level, the ALC limits the RF power. In such cases, reduce the microphone gain (see above).
SWR	Indicates the SWR over the transmission line.

Note: The SWR meter cannot be used for the 144/430 MHz bands since the meter activates for the [ANT 1] connector only.

◆ Speech compressor

The IC-706MKIIG has a built-in, low distortion speech compressor circuit. This circuit increases your average talk power in SSB mode and is especially useful for DX'ing when the receiving station is having difficulty copying your signal.

- ① Select USB or LSB mode.
- ② Select the ALC meter.
 - Push [DISPLAY] 1 or 2 times to select M, if necessary.
 - Push [MENU] one or more times to select M3, then push [(F-3)MET] one or more times to select "ALC."
- ③ Select the mic gain display in quick set mode.
 - Push [DISPLAY] for 2 sec.
 - Push [MENU] one or more times to select 02 MIC GAIN.
- ④ Adjust the mic gain.
 - While transmitting at your normal voice level, the ALC meter should read at about the middle of the ALC zone.
 - Be sure the mic gain is in the range of 2 to 5.
- ⑤ Select M4.
 - Push [DISPLAY] 1 or 2 times to select M, if necessary.
 - Push [MENU] one or more times to select M4.
- ⑥ Push [(F-2)COM], then adjust [COMP GAIN] so that the ALC meter reads within the ALC zone whether you speak softly or loudly.

Note: When the ALC meter peaks above the ALC zone, your transmitted voice may be distorted.

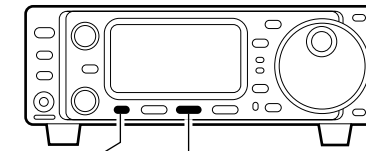

[MENU] [(F-2)COM]

[COMP GAIN]

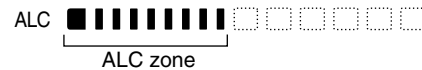
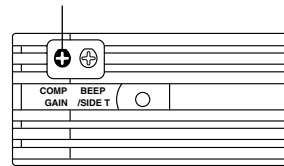

Adjust [COMP GAIN] so that the ALC meter reads within the ALC zone.

◆ VOX operation

The VOX (Voice-operated Transmission) function toggles between transmit and receive with your voice. This function provides an opportunity to input log entries into your computer, etc., while operating.

- ① Select M4, then turn the VOX function ON.
 - Push [DISPLAY] 1 or 2 times when S or G appears.
 - Push [MENU] one or more times to select M4.
 - Push [(F-1)VOX] to turn the function ON.
- ② Select VOX GAIN in quick set mode.
 - Push [DISPLAY] for 2 sec. then push [MENU] one or more times to select 04.
- ③ While speaking into the microphone, adjust [VOX GAIN] until the transceiver is transmitting.
- ④ Select VOX DELAY in quick set mode.
 - Push [MENU] one or more times to select 03.
- ⑤ While speaking into the microphone, adjust [VOX DELAY] as desired.
- ⑥ Select ANTI VOX in quick set mode.
 - Push [MENU] one or more times to select 05.
- ⑦ If the receive audio from the speaker toggles the transceiver to transmit during receive, adjust the [ANTI-VOX] to the point where it has no effect.
- ⑧ Push [DISPLAY] to exit quick set mode.

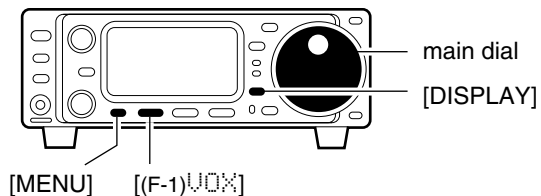

[MENU] [(F-1)VOX]

main dial
[DISPLAY]

◇ Optional AT-180 AUTOMATIC ANTENNA TUNER operation

The AT-180 automatic antenna tuner matches the IC-706MKIIG to the connected antenna automatically. Once the tuner matches an antenna, the variable capacitor angles are memorized as a preset point for each frequency range (100 kHz steps). Therefore, when you change the frequency range, the variable capacitors are automatically preset to the memorized point.

CAUTION: NEVER transmit with the tuner ON when no antenna is connected. This will damage both the transceiver and the antenna tuner.

Note:

- The AT-180 cannot be used for the 144/430 MHz band.
- When operating on the 144/430 MHz band, pushing the tuner switch selects the call channel (p. 39).
- The AT-180 can match both HF and 50 MHz bands. However, operation is different for the HF and 50 MHz bands.

TUNER OPERATION

• For the HF band:

Push [TUNER] to turn the tuner ON. The antenna is tuned automatically during transmission when the antenna SWR is higher than 1.5:1.

- When the tuner is OFF, the [TUNER] light goes out.

[TUNER/CALL]

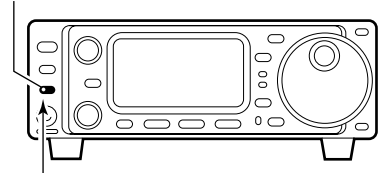

Lights to indicate the AT-180 is turned ON.

• For the 50 MHz band:

Push and hold [TUNER] to tune the antenna. If the [TUNER] light flashes slowly while transmitting, push and hold [TUNER] again to re-tune the antenna.

[TUNER/CALL]

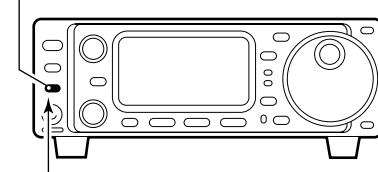

Flashes to indicate re-tuning is necessary.

MANUAL TUNING

During SSB operation on HF bands at low voice levels, the AT-180 may not be tuned correctly. In such cases, manual tuning is helpful.

Push and hold [TUNER] for 1 sec. to start manual tuning.

- CW mode is selected, a side tone is emitted, and the [TUNER] light flashes; then, the previous mode is selected.

[TUNER/CALL]

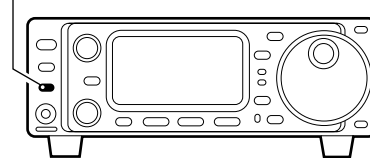

Push and hold for 1 sec. to start manual tuning.

If the tuner cannot reduce the SWR to less than 1.5:1 after 20 sec. of tuning, the [TUNER] light goes out. In this case, check the following:

- the antenna connection and feedline
- the antenna SWR (p. 26; meter function)

Through inhibit (HF bands only)

The AT-180 has a through inhibit condition. When selecting this condition, the tuner can be used at poor SWR's. In this case, automatic tuning in the HF bands activates only when exceeding SWR 3:1. Therefore, manual tuning is necessary each time you change the frequency. Although termed "through inhibit," the tuner will be "through" if the SWR is higher than 3:1 after tuning.

CONVENIENT

• Tuner sensitive condition (HF bands only)

If you require critical tuning at any time during transmission, select the tuner sensitive condition. See p. 55 for selection.

• Automatic tuner start (HF bands only)

If you want to turn OFF the tuner under conditions of VSWR 1.5:1 or less, use "automatic tuner on" and turn the tuner OFF. See p. 54 for turning the function ON and OFF.

◇ Optional AH-4 AUTOMATIC ANTENNA TUNER operation

The AH-4 matches the IC-706MKIIG to a long wire antenna more than 7 m/23 ft long (3.5 MHz and above).

- See p. 14 for connection.
- See the AH-4 instruction manual for AH-4 installation and antenna connection details.

AH-4 setting example:

For mobile operation

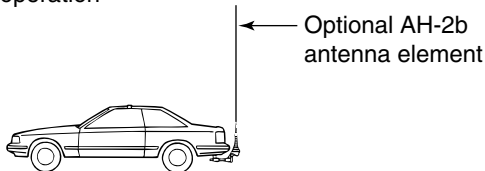

For outdoor operation

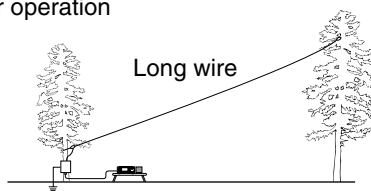

⚠ WARNING: HIGH VOLTAGE!
NEVER touch the antenna element while tuning or transmitting.

NEVER operate the AH-4 without an antenna wire. The tuner and transceiver will be damaged.

NEVER operate the AH-4 when it is ungrounded.

Transmitting before tuning may damage the transceiver. Note that the AH-4 cannot tune when using a $\frac{1}{2} \lambda$ long wire or multiple of the operating frequency.

Note: The AH-4 can be used for HF bands and the 50 MHz band only.

AH-4 operation

Tuning is required for each frequency. **Be sure** to re-tune the antenna before transmitting when you change the frequency—even slightly.

- ① Set the desired frequency in an HF band.
 - The AH-4 will not operate on frequencies outside of ham bands.

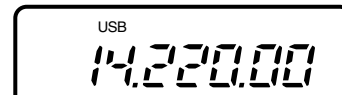

- ② Push and hold [TUNER] for 2 sec.
 - The [TUNER] light flashes and “CW” appears while tuning.

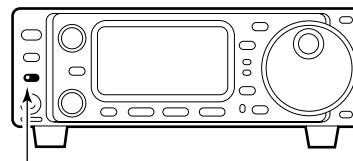

Push [TUNER] for 2 sec.

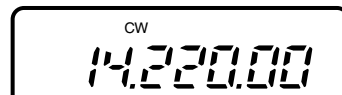

- ③ The [TUNER] light lights constantly when tuning is complete.
 - When the connected wire cannot be tuned, the [TUNER] light goes out, the AH-4 is bypassed and the antenna wire is connected to the antenna connector on the transceiver directly.
- ④ To bypass the AH-4 manually, push [TUNER].

CONVENIENT

• PTT tune function

The AH-4 is always tuned when the PTT is pushed after the frequency is changed (more than 1%). This function removes the “push and hold [TUNER]” operation and activates first transmission on the new frequency. This function is turned ON in initial set mode, item 13 (p. 54).

Split frequency operation

Split frequency operation allows you to transmit and receive on two different frequencies. Split frequency operation uses 2 frequencies, one in VFO A and the other in VFO B.

Following is an example of setting 7.057 MHz, CW mode in VFO A (for receive) and 7.025 MHz, CW mode in VFO B (for transmit).

① Select VFO A and set the frequency to 7.057 MHz/CW.

- [(F-2)A/B] is available when M1 appears.
- [(F-3)U/M] is available when M2 appears.

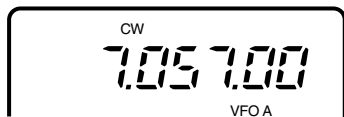

② Push or push and hold [(F-1)SPL] in the M1 display.

- ➔ Push [SPL]: activates split only.
- ➔ Push and hold [SPL]: activates the quick split below.

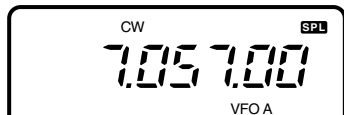

③ To change the receive frequency, rotate the main dial; to change the transmit frequency, rotate the main dial while pushing [(F-3)XFC].

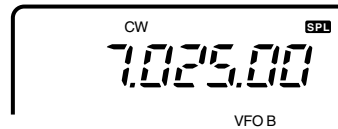

- The transmit frequency can be monitored while pushing [(F-3)XFC].
- Split operation is now set for receive on 7.057 MHz/CW and transmit on 7.025 MHz/CW.

To exchange the transmit and receive frequencies, push [(F-2)A/B] in M1.

CONVENIENT

The display conveniently shows the transmit frequency during split frequency operation and [(F-3)XFC] allows you to change the transmit frequency.

Split lock function

The split lock function is convenient for changing only the transmit frequency. Otherwise, accidentally releasing the [(F-3)XFC] switch while rotating the main dial changes the receive frequency. The split lock's effectiveness can be selected in initial set mode (item 12) for both receive and transmit frequencies; or only the receive frequency. (p. 52)

Quick split function

In M1, when you push [(F-1)SPL] for 2 sec., split frequency operation is turned ON and VFO B is automatically changed according to the plus/minus pre-programmed shift frequency set in initial set mode (or equalized when 0 kHz is programmed as the split shift frequency). This shortens the time needed to start split frequency operation—great for DX'ing.

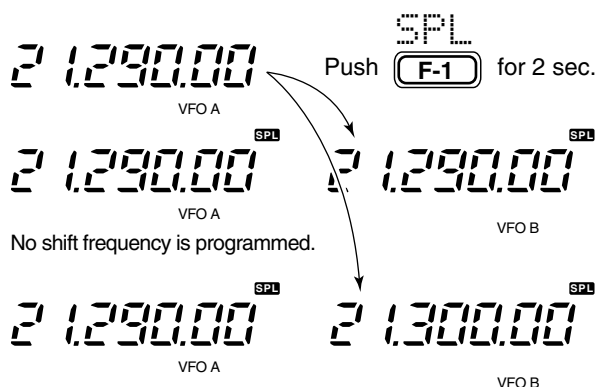

+10 kHz is programmed as a shift frequency.

The quick split function is ON by default. If desired, it can be turned OFF in initial set mode (p. 51). In this case, pushing [(F-1)SPL] for 2 sec. has the same effect as pushing [(F-1)SPL] momentarily as in normal split operation.

PROGRAMMING SPLIT SHIFT FREQUENCY

- ① Push [POWER] to turn power OFF.
- ② While pushing [LOCK], push [POWER] to turn power ON and enter initial set mode.
- ③ Select "SPL OFFSET" using [MENU], [M-CH] or the [▲]/[▼] keys, then rotate the main dial to select the desired split offset.
 - The split offset can be selected from -4000 kHz to +4000 kHz.



Note: This setting is not valid for FM operation. This is because FM operation uses the duplex setting for repeater operation (next page).

◇ Repeater operation

A repeater amplifies received signals and retransmits them at a different frequency. When using a repeater, the transmit frequency is shifted from the receive frequency by an offset frequency. A repeater can be accessed using split frequency operation with the shift frequency set to the repeater's offset frequency.

- ① Set the offset frequency and turn ON the quick split function in initial set mode in advance (p. 52).
 - If the quick split function is turned OFF, both transmit and receive must be set separately.
- ② Push [MODE] one or more times to select FM mode, then set the receive frequency.
- ③ Select a suitable tone frequency in quick set mode.
 - ➔ Push [DISPLAY] for 2 sec., then push [MENU] one or more times to select "Q6 RPTR TONE."
 - If FM mode has not been selected, this item does not appear.
 - ➔ Rotate the main dial to set a subaudible tone frequency.
 - ➔ Push [DISPLAY] to exit quick set mode.
- ④ Push [(F-1)SPL] for 2 sec. (in the M1 display) to activate the split frequency function (duplex function) with the pre-selected offset.
 - When a subaudible tone frequency is selected in ③, "FM-T" is selected simultaneously.
- ⑤ Push and hold [PTT] to transmit; release [PTT] to receive.
 - Push and hold [(F-3)TON] in the M4 display while pushing [PTT] to send the 1750 Hz tone burst. (p. 32)
- ⑥ To check the repeater input frequency (direct signal from the other station), push and hold [(F-3)XFC] in the M1 display.
- ⑦ To return to simplex operation, push [(F-1)SPL].

NOTE: The split function may not be turned off when you change the operating band, push [(F-1)SPL] again to turn off the split function after you finish the repeater operation.

CONVENIENT

Each memory channel can store a tone frequency and an offset frequency, as well as the operating frequency. Store repeater information into memory channels for quick and easy access to repeaters.



Turn the quick split function ON. (Initial set mode default is ON.)

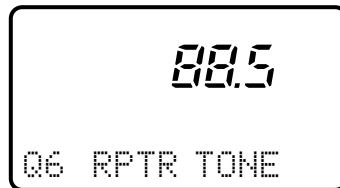

Set the tone frequency (quick set mode). See p. 49 for setting details and available frequencies.



PROGRAMMING DUPLEX SHIFT FREQUENCY

- ① Push [POWER] to turn power OFF.
- ② While pushing [LOCK], push [POWER] to turn power ON and enter initial set mode.
- ③ Select "DUP 144M" using [MENU] or the [UP]/[DN] keys, then rotate the main dial to select the desired duplex offset.
 - The duplex offset can be selected from -4000 kHz to +4000 kHz.



■ Tone squelch operation

Tone squelch operation is a method of communications using selective calling. Only received signals having a matching tone will open the squelch. Before communicating using tone squelch, all members of your party must agree on the tone squelch frequency to use.

- ① Push [MODE] one or more times to select FM mode.
- ② Push and hold [DISPLAY] to enter Quick Set mode.
- ③ Push [MENU] one or more times to select item 07 TONE SQL.
 - [▲]/[▼] or [M-CH] can also be used.
- ④ Rotate the main dial to select the desired subaudible tone frequency.
 - Available tone frequencies are the same as for repeater tone operation (see previous page).
- ⑤ Select M4 and turn the tone squelch function ON.
 - ➔ Push [(F-3)TON] to toggle tone squelch operation ON and OFF.
 - When tone squelch is turned ON, "TSQL" appears in the display.
- ⑥ Communicate in the usual manner.
 - Push [PTT] to transmit; release to receive.

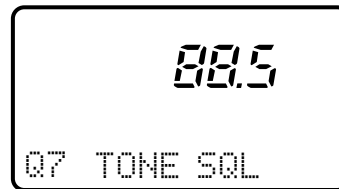

Set the tone frequency (quick set mode).

See p. 49 for setting details and available frequencies.

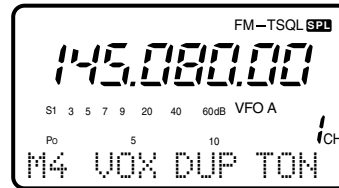

■ Tone scan operation

By monitoring a signal that is being transmitted on a repeater input frequency, you can determine the tone frequency necessary to open a repeater.

- ① During tone squelch or repeater operation, push and hold [DISPLAY] to enter Quick Set mode.
- ② Push [MENU] one or more times to select item 08 T-SQL SCN during tone squelch operation, or 08 RPTR-T SCN during repeater operation.
 - [▲]/[▼] or [M-CH] can also be used.
- ③ Push [(F-3)SCN] to toggle tone scan operation ON and OFF.
 - While scanning tone frequencies are displayed instead of the operating frequency.
 - When a matched tone is detected, tone scan automatically stops, the matched tone is displayed and the repeater tone (or tone squelch tone) setting is automatically adjusted accordingly.
- ④ Push [DISPLAY] to return to the main menu.

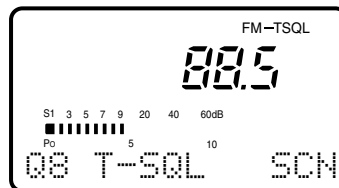

During tone squelch operation.

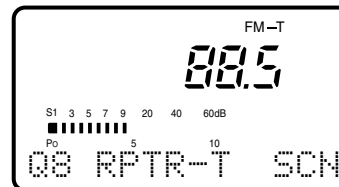

During repeater operation.

■ One-touch repeater function

This function allows you to set repeater operation with the push of one switch.

- ① Push [(▲)BAND]/[(▼)BAND] to select the 28 MHz band.
- ② Rotate [DIAL] to select the operating frequency.
- ③ Push [MODE] one or more times to select FM.
- ④ Select M4 and turn the one-touch repeater function ON.
 - ➔ Push and hold [(F-2)DUP] to toggle the one-touch repeater function ON and OFF.
 - When the one-touch repeater function is turned ON, “DUP” (duplex indicator) and “T” (tone frequency indicator) appear in the display.
 - Be sure to set the duplex direction and offset in initial set mode in advance (p. 52).
 - Push [(F-2)DUP] to toggle the duplex direction.

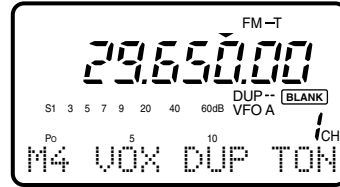
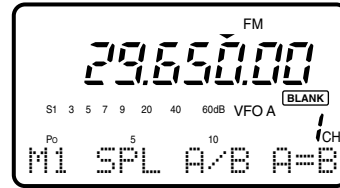

☞ **NOTE:** When you want to transmit a 1750 Hz tone, while pushing [PTT], push [(F-3)TON] in the M4 display during repeater operation.

■ Auto repeater function

This function automatically activates the repeater settings (DUP+ or DUP- and tone encoder ON/OFF) when the operating frequency falls within the general output frequency range and deactivates them when outside of the range.

Set the auto repeater function ON or OFF in initial set mode in advance (p. 53). When set ON, repeater settings are automatically activated according to the table at right.

FREQUENCY	DUPLEX DIRECTION
145.200–145.495 MHz 146.610–146.995 MHz	“DUP-” appears
147.000–147.395 MHz	“DUP+” appears
442.000–444.995 MHz	“DUP+” appears
447.000–449.995 MHz	“DUP-” appears

☞ **NOTE:** This function is available for the USA version only.

■ 1750 Hz tone burst (FM mode only)

A 1750 Hz tone is required to access most European repeaters. When you want to transmit a 1750 Hz tone, there are two methods described as follows;

- ➔ While pushing [PTT], push [(F-3)TON] in the M4 display during repeater operation. (pgs. 30, 32)
 - ➔ While pushing [PTT], push [F-2] in the G4 memory name display.
- ☞ **NOTE:** Program the memory names and the appropriate repeaters information before using this function. (p. 41)

■ Functions for CW

◇ Connections for CW

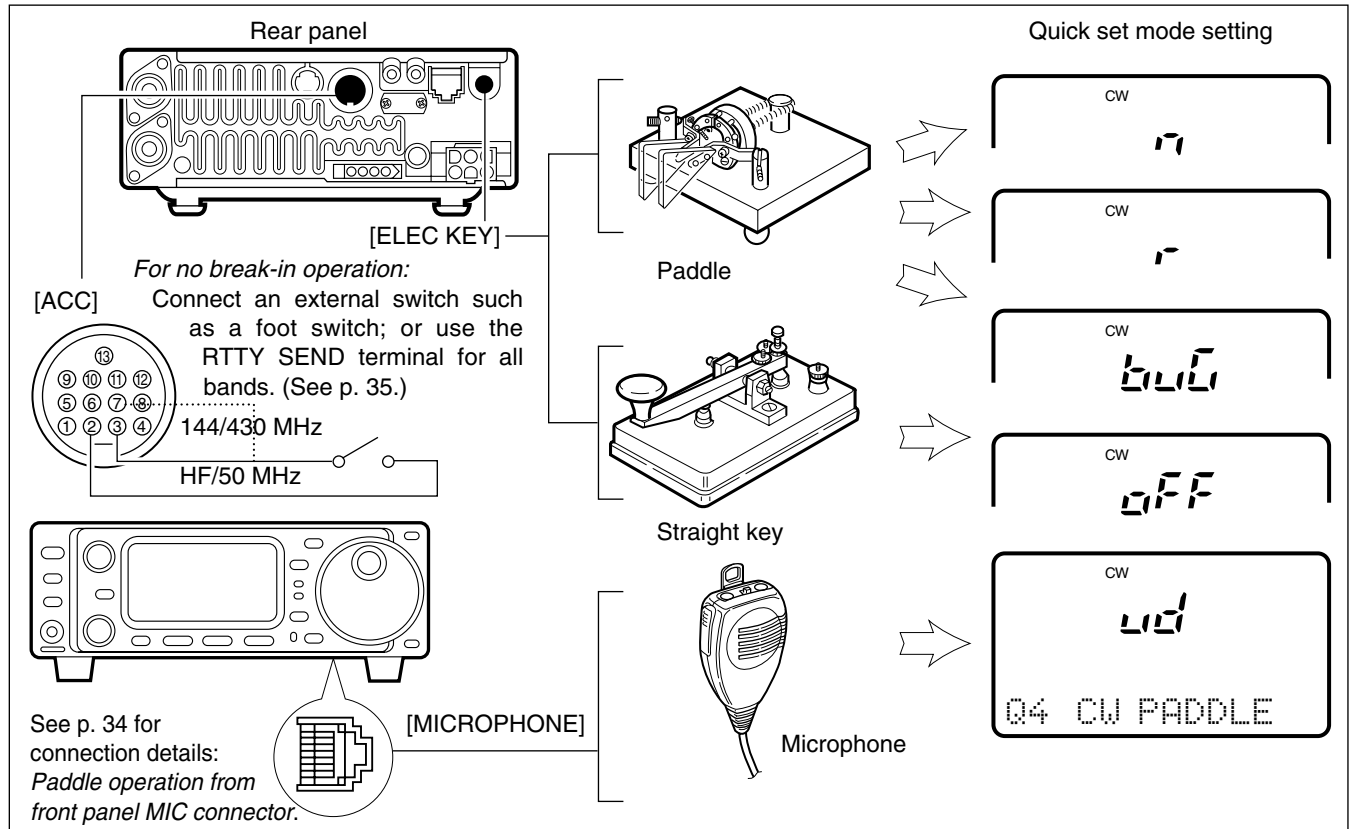

◇ CW operation

- ① Connect a paddle or straight key as above.
- ② Select CW (or CW \square) mode with [MODE].
- ③ Set CW break-in operation as semi break-in, full break-in or OFF.
 - Push [DISPLAY] one or two times to select M, if necessary.
 - Push [MENU] one or more times to select M4.
 - Push [(F-2)BRK] one or more times to select the desired condition:
 - ▶ "F-BK": full break-in
 - ▶ "BK": semi break-in
 - ▶ No indicator: no break-in (ACC socket connection is necessary as above.)
- ④ Set the CW delay time when semi break-in operation is selected.
 - ▶ Push [DISPLAY] for 2 sec. to select quick set mode; push [MENU] one or more times to select Q3 BK-IN DELAY; then rotate the main dial to set the desired delay time (see p. 48 for details).



CW mode and semi break-in operation is selected.

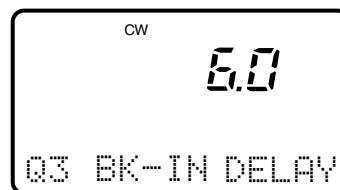

Delay time of 6.0 dots is selected in quick set mode for semi break-in operation.

◇ CW pitch control QUICK SET MODE

The received CW audio pitch and monitored CW audio pitch can be adjusted to suit your preferences (300 to 900 Hz) without changing the operating frequency.

- ① Push [MODE] one or more times to select CW mode.
- ② Select CW PITCH in quick set mode.
 - Push [DISP] for 2 sec. then push [MENU] one or more times.

- ③ Rotate the main dial to set the desired pitch.
- ④ Push [DISPLAY] to exit quick set mode.

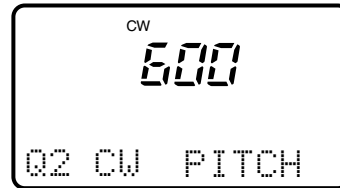

This shows the default setting for the CW pitch control (600 Hz).

◇ CW reverse mode

The CW \overline{R} (CW Reverse) mode receives CW signals with a reverse side CW carrier point like that of LSB and USB modes. Use this mode when interference signals are near the desired signal and you want to change the interference tone.

- ① Push [MODE] one or more times to select CW mode.
- ② Push and hold to toggle between CW and CW \overline{R} modes.
 - Check the interference tone.

• Receive audio tone response

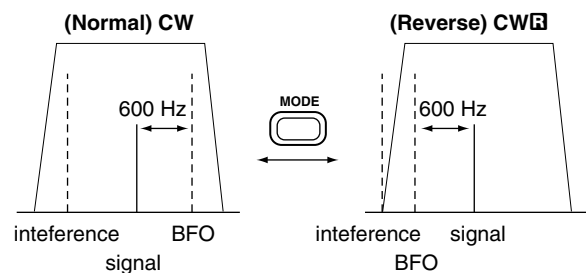

◇ Electronic CW keyer QUICK SET MODE

The IC-706MKIIG has an electronic keyer. Both keying speed and weight (the ratio of dot:space:dash) can be set in quick set mode.

• Setting the electronic keyer

- ① Select CW mode with [MODE].
- ② Push [DISPLAY] for 2 sec. to enter quick set mode.
- ③ Push [MENU] one or more times to select item 04 CW PADDLE, then rotate the main dial to select the paddle type.
 - When “ud” is selected, the up/down switches on the microphone can be used as a paddle.
- ④ Push [MENU] two more times to select item 06 RATIO, then rotate the main dial to select the desired weight.
 - Key weight can be selected from 2.8 to 4.5.
 - Check the selected ratio with the side tone function in CW mode.
- ⑤ Push [DISPLAY] momentarily to exit quick set mode.

Paddle operation from front panel MIC connector

Connect a CW paddle as at right to operate an electronic keyer from the front panel MIC connector.

- This function is available from the front panel mic connector only.
- Be sure to select item “n,” “r,” “buG” or “oFF” in 04 CW PADDLE in quick set mode. (p. 49)
- Connect straight key to “DOT” side.

KEYING WEIGHT EXAMPLE: morse code “K”

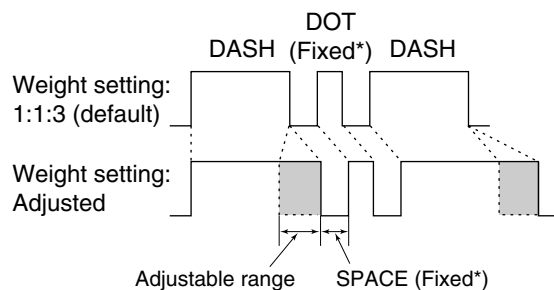

*SPACE and DOT length can be adjusted with “05 KEY SPEED” only.

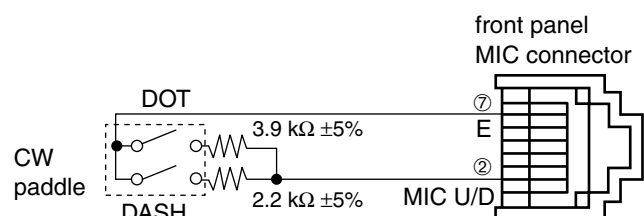

■ Functions for RTTY

◇ Connections for RTTY (FSK)

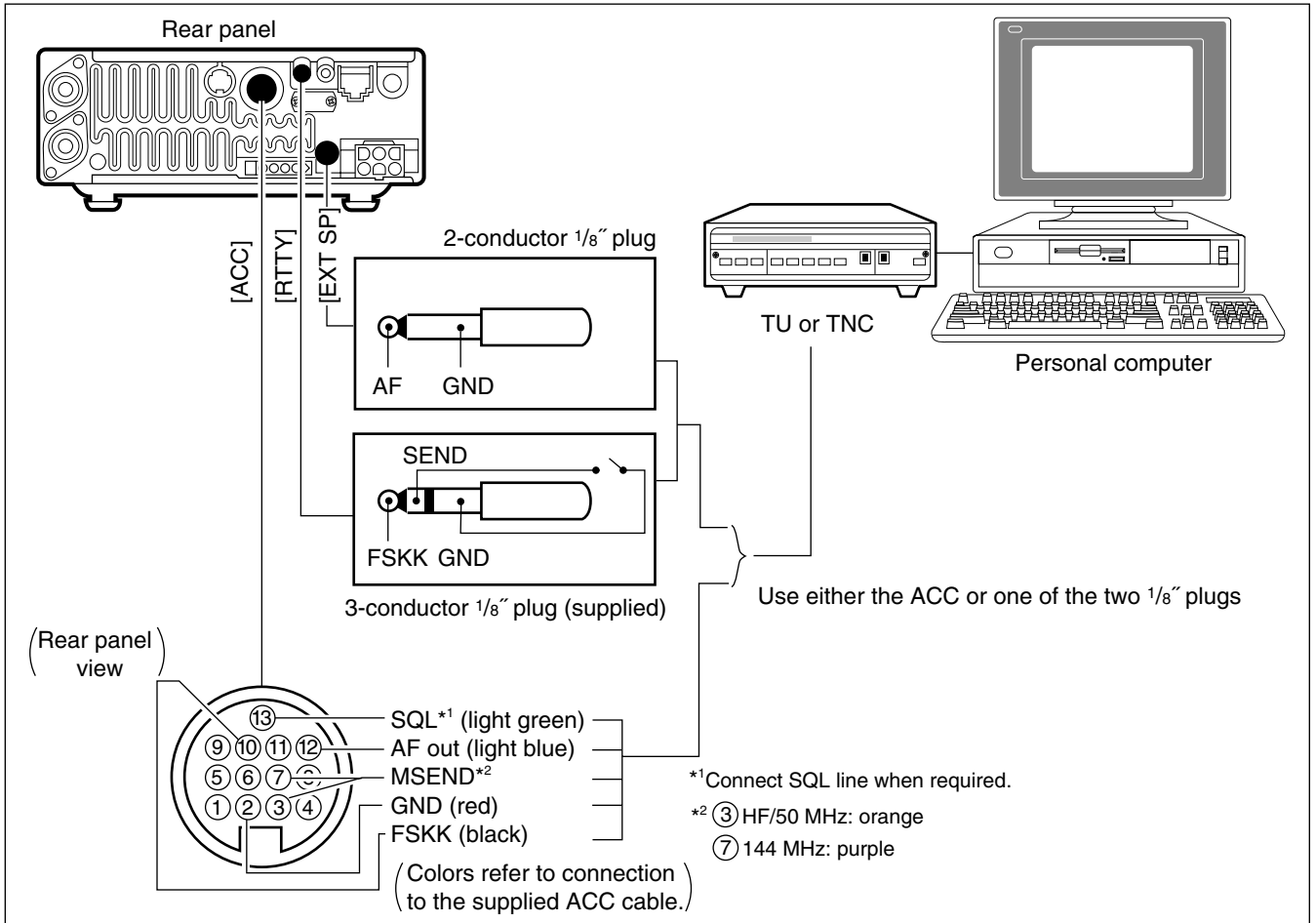

◇ Connections for AFSK

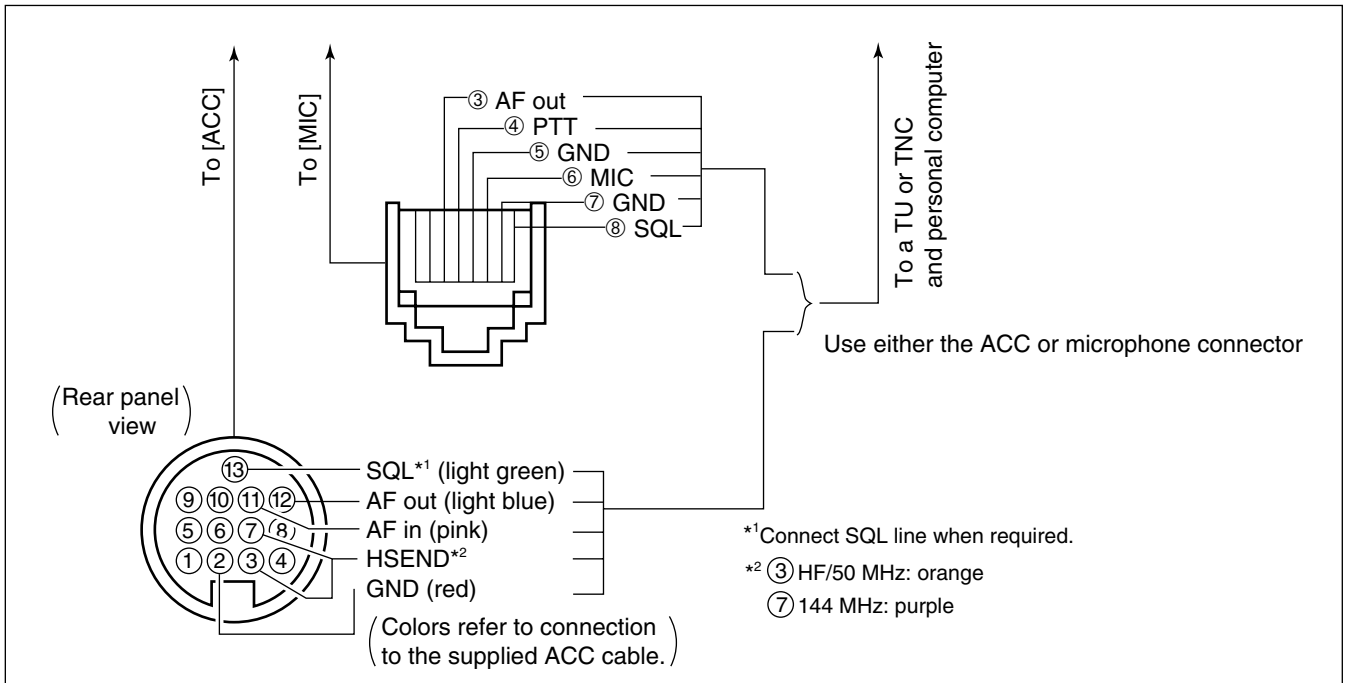

◇ RTTY (FSK) operation

- ① Connect a terminal unit as at left.
- ② Select RTTY (or **RTTY**—see bottom of page) mode with [MODE].
- ③ Select the desired FSK tone/shift frequencies and keying polarity as below.
- ④ Set the desired frequency with the main dial.
 - Use [(F-1)1/4] in the M4 display when critical setting is required.
- ⑤ Operate the connected PC or TNC (TU).



RTTY mode is selected.

PRESETTING FOR RTTY

Tone frequency

- ① Push [DISPLAY] for 2 sec. to select quick set mode.
- ② Push [MENU] one or more times to select **02 RTTY TONE**; then rotate the main dial to select the desired tone frequency (p. 48).



RTTY mark frequency is set to 2125 Hz.
2125 and 1615 Hz are available.

Shift frequency

- ① Push [DISPLAY] for 2 sec. to select quick set mode.
- ② Push [MENU] one or more times to select **03 RTTY SHIFT**; then rotate the main dial to select the desired shift frequency (p. 48).

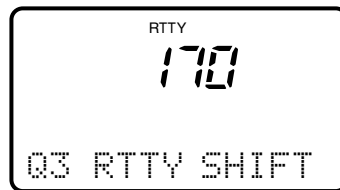

RTTY shift frequency is set to 170 Hz.
170/200/425 Hz are available.

RTTY keying

- ① Push [DISPLAY] for 2 sec. to select quick set mode.
- ② Push [MENU] one or more times to select **04 RTTY KEYING**; then rotate the main dial to select the desired keying polarity (p. 48).



RTTY keying is set to 'normal'.
normal: key open=mark
key close=space
reverse: key open=space
key close=mark

◇ RTTY (AFSK) operation

- ① Connect a terminal unit as at left.
- ② Select SSB (LSB) mode with [MODE].
 - Generally, LSB is used on the HF bands and FM is used for the VHF band.
- ③ Select the desired FSK tone/shift frequencies and keying polarity as below.
- ④ Set the desired frequency with the main dial.
 - Use [(F-1)1/4] in the M4 display when critical setting is required.
- ⑤ Operate the connected PC or TNC (TU).

PRESETTING FOR RTTY

Tone frequency

Same as above.

Shift frequency

Same as above.

RTTY keying

Same as above.

RTTY reverse mode

Received characters are occasionally garbled when the receive signal is reversed between MARK and SPACE. This reversal can be caused by incorrect TNC connections, settings, commands, etc.

To receive a reversed RTTY signal correctly, select **RTTY** (RTTY reverse) mode.

- ➔ Push [MODE] for 1 sec. (while RTTY is selected) to select **RTTY** mode.
- Check the receive signal.

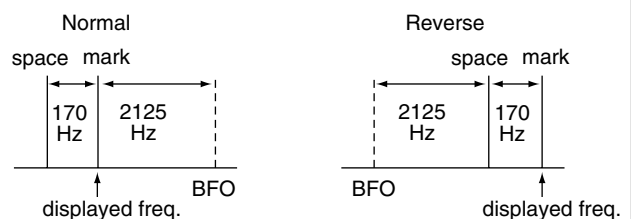

Packet operation

Connections for packet

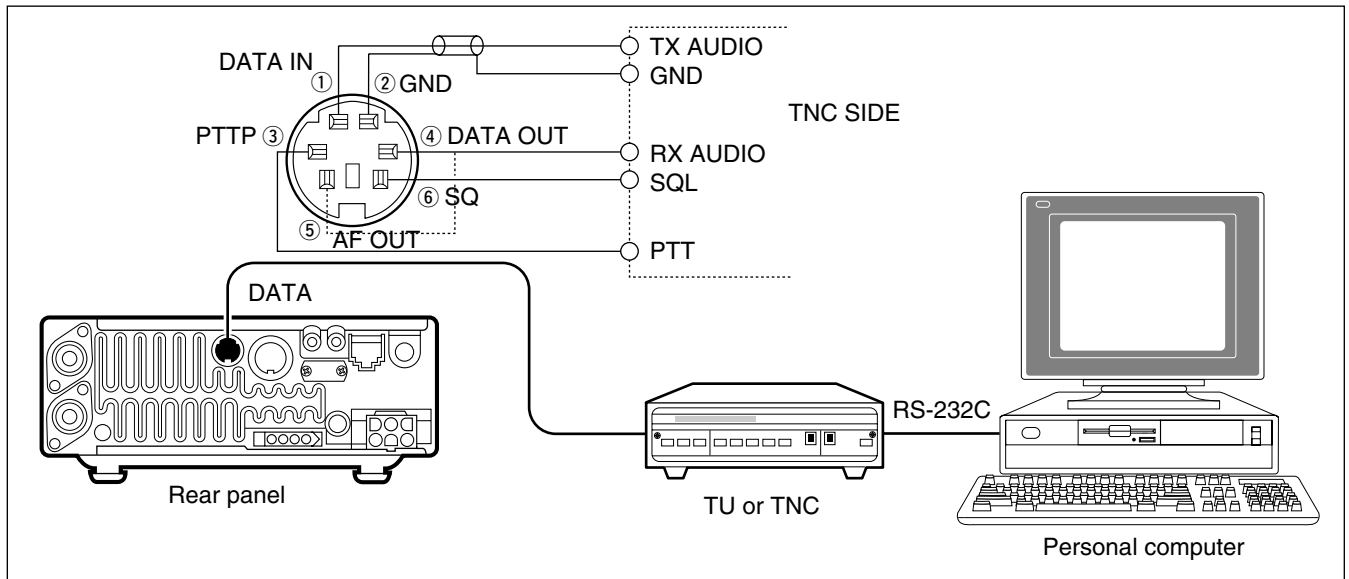

Data socket

Rear panel view

PIN #/NAME	DESCRIPTION
① DATA IN	Communication data input.
② GND	Ground for DATA IN, DATA OUT and AF OUT.
③ PTP	Transmits when grounded.
④ DATA OUT	Outputs 9600 bps receive data.
⑤ AF OUT	Outputs 1200 bps receive data.
⑥ SQ	Squelch output. Goes to ground when squelch opens.

Adjusting the transmit signal output from the TNC

NOTE: For packet operation the transceiver can be set to one of two data speeds: 1200 bps or 9600 bps. Data speed is set in initial set mode (see p. 54 item 29 9600 MODE).

Data speed is set in initial set mode (see p. 53 item 29 9600 MODE). When setting data transmission speed to 9600 bps, the DATA signal coming from the TNC is applied exclusively to the internal limiter circuitry to automatically maintain bandwidth.

NEVER apply data levels from the TNC of over 0.6 Vp-p, otherwise the transceiver will not be able to maintain the band width and may possibly interfere with other stations.

NOTE: Read the instructions supplied with your TNC carefully before attempting packet operation with the IC-706MKIIG.

1. When using a level meter or synchroscope, adjust the TX audio level (DATA IN level) from the TNC as follows.

- 0.4 Vp-p (0.2 Vrms): recommended level
- 0.2 Vp-p–0.5 Vp-p (0.1 Vrms–0.25 Vrms): acceptable level

2. When not using a measuring device.

- ① Connect the IC-706MKIIG to a TNC.
- ② Enter a test mode (“CAL”, etc.) on the TNC, then transmit some test data.
- ③ *When the transceiver fails to transmit test data or transmits sporadically (TX indicator doesn't appear or flashes):*

Decrease the TNC output level until the transmit indicator lights continuously.

When transmission is not successful even though the TX indicator lights continuously:
Increase the TNC output level.

■ SWR

The IC-706MKIIG has a built-in circuit for measuring antenna SWR—no external equipment or special adjustments are necessary.

NOTE: The SWR can only be measured on ANT1, HF/50 MHz bands.

◆ Measuring SWR

The IC-706MKIIG can measure SWR in 2 ways:
 (A) Spot measurement; or (B) Plot measurement.

(A) Spot measurement

- ① Confirm that the output power is over 30 W.
- ② Push [MENU] one or more times to select M3.
- ③ Push [(F3)MET] to select the SWR meter.
- ④ Push [MODE] one or more times to select CW or RTTY operation.
 - Key down or push [PTT] to transmit; then read the actual SWR from the meter:
 - ➡ ≤ 1.5 well matched antenna
 - ➡ > 1.5 check antenna or cable connection, etc.

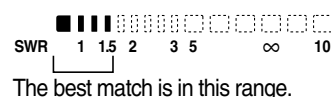
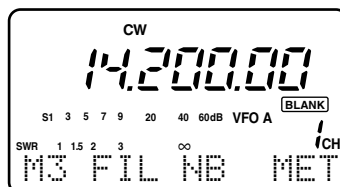

(B) Plot measurement

Plot measurement allows you to measure the SWR over an entire band.



- Frequency span
- Step bar indication
- Frequency indication mark
- Measure start indicator

Span	Push [F-1] for 1 sec. to change the selected span.
Step bar	Push [F-2] for 1 sec. to change the step bar (3, 5, 7 or 9 steps are available).
Marker	Indicates the currently active step bar.
Start	Flashes while the SWR is being measured.

- ① Confirm that the output power is over 30 W.
- ② Push [DISPLAY] twice to select G1 menu.
- ③ Push [MENU] to select G2.
- ④ Set the center frequency for the SWR to be measured.
- ⑤ Push and hold [(F1)10k] one or more times to select the desired frequency pitch.
- ⑥ Push and hold [(F2)] one or more times to select the desired step.
- ⑦ After selecting the desired pitch and step, push [(F3)STR] to measure the SWR.
 - RTTY mode is selected automatically.
- ⑧ Push and hold [PTT] to display the SWR in a bar graph readout.
- ⑨ When [PTT] is released, the frequency marker and frequency indication move to the next frequency to be measured.
- ⑩ Repeat steps ⑧ and ⑨ to measure SWR over the entire frequency range.
- ⑪ When the measured SWR is less than 1.5, the antenna is well matched.

Step ⑨

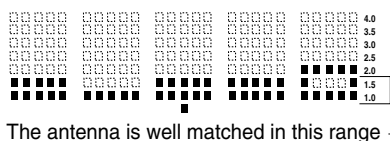

Memory channels

The transceiver has 105 memory channels (plus 2 call channels). Memory mode is useful for quickly changing to often-used frequencies.

Note: During split frequency operation, programmed memory contents can be called up to the SUB readout (dot matrix portion of the display).

All 105 memory channels are tuneable which means the programmed frequency can be tuned temporarily with the main dial, etc., in memory mode.

MEMORY CHANNEL	MEMORY CHANNEL NUMBER	CAPABILITY	TRANSFER TO VFO	OVER-WRITING	CLEAR
Regular (split memory)	1-99	Independent transmit and receive frequencies and one mode in each memory channel. In addition, tone frequencies (or 1750 Hz tone burst) can also be stored for repeater use.	Yes	Yes	Yes
Scan edges	1A-3B (3 pair)	One frequency and one mode in each memory channel as scan edges for programmed scan.	Yes	Yes	No
Call channel (split memory)	C1 (144 MHz) C2 (430 MHz)	Same as regular, but only 144/430 MHz band can be programmed.	Yes	Yes	No

Memory channel selection

- ① Select M2 functions.
 - Push [DISPLAY] 1 or 2 times to select M.
 - Push [MENU] one or more times to select M2.
- ② Push [(F-3)] to select memory mode.
- ③ Rotate [M-CH] to select the desired memory channel.
 - All memory channels including blank channels can be selected.
 - [UP]/[DN] on the microphone changes the frequency.
- ④ To return to VFO mode, push [(F-3)] again.

[EXAMPLE]: Selecting memory channel 17.

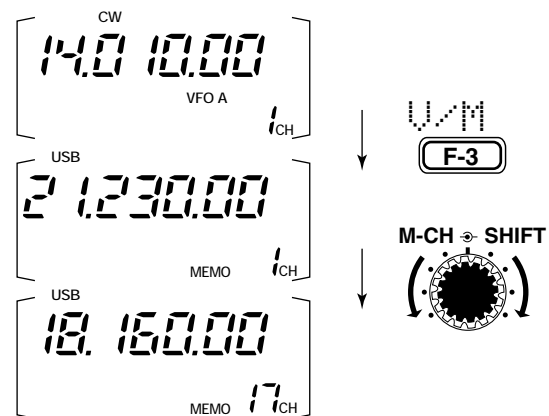

Memory clearing

Any unnecessary memory channels can be cleared. The cleared memory channels become blank channels.

- ① Push [(F-3)] in the M2 display to select memory mode.
- ② Rotate [M-CH] to select a memory channel to be cleared.
- ③ Push [MCL (F-2)] for 2 sec. to clear the contents.
 - The programmed frequency and operating mode disappear and "BLANK" appears.
- ④ To return to VFO mode, push [(F-3)] again.

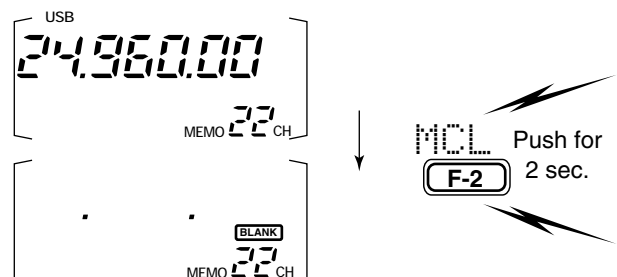

Memory/call programming

• Programming in VFO mode

- ① Select M2 functions.
 - Push [DISPLAY] 1 or 2 times to select M.
 - Push [MENU] one or more times to select the M2 functions.
- ② Set the desired frequency and operating mode in VFO mode.
 - If you want to program the split frequency function, program both receive and transmit frequencies into VFO A and B, then turn ON the split function.
 - If you want to program a repeater function, set a tone frequency (p. 49) in addition to the receive/transmit frequencies.
- ③ Rotate [M-CH] to select the desired memory channel, or the call channel (144/430 MHz bands only).
 - Select memory mode to confirm the contents, if desired.
 - "[BLANK]" appears if the selected memory channel is a blank channel (and does not have contents).
- ④ Push [(F-1)M] for 2 sec. to program the displayed frequency and operating mode into the memory channel.

To check the programmed contents, push [(F-3)M] to select memory mode; or, push [CALL] to select the call channel.

[EXAMPLE]: Programming 7.088 MHz/LSB into ch 12.

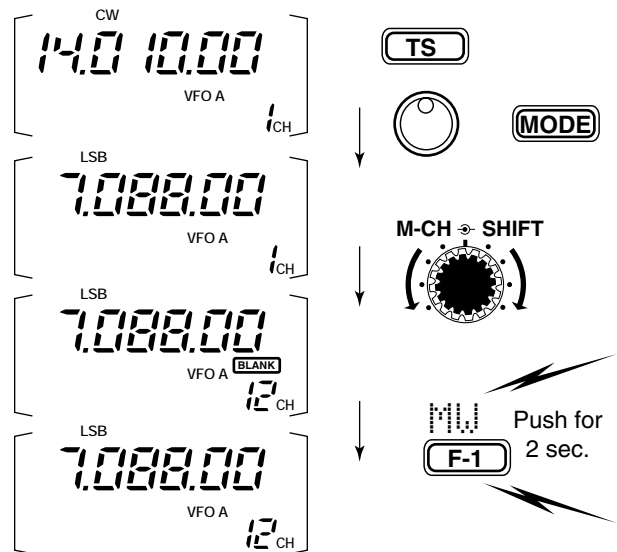

• Programming in memory mode

- ① Set the desired frequency and operating mode.
- ② Select memory mode, then select the desired memory channel with [M-CH].
 - Push [▲]/[▼] when you want to program blank channels.
- ③ Push [(F-1)M] for 2 sec. to program the displayed frequency and operating mode into the memory channel.

[EXAMPLE]: Programming 21.280 MHz/USB into ch 18.

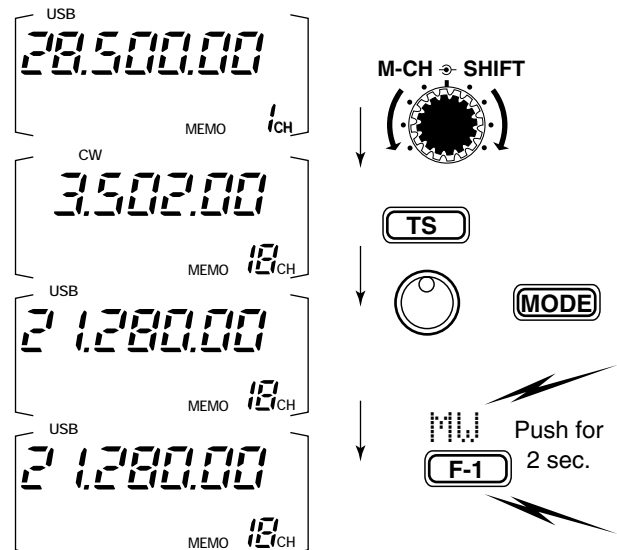

Frequency transferring

The frequency and operating mode can be transferred from memory mode to VFO mode.

- ① Select VFO mode with [(F-3)M] in the M2 display.
- ② Select a memory channel with [M-CH].
 - Select memory mode to confirm the memory channel's contents, if desired; then return to VFO mode.
 - "BLANK" appears if the selected memory channel is a blank channel (and does not have contents). In this case transferring is not possible.
- ③ Push [(F-2)M] for 2 sec. to transfer the frequency and operating mode.
 - Transferred frequency and operating mode appear in the display.
 - "M" does not appear in memory mode.

[EXAMPLE]: Transferring contents of memory 16.
 Operating frequency: 21.320 MHz/USB (VFO)
 Contents of memory 16: 14.020 MHz/CW

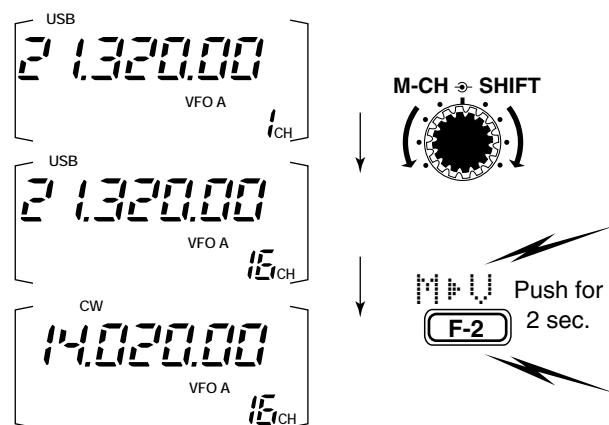

Memory names

All memory channels (including scan edges and the call channel) can be tagged with alphanumeric names of up to 9 characters each.

All common keyboard characters (ASCII characters 33 to 126) can be used, including numerals and punctuation marks.

Calling up memory names

- ① Select the G4 display.
 - ➔ Push [DISPLAY] 1 or 2 times to select G.
 - ➔ Push [MENU] one or more times to select the G4 display.
- ② Select a memory channel with [M-CH].

Editing (programming) memory names

- ① Call up the desired memory (channel) name as above.
- ② Push [(F-3)E] to enter memory name edit mode.
 - "name edit" appears briefly, then a flashing cursor appears under the first character position.
- ③ Rotate the main dial to select the desired character, then advance the cursor position.
 - [(F-3)R] increments the cursor position; [(F-1)L] decrements the cursor position.
 - [(F-2)] overwrites the character with a space.
- ④ Repeat this procedure until all desired characters have been selected.
- ⑤ Push [(MENU)EXIT] to exit memory name edit mode.
 - The G4 display reappears and the programmed memory name is displayed.

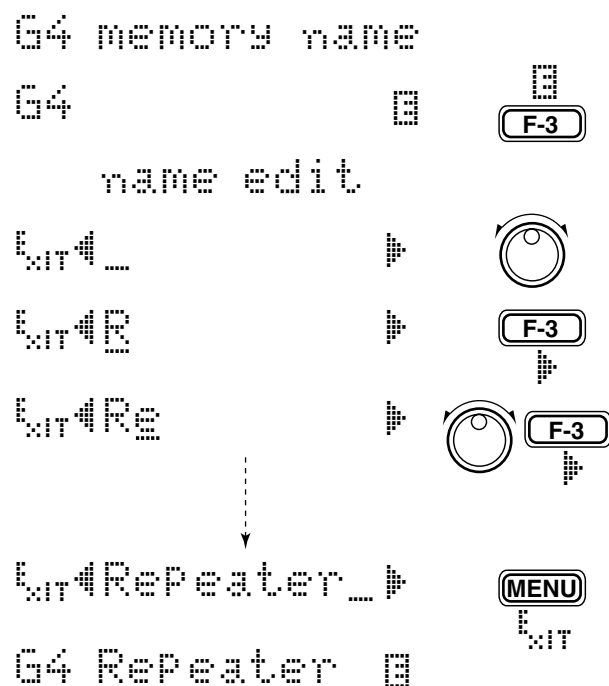

■ Memo pads

The transceiver has a memo pad function to store frequency and operating mode for easy write and recall. The memo pads are separate from memory channels.

The default number of memo pads is 5, however, this can be increased to 10 in initial set mode if desired (p. 53).

Memo pads are convenient when you want to memorize a frequency and operating mode temporarily, such as when you find a DX station in a pile-up or when a station is busy for a long time and you want to temporarily search for other stations.

Use the transceiver's memo pads instead of relying on hastily scribbled notes that are easily misplaced.

• Writing frequencies and operating modes into memo pads

- ① Select the S1 display.
 - Push [DISPLAY] 1 or 2 times to select S.
 - Push [MENU] one or more times to select S1.
- ② Push [(F-2)MPW] to program the frequency into a memo pad.

When you write a 6th frequency and operating mode, the oldest written frequency and operating mode are automatically erased to make room for the new settings.

Note: Each memo pad must have its own unique combination of frequency and operating mode; memo pads having identical settings cannot be written.

Displayed frequency and mode

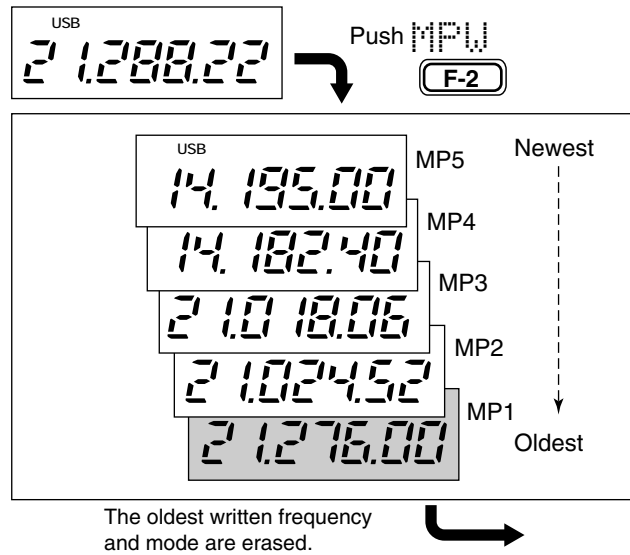

• Calling up a frequency from a memo pad

You can simply call up the desired frequency and operating mode of a memo pad by pushing [(F-3)MPR] in the S1 display.

- Make sure S1 is selected in advance.
- Both VFO and memory modes can be used.
- The frequency and operating mode are called up, starting from the most recently written.

When you call up a frequency and an operating mode from memo pads with [(F-3)MPR], the previously displayed frequency and operating mode are automatically stored in a temporary pad. The frequency and operating mode in the temporary pad can be recalled by pushing [(F-3)MPR] one or more times.

Note: If you change the frequency or operating mode called up from a memo pad, the frequency and operating mode in the temporary pad are erased.

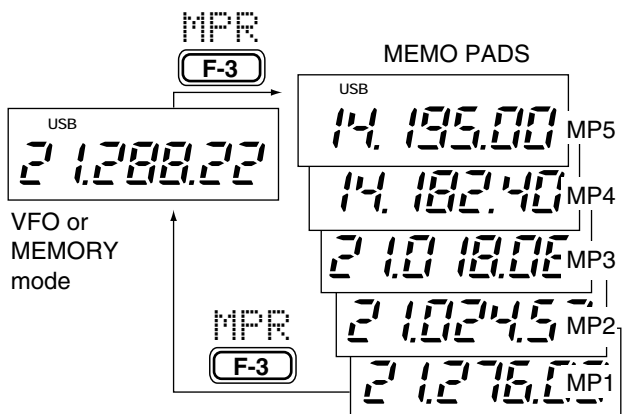

Scan types

PROGRAMMED SCAN
 Repeatedly scans between two scan edge frequencies (scan edge memory channels 1A and 1B).

This scan operates in VFO mode.

PRIORITY WATCH
 Checks for signals on a memory or call channel while operating on a VFO frequency.

This scan operates in VFO mode.

MEMORY SCAN
 Repeatedly scans all programmed memory channels.

This scan operates in memory mode.

SELECTED MEMORY SCAN
 Repeatedly scans all selected memory channels.

This scan operates in memory mode.

Preparation

•Channels

For programmed scan: Program scan edge frequencies into scan edge memory channels 1A and 1B (p. 34).

For memory scan: Program 2 or more memory channels except scan edge memory channels.

For memory select scan: Designate 2 or more memory channels as select memory channels—select a memory channel, then push [(F-2)SEL] in the S2 display (memory mode) to designate the channel as a select memory channel.

For priority watch: Program 1 memory channel to be watched.

•Scan resume ON/OFF

You can select the scan to resume or cancel when detecting a signal, in initial set mode, item 21. Scan resume ON/OFF must be set before operating a scan. See p. 53 for ON/OFF setting and scan resume condition details.

• Scan speed

Scan speed can be selected from 2 levels, high or low, in initial set mode. See p. 47 for details.

•Squelch condition

SCAN STARTS WITH	PROGRAMMED SCAN	MEMORY SCANS PRIORITY WATCH
SQUELCH OPEN	The scan continues until it is stopped manually, and does not pause even if it detects signals. This is not applicable when the scan resume is OFF and a programmable step (more than 1 kHz) is selected.	Scan pauses on each channel when the scan resume is ON; not applicable when OFF.
SQUELCH CLOSED	Scan stops when detecting a signal. If you set scan resume ON in initial set mode, the scan pauses for 10 sec. when detecting a signal, then resumes. When a signal disappears while scan is paused, scan resumes 2 sec. later.	

Programmed scan operation

- ① Select VFO mode.
- ② Select the desired operating mode.
 - The operating mode can also be changed while scanning.
- ③ Set [SQL] open or closed.
 - See page a left for squelch condition.
- ④ Select S2, then push [(F-1)SON] to start the scan.
 - Decimal point blinks while scanning.
- ⑤ When the scan detects a signal, the scan turns OFF, pauses or ignores it depending on the resume setting and the squelch condition.
 - During scan [TS] can be used only when resume is ON.
- ⑥ To cancel the scan push [(F-1)SON].

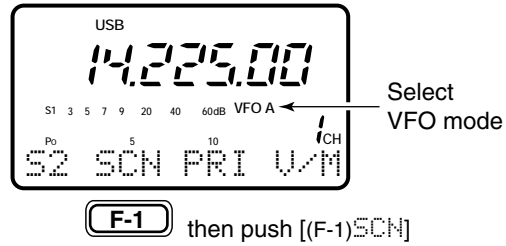

Note: If the same frequencies are programmed into the scan edge memory channels 1A and 1B, programmed scan does not start.

Memory scan operation

- ① Select memory mode.
- ② Close the squelch with [SQL].
- ③ Select S2, then push [(F-1)SON] to start the scan.
 - Decimal point blinks while scanning.
- ④ When the scan detects a signal, the scan stops or pauses depending on the resume setting.
- ⑤ To cancel the scan push [(F-1)SON].

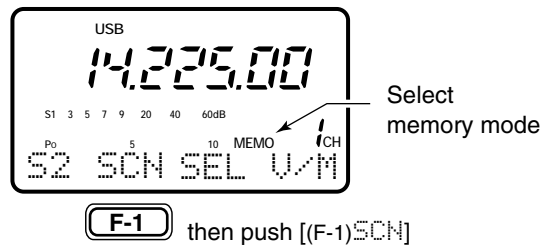

Note: Two or more memory channels must be programmed for memory scan to start.

Select memory scan operation

- ① Select memory mode.
- ② Close the squelch with [SQL].
- ③ Select S2, then push [(F-1)SON] to start the memory scan.
 - Decimal point blinks while scanning.
- ④ Push [(F-2)SEL] to change the memory scan to select memory scan.
 - Push [(F-2)SEL] for 2 sec. to clear all select memory channels.
- ⑤ When the scan detects a signal, the scan stops or pauses depending on the resume setting.
- ⑥ To cancel the scan push [(F-1)SON].

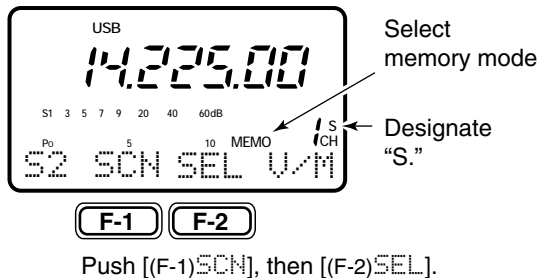

Note: Two or more memory channels must be designated as select memory channels for select memory scan to start.

Priority watch

- ① Select VFO mode, then set a frequency.
- ② Close the squelch with [SQL].
- ③ Set the desired memory channel as the watching channel.
- ④ Select S2, then push [(F-2)PRI] to start the watch.
 - Decimal point blinks while scanning.
- ⑤ When the scan detects a signal, the scan pauses for 10 sec. or until the signal disappears, depending on the resume setting.
- ⑥ To cancel the scan push [(F-2)PRI].

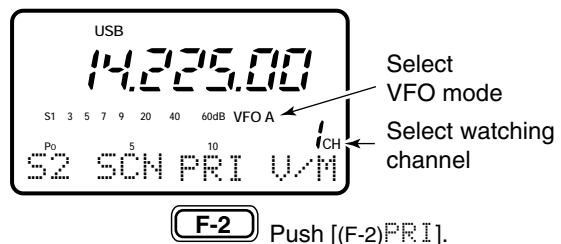

Note: The paused condition when detecting a signal differs depending on the scan resume condition.
 resume on: pauses for 10 sec.
 resume off: pauses until the signal disappears.

◇ CI-V connection example

The transceiver can be connected through an optional CT-17 CI-V LEVEL CONVERTER to a personal computer equipped with an RS-232C port. The Icom Communication interface-V (CI-V) controls the following functions of the transceiver.

Up to four Icom CI-V transceivers or receivers can be connected to a personal computer equipped with an RS-232C port. See p. 55 for setting the CI-V condition using initial set mode.

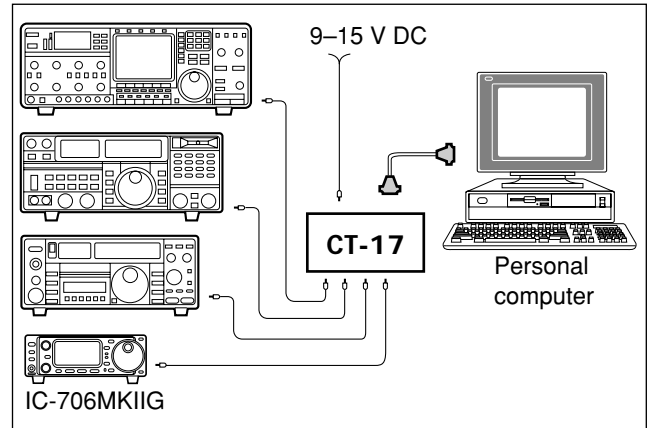

◇ Data format

The CI-V system can be operated using the following data formats. Data formats differ according to command numbers. A data area is added for some commands.

CONTROLLER TO IC-706MKIIG

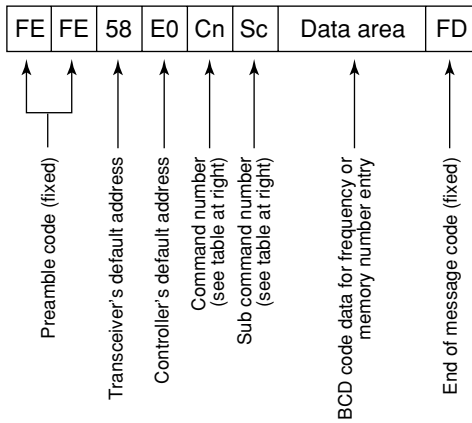

OK MESSAGE TO CONTROLLER

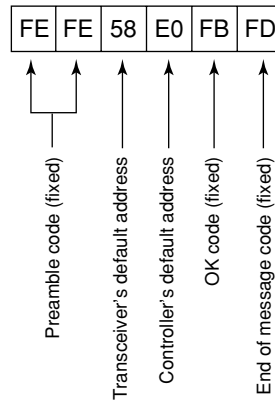

IC-706MKIIG TO CONTROLLER

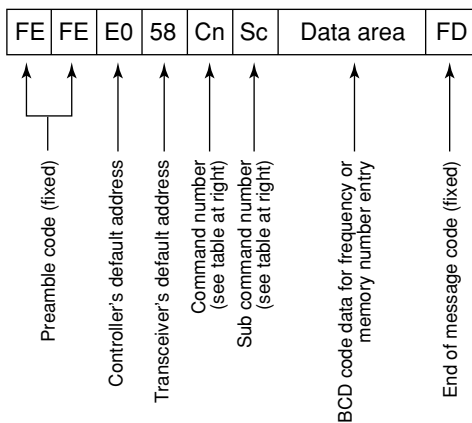

NG MESSAGE TO CONTROLLER

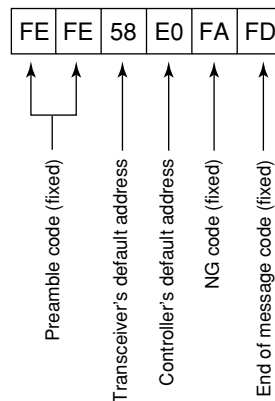

COMMAND TABLE

Cn	Sc	Description
00	—	Send frequency data
01	xx	Send mode data
02	—	Read band edge frequencies
03	—	Read display frequency
04	—	Read display mode
05	—	Set frequency data
06	00* ¹	Set LSB
	01* ¹	Set USB
	02* ¹	Set AM
	03* ¹	Set CW
	04* ¹	Set RTTY
	05* ¹	Set FM
	06* ¹	Set WFM
07	—	Set to VFO
	00	Set to VFO A
	01	Set to VFO B
	A0	VFO A=B
	B0	Switch VFO A and B
08	—	Set to memory mode
	mc* ²	Mch
09	—	Memory write
0A	—	Memory to VFO
0B	—	Memory clear
0C	—	Read duplex offset frequency
0D	—	Set duplex offset frequency

*¹When wide or normal operation is available, add "00" for wide operation or "01" for normal operation; when normal or narrow operation is available, add "00" for normal operation or "01" for narrow operation; when wide, normal and narrow operation is available, add "00" for wide operation, "01" for normal operation and "02" for narrow operation.

*²Memory channel number 1A=0100/1b=0101, 2A=0102/2b=0103, 3A=0104/3b=0105, C1=0106, C2=0107.

Cn	Sc	Description
0E	00	Scan stop
	01	Scan start
0F	00	Split OFF
	01	Split ON
	10	Simplex mode
	11	Duplex mode
10	12	Duplex + mode
	00	10 Hz TS
	01	100 Hz TS
	02	1 kHz TS
	03	5 kHz TS
	04	9 kHz TS
	05	10 kHz TS
	06	12.5 kHz TS
	07	20 kHz TS
	08	25 kHz TS
09	100 kHz TS	
11	xx	ATT ON/OFF; 00=OFF; 20=ON
15	01	Read squelch condition
	02	Read S-meter level
16	02	Preamp setting
	12	AGC setting
	22	NB setting
	42	TONE setting
	43	TSQL setting
	44	COMP setting
	46	VOX setting
47	BK-IN setting	
19	00	Read transceiver ID code

■ General

Set mode is used for programming infrequently changed values or conditions of functions. The IC-706MKIIG has 2 separate set modes: *quick set mode* and *initial set mode*.

◇ Quick set mode operation

- ① While power is ON, push [DISPLAY] for 2 sec.
 - Quick set mode is selected and one of its items appears.
 - Quick set mode items vary depending on the operating mode (SSB, FM, etc.) selected.
- ② Push [MENU] one or more times to select the desired item.
 - [M-CH] or [▲]/[▼] can also be used.
- ③ Rotate the main dial to set the values or conditions for the selected item.
- ④ Repeat steps ② and ③ to set other items.
- ⑤ To exit quick set mode, push [DISPLAY] momentarily.

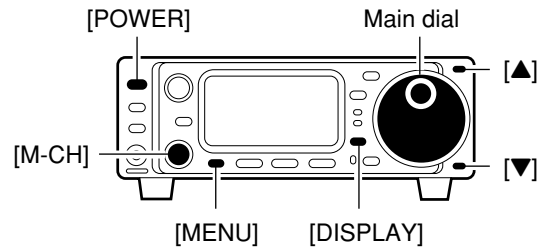

[DISPLAY EXAMPLE: QUICK SET MODE]

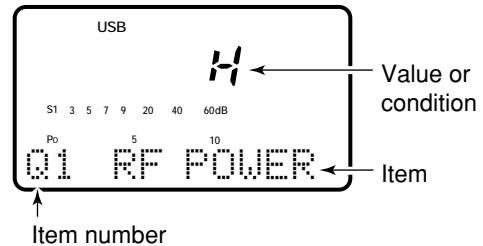

◇ Initial set mode operation

- ① Push [POWER] for 2 sec. to turn power OFF.
- ② While pushing [LOCK] push [POWER] to turn power ON.
 - Initial set mode is selected and one of its items appears.
- ③ Push [MENU] one or more times to select the desired item.
 - [M-CH] or [▲]/[▼] can also be used.
- ④ Rotate the main dial to set the values or conditions for the selected item.
- ⑤ Repeat steps ③ and ④ to set other items.
- ⑥ To exit initial set mode, push [POWER] for 2 sec. to turn power OFF.
- ⑦ Push [POWER] to turn power ON again.
 - The conditions selected in initial set mode are now effective.

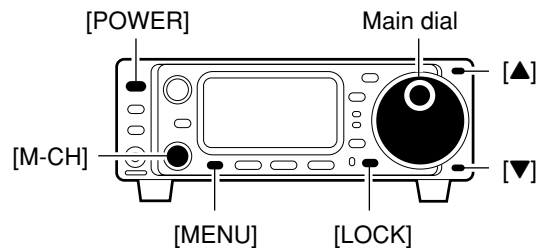

[DISPLAY EXAMPLE: INITIAL SET MODE]

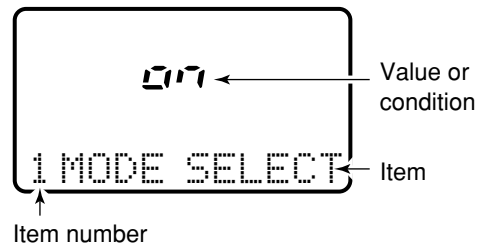

■ Quick set mode items

<p>Q1 RF POWER (all modes)</p> <p>This item adjusts the RF output power. The RF output power can be adjusted from L, 1 to 9 and H for indication, however, it can be adjusted continuously.</p>	H	<p>The default is H (maximum power). Note that while adjusting the output power, the power meter is displayed automatically.</p>
<p>Q2 MIC GAIN (SSB/AM/FM only)</p> <p>This item adjusts microphone gain from 1 to 10 for indication, however, it can be adjusted continuously.</p>	5	<p>The default is 5. Note that while adjusting mic gain, the ALC meter is displayed automatically.</p>
<p>Q2 CW PITCH (CW only)</p> <p>This item adjusts the CW pitch. CW pitch is adjustable from 300 to 900 Hz in 10 Hz steps.</p>	CW 600	<p>The default is 600 Hz.</p>
<p>Q2 RTTY TONE (RTTY only)</p> <p>This item selects the RTTY tone. RTTY tone is toggled between 1275, 1615 and 2125 Hz.</p>	RTTY 2125	<p>The default is 2125 Hz.</p>
<p>Q3 VOX DELAY (SSB/AM/FM only)</p> <p>This item adjusts the VOX (Voice-activated Transmit) delay time. The delay time can be adjusted from 0 to 2 sec. in 0.1 sec. units.</p>	USB 1.0	<p>The default is 1.0 seconds.</p>
<p>Q3 BK-IN DELAY (CW only)</p> <p>This item adjusts break-in delay time for CW semi break-in operation. The delay time is selectable from 2.0 to 13.0 (dots).</p>	CW 7.5	<p>The default is 7.5 dots.</p>
<p>Q3 RTTY SHIFT (RTTY only)</p> <p>This item adjusts the RTTY shift. There are 3 selectable values: 170, 200 and 425 Hz.</p>	RTTY 170	<p>The default is 170 Hz.</p>
<p>Q4 VOX GAIN (SSB/AM/FM only)</p> <p>This item adjusts the VOX gain for the VOX (voice activated transmit) function.</p>	USB 5	<p>The default is 5.</p>
<p>Q4 RTTY KEYING (RTTY only)</p> <p>This item adjusts the RTTY keying. Normal or reverse keying can be selected.</p>	RTTY n	<p>The default is "n," normal. Normal : key open=mark Reverse : key open=space</p>

04 CW PADDLE (CW only)

This item adjusts the CW paddle type. Four selections are available.

- n : normal (for electronic keyer use)
- r : reverse (for electronic keyer use)
- buG : When using the electronic key, key down produces a “dash,” releasing the key automatically produces a “dot(s).”
- oFF : Turns OFF the electronic keyer (for straight key use)
- ud : For using the microphone’s [UP]/[DN] keys instead of the CW paddle.

CW

n

The default is “n,” normal.

05 ANTI VOX (SSB/AM/FM only)

This item adjusts the ANTI-VOX gain for the VOX (voice activated transmit) function.

USB

5

The default is 5.

05 KEY SPEED (CW only)

This item adjusts the CW key speed. The key speed can be selected from 6 to 60 wpm.

CW

20

The default is 20 wpm.

06 CARRIER FREQ (SSB only)

This item adjusts the carrier frequency (BFO frequency), allowing you to change the audio characteristics. Selectable values are –200 to +200 Hz in 10 Hz steps.

USB

0

The default is 0 Hz.

06 RATIO (CW only)

This item adjusts the CW key ratio (or weight). The ratio can be selected from 2.8 to 4.5.

CW

3.0

The default is 3.0.

06 RPTR TONE (FM only)

This item selects a subaudible tone for FM-T mode operation to access a repeater. There are 50 tones available from 67.0 Hz to 254.1 Hz (see table at right).

FM

88.5

The default is 88.5 Hz.

• Available subaudible tones

Unit: Hz

67.0	79.9	94.8	110.9	131.8	156.7	171.3	186.2	203.5	229.1
69.3	82.5	97.4	114.8	136.5	159.8	173.8	189.9	206.5	233.6
71.9	85.4	100.0	118.8	141.3	162.2	177.3	192.8	210.7	241.8
74.4	88.5	103.5	123.0	146.2	165.5	179.9	196.6	218.1	250.3
77.0	91.5	107.2	127.3	151.4	167.9	183.5	199.5	225.7	254.1

07 TONE SOL (FM only)

This item adjusts sets a subaudible tone for tone squelch use. (the same subaudible tone frequencies as for repeater operation are available—see above).

FM

88.5

The default is 88.5 Hz.

08 RPTR-T SCN (repeater tone scan)

During repeater operation, you can detect the tone frequency necessary to open a repeater (see p. 30).

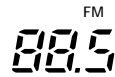

The default is 88.5 Hz.

08 T-SQL SCN (tone squelch tone scan)

During tone squelch operation, you can detect the tone frequency necessary to communicate using tone squelch (see p. 31).

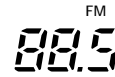

The default is 88.5 Hz.

■ Initial set mode items

1 MODE SELECT (all modes)

This item is available in all modes, and allows you to simplify operation by inhibiting the selection of unneeded operating modes during normal operation. For example if you are operating mobile and only plan on using FM and AM modes, use "MODE SELECT" to inhibit access to all other modes (SSB, CW, RTTY, WFM), thereby making selection of AM or FM quick and easy.



The default is on for all operating modes. To toggle an operating mode on or off, push (or push and hold) [MODE] one or more times until the desired mode is displayed, then rotate the main dial to set on or off.

2 BEEP (confirmation beep)

A beep sounds each time a switch is pushed to confirm it. This function can be turned OFF for silent operation.



Confirmation beep ON (default)



Confirmation beep OFF

3 BAND BEEP (band beep)

A beep sounds when an operating frequency enters or exits a transmit frequency range. This functions independent of the confirmation beep setting (above).



Band beep ON (default)

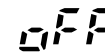

Band beep OFF

4 BACK LIGHT (display backlighting)

The function display backlighting can be set to high, low or OFF to suit ambient lighting.



Display backlighting set to high (default).



Display backlighting set to low.

5 KEY LIGHT (key/switch backlighting)

The key/switch backlighting can be set to high, low or OFF to suit ambient lighting.



Display backlighting set to high (default).



Display backlighting set to low.

7 SET MODE

6 AUTO OFF (auto power OFF)

The auto power OFF function can be used to automatically turn the transceiver OFF after a specified time of operation. This item can be set to 30 min., 60 min., 90 min., 120 min., or OFF.

OFF

Auto power OFF deactivates. (default)

20

Auto power OFF set to 20 min.

7 RF/SQL (SQL/AUTO/RF•SQL)

The [RF/SQL] control can be set as the squelch control (default), the RF/squelch control (USA version default) or automatic (acts as squelch in FM/WFM/AM modes; as RF in SSB/CW/RTTY modes). (See p. 22)

RF

The [RF/SQL] control functions as RF gain control only.

Note: RF gain does not function in WFM mode

SQL

The [RF/SQL] control functions as squelch control only.

8 SUBDIAL (Subdial function)

When this item is set to "rit," pushing [RIT/SUB] turns the RIT function ON (lights red)—rotating [M-CH] changes the RIT frequency; when this item is set to "Freq," pushing [RIT/SUB] turns the sub dial function ON (lights green)—rotating [M-CH] changes the operating frequency. Note that in FM, WFM and AM modes, pushing [RIT/SUB] always selects the sub dial function (lights green), regardless of this setting.

rit

Pushing [RIT/SUB] selects the RIT function (default).

FREQ

Pushing [RIT/SUB] selects the sub dial function.

9 OPT. FIL 1 (optional filter)

When an optional filter is installed, this selection is necessary, otherwise the filters cannot be selected. Selections available are FL-100, FL-101, FL-103, FL-223, FL-232 and none (default). See p. 22 for usable filters for each mode and see p. 60 for filter installation.

no

No filters are selected (default).

FL -223

FL-223 (for LSB/USB mode) is selected.

10 OPT. FIL 2 (optional filter)

When an optional filter is installed, this selection is necessary, otherwise the filters cannot be selected. Selections available are FL-100, FL-101, FL-103, FL-223, FL-232 and none (default). See p. 22 for usable filters for each mode and see p. 60 for filter installation.

no

No filters are selected (default).

FL -223

FL-223 (for LSB/USB mode) is selected.

11 PEAK HOLD (peak hold)

When the peak hold function is ON, the highest activated segment of the meter remains visible for 0.5 sec.; when OFF, the meter functions normally.

on

Peak hold ON (default)

OFF

Peak hold OFF

12 QUICK SPLIT (quick split function)

When this item is set to ON, pushing [SPL] for 2 sec. sets the undisplayed VFO frequency to the displayed VFO frequency plus the split offset or duplex offset, and activates split operation.

on

Quick split function ON (default).

off

Quick split function OFF.

13 SPLIT LOCK (split lock)

When this item is ON the main dial can be used to adjust the transmit frequency (XFC) even while the lock function is activated.

off

Split lock function OFF (default)

on

Split lock function ON

14 SPL OFFSET (split offset)

This item sets the offset (difference between transmit and receive frequencies) for the quick split function. Note that this setting is not valid in FM/WFM modes.

0.000

Default is 0.100 MHz.

15 DUP HF (duplex offset)

This item sets the offset for the duplex function when operating on the HF bands.

0.100

Default is 0.100 MHz.

16 DUP 50M (duplex offset)

This item sets the offset for the duplex function when operating on the 50 MHz band.

0.500

Default is 0.500 MHz.

17 DUP 144M (duplex offset)

This item sets the offset for the duplex function when operating on the 144 MHz band.

0.600

Default is 0.600 MHz.

18 DUP 430M (duplex offset)

This item sets the offset for the duplex function when operating on the 430 MHz band.

5.000

Default is 5.000 MHz.

19 1TOUCH RPTR (one touch repeater)

This item sets the offset direction when using the one-touch repeater function. +duplex or -duplex can be selected.

DUP--

Duplex direction is set to -duplex.

DUP+

Duplex direction is set to +duplex.

7 SET MODE

20 AUTO RPTR (auto repeater)

When this item is set to “on 1”, the tone encoder is not set when the auto repeater is activated; when set to “on 2” the auto repeater function also sets the tone encoder on.

OFF

Auto repeater function OFF (default).

on 1

Auto repeater function ON, tone encoder OFF.

21 SCAN RESUME (scan resume)

This item sets the scan resume function ON or OFF. *ON*: scan resumes 10 sec. after stopping on a signal (or 2 sec. after a signal disappears); *OFF*: scan does not resume after stopping on a signal. For the priority watch, setting to OFF pauses the watch until signal disappears and scan resumes.

on

Scan resume function is turned ON (default).

OFF

Scan resume function is turned OFF.

22 SCAN SPEED (scan speed)

This item sets the rate at which channels or frequencies are scanned during scan operations. High or low can be selected.

H I

Scan speed is set to high (default).

Lo

Scan speed is set to low.

23 U/D SPEED (up/down speed)

This item sets the rate at which frequencies are scanned through when the [UP]/[DN] switches are pushed and held. High or low can be selected.

H I

Up/down speed is set to high (default).

Lo

Up/down speed is set to low.

24 AM NB (Noise blanker in AM mode)

When this item is set to ON, the noise blanker function is available in AM mode. This is useful when communicating in AM mode (the noise blanker function should not be used when listening to regular AM broadcasts as it may degrade the received audio).

on

Noise blanker available (default)

OFF

Noise blanker not available

25 PAD CH (available memo pads)

This item sets the number of memo pad channels available. 5 or 10 memo pads can be set.

5

5 memo pads are available (default).

10

10 memo pads are available.

26 PWR ON CHK (Power on check)

When this item is set to “on,” the set output power is briefly displayed when turning power ON (RIT and auto power off settings are also displayed if activated); when turned “oFF,” the display goes directly to frequency indication at power ON.

on

Power on check ON (default)

OFF

Power on check OFF

27 A-TUNE STRT (auto tuner start)

The optional AT-180 ANTENNA TUNER has an automatic start capability which starts tuning if the SWR is higher than 1.5–3.

When “oFF” is selected, the tuner remains OFF even when the SWR is poor (1.5–3).

When “on” is selected, automatic tune starts even when the tuner is turned OFF.

oFF

Auto tune function OFF (default).

on

Auto tune function ON.

Note: Even when “on” is selected, automatic tune does not start for the 50 MHz band.

28 PTT TUNE (PTT tune function)

When an optional AH-4 ANTENNA TUNER is connected, tuning can be started automatically at the moment the PTT is pushed.

oFF

Tuning starts only when [TUNER] is pushed (default).

on

Tuning starts when pushing [PTT] on a new frequency.

29 9600 MODE (Data socket speed)

This is used to change the communications speed packet operation. The data socket can be set to 1200 or 9600 baud.

9600

Default is 9600 baud.

30 VSEND SEL (ACC socket output)

“on”: VSEND is for 144/430 MHz; HSEND is for the HF/50 MHz

“U only”: VSEND is for 430 MHz; HSEND is for HF/50/144 MHz

“oFF”: VSEND is not used; HSEND is for all bands.

on

The default is VSEND is for the 144/430 MHz band; HSEND is for the HF/50 MHz band.

31 SPEECH LANG (voice synthesizer language)

When the optional UT-102 VOICE SYNTHESIZER UNIT is installed, you can select between English and Japanese as the language.

EnG

Voice synthesizer functions in English (default).

Jpn

Voice synthesizer functions in Japanese.

32 SPEECH SPD (voice synthesizer speed)

When the optional UT-102 VOICE SYNTHESIZER UNIT is installed, you can select between faster or slower synthesizer output.

Hl

Voice synthesizer output is faster (default).

Lo

Voice synthesizer output is slower.

33 S-LVL SPOH (S-level speech)

When an optional UT-102 SPEECH SYNTHESIZER UNIT is installed, the synthesizer can be set to read out the frequency/mode only, or both the frequency/mode and S-meter level.

on

Voice synthesizer reads out both the frequency/mode and S-meter level (default).

off

Voice synthesizer reads out the frequency/mode only.

34 CI-V ADDRESS (CI-V address)

To distinguish equipment, each CI-V transceiver has its own Icom standard address in hexadecimal code. The IC-706MKIIG's address is 4EH.

When 2 or more IC-706MKIIG's are connected to an optional CT-17 CI-V LEVEL CONVERTER, rotate the main dial to select a different address for each IC-706MKIIG in the range 01H to 7FH.

58H

Address set to 58H (default).

7FH

Address set to 7FH.

35 CI-V BAUD (CI-V data rate)

This item sets the data transfer rate. When "Auto" is selected, the baud rate is automatically set according to the connected controller or remote controller.

Auto

Auto baud rate (default)

19200

19200 bps

36 CI-V TRN (CI-V transceive)

Transceive operation is possible with the IC-706MKIIG connected to other Icom HF transceivers or receivers. When "on" is selected, changing the frequency, operating mode, etc. on the IC-706MKIIG automatically changes those of connected transceivers (or receivers) and vice versa.

on

Transceive ON (default)

off

Transceive OFF

37 CI-V 731 (CI-V operating frequency data length)

When connecting the IC-706MKIIG to the IC-735 for transceive operation, you must change the operating frequency data length to 4 bytes.

- This item MUST be set to "on" only when operating transceiver with the IC-735.

off

Frequency data set to 5 bytes (default).

on

Frequency data set to 4 bytes.

■ Fuse replacement

If a fuse blows or the transceiver stops functioning, try to find the source of the problem, and replace the damaged fuse with a new, rated fuse.

Caution: Disconnect the DC power cable from the transceiver when changing a fuse.

The IC-706MKIIG has 2 types of fuses installed for transceiver protection.

- DC power cable fuses 30 A
- Circuitry fuse F.G.M.B. 125 V 4 A

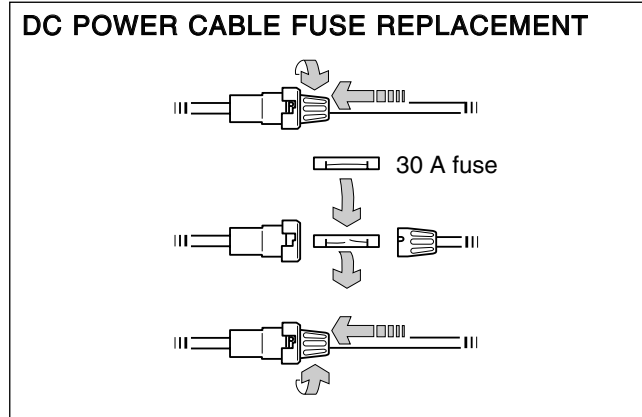

CIRCUITRY FUSE REPLACEMENT

The 13.8 V DC from the DC power cable is applied to all units in the IC-706MKIIG, except for the power amplifier, through the circuitry fuse. This fuse is installed in the PA unit.

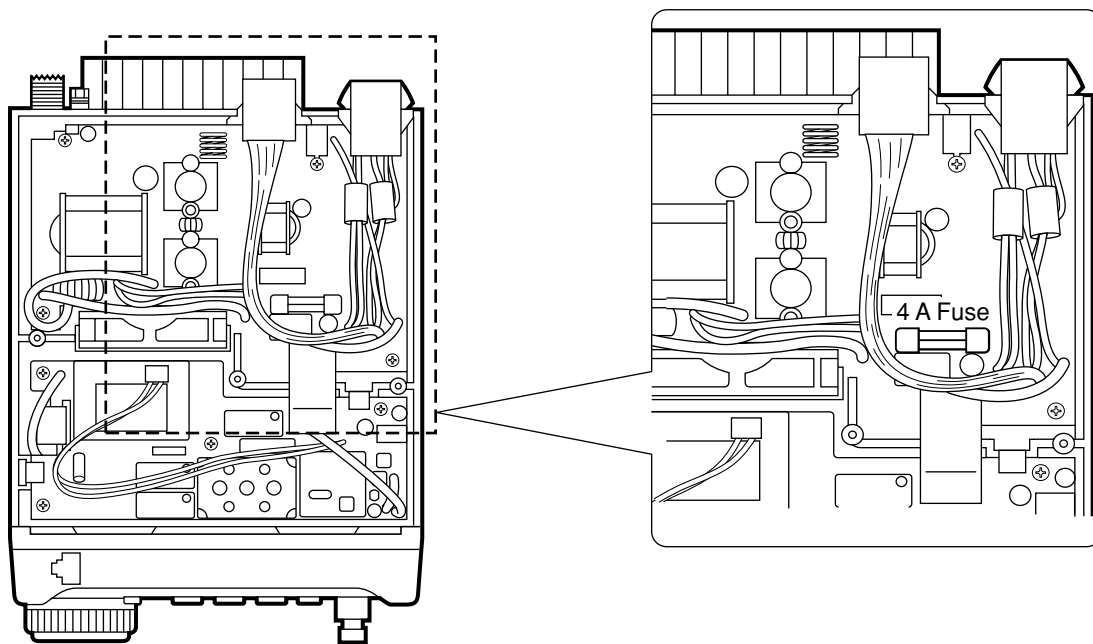

■ Memory backup

All of the CPU's memory is backed up by an EEPROM (Electrically-Erasable Programmable Read-Only Memory). All data you set, such as VFO, memory, set mode contents, etc. is stored in this EEPROM. There is no internal lithium battery.

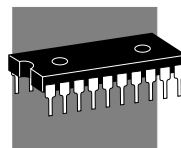

■ Cleaning



If the transceiver becomes dusty or dirty, wipe it clean with a dry, soft cloth.



AVOID the use of strong chemical solvents such as thinner, benzene or alcohol to clean the transceiver. These may damage the transceiver's surfaces.

The following chart is designed to help you correct problems which are not equipment malfunctions.

If you are unable to locate the cause of a problem or solve it through the use of this chart, contact your nearest Icom Dealer or Service Center.

	PROBLEM	POSSIBLE CAUSE	SOLUTION	REF.
POWER SUPPLY	Power does not come on when the [POWER] switch is pushed.	<ul style="list-style-type: none"> • DC power cable is improperly connected. • Fuse is blown. • Battery is exhausted if you are using a 12 V battery as the power source. 	<ul style="list-style-type: none"> • Reconnect the power cable correctly. • Check for the cause, then replace the fuse with a spare one. (Fuses are installed in two places. One is installed in the DC power cable and the other is installed in the PA unit.) • Check the battery voltage with the [POWER] pushed IN. 	<p>p. 13</p> <p>p. 56</p> <p>—</p>
	No sound comes from the speaker.	<ul style="list-style-type: none"> • Volume level is set too low. • The squelch is closed. • The transceiver is in the transmitting condition. • An external speaker or headphones are connected. 	<ul style="list-style-type: none"> • Rotate [AF] clockwise to obtain a suitable listening level. • Rotate [SQL] counterclockwise to open the squelch. • Release [PTT] on the microphone or check the SEND line of an external unit, if connected. • Check the external speaker or headphone plug connection. • Check the speaker ON/OFF switch or speaker A/B switch, when an optional SP-20 EXTERNAL SPEAKER is in use. 	<p>p. 1</p> <p>p. 1</p> <p>—</p> <p>p. 12</p> <p>p. 12</p>
RECEIVE	Sensitivity is low.	<ul style="list-style-type: none"> • The antenna is not connected properly. • The antenna feed line is cut or shorted. • The antenna for another band is selected. • The antenna is not properly tuned. • The attenuator function is activated. 	<ul style="list-style-type: none"> • Reconnect to the antenna connector. • Check the feed line and correct any improper conditions. • Select an antenna suitable for the operating frequency. Make sure that [ANT1] is used for frequencies less than 60 MHz and [ANT2] is used for frequencies of 60 MHz and above. • Push [TUNE] to manually tune the antenna. • Push [ATT] to turn the function OFF. 	<p>—</p> <p>—</p> <p>p. 14</p> <p>pgs. 27, 28</p> <p>p. 21</p>
	Receive audio is distorted.	<ul style="list-style-type: none"> • The operating mode is not selected correctly. • The [SHIFT] control is set off-center. 	<ul style="list-style-type: none"> • Select a suitable operating mode. • Set [SHIFT] to the center position. 	<p>p. 19</p> <p>p. 20</p>
	Receive signal is distorted with strong signals.	<ul style="list-style-type: none"> • Noise blanker function is activated. • Preamp is activated. 	<ul style="list-style-type: none"> • Push [NB] to turn the function OFF. • Push [P.AMP] to turn the function OFF. 	<p>p. 21</p> <p>p. 21</p>

	PROBLEM	POSSIBLE CAUSE	SOLUTION	REF.
TRANSMIT	Transmitting is impossible.	<ul style="list-style-type: none"> The operating frequency is not set to a ham band. 	<ul style="list-style-type: none"> Set the frequency to a ham band. 	p. 17
	Output power is too low.	<ul style="list-style-type: none"> Power is set to a lower power than maximum. Microphone gain is set too low. The antenna is not connected properly. The antenna feed line is cut or shorted. An antenna for another band is selected. The antenna is not properly tuned. 	<ul style="list-style-type: none"> Set the output power in quick set mode. Set microphone gain to a suitable position using quick set mode. Reconnect the antenna connector. Check the feed line and correct any improper conditions. Select an antenna suitable for the operating frequency. Push [TUNE] to manually tune the antenna when an optional antennal tuner is connected. 	<p>p. 44</p> <p>p. 44</p> <p>—</p> <p>—</p> <p>p. 14</p> <p>pgs. 27, 28</p>
	No contact possible with other stations.	<ul style="list-style-type: none"> RIT function is activated. Split function is activated. 	<ul style="list-style-type: none"> Push RIT to turn the function OFF. Push [SPLIT] to turn the function OFF. 	<p>p. 20</p> <p>p. 29</p>
	Repeater cannot be accessed.	<ul style="list-style-type: none"> Split function is not activated. An incorrect transmit frequency is set. Subaudible tone encoder is OFF and repeater requires a tone for access. Programmed subaudible tone frequency is wrong. 	<ul style="list-style-type: none"> Push [DUP] to turn the function ON. Set the proper frequencies into VFO A and B or into one of the memory channels. Use [TON] to select FM-T. Program the required frequency using quick set mode. 	<p>p. 29</p> <p>p. 17</p> <p>p. 30</p> <p>p. 49</p>
	Transmitted signals are distorted.	<ul style="list-style-type: none"> Microphone gain is set too high. [COMP LEVEL] is rotated too far clockwise with the speech compressor ON. 	<ul style="list-style-type: none"> Set gain in quick set mode. Set [COMP LEVEL] to a suitable position. 	<p>p. 48</p> <p>p. 5</p>
DISPLAY	Displayed frequency does not change properly.	<ul style="list-style-type: none"> The dial lock function is activated. The internal CPU has malfunctioned. 	<ul style="list-style-type: none"> Push [LOCK] to deactivate the function. Reset the CPU. (While pushing [UP] and [DN] push [POWER] to turn power ON. 	<p>p. 2</p> <p>p. 15</p>
SCAN	Programmed scan does not stop.	<ul style="list-style-type: none"> Squelch is open. 	<ul style="list-style-type: none"> Set squelch to the threshold position. 	p. 23
	Programmed scan does not start.	<ul style="list-style-type: none"> The same frequencies have been programmed in scan edge memory channels. 	<ul style="list-style-type: none"> Program different frequencies into scan edge memory channels. 	p. 44
	Memory scan does not start.	<ul style="list-style-type: none"> 2 or more memory channels have not been programmed. 	<ul style="list-style-type: none"> Program 2 or more memory channels. 	p. 41
	Memory select scan does not start.	<ul style="list-style-type: none"> 2 or more memory channels have not been designated as select channels. 	<ul style="list-style-type: none"> Designate 2 or more memory channels as select channels for the scan. 	p. 44

10 OPTIONAL INSTALLATIONS/SETTINGS

■ Opening the transceiver case

To remove the transceiver case unscrew the 10 screws (5 in the top panel and 5 in the bottom panel) as shown in the diagram below.

Caution: Disconnect the DC power cable from the transceiver before performing any work on the transceiver.

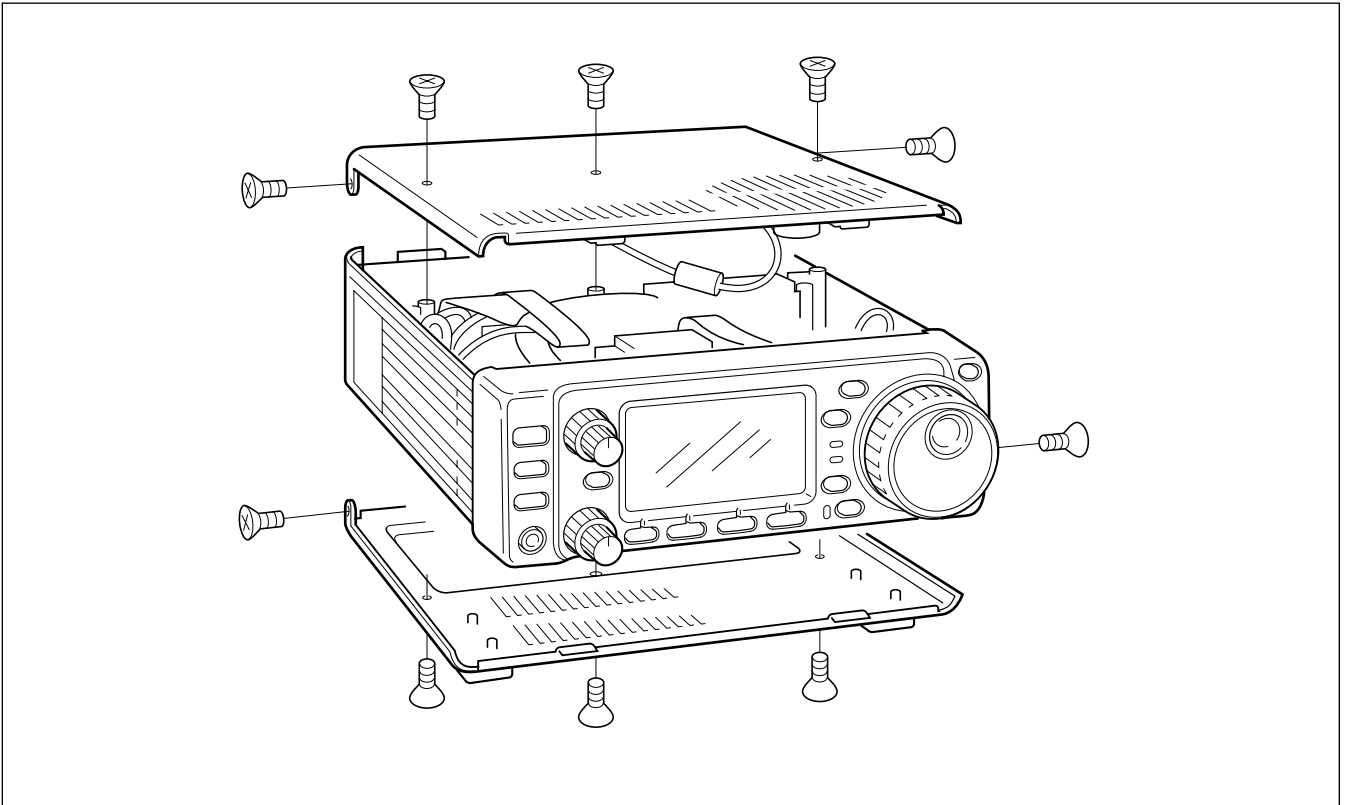

■ UT-102 VOICE SYNTHESIZER UNIT

The UT-102 announces the accessed band's frequency, mode, etc. (S-meter level can also be announced—p. 55) in a clear, electronically generated voice, in English (or Japanese).

- ① Remove the top cover as shown above.
- ② Connect the UT-102 as shown in the diagram at right (label side up).
- ③ Replace the top cover.

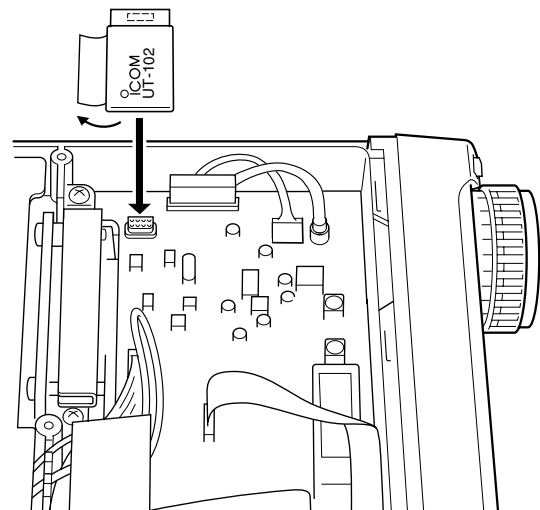

■ CR-282 HIGH-STABILITY CRYSTAL UNIT

By installing the CR-282, the total frequency stability of the transceiver will be improved.

CR-282 frequency stability: ± 0.5 ppm
 (−30°C to +60°C;
 −22°F to +140°F)

- ① Remove the bottom cover as shown on the opposite page.
- ② Remove the 5 screws and 2 flat cables holding the PLL unit in place.
- ③ Remove the existing crystal unit.
- ④ Put the CR-282 in the space available as shown in the diagram.
- ⑤ Adjust the reference frequency at L601 using a frequency counter (60.00000 MHz).
- ⑥ Return the shield case and bottom cover to their original positions.

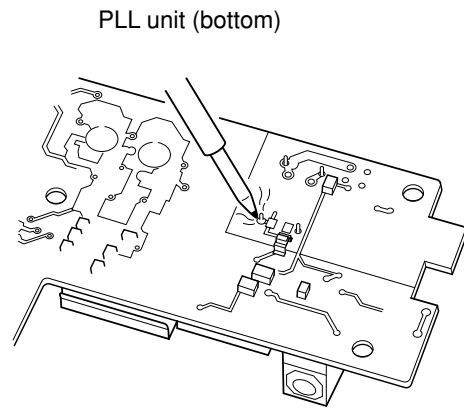
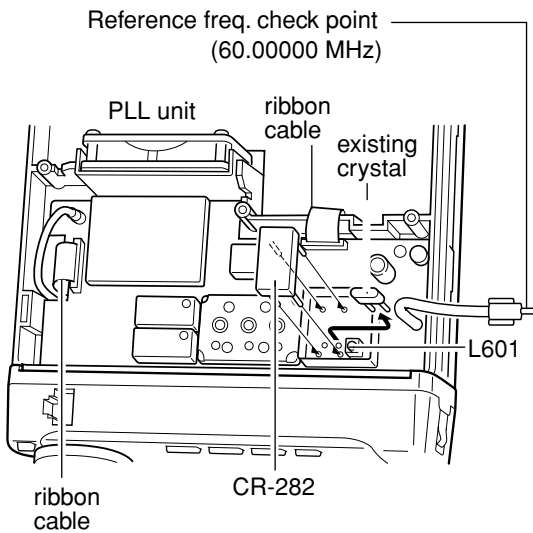

■ IF filters

Several IF filters are available for the IC-706MKIIG. Choose a filter most appropriate to your operating needs.

Note: After filter installation, specify the installed filter using initial set mode (items 9, 10). Otherwise, the installed filter will not function properly.

FL-100 CW NARROW FILTER	500 Hz/−6 dB
FL-101 CW NARROW FILTER	250 Hz/−6 dB
FL-103 SSB WIDE FILTER	2.8 kHz/−6 dB
FL-223 SSB NARROW FILTER	1.9 kHz/−6 dB
FL-232 CW/RTTY NARROW FILTER	350 Hz/−6 dB

- ① Remove the top cover as shown on the previous page.
- ② Install the desired filter as shown in the diagram below.
 - These filters can be installed in either direction.
- ③ Replace the top cover.

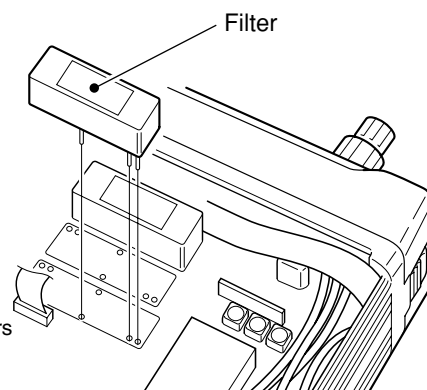

Spaces for 2 optional filters available.

■ UT-106 DSP RECEIVER UNIT

◇ Installation

- ① Open the transceiver case as shown on p. 59.
- ② Remove the 4-pin connector (P251) from J1413 on the MAIN unit (top side) and plug it into J1 of the UT-106 on the PLL unit (bottom side).
- ③ Plug the 4-pin connector (P1) from the UT-106 into J1413 on the MAIN unit.
- ④ Plug the supplied ribbon cable into J3 on the UT-106 and J253 on the PLL unit.
 - Be careful of the orientation of the ribbon cable.
- ⑤ Attach the UT-106 to the PLL unit, using the existing guide for alignment, as illustrated at right.
- ⑥ Reassemble the transceiver.

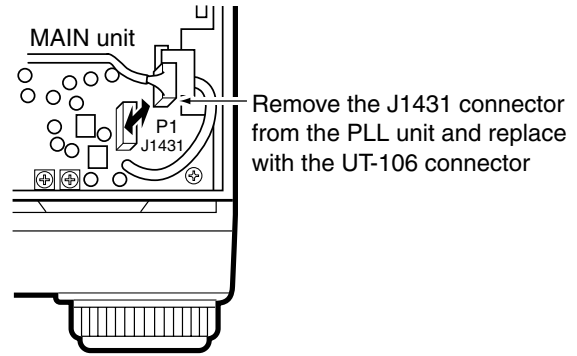

◇ Operation

Refer to the instructions supplied with the UT-106 for operating details.

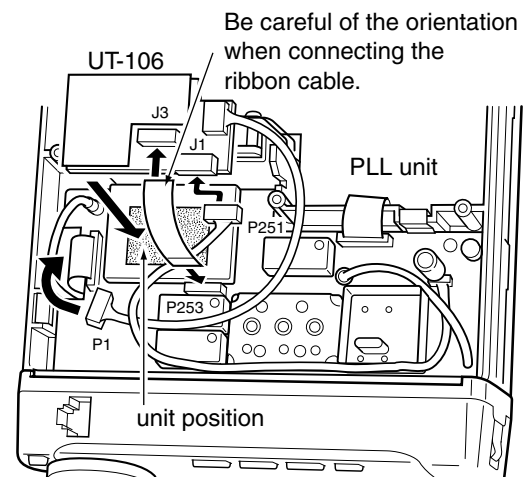

■ MB-72 CARRYING HANDLE

The optional MB-72 CARRYING HANDLE IS CONVENIENT when carrying the transceiver for DX'peditions, field operation, etc.

- ① Remove the 2 screws from the right side of the transceiver as shown below.
- ② Replace those with 2 supplied screws plus rubber

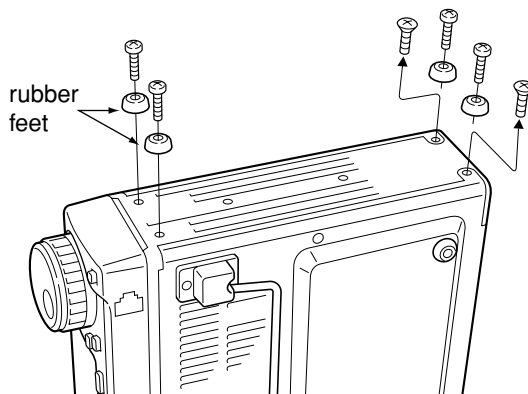

feet and additionally attach 2 more supplied screws (including rubber feet) as shown below.

- When replacing the 2 screws at the rear, be sure to squeeze the top and bottom covers together to ensure proper alignment.

- ③ Attach the MB-72 to the left side of the transceiver as shown below.

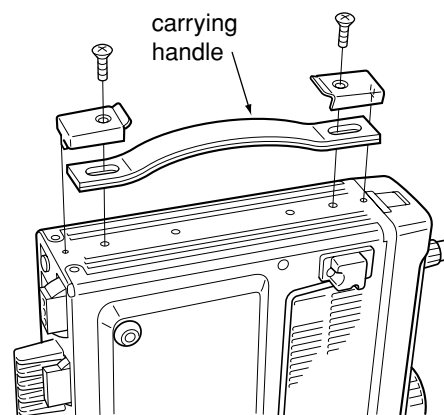

■ AT-180 internal switch description

The optional AT-180 has 3 operating conditions for HF band operation. Select a suitable condition according to your antenna system.

- ① Remove the top cover of the AT-180.
- ② Set the tuner switches to the desired positions according to the table below.

SW	Position	Operation
S1	A (default)	The tuner operating condition is set by S2 described below.
	B	THROUGH INHIBIT The tuner tunes the antenna even when the antenna has poor SWR (up to VSWR 3:1 after tuning). In this case, manual tuning is necessary each time you change the frequency although the tuner automatically starts tuning when the VSWR is higher than 3:1. This setting is called "through inhibit," however, the tuner is set to "through" if the VSWR is higher than 3:1 after tuning.
S2	C	TUNER SENSITIVE CONDITION The tuner tunes each time you transmit (except SSB mode). Therefore, the lowest SWR is obtained at any given time. For SSB mode, the same condition as the "D" position.
	D (default)	NORMAL CONDITION The tuner tunes when the SWR is higher than 1.5:1. Therefore, the tuner activates only when tuning is necessary.

• Specifications for the AT-180

- Frequency coverage : 1.9–54 MHz
- Input impedance : 50 Ω
- Maximum input power : 120 W
- Minimum tuning power : 8 W
- Matching impedance : 16.7–150 Ω (HF band)
range 20–125 Ω (50 MHz band)
- Tuning accuracy : Less than SWR 1.5:1
- Insertion loss : Less than 1.0 dB
(after tuning)
- Power supply : 13.8 V DC/1 A (supplied from the transceiver's ACC socket)
- Dimensions (mm/in) : 167(W)×58.6(H)×225(D)
6⁹/₁₆(W)×2⁵/₁₇(H)×8⁷/₈(D)
- Weight : 2.4 kg; 5 lb 4 oz
- Supplied accessories : coaxial cable (1 m),
ACC cable (DIN 13 pins)

• AT-180 inside top cover

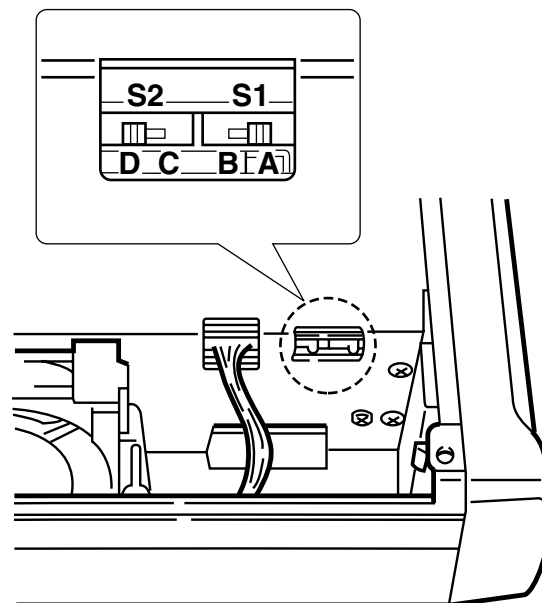

• Connector information for ACC(2) socket



PIN NO./NAME	DESCRIPTION
① 8 V	Regulated 8 V output. (10 mA max.)
② GND	Connects to ground.
③ SEND	Input/output pin. Goes to ground when transmitting (20 mA max). When grounded, transmits.
④ BAND	Band voltage output. (Varies with amateur band; 0 to 8.0 V).
⑤ ALC	ALC output voltage (–4 to 0 V).
⑥ NC	No connection.
⑦ 13.8V	13.8 V output when power is ON (1 A max).

11 INTERNAL VIEWS

◇ Top view

Caution:

The transceiver has been thoroughly tested and adjusted at the factory before being shipped. The transceiver warranty does not cover any problems caused by unauthorized internal adjustment.

- 430 MHz Tx power adj.
- 144 MHz Tx power adj.
- 50 MHz Tx power adj.
- HF Tx power adj.
- AM Tx carrier adj.
- ID APC adj.
- NB sensitivity adj.

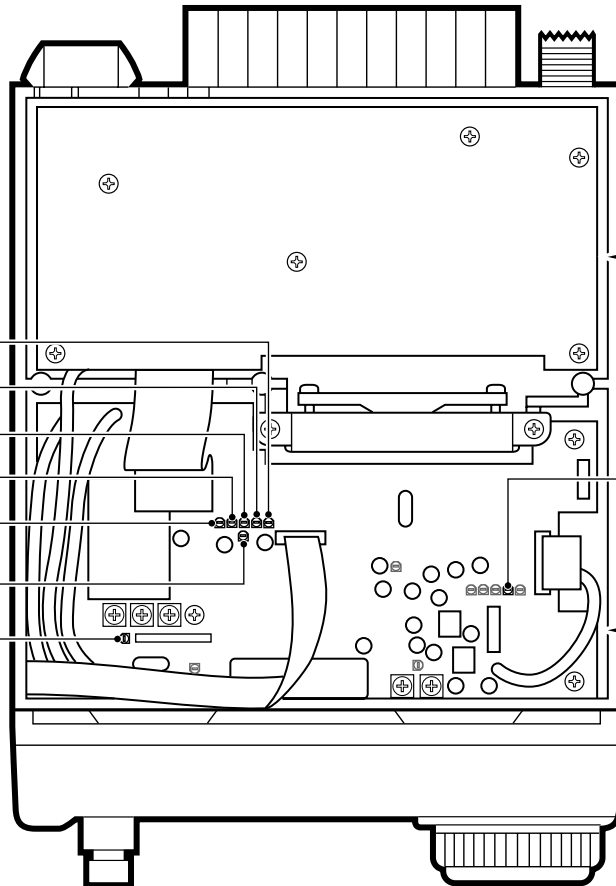

The internal speaker has been removed in this diagram for illustration purposes.

FILTER unit

FM deviation adj.

MAIN unit

◇ Bottom view

- 144/430 MHz Final amplifier (SRFJ7044)
- HF Final amplifier (SRFJ7044 x 2)

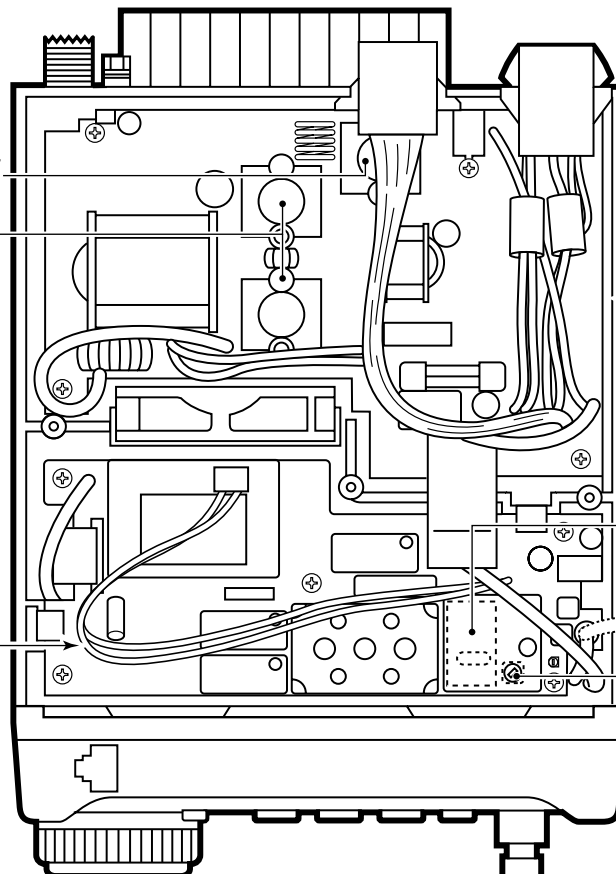

PA unit

Optional crystal (CR-282)

Reference freq. check point (60.000 MHz)

Reference freq. adj. (L601) (when optional crystal is installed)

PLL unit

IC-PW1 HF + 50 MHz 1 kW LINEAR AMPLIFIER

Full-duty 1 kW linear amplifier including an automatic antenna tuner. Has automatic tuning and band selection capability. Full break-in (QSK) operation is possible. The amplifier/power supply unit and the remote control unit are separated. The OPC-599 is necessary to connect the IC-706MKIIG to the IC-PW1.

AT-180 HF/50 MHz AUTOMATIC ANTENNA TUNER

Fully automatic antenna tuner with preset memories for each 100 kHz. Unique "automatic tuner on" function is available. See p. 62 for AT-180 specifications.

AH-4 HF AUTOMATIC ANTENNA TUNER

Specially designed to tune a long wire antenna for portable or mobile HF/50 MHz operation. The "PTT tune" function provides simple operation.

- Input power rating: 150 W

AH-2b ANTENNA ELEMENT

A 2.5 m long antenna element for mobile operation with the AH-3.

- Frequency coverage 3.5–28 MHz band with the AH-3

HM-118T HAND MICROPHONE

Includes DTMF keypad, hand microphone.

PS-85 DC POWER SUPPLY

Light weight switching regulator system power supply.

- Output voltage: 13.8 V DC
- Max. current drain: 20 A

SM-8 DESKTOP MICROPHONE

Including 2 connection cables for simultaneous connection of 2 transceivers. Has [UP]/[DOWN] switches. The OPC-589 is necessary to use this microphone.

SM-20 DESKTOP MICROPHONE

Includes [UP]/[DOWN] switches and a low cut function. The OPC-589 is necessary to use this microphone.

MB-62 MOBILE MOUNTING BRACKET

Mounts the transceiver main body, with or without the front panel, inside a vehicle.

MB-63 MOUNTING BRACKET

Metal plate for attaching the front panel to a wall or other such flat surface.

MB-65 MOUNTING BASE

Allows you to conveniently vehicle-mount the front panel of the IC-706MKIIG. An MB-63 must be used in combination with the MB-65.

12 OPTIONS

SP-7 EXTERNAL SPEAKER

Compact speaker for base station operation. Height can be adjusted for your convenience.

- Input impedance: 8 Ω
- Max. input power: 5 W

SP-10 EXTERNAL SPEAKER SP-12 EXTERNAL SPEAKER

SP-12 SP-10

External speakers suitable for mobile operation.

- SP-12: Slim-type; 8 Ω /3 W
- SP-10: Compact-type; 4 Ω /5 W

SP-20 EXTERNAL SPEAKER

Equipped with 4 types of audio filters, a headphone jack and can be connected to 2 transceivers.

- Input impedance: 8 Ω
- Max. input power: 5 W

SP-21 EXTERNAL SPEAKER

External speaker designed for base station operation.

- Input impedance: 8 Ω
- Max. input power: 5 W

CT-16 SATELLITE INTERFACE UNIT

Easy tuning when connecting another Icom

VHF transceiver for instant satellite communications.

CT-17 CI-V LEVEL CONVERTER UNIT

For remote transceiver control using a personal computer equipped with an RS-232C port. You can change frequencies, operating mode, memory channels, etc., via your computer.

OPC-581 SEPARATION CABLE OPC-587 SEPARATION CABLE

Provide front panel detached operation for mobile installations or compact transceiver operation.

- OPC-581: 3.5 m (11.5 ft)
- OPC-587: 5 m (16.4 ft)

OPC-589 MICROPHONE ADAPTER CABLE

Conversion between 8-pin modular and 8-pin metal connector for using a desktop microphone with the IC-706MKIIG.

PS-125 DC POWER SUPPLY

Light weight switching regulator system power supply.

- Output voltage: 13.8 V DC
- Max. current drain: 25 A

CR-282 HIGH-STABILITY CRYSTAL UNIT

Contains a temperature-compensating oven heater and crystal unit for frequency stability.

- Frequency stability: ± 0.5 ppm (-10°C to $+60^{\circ}\text{C}$; $+14^{\circ}\text{F}$ to $+140^{\circ}\text{F}$)

FL-100 CW NARROW FILTER (500 Hz/ -6 dB)

FL-101 CW NARROW FILTER (250 Hz/ -6 dB)

FL-103 SSB WIDE FILTER (2.8 kHz/ -6 dB)

FL-223 SSB NARROW FILTER (1.9 kHz/ -6 dB)

FL-232 CW/RTTY NARROW FILTER (350 Hz/ -6 dB)

Two of the above 5 filters can be installed at one time.

HM-103 HAND MICROPHONE

Standard hand microphone.

OPC-599 ADAPTER CABLE

13-pin, ACC connector to 7-pin + 8-pin ACC connector.

OPC-742 ACC 13-PIN CABLE

Required when using both the AT-180 and a 2 m linear amplifier.

MB-72 CARRYING HANDLE

Convenient when carrying the transceiver.

UT-102 VOICE SYNTHESIZER UNIT

UT-106 DSP RECEIVE UNIT

■ GENERAL

- Frequency coverage : Receive
 30 kHz–199.999999 MHz*
 400–470.000 MHz*
 Transmit
 1.800– 1.99999 MHz*
 3.500– 3.9999 MHz*
 7.000– 7.300 MHz*
 10.100– 10.150 MHz
 14.000– 14.350 MHz
 18.068– 18.168 MHz
 21.000– 21.450 MHz
 24.890– 24.990 MHz
 28.000– 29.700 MHz
 50.000– 54.000 MHz*
 144.000–148.000 MHz*
 430.000–450.000 MHz*
 *Depending on version.
- Mode : SSB, CW, AM, FM, WFM, RTTY
 (WFM is for receive only)
- Number of memory channels : 107 (split memory: 99; scan edges: 6; call channels: 2)
- Antenna connector : SO-239×2 (for HF/50 MHz and 144/430 MHz)/50 Ω
- Usable temperature range : –10°C to +60°C (+14°F to +140°F)
- Frequency stability : Less than ±7 ppm from 1 min. to 60 min. after power ON. After that, rate of stability change is less than ±1 ppm/hr. at +25°C (+77°F). Temperature fluctuations (0°C to +50°C; +32°F to +122°F) less than ±5 ppm.
- Power supply requirement : 13.8 V DC ±15% (negative ground)
- Current drain (at 13.8 V DC) : Transmit 20 A
 Receive squelched 1.8 A
 max. audio 2.0 A
- Dimensions : 167(W)×58(H)×200(D) mm
 6⁹/₁₆(W)×2⁵/₁₆(H)×7⁷/₈(D) in
 (projections not included)
- Weight : 2.45 kg (5 lb 6 oz)
- CI-V connector : 2-conductor 3.5 (d) mm (1/8")/8 Ω
- ACC connector : 13-pin

■ TRANSMITTER

- Output power :
 SSB, CW, FM, RTTY 5–100 W (1.8–50 MHz bands)
 5–50 W (144 MHz band)
 2–20 W (430 band)
 AM 2–40 W (1.8–50 MHz bands)
 2–20 W (144 MHz band)
 2–8 (430 band)
- Modulation system :
 SSB Balanced modulation
 AM Low level modulation
 FM Variable reactance modulation
- Spurious emissions : Less than –60 dB*
 *spurious freq.: below 30 MHz: –50 dB (typ.); above 50 MHz: –60 dB (typ.).
- Carrier suppression : More than 40 dB
- Unwanted sideband : More than 50 dB
- Microphone connector : 8-pin modular jack (600 Ω)
- KEY connector : 3-conductor 6.35 (d) mm (1/4")
- RTTY connector : 3-conductor 3.5 (d) mm (1/8")

■ RECEIVER

- Receive system :
 SSB, CW, AM, RTTY Double-conversion superheterodyne
 WFM
 FM Triple-conversion superheterodyne
- Intermediate frequencies:

MODE	1st	2nd	3rd
SSB	69.0115 MHz	9.0115 MHz	—
AM	69.0100 MHz	9.0100 MHz	—
AM-N	69.0115 MHz	9.0115 MHz	—
CW	69.0106 MHz	9.0106 MHz	—
RTTY	69.0105 MHz	9.0105 MHz	—
FM	69.0115 MHz	9.0115 MHz	455 kHz
FM-N	69.0100 MHz	9.0100 MHz	455 kHz
WFM	70.7000 MHz	10.7000 MHz	—

- Sensitivity (pre-amp ON):

Frequency range	SSB/CW	AM	FM	WFM
	10 dB S/N	10 dB S/N	12 dB SINAD	12 dB SINAD
0.5–1.8 MHz	—	13 μV	—	—
1.8–28 MHz	0.15 μV	2.0 μV	—	—
28–29.7 MHz			0.5 μV	—
50 MHz band	0.12 μV	1.0 μV	0.25 μV	—
76–108 MHz	—	—	—	10.0 μV
144/430 MHz bands	0.11 μV	1.0 μV	0.18 μV	—







- Squelch sensitivity (threshold; preamp ON) :
 SSB Less than 5.6 μV
 FM Less than 0.3 μV
- Selectivity* :
 SSB, CW, RTTY More than 3.0 kHz/–6 dB
 Less than 4.8 kHz/–60 dB
 AM/FM-N More than 8.0 kHz/–6 dB
 Less than 30.0 kHz/–40 dB
 FM More than 12.0 kHz/–6 dB
 Less than 30.0 kHz/–60 dB
 *Without optional filter and with mid band selected.
- Spurious and image rejection ratio:
 HF More than 70 dB
 50 MHz More than 65 dB (except IF through)
 144/430 MHz More than 65 dB
- Audio output power : More than 2.0 W at 10% distortion with an 8 Ω load
- RIT variable range : ±9.99 kHz max.
- PHONES connector : 3-conductor 3.5 (d) mm (1/8")/8 Ω
- EXT SP connector : 2-conductor 3.5 (d) mm (1/8")/8 Ω

14 MENU GUIDE

 **LOCK** + power ON

Power OFF then ON to exit initial set mode. 

Initial set mode

MENU	No.	Indication	Description	No.	Indication	Description
     	1	MODE SELECT	Mode availability	20	AUTO RPTR	Auto repeater function
	2	BEEP	Confirmation beeps	21	SCAN RESUME	Scan resume condition
	3	BAND BEEP	Band edge beeps	22	SCAN SPEED	Scanning speed
	4	BACK LIGHT	Display backlighting	23	U/D SPEED	[UP]/[DN] speed
	5	KEY LIGHT	Key backlighting	24	AM NB	AM noise blanker
	6	AUTO OFF	Auto power OFF function	25	PAD CH	No. of memory pads
	7	RF/SQL	RF gain/squelch control	26	PWR ON CHK	Power ON check function
	8	SUB DIAL	Sub dial RIT function	27	A-TUNE STRT	Auto tune start function
	9	OPT. FIL 1	Optional filter 1	28	PTT TUNE	PTT tune function
	10	OPT. FIL 2	Optional filter 2	29	9600 MODE	Packet data speed
	11	PEAK HOLD	Meter peak function	30	USEND SEL	ACC output selection
	12	QUICK SPLIT	Quick split function	31	SPEECH LANG	Speech synthesizer lang.
	13	SPLIT LOCK	Split lock function	32	SPEECH SPD	Speech synthesizer speed
	14	SPL OFFSET	Quick split offset	33	S-LVL SPC	Speech synthesizer S-meter
	15	DUP HF	Quick split offset (HF)	34	CI-V ADDRES	CI-V address assignment
	16	DUP 50M	Quick split offset (50 MHz)	35	CI-V BAUD	Data transfer rate
	17	DUP 144M	Quick split offset (144 MHz)	36	CI-V TRN	CI-V transceive
	18	DUP 430M	Quick split offset (430 MHz)	37	CI-V 731	CI-V 731
	19	1TOUCH RPTR	One touch repeater			

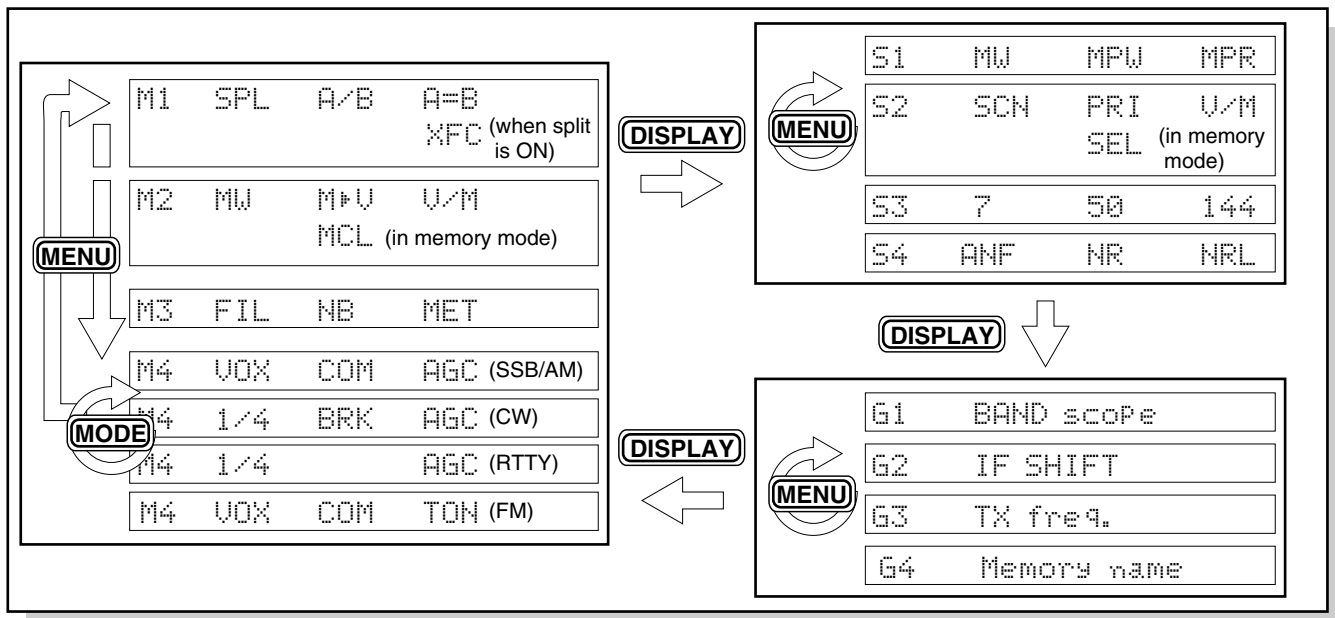

DISPLAY ↑ **DISPLAY** ↓ For 2 sec.

Quick set mode



No.	SSB/AM/FM mode	CW mode	RTTY mode
Q1	RF POWER	RF POWER	RF POWER
Q2	MIC GAIN	CW PITCH	RTTY TONE
Q3	VOX DELAY	BK-IN DELAY	RTTY SHIFT
Q4	VOX GAIN	CW PADDLE	RTTY KEYING
Q5	ANTI VOX	KEY SPEED	—
Q6	CARRIER Freq ^{*1} RPTR TONE ^{*2}	RATIO	—
Q7	TONE SQL ^{*2}	—	—
Q8	RPTR-T ^{*3} T-SQL ^{*4}	—	—

*1SSB mode only; *2FM mode only; *3FM mode only/tone encoder ON;
*4FM mode only/tone squelch ON.

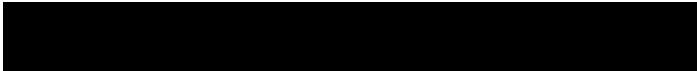
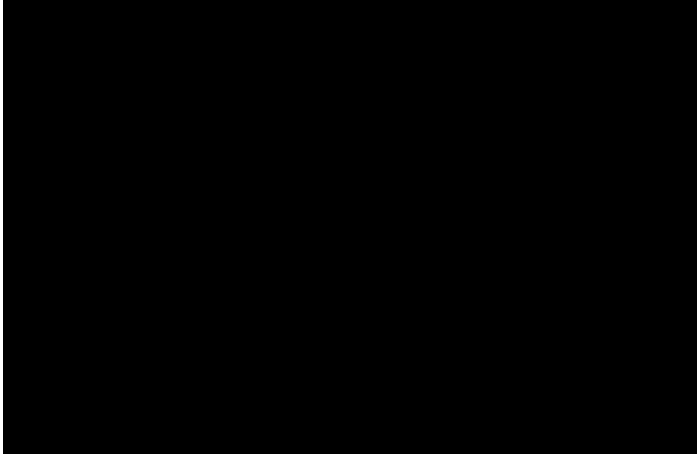
Count on us!

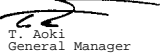

ABOUT CE

	DECLARATION OF CONFORMITY
<p>We Icom Inc. Japan 1-1-32 Kamiminami, Hirano-ku, Osaka 547-0003 Japan</p>	
	
<p>Declare on our sole responsibility that this equipment complies with the essential requirements of the Radio and Telecommunications Terminal Equipment Directive, 1999/5/CE, and that any applicable Essential Test Suite measurements have been performed.</p>	
<p>Kind of equipment: HF/VHF/UHF ALL MODE TRANSCEIVER</p>	<p>Düsseldorf 13th Mar. 2001 Place and date of issue</p>
<p>Type-designation: IC-706MKIIG</p>	<p>Icom (Europe) GmbH Himmelsteierstraße 100 D-40225 Düsseldorf Authorized representative name</p>
<p>Version (where applicable):</p> <p>This compliance is based on conformity according to Annex III of the RTTE Directive 1999/5/EC using the following harmonised standards:</p> <p>i) Article 3.1a EN 60950 + A11 ii) Article 3.1b EN 301489-1 and EN 301489-15 iii) Article 3.2 EN 301783-2 iv) _____ v) _____</p>	<p>Icom (Europe) GmbH  T. Aoki General Manager Signature</p>
	<p>Icom Inc.</p>

•Version and frequency coverage

Europe (#02, #12)	
Tx 1.800000 – 1.850000	Rx 0.030000 – 29.999999
3.500000 – 3.800000	50.000000 – 52.000000
7.000000 – 7.100000	144.000000 – 146.000000
10.100000 – 10.150000	430.000000 – 440.000000
14.000000 – 14.350000	
18.068000 – 18.168000	
21.000000 – 21.450000	
24.890000 – 24.990000	
28.000000 – 29.700000	
50.000000 – 52.000000	
144.000000 – 146.000000	
430.000000 – 440.000000	

Spain (#04, #14)	
Tx 1.830000 – 1.850000	Rx 1.830000 – 1.850000
3.500000 – 3.800000	3.500000 – 3.800000
7.000000 – 7.100000	7.000000 – 7.100000
10.100000 – 10.150000	10.100000 – 10.150000
14.000000 – 14.350000	14.000000 – 14.350000
18.068000 – 18.168000	18.068000 – 18.168000
21.000000 – 21.450000	21.000000 – 21.450000
24.890000 – 24.990000	24.890000 – 24.990000
28.000000 – 29.700000	28.000000 – 29.700000
50.000000 – 50.200000	50.000000 – 50.200000
144.000000 – 146.000000	144.000000 – 146.000000
430.000000 – 440.000000	430.000000 – 440.000000

France (#03, #13)	
Tx 1.810000 – 1.850000	Rx 1.810000 – 1.850000
3.500000 – 3.800000	3.500000 – 3.800000
7.000000 – 7.100000	7.000000 – 7.100000
10.100000 – 10.150000	10.100000 – 10.150000
14.000000 – 14.350000	14.000000 – 14.350000
18.068000 – 18.168000	18.068000 – 18.168000
21.000000 – 21.450000	21.000000 – 21.450000
24.890000 – 24.990000	24.890000 – 24.990000
28.000000 – 29.700000	28.000000 – 29.700000
50.200000 – 51.200000	50.200000 – 51.200000
144.000000 – 146.000000	144.000000 – 146.000000
430.000000 – 440.000000	430.000000 – 440.000000

Italy (#10, #20)	
Tx 1.830000 – 1.850000	Rx 1.830000 – 1.850000
3.500000 – 3.800000	3.500000 – 3.800000
7.000000 – 7.100000	7.000000 – 7.100000
10.100000 – 10.150000	10.100000 – 10.150000
14.000000 – 14.350000	14.000000 – 14.350000
18.068000 – 18.168000	18.068000 – 18.168000
21.000000 – 21.450000	21.000000 – 21.450000
24.890000 – 24.990000	24.890000 – 24.990000
28.000000 – 29.700000	28.000000 – 29.700000
50.000000 – 51.000000	50.000000 – 51.000000
144.000000 – 146.000000	144.000000 – 146.000000
430.000000 – 434.000000	430.000000 – 434.000000
435.000000 – 438.000000	435.000000 – 438.000000

(UNIT: MHz)

•About DC power supply.

The use of IC-706MKIIG (#02, #12, #03, #13, #04, #14, #10, #20) in combination with The DC power supply complies with European Harmonised Standard regulations under the conditions listed below.

Conditions

- In combination with PS-125
- When connected to a power supply via OPC-639

•About IC-PW1 LINEAR AMPLIFIER and SP-10, SP-12, SP-20, SP-21 EXTERNAL SPEAKERS.

The IC-PW1 LINEAR AMPLIFIER and The SP-10, SP-12, SP-20, SP-21 EXTERNAL SPEAKERS do not comply with European Harmonised Standard regulations. Please do not use these equipments within European countries.

INSTALLATION NOTES

For amateur base station installations it is recommended that the forwards clearance in front of the antenna array is calculated relative to the EIRP (Effective Isotropic Radiated Power). The clearance height below the antenna array can be determined in most cases from the RF power at the antenna input terminals.

As different exposure limits have been recommended for different frequencies, a relative table shows a guideline for installation considerations.

Below 30 MHz, the recommended limits are specified in terms of V/m or A/m fields as they are likely to fall within the near-field region. Similarly, the antennae may be physically short in terms of electrical length and that the installation will require some antenna matching device which can create local, high intensity magnetic fields. Analysis of such MF installations is best considered in association with published guidance notes such as the FCC OET Bulletin 65 Edition 97-01 and its annexes relative to amateur transmitter installations. The EC recommended limits are almost identical to the FCC specified 'uncontrolled' limits and tables exist that show pre-calculated safe distances for different antenna types for different frequency bands. Further information can be found at <http://www.arrl.org/>.

•Typical amateur radio installation

Exposure distance assumes that the predominant radiation pattern is forwards and that radiation vertically downwards is at unity gain (sidelobe suppression is equal to main lobe gain). This is true of almost every gain antenna today. Exposed persons are assumed to be beneath the antenna array and have a typical height to 1.8 m.

The figures assume the worst case emission of constant carrier.

For the bands 10 MHz and higher the following power density limits have been recommended:

10 – 400 MHz 2 W/sq m
435 MHz 2.2 W/sq m

EIRP Clearance heights by frequency band

Watts	10–2 m	70 cm	23 cm	13cm and above
1	2.1 m	2 m	2 m	2 m
10	2.8 m	2.7 m	2.5 m	2.3 m
25	3.4 m	3.3 m	2.7 m	2.5 m
100	5 m	4.7 m	3.6 m	3.2 m
1000	12 m	11.5 m	7.3 m	6.3 m

Forward clearance, EIRP by frequency band

Watts	10–2 m	70 cm	23 cm	13cm and above
100	2 m	2 m	1.1 m	0.7 m
1000	6.5 m	6 m	3.5 m	3 m
10,000	20 m	18 m	11 m	7 m
100,000	65 m	60 m	35 m	29 m

In all cases any possible risk depends on the transmitter being activated for long periods. (actual recommendation limits are specified as an average during 6 minutes) Normally the transmitter is not active for long periods of time. Some radio licenses will require that a timer circuit automatically cuts the transmitter after 1–2 minutes etc.

Similarly some types of transmitter, SSB, CW, AM etc. have a lower 'average' output power and the assessed risk is even lower.

 Versions of the IC-706MKIIG which display the "CE" symbol on the serial number seal, comply with the essential requirements of the European Radio and Telecommunication Terminal Directive 1999/5/EC.

 This warning symbol indicates that this equipment operates in non-harmonised frequency bands and/or may be subject to licensing conditions in the country of use. Be sure to check that you have the correct version of this radio or the correct programming of this radio, to comply with national licensing requirement.

IC-706MKIIG
#02, #12
(Europe)

< Intended Country of Use >		
<input checked="" type="checkbox"/> GER	<input checked="" type="checkbox"/> NED	<input type="checkbox"/> ITA
<input checked="" type="checkbox"/> AUT	<input type="checkbox"/> BEL	<input type="checkbox"/> GRE
<input checked="" type="checkbox"/> GBR	<input checked="" type="checkbox"/> LUX	<input checked="" type="checkbox"/> SWE
<input checked="" type="checkbox"/> IRL	<input type="checkbox"/> ESP	<input checked="" type="checkbox"/> DEN
<input type="checkbox"/> FRA	<input type="checkbox"/> POR	<input checked="" type="checkbox"/> FIN

IC-706MKIIG
#04, #14
(Spain)

< Intended Country of Use >		
<input type="checkbox"/> GER	<input checked="" type="checkbox"/> NED	<input type="checkbox"/> ITA
<input type="checkbox"/> AUT	<input type="checkbox"/> BEL	<input type="checkbox"/> GRE
<input type="checkbox"/> GBR	<input type="checkbox"/> LUX	<input type="checkbox"/> SWE
<input type="checkbox"/> IRL	<input checked="" type="checkbox"/> ESP	<input type="checkbox"/> DEN
<input type="checkbox"/> FRA	<input checked="" type="checkbox"/> POR	<input type="checkbox"/> FIN

IC-706MKIIG
#03, #13
(France)

< Intended Country of Use >		
<input type="checkbox"/> GER	<input checked="" type="checkbox"/> NED	<input type="checkbox"/> ITA
<input type="checkbox"/> AUT	<input type="checkbox"/> BEL	<input checked="" type="checkbox"/> GRE
<input type="checkbox"/> GBR	<input type="checkbox"/> LUX	<input type="checkbox"/> SWE
<input type="checkbox"/> IRL	<input type="checkbox"/> ESP	<input type="checkbox"/> DEN
<input checked="" type="checkbox"/> FRA	<input type="checkbox"/> POR	<input type="checkbox"/> FIN

IC-706MKIIG
#10, #20
(Italy)

< Intended Country of Use >		
<input type="checkbox"/> GER	<input checked="" type="checkbox"/> NED	<input checked="" type="checkbox"/> ITA
<input type="checkbox"/> AUT	<input type="checkbox"/> BEL	<input type="checkbox"/> GRE
<input type="checkbox"/> GBR	<input type="checkbox"/> LUX	<input type="checkbox"/> SWE
<input type="checkbox"/> IRL	<input type="checkbox"/> ESP	<input type="checkbox"/> DEN
<input type="checkbox"/> FRA	<input type="checkbox"/> POR	<input type="checkbox"/> FIN

ABOUT SP-7 EXTERNAL SPEAKER

If the SP-7 external speaker is used with the IC-706MKIIG, please install the ferrite bead on the speaker cable, as shown below.

- A ferrite bead and a cable fastener are supplied with IC-706MKIIG.

INSTALLATION NOTE:

- Install the ferrite bead as near as possible the connecting plug.
- Attach the ferrite bead making a loop with the cable as shown in the diagram at below left.
- Fasten the ferrite bead and speaker cable with the supplied cable fastener.

