



INSTRUCTION MANUAL

VHF TRANSCEIVERS

IC-F3011
IC-F3013

UHF TRANSCEIVERS

IC-F4011
IC-F4013

This device complies with Part 15 of the FCC Rules. Operation is subject to the condition that this device does not cause harmful interference.



Icom Inc.

SAFETY TRAINING INFORMATION



WARNING

Your Icom radio generates RF electromagnetic energy during transmit mode. This radio is designed for and classified as “Occupational Use Only”, meaning it must be used only during the course of employment by individuals aware of the hazards, and the ways to minimize such hazards. This radio is NOT intended for use by the “General Population” in an uncontrolled environment.

This radio has been tested and complies with the FCC RF exposure limits for “Occupational Use Only”. In addition, your Icom radio complies with the following Standards and Guidelines with regard to RF energy and electromagnetic energy levels and evaluation of such levels for exposure to humans:

- FCC OET Bulletin 65 Edition 97-01 Supplement C, Evaluating Compliance with FCC Guidelines for Human Exposure to Radio Frequency Electromagnetic Fields.
- American National Standards Institute (C95.1-1992), IEEE Standard for Safety Levels with Respect to Human Exposure to Radio Frequency Electromagnetic Fields, 3 kHz to 300 GHz.
- American National Standards Institute (C95.3-1992), IEEE Recommended Practice for the Measurement of Potentially Hazardous Electromagnetic Fields— RF and Microwave.
- The following accessories are authorized for use with this product. Use of accessories other than those specified may result in RF exposure levels exceeding the FCC requirements for wireless RF exposure.; Belt Clip (MB-94), Rechargeable Li-ion Battery Pack (BP-230N/BP-232N/BP-232H) and Speaker-microphone (HM-131L).



CAUTION

To ensure that your exposure to RF electromagnetic energy is within the FCC allowable limits for occupational use, always adhere to the following guidelines:

-
-
- **DO NOT** operate the radio without a proper antenna attached, as this may damaged the radio and may also cause you to exceed FCC RF exposure limits. A proper antenna is the antenna supplied with this radio by the manufacturer or antenna specifically authorized by the manufacturer for use with this radio.
 - **DO NOT** transmit for more than 50% of total radio use time (“50% duty cycle”). “50% duty cycle” is also applicable to VOX/PTT mode. Transmitting more than 50% of the time can cause FCC RF exposure compliance requirements to be exceeded. The radio is transmitting when the “LED indicator” lights red. You can cause the radio to transmit by pressing the “PTT” switch or VOX function.
 - **ALWAYS keep** the antenna at least 2.5 cm (1 inch) away from the body when transmitting and only use the Icom belt-clip which is listed on page 33 when attaching the radio to your belt, etc., to ensure FCC RF exposure compliance requirements are not exceeded. To provide the recipients of your transmission the best sound quality, hold the antenna at least 5 cm (2 inches) from your mouth, and slightly off to one side.

The information listed above provides the user with the information needed to make him or her aware of RF exposure, and what to do to assure that this radio operates with the FCC RF exposure limits of this radio.

Electromagnetic Interference/Compatibility

During transmissions, your Icom radio generates RF energy that can possibly cause interference with other devices or systems. To avoid such interference, turn off the radio in areas where signs are posted to do so. **DO NOT** operate the transmitter in areas that are sensitive to electromagnetic radiation such as hospitals, aircraft, and blasting sites.

Occupational/Controlled Use

The radio transmitter is used in situations in which persons are exposed as consequence of their employment provided those persons are fully aware of the potential for exposure and can exercise control over their exposure.

FOREWORD

READ ALL INSTRUCTIONS carefully and completely before using the transceiver.

SAVE THIS INSTRUCTION MANUAL— This instruction manual contains important operating instructions for the IC-F3011/IC-F3013 VHF TRANSCEIVERS and IC-F4011/IC-F4013 UHF TRANSCEIVERS.

EXPLICIT DEFINITIONS

WORD	DEFINITION
⚠ DANGER!	Personal death, serious injury or an explosion may occur.
⚠ WARNING!	Personal injury, fire hazard or electric shock may occur.
CAUTION	Equipment damage may occur.
NOTE	If disregarded, inconvenience only. No risk of personal injury, fire or electric shock.

Icom, Icom Inc. and the Icom logo are registered trademarks of Icom Incorporated (Japan) in Japan, the United States, the United Kingdom, Germany, France, Spain, Russia and/or other countries.

PRECAUTIONS

⚠ **DANGER! NEVER** short the terminals of the battery pack.

⚠ **DANGER!** Use and charge only specified Icom battery packs with Icom radios or Icom chargers. Only Icom battery packs are tested and approved for use with Icom radios or charged with Icom chargers. Using third-party or counterfeit battery packs or chargers may cause smoke, fire, or cause the battery to burst.

⚠ **WARNING! NEVER** hold the transceiver so that the antenna is very close to, or touching exposed parts of the body, especially the face or eyes, while transmitting. The transceiver will perform best if the microphone is 5 to 10 cm (2 to 4 in.) away from the lips and the transceiver is vertical.

⚠ **WARNING! NEVER** operate the transceiver with a headset or other audio accessories at high volume levels.

CAUTION: NEVER expose the transceiver to rain, snow or any liquids. The transceiver may be damaged.

DO NOT push [PTT] when not actually desiring to transmit.

DO NOT use or place the transceiver in direct sunlight or in areas with temperatures below -30°C ($+22^{\circ}\text{F}$) or above $+60^{\circ}\text{C}$ ($+140^{\circ}\text{F}$).

DO NOT modify the transceiver. The transceiver warranty does not cover any problems caused by unauthorized modification.

MAKE SURE the flexible antenna and battery pack are securely attached to the transceiver, and that the antenna and battery pack are dry before attachment. Exposing the inside of the transceiver to water will result in serious damage to the transceiver.

For U.S.A. only

CAUTION: Changes or modifications to this device, not expressly approved by Icom Inc., could void your authority to operate this transceiver under FCC regulations.

TABLE OF CONTENTS

SAFETY TRAINING INFORMATION.....	i
FOREWORD	iii
EXPLICIT DEFINITIONS.....	iii
PRECAUTIONS.....	iv
TABLE OF CONTENTS.....	v
1 ACCESSORIES	1-5
■ Supplied accessories.....	1
■ Accessory attachments	2
2 PANEL DESCRIPTION.....	6-11
■ Front, top and side panels	6
■ LED indicator	8
■ Programmable function keys	9
3 CONVENTIONAL OPERATION.....	12-15
■ Turning power ON	12
■ Channel selection	12
■ Receiving and transmitting	13
■ Setting the squelch level.....	15
4 SIGNALING OPERATIONS.....	16-17
■ Call procedure	16
■ Emergency Call	17
■ DTMF transmission.....	17
5 BATTERY CHARGING	18-25
■ Caution	18
■ Battery chargers	21
6 BATTERY CASE	26-27
■ Optional battery case (BP-240)	26
7 SWIVEL BELT CLIP	28-31
■ MB-93 contents.....	28
■ To attach	28
■ To detach	30
8 OPTIONS	32-35
9 FCC INFORMATION	36

■ Supplied accessories

The following accessories are supplied.

Flexible antenna*



Battery pack

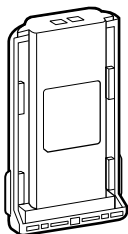

Battery charger
(with AC adapter)

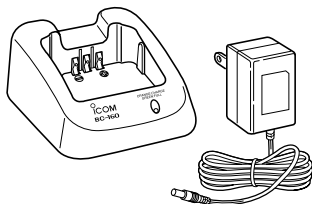

Belt clip



Jack cover (with screws)

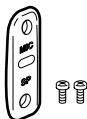

*This illustration is described with the VHF type.

■ Accessory attachments

◇ Flexible antenna

Connect the supplied flexible antenna to the antenna connector.

CAUTION:

- **NEVER** carry the transceiver by holding only the antenna.
- **DO NOT** connect the antenna other than listed on page 34.
- Transmitting without an antenna may damage the transceiver.

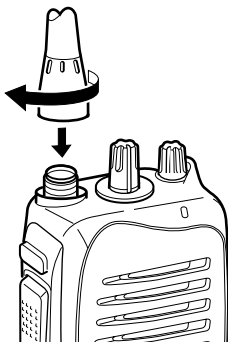

◇ Battery pack

To attach the battery pack:

Slide the battery pack on the back of the transceiver in the direction of the arrow (1), then lock it with the battery release button.

- Slide the battery pack until the battery release button makes a 'click' sound.

To remove the battery pack:

Push the battery release button in the direction of the arrow (2) as shown below. The battery pack is then removed.

/// **NOTE:** Keep the battery terminals clean. It's a good idea to occasionally clean them.

/// **NEVER** remove or attach the battery pack when the transceiver is wet or soiled. This may result in water or dust getting into the transceiver/battery pack and may result in the transceiver being damaged.

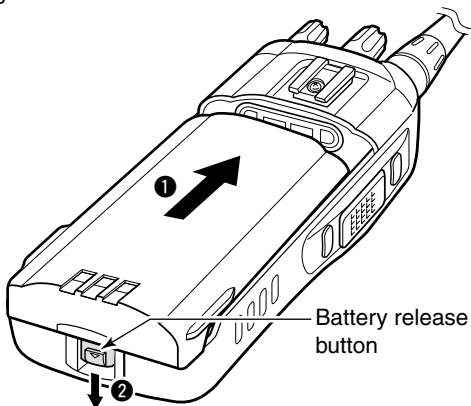

1 ACCESSORIES

◇ Jack cover

Attach the jack cover when the optional speaker-microphone is not used.

To attach the jack cover:

- 1 Attach the jack cover to the [SP MIC] connector.
- 2 Tighten the screws.

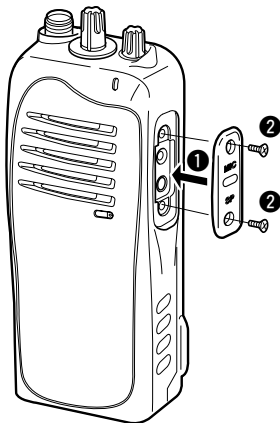

To detach the jack cover:

- 3 Remove the screws with a phillips screwdriver.
- 4 Detach the jack cover for the optional equipment connection.

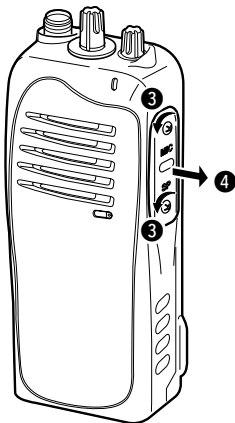

◇ Belt clip

To attach the belt clip:

- ① Remove the battery pack if it is attached.
- ② Slide the belt clip in the direction of the arrow until the belt clip is locked and makes a 'click' sound.

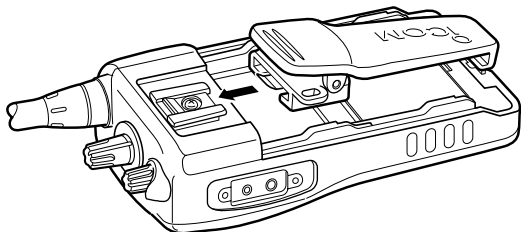

To detach the belt clip:

- ① Remove the battery pack if it is attached.
- ② Pinch the clip (1), and slide the belt clip in the direction of the arrow (2).

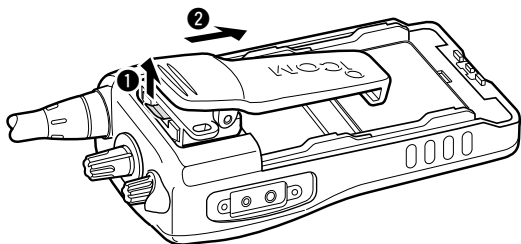

2 PANEL DESCRIPTION

■ Front, top and side panels

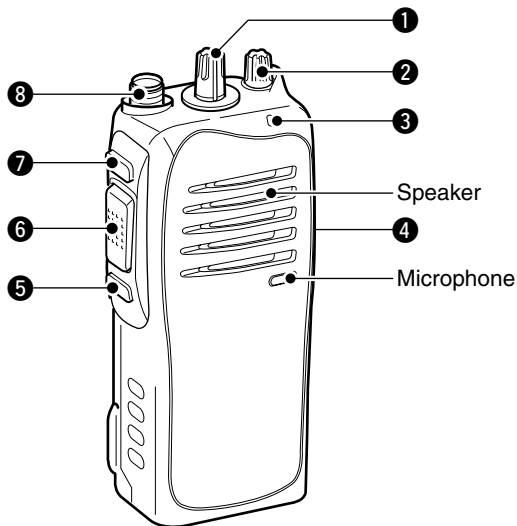

❶ CHANNEL SELECTOR

Rotate the channel selector to select the pre-programmed memory channels.

❷ VOLUME CONTROL [VOL]

Rotate to turn the power ON/OFF and adjust the audio level.

3 LED INDICATOR (p. 8)

- Lights red while transmitting.
- Lights green while receiving a signal, or when the squelch is open.
- Lights/blinks orange when the matched 2/5-tone code is received, according to the pre-programming. (For IC-F3013/F4013 only)

4 SPEAKER-MICROPHONE CONNECTOR [SP MIC]

Connects the optional speaker-microphone, earphone, etc.



[SP MIC] jack cover

NOTE: Attach the [SP MIC] jack cover when the optional equipment is not used. (p. 4)

5 DEALER-PROGRAMMABLE KEY [Lower]

The desired function can be assigned by your dealer. (p. 9)

6 PTT SWITCH [PTT]

Push and hold to transmit; release to receive.

7 DEALER-PROGRAMMABLE KEY [Upper]

The desired function can be assigned by your dealer. (p. 9)

8 ANTENNA CONNECTOR

Connects the supplied antenna.

■ LED indicator

The LED indicator indicates several information as follows;

(Ref.; R=Red, G=Green, O=Orange)

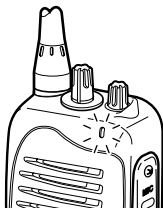

- TX: Turns Red while transmitting a signal.



- RX: Turns Green while receiving a signal.

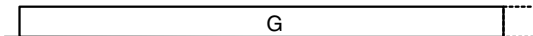

- Fast/Slow scan: Blinks while Fast/Slow scan is activated.

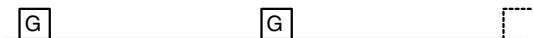

- Low BATT1: You should charge the battery. (blinks slowly)



- Low BATT2: You must charge the battery. (blinks fast)

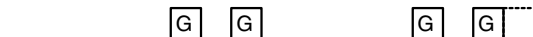

- TX low BATT2: Low BATT2 was detected during TX mode.



- CH error: Non-programmed channel is selected.



For IC-F3013/IC-F4013 only

- Call LED (ON): When receiving a matched 2/5-tone.



- Call LED (Blink): When receiving a matched 2/5-tone.



■ Programmable function keys

The following functions can be assigned to [Upper] and [Lower] programmable function keys.

Consult your Icom dealer or system operator for details concerning your transceivers programming.

◇ For All models

SCAN A KEY

- Push to start and cancel scanning operation.
- When the Power ON scan function is turned ON, push to pause the scanning operation. The paused scan restarts after the specified time period has passed.

SCAN B KEY

Push to start and cancel scanning operation. In case of transmission during scan, pauses scanning. The paused scan restarts after the specified time period has passed.

PRIORITY CHANNEL KEYS

- Push to select the Priority A or Priority B channel.
- Push and hold [**Prio A (Rewrite)**] to rewrite the Prio A channel.

MR-CH 1/2/3/4 KEYS

Push to select a memory channels 1 to 4 directly.

2 PANEL DESCRIPTION

OUTPUT POWER SELECTION KEY

Select the transmit output power temporarily or permanently, depending on the pre-setting.

- Ask your dealer for the output power level for each selection.

TALK AROUND KEY

- Push to turn the talk around function OFF.
- Push and hold to turn the talk around function ON.
 - The talk around function equalizes the transmit frequency to the receive frequency for transceiver-to-transceiver communication.

WIDE/NARROW KEY

- Push to select the IF bandwidth to wide.
 - The wide passband width can be selected from 25 or 20 kHz using the optional cloning software (PMR operation only). Ask your dealer for details.
- Push and hold to select the IF bandwidth to narrow.

SIREN KEY

Push to emit a siren. This function can be used for situations other than an emergency alert such as a security alarm for example.

LOCK KEY

Push and hold to electronically lock all programmable keys except the followings: **[Moni(Audi)]**, **[Call]** (incl. Call A and Call B)* and **[Emergency Single]/[Emergency Repeat]** (incl. Silent)*.

* Available for IC-F3013/IC-F4013 only.

MONITOR KEY

- Push to mute and release the CTCSS (DTCS) or 2Tone* squelch mute. Open any squelches/deactivate any mutes while pushing this key. (LMR operation only)

* Available for the IC-F3013/F4013 only.

- Activates one of (or two of) the following functions on each channel independently: (PMR operation only)
 - Push and hold to un-mute the channel (audio is emitted; 'Audible').
 - Push to mute the channel (audio is not emitted; 'Inaudible').
 - Push to send a 'reset code' after the communication is finished.

 **NOTE:** The un-mute condition ('Audible' condition) may automatically return to the mute condition ('Inaudible' condition) after a specified period.

◇ For IC-F3013/IC-F4013 only

DTMF AUTODIAL KEY

Push to transmit the programmed DTMF code.

CALL KEYS

Push to transmit a 2/5-tone code.

- Call transmission is necessary before you call another station depending on your signalling system.
- [Call A] and/or [Call B] keys may be available when your system employs selective 'Individual/Group' calls. Ask your dealer which call is assigned to each key.

EMERGENCY SINGLE/EMERGENCY REPEAT KEYS

- Push and hold for the specified time period to transmit an emergency call once or repeatedly.
- When [**Emergency Single (Silent)**] or [**Emergency Repeat (Silent)**] is pushed, an emergency call is transmitted with no beep emission.
 - If you want to cancel the emergency call, push (or push and hold) the key again before transmitting the call.
 - The emergency call is transmitted one time only or repeatedly until receiving a control code depending on the pre-setting.

3 CONVENTIONAL OPERATION

■ Turning power ON

Rotate [VOL] to turn power ON.

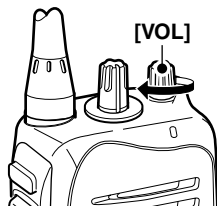

■ Channel selection

Rotate [CHANNEL SELECTOR] to select the desired operating channel, in sequence; or, push one of [MR-CH 1] to [MR-CH 4] key to select a channel directly.

AUTOMATIC SCAN TYPE:

Channel setting is not necessary for this type. When turning the power ON, the transceiver automatically starts scanning. Scanning stops when receiving a call.

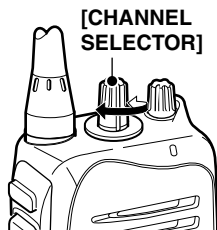

■ Receiving and transmitting

NOTE: Transmitting without an antenna may damage the transceiver. See page 2 for antenna attachment.

Receiving:

- ① Rotate **[VOL]** to turn power ON.
- ② Rotate **[CHANNEL SELECTOR]** or push one of **[MR-CH 1]** to **[MR-CH 4]** key to select a channel.
- ③ When receiving a call, adjust the audio output level to a comfortable listening level.

Transmitting:

Wait for the channel to become clear to avoid interference.

- ① While pushing and holding **[PTT]**, speak into the microphone at a normal voice level.
- ② Release **[PTT]** to return to receive.

IMPORTANT: To maximize the readability of your signal;

1. Pause briefly after pushing **[PTT]**.
2. Hold the microphone 5 to 10 cm (2 to 4 inches) from your mouth, then speak into the microphone at a normal voice level.

3 CONVENTIONAL OPERATION

◇ **Transmitting notes**

• **Transmit inhibit function**

The transceiver has several inhibit functions which restrict transmission under the following conditions:

- The channel is in mute condition.
- The channel is busy.
- Un-matched (or matched) CTCSS is received.
- The selected channel is a 'receive only' channel.

• **Time-out timer**

After continuous transmission for the pre-programmed time period, the time-out timer activates, and causes the transceiver to stop transmitting.

• **Penalty timer**

Once the time-out timer activates, transmission is further inhibited for a period determined by the penalty timer.

■ Setting the squelch level

The squelch circuit mutes the received audio signal depending on the signal strength.

- ① While pushing **[PTT]** and **[Lower]**, rotate **[VOL]** to turn the power ON to enter the squelch level adjustment mode.
- ② Push **[Upper]** to increase the squelch level (tight squelch) or **[Lower]** to decrease the squelch level (loose squelch).
- ③ Rotate **[VOL]** to turn the power OFF to fix the squelch level.

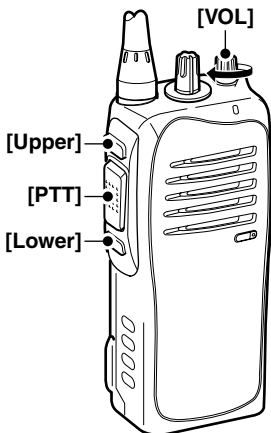

4 SIGNALING OPERATIONS

NOTE: The tone signalling operations are available for the IC-F3013/F4013 only.

Call procedure

When your system employs tone signalling (excluding CTCSS and DTCSS), the call procedure may be necessary prior to voice transmission. The tone signalling employed may be a selective calling system which allows you to call specific station(s) only and prevent unwanted stations from contacting you.

- ① Select the desired TX code channel or 2/5-tone code according to your System Operator's instructions.
 - This may not be necessary depending on programming.
- ② Push **[Call]**. (p. 11)
- ③ After transmitting a 2/5-tone code, the remainder of your communication can be carried out in the normal fashion.

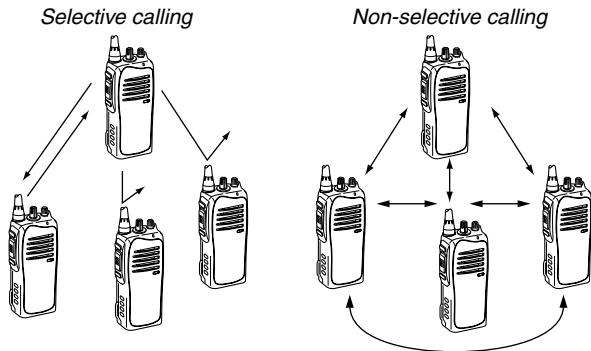

◇ Transmitting notes— PTTID call

The transceiver sends the ID code (5-tone, DTMF or digital ANI) automatically when **[PTT]** is pushed (beginning of transmission) and released (end of transmission) depends on the setting.

■ Emergency Call

When **[Emergency Single]** or **[Emergency Repeat]** (p. 11) is pushed and held for the specified time period, the emergency signal (5-tone, DTMF or MDC 1200) is transmitted once or repeatedly on the emergency channel. A repeat emergency signal is automatically transmitted until it receives the acknowledgement signal. When no emergency channel is specified, the signal is transmitted on the previously selected channel.

If you want to cancel the emergency call, push and hold the key again before transmitting the call.

The emergency call can be transmitted without a beep emission, and the LCD indication if **[Emergency Single (Silent)]** or **[Emergency Repeat (Silent)]** (p. 11) is pushed.

The transceiver can also be programmed to keep the microphone open during an emergency call, allowing monitoring of the situation.

 **IMPORTANT:** It is recommended to set an emergency channel individually to provide the certain emergency call operation.

■ DTMF transmission

If the transceiver has **[DTMF Autodial]** assigned to it, the automatic DTMF transmission function is available.

➡ Push **[DTMF Autodial]** to transmit the DTMF code.

5 BATTERY CHARGING

■ Caution

Misuse of Lithium-ion batteries may result in the following hazards: smoke, fire, or the battery may rupture. Misuse can also cause damage to the battery or degradation of battery performance.

⚠ **DANGER!** Use and charge only specified Icom battery packs with Icom radios or Icom charger. Only Icom battery packs are tested and approved for use and charge with Icom radios or Icom charger. Using third-party or counterfeit battery packs or charger may cause smoke, fire, or cause the battery to burst.

◇ Battery caution

⚠ **DANGER! DO NOT** hammer or otherwise impact the battery. Do not use the battery if it has been severely impacted or dropped, or if the battery has been subjected to heavy pressure. Battery damage may not be visible on the outside of the case. Even if the surface of the battery does not show cracks or any other damage, the cells inside the battery may rupture or catch fire.

⚠ **DANGER! NEVER** use or leave battery packs in areas with temperatures above +60°C (+140°F). High temperature buildup in the battery, such as could occur near fires or stoves, inside a sun heated car, or in direct sunlight may cause the battery to rupture or catch fire. Excessive temperatures may also degrade battery performance or shorten battery life.

⚠ **DANGER! DO NOT** expose the battery to rain, snow, seawater, or any other liquids. Do not charge or use a wet battery. If the battery gets wet, be sure to wipe it dry before using. The battery is not waterproof.

△ **DANGER! NEVER** incinerate used battery packs since internal battery gas may cause them to rupture, or may cause an explosion.

△ **DANGER! NEVER** solder the battery terminals or NEVER modify the battery pack. This may cause heat generation, and the battery may rupture, emit smoke or catch fire.

△ **DANGER!** Use the battery only with the transceiver for which it is specified. Never use a battery with any other equipment, or for any purpose that is not specified in this instruction manual.

△ **DANGER!** If fluid from inside the battery gets in your eyes, blindness can result. Rinse your eyes with clean water, without rubbing them, and see a doctor immediately.

WARNING! Immediately stop using the battery if it emits an abnormal odor, heats up, or is discolored or deformed. If any of these conditions occur, contact your Icom dealer or distributor.

WARNING! Immediately wash, using clean water, any part of the body that comes into contact with fluid from inside the battery.

WARNING! NEVER put the battery in a microwave oven, high-pressure container, or in an induction heating cooker. This could cause a fire, overheating, or cause the battery to rupture.

CAUTION! Always use the battery within the specified temperature range for the transceiver (-30°C to $+60^{\circ}\text{C}$; -22°F to $+140^{\circ}\text{F}$) and the battery itself (-20°C to $+60^{\circ}\text{C}$; -4°F to $+140^{\circ}\text{F}$). Using the battery out of its specified temperature range will reduce the battery's performance and battery life.

5 BATTERY CHARGING

CAUTION! Shorter battery life could occur if the battery is left fully charged, completely discharged, or in an excessive temperature environment (above +50°C; +122°F) for an extended period of time. If the battery must be left unused for a long time, it must be detached from the radio after discharging.

You may use the battery until the remaining capacity is about half, then keep it safely in a cool dry place with the temperature range as below:

- 20°C to +50°C (-4°F to +122°F) (within a month)
- 20°C to +40°C (-4°F to +95°F) (within three months)
- 20°C to +20°C (-4°F to +68°F) (within a year)

◇ Charging caution

⚠ **DANGER! NEVER** charge the battery pack in areas with extremely high temperatures, such as near fires or stoves, inside a sun heated car, or in direct sunlight. In such environments, the safety/protection circuit in the battery will activate, causing the battery to stop charging.

WARNING! DO NOT charge or leave the battery in the battery charger beyond the specified time for charging. If the battery is not completely charged by the specified time, stop charging and remove the battery from the battery charger. Continuing to charge the battery beyond the specified time limit may cause a fire, overheating, or the battery may rupture.

WARNING! NEVER insert the transceiver (battery attached to the transceiver) into the charger if it is wet or soiled. This could corrode the battery charger terminals or damage the charger. The charger is not waterproof.

CAUTION! DO NOT charge the battery outside of the specified temperature range: BC-160 (0°C to +40°C; +32°F to +104°F). Icom recommends charging the battery at +20°C (+68°F). The battery may heat up or rupture if charged out of the specified temperature range. Additionally, battery performance or battery life may be reduced.

■ Battery chargers

◇ Rapid charging with the BC-160

The optional BC-160 provides rapid charging of the Li-ion battery pack. Charging period: Approximately 3 hours (with BP-232H)

The following items are additionally required:

- An AC adapter (not supplied with some versions) or the DC power cable (OPC-515L/CP-23L) is additionally required.

AC adapter

(A different type, or no AC adapter is supplied, depending on the version.)

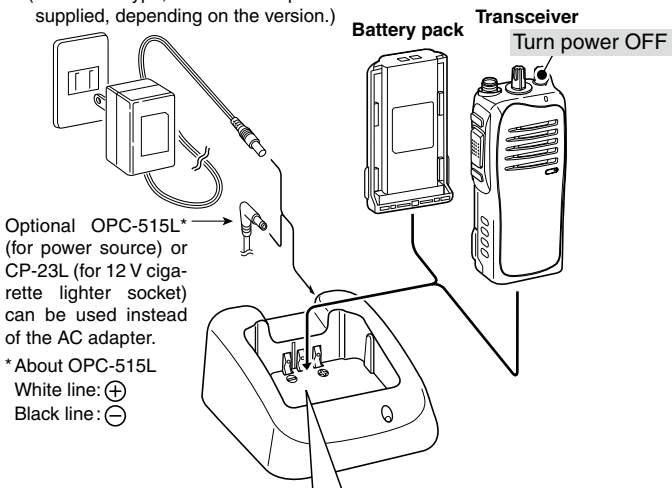

IMPORTANT!

Ensure the guide tabs on the battery pack are correctly aligned with the guide rails inside the charger adapter.

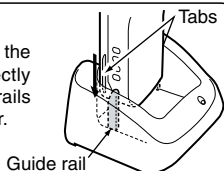

◇ AD-106 installation

The AD-106 CHARGER ADAPTER must be installed into the BC-119N or BC-121N before battery charging.

- ① Attach the plugs from the BC-119N/BC-121N to the AD-106 CHARGER ADAPTER.
- ② Secure the AD-106 into the holder space of the BC-119N/BC-121N with the supplied screws.

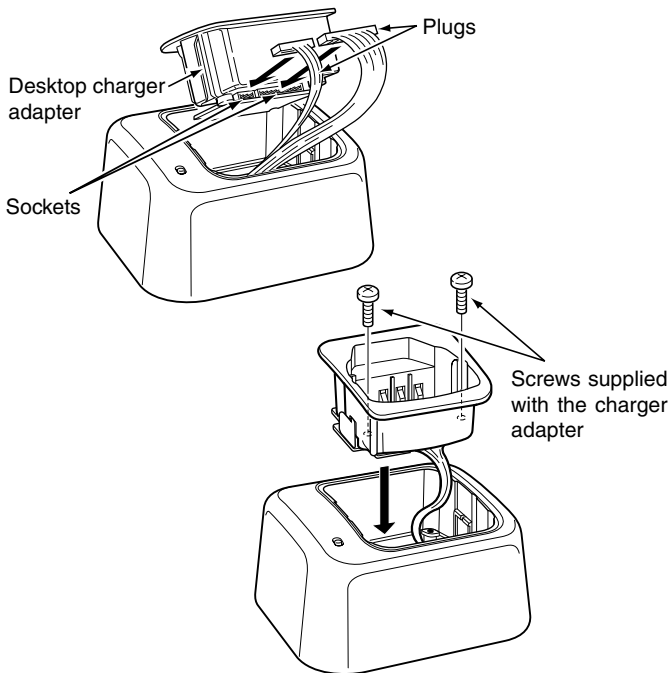

This illustration is described with the BC-119N.

5 BATTERY CHARGING

◇ Rapid charging with the BC-119N+AD-106

The optional BC-119N provides rapid charging of the Li-ion battery pack.

Charging period: Approximately 3 hours (with BP-232H)

The following items are additionally required:

- An AD-106 CHARGER ADAPTER (purchase separately)
- An AC adapter (not supplied with some versions) or the DC power cable (OPC-515L/CP-23L).

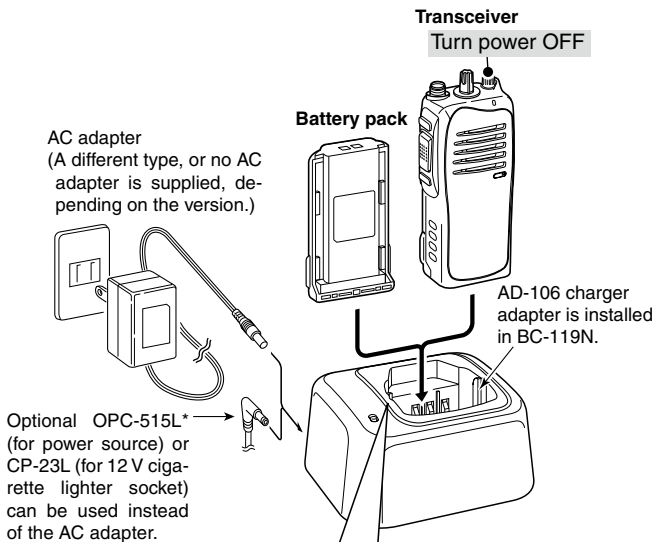

* About OPC-515L

White line: ⊕

Black line: ⊖

IMPORTANT!

Ensure the guide tabs on the battery pack are correctly aligned with the guide rails inside the charger adapter.

Guide rails

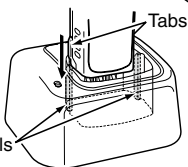

◇ Rapid charging with the BC-121N+AD-106

The optional BC-121N allows up to 6 battery packs to be charged simultaneously.

Charging period: Approximately 3 hours (with BP-232H)

The following items are additionally required.

- Six AD-106 CHARGER ADAPTER (purchase separately)
- An AC adapter (BC-157) or the DC power cable (OPC-656)

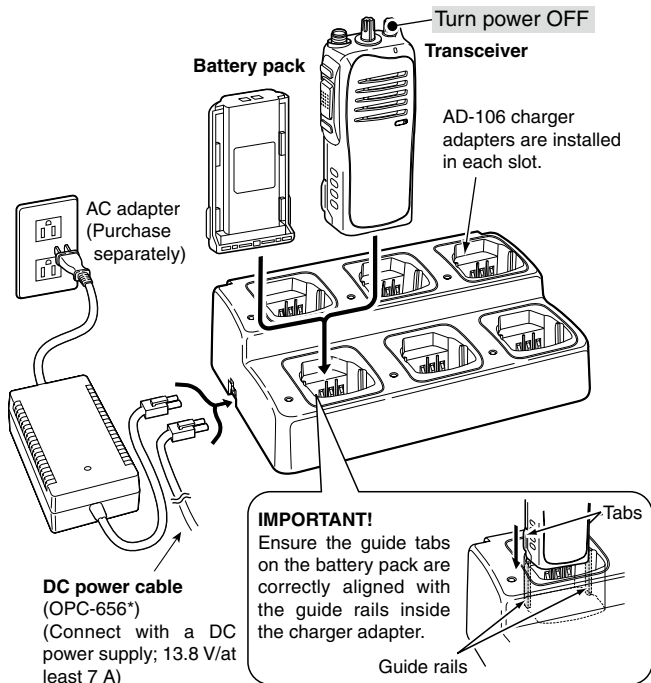

*About the OPC-656

Red line: ⊕ Black line: ⊖

6 BATTERY CASE

■ Optional battery case (BP-240)

When using the optional battery case, install 6 × AAA (LR03) size alkaline batteries as illustrated at right.

- ① Unhook the battery cover release hook (❶), and open the cover in the direction of the arrow (❷). (Fig.1)
- ② Then, install 6 × AAA (LR03) size alkaline batteries. (Fig.2)
 - Install the alkaline batteries only.
 - Be sure to observe the correct polarity.
- ③ Fit the cover in the direction of the arrow (❸), then close (❹). Hook the battery cover release hook until it makes a 'click' sound (❺). (Fig.3)

CAUTION:

- When installing batteries, make sure they are all the same brand, type and capacity. Also, do not mix new and old batteries together.
- Keep battery contacts clean. It's a good idea to occasionally clean them.
- Never incinerate used battery cells since internal battery gas may cause them to rupture.
- Never expose a detached battery case to water. If the battery case gets wet, be sure to wipe it dry before using it.

NOTE: When the optional battery case is attached, the battery type must be selected to "Alkaline battery operation" when turning the transceiver ON. Ask your dealer for details.

Fig.1

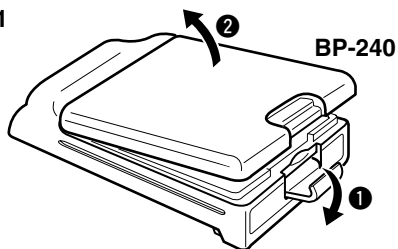

Fig.2

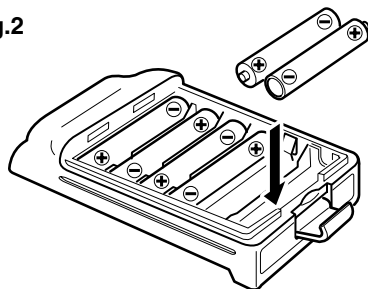
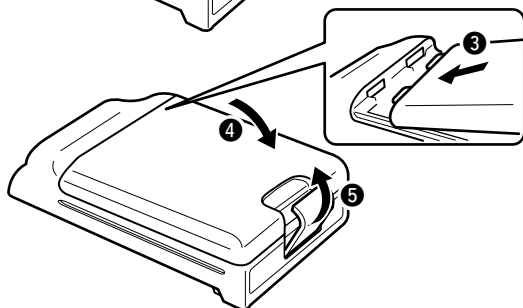

Fig.3



7 SWIVEL BELT CLIP

■ MB-93 contents

	Qty.
① Belt clip	1
② Base clip	1

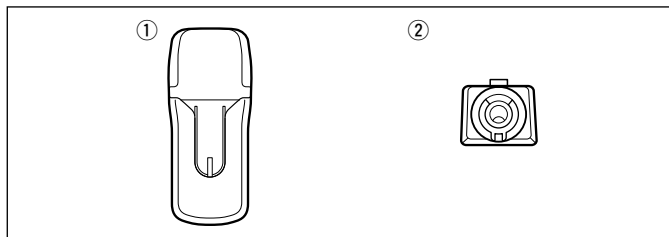

■ To attach

- ① Remove the battery pack if it is attached. (p. 3)
- ② Slide the base clip in the direction of the arrow until the base clip is locked and makes a 'click' sound.

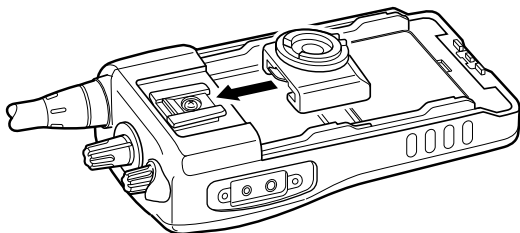

- ③ Clip the belt clip to a part of your belt. And insert the transceiver into the belt clip until the base clip inserted fully into the groove.

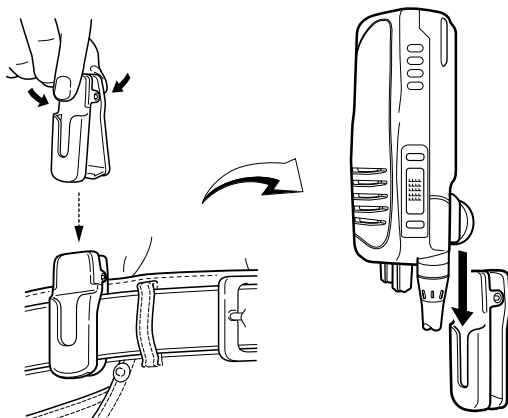

- ④ Once the transceiver is locked in place, it swivels as illustrated below.

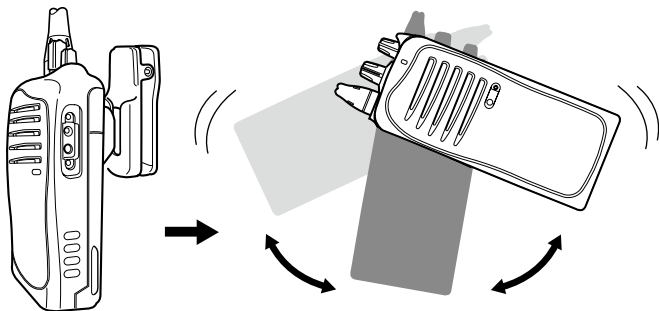

Once the transceiver is locked in place, it will swivel 360 degrees.

■ To detach

- ① Turn the transceiver upside down in the direction of the arrow and pull out from the belt clip.

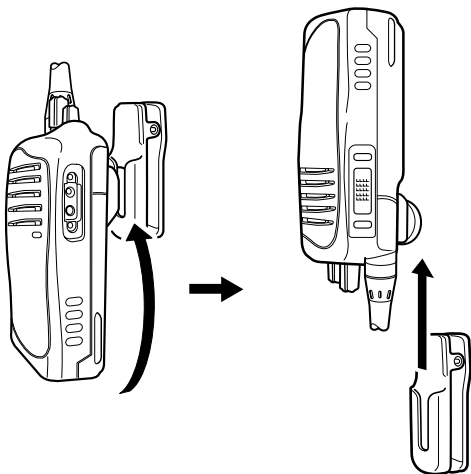

- ② Remove the battery pack if it is attached. (p. 3)
- ③ Pinch the clip (①), and slide the base clip in the direction of the arrow (②).

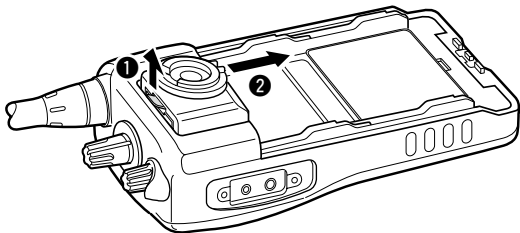

7

CAUTION:

HOLD THE TRANSCEIVER TIGHTLY, WHEN HANGING OR DETACHING THE TRANSCEIVER FROM THE BELT CLIP.

Otherwise the transceiver may not be attached to the holder or swivel properly if the transceiver is accidentally dropped and the base clip is scratched or damaged.

8 OPTIONS

◇ BATTERY PACK

Battery pack	Voltage	Capacity	Battery life* ¹
BP-230N	7.4 V	950 mAh (min.) 980 mAh (typ.)	9 hrs.
BP-232N	7.4 V	1900 mAh (min.) 2000 mAh (typ.)	18 hrs.
BP-232H	7.4 V	2250 mAh (min.) 2300 mAh (typ.)	21 hrs.
BP-240	Battery case for AAA (LR03) × 6 alkaline		—* ²

*¹ When the power save function is turned ON, and the operating periods are calculated under the following conditions;

TX : RX : standby = 5 : 5 : 90

*² Operating period depends on the alkaline cells used.

◇ CHARGERS

- **BC-119N** DESKTOP CHARGER + **AD-106** CHARGER ADAPTER
+ **BC-145S** AC ADAPTER

For rapid charging of battery packs. An AC adapter is supplied with the charger depending on versions.

Charging time: Approximately 3 hours when BP-232H is attached.

- **BC-121N** MULTI-CHARGER + **AD-106** CHARGER ADAPTER (6 pcs.)
+ **BC-157** AC ADAPTER

For rapid charging of up to 6 battery packs (six AD-106's are required) simultaneously. An AC adapter should be purchased separately.

Charging time: Approximately 3 hours when BP-232H is attached.

- **BC-160** DESKTOP CHARGER + **BC-145S** AC ADAPTER

For rapid charging of battery packs. An AC adapter is supplied with the charger depending on versions.

Charging time: Approximately 3 hours when BP-232H is attached.

- **BC-171** DESKTOP CHARGER + **BC-147S** AC ADAPTER

For regular charging of battery packs. We recommend that the BP-230N charging. An AC adapter is supplied with the charger depending on versions.

Charging time: Approximately 11 hours when BP-232H is attached.

Approximately 4 hours when BP-230N is attached.

◇ BELT CLIPS

- **MB-93** SWIVEL BELT CLIP

- **MB-94** BELT CLIP

Exclusive alligator-type belt clip.

- **MB-96N/96F** LEATHER BELT HANGER

◇ DC CABLES

- **CP-23L** CIGARETTE LIGHTER CABLE

Allows charging of the battery pack through a 12 V cigarette lighter socket. (For BC-119N/BC-160/BC-171)

- **OPC-515L/OPC-656** DC POWER CABLES

Allows charging of the battery pack using a 13.8 V power source instead of the AC adapter.

OPC-515L: For BC-119N/BC-160/BC-171

OPC-656 : For BC-121N

8 OPTIONS

◇ ANTENNAS

- **FA-SC73US/FA-SC56VS/FA-SC57VS** STUBBY ANTENNAS
FA-SC73US: 450–490 MHz FA-SC56VS: 150–162 MHz
FA-SC57VS: 160–174 MHz
- **FA-SC01U/FA-SC25U/FA-SC57U/FA-SC72U/FA-SC25V/
FA-SC55V** ANTENNAS
FA-SC01U: 350–400 MHz FA-SC25U: 400–430 MHz
FA-SC57U: 430–470 MHz FA-SC72U: 470–520 MHz
FA-SC25V: 136–155 MHz FA-SC55V: 146–174 MHz
- **FA-SC61VC/FA-SC61UC** CUT ANTENNAS
FA-SC61VC: 136–174 MHz FA-SC61UC: 380–520 MHz

◇ OTHER OPTIONS

- **SP-13** EARPHONE
Provides clear receive audio in noisy environment.
- **HM-153L** EARPHONE-MICROPHONE
- **HM-131L/158L/159L** SPEAKER-MICROPHONE
Combination speaker-microphone that provides convenient operation while hanging the transceiver from your belt.
- **VS-1L** VOX/PTT CASE + **HS-94/HS-95/HS-97** HEADSET
VS-1L: VOX/PTT switch box for hands-free operation, etc.
HS-94: Ear hook type HS-95: Neck-arm type
HS-97: Throat microphone
- **MB-130** VEHICLE CHARGER BRACKET
Vehicle mounting bracket for the BC-160 battery charger.

Approved Icom optional equipment is designed for optimal performance when used with an Icom transceiver.

Icom is not responsible for the destruction or damage to an Icom transceiver in the event the Icom transceiver is used with equipment that is not manufactured or approved by Icom.

Some options may not be available in some countries. Please ask your dealer for details.

◇ About VS-1L VOX/PTT CASE

The VS-1L is a VOX/PTT unit for Icom handheld transceivers, and allows you hands-free operation.

An optional headset (HS-94, etc.) is additionally required for operation.

- The VOX (voice operated transmission) function starts transmission without pushing PTT switch when you speak into the microphone; then, automatically returns to receive when you stop speaking.

Features

- Straight type head SP/MIC plug equipped
- Water resistant construction
- Durable construction
- Equipped with a PTT switch and revolving clip.

MIC/VOX gain adjustment

- 1 Remove the water protection cover on the right side of the VS-1L.
- 2 Adjust the MIC/VOX gain with a thin screw driver. Clockwise rotation increases the MIC/VOX gain.
- 3 Return the protective cover back to the MIC/VOX gain adjustment hole.

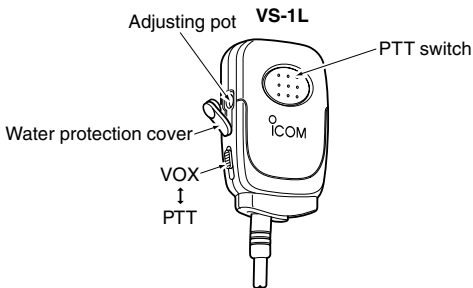

9 FCC INFORMATION

• FOR CLASS B UNINTENTIONAL RADIATORS:

This equipment has been tested and found to comply with the limits for a Class B digital device, pursuant to part 15 of the FCC Rules. These limits are designed to provide reasonable protection against harmful interference in a residential installation. This equipment generates, uses and can radiate radio frequency energy and, if not installed and used in accordance with the instructions, may cause harmful interference to radio communications. However, there is no guarantee that interference will not occur in a particular installation. If this equipment does cause harmful interference to radio or television reception, which can be determined by turning the equipment off and on, the user is encouraged to try to correct the interference by one or more of the following measures:

- Reorient or relocate the receiving antenna.
- Increase the separation between the equipment and receiver.
- Connect the equipment into an outlet on a circuit different from that to which the receiver is connected.
- Consult the dealer or an experienced radio/TV technician for help.

Count on us!

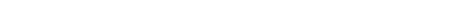
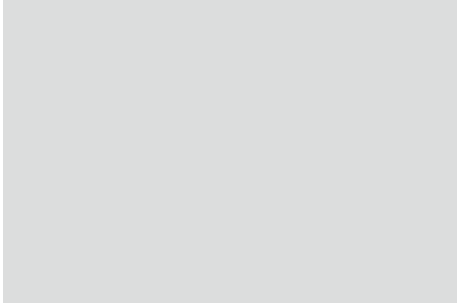

A-6768H-1EX-②

Printed in Japan

© 2009–2012 Icom Inc.

Printed on recycled paper with soy ink.

Icom Inc.

1-1-32 Kamiminami, Hirano-ku, Osaka 547-0003, Japan