



INSTRUCTION MANUAL

VHF MARINE TRANSCEIVER IC-GM1600

This device complies with Part 15 of the FCC Rules. Operation is subject to the condition that this device does not cause harmful interference.

Icom Inc.

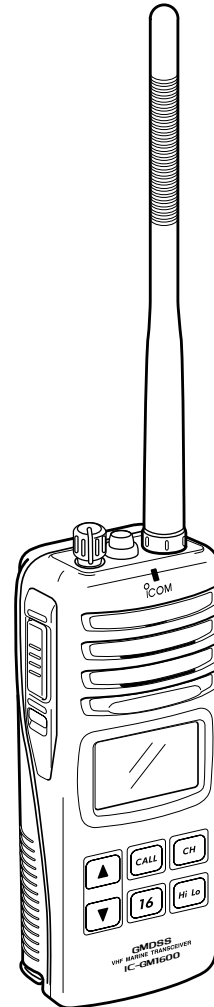

SAFETY TRAINING INFORMATION



Your Icom radio generates RF electromagnetic energy during transmit mode.

This radio has been evaluated for compliance at the distance of 2.5 cm with the FCC RF exposure limits for “Occupational Use Only”. In addition, your Icom radio complies with the following Standards and Guidelines with regard to RF energy and electromagnetic energy levels and evaluation of such levels for exposure to humans:

levels for exposure to humans:

- FCC OET Bulletin 65 Edition 97-01 Supplement C, Evaluating Compliance with FCC Guidelines for Human Exposure to Radio Frequency Electromagnetic Fields.
- American National Standards Institute (C95.1-1992), IEEE Standard for Safety Levels with Respect to Human Exposure to Radio Frequency Electromagnetic Fields, 3 kHz to 300 GHz.
- American National Standards Institute (C95.3-1992), IEEE Recommended Practice for the Measurement of Potentially Hazardous Electromagnetic Fields– RF and Microwave.
- The following accessories are authorized for use with this product. Use of accessories other than those specified may result in RF exposure levels exceeding the FCC requirements for wireless RF exposure.; Belt Clip (MB-86, MB-103Y), Rechargeable Ni-Cd Battery Pack (BP-224) and Lithium Battery Pack (BP-234).



To ensure that your expose to RF electromagnetic energy is within the FCC allowable limits for occupational use, always adhere to the following guidelines:

- **DO NOT** operate the radio without a proper antenna attached, as this may damaged the radio and may to exceed FCC RF exposure limits. A proper antenna is the antenna supplied with this radio by the manufacturer or an antenna specifically authorized by the manufacturer for use with this radio.
- **DO NOT** transmit for more than 50% of total radio use time (“50% duty cycle”). Transmitting more than 50% of the time can cause FCC RF exposure compliance requirements to be exceeded. The radio is transmitting when the “TX indicator” lights red. You can cause the radio to transmit by pressing the “PTT” switch.
- **ALWAYS keep** the antenna at least 2.5 cm (1 inch) away from the body when transmitting and only use the Icom belt-clips which are listed on page 33 when attaching the radio to your belt, etc., to ensure FCC RF exposure compliance requirements are not exceeded. To provide the recipients of your transmission the best sound quality, hold the radio in an almost vertical position at least 5 cm (2 inches) from your mouth, the microphone is located next to the speaker, so you should “talk into the speaker”.

The information listed above provides the user with the information needed to make him or her aware of RF exposure, and what to do to assure that this radio operates within FCC RF exposure limits.

Electromagnetic Interference/Compatibility

During transmissions, your Icom radio generates RF energy that can possibly cause interference with other devices or systems. To avoid such interference, turn off the radio in areas where signs are posted to do so. **DO NOT** operate the transmitter in areas that are sensitive to electromagnetic radiation such as hospitals, aircraft, and blasting sites.

IN CASE OF EMERGENCY

If your vessel requires assistance, contact other vessels and the Coast Guard by sending a distress call on Channel 16.

○ **USING CHANNEL 16**

DISTRESS CALL PROCEDURE

1. "MAYDAY MAYDAY MAYDAY."
2. "THIS IS" (name of vessel)
3. Your call sign or other indication of the vessel.
4. "LOCATED AT" (your position)
5. The nature of the distress and assistance required.
6. Any other information which might facilitate the rescue.

RECOMMENDATION

CLEAN THE TRANSCEIVER THOROUGHLY WITH FRESH WATER after exposure to saltwater, and dry it before operation. Otherwise, the transceiver's keys, switches and controllers may become inoperable due to salt crystallization.

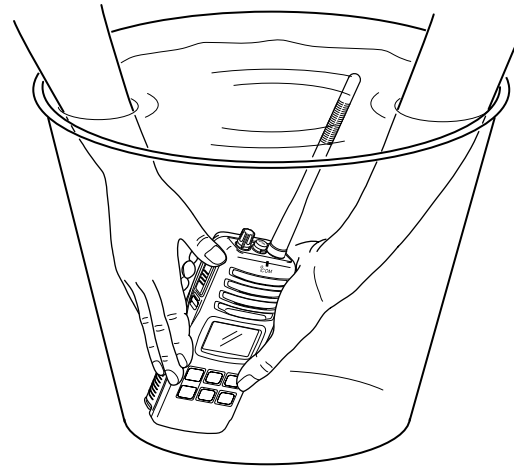

FOREWORD

Thank you for purchasing this Icom radio. The IC-GM1600 VHF MARINE TRANSCEIVER is designed and built with Icom's state of the art technology and craftsmanship. With proper care this product should provide you with years of trouble-free operation.

IMPORTANT

READ ALL INSTRUCTIONS carefully and completely before using the transceiver.

SAVE THIS INSTRUCTION MANUAL—This instruction manual contains important operating instructions for the IC-GM1600.

EXPLICIT DEFINITIONS

| WORD | DEFINITION |
|------------------|---|
| ⚠ WARNING | Personal injury, fire hazard or electric shock may occur. |
| CAUTION | Equipment damage may occur. |
| NOTE | If disregarded, inconvenience only. No risk of personal injury, fire or electric shock. |

FEATURES

Waterproof construction

Built tough to withstand the punishing marine environment, the IC-GM1600 meets JIS waterproof specification grade 7 while using BP-234 (option) or BP-224.

In addition to, the speaker grill adopts a new structure which drains water or seawater easily.

Large, easy-to-read LCD

With dimensions of 19(H) × 35(W) mm; ¾(H) × 1⅜(W) inch, the IC-GM1600's function display is easy to read and shows operating conditions at a glance. Backlighting and contrast can be adjusted to suit your preferences.

Simple operation

6 large buttons on the front panel provide user-friendly operation. The independent volume and channel buttons are located on the front panel for convenient one-handed operation.

PRECAUTION

⚠ WARNING! NEVER connect the transceiver to an AC outlet. This may pose a fire hazard or result in an electric shock.

⚠ WARNING! NEVER hold the transceiver so that the antenna is closer than 2.5 cm (1 inch) from exposed parts of the body, especially the face or eyes, while transmitting. The transceiver will perform best if the microphone is 5 to 10 cm (2 to 4 inches) away from the lips and the transceiver is vertical.

NEVER connect the transceiver to a power source other than the BP-224 or BP-234. Such a connection will ruin the transceiver.

AVOID using or placing the transceiver in direct sunlight or in areas with temperatures below -20°C (-4°F) or above $+60^{\circ}\text{C}$ ($+140^{\circ}\text{F}$).

KEEP the transceiver out of the reach of children.

KEEP the transceiver at least 0.9 meters (3.0 ft) away from your vessel's magnetic navigation compass.

MAKE SURE the flexible antenna and battery pack are securely attached to the transceiver, and that the antenna and battery pack are dry before attachment. Exposing the inside of the transceiver to water will result in serious damage to the transceiver.

BE CAREFUL! The IC-GM1600 employs waterproof construction, which corresponds to JIS waterproof specification, Grade 7 (1 m; 3 ft depth for 30 min.). However, once the transceiver has been dropped, waterproofing cannot be guaranteed due to the fact that the transceiver may be cracked, or the waterproof seal damaged, etc.

For U.S.A. only

CAUTION: Changes or modifications to this device, not expressly approved by Icom Inc., could void your authority to operate this device under FCC regulations.

Icom, Icom Inc. and the ICOM logo are registered trademarks of Icom Incorporated (Japan) in the United States, the United Kingdom, Germany, France, Spain, Russia and/or other countries.

◇ **Priorities**

- Read all rules and regulations pertaining to priorities and keep an up-to-date copy handy. Safety and distress calls take priority over all others.
- You must monitor Channel 16 when you are not operating on another channel.
- False or fraudulent distress calls are prohibited under law.

◇ **Privacy**

- Information overheard but not intended for you cannot lawfully be used in any way.
- Indecent or profane language is prohibited.

◇ **Radio licenses**

(1) SHIP STATION LICENSE

When your craft is equipped with a VHF FM transceiver, you must have a current radio station license before using the transceiver. It is unlawful to operate a ship station which is not licensed.

Inquire through your dealer or the appropriate government agency for a Ship-Radiotelephone license. This license includes the call sign which is your craft's identification for radio purposes.

(2) OPERATOR'S LICENSE

A restricted Radiotelephone Operator Permit is the license most often held by small vessel radio operators when a radio is not required for safety purposes.

The Restricted Radiotelephone Operator Permit must be posted near the transceiver or be kept with the operator. Only a licensed radio operator may operate a transceiver.

However, non-licensed individuals may talk over a transceiver if a licensed operator starts, supervises, ends the call and makes the necessary log entries.

A current copy of the applicable government rules and regulations is only required to be on hand for vessels in which a radio telephone is compulsory. However, even if you are not required to have these on hand it is your responsibility to be thoroughly acquainted with all pertinent rules and regulations.

■ Supplied accessories

| The following accessories are supplied: | Qty. |
|---|------|
| ① Handstrap | 1 |
| ② Battery charger (BC-158) | 1 |
| ③ Belt clip (MB-103Y) | 1 |
| ④ AC adapter (BC-147A) | 1 |
| ⑤ Ni-Cd battery pack (BP-224) | 1 |

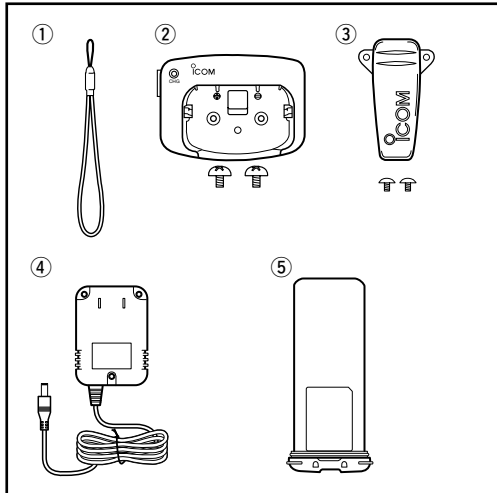

■ Attachments

◇ Handstrap

Pass the handstrap through the loop on the top of the transceiver as illustrated at right. Facilitates carrying.

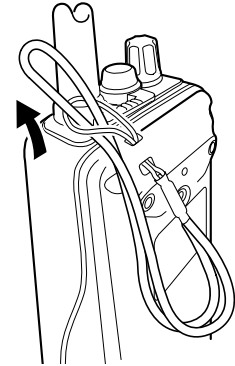

◇ Belt clip

Attach the belt clip to the transceiver as illustrated below.

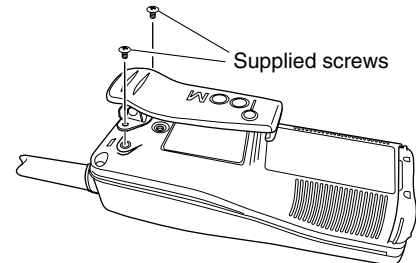

◆ **Battery pack**

To remove the battery pack:

Turn the screw counterclockwise, then pull the battery pack in the direction of the arrow as shown below.

To attach the battery pack:

Insert the battery pack in the IC-GM1600 completely, then turn the screw clockwise.

NEVER remove or insert the battery pack when the transceiver is wet or soiled. This may result water or dust getting into the transceiver/battery pack and may result in the transceiver being damaged.

NOTE: When the lock screw does not easily (feels tight), check to ensure the battery pack is sufficiently inserted to the transceiver. **DO NOT** bang or cause high impact to the battery pack, as this may damage the battery pack/or the transceiver.

Screw position when removing battery

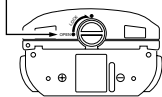

Screw position when attaching battery

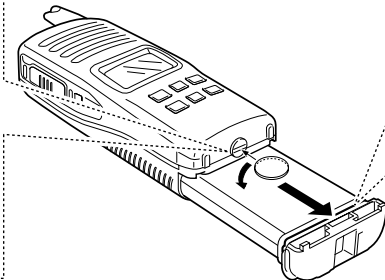
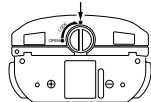

NOTE: When removing or attaching the battery pack, use a coin or flat-blade screwdriver to loosen or tighten the bottom screw.

CAUTION!: When attaching or removing a battery pack, make sure the rubber seal is set in the groove of the battery pack correctly. If the seal is not neatly in the groove it may be damaged when attaching the battery pack. If the seal is damaged, waterproofing is not guaranteed.

NOTE: When attaching a battery pack, make sure dust or else does not adhere to the rubber seal. If dust or else is on the seal when attaching a battery pack, the water resistant may be reduced.

Make sure both the rubber seal (purple) is set to the groove correctly and dust or else does not adhere to it.

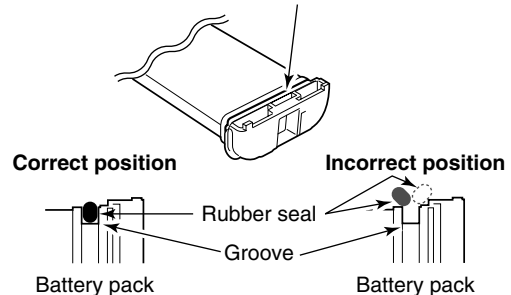

3

PANEL DESCRIPTION

■ Front, top and side panels

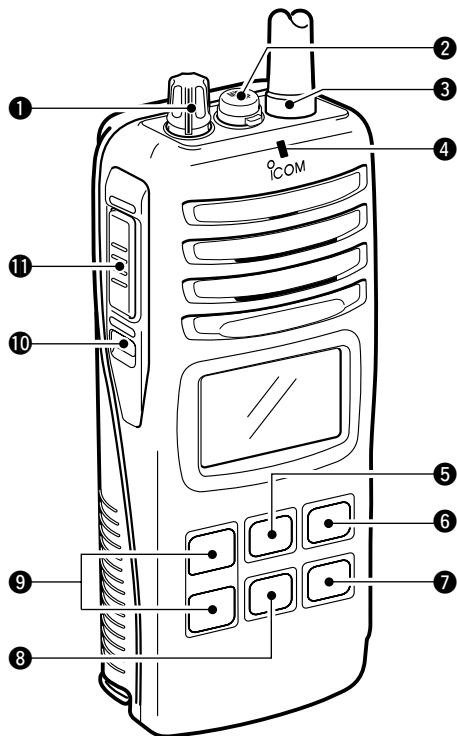

① VOLUME CONTROL [VOL]

Turns power ON and adjusts the audio level.

② MICROPHONE CONNECTOR [SP MIC]

Connects the optional external microphone.

NOTE: Attach the [SP MIC] cap when the optional speaker-microphone is not used.

③ ANTENNA

④ TRANSMIT/RECEIVE INDICATOR

Lights green while receiving a signal or when the squelch is open; lights red while transmitting (lights orange while VOX function is used).

⑤ CALL CHANNEL SWITCH [CALL]

➔ Selects the call channel when pushed. (p. 7)

- Channel 9 is factory default.

➔ Push for 3 sec. to enter call channel programming condition. (p. 9)

⑥ CHANNEL SWITCH [CH]

Push to return the previous condition when priority channel or call channel is selected. (p. 7)

⑦ TRANSMIT POWER/LOCK SWITCH [Hi/Lo]

➔ Selects high or low power when pushed. (p. 8)

➔ Toggles the lock function ON/OFF when pushed for 1 sec. (p. 10)

8 CHANNEL 16 SWITCH [16]

Selects Channel 16 when pushed. (p. 7)

9 CHANNEL UP/DOWN SWITCHES [▲]/[▼]

- Selects an operating channel. (pgs. 7–8)
- Selects the SET mode condition of the item. (p. 11)
- Selects the SET mode item when pushed with [SQL] switch (p. 11)

10 SQUELCH SWITCH [SQL•MONI]

- Push this switch, then adjust the squelch level with [▲]/[▼]. (p. 9)
- Manually opens the squelch for monitoring the channel while pushed and held. (p. 10)
- While pushing this switch, turn power ON to enter the set mode. (p. 11)

11 PTT SWITCH [PTT]

Push and hold to transmit; release to receive.

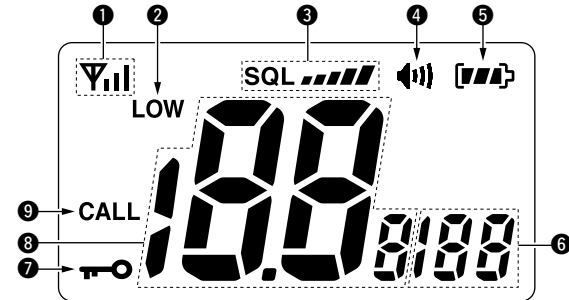
Function display**1 SIGNAL STRENGTH INDICATOR** (pgs. 10, 14)

Shows the relative signal strength while receiving signals.

2 TRANSMIT POWER INDICATOR (p. 8)

- “LOW” appears when low power is selected.
- No indication appears when high power is selected.

3 SQUELCH LEVEL INDICATOR (p. 9)

Show the squelch level.





4 MONITOR INDICATOR (p. 10)

Appears when the monitor function is activated.

3 PANEL DESCRIPTION

5 BATTERY INDICATOR

Indicates remaining battery power.

| Indication |  |  |  |  |
|---------------|---|---|---|---|
| Battery level | Full | Middle | Charging required | No battery |

 blinks when the battery is over charged.

 blinks when the battery is exhaustion.

6 SET MODE ITEM READOUT

Indicates the SET mode item while in the SET mode.
(p. 11)

7 LOCK INDICATOR

Appears when the lock function is activated. (p. 10)

8 CHANNEL NUMBER READOUT

- ➔ Indicates the selected operating channel number.
- ➔ In SET mode, indicates the selected condition.

9 CALL CHANNEL INDICATOR

Appears when the call channel is selected. (p. 7)

■ Channel selection

IMPORTANT!: Prior to using the transceiver for the first time, the battery pack must be fully charged for optimum life and operation. To avoid damage to the transceiver, turn the power OFF while charging.

◇ Channel 16

Channel 16 (Distress channel) is used for establishing initial contact with another station and for emergency communications. While standing by, you must monitor Channel 16.

- ① Push [16] to select Channel 16.
- ② Push [CH] to return to the condition before selecting Channel 16, or push [▲]/[▼] to select the operating channel.

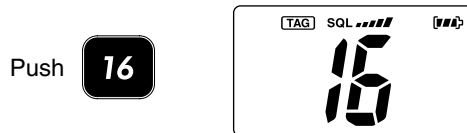

◇ Channel 9 (Call channel)

Channel 9 is the leisure-use call channel. The call channels can be re-programmed (p. 9) and may be used to store your most often used channels for quick recall.

- ① Push [CALL] to select the call channel.
 - "CALL" and the call channel number appear.
 - Call channel can be re-programmed. See the "Call channel programming" on p. 9 for details.
- ② Push [CH] to return to the condition before selecting Channel 9 (call channel), or push [▲]/[▼] to select the operating channel.

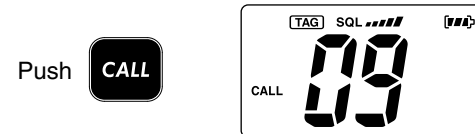

4 BASIC OPERATION

■ Receiving and transmitting

CAUTION: Transmitting without an antenna may damage the transceiver.

- ① Rotate [VOL] clockwise to turn power ON.
- ② Set the volume and squelch level.
 - ➔ Push [SQL•MONI], and push [▼] to open the squelch.
 - ➔ Push [SQL•MONI] to stop “SQL” indicator blinking, then rotate [VOL] to set the volume level.
 - ➔ Push [SQL•MONI], and push [▲]/[▼] to set the squelch level.
- ③ Push [▲]/[▼] to select the desired channel.
 - When receiving a signal, the [TRANSMIT/RECEIVE] indicator lights green while audio is emitted from the speaker.
 - Further adjustment of [VOL] may be necessary at this point.
- ④ Push [Hi/Lo•] to select the output power if necessary.
 - “LOW” appears when low power is selected; no indication when high power is selected.
 - Choose low power to conserve battery power, choose high power for longer distance communications.
 - Some channels are for low power only.
- ⑤ Push and hold [PTT] to transmit, then speak into the microphone.
 - The [TRANSMIT/RECEIVE] indicator lights red while transmitting.
- ⑥ Release [PTT] to receive.

IMPORTANT: To maximize the readability of your transmitted signal, pause a few sec. after pushing [PTT], hold the microphone 5 to 10 cm (2 to 4 inches) from your mouth and speak into the microphone at a normal voice level.

NOTE: The transceiver has a power save function to conserve the battery power. The power save function activates automatically when no signal is received for 5 sec.

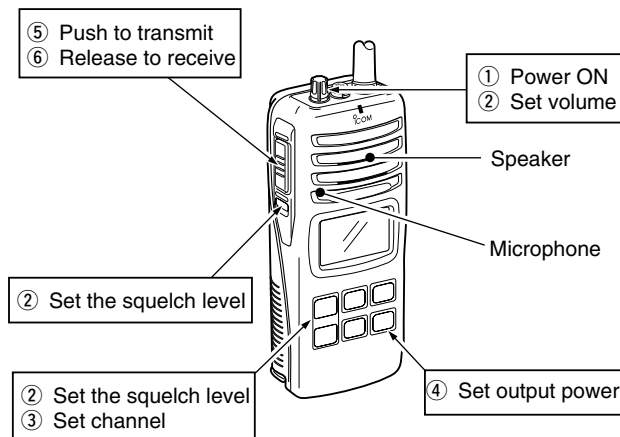

■ Call channel programming

The call channel switch is used to select Channel 9 by default, however, you can program your most often-used channel for quick recall.

- ① Push [CALL] for 1 sec. to select the call channel.
 - “CALL” and call channel number appear.



- ② Push [CALL] again for 3 sec. (until a long beep changes to 2 short beeps) to enter call channel programming condition.
 - Call channel number to be programmed flashes.

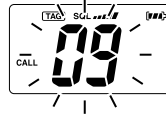

- ③ Push [▲]/[▼] to select the desired channel.

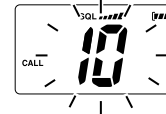

- ④ Push [CALL] to program the displayed channel as the call channel.
 - The call channel number stop flashing.

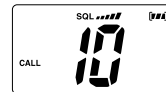

■ Adjusting the squelch level

To adjust the IC-GM1600's squelch level, use the [▲]/[▼] keys as desired below. In order to receive signals properly, as well as for the scan to function effectively, the squelch must be adjusted to the proper level.

- ① Push [SQL•MONI], then adjust the squelch level with [▲]/[▼].
 - “SQL” indicator starts blinking.
 - There are 11 squelch levels to choose from: OP is completely open; 10 is tight squelch; 1 is loose squelch level.
 - When no switch is pushed for 5 sec., the transceiver returns to normal condition.

Blinks during the squelch level adjustment.

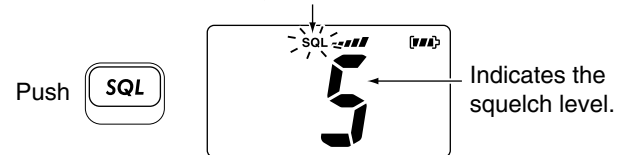

- ② Push [SQL•MONI] again to return to normal condition.

4 BASIC OPERATION

■ Lock function

This function electronically locks all switches (except for [PTT], [SQL•MONI] and [Hi/Lo•



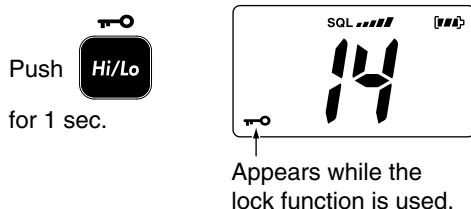

➔ Push [Hi/Lo•



■ Signal strength indicator function

The received signal strength level is indicated by number of bars as below.

This indicator can be hidden by using the set mode (p. 14) if desired.

| Indication |  |  |  |  |
|-----------------|---|---|---|---|
| Signal strength | Strong | Middle | Weak | No signal or very weak |

■ Monitor function

The monitor function releases the noise squelch mute to check the volume level. See p. 12 for details of the monitor switch action.

➔ Push [SQL•MONI] for 1 sec. to activate the monitor function.

- “

■ Backlighting function

This function is convenient for nighttime operation. The backlighting brightness can be adjusted in the SET mode. (p. 12)

➔ Push any switch except for [PTT] to turn the backlighting ON.

- The backlighting is automatically turned OFF after 5 sec. of inactivity.

■ SET mode programming

SET mode is used to change the condition of 9 transceiver functions: beep tone function, monitor switch action, back-lighting function, LCD contrast selection, auto power save function, self check function, battery voltage indicator, signal strength indicator and squelch sensitivity function.

◇ SET mode operation

- ① Turn power OFF.
- ② While pushing [SQL•MONI], turn power ON to enter the SET mode.
 - "bp" (Beep tone function setting) appears.
- ③ Push [SQL•MONI] or [SQL•MONI] and [▲]/[▼] to select the desired item, if necessary.
- ④ Push [▲]/[▼] to select the desired condition of the item.
- ⑤ To exit the SET mode, push [16].

◇ **SET MODE ITEMS** The displays show the default settings, and the selected item is displayed in the dotted circle.

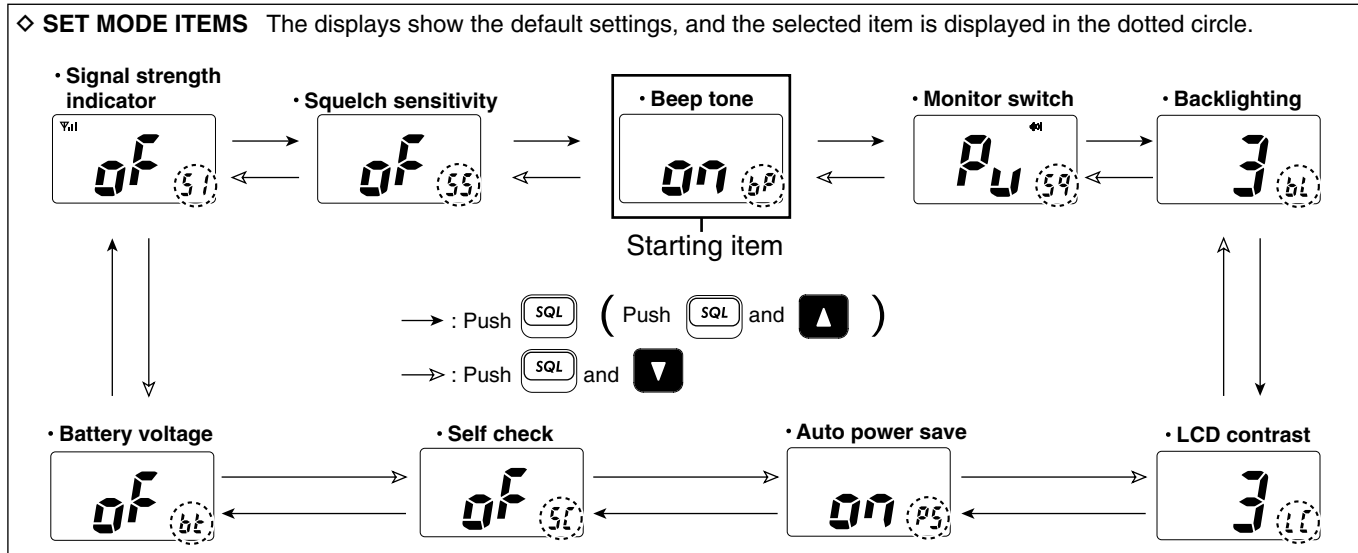

■ SET mode items

◇ Beep tone function “bP”

You can select silent operation by turning the beep tones OFF, or you can have 2 types of confirmation beeps sound at the push of a switch. When “ON” is selected, a fixed beep (Pi) sounds, and when “US” is selected, the preset beeps (e.g. do, re, mi) sound.

- Beep tone synchronises with the volume level.
- The beeps sound during call channel programming and a weather alert tone indication even if this function is turned OFF.

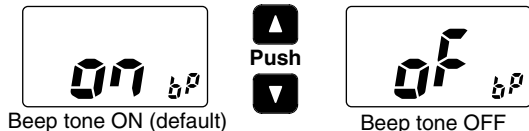

◇ Monitor switch action “Sq”

The monitor switch action cuts off the squelch function temporarily. This switch action contains PUSH (Pu) or HOLD (Ho) settings as shown below.

- Pu (PUSH): After pushing [SQL•MONI] for 1 sec., the squelch opens and emits audio. The squelch is held open while continuously pushing and holding [SQL]. (default)
- Ho (HOLD): After pushing [SQL•MONI] for 1 sec., the squelch opens and emits audio even [SQL•MONI] is released. To close the squelch, push any switch.

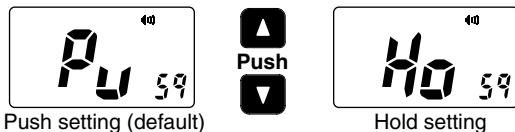

◇ Backlighting function “bL”

This function is convenient for nighttime operation. The backlighting brightness can be adjusted from OFF, 1 (dark)–3 (bright); 3 (default). Select 1–3 to turn this function ON.

- The automatic backlighting turns the backlighting ON when any switch except for [PTT] is pushed.
- The backlighting is automatically turned OFF after 5 sec. of inactivity.

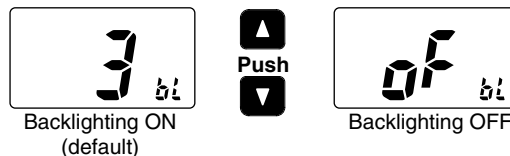

◇ LCD contrast selection “LC”

The contrast of the LCD can be adjusted from 4 levels.

- 1 (bright)–4 (dark); 3 (default)

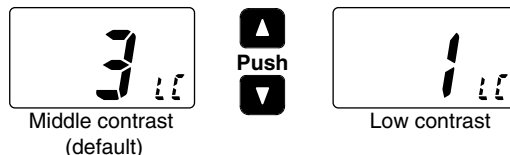

◇ **Auto power save function “PS”**

The auto power save function reduces current drain by deactivating the receiver circuit for preset intervals.

- ON : The power save function is turned ON. The power save function will activate when no signal is received, and no operation is performed for 5 sec.
- OFF: The power save function is turned OFF.

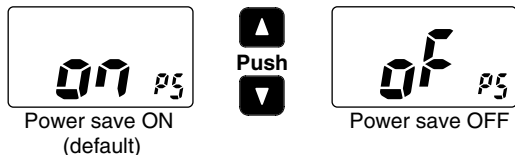

◇ **Self check function “SC”**

The self check function checks the transceiver conditions by itself, and informs you in case a problem is found. Self check automatically and quickly runs through its diagnostic steps each time the radio is turned ON. Afterwards, the radio switches to normal operation mode.

- Temperature : Outside of -35°C to $+80^{\circ}\text{C}$; -31°F to $+173^{\circ}\text{F}$ (approx.)
- Connected battery voltage

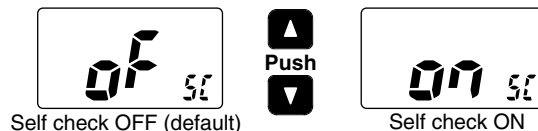

When error messages as shown below are displayed, see troubleshooting for advice. (p. 28)

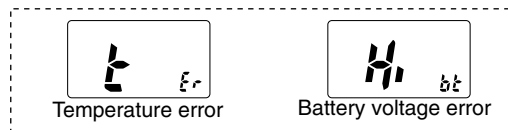

5 SET MODE

◇ Battery voltage indicator “bt”

This function controls display or non-display settings of the connected battery pack’s voltage when the power is ON.

- The voltage of the connected battery pack is displayed for 2 sec. after power is turned ON.

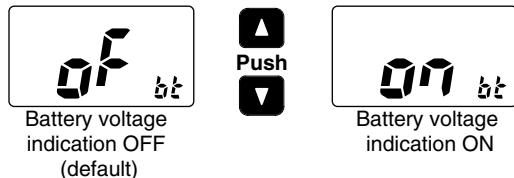

◇ Signal strength indicator “SI”

The signal strength indicator displays received signal strength as “S-meter”. This function is convenient to check the signal strength visually.

- The strength is displayed at 4 steps.
- The antenna mark and 3 bars appear when receiving strong signals.
- The antenna mark only appears when receiving no signal.

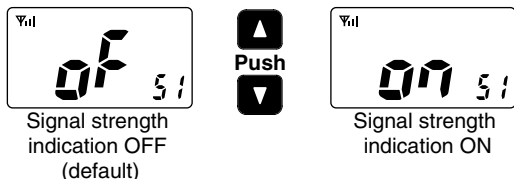

◇ Squelch sensitivity function “SS”

When this function is turned ON, blocking against noise is improved. Therefore the squelch is not easily affected by noise.

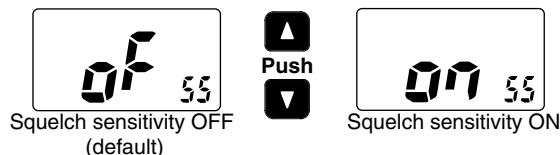

SET MODE LIST

| Function | Indication | Switch |
|---------------------------|------------|------------|
| Beep tone function | “bP” | OFF/ON*/US |
| Monitor switch action | “Sq” | Push*/Hold |
| Backlighting function | “bL” | OFF/1/2/3* |
| LCD contrast selection | “LC” | 1/2/3*/4 |
| Auto power save function | “PS” | OFF/ON* |
| Self check function | “SC” | OFF*/ON |
| Battery voltage indicator | “bt” | OFF*/ON |
| Signal strength indicator | “SI” | OFF*/ON |
| Squelch sensitivity | “SS” | OFF*/ON |

*default setting

■ Battery charging

Prior to using the transceiver for the first time, the battery pack must be fully charged for optimum life and operation.

/// **CAUTION:** To avoid damage to the transceiver, turn the power OFF while charging.

- Recommended temperature range for charging: +10°C to +40°C (+50°F to +104°F)
- Use the specified chargers (BC-158, BC-119N and BC-121N). **NEVER** use another manufacture's charger.
- Use the supplied AC adapter for the BC-158. **NEVER** use another manufacture's adapters.

/// **NEVER** connect DC power to the battery case when installing Alkaline batteries. Such a connection will damage the transceiver.

◇ Recycling information



The product that you have purchased contains a rechargeable battery. The battery is recyclable. At the end of its life, under various state and local laws, it may be illegal to dispose of this battery into the municipal waste stream. Call 1-800-822-8837 for battery recycling options in your area or contact your dealer.

Turn the transceiver OFF when charging an attached battery pack. Otherwise, the battery pack may not become full-charging or may not charge properly.

■ Battery cautions

CAUTION! NEVER insert battery pack/transceiver (with the battery pack attached) with wet or soiled into the charger. This may result in corrosion of the charger terminals or damage to the charger. The charger is not waterproof and water can easily get into it.

NEVER incinerate used battery packs. Internal battery gas may cause an explosion.

NEVER immerse battery pack in water. If the battery pack becomes wet, be sure to wipe it dry immediately (particularly the battery terminals BEFORE attaching it to the transceiver).

NEVER short the terminals of the battery pack. Also, current may flow into nearby metal objects, such as a necklace, etc. Therefore, be careful when carrying in a pocket, backpack or handbag, and when placing the radio near metal objects.

If your battery pack seem to have no capacity even after being charged, completely discharge it by leaving the power ON overnight. Then, fully charge the battery pack again. If the batteries still do not retain a charge (or very little), new battery pack must be purchased.

7 BATTERY CHARGING

◇ Charging connections

- ① Attach the BC-158 to a flat surface, such as a desk.
- ② Connect the AC adapter as shown below.
- ③ Insert the battery pack with/without the transceiver into the charger.
 - The charge indicator lights green.
- ④ Charge the battery pack approx. 8 hours, depending on the remaining power condition.

DO NOT charge the BP-224 more than 12 hours. Otherwise, the BP-224 will be damaged.

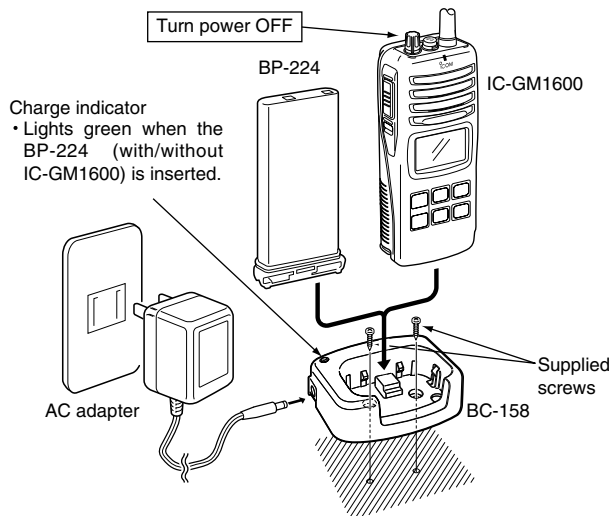

■ Optional battery pack

The optional BP-234 battery pack is a non-rechargeable, Lithium battery pack. The following precaution must be observed.

- **NEVER** dispose of the BP-234 or battery pack in a fire. This could result in a fire or explosion.
- **DO NOT** short-circuit the BP-234 or battery pack. Metal contact (such as paper clip, another battery, etc.) across the battery contacts can result in a sustained high rate discharge, which could damage the battery, void the warranty and create a burn or a fire hazard.
- **NEVER** expose of the BP-234 or battery pack to excessive heat of 60°C (+140°F) or above. This could result in electrolyte leakage, possibly causing an explosion or fire.
- **NEVER** attempt to recharge the BP-234 or battery pack. Lithium batteries may explode or cause a fire in such cases.
- **DO NOT** disassemble the BP-234 or battery pack. The BP-234 or battery pack contains no user serviceable parts. Internal battery gas can cause throat irritation. Also, exposed lithium may generate heat and ignite.
- **DO NOT** apply excessive pressure to the battery. This may result in electrolyte leakage, possibly causing a explosion or fire.
- The storage life of the BP-234 about 5 years. Once the expiration date on the battery pack expires, a new battery pack **must** be purchased.
- For safety reasons, once the BP-234 is used, a spare one should be purchased. The original battery pack can be continued to be used for regular communications; save the spare one for emergency situations.

■ Optional battery chargers

◇ AD-109 installation

- ① Connect the charger's 10-pins connector to the AD-109 desktop charger adapter's plug.

/// **NOTE:** The 3-pins connector is not used.

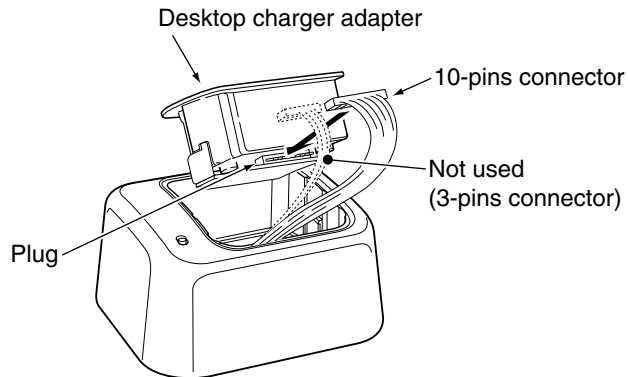

- ② Install the adapter into the charger in the direction of the arrow, then use the supplied 2 screws to attach the charger adapter to the charger.

/// **NOTE: BE CAREFUL** not to catch the unused 3-pins plug between the charger and the charger adapter.

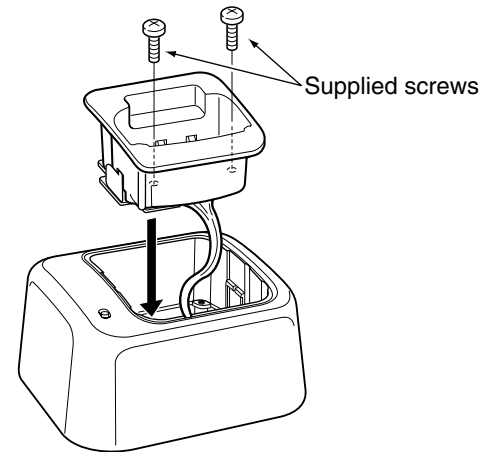

7 BATTERY CHARGING

◇ Rapid charging with the BC-119N+AD-109

The optional BC-119N provides rapid charging of battery packs. The following are additionally required.

- AD-109 charger adapter
- An AC adapter (BC-145A) or the DC power cable (OPC-515L/CP-17L).

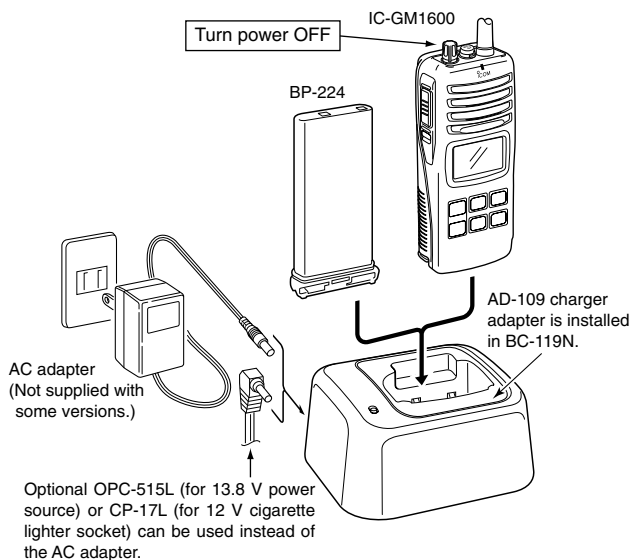

◇ Rapid charging with the BC-121N+AD-109

The optional BC-121N allows up to 6 battery packs to be charged simultaneously. The following are additionally required.

- Six AD-109 charger adapters
- An AC adapter (BC-124) or the DC power cable (OPC-656)

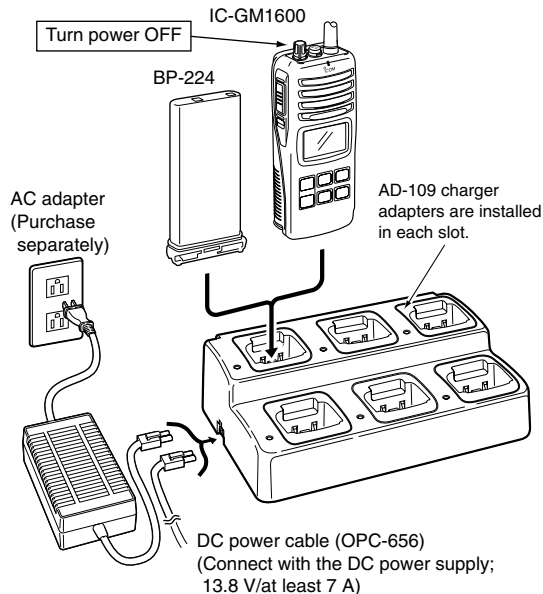

■ MB-86 contents

| | Qty. |
|-----------------------|------|
| Belt clip | 1 |
| Base clip | 1 |
| Supplied screws | 2 |

■ Attachment

- ① Screw the base clip to the back of the transceiver using the two screws (supplied) as shown below.

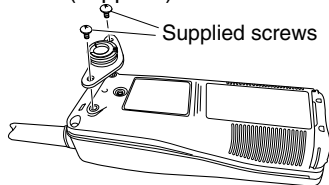

- ② Clip the belt clip over your belt and insert the transceiver.

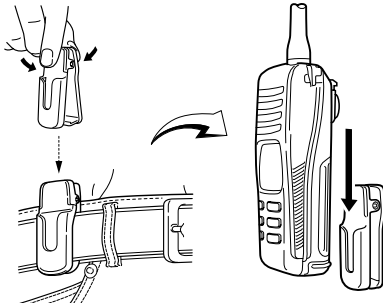

- ③ Once the transceiver is locked in place, it swivels as illustrated below.

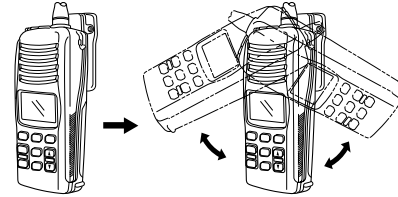

■ Detachment

- Turn the transceiver upside down in the direction of the arrow and pull out from the belt clip.

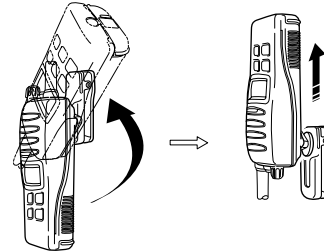

⚠ CAUTION!

HOLD THE TRANSCEIVER TIGHTLY, WHEN HANGING OR DETACHING THE TRANSCEIVER FROM THE BELT CLIP.

Otherwise the transceiver may not be attached to the belt clip or swivelled properly if the transceiver is accidentally dropped and the base clip is scratched or damaged.

■ HM-125 descriptions

Alligator type clip

To attach the speaker-mic.
to your shirt or collar, etc.

PTT switch

Transmits during push.
Receives during release.

Microphone

Speaker

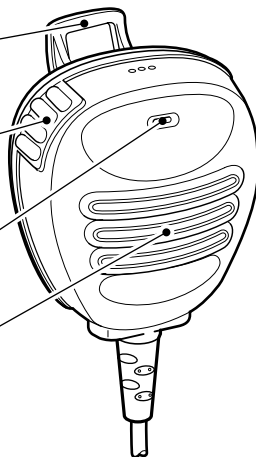

NEVER immerse the connector in water. If the connector becomes wet, be sure to dry **BEFORE** attaching it to the transceiver.

NOTE: The microphone is located at the top of the speaker-microphone, as shown in the diagram above. To maximize the readability of your transmitted signal (voice), hold the microphone approx. 2.5 cm (1 inch) from your mouth, and speak in a normal voice level.

■ Attachment

Insert the speaker-mic connector on to [SP MIC] connector and carefully screw it tight, as shown in the diagram below. Be careful not to cross thread the connection.

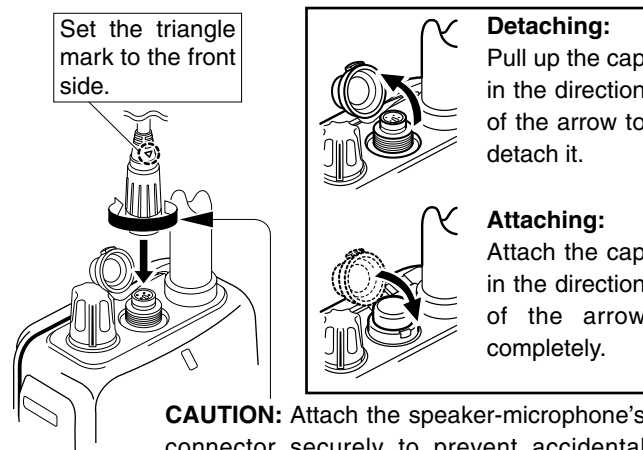



CAUTION: Attach the speaker-microphone's connector securely to prevent accidental dropping, or water intrusion in the connector.

IMPORTANT: KEEP the transceiver's [SP MIC] connector cap attached when the speaker-microphone is not in use. Water will not get into the transceiver even if the cover is not attached, however, the terminals (pins) will become rusty, or the transceiver will function abnormally if the connector has become wet.

TROUBLESHOOTING AND SURVIVAL CHANNELS

• TROUBLESHOOTING

| PROBLEM | POSSIBLE CAUSE | SOLUTION | REF. |
|--|--|--|-------------------------------------|
| The transceiver does not turn ON. | <ul style="list-style-type: none"> The battery is exhausted. Bad connection to the battery pack. | <ul style="list-style-type: none"> Recharge the battery pack. Check the connection to the transceiver. | p. 22 p. 3 |
| No sound from the speaker. | <ul style="list-style-type: none"> Squelch level is too deep. Volume level is too low. Speaker has been exposed to water. Water has entered to [SP MIC] connector. | <ul style="list-style-type: none"> Set squelch to the threshold point. Rotate [VOL] to set a suitable level. Drain water from the speaker. Dry [SP MIC] connector. | p. 9 p. 8 — — |
| Transmitting is impossible, or high power can not be selected. | <ul style="list-style-type: none"> Some channels are for low power or receive only. The battery is exhausted. The battery is over charged. The output power is set to low. | <ul style="list-style-type: none"> Change channels. Recharge the battery pack. Verify the battery voltage is correct. Push [Hi/Lo•] to select high power. | pgs. 8, 29 p. 22 — p. 8 |
| The displayed channel cannot be changed. | <ul style="list-style-type: none"> Lock function is activated. | <ul style="list-style-type: none"> Push [Hi/Lo•] for 1 sec. to cancel the function. | p. 10 |
| No beeps. | <ul style="list-style-type: none"> Beep tones are turned OFF. | <ul style="list-style-type: none"> Set the beep tones to ON (Fix Beep/User Beep) on the SET mode. | p. 12 |
| Self check error. (Temperature) | <ul style="list-style-type: none"> The temperature is outside of -35°C to $+80^{\circ}\text{C}$; -31°F to $+173^{\circ}\text{F}$ (approx.). | <ul style="list-style-type: none"> Leave the transceiver at room temperature for a while. Turn the power ON to check if the internal temperature has returned to normal. | — |
| Self check error. (Battery voltage) | <ul style="list-style-type: none"> The connected battery pack's voltage is more than 11 V. | <ul style="list-style-type: none"> Verify the battery voltage is correct. | — |

• SURVIVAL CHANNELS

Unit: MHz

| CH | TX/RX | CH | TX/RX | CH | TX/RX | CH | TX/RX | CH | TX/RX | CH | TX/RX | CH | TX/RX | CH | TX/RX |
|-----|---------|----|---------|-----|---------|-----------------|---------|----|---------|----|---------|----|---------|----|---------|
| 06 | 156.300 | 08 | 156.400 | 09 | 156.450 | 10 | 156.500 | 11 | 156.550 | 12 | 156.600 | 13 | 156.650 | 14 | 156.700 |
| 15* | 156.750 | 16 | 156.800 | 17* | 156.850 | 67 | 156.375 | 68 | 156.425 | 69 | 156.475 | 71 | 156.575 | 72 | 156.625 |
| 73 | 156.675 | 74 | 156.725 | 77 | 156.875 | *Low power only | | | | | | | | | |

11 SPECIFICATIONS

GENERAL

- Frequency coverage
TX/RX : 156.300–156.875 MHz
- Mode : 16K0G3E
- Channel spacing : 25 kHz
- Power supply requirement : BP-234 or BP-224
- Current drain (at 7.5 V DC) : TX High (2 W) 1.0 A typical
Max. audio 200 mA typical
Power save 20 mA typical
- Useable temperature range : –20°C to +60°C; –4°F to +140°F
- Frequency stability : ±5 ppm
(–20°C to +60°C;
–22°F to +140°F)
- Antenna impedance : 50 Ω
- Dimensions : 65(W) × 145(H) × 44(D) mm
(Projections not included) 2⁹/₁₆(W) × 5²³/₃₂(H) × 1³/₄(D) inch
- Weight (with BP-224) : Approx. 385 g (13.6 oz)

TRANSMITTER

- Output power (at 7.5 V DC) : 2 W (Hi) and 1 W (Low)
- Modulation system : Variable reactance frequency modulation
- Microphone impedance : 2 kΩ
- Max. frequency deviation : ±5 kHz
- Adjacent channel power : 70 dB
- Spurious emissions : Less than –70 dBc typical

RECEIVER

- Receive system : Double-conversion superheterodyne
- Sensitivity (12 dB SINAD) : 0.25 μV typical
- Squelch sensitivity : Less than 0.35 μV typical (at threshold)
- Intermodulation rejection ratio : 70 dB typical
- Spurious response rejection ratio : 70 dB typical
- Adjacent channel selectivity : 70 dB typical
- Audio output power : 0.35 W typical at 10% distortion with an 8 Ω load

All stated specifications are subject to change without notice or obligation.

◇ BATTERY CASE AND PACK

- **BP-224** Ni-Cd BATTERY PACK
7.2 V/750 mAh Ni-Cd battery pack.
- **BP-225** Ni-Cd BATTERY PACK
7.2 V/1100 mAh Ni-Cd battery pack.
- **BP-234** LITHIUM BATTERY PACK
9.0 V 3300 mA Lithium battery pack.

◇ CHARGERS

- **BC-119N** DESKTOP CHARGER + **AD-109** CHARGER ADAPTER
+ **BC-145A** AC ADAPTER
For rapid charging of battery packs. An AC adapter is supplied with the charger depending on versions. Charging time: approx. 1.5 to 2 hours (BP-224).
- **BC-121N** MULTI-CHARGER + **AD-109** CHARGER ADAPTER (6 pcs.)
+ **BC-124** AC ADAPTER
For rapid charging of up to 6 battery packs (six AD-109's are required) simultaneously. An AC adapter should be purchased separately. Charging time: approx. 1.5 to 2 hours (BP-224).
- **BC-158** DESKTOP CHARGER + **BC-147A** AC ADAPTER
Used for regular charging of battery pack. The same as supplied with the transceiver. Charging time: approx. 8 hours (BP-224).

◇ BELT CLIPS

- **MB-103Y** BELT CLIP
The same as supplied with the transceiver.
- **MB-86** SWIVEL BELT CLIP
Belt clip for swivel type.
- **MB-96F/96N** BELT HANGER
 - ➔ MB-96F: Attaches with the supplied belt clip (Not swivel type).
 - ➔ MB-96N: Belt hanger for swivel type.

◇ DC CABLES

- **CP-17L** CIGARETTE LIGHTER CABLE
Charges the battery pack through a 12 V cigarette lighter socket. (For BC-119N)
- **OPC-515L/OPC-656** DC POWER CABLES
Charges the battery pack using 13.8 V power source instead of the AC adapter.
OPC-515L: For BC-119N
OPC-656 : For BC-121N

◇ OTHER OPTIONS

- **HM-125** SPEAKER-MICROPHONE
Full sized waterproof (JIS grade 7; 1m/30 min.) speaker-microphone. Includes an alligator clip to attach the speaker mic to your shirt or collar, etc.
- **HS-94/HS-95/HS-97** HEADSET + **OPC-1392** HEADSET ADAPTER
HS-94: Ear-piece type
HS-95: Neck-arm type
HS-97: Throat microphone

Different versions of this radio use different options. Ask your authorized dealers for details.

Count on us!

A-6383H-1EX
Printed in Japan
© 2004 Icom Inc.

Icom Inc.
1-1-32 Kamiminami, Hirano-ku, Osaka 547-0003, Japan