



INSTRUCTION MANUAL

VHF TRANSCEIVER IC-V82

This device complies with Part 15 of the FCC rules. Operation is subject to the following two conditions: (1) This device may not cause harmful interference, and (2) this device must accept any interference received, including interference that may cause undesired operation.

Icom Inc.



FOREWORD

Thank you for purchasing this Icom product. The IC-V82 VHF TRANSCEIVER is designed and built with Icom's superior technology and craftsmanship. With proper care, this product should provide you with years of trouble-free operation.

We want to take a couple of moments of your time to thank you for making your IC-V82 your radio of choice, and hope you agree with Icom's philosophy of "technology first." Many hours of research and development went into the design of your IC-V82.

◇ **FEATURES**

- *7 W of high transmit output power*
- *CTCSS and DTCS encoder/decoder standard*
- *Optional Digital modulator/demodulator*
- *Optional DTMF decoder*

IMPORTANT

READ ALL INSTRUCTIONS carefully and completely before using the transceiver.

SAVE THIS INSTRUCTION MANUAL— This instruction manual contains important operating instructions for the IC-V82.

EXPLICIT DEFINITIONS

WORD	DEFINITION
⚠ WARNING!	Personal injury, fire hazard or electric shock may occur.
CAUTION	Equipment damage may occur.
NOTE	Recommended for optimum use. No risk of personal injury, fire or electric shock.

Icom, Icom Inc. and the ICOM logo are registered trademarks of Icom Incorporated (Japan) in the United States, the United Kingdom, Germany, France, Spain, Russia and/or other countries.

PRECAUTION

⚠ WARNING! NEVER hold the transceiver so that the antenna is very close to, or touching exposed parts of the body, especially the face or eyes, while transmitting. The transceiver will perform best if the microphone is 5 to 10 cm (2 to 4 inches) away from the lips and the transceiver is vertical.

⚠ WARNING! NEVER operate the transceiver with a headset or other audio accessories at high volume levels. Hearing experts advise against continuous high volume operation. If you experience a ringing in your ears, reduce the volume or discontinue use.

NEVER connect the transceiver to a power source that is DC fused at more than 5 A. Accidental reverse connection will be protected by this fuse, but higher fuse values will not give any protection against such accidents and the transceiver will be ruined.

NEVER attempt to charge alkaline or dry cell batteries. Be aware that external DC power connections will charge batteries inside the battery case. This will damage not only the battery case but also the transceiver.

DO NOT push the PTT when not actually desiring to transmit.

Place the unit in a secure place to avoid inadvertent use by children.

DO NOT operate the transceiver near unshielded electrical blasting caps or in an explosive atmosphere.

AVOID using or placing the transceiver in direct sunlight or in areas with temperatures below -10°C ($+14^{\circ}\text{F}$) or above $+60^{\circ}\text{C}$ ($+140^{\circ}\text{F}$).

The use of non-Icom battery packs/chargers may impair transceiver performance and invalidate the warranty.

Even when the transceiver power is OFF, a slight current still flows in the circuits. Remove the battery pack or case from the transceiver when not using it for a long time. Otherwise, the battery pack or installed Ni-Cd batteries will become exhausted.

For USA only:

Caution: Changes or modifications to this transceiver, not expressly approved by Icom Inc., could void your authority to operate this transceiver under FCC regulations.

SUPPLIED ACCESSORIES

■ Supplied Accessories

- ① Antenna* 1
- ② Belt clip (with screws) 1
- ③ AC Adapter 1
- ④ Battery pack*/Battery case* 1
- ⑤ Battery charger* 1 set

*Not supplied with some versions.

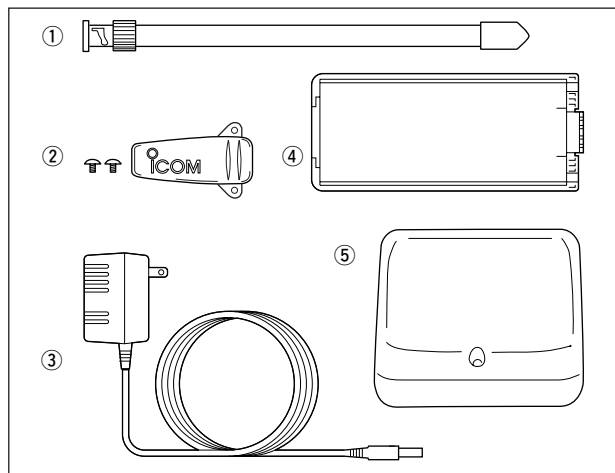

SAFETY TRAINING INFORMATION

CAUTION

To ensure that your exposure to RF electromagnetic energy is within the FCC allowable limits, always adhere to the following guidelines:

- **DO NOT** operate the radio without a proper antenna attached, as this may damage the radio and may also cause you to exceed FCC RF exposure limits. A proper antenna is the antenna supplied with this radio by the manufacturer or an antenna specifically authorized by the manufacturer for use with this radio.
- **DO NOT** transmit for more than 50% of total radio use time (“50% duty cycle”). Transmitting more than 50% of the time can cause FCC RF exposure compliance requirements to be exceeded. The radio is transmitting when the “TX indicator” is lit. You can cause the radio to transmit by pressing the “PTT” switch.
- **ALWAYS** use Icom authorized accessories (antennas, batteries, belt clips, speaker/mics, etc.). Use of unauthorized accessories can cause the FCC RF exposure compliance requirements to be exceeded.

- **ALWAYS** keep the antenna at least 2.5 cm (1 inch) away from the body when transmitting, and only use the Icom belt-clips which are listed in this manual when attaching the radio to your belt, etc. To provide the recipients of your transmission the best sound quality, hold the antenna at least 5 cm (2 inches) from your mouth, and slightly off to one side.

The information listed above provides the user with the information needed to make him or her aware of RF exposure, and what to do to assure that this radio operates within the FCC RF exposure limits of this radio. **Electromagnetic Interference/Compatibility.** During transmissions, your Icom radio generates RF energy that can possibly cause interference with other devices or systems. To avoid such interference, turn off the radio in areas where signs are posted to do so. **DO NOT** operate the transmitter in areas that are sensitive to electromagnetic radiation such as hospitals, aircraft, and blasting sites.

TABLE OF CONTENTS

FOREWORD	i
IMPORTANT	i
EXPLICIT DEFINITIONS	i
PRECAUTION	ii
SUPPLIED ACCESSORIES	iii
SAFETY TRAINING INFORMATION	iv
TABLE OF CONTENTS	v–vi

QUICK REFERENCE..... I–V

■ Preparation	I
■ Your first contact	III
■ Repeater operation	IV
■ Programming memory channels	V

1 ACCESSORIES..... 1–2

■ Accessory attachment	1
------------------------------	---

2 PANEL DESCRIPTION 3–7

■ Switches, controls, keys and connectors	3
■ Function display	6

3 BATTERY PACKS 8–12

■ Battery pack replacement	8
■ Battery caution	9
■ Charging NOTE	9
■ Battery charging	10
■ Battery case (optional for some versions)	12

4 BASIC OPERATION..... 13–16

■ Power ON	13
------------------	----

■ VFO mode selection	13
■ Setting a frequency	13
■ Setting audio/squelch level	15
■ Receive and transmit	15
■ Display type	16
■ Key lock function	16

5 REPEATER OPERATION 17–19

■ General	17
■ Offset frequency	17
■ Subaudible tones	18
■ Auto repeater function (USA versions only)	19
■ Repeater lockout	19

6 MEMORY/CALL OPERATION 20–25

■ General description	20
■ Selecting a memory channel	20
■ Selecting the call channel	20
■ Programming the memory/call channels	21
■ Channel name programming	22
■ Memory transferring	22
■ Memory bank selection	24
■ Memory bank setting	24
■ Transferring bank contents	25

7 DTMF MEMORY 26–27

■ Programming a DTMF code	26
■ Transmitting a DTMF code	27
■ DTMF transmission speed	27

8 SCAN OPERATION.....	28–31
■ Scan types	28
■ Programmed scan	28
■ Memory scan.....	29
■ Skip channels.....	30
■ Priority watch.....	30
■ Scan resume condition.....	31
9 SUBAUDIBLE TONES	32–35
■ Tone squelch	32
■ Pocket beep operation	34
■ Tone scan.....	35
10 PAGER/CODE SQUELCH (Required Optional UT-108)..	36–39
■ Pager function	36
■ Code programming	36
■ Pager operation.....	38
■ Code squelch	39
11 DIGITAL MODE OPERATION	
(Required Optional UT-118).....	40–56
■ Digital mode operation	40
■ Call sign programming	40
■ Digital voice mode operation	43
■ When receiving a Digital call	44
■ Break-in communication	45
■ EMR communication	46
■ Pocket beep operation	46
■ Digital squelch functions	47

■ Digital monitor	47
■ Low-speed data communication	48
■ About D-STAR system	49
■ Repeater call sign programming	50
■ Other setting items	51
■ GPS operation	55
12 OTHER FUNCTIONS	57–67
■ SET MODE.....	57
■ INITIAL SET MODE	61
■ Weather channel operation (USA versions only).....	66
■ CPU reset.....	67
■ Partial reset	67
13 CLONING	68
14 OPTIONAL UNIT	69–70
■ Optional UT-108/118 installation	69
■ Optional MB-86 installation	69
15 SPECIFICATIONS	71
16 OPTIONS.....	72
17 CE.....	74

QUICK REFERENCE GUIDE

■ Preparation

◇ Battery pack replacement

Before replacing the battery pack, push [PWR] for 1 sec. to turn the power OFF.

- Slide the battery release forward, then pull the battery pack upward with the transceiver facing away from you.

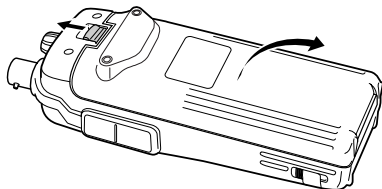

◇ Battery case— optional for some versions

When using a BP-208N BATTERY CASE attached to the transceiver, install 6 AA (LR6) size alkaline batteries as illustrated below.

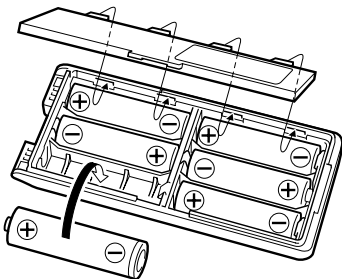

◇ Charging with the BC-144N/146

The optional BC-144N provides rapid charging, and the BC-146 provides regular charging of an optional battery pack with/without transceiver. The following is additionally required:

- An optional AC adapter. (An AD-99N is supplied with BC-144N or BC-146.)

Turn power OFF.

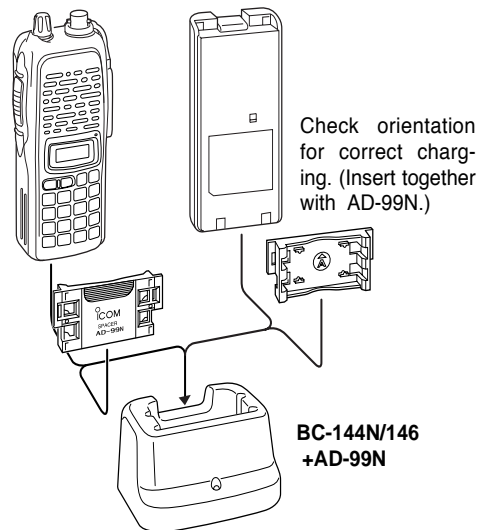

◇ **About AD-99N**

Attach the spacer (Spacer B/C) to the adapter (Spacer A) with orientation as illustrated in the diagram below.

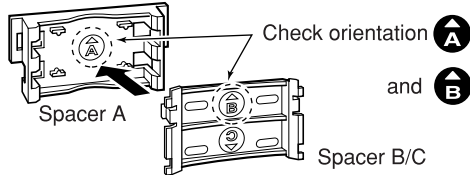

- Attach the spacer (Spacer B/C) to the adapter with the orientation of the stamp “**B**” pointing up.

When removing the spacer (Spacer B/C), push the notch carefully with your finger to remove the spacer (Spacer B/C) from the adapter (Spacer A).

Remove the spacer (Spacer B/C) from the adapter.

Push the notch carefully.

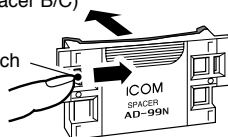

⚠ **CAUTION!**

DO NOT push or force the notch with a screw driver, etc., to remove it.

DO NOT bend the notch when the adapter and spacer are not joined together. This will cause weakening of the notch plastic.

Both cases may break the notch and it may not be able to be reattached.

◇ **Antenna**

Attach the antenna to the transceiver as illustrated at right.

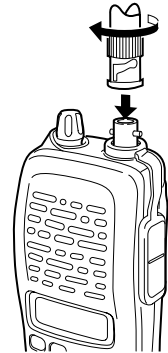

◇ **Belt clip**

Attach the belt clip to the transceiver as illustrated below.

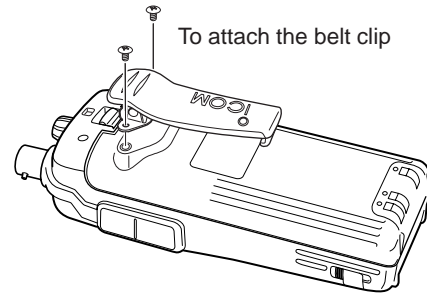

QUICK REFERENCE GUIDE

■ Your first contact

Now that you have your IC-V82 ready, you are excited to get on the air. We would like to walk you through a few basic operational steps to make your first “On The Air” use an enjoyable experience.

◇ About default setting

The [VOL] control function can be traded with [▲]/[▼] keys function in INITIAL SET MODE. However, in this QUICK REFERENCE, the factory default setting ([VOL] controls audio output level) is used for simple instructions.

◇ Basic operation

1. Turning ON the transceiver

Although you have purchased a brand new transceiver, some settings may be changed from the factory defaults because of the QC process. Resetting the CPU is necessary to start from factory default.

- While pushing [MONI] and [D•CLR], push [PWR] for 1 sec. to reset the CPU and turn power ON.

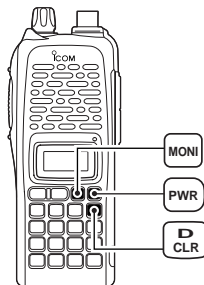

2. Adjusting audio output level

- Rotate [VOL] to set the desired audio level.

3. Adjusting the squelch level

- While pushing and holding [MONI], push [▲] or [▼] to set the squelch level.

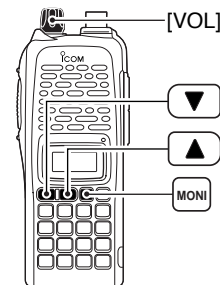

4. Tune the desired frequency

The up/down keys, [▲]/[▼], will allow you to tune the frequency that you want to operate on. Page 14 will instruct you on how to adjust the tuning step.

- Push [▲] or [▼] to adjust the frequency.

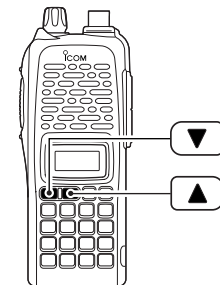

Direct frequency input from the keypad is also available.

- ➔ To enter the desired frequency, enter 6-digits starting from the 100 MHz digit.
 - Enter three* to five digits then pushing [***ENT**] is also set the frequency. (*Some versions are available from two digits.)
 - When a digit is mistakenly input, push [**D.CLR**] to abort to input.

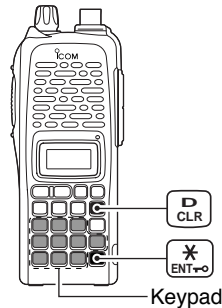

• Example 1— when entering 145.525 MHz

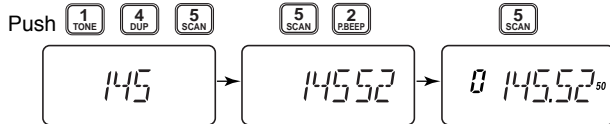

• Example 2— when entering 144.800 MHz



5. Transmit and receive

- ➔ Push and hold [**PTT**] to transmit, then speak into the microphone; release to receive.

■ Repeater operation

1. Setting duplex

- ➔ Push [**A•FUNC**], then [**4•DUP**] several times to select minus duplex or plus duplex.
 - The USA version has an auto repeater function, therefore, setting duplex is not required.

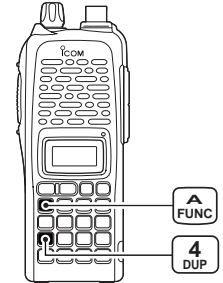
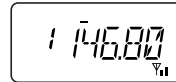

2. Repeater tone

- ➔ Push [**A•FUNC**], then [**1•TONE**] several times until “**T**” appears, if required.

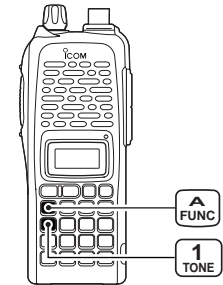
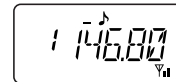

■ Programming memory channels

The IC-V82 has a total of 207 memory channels (including 6 scan edges and 1 call channel) for storing often used operating frequency, repeater settings, etc.

1. Setting frequency

In VFO mode, set the desired operating frequency with other desired settings, such as repeater and subaudible tone.

2. Selecting a memory channel

➤ Push [A•FUNC], [C•MR] then push [▲] or [▼] several times to select the desired memory channel.

- “MR” indicator and memory channel number blink.

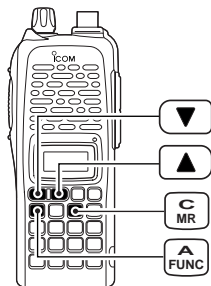
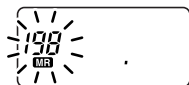

3. Writing a memory channel

➤ Push [A•FUNC], then push [C•MR] for 1 sec. to program.

- 3 beeps sound

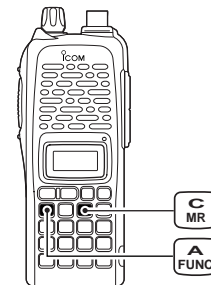
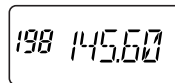

- Continue to hold [C•MR] down for 1 sec. after 3 beeps are emitted, to increment the displayed memory channel number.

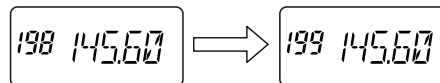

■ Accessory attachment

◇ Antenna

Attach the antenna to the transceiver as illustrated below.

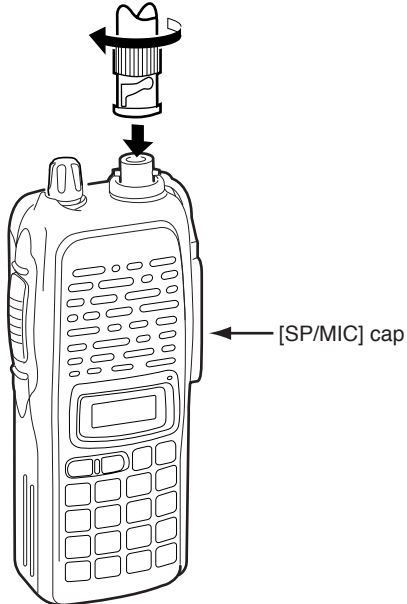

Keep the [SP/MIC] cap (SP/MIC jack cover) attached when jacks are not in use to avoid bad contacts.

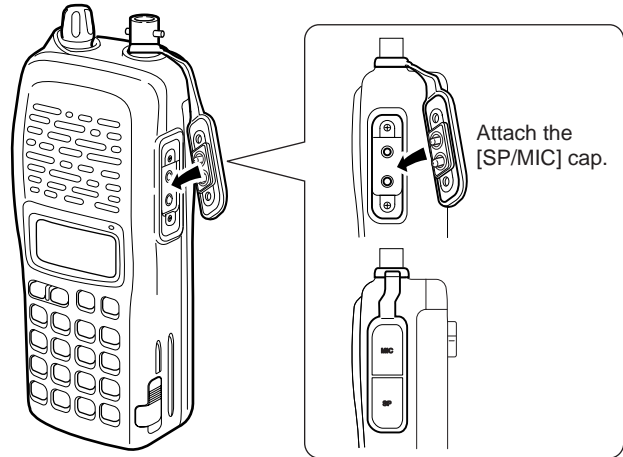

1 ACCESSORIES

◇ Belt clip

Attach the belt clip to the transceiver as illustrated below.

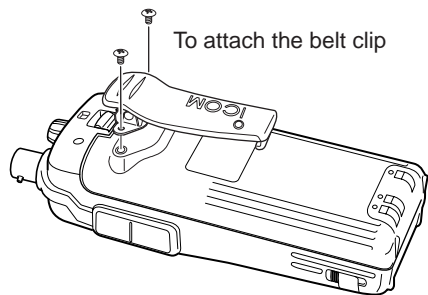

◇ Handstrap (Not supplied)

Slide the hand strap through the loop on the top of the rear panel as illustrated below. Facilitates carrying.

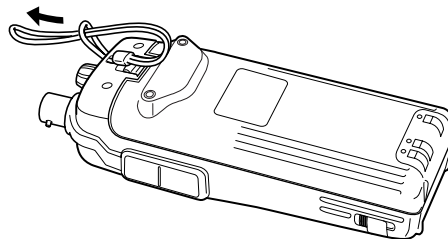

■ Switches, controls, keys and connectors

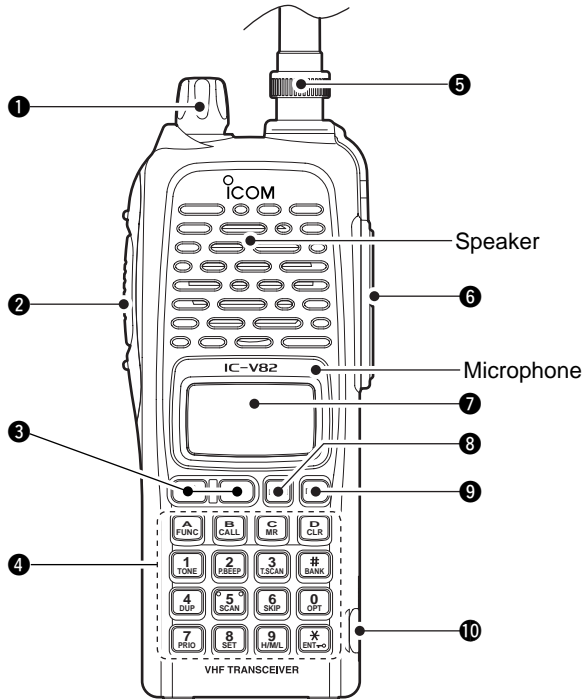

1 CONTROL DIAL [VOL]

*Rotate to adjust the volume level.

2 PTT SWITCH [PTT]

Push and hold to transmit; release to receive.

3 UP/DOWN KEYS [▲]/[▼]

*Selects the operating frequency.

4 KEY PAD (pgs. 4, 5)

Used to enter operating frequency, the DTMF codes, etc.

5 ANTENNA CONNECTOR

Connects the supplied antenna.

6 [SP]/[MIC] JACK

Connect an optional speaker-microphone or headset, if desired. The internal microphone and speaker will not function when either is connected.

7 FUNCTION DISPLAY (pgs 6, 7)

8 SQUELCH/MONITOR SWITCH [MONI]

Push and hold to force the squelch open and set the transceiver to the squelch level adjustable condition.

9 POWER SWITCH [PWR]

Push for 1 sec. to turn the power ON and OFF.

*The assigned function for [VOL] and [▲]/[▼] can be traded in INITIAL SET MODE (pgs. 14, 63).

2 PANEL DESCRIPTION

⑩ [DATA] JACK

Connect to a PC or GPS receiver via the RS232C cable (D-sub 9 pin) for data communication in the RS-232C format.

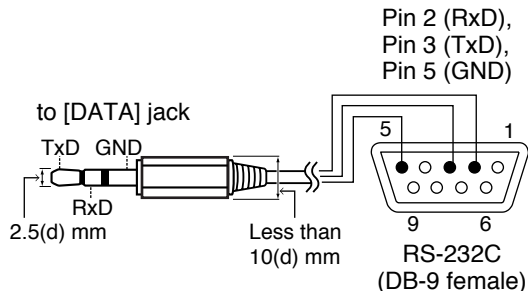

Make sure the connection between transceiver and PC, otherwise misreading may occur for data communication.

◇ Key pad



[A•FUNC]

Access to secondary function.



[B•CALL]

Select the call channel. (p. 20)



[C•MR]

- ➔ Selects a memory mode. (p. 20)
- ➔ After pushing **[A•FUNC]**, entering into memory programming/editing mode. (pgs. 21–23)
- ➔ After pushing **[A•FUNC]**, programs/transfers VFO/memory or call channel contents into memory channel/VFO when pushed for 1 sec. (pgs. 21–23)



[D•CLR]

Selects VFO mode, aborts direct frequency input, or cancels scanning, etc. (pgs. 13, 28)



[1•TONE]

- ➔ Input digit “1” during frequency input, memory channel selection, etc. (pgs. 13, 20)
- ➔ After pushing **[A•FUNC]**, selects the subaudible tone function. (pgs. 17, 32)



[2•P.BEEP]

- ➔ Input digit “2” during frequency input, memory channel selection, etc. (pgs. 13, 20)
- ➔ After pushing **[A•FUNC]**, turn the pocket beep function ON and OFF. (p. 34)



[3•T.SCAN]

- Input digit “3” during frequency input, memory channel selection, etc. (pgs. 13, 20)
- After pushing **[A•FUNC]**, starts the tone scanning. (pgs. 18, 35)



[4•DUP]

- Input digit “4” during frequency input, memory channel selection, etc. (pgs. 13, 20)
- After pushing **[A•FUNC]**, selects a duplex function (–duplex, +duplex, simplex). (p. 17)



[5•SCAN]

- Input digit “5” during frequency input, memory channel selection, etc. (pgs. 13, 20)
- After pushing **[A•FUNC]**, starts scanning. (p. 28)



[6•SKIP]

- Input digit “6” during frequency input, memory channel selection, etc. (pgs. 13, 20)
- After pushing **[A•FUNC]**, sets and cancels skip setting for memory skip scan during memory mode. (p. 30)



[7•PRIO]

- Input digit “7” during frequency input, memory channel selection, etc. (pgs. 13, 20)
- After pushing **[A•FUNC]**, starts the priority watch. (p. 30)



[8•SET]

- Input digit “8” during frequency input, memory channel selection, etc. (pgs. 13, 20)
- After pushing **[A•FUNC]**, enters into SET MODE. (p. 57)



[9•H/M/L]

- Input digit “9” during frequency input, memory channel selection, etc. (pgs. 13, 20)
- After pushing **[A•FUNC]**, switches transmit power from high, middle and low output power. (p. 15)



[0•OPT]

- Input digit “0” during frequency input, memory channel selection, etc. (pgs. 13, 20)
- After pushing **[A•FUNC]**, selects an optional function mode, such as pager, code squelch or digital operation. (pgs. 38, 40)



[#•BANK]

- After pushing **[A•FUNC]**, enters a memory bank condition. (p. 24)



[*•ENT →]

- Sets the frequency even if the full 6-digits of frequency have not been entered. (p. 13)
- After pushing **[A•FUNC]**, switches key lock function ON and OFF when pushed for 1 sec. Lock all keys, except **[PWR]**, **[PTT]**, **[MONI]** and audio level adjustment. (p. 16)

■ Function display

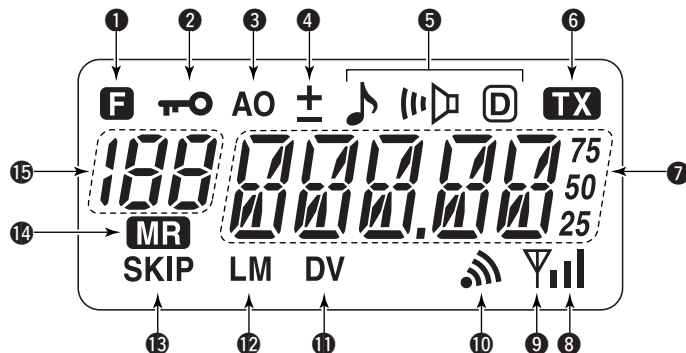

① FUNCTION INDICATOR

Appears while a secondary function is being accessed.

② KEY LOCK INDICATOR (p. 16)

Appears when the key lock function is ON.

③ AUTO POWER OFF INDICATOR (p. 62)

Appears while the auto power OFF function is activated.

④ DUPLEX INDICATOR (p. 17)

Either “-” or “+” appears during repeater operation.

⑤ TONE INDICATOR

○ While in the analog (FM) mode operation

- “♪” appears while the subaudible tone encoder is in use. (p. 17)
- “▷” appears while the tone (CTCSS) squelch function is in use. (p. 32)
- “@” appears while the tone (DTCS) squelch function is in use. (p. 32)
- “|” appears with the “▷” or “@” indicator while the pocket beep function (CTCSS or DTCS) is in use. (p. 34)

- While in the digital (DV) mode operation with the installing an optional Digital unit UT-118.
 - ↳ “**▷**” appears while the digital code (CSQL) squelch function is in use. (p. 47)
 - ↳ “**Ⓞ**” appears while the call sign (DSQL) squelch function is in use. (p. 47)
 - ↳ “**Ⓜ**” appears with the “**▷**” or “**Ⓞ**” indicator while the pocket beep function (CSQL or DSQL) is in use. (p. 46)

6 TRANSMIT INDICATOR (p. 15)
Appears during transmit.

7 FREQUENCY READOUT
Shows operating frequency, channel number or channel names, depending on display type (p. 16).

8 SIGNAL INDICATOR
↳ Shows receiving signal strength as below.



Weak ← RX Signal level ⇒ Strong

↳ Shows the output power level while transmitting.



9 BUSY INDICATOR

- ↳ Appears when a signal is being received or the squelch is open.
- ↳ Blinks while the monitor function is activated. (pgs.15, 47)

10 PAGER CALL INDICATOR (p. 39)
Blinks when a pager call is received. (This indicator appears only when UT-108 is installed.)

11 DIGITAL MODE INDICATOR (p. 43)
Appears when digital mode is selected. (This indicator appears only when UT-118 is installed.)

12 LOW/MIDDLE POWER INDICATOR (p. 15)
↳ “**L**” or “**M**” appears when the low or middle output power is selected, respectively.
↳ No indicator appears when high output power is selected.

13 SKIP CHANNEL INDICATOR (p. 30)
Appears when the selected memory channel is specified as a skip channel.

14 MEMORY MODE INDICATOR (p. 20)
Appears while in memory mode or channel number indication mode.

15 MEMORY CHANNEL INDICATOR (p. 20)
↳ Shows the selected memory channel number.
↳ “**C**” appears when the call channel is selected.

3

BATTERY PACKS

■ Battery pack replacement

- Before replacing the battery pack, push [PWR] for 1 sec. to turn the power OFF.

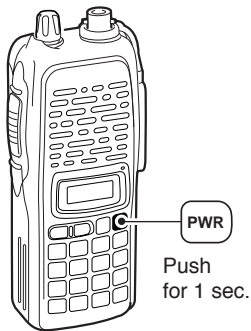

- Slide the battery release forward, then pull the battery pack upward with the transceiver facing away from you.

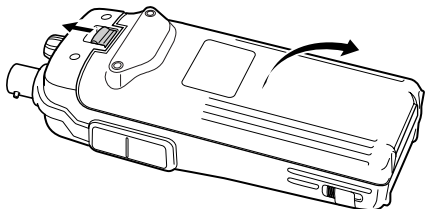

◇ BATTERY PACKS

Battery pack	Voltage	Capacity	Battery life*1
BP-208N	Battery case for AA (LR6)×6 alkaline		—*2
BP-209N	7.2 V	1100 mAh	3 hrs. 20 min.
BP-210N	7.2 V	1650 mAh	6 hrs.
BP-211N	7.4 V	1800 mAh	6 hrs. 10 min.
BP-222N	7.2 V	600 mAh	2 hrs. 15 min.

*1 Operating periods are calculated under the following conditions;
Tx : Rx : standby = 1 : 1 : 8, power save function: auto setting is activated

*2 Operating period depends on the alkaline cells used.

■ Battery caution

⚠ **DANGER! Use/Charge** the specified Icom batteries only.

Only tested and approved for use with genuine Icom batteries. Fire and/or explosion may occur when a third party battery pack or counterfeit product is used/charged.

- **CAUTION! NEVER** short the terminals of the battery pack (or charging terminals of the transceiver). Also, current may flow into nearby metal objects such as a necklace, so be careful when placing battery packs (or the transceiver) in handbags, etc.

Simply carrying with or placing near metal objects such as a necklace, etc. causes shorting. This will damage not only the battery pack, but also the transceiver.

- **NEVER** incinerate used battery packs. Internal battery gas may cause an explosion.
- **NEVER** immerse the battery pack in water. If the battery pack becomes wet, be sure to wipe it dry **BEFORE** attaching it to the transceiver.
- **Clean** the battery terminals to avoid rust or poor contact.
- **Keep** battery contacts clean. It's a good idea to clean battery terminals once a week.

If your battery pack seems to have no capacity even after being charged, completely discharge it by leaving the power ON overnight. Then, fully charge the battery pack again. If the battery pack still does not retain a charge (or only very little charge), a new battery pack must be purchased (p. 70).

■ Charging NOTE

Prior to using the transceiver for the first time, the battery pack must be fully charged for optimum life and operation.

- Recommended temperature range for charging:
+10°C to +40°C (; +50°F to 140°F)
- Use the supplied charger or optional charger (BC-119N/121N/144N for rapid charging, BC-146 for regular charging) only. **NEVER** use other manufacturers' chargers.

The optional BP-222N, BP-209N, BP-210N or BP-211N battery packs include rechargeable batteries (Ni-Cd: BP-222N, BP-209N, Ni-MH: BP-210N, Li-Ion: BP-211N) and can be charged approx. 300 times. Charge the battery pack before first operating the transceiver or when the battery pack becomes exhausted.

If you want to charge the battery pack more than 300 times, the following points should be observed:

- Avoid over charging. The charging period should be less than 24 hours.
- Use the battery until it becomes almost completely exhausted under normal conditions. We recommend battery charging after transmitting becomes impossible.

◇ Battery pack life

When the operating period becomes extremely short even after charging the battery pack fully, a new battery pack is needed.

3 BATTERY PACKS

■ Battery charging

◇ Regular charging with the BC-146

The optional BC-146 provides regular charging of an optional NI-Cd battery pack with/without transceiver. The following is additionally required:

- An optional AC adapter. (An AD-99N is supplied with BC-146.)

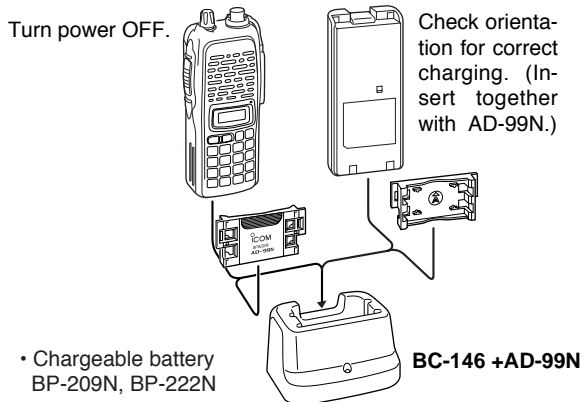

Recommendation:

Charge the BP-211N (Li-Ion) by BC-119N (or BC-121N) for a maximum of 2 hours. Li-Ion batteries are different from Ni-Cd batteries in that it is not necessary to completely charge and discharge them to prolong the battery life. Therefore, charging the battery in intervals, and not for extended periods is recommended.

◇ About AD-99N

Attach the spacer (Spacer B/C) to the adapter (Spacer A) with orientation as illustrated in the diagram below.

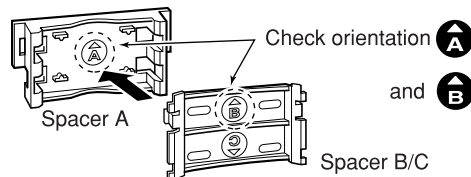

- Attach the spacer (Spacer B/C) to the adapter with the orientation of the stamp “**A**” pointing up.

When removing the spacer (Spacer B/C), push the notch carefully with your finger to remove the spacer (Spacer B/C) from the adapter (Spacer A).

Remove the spacer (Spacer B/C) from the adapter.

Push the notch carefully.

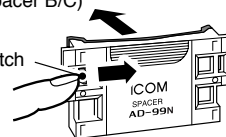

CAUTION!

DO NOT push or force the notch with a screw driver, etc., to remove it.

DO NOT bend the notch when the adapter and spacer are not joined together. This will cause weakening of the notch plastic.

Both cases may break the notch and it may not be able to be reattached.

◇ **Rapid charging with the BC-144N**

The optional BC-144N provides rapid charging of optional battery packs.

The following are additionally required:

- An AC adapter (may be supplied with the BC-144N depending on version).

Turn power OFF.

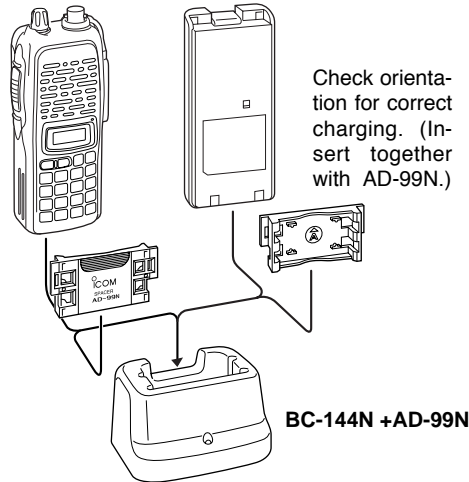

• **Chargeable battery**

- BP-210N (Ni-MH battery)
- BP-209N, BP-222N (Ni-Cd batteries)

◇ **Rapid charging with the BC-119N+AD-101**

The optional BC-119N provides rapid charging of battery packs. The following items are additionally required.

- AD-101.
- An AC adapter (may be supplied with the BC-119N depending on version) or the DC power cable (OPC-515L/CP17L).

Turn power OFF.

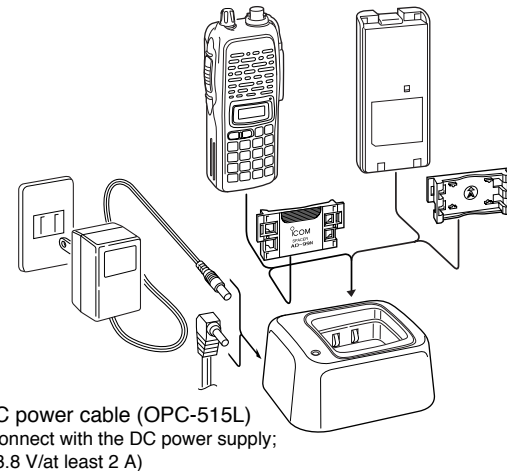

• **Chargeable battery**

- BP-210N (Ni-MH battery)
- BP-209N, BP-222N (Ni-Cd batteries)
- BP-211N (Li-Ion battery)

3 BATTERY PACKS

◇ Rapid charging with the BC-121N+AD-101

The optional BC-121N allows up to 6 battery packs to be charged simultaneously. The following items are additionally required.

- Six AD-101.
- An AC adapter (BC-124; may be supplied with the BC-121N depending on version) or the DC power cable (OPC-656).

Turn power OFF.

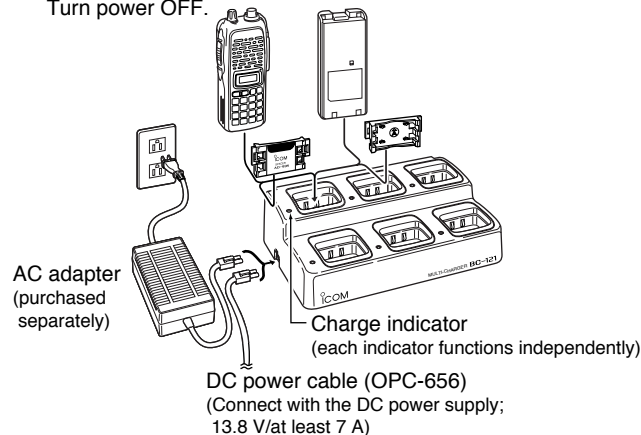

• Chargeable battery

- BP-210N (Ni-MH battery)
- BP-209N, BP-222N (Ni-Cd batteries)
- BP-211N (Li-Ion battery)

■ Battery case (optional for some versions)

When using a BP-208N BATTERY CASE attached to the transceiver, install 6 AA (LR6) size alkaline batteries as illustrated below.

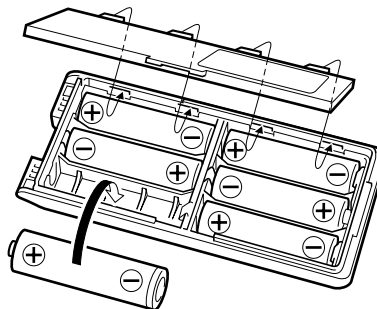

◇ CAUTION

- Use **ALKALINE** batteries only.
- **Make sure** all battery cells are the same brand, type and capacity.
- **Never** mix old and new batteries.
Either of the above may cause a fire hazard or damage the transceiver if ignored.
- **Never** incinerate used battery cells since internal battery gas may cause them to rupture.
- **Never** expose a detached battery case to water.
If the battery case gets wet, be sure to wipe it dry before use.

■ Power ON

- ➔ Push [PWR] for 1 sec. to turn power ON.

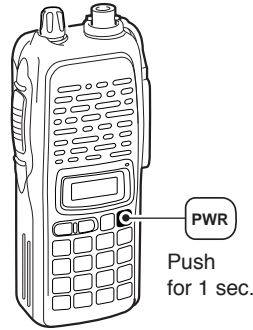

■ VFO mode selection

The transceiver has 2 basic operating modes: VFO mode and memory mode.

- ➔ Push [D•CLR] to select VFO mode.

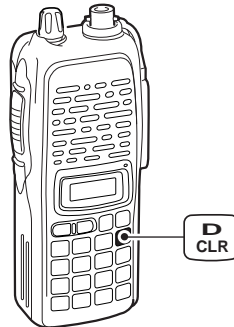

■ Setting a frequency

◇ Via the keypad

- ① Push [D•CLR] to select VFO mode, if necessary.
- ② To enter the desired frequency, enter 6-digits starting from the 100 MHz digit.
 - Enter three* to five digits then pushing [***ENT** ↔] is also set the frequency. (*Some versions are available from two digits.)
 - When a digit is mistakenly input, push [D.CLR] to abort to input.

• Example 1— when entering 145.525 MHz

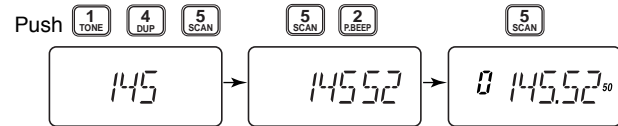

• Example 2— when entering 144.800 MHz

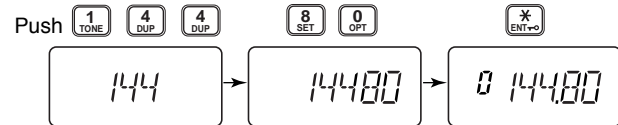

4 BASIC OPERATION

◇ By other methods

Via the [▲]/[▼] keys

- Push [▲] or [▼] several times to set the desired frequency.
 - Each push increases/decreases the frequency by the selected tuning step. See right content for tuning step details.

✓ For your information— [VOL] function assignment

The [VOL] control can be used as a tuning dial for frequency tuning instead of [▲]/[▼] keys. However, while [VOL] functions as tuning dial, [▲]/[▼] keys functions as AF volume control.

- ① While pushing [▲] and [▼], turn power ON to enter INITIAL SET MODE.
- ② Push [▲] or [▼] several times to select the dial assignment item, "tOP."
- ③ Rotate [VOL] to select the condition.

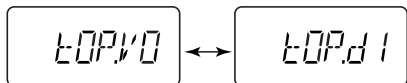

[VOL] is assigned as AF volume control.

[VOL] is assigned as tuning dial.

- ④ To exit SET MODE, push [*•ENT→].

◇ Tuning step selection

The IC-V82 has 8 tuning steps— 5, 10, 12.5, 15, 20, 25, 30 and 50 kHz. The tuning step is selectable in SET MODE.

- ① Push [A•FUNC] then [8•SET] to enter SET MODE.
- ② Push [▲] or [▼] several times to select the tuning step item.

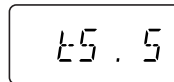

- ③ Rotate [VOL] to select the desired tuning step.
- ④ Push [*•ENT→] to exit SET MODE.

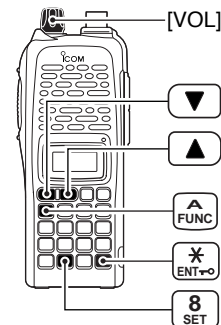

■ Setting audio/squelch level

◇ To set the audio level

Rotate **[VOL]** to set the desired audio level while receiving a signal.

- When no signal is received, push and hold **[MONI]** while setting the audio level.
- When **[VOL]** is assigned as tuning dial, push **[▲]/[▼]** to adjust the audio output level. (pgs. 14, 63)

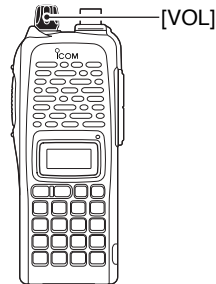

◇ To set the squelch level

While pushing **[MONI]**, push **[▲]/[▼]** to set the squelch level.

- The squelch level "1" is loose squelch, "10" is tight squelch.
- When **[VOL]** is assigned as tuning dial, rotate **[VOL]** while **[MONI]** is pushed. (pgs. 14, 63)

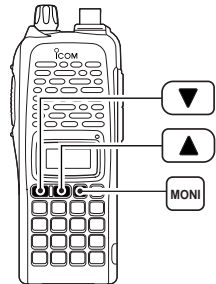

■ Receive and transmit

- ① Push **[PWR]** for 1 sec. to turn the power ON.
- ② Adjust audio volume to the desired level.
- ③ Set a frequency.
 - When a signal is received:
 - Squelch opens and audio is emitted from the speaker.
 - Signal indicator shows the relative signal strength level.
- ④ Push **[A•FUNC]**, then **[9•H/M/L]** to select output power between high, middle and low.
 - "L" appears when low power is selected.
 - "M" appears when middle power is selected.
 - No indication appears when high power is selected.
- ⑤ Push and hold **[PTT]** to transmit, then speak into the microphone.
 - "**TX**" appears.
 - **Do not** hold the microphone too close to your mouth or speak too loudly. This may distort the signal.
- ⑥ Release **[PTT]** to receive.

✓ For your information— Monitor function:

Push and hold **[MONI]** to listen to weak signals that do not open the squelch.

4 BASIC OPERATION

■ Display type

USING INITIAL SET MODE

The transceiver has 3 display types to suit your operating style.

The display type is selected in INITIAL SET MODE (p. 63).

“Frequency Indication” type

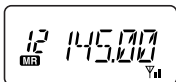

Displays operating frequency.

“Channel Number Indication” type

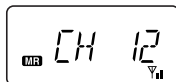

Displays memory channel number. In this type only pre-programmed memory channel numbers are displayed.

VFO mode cannot be selected.

- When the channel indication type is selected, only the following functions can be performed.
 - Scan function (p. 28)
 - Output power setting (p. 15)
 - DTMF memory function (p. 26)
 - Key lock function (see right content)
 - Scan pause timer setting, function key timer setting and LCD backlight setting in SET MODE (p. 59)

“Channel Name Indication” type

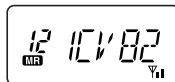

Displays memory channel name you have assigned. In this display pre-programmed memory channel names are displayed.

VFO mode is selectable.

- Programmed frequencies are indicated pre-programmed in the selected memory channel.
- Push and hold [MONI] to display the operating frequency.

■ Key lock function

The key lock function prevents accidental frequency changes and function activation.

Push [A•FUNC] then push [*•ENT•] for 1 sec. to toggle the function ON and OFF.

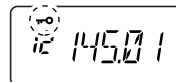

- “**LO**” appears while the lock function is activated.
- [PWR], [PTT], [VOL] and [MONI] can be operated regardless of this setting.

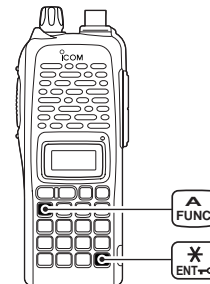

■ General

When using a repeater, the transmit frequency is shifted from the receive frequency by the offset frequency. It is convenient to program repeater information into memory channels.

- ① Set the receive frequency (repeater output frequency).
- ② Push **[A•FUNC]** and **[4•DUP]** several times to select “-” or “+.”
 - “-” indicates the transmit frequency is shifted down; “+” indicates the transmit frequency is shifted up.
 - Blinking “-” or “+” indicates the reversed duplex mode is selected in SET MODE (p. 58).
- ③ Push **[A•FUNC]** and **[1•TONE]** several times to activate the subaudible tone encoder, if required.
 - “J” appears.
 - Select the desired subaudible tone frequency, if necessary. (p. 18)
- ④ Push and hold **[PTT]** to transmit.
 - The displayed frequency automatically changes to the transmit frequency (repeater input frequency).
 - If “OFF” appears, check the offset frequency (see right content for details) and direction.
- ⑤ Release **[PTT]** to receive.
- ⑥ Push and hold **[MONI]** to check whether the other station’s transmit signal can be directly received or not.

/// About reversed duplex mode

When the reversed duplex mode is selected, the receive frequency shifts. (Transmit frequency shifts in normal duplex mode.)

Each receive and transmit frequency is shown in the table below with the following conditions;

Inputed freq. : 145.30 MHz	Reversed	OFF	ON
Direction : - (negative)	Rx freq.	145.30 MHz	144.70 MHz
Offset frequency : 0.6 MHz	Tx freq.	144.70 MHz	145.30 MHz

■ Offset frequency

USING SET MODE

When communicating through a repeater, the transmit frequency is shifted from the receive frequency by an amount determined by the offset frequency.

- ① Push **[A•FUNC]**, then push **[8•SET]** to enter SET MODE.
- ② Push **[▲]** or **[▼]** several times until “±” and offset frequency appear.

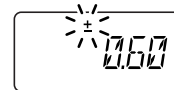

- ③ Rotate **[VOL]** to select the desired offset frequency.
 - Selectable steps are the same as the pre-set tuning steps.
 - The unit of the displayed offset frequency is “MHz.”
- ④ Push **[*•ENT•O]** (or **[D•CLR]**) to fix the offset frequency and exit SET MODE.

5 REPEATER OPERATION

■ Subaudible tones USING SET MODE

Some repeaters require subaudible tones to be accessed. Subaudible tones are superimposed over your normal signal and must be set in advance.

- ① Push [A•FUNC], then push [8•SET] to enter SET MODE.
- ② Push [▲] or [▼] one or more times until “rt” appears.

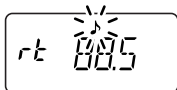

- ③ Rotate [VOL] to select the desired subaudible tone.
- ④ Push [*•ENT↔] (or [D•CLR]) to fix the selected tone and exit SET MODE.

• Available subaudible tone frequencies (unit: Hz)

67.0	85.4	107.2	136.5	165.5	186.2	210.7	254.1
69.3	88.5	110.9	141.3	167.9	189.9	218.1	
71.9	91.5	114.8	146.2	171.3	192.8	225.7	
74.4	94.8	118.8	151.4	173.8	196.6	229.1	
77.0	97.4	123.0	156.7	177.3	199.5	233.6	
79.7	100.0	127.3	159.8	179.9	203.5	241.8	
82.5	103.5	131.8	162.2	183.5	206.5	250.3	

◇ Tone information

Some repeaters require another tone system to be accessed.

DTMF TONES

While pushing [PTT], push the desired DTMF keys (0–9, [A•FUNC], [B•CALL], [C•MR], [D•CLR], [#•BANK] and [*•ENT↔]) to transmit DTMF tones.

- [*•ENT↔] enters as “E”, [#•BANK] enters as “F.”
- The transceiver has 16 DTMF memory channels (p. 26).

1750 Hz TONE

While pushing [PTT], push [▲] or [▼] to transmit a 1750 Hz tone signal.

✓ Convenient

Tone scan function: When you don't know the subaudible tone used for a repeater, the tone scan is convenient for detecting the tone frequency.

Push [A•FUNC], then push [3•T.SCAN] to start the tone scan.

- Push [D•CLR] to cancel the scan.
- When the required tone frequency is detected, the scan pauses.

■ Auto repeater function

(USA version only)

USING INITIAL SET MODE

The USA version automatically activates the repeater settings (duplex, ON/OFF, duplex direction, tone encoder ON/OFF) when the operating frequency falls within or outside of the general repeater output frequency range. The offset and repeater tone frequencies are not changed by the auto repeater function. Reset these frequencies, if necessary.

- ① While pushing [▲] and [▼], turn the power ON to enter INITIAL SET MODE.
- ② Push [▲] or [▼] several times until “RPt” appears.
- ③ Rotate [VOL] to select the desired condition.
 - “OF”— the auto repeater function is turned OFF;
 - “R1”— the auto repeater function activates for duplex only;
 - “R2”— the auto repeater function activates for duplex and tone.

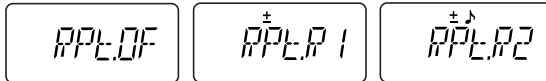

- ④ Push [*•ENT↵] (or [D•CLR]) to exit INITIAL SET MODE.

• Frequency range and offset direction

Frequency range	Duplex direction
145.200–145.495 MHz 146.610–146.995 MHz	“–” appears
147.000–147.395 MHz	“+” appears

■ Repeater lockout

USING INITIAL SET MODE

This function helps prevent interference to other stations by inhibiting your transmission when a signal is received. The transceiver has two inhibiting conditions, repeater and busy.

- ① While pushing [▲] and [▼], turn the power ON to enter INITIAL SET MODE.
- ② Push [▲] or [▼] several times until “RLO” appears.
- ③ Rotate [VOL] to turn the repeater lockout function to “RP,” “bU” or OFF.
 - “RP”: Transmit is inhibited when a signal with un-matched sub-audible tone is received.
 - “bU”: Transmit is inhibited when a signal is received.

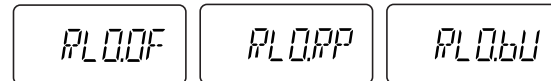

- ④ Push [*•ENT↵] (or [D•CLR]) to exit INITIAL SET MODE.

■ General description

The transceiver has 207 memory channels including 6 scan edge memory channels (3 pairs), and 1 call channel. Each of these channels can be individually programmed with operating frequency (pgs. 13, 14), duplex direction (p. 17) and offset (p. 17), subaudible tone encoder or tone squelch and its tone frequency (pgs. 18, 33) and skip information* (p. 30).

In addition, a total of 10 memory banks, A to J, are available for usage by group, etc.

*except for scan edge memory channels.

■ Selecting a memory channel

① Push [**C•MR**] to select memory mode.

- “MR” appears.

Push 

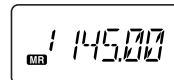

② Enter 2 digits to select the desired memory channel (or push the [**▲**]/[**▼**] keys).

- The memory channels 0–9 are preceded by a “0.”
- When [**VOL**] is assigned as tuning dial, rotate [**VOL**] to select the memory channel. (pgs. 14, 63)

Push  

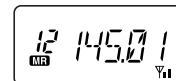

■ Selecting the call channel

➔ Push [**B•CALL**] to select the call channel.

- “C” is displayed instead of the memory channel number.
- Push [**D•CLR**] or [**C•MR**] to select VFO or memory mode, respectively.

Push 

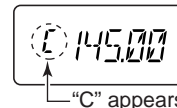

—“C” appears

■ Programming the memory/call channels

- ① Push **[D•CLR]** to select VFO mode, if necessary.
- ② Set the desired frequency.
- ③ Set other information, such as tone, duplex, as desired.
- ④ Push **[A•FUNC]**, then **[C•MR]** momentarily.
 - “MR” and memory channel number blink.

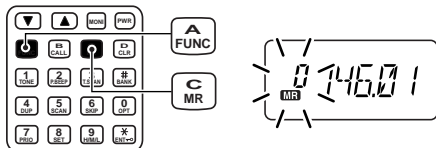

- ⑤ Push **[▲]** or **[▼]** to select the desired memory channel.
 - When programming the call channel, select “C.”
 - When **[VOL]** is assigned as tuning dial, rotate **[VOL]** to select the memory channel. (pgs. 14, 63)

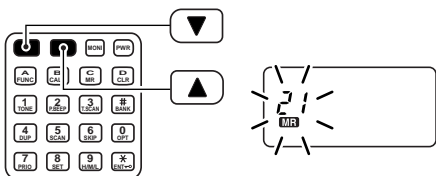

- ⑥ Push **[A•FUNC]**, then push **[C•MR]** for 1 sec. (until 3 beeps are emitted) to program the information into the selected memory channel and return to VFO.

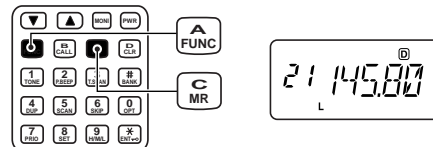

- Continue to hold **[C•MR]** down for 1 sec. after 3 beeps are emitted, to increment the displayed memory channel number.

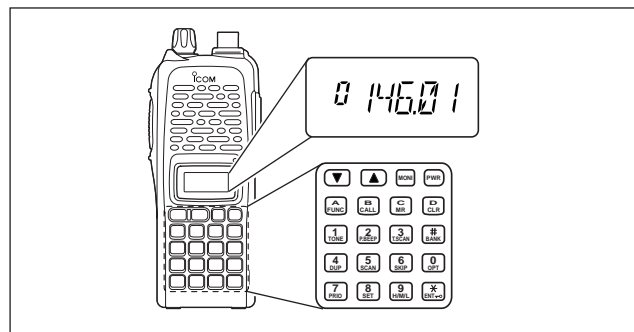
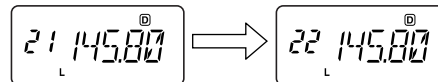

6 MEMORY/CALL OPERATION

■ Channel name programming

- ① Select a “Channel Name Indication” type in INITIAL SET MODE (p. 63).
- ② Push [**C•MR**] to select memory mode, if necessary.
- ③ Push [**A•FUNC**], then push [**8•SET**] to enter into the channel name programming mode.
 - The character to be edited blinks.
- ④ Rotate [**VOL**] to select a character.

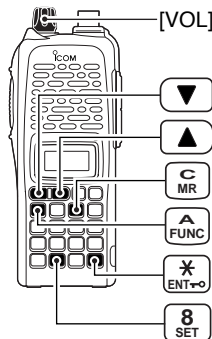

- ⑤ Push [**▲**] to move to the right, [**▼**] to move to the left.
 - Up to 5 characters can be used for channel name.
 - Usable characters are A–Z, 0–9, “space,” +, –, =, *, /, [,] and .:
- ⑥ Push [***•ENT-TO**] (or [**D•CLR**]) to fix and exit the channel name programming mode.

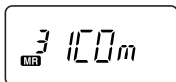

■ Memory transferring

This function transfers a memory channel’s contents to VFO (or another memory/call channel). This is useful when searching for signals around a memory channel frequency and for recalling the offset frequency, subaudible tone frequency etc.

◇ Memory/call ⇒ VFO

- ① Select the memory (call) channel to be transferred:
 - ➔ Push [**C•MR**] or [**B•CALL**] to select memory (call) mode.
 - ➔ Push [**▲**] or [**▼**] to select the memory channel.
 - When [**VOL**] is assigned as tuning dial, rotate [**VOL**] to select the memory channel. (pgs. 14, 63)
- ② Push [**A•FUNC**], then push [**C•MR**] for 1 sec. to transfer the selected memory contents to the VFO.
 - VFO mode is selected automatically.

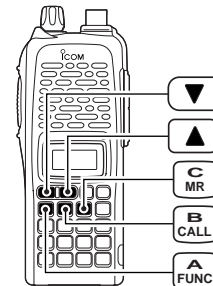

◇ Memory/call ⇒ call/memory

- ① Select the memory (call) channel to be transferred:
 - ➔ Push [**C•MR**] or [**B•CALL**] to select the memory (call) mode.
 - ➔ Push [**▲**] or [**▼**] to select the memory channel.
 - When [**VOL**] is assigned as tuning dial, rotate [**VOL**] to select the memory channel. (pgs. 14, 63)
- ② Push [**A•FUNC**], then push [**C•MR**] momentarily.
 - “--” and “**MR**” blink.
- ③ Push [**▲**] or [**▼**] to select the target memory.
 - When [**VOL**] is assigned as tuning dial, rotate [**VOL**] to select the target channel. (pgs. 14, 63)
- ④ Push [**A•FUNC**], then push [**C•MR**] for 1 sec.
 - Memory mode is selected and the contents are transferred to the target memory.

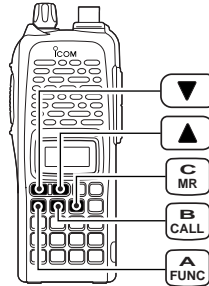

◇ Clearing a memory

- ① Push [**A•FUNC**], then push [**C•MR**] to enter the memory transfer mode.
 - “**MR**” and a memory channel number blink.
- ② Push [**▲**] or [**▼**] to select the memory channel to be cleared.
 - When [**VOL**] is assigned as tuning dial, rotate [**VOL**] to select the memory channel. (pgs. 14, 63)
 - The call channel cannot be cleared.
- ③ Perform the following operation within 1.5 sec, otherwise the memory clearing is cancelled and the transceiver returns to the memory mode.
 - Push [**A•FUNC**], then push [**C•MR**] momentarily.
 - Push [**A•FUNC**], then push [**C•MR**] for 1 sec.
 - The contents of the selected memory are cleared.
- ④ Push [**D•CLR**] to return to regular operation.

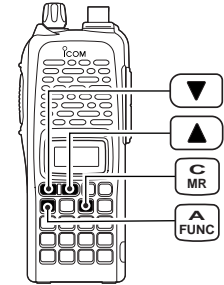

■ Memory bank selection

The IC-V82 has a total of 10 banks (A to J). Regular memory channels, 0 to 199, are assigned into the desired bank for easy memory management.

- ① Push [**C•MR**] to select memory mode.
- ② Push [**A•FUNC**] and [**#•BANK**] to select memory bank condition.
 - Bank initial blinks.

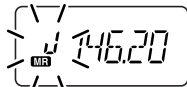

- ③ Rotate [**VOL**] to select the desired bank, A to J.
 - Banks that have no programmed contents are skipped.
- ④ Push [***•ENT↔O**] (or [**D•CLR**]) to set the bank.
 - Initial stops blinking.
- ⑤ Push [**▲**] or [**▼**] to select the contents in the bank.
 - No channel numbers are displayed for memory bank operation.
- ⑥ To return to regular memory condition, push [**A•FUNC**] and [**#•BANK**] to enter memory bank condition, then push [***•ENT↔O**] (or [**D•CLR**]).

■ Memory bank setting

- ① Push [**C•MR**] to select memory mode, then select the desired memory channel via [**▲**] or [**▼**].
- ② Push [**A•FUNC**] and [**8•SET**] to enter SET MODE.
- ③ Push [**▲**] or [**▼**] several times until “bAk” appears.
 - “—” indication blinks as follows.

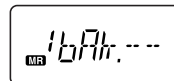

- ④ Rotate [**VOL**] to select the desired bank to be set.

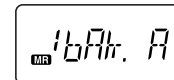

- ⑤ Push [***•ENT↔O**] (or [**D•CLR**]) to set the channel into the bank and return to regular memory condition.
- ⑥ Repeat steps ① to ⑤ to set another memory channel into the same or another bank.

■ Transferring bank contents

Contents of programmed memory banks can be cleared or transferred to another bank.

/// INFORMATION: Even if the memory bank contents are cleared, the memory channel contents still remain programmed.

- ① Select the desired bank contents to be transferred or erased.
 - ➔ Push [**C•MR**] to select memory mode.
 - ➔ Push [**A•FUNC**] and [**#•BANK**], then rotate [**VOL**] to select the desired memory bank.
 - Bank initial blinks.
 - ➔ Push [***•ENT↔**] (or [**D•CLR**]) to select the bank then push [**▲**] and [**▼**] to select the desired contents.
 - Bank initial stops blinking.
- ② Push [**A•FUNC**] and [**8•SET**] to enter SET MODE.
- ③ Push [**▲**] or [**▼**] several times until “bAk” appears.
 - Bank initial appears.

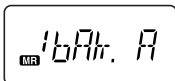

- ④ Rotate [**VOL**] to select the desired bank initial to transfer or erase.
 - Select “- -” indication when erasing the contents from the bank.

- ⑤ Push [***•ENT↔**] (or [**D•CLR**]) to transfer or erase, and return to regular memory condition.
- ⑥ Repeat steps ① to ⑤ for transferring or erasing another bank's contents.

■ Programming a DTMF code

The transceiver has 16 DTMF memory channels (d0 to dF) for storage of often-used DTMF codes of up to 24 digits.

- ① Push **[A•FUNC]**, then push **[0•OPT]** to enter OPTION SET MODE.
- Rotate **[VOL]** to select “dtm.OF,” if necessary.



- ② Push **[0•OPT]** for 1 sec. to enter the DTMF memory.
- One of “d0” to “dF” appears.

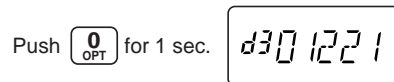

- ③ Rotate **[VOL]** to select the desired channel.
- ④ Push **[0•OPT]** for 1 sec. to enter the DTMF programming mode.
- “_____” appears.
 - Programmed memories can be cleared in this way.

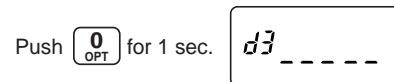

- ⑤ Push the digit keys, **[A•FUNC]**, **[B•CALL]**, **[C•MR]**, **[D•CLR]**, **[#•BANK]** and **[*•ENT→O]** to enter the desired DTMF code.
- A maximum of 24 digits can be input.
 - **[*•ENT→O]** enters as “E”, **[#•BANK]** enters as “F.”
 - If a digit is mistakenly input, push **[MONI]** or **[PTT]** momentarily then repeat from step ①.



- ⑥ Push **[MONI]** or **[PTT]** to fix the digits and exit the DTMF programming mode.
- Programmed DTMF codes sound when **[MONI]** is pushed.

The DTMF memory consists of 5 pages that are 1st to 5th, 6 to 10th, 11 to 15th, 16 to 20th and 21st to 24th digits.

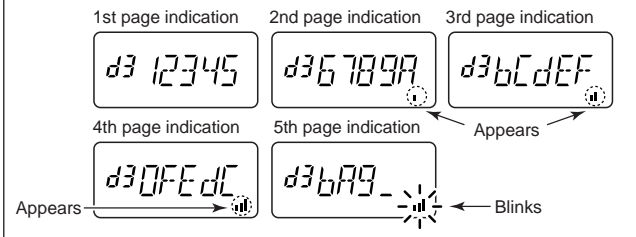

■ Transmitting a DTMF code

◇ Using a DTMF memory channel

- ① Push **[A•FUNC]**, then push **[0•OPT]** to enter **OPTION SET MODE**.
 - Rotate **[VOL]** to select “dtm.OF,” if necessary.
- ② Push **[0•OPT]** for 1 sec. to enter the DTMF memory.
- ③ Rotate **[VOL]** to select the desired channel.
- ④ Push **[MONI]** or **[PTT]** to exit the DTMF memory mode.
- ⑤ While pushing **[PTT]**, push **[MONI]** to transmit the selected DTMF memory.
 - After the DTMF code is transmitted, the transceiver returns to receive automatically.

◇ Manual DTMF code transmission

While pushing **[PTT]**, push digit keys, **[A•FUNC]**, **[B•CALL]**, **[C•MR]**, **[D•CLR]**, **[#•BANK]** and **[*•ENT↔O]** to transmit a DTMF code manually.

- **[*•ENT↔O]** enters as “E”, **[#•BANK]** enters as “F.”

■ DTMF transmission speed

USING INITIAL SET MODE

When slow DTMF transmission speeds are required with DTMF memory transmission (as for some repeaters), the transceiver’s rate of DTMF transmission can be adjusted.

- ① While pushing **[▲]** and **[▼]**, turn the power on to enter **INITIAL SET MODE**.
- ② Push **[▲]** or **[▼]** several times until “dtd” appears.
- ③ Rotate **[VOL]** to select the desired DTMF transmission speed.
 - Four speeds are available: “1” (100 msec. intervals) is the fastest; “5” (500 msec. intervals) is the slowest.

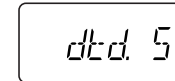
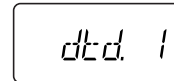

- ④ Push **[*•ENT↔O]** to exit **INITIAL SET MODE**.

Scan types

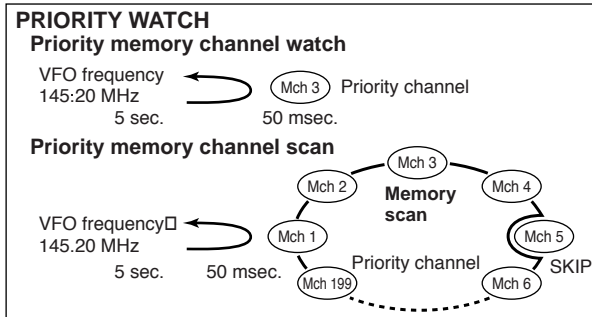
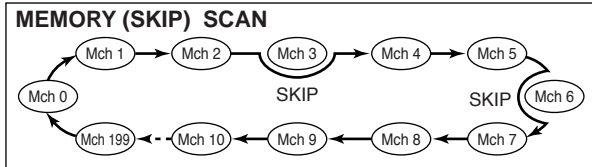
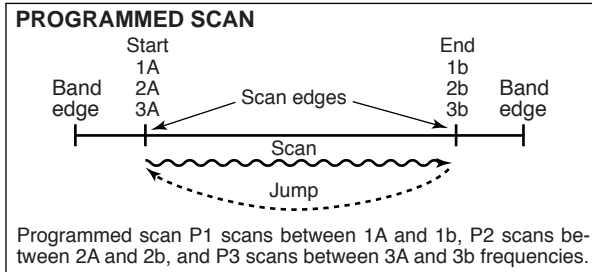

Programmed scan

Programmed scan repeatedly scans between two user programmed frequencies (memory channels “1A–3A” and “1b–3b”) or scans between upper and lower band edges. This scan is useful for checking for signals within a specific frequency range such as repeater output frequencies, etc. Scans between lower (start) and high (stop) frequency.

- ① Push **[D•CLR]** to select VFO mode, if necessary.
- ② Push **[A•FUNC]** and **[5•SCAN]** to start the scan, then a selected scan edge appears as “P1,” “P2,” “P3” or “AL.”
 - To change the scan edge, push **[A•FUNC]** and **[8•SET]** several times until the desired scan edge appears.
 - “AL” for full scan, “P1,” “P2” and “P3” for programmed scan between the programmed scan edge channels as “1A”–“1b,” “2A”–“2b” and “3A”–“3b.”
 - To change the scan direction, push **[▲]** or **[▼]**.
 - When **[VOL]** is assigned as tuning dial, rotate **[VOL]** to change the scan direction. (pgs. 14, 63)



- ③ Push **[D•CLR]** to stop the scan.

NOTE: Scan edges, 1A–3A/1b–3b, must be programmed in advance. Program them in the same manner as regular memory channels. (p. 21)
 If the same frequencies are programmed into the scan edges, programmed scan will not proceed.

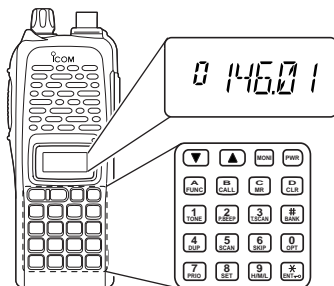

Memory scan

Memory scan repeatedly scans all programmed memory channels, except those set as *skip* channels.

- ① Push **[C•MR]** to select memory mode, if necessary.
 - “**MR**” appears.
- ② Push **[A•FUNC]** and **[5•SCAN]** to start the scan.
 - To change the scan direction, push **[▲]** or **[▼]**.
 - When **[VOL]** is assigned as tuning dial, rotate **[VOL]** to change the scan direction. (pgs. 14, 63)



- ③ Push **[D•CLR]** to stop the scan.

• **Bank scan** — Select the desired bank at above step ①.

- ① Push **[A•FUNC]** and **[#•BANK]** to select memory bank condition.

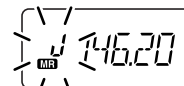

- ② Rotate **[VOL]** to select the desired bank, A to J.
- ③ Push **[*•ENT MR]** (or **[D•CLR]**) to set the bank.

8 SCAN OPERATION

■ Skip channels

In order to speed up the scan interval, you can set memory channels you don't wish to scan as skip channels.

- ① Push [**C•MR**] to select memory mode, if necessary.
 - “MR” appears.
- ② Select a memory channel to set as a skip channel.
- ③ Push [**A•FUNC**] and [**6•SKIP**] to toggle the skip setting ON and OFF.
 - “SKIP” appears when the channel is set as a skip channel.

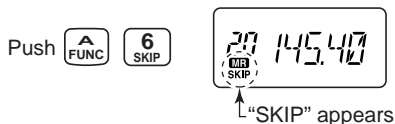

■ Priority watch

Priority watch checks for signals on “priority channels” while operating on a VFO frequency.

◇ Memory or call channel watch

While operating on a VFO frequency, memory or call channel watch monitors for signals in the selected memory or call channel every 5 sec.

- ① Select the desired memory channel or the call channel.
- ② Push [**D•CLR**] to select VFO mode.
- ③ Push [**A•FUNC**], then push [**7•PRIO**] to start watching.
 - VFO is displayed, then the decimal point “.”, on the frequency readout blinks.
 - The priority channel is monitored every 5 sec.
 - When the signal is detected on the priority channel, the watching is paused according to the setting of the scan resume condition.
- ④ Push [**D•CLR**] to stop watching.