

**COMMUNICATIONS RECEIVER**  
**IC-R9500**

**Instruction Manual**

---

## FOREWORD

---

Thank you for making the IC-R9500 your radio of choice. We hope you agree with Icom's philosophy of "technology first." Many hours of research and development went into the design of your IC-R9500.

### ◇ FEATURES

- *Ultimate receiver performance: 110 dB wide dynamic range and third-order intercept (IP3) of +40 dBm (HF bands only)*
- *7-inch wide color TFT LCD*
- *Built-in Baudot FSK demodulator*
- *High resolution spectrum scope— center frequency and fix frequency modes, plus mini-scope displays*

---

## IMPORTANT

---

**READ THIS INSTRUCTION MANUAL CAREFULLY** before attempting to operate the receiver.

**SAVE THIS INSTRUCTION MANUAL.** This manual contains important safety and operating instructions for the IC-R9500.

---

## EXPLICIT DEFINITIONS

---

WORD	DEFINITION
<b>⚠ WARNING</b>	Personal injury, fire hazard or electric shock may occur.
<b>CAUTION</b>	Equipment damage may occur.
<b>NOTE</b>	If disregarded, inconvenience only. No risk of personal injury, fire or electric shock.

---

## TRADEMARKS

---

Icom, Icom Inc. and the Icom logo are registered trademarks of Icom Incorporated (Japan) in the United States, the United Kingdom, Germany, France, Spain, Russia and/or other countries.

---

## PRECAUTIONS

---

⚠ **WARNING! NEVER** operate the receiver with a headset or other audio accessories at high volume levels. Hearing experts advise against continuous high volume operation. If you experience a ringing in your ears, reduce the volume or discontinue use.

⚠ **CAUTION! NEVER** change the internal settings of the receiver. This may reduce receiver performance and/or damage to the receiver.

The receiver warranty does not cover any problems caused by unauthorized internal adjustment.

⚠ **CAUTION!** The receiver weighs approx. 20 kg (44 lb). Always have two people available to carry, lift or turn over the receiver.

⚠ **CAUTION!** The line-voltage receptacle must be near the receiver and must be easily accessible. Avoid extension cords.

⚠ **ACHTUNG!** Die Steckdose muß nahe bei diesem Gerät angebracht und zugänglich sein.

⚠ **NEVER** let metal, wire or other objects protrude into the receiver or into connectors on the rear panel. This may result in an electric shock.

⚠ **NEVER** block any cooling vents on the top, rear or bottom of the receiver.

⚠ **NEVER** expose the receiver to rain, snow or any liquids.

⚠ **NEVER** install the receiver in a place without adequate ventilation. Heat dissipation may be reduced, and the receiver may be damaged.

⚠ **NEVER** operate or touch the receiver with wet hands. This may result in an electric shock or damage to the receiver.

**DO NOT** use chemical agents such as benzine or alcohol when cleaning the IC-R9500, as they can damage the receiver's surfaces.

**AVOID** using or storing the receiver in areas with temperatures below  $\pm 0^{\circ}\text{C}$  ( $+32^{\circ}\text{F}$ ) or above  $+50^{\circ}\text{C}$  ( $+122^{\circ}\text{F}$ ).

**AVOID** placing the receiver in excessively dusty environments or in direct sunlight.

**AVOID** placing the receiver against walls or putting anything on top of the receiver. This may overheat the receiver.

Always place unit in a secure place to avoid inadvertent use by children.

The LCD display may have cosmetic imperfections that appear as small dark or light spots. This is not a malfunction or defect, but a normal characteristic of LCD displays.

During maritime mobile operation, keep the receiver as far away as possible from the magnetic navigation compass to prevent erroneous indications.

Turn [I/O] switch (on the rear panel) OFF and/or disconnect the AC power cable from the AC outlet when you will not use the receiver for a long period of time.

### *For U.S.A. only*

**CAUTION:** Changes or modifications to this device, not expressly approved by Icom Inc., could void your authority to operate this device under FCC regulations.

---

## ABOUT APCO PROJECT 25

---

This device made under license under one or more of the following US patents: #4,590,473, #4,636,791, #5,148,482, #5,185,796, #5,271,017, #5,377,229.

The IMBE™ voice coding technology embodied in this product is protected by intellectual property rights including patent rights, copyrights and trade secrets of Digital Voice Systems, Inc. This voice coding Technology is licensed solely for use within this communications equipment. The user of this technology is explicitly prohibited from attempting to decompile, reverse engineer, or disassemble the object code, or in any other way convert the object code into a human-readable form. U.S. Pat. nos. #5,870,405, #5,826,222, #5,754,974, #5,701,390, #5,715,365, #5,649,050, #5,630,011, #5,581,656, #5,517,511, #5,491,772, #5,247,579, #5,226,084, #5,195,166.

P25 digital mode is available when the optional UT-122 DIGITAL UNIT is installed.
---

# SUPPLIED ACCESSORIES

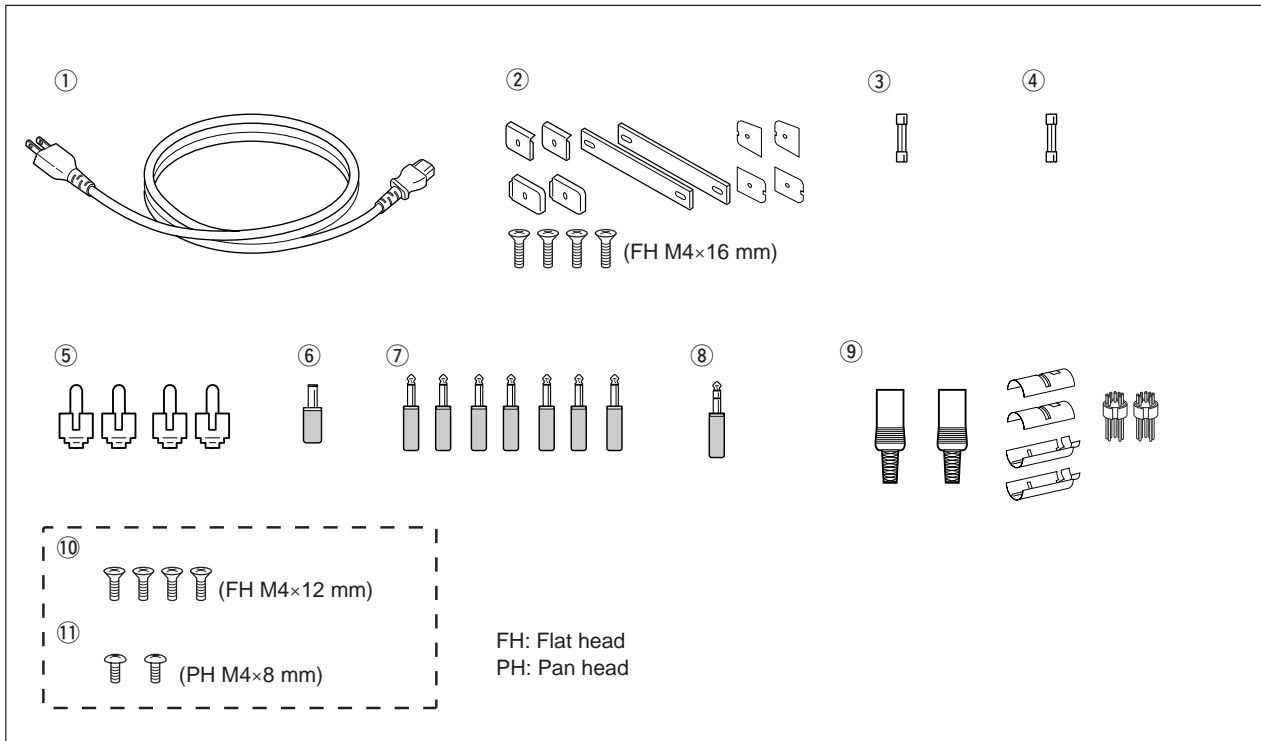

① AC power cable*	1
② Carrying handles	1 set
③ Spare fuse (FGB 1 A)	1
④ Spare fuse	
FGB 4 A (100 V/120 V versions)	1
0234002MXP (230 V/240 V versions)	1
⑤ RCA plugs	4
⑥ DC power plug	1
⑦ 2-conductor 1/8" plugs	7
⑧ 3-conductor 1/8" plugs	1
⑨ 8 pin ACC plugs	2
⑩ Screws for side plate†	4
⑪ Hiding screws for screw hole†	2

\*May differ from that shown according to version

†These screw are used when removing rack mounting handles

---

# TABLE OF CONTENTS

---

<b>Section 1</b>	<b>PANEL DESCRIPTION</b>	
	■ Front panel .....	1-2
	■ Rear panel .....	1-8
	■ LCD display .....	1-10
	■ Screen menu arrangement .....	1-12
<b>Section 2</b>	<b>INSTALLATION AND CONNECTIONS</b>	
	■ Unpacking .....	2-2
	■ Selecting a location .....	2-2
	■ Grounding .....	2-2
	■ Antenna connection .....	2-3
	■ TV jumper cable connection .....	2-4
	■ Carrying handle attachment .....	2-4
	■ Rack mounting handle detachment .....	2-4
	■ Required connections .....	2-5
	◇ Rear panel .....	2-5
	■ Advanced connections .....	2-6
	◇ Front panel .....	2-6
	◇ Rear panel—1 .....	2-6
	◇ Rear panel—2 .....	2-7
	■ Tape recorder connections .....	2-8
	◇ Recording from the front panel or rear panel .....	2-8
	◇ Separately recording audio and frequency .....	2-9
	■ Monitor display connection .....	2-10
	■ Transceive function .....	2-10
	■ FSK and AFSK (SSTV) connections .....	2-11
	■ Accessory connector information .....	2-12
<b>Section 3</b>	<b>BASIC OPERATIONS</b>	
	■ When first applying power (CPU resetting) .....	3-2
	■ Initial settings .....	3-2
	■ Selecting VFO mode .....	3-3
	■ Selecting memory mode .....	3-3
	■ Frequency setting .....	3-4
	◇ Direct frequency entry with the keypad .....	3-4
	◇ Tuning with the main dial .....	3-5
	◇ Selecting a tuning step .....	3-5
	◇ Auto tuning step function .....	3-6
	◇ 1/4 tuning step function .....	3-6
	■ Operating mode selection .....	3-7
	■ Volume setting .....	3-8
	■ RF gain adjustment .....	3-8
	■ Squelch level adjustment .....	3-8
	■ Audio tone adjustment .....	3-9
	◇ Treble level adjustment .....	3-9
	◇ Bass level adjustment .....	3-9
	■ Meter indication selection .....	3-10
	◇ Meter type selection .....	3-10
<b>Section 4</b>	<b>RECEIVE MODES</b>	
	■ Operating FM .....	4-2
	◇ Convenient functions for FM .....	4-2
	■ Duplex operation .....	4-3
	◇ Offset frequency setting .....	4-3

---

# TABLE OF CONTENTS

---

- Tone/DTCS squelch operation ..... 4-4
- Operating WFM ..... 4-5
  - ◇ Convenient functions for WFM .....4-5
- TV channel operation ..... 4-6
  - ◇ Convenient functions for TV operation .....4-6
- Operating AM ..... 4-7
  - ◇ Convenient functions for AM .....4-7
- Operating SSB ..... 4-8
  - ◇ Convenient functions for SSB .....4-8
- Operating CW ..... 4-9
  - ◇ Convenient functions for CW .....4-9
  - ◇ APF (Audio Peak Filter) operation .....4-10
  - ◇ About CW reverse mode .....4-10
  - ◇ About CW pitch control .....4-10
- Operating FSK ..... 4-11
  - ◇ Convenient functions for FSK .....4-12
  - ◇ About FSK reverse mode .....4-12
  - ◇ Twin peak filter .....4-12
  - ◇ Functions for the FSK decoder indication .....4-13
  - ◇ Setting the decoder threshold level .....4-13
  - ◇ FSK decode set mode .....4-14
  - ◇ Time stamp function .....4-15
  - ◇ Setting FSK tone frequency .....4-16
  - ◇ Setting FSK Baud rate .....4-16
  - ◇ Data saving .....4-17
- Operating P25 (Requires optional UT-122) ..... 4-18
  - ◇ Convenient functions for P25 .....4-18
- Digital squelch operation ..... 4-19

## Section 5 RECEIVE FUNCTIONS

- Spectrum scope screen ..... 5-2
  - ◇ Center mode ..... 5-2
  - ◇ Fix mode ..... 5-3
  - ◇ Peak marker function ..... 5-4
  - ◇ Wide band-pass filter selection..... 5-5
  - ◇ Wide band scope function ..... 5-5
  - ◇ Mini scope screen indication ..... 5-6
  - ◇ Scope set mode ..... 5-6
- Preamplifier ..... 5-9
- Attenuator ..... 5-9
- AGC function ..... 5-10
  - ◇ Selecting the preset value .....5-10
  - ◇ Adjusting the AGC time constant .....5-10
  - ◇ Setting the AGC time constant preset value .....5-10
- Twin PBT operation ..... 5-11
- IF filter selection ..... 5-12
  - ◇ IF filter selection ..... 5-12
  - ◇ Filter passband width setting ..... 5-12
  - ◇ Roofing filter selection ..... 5-13
  - ◇ DSP filter shape ..... 5-13
  - ◇ Filter shape set mode ..... 5-13
- Noise blanker ..... 5-15
  - ◇ NB set mode ..... 5-15

---

# TABLE OF CONTENTS

---

	■ Noise reduction .....	5-16
	■ Notch function .....	5-16
	■ Autotune function .....	5-17
	■ AFC function .....	5-17
<b>Section 6</b>	<b>VOICE RECORDER FUNCTIONS</b>	
	■ About digital voice recorder .....	6-2
	■ Recording a received audio .....	6-3
	◇ Regular recording .....	6-3
	■ Playing the recorded audio .....	6-3
	◇ Regular playing .....	6-3
	■ Erasing the recorded contents .....	6-4
	■ Selecting the CF memory card or USB-Memory .....	6-4
	■ Short recording .....	6-5
	◇ Recording .....	6-5
	◇ Playing back .....	6-5
	■ Voice set mode .....	6-6
<b>Section 7</b>	<b>MEMORY OPERATION</b>	
	■ Memory channels .....	7-2
	■ Memory channel selection .....	7-3
	◇ Using the [M-CH]/[BANK] selectors .....	7-3
	◇ Using the keypad .....	7-3
	■ Memory channel programming .....	7-4
	◇ Programming in VFO mode .....	7-4
	◇ Programming in memory mode .....	7-4
	■ Frequency transferring .....	7-5
	◇ Transferring in VFO mode .....	7-5
	◇ Transferring in memory mode .....	7-5
	■ Memory names .....	7-6
	◇ Editing (programming) memory names .....	7-6
	■ Memory clearing .....	7-6
	■ Memory list screen .....	7-7
	◇ Selecting a memory channel using the memory list screen .....	7-7
	◇ Confirming programmed memory channels .....	7-7
	◇ Memory bank set .....	7-8
<b>Section 8</b>	<b>SCANS</b>	
	■ Scan types .....	8-2
	■ Preparation .....	8-3
	■ Voice squelch control function .....	8-3
	■ Scan set mode .....	8-4
	■ Priority scan .....	8-5
	◇ Setting .....	8-5
	◇ Priority scan operation .....	8-5
	■ Programmed scan .....	8-6
	◇ Setting .....	8-6
	◇ Program scan operation .....	8-7
	■ $\Delta F$ scan .....	8-8
	◇ Setting .....	8-8
	◇ $\Delta F$ scan operation .....	8-8
	■ Fine programmed scan/fine $\Delta F$ scan operation .....	8-9
	■ Auto memory write scan operation .....	8-10

---

# TABLE OF CONTENTS

---

	■ Memory scan .....	8-11
	◇ Setting .....	8-11
	◇ Memory scan operation .....	8-11
	◇ Programming the select memory scan setting .....	8-12
	◇ Select memory scan operation .....	8-13
	◇ Mode select memory scan operation .....	8-14
	■ Skip scan .....	8-15
	◇ Specifying skip channels .....	8-15
	◇ Programming skip frequencies (for programming scan) .....	8-15
	◇ Skip scan setting .....	8-15
	■ Tone scan .....	8-16
	■ Scan resume condition.....	8-17
	■ Scan speed .....	8-18
	■ Scan delay .....	8-18
<b>Section 9</b>	<b>OTHER FUNCTIONS</b>	
	■ Voice synthesizer operation .....	9-2
	■ Lock function .....	9-2
	◇ Dial lock function.....	9-2
	◇ Panel lock function .....	9-2
	■ Dial click function .....	9-3
	■ Antenna selection .....	9-3
<b>Section 10</b>	<b>CLOCK AND TIMERS</b>	
	■ Time set mode .....	10-2
	■ Daily timer setting .....	10-3
	■ Setting sleep timer .....	10-4
	■ Timer operation .....	10-4
<b>Section 11</b>	<b>SET MODE</b>	
	■ Set mode description .....	11-2
	◇ Set mode operation .....	11-2
	◇ Screen arrangement .....	11-3
	■ Level set mode .....	11-4
	■ ACC set mode .....	11-7
	■ Display set mode .....	11-8
	■ Others set mode .....	11-10
	■ CF card/USB-Memory set menu .....	11-16
	◇ CF/USB-Memory set screen arrangement .....	11-16
	◇ Load option set mode .....	11-17
	■ File saving .....	11-18
	■ File loading .....	11-19
	■ Changing the file name .....	11-20
	■ File copying .....	11-21
	■ Deleting a file .....	11-22
	■ Unmount an USB-Memory .....	11-22
	■ Formatting the CF card or USB-Memory .....	11-23
	■ Display set (Video) mode .....	11-24
	■ LCD set mode .....	11-26
<b>Section 12</b>	<b>MAINTENANCE</b>	
	■ Troubleshooting .....	12-2
	◇ Receiver power .....	12-2
	◇ Receiving .....	12-2



---

# TABLE OF CONTENTS

---

	◇ Scanning .....	12-3
	◇ Display .....	12-3
	◇ Voice recorder .....	12-3
	◇ Format memory media .....	12-3
	■ Screen type selection .....	12-4
	■ Main dial brake adjustment .....	12-4
	■ Frequency calibration (approximate) .....	12-5
	■ Opening the receiver's case .....	12-6
	■ Opening the shield case .....	12-6
	■ UT-122 installation .....	12-7
	■ Clock backup battery replacement .....	12-7
	■ Fuse replacement .....	12-8
	◇ AC power input fuse .....	12-8
	◇ DC output fuse .....	12-8
	■ Resetting the CPU .....	12-9
	■ Screen Saver Function .....	12-9
<b>Section 13</b>	<b>CONTROL COMMAND</b>	
	■ Remote interface (CI-V) information .....	13-2
	◇ CI-V connection example .....	13-2
	◇ Data format .....	13-2
	◇ Command table .....	13-3
	◇ To send/read memory contents .....	13-10
	◇ Codes for memory name, bank name, opening message, and clock 2 name contents .....	13-10
	◇ Offset frequency setting .....	13-10
	◇ Tone squelch frequency setting .....	13-10
	◇ DTCS squelch code setting .....	13-10
	◇ NAC squelch code setting .....	13-11
	◇ Selective squelch code settings .....	13-11
	◇ Color setting .....	13-11
	◇ Data mode with filter width setting .....	13-11
<b>Section 14</b>	<b>SPECIFICATIONS AND OPTIONS</b>	
	■ Specifications .....	14-2
	◇ General .....	14-2
	◇ Receiver .....	14-3
	■ Options .....	14-4
<b>Section 15</b>	<b>UPDATING THE FIRMWARE</b>	
	■ General .....	15-2
	■ Caution .....	15-2
	■ Preparation .....	15-3
	◇ Firmware and firm utility .....	15-3
	◇ File downloading .....	15-3
	■ Firmware update— CF memory card .....	15-4
	■ Firmware update— PC .....	15-6
	◇ Connections .....	15-6
	◇ IP address setting .....	15-7
	◇ Updating from the PC .....	15-8



# PANEL DESCRIPTION

# Section 1

---

- Front panel ..... 1-2
- Rear panel ..... 1-8
- LCD display ..... 1-10
- Screen menu arrangement ..... 1-12

# 1 PANEL DESCRIPTION

## ■ Front panel

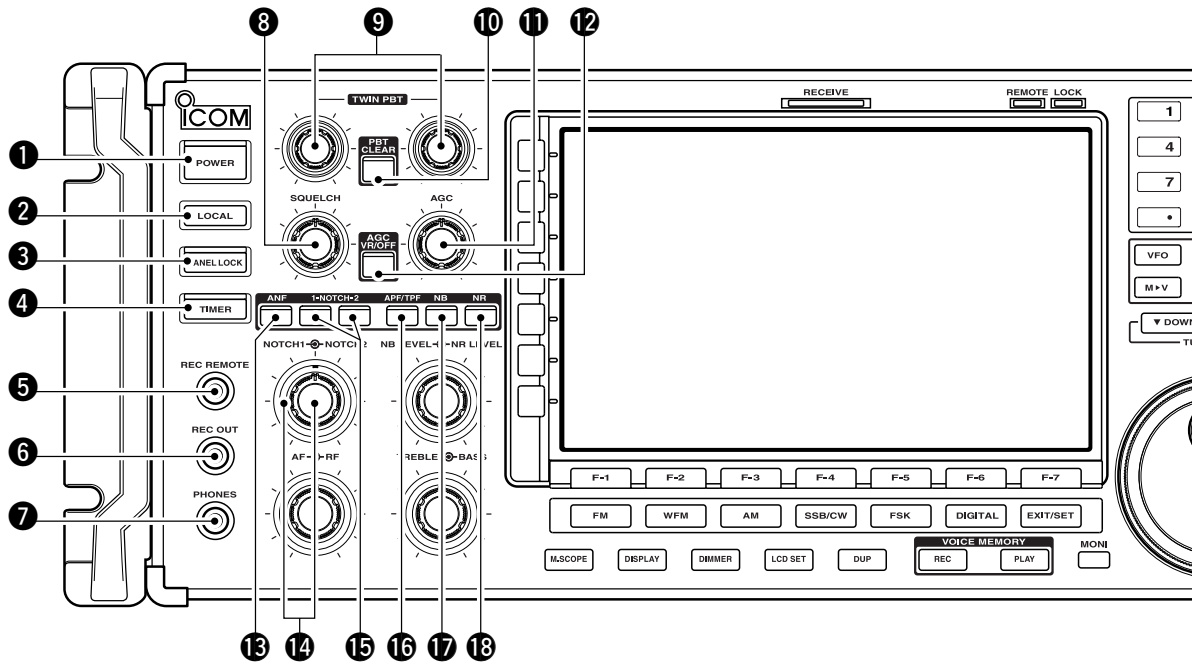

### 1 POWER SWITCH [POWER] (p. 3-2)

Turn the internal power supply ON before turning the unit ON from the front panel. The internal power supply switch is located on the rear panel. (p. 3-2)

- Push to turn the receiver power ON.
  - The [POWER] indicator above this switch lights green when powered ON.
- Push for 1 sec. to turn the receiver power OFF.
  - The [POWER] indicator lights orange when the receiver is OFF when the internal power supply is switched ON.

### 2 REMOTE CONTROL SWITCH [LOCAL]

- Push to cancel remote control operation from a PC via a CI-V data.
- The [REMOTE] indicator lights yellow while in remote control operation.
  - When the [REMOTE] indicator lights yellow, all dials, keys or switches other than this switch are disabled.

### 3 PANEL LOCK SWITCH [PANEL LOCK] (p. 9-2)

- Push to turn the panel lock function ON or OFF. The panel lock function locks all dials, keys and switches other than [POWER] and [PANEL LOCK].
- The [PANEL LOCK] indicator above this switch lights yellow when the timer is in use.
  - The dial lock function is also available.

### 4 TIMER SWITCH [TIMER] (p. 10-3)

- Turns the sleep or daily timer function ON or OFF.
  - The [TIMER] indicator above this switch lights green when the timer is in use.
- Enters timer set mode when pushed and held for 1 sec.

### 5 RECORDER REMOTE JACK [REC REMOTE]

Controls the operation of a tape recorder for recording. Connects to the REMOTE jack on a tape recorder.

### 6 RECORDER JACK [REC OUT]

Outputs an audio signal. Connect to the AUX or LINE IN jack on a tape recorder.

### 7 HEADPHONE JACK [PHONES]

- Accepts standard 3.5 (d) mm (1/8) stereo headphones.
- Output power: 40 mW with an 8  $\Omega$  load.
  - When headphones are connected, the internal speaker or connected external speaker does not function.

### 8 SQUELCH CONTROL [SQUELCH] (p. 3-8)

- Adjusts the squelch threshold level. The squelch disables output from the speaker (closed condition) when no signal is received.
- The squelch control is particularly effective for FM or AM. It is also available for other modes.
  - 11 to 12 o'clock position is recommended for any setting of the [SQL] control.

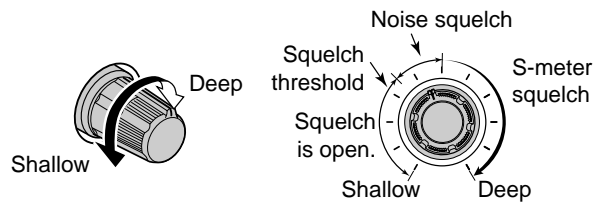

**9 PASSBAND TUNING CONTROLS [TWIN PBT]**

(p. 5-11)

Adjusts the IF filter “passband width” via the DSP.

- Passband width and shift frequency are shown on the multifunction display.
- Push and hold [PBT CLEAR] for 1 sec. to clear the PBT settings.
- Variable range is set to half of the IF filter passband width. 25 Hz steps and 50 Hz steps are available in SSB, CW and FSK modes.

**✓ What is the PBT control?**

The PBT function electronically modifies the IF passband width to reject interference. This receiver uses the DSP circuit for the PBT function.

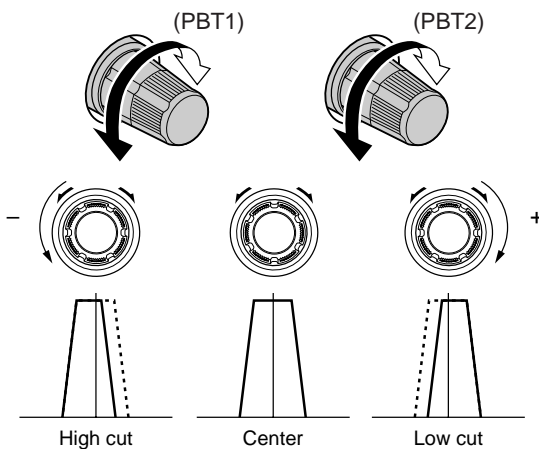

**10 PBT CLEAR SWITCH [PBT CLEAR]** (p. 5-11)

Push and hold for 1 sec. to clear the PBT settings.

- The [PBT CLEAR] indicator above this switch lights when PBT is in use.

**11 AGC CONTROL [AGC]** (p. 5-10)

Adjusts the continuously-variable AGC circuit time constant.

- To use [AGC] control, push the appropriate band's [AGC VR/OFF] ([AGC VR] indicator lights green).



**12 AGC SWITCH [AGC VR/OFF]** (p. 5-10)

- ➔ Push to toggle [AGC] control usage ON or OFF.
  - Use [AGC] control to set the AGC time constant when switched ON.
  - The [AGC VR] indicator above this switch lights green when the control is ON.
- ➔ Turns the AGC function OFF when pushed and held for 1 sec.

**13 AUTO NOTCH SWITCH [ANF]** (p. 5-16)

- ➔ Turns the auto notch function ON or OFF when pushed in SSB, AM, FM and WFM mode.
  - “AN” appears when auto notch is in use.

**14 MANUAL NOTCH SWITCHES [NOTCH1]/[NOTCH2]** (p. 5-16)

- ➔ Turns the manual notch function ON or OFF when pushed in SSB, CW, AM and FSK mode.
  - “MN1” or “MN2” appear when manual notch is in use.
- ➔ Switches the manual notch characteristics between wide, middle and narrow when pushed and held for 1 sec.

**✓ What is the notch function?**

The notch function eliminates unwanted CW or AM carrier tones while preserving the desired voice signal. The DSP circuit automatically adjusts the notch frequency to effectively eliminate unwanted tones.

**15 MANUAL NOTCH FILTER CONTROLS [NOTCH1]/[NOTCH2]** (p. 5-16)

Varies the “notch” frequency of the manual notch filter to reject an interfering signal while the manual notch function is ON.

- Notch filter center frequency:
  - SSB : -1060 Hz to 4040 Hz
  - CW : CW pitch freq. + 2540 Hz to CW pitch freq. -2540 Hz
  - AM : -5100 Hz to 5100 Hz

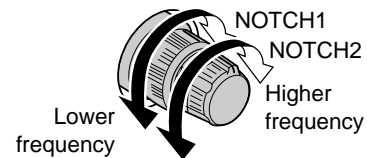

**16 AUDIO PEAK FILTER/TWIN PEAK FILTER SWITCH [APF/TPF]**

- ➔ Push to turn the audio peak filter ON or OFF during CW mode operation. (p. 4-10)
- ➔ Push to turn the twin peak filter ON or OFF during FSK mode operation. (p. 4-12)
  - “APF” appears when audio peak filter is in use.
  - “TPF” appears when twin peak filter is in use.
- ➔ During CW mode operation, push and hold for 1 sec. to select the APF passband width from 80, 160 and 320 Hz. (p. 4-10)

**17 NOISE BLANKER SWITCH [NB]** (p. 5-15)

- ➔ Selects from noise blanker 1, 2, or OFF when pushed. The noise blanker reduces pulse-type noise such as that generated by automobile ignition systems. This function cannot be used for FM/WFM, P25 modes or non-pulse-type noise.
  - The [NB] indicator above this switch lights green and “NB1” or “NB2” appears on the display when the function is activated.
- ➔ Enters blank-width set mode when pushed and held for 1 sec.

**18 NOISE REDUCTION SWITCH [NR]** (p. 5-16)

- ➔ Push to switch the DSP noise reduction ON or OFF.
  - The [NR] indicator above this switch lights green when the function is activated.

■ Front panel (continued)

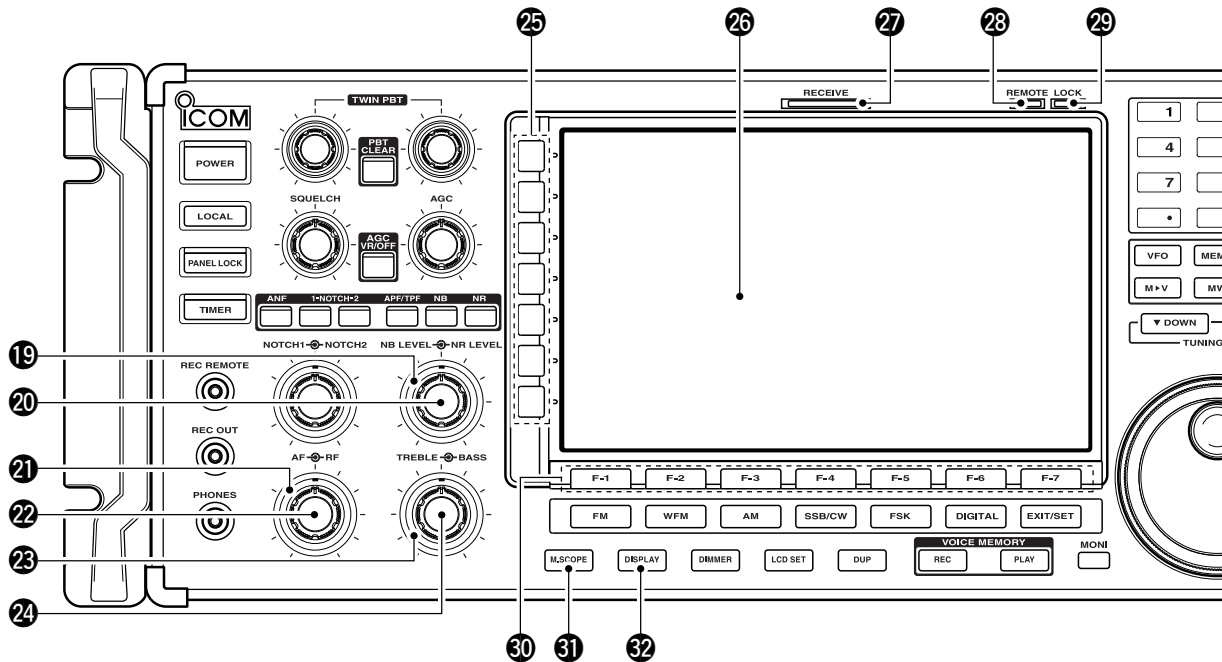

**19 NOISE REDUCTION LEVEL CONTROL [NR LEVEL]** (outer control; p. 5-16)  
 Adjusts the DSP noise reduction level when noise reduction is in use. Set for maximum readability.  
 • To use this control, noise reduction must be ON.

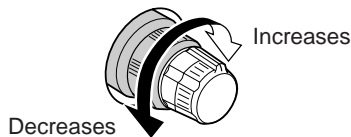

**20 NOISE BLANKER CONTROL [NB LEVEL]** (inner control; p. 5-15)  
 Adjust the noise blanker threshold level.  
 • To use this control, either noise blanker must be ON.

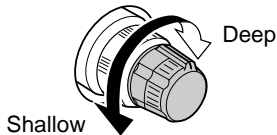

**21 RF GAIN CONTROL [RF]** (outer control; p. 3-8)  
 Adjusts the RF gain level.  
 While rotating the RF gain control, you may hear noise. This comes from the DSP unit and does not indicate a malfunction.

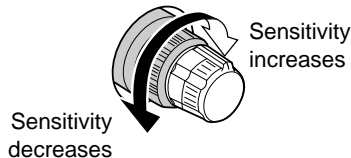

**22 AF CONTROL [AF]** (inner control; p. 3-8)  
 Varies the audio output level of the speaker or headphones.

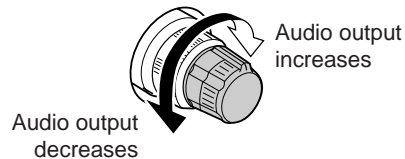

**23 BASS RESPONSE CONTROL [BASS]** (outer control; p. 3-9)  
 Adjusts the bass response of the audio output.

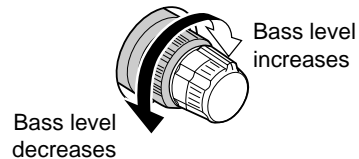

**24 TREBLE RESPONSE CONTROL [TREBLE]** (inner control; p. 3-9)  
 Adjusts the treble response of the audio output.

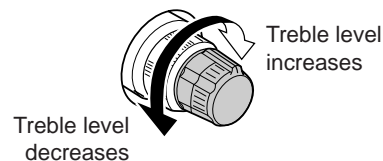

## 25 MULTIFUNCTION SWITCHES

Push to select the functions indicated in the LCD display to the right of these switches.

- Functions vary depending on the operating condition.



- ➔ While operating HF bands, selects the antenna connector from HF ANT 1, HF ANT 2 and HF ANT 3 when pushed. (p. 9-3)
  - During 30–1150 MHz operation, only ANT 1 is available.
  - During 1150–3335 MHz operation, only ANT 2 is available.
- ➔ Turns the antenna control voltage ON and OFF form [ANT SEL] when pushed and held for 1 sec. (p. 9-3)



- ➔ Selects one of 2 receive RF preamps or bypasses them. (p. 5-9)
  - “P. AMP1” activates 10 dB preamp.
  - “P. AMP2” activates 16 dB high-gain preamp.

### ✓ What is the preamp?

The preamp amplifies received signals in the front end circuit to improve S/N ratio and sensitivity. Select “P. AMP1” or “P. AMP2” when receiving weak signals.



- ➔ Selects the attenuator when pushed. (p. 5-9)
  - HF bands: 6, 12, 18, 24, 30 dB.
  - 30–1150 MHz,: 10, 20, 30 dB.
  - 1150–3335 MHz: 20 dB only.
- ➔ Turns OFF the attenuator when pushed and held for 1 sec. (p. 5-9)

### ✓ What is the attenuator?

The attenuator prevents a desired signal from distorting when very strong signals are near the receiving frequency, or when very strong electric fields, such as from a broadcasting station, are near your location.



- ➔ Selects one of 3 IF filter settings.
- ➔ Enters the filter set screen when pushed and held for 1 sec.



- ➔ Activates and selects fast, middle or slow AGC time constant when pushed. (p. 5-10)
  - In FM/WFM or P25 mode, only “FAST” is available.
  - “VR (volume)” indicates that AGC time constant depends on [AGC] control.
- ➔ Enters the AGC set mode when pushed and held for 1 sec. (p. 5-10)

▨ AGC time constant can be set from 0.1 to 8.0 sec. (depends on mode), or turned OFF. When AGC is ▨ “OFF,” the S-meter does not function.

### ✓ What is the AGC?

The AGC controls receiver gain to produce a constant audio output level, even when the received signal strength varies dramatically. Select “FAST” for tuning and then select “MID” or “SLOW” depending on the receiving conditions.



- ➔ Switches between the tone squelch, DTCS squelch function and no-tone operation when pushed in FM mode. (p. 4-4)
- ➔ Enters the tone set mode when pushed and held for 1 sec. in FM/FSK mode. (pgs. 4-4, 4-16)



- ➔ Push to toggle the CW pitch setting screen ON and OFF in CW mode. (p.4-10)



(Requires optional UT-122)

- ➔ Switches the digital squelch between NAC squelch, selective squelch and OFF in P25 mode. (p. 4-19)
- ➔ Enters the code set mode when pushed and held for 1 sec. in P25 mode. (p. 4-19)



- ➔ Push to switch the voice squelch control function ON and OFF; useful for scanning.

## 26 LCD FUNCTION DISPLAY (p. 1-10)

Shows the operating frequency, function switch menus, spectrum scope screen, memory channel screen, set mode settings, etc.

## 27 RECEIVE INDICATOR [RECEIVE]

Lights green while receiving a signal and when the squelch is open.

## 28 REMOTE CONTROL INDICATOR [REMOTE]

Lights yellow when a command is received from a PC via CI-V data.

- When this indicator lights yellow, all dials, keys or switches other than [LOCAL] are disabled.
- This indicator goes OFF, when [LOCAL] is pushed.

## 29 DIAL LOCK INDICATOR [LOCK] (p. 9-2)

Lights orange when the dial lock function is activated.

## 30 LCD FUNCTION SWITCHES [F-1]–[F-7]

Push to select the function indicated in the LCD display above these switches.

- Functions vary depending on the operating condition.

## 31 MINI SPECTRUM SCOPE SWITCH [M.SCOPE]

(p. 5-6)

- ➔ Turns the mini spectrum scope screen ON or OFF.
- The mini spectrum scope screen can be displayed with another screen, such as memory or set mode screen, simultaneously.

## 32 DISPLAY SWITCH [DISPLAY]

- ➔ Push to toggle the external input screen between mini TV screen, full TV screen, or OFF.
  - If no signal inputs from [VIDEO IN], black screen appears.
- ➔ Enter the display set mode menu screen when pushed and held for 1 sec.



■ Front panel (continued)

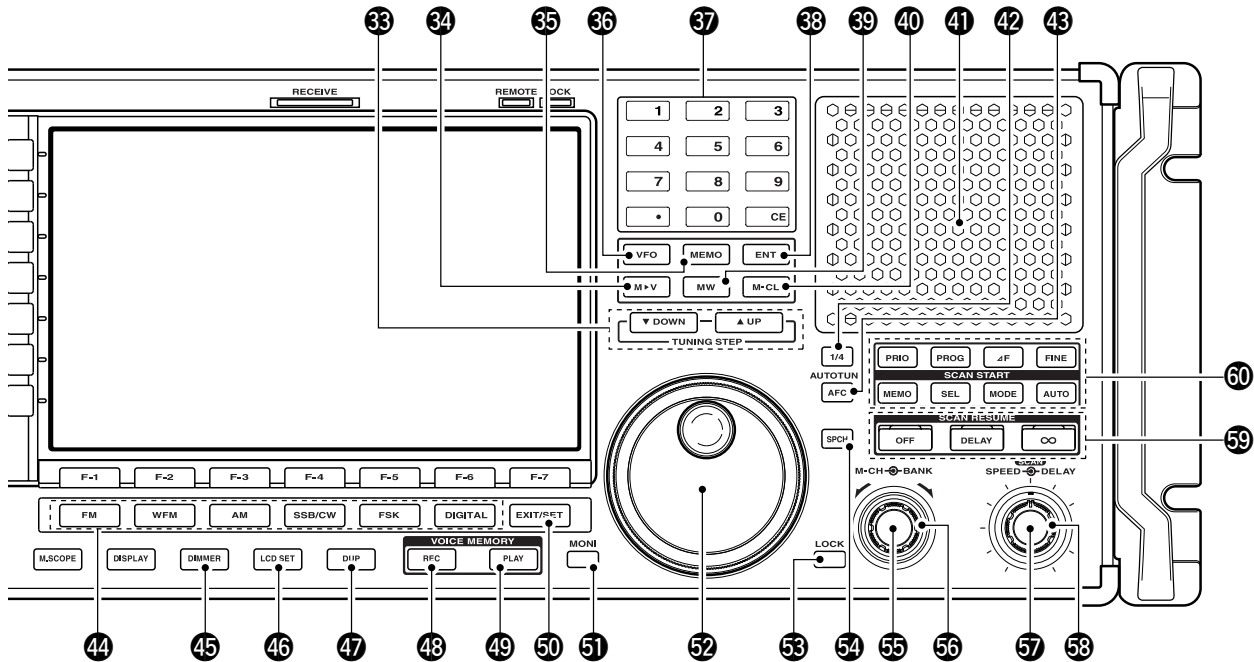

**33 TUNING STEP SWITCHES [▲UP]/[▼DOWN]**

- (p. 3-5)
- Select the tuning step for the main dial. Push [▲UP] to select a larger tuning step; push [▼DOWN] to select a smaller tuning step.
    - 1 Hz, 10 Hz, 100 Hz, 1 kHz, 2.5 kHz, 5 kHz, 6.25 kHz, 9 kHz, 10 kHz, 12.5 kHz, 20 kHz, 25 kHz, 100 kHz and 1 MHz are selectable.
    - Programmable tuning steps can be set between 0.1 and 999.9 kHz in 0.1 kHz steps.
      - ➡ To set programmable tuning steps, enter the desired steps via the keypad, then push [▲UP] or [▼DOWN].
  - Push and hold [▲UP] (or [▼DOWN]) for 1 sec. to enter the tuning step select screen.
    - Unwanted tuning step for each operating mode can be skipped in the tuning step select.

**34 MEMORY TRANSFER SWITCH [M▶V]** (p. 7-5)

- Transfers the memory contents to VFO when pushed and held for 1 sec.
- This function is available both in VFO and memory modes.

**35 MEMORY SWITCH [MEMO]** (p. 7-3)

- Selects the memory mode when pushed.
  - After pushing one to three digit (0 to 999), pushing the switch selects a memory channel.
- Memory bank limit function ON or OFF when pushed and held for 1 sec.

**36 VFO SWITCH [VFO]**

- Selects the VFO mode when pushed. (p. 3-3)
- After pushing a digit switch (0 to 9), push this switch selects a VFO mode (VFO-0 to VFO-9).

**37 KEYPAD** (pgs. 3-3, 3-4, 7-3)

- Enters a frequency or memory channel. Pushing [ENT], [VFO] or [MEMO] ends keypad input.
- e.g. to enter 14.195 MHz, push [1] [4] [•] [1] [9] [5] [ENT].

**38 ENTER SWITCH [ENT]**

- Enters input frequency. (pgs. 3-4)

**39 MEMORY WRITE SWITCH [MW]** (p. 7-4)

- Stores the selected readout frequency and operating mode into the displayed memory channel when pushed and held for 1 sec.
- This function is available both in VFO and memory modes.

**40 MEMORY CLEAR SWITCH [M-CL]** (p. 7-7)

- Push and hold to clear the contents of displayed memory channel.

**41 SPEAKER**

- Outputs audio signals.

**42 1/4-SPEED TUNING SWITCH [1/4]**

- Push to turn the 1/4-speed tuning function ON or OFF in CW and FSK modes. (p. 3-6)
  - “1/4” appears when 1/4 function is in use.
  - 1/4 function sets dial rotation to 1/4 of normal speed for fine tuning.
- Push and hold to turn the dial click function ON or OFF. (p. 9-3)

**43 AUTOMATIC TUNING SWITCH [AUTOTUNE]**

- Turns the automatic tuning function ON or OFF in AM, SSB and CW modes.



**IMPORTANT!**

When receiving a weak signal, or receiving a signal with interference, the automatic tuning function may tune the receiver to an undesired signal.

**44 MODE SWITCHES**

Selects the desired mode. (p. 3-7)

- Announces selected mode via the speech synthesizer. (p. 11-11)



➔ Selects FM mode.



➔ Selects WFM mode.

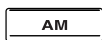

➔ Selects AM and S-AM modes alternately.  
➔ Switches S-AM(D), S-AM(U) and S-AM(L) mode when pushed and held for 1 sec. in S-AM mode.



➔ Switches between SSB and CW mode.  
➔ Switches between LSB and USB mode when pushed and held for 1 sec. in SSB mode.  
➔ Switches between CW and CW-R (CW reverse) mode when pushed and held for 1 sec. in CW mode.



➔ Selects FSK and FSK-R (FSK reverse) modes alternately.



➔ Selects Digital (P25) mode. (Requires optional UT-122.)

**45 DIMMER SWITCH [DIMMER]** (p.11-26)

- ➔ Push to turn the dimmer function ON or OFF.
  - When this function is ON, LEDs and LCD backlight become dim according to the preset setting.
- ➔ Push and hold for 1 sec. to reset the LCD setting to the default value with the dimmer function ON and OFF.

**46 LCD SET SWITCH [LCD SET]** (p. 11-26)

- ➔ Push to toggle the LCD setting screen ON or OFF.
  - LCD contrast and backlight's brightness can be set.

**47 DUPLEX SWITCH [DUP]** (p. 4-3)

- ➔ Push to select the duplex function (DUP-, DUP+ and OFF).
- ➔ Push and hold for 1 sec. to enter the offset frequency set mode.

**48 VOICE MEMORY RECORD SWITCH [REC]**

- ➔ Short recording; Push momentarily to record the signal received for the preset time period before [REC] was pushed. (p.6-5)
  - Starts recording again automatically.
- ➔ Regular recording; Push and hold for 1 sec. to record the received signal until recording is stopped. (p. 6-3)
  - Push and hold this switch for 1 sec. to stop recording.

**49 SHORT VOICE MEMORY PLAY BACK SWITCH [PLAY]** (p. 6-5)

- ➔ Plays back the audio previously recorded during the preset time period when pushed.
- ➔ Plays back all of the previously recorded audio when pushed and held for 1 sec.

**50 EXIT/SET SWITCH [EXIT/SET]**

- ➔ Push to exit, or return to the previous screen during spectrum scope, memory, scan or set mode screen display.
- ➔ Displays set mode menu screen when pushed and held for 1 sec.

**51 MONITOR SWITCH [MONI]** (pgs. 3-8, 4-4, 4-19)

- ➔ Push and hold to open the squelch manually.
  - The [MONI] indicator appears on the display.

**52 MAIN DIAL**

Changes the displayed frequency, selects set mode setting, etc.

**53 LOCK SWITCH [LOCK]** (p. 9-2)

Push to turn the dial lock function ON or OFF.

**54 SPEECH SWITCH [SPCH]** (p. 9-2)

- ➔ Push to announce the S-meter indication and the selected readout frequency.
- ➔ The selected operating mode is also announced when pushed and held for 1 sec.

**55 MEMORY DIAL [M-CH]** (inner control; p. 7-3)

Rotate to select the desired memory channel.
 

- Memory channels can be selected both in VFO and memory modes.

**56 MEMORY BANK DIAL [BANK]**

(outer control; p. 7-3)  
Rotate to select the desired memory bank.
 

- Memory banks can be selected both in VFO and memory modes.

**57 SCAN SPEED CONTROL [SPEED]**

(inner control; p. 8-18)  
Rotate to adjust the scan speed.

**58 SCAN DELAY CONTROL [DELAY]**

(outer control; p. 8-18)  
Rotate to adjust the desired scan delay time.
 

- This setting is effective when "DELAY" is selected for the scan resume condition (59).
- Scan delay time is adjustable between 2 sec. to 20 sec.

**59 SCAN RESUME SWITCHES [OFF]/[DELAY]/[-]**

(p. 8-17)  
Push to select a scan resume condition.
 

- The [SCAN RESUME] indicator lights green above the selected switch.

**60 SCAN START SWITCHES**

(pgs. 8-5, 8-7 to 8-11, 8-13, 8-14)  
Push to start the desired scan.

■ Rear panel

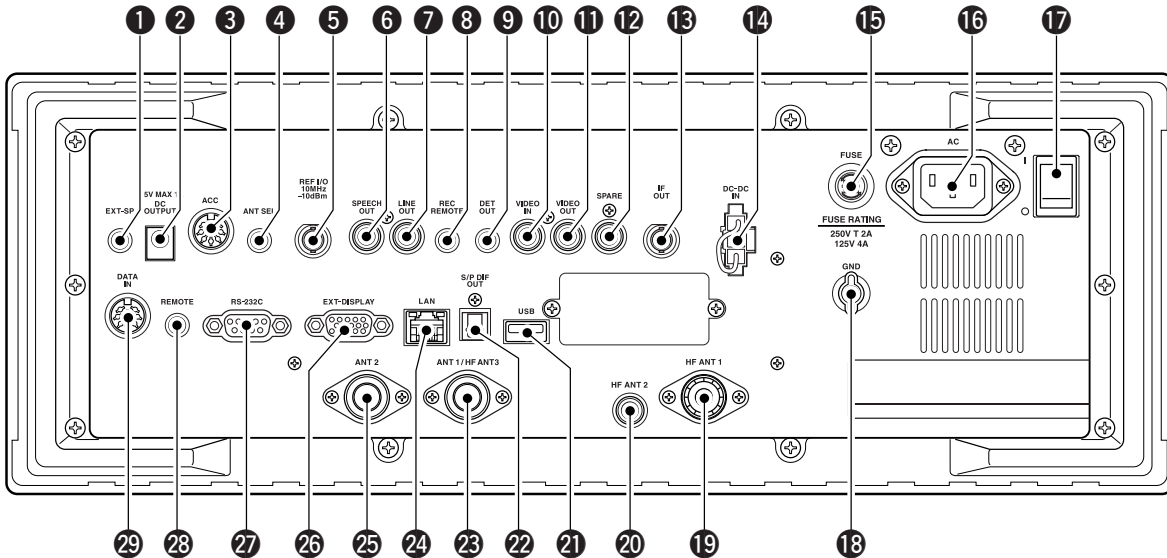

**1 EXTERNAL SPEAKER JACK [EXT-SP]** (p. 2-6)  
Connects an external speaker (4–8 Ω), if desired.

**2 DC OUTPUT JACK [DC OUTPUT]** (p. 2-6)  
Outputs regulated 15 V DC (approx.) for external equipment. Connected in parallel with 13.8 V outputs of [ACC]. (max. 1 A total)

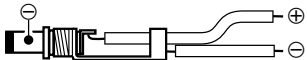

**3 ACCESSORY SOCKET [ACC]** (p. 2-6)  
Enables connection of external equipment such as an automatic antenna selector, a TNC for data communications, etc.  
• See p. 2-12 for socket information.

**4 ANTENNA SELECTOR VOLTAGE OUTPUT JACK [ANT SEL]**  
Outputs regulated 13.8 V DC (max. 100 mA) for external preamplifier or antenna selector, etc.

**5 REFERENCE SIGNAL INPUT/OUTPUT TERMINAL [REF I/O 10MHz–10dBm]**  
Inputs/outputs a 10 MHz reference signal.

**6 SPEECH OUTPUT JACK [SPEECH OUT]** (p. 2-9)  
Outputs an operating frequency, mode, S-meter indication and time with a synthesized voice when pushing [SPCH] or scan stopped.  
• Turn ON the “REC SPCH” in the others set mode to activate this jack when scan stopped. (p. 11-11)  
• Output level can be adjusted in ACC set mode. (p. 11-7)

**7 LINE OUTPUT JACK [LINE OUT]**  
Audio output jack for tape recorder. The fixed audio output level is set for a tape recorder AUX jack.

**8 RECORDER REMOTE JACK [REC REMOTE]**  
Controls the operation of a tape recorder for recording. Connects to the REMOTE jack on a tape recorder.

**9 DETECTOR OUTPUT JACK [DET OUT]**  
Outputs the detector output signal.

**10 VIDEO INPUT JACK [VIDEO IN]**  
Accepts video signals for display on the LCD monitor when the [DISPLAY] switch is ON.

**11 VIDEO OUTPUT JACK [VIDEO OUT]**  
Outputs video signals when TV frequencies with WFM mode are received. The NTSC M, PAL B/G, PAL I, PAL D and SECAM K system can be accepted.

**12 SPARE JACK [SPARE]** (p. 2-3)  
No connection.

**13 IF OUTPUT JACK [IF OUT]** (p. 2-3)  
Outputs a 10.7 MHz IF signal.  
Output level is the same level as an antenna input signal or below (when the AGC function is activated or attenuator is ON.)

**14 DC-DC POWER SOCKET [DC-DC IN]** (p. 2-6)  
Accepts a regulated 13.5 to 15 V DC input. This socket does not accept voltage from a non-regulated power source such as a vehicle’s battery.

- 15 FUSE HOLDER [FUSE]** (p. 12-8)  
Holds a 4 A fuse (100 V/120 V versions) or 2 A fuse (230 V/240 V versions) for internal AC power supply protection. Cuts off the AC input when over-current occurs.
- CAUTION:** Always use the correct fuse for AC input power. Using a fuse rated for a different input power may damage your house electrical system or the receiver.
- 16 AC POWER SOCKET [AC]** (p. 2-5)  
Connects the supplied AC power cable to an AC line-voltage receptacle.
- 17 MAIN POWER SWITCH [I/O]** (p. 3-2)  
Turns the internal power supply ON or OFF.
- 18 GROUND TERMINAL [GND]** (p. 2-2)  
Connect this terminal to a ground to prevent electrical shocks, TVI, BCI and other problems.
- 19 HF ANTENNA CONNECTOR 1 [HF ANT 1]** (p. 2-5)  
Accepts a 50  $\Omega$  antenna for HF bands with a PL-259 plug connector.
- 20 HF ANTENNA CONNECTOR 2 [HF ANT 2]** (p. 2-5)  
Accepts a 50  $\Omega$  antenna for HF band with an RCA connector.
- 21 USB CONNECTOR [USB]**  
Connects USB equipment such as a memory media, hub or keyboard.
- 22 S/P DIF OUTPUT TERMINAL [S/P DIF OUT]** (p. 2-7)  
Connects external equipment that supports S/P DIF output.
- 23 HF ANTENNA CONNECTOR 3/ANTENNA CONNECTOR 1 [ANT 1/HF ANT 3]** (p. 2-5)  
Accepts a 50  $\Omega$  antenna with a Type-N connector. Covers the HF bands and 30–1150 MHz frequency range.
- 24 ETHERNET CONNECTOR [LAN]** (pgs. 2-7, 15-6)  
Connects to a PC through a LAN (Local Area Network).
- 25 ANTENNA CONNECTOR 2 [ANT 2]** (p. 2-5)  
Accepts a 50  $\Omega$  antenna with a Type-N connector. Covers the 1150–3335 MHz frequency range.
- 26 EXTERNAL DISPLAY TERMINAL [EXT-DISPLAY]** (p. 2-10)  
Connects to an external display monitor.  
• At least 800×600 pixel display is necessary.
- 27 RS-232C TERMINAL [RS-232C]** (p. 2-6)  
Connects to a PC using a D-sub 9-pin RS-232C cable.  
Can be used for remote control of the IC-R9500 without the optional CT-17, or the FSK decoded signal output. The [RS-232C] interface is wired as a modem (DCE).
- 28 CI-V REMOTE CONTROL JACK [REMOTE]** (p. 2-6)  
➤ Connects a PC via the optional CT-17 CI-V LEVEL CONVERTER for external control of the receiver.  
➤ Used for transceive operation with another Icom CI-V transceiver or receiver.
- 29 DATA SOCKET [DATA IN]** (pgs. 2-10, 2-12)  
Outputs LCD monitor signals (NTSC system).

■ LCD display

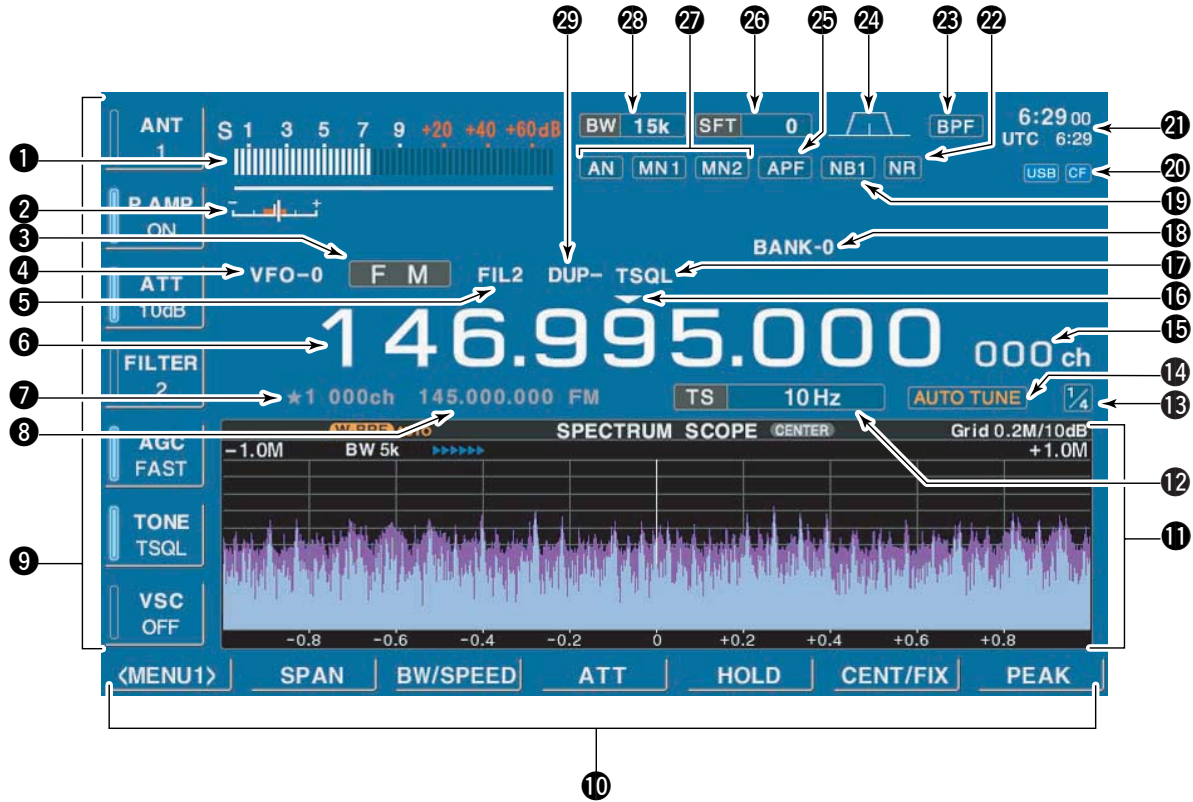

1 RSSI METER (p. 3-10)

Shows the received signal strength. Four meter types, S, dBμ, dBμ(EMF) and dBm meters are selectable.

- S-meter



- dBμ meter

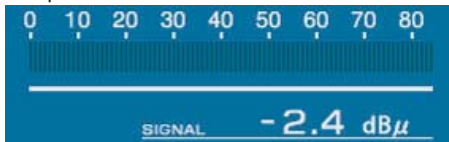

- dBμ (EMF) meter

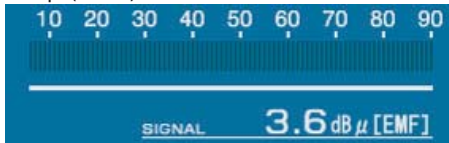

- dBm meter

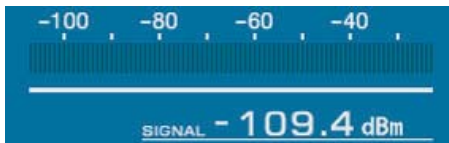

2 CENTER METER

Shows that the received signal is tuned to its center frequency for FM/WFM or FSK modes.

- FM/WFM modes
- FSK mode



3 MODE INDICATOR (p. 3-7)

Shows the selected receive mode.

4 VFO/MEMORY INDICATOR (pgs. 3-3, 7-3)

Indicates the selected VFO number (VFO-0 to VFO-9) or memory mode.

5 IF FILTER INDICATOR (p. 5-12)

Shows the selected IF filter number.

6 FREQUENCY READOUTS

Shows the operating frequency.

7 SELECT MEMORY CHANNEL INDICATOR (p. 8-12)

Indicates the displayed memory channel is set as a select memory channel.

8 MEMORY CHANNEL READOUTS

- ➔ Shows the selected memory channel contents in VFO mode.
- ➔ Shows the VFO contents in memory mode.

**9 MULTIFUNCTION SWITCH GUIDE**

Indicates the function of the multifunction switches.

**10 LCD FUNCTION SWITCH GUIDE**

Indicates the function of the LCD function switches ([F-1] – [F-7]).

**11 MULTIFUNCTION SCREEN**

Shows the screens for the spectrum scope, voice recorder, memory channel list, scan, FSK decoder, IF filter selection or set modes, etc.

**12 TUNING STEP INDICATOR** (p. 3-5)

Shows the selected tuning step.

**13 1/4 FUNCTION INDICATOR** (p. 3-6)

Appears when the 1/4-speed tuning function is activated in CW and FSK modes.

**14 AUTOMATIC TUNE INDICATOR** (p. 5-17)

“**AUTO TUNE**” blinks during automatic tuning. This feature is active in AM, SSB and CW mode.

**15 MEMORY CHANNEL INDICATOR** (p. 7-3)

Indicates the selected memory channel number.

**16 TUNING DIGIT INDICATOR** (p. 3-5)

Shows the tuneable digit when rotating the main dial.

**17 TONE/DTCS/NAC/SELECTIVE SQUELCH INDICATOR**

- “TSQL” or “DTCS” appears when the tone squelch or DTCS squelch is set in FM mode. (p. 4-4)
- “NAC” or “SEL” appears when the NAC squelch or selective squelch is selected in P25 mode. (Requires optional UT-122.) (p.4-19)

**18 BANK INDICATOR** (p. 7-3)

Appears when the bank limit function is in use and indicates the selected bank number.

- BANK-0 to BANK-9, BANK-A (AUTO MW), BANK-S (SKIP) and BANK-P (SCAN EDGE) are selectable.

**19 NOISE BLANKER INDICATOR** (p. 5-15)

“NB1” or “NB2” appears when either noise blanker 1 or noise blanker 2 is ON. This function is not available for FM/WFM or P25 mode.

**20 CF CARD/USB-MEMORY INDICATOR** (p. 11-16)

- “**CF**” appears when CF card is correctly connected and blinks while CF card is active.
  - This indicator is normally stayed ON.
- “**USB**” appears when USB equipment (USB-Memory or keyboard, etc) is connected, and blinks while it is active.

**21 CLOCK READOUT** (p. 10-2)

Shows the current time. Local and UTC time can indicate at the same time.

**22 NOISE REDUCTION INDICATOR** (p. 5-16)

Appears when noise reduction function is in use.

**23 BANDPASS FILTER INDICATOR**

Appears when the narrow filter (500 Hz or less) is selected during CW or FSK operation.

**24 PASSBAND WIDTH INDICATOR** (p. 5-11)

Graphically displays the passband width for twin PBT operation and center frequency for IF shift operation.

**25 AUDIO PEAK FILTER INDICATOR** (p. 4-10)

Appears when the audio peak filter function is in use. This function is available in CW mode

**26 SHIFT FREQUENCY INDICATOR** (p. 5-11)

Shows the shift frequency of the IF filter.

**27 NOTCH FILTER INDICATOR** (p. 5-16)

- “**AN**” appears when the auto notch function is in use. This function is available in FM, WFM, AM and SSB modes.
- “**MN1**” or “**MN2**” appears when the manual notch filter function is in use. This function is available in AM, SSB, CW and FSK mode.

**28 BAND WIDTH INDICATOR** (p. 5-11)

Shows the passband width of the IF filter.

**29 DUPLEX INDICATOR** (p. 4-3)

“DUP-” or “DUP+” appears when the negative duplex or positive duplex operation is selected, respectively.



# 1 PANEL DESCRIPTION

## ■ Screen menu arrangement

The following screens can be selected from the start up screen. Choose the desired screen using the following chart.

Pushing [EXIT/SET] several times returns to the start up screen. See p. 11-3 for set mode arrangement.

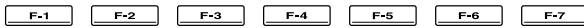

### • Spectrum scope screen (p. 5-2)

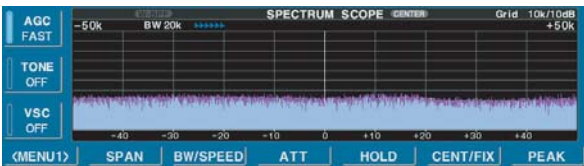

### • Voice recorder screen (p. 6-3)

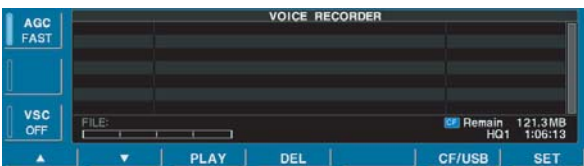

### • FSK decoder screen (p. 4-14)

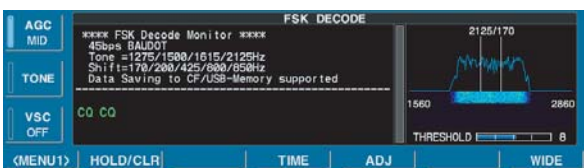

### • Memory channel screen (p. 7-4)

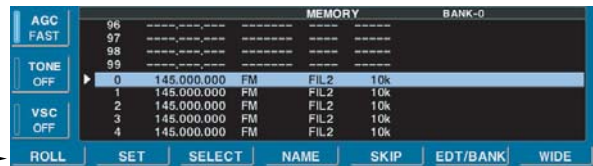

### • Scan screen (p. 5-5)

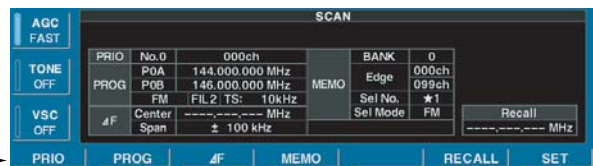

### • Set mode menu screen (p. 11-2)

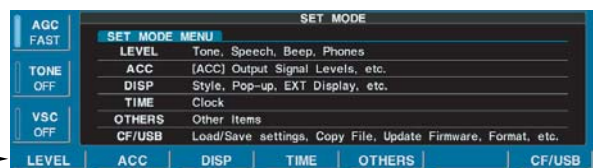

- Unpacking ..... 2-2
- Selecting a location ..... 2-2
- Grounding ..... 2-2
- Antenna connection ..... 2-3
- TV jumper cable connection ..... 2-4
- Carrying handle attachment ..... 2-4
- Rack mounting handle detachment ..... 2-4
- Required connections ..... 2-5
  - ◇ Rear panel ..... 2-5
- Advanced connections ..... 2-6
  - ◇ Front panel ..... 2-6
  - ◇ Rear panel—1 ..... 2-6
  - ◇ Rear panel—2 ..... 2-7
- Tape recorder connections ..... 2-8
  - ◇ Recording from the front panel or rear panel ..... 2-8
  - ◇ Separately recording audio and frequency ..... 2-9
- Monitor display connection ..... 2-10
- Transceive function ..... 2-10
- FSK and AFSK (SSTV) connections ..... 2-11
- Accessory connector information ..... 2-12

 **CAUTION!:** The receiver weighs approx. 20 kg (44 lb). Always have two people available to carry, lift or turn over the receiver.

## ■ Unpacking

After unpacking, immediately report any damage to the delivering carrier or dealer. Keep the shipping cartons.

For a description and a diagram of accessory equipment included with the IC-R9500, see 'Supplied accessories' on p. iii of this manual.

## ■ Selecting a location

Select a location for the receiver that allows adequate air circulation and access to the front and rear panels. Do not place in areas subject to extreme heat, cold, or vibrations, or near TV sets, radios and other electromagnetic sources.

## ■ Grounding

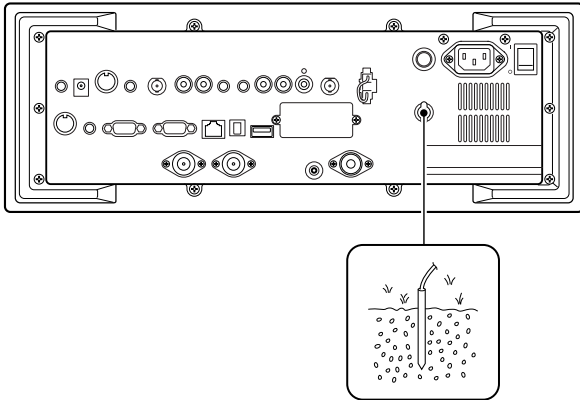

To prevent electrical shock, television interference (TVI), broadcast interference (BCI) and other problems, ground the receiver through the GROUND terminal on the rear panel.

For best results, connect a heavy gauge wire or strap to a long earth-sunk copper rod. Make the distance between the [GND] terminal and ground as short as possible.

**⚠ WARNING: NEVER** connect the [GND] terminal to a gas or electric pipe, since the connection could cause an explosion or electric shock.



## ■ Antenna connection

Your antenna plays a very important role in receiver operation. If the antenna is poor, your receiver cannot give you the best performance.

The IC-R9500 requires at least 2 antennas (ANT 1/HF ANT 3, ANT 2) for full coverage from 100 kHz to 3335 MHz. Select an antenna, such as a well matched 50 Ω antenna and feedline. When you wish to use a long wire antenna for short wave bands, use one as long as possible (at least 10 m, 32.8 ft).

**CAUTION:** Protect your receiver from lightning by using a lightning arrestor.

### PL-259 CONNECTOR INSTALLATION EXAMPLE

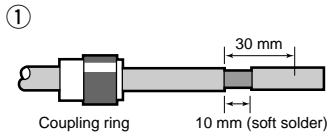

Slide the coupling ring down. Strip the cable jacket and tin the braid.

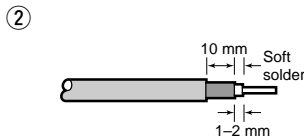

Strip the cable as shown at left. Tin the center conductor.

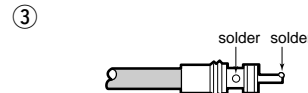

Slide the connector body on and solder it.

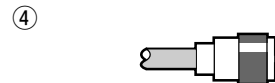

Screw the coupling ring onto the connector body.

30 mm <sup>1</sup>/<sub>8</sub> in 10 mm <sup>1</sup>/<sub>8</sub> in 1–2 mm <sup>1</sup>/<sub>16</sub> in

### TYPE-N CONNECTOR INSTALLATION EXAMPLE

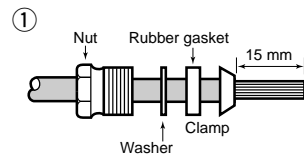

Slide the nut, washer, rubber gasket and clamp over the coaxial cable, then cut the end of the cable evenly.

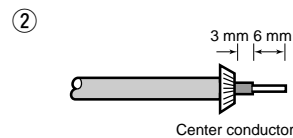

Strip the cable and fold the braid back over the clamp.

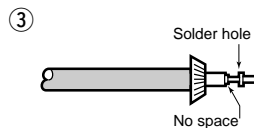

Tin the center conductor. Install the center conductor pin and solder it.

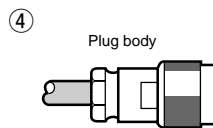

Carefully slide the plug body into place aligning the center conductor pin on the cable. Tighten the nut onto the plug body.  
 • Be sure the center pin is flush with the end of the plug body.

30 mm <sup>1</sup>/<sub>8</sub> in 10 mm <sup>1</sup>/<sub>8</sub> in 1–2 mm <sup>1</sup>/<sub>16</sub> in

### ■ TV jumper cable connection

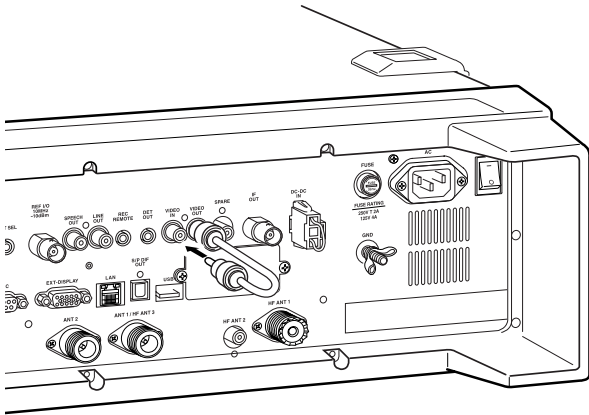

Connect the RCA cable between [VIDEO IN] and [VIDEO OUT].

When connecting external video equipment, connect the unit between [VIDEO IN] and [VIDEO OUT] connectors.

### ■ Carrying handle attachment

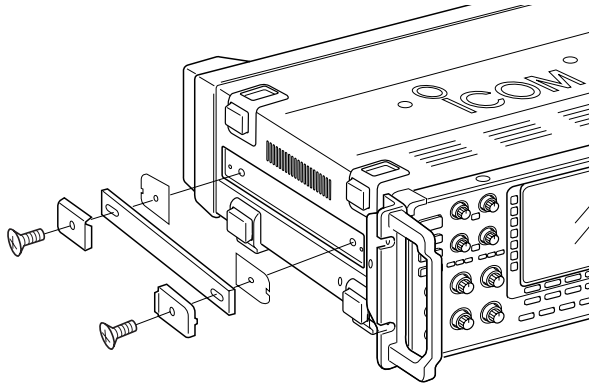

Attach the supplied Carrying handles as shown at left.

### ■ Rack mounting handle detachment

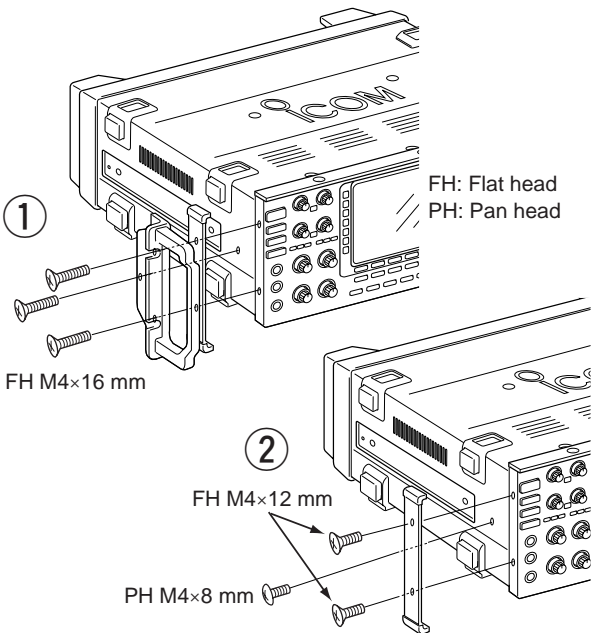

When removing the rack mounting handles, use the supplied screws for attach the side plates.

① Remove the 6 screws from the rack mounting handles from both side. And remove the rack mounting handles and side plates.

② Attach the removed side plates to original position, then tighten the supplied 4 screws (FH M4×12). Tighten the supplied 2 screw (PH M4×8) for hiding screw holes for both side.

**CAUTION: NEVER** replace the any other than specified screws for side plate attachment or hiding screw holes. If long screw is used, it is caused to damage the receiver's inside board.

## Required connections

### ◇ Rear panel

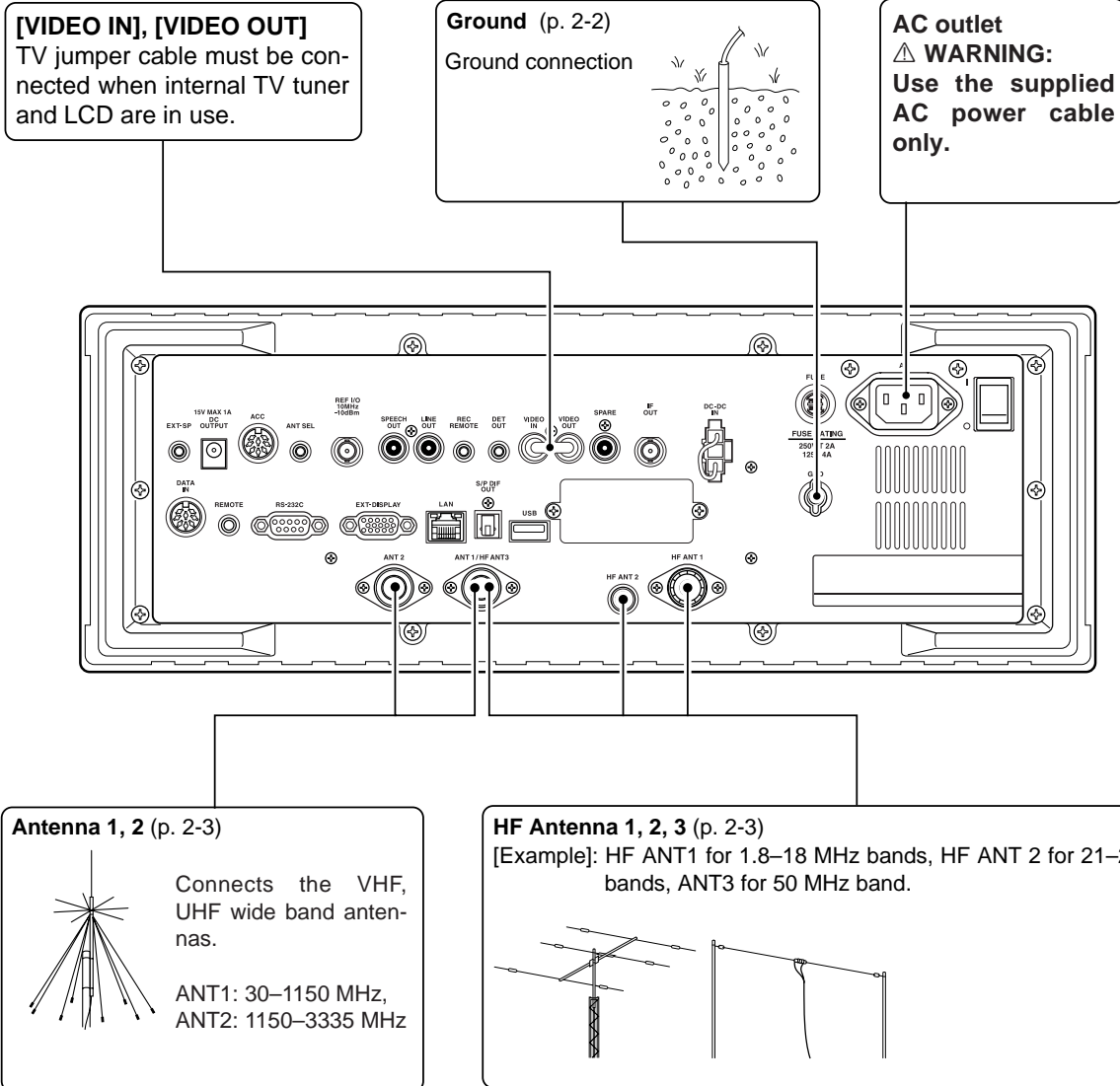

The optional AH-7000 is available for 25 MHz to 1.3 GHz coverage.

Select the active antenna connector. (p.9-3)

## Advanced connections

### Front panel

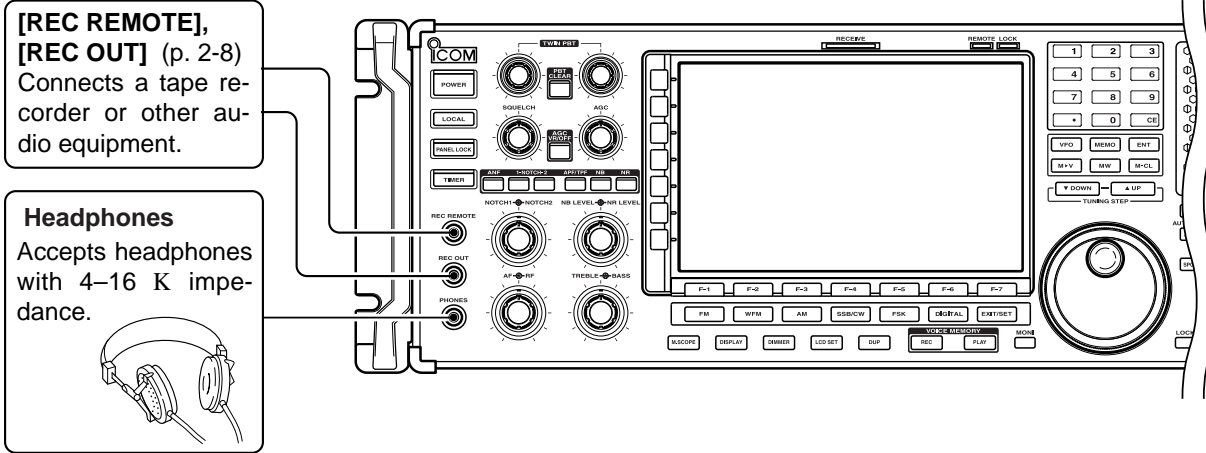

### Rear panel—1

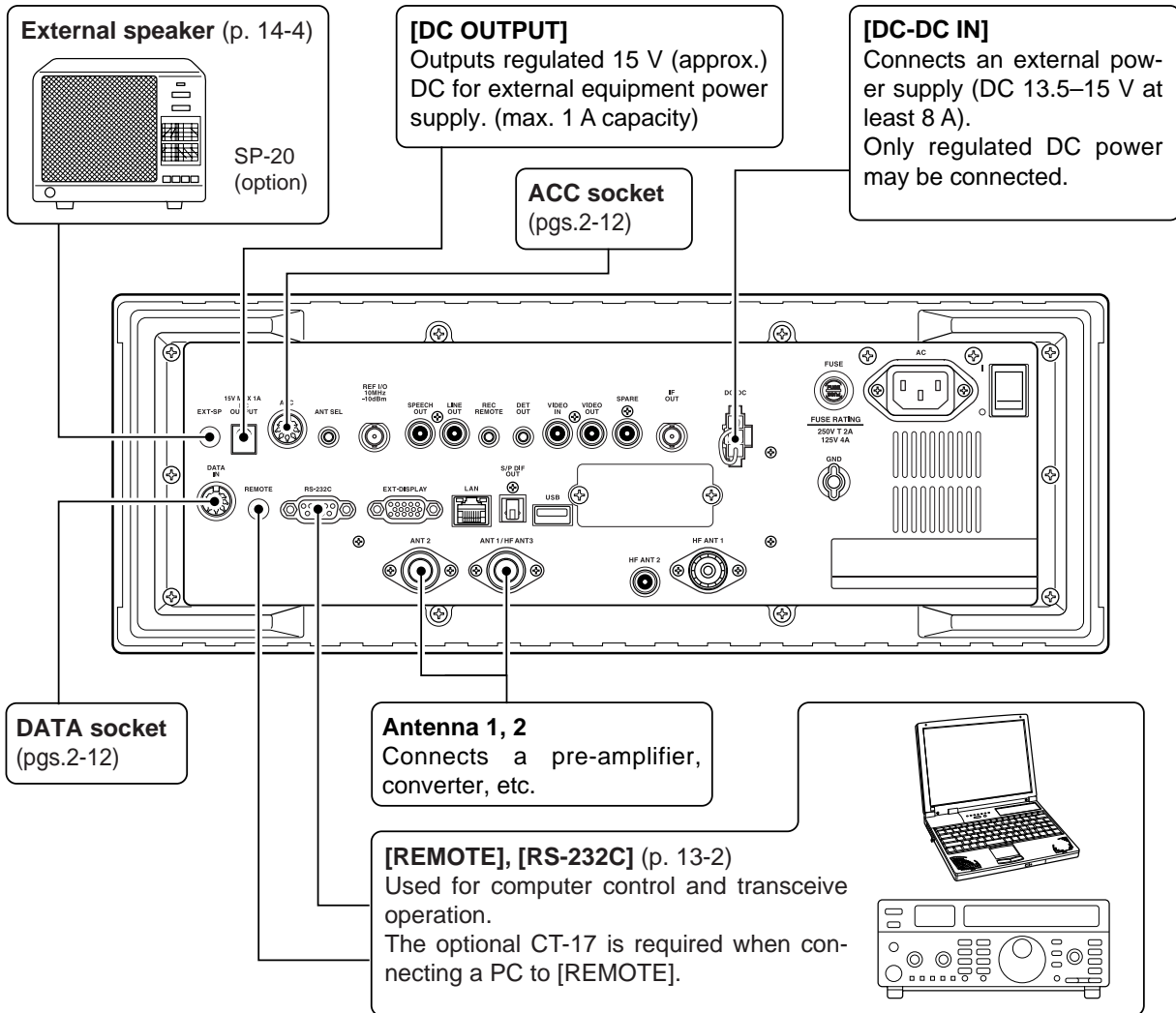

◇ Rear panel—2

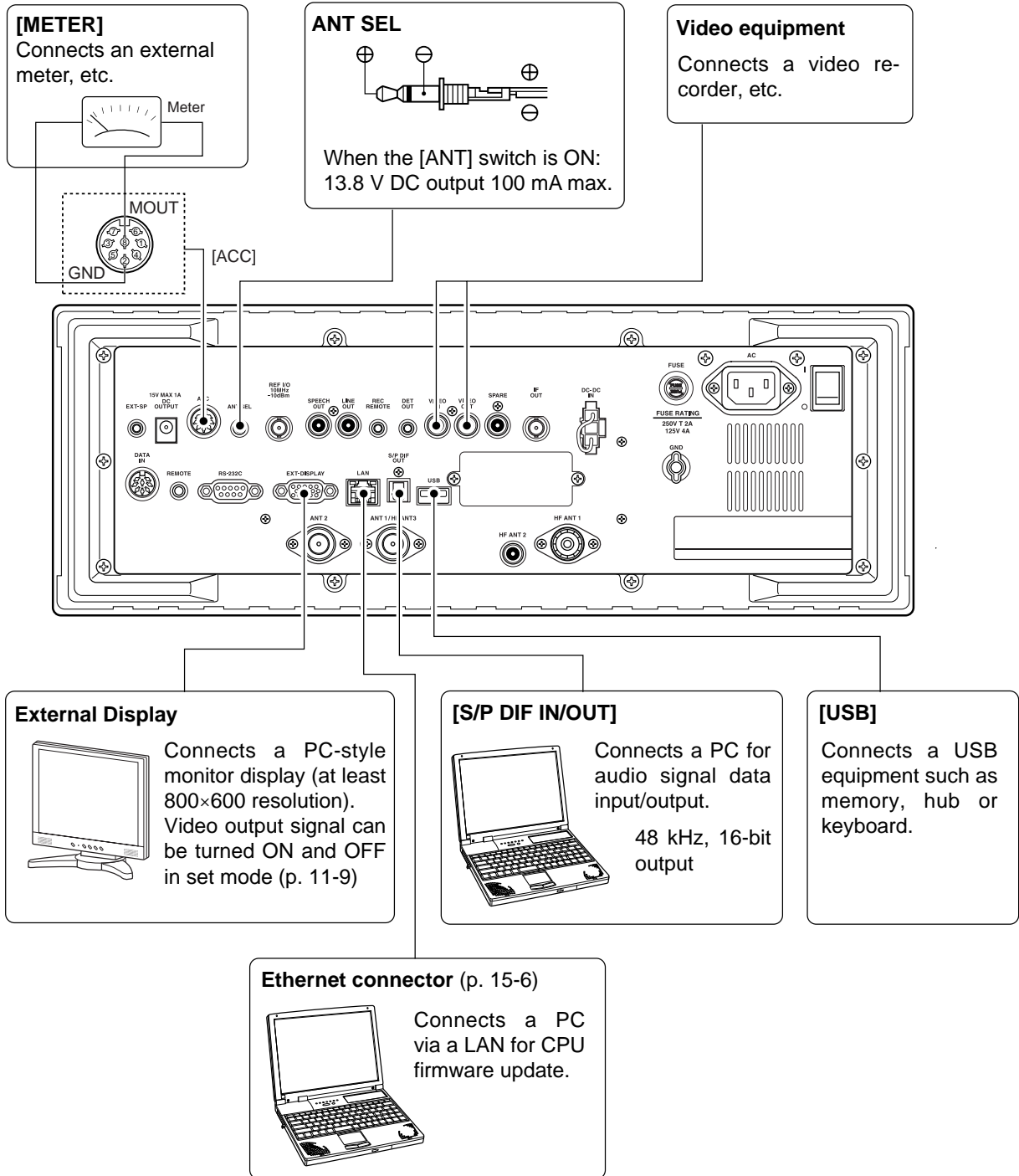

## ■ Tape recorder connections

The [REC REMOTE] jack is grounded when a signal is received and squelch opens. If a tape recorder has a control terminal, this jack can be used for recording control. (2 A/DC max.)

The [REC OUT] or [LINE OUT] jack has 350 mV rms/4.7 k $\Omega$  output for connection to other audio equipment.

### ◇ Recording from the front panel or rear panel

The [REC REMOTE] jack is grounded when a signal is received and squelch opens. If a tape recorder has a control terminal, this jack can be used for recording control. (2 A/DC max.)

The [REC OUT] or [LINE OUT] jack has 350 mV rms/4.7 k $\Omega$  output for connection to other audio equipment.

#### • Recording from the front panel

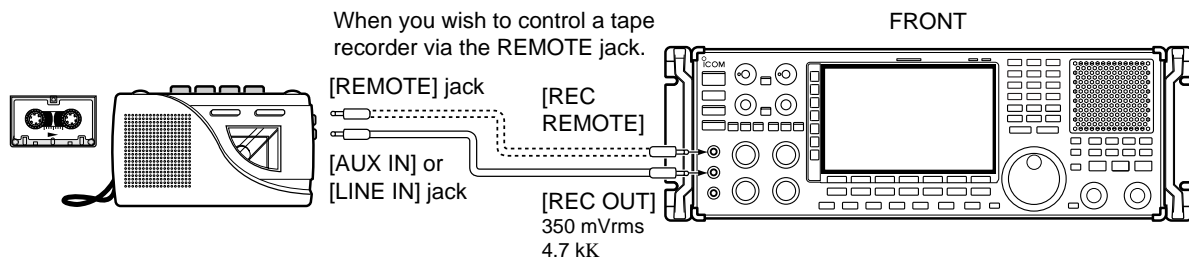

#### • Recording from the rear panel

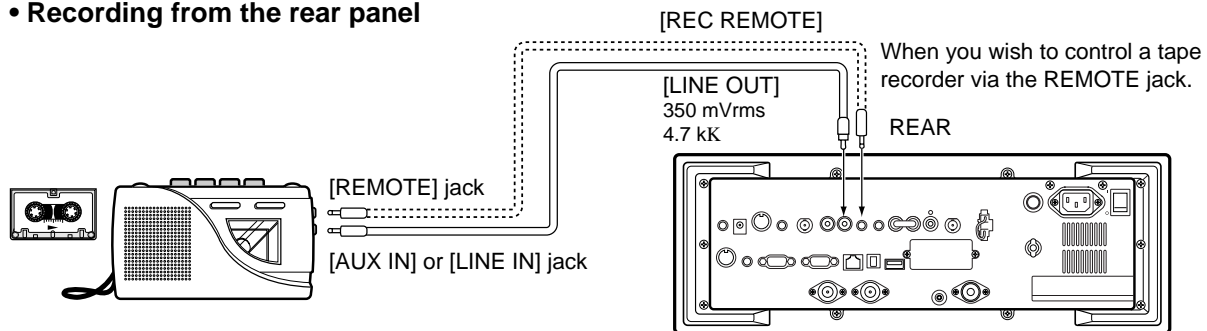

◆ Separately recording audio and frequency

When using a stereo tape recorder for recording, received audio and a frequency with a synthesized voice can be separately recorded.

When recording this way, you can search ahead of the audio signal recorded in the tape recorder using the frequency recording channel search.

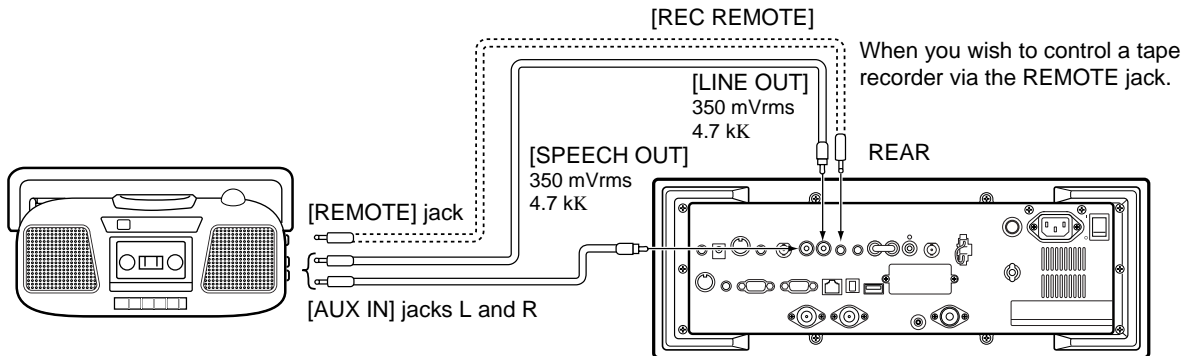

- Be sure the "REC SPEECH" item is turned ON, and "SPEECH Mix" item is select OFF in the others set mode (p. 11-11).

## ■ Monitor display connection

A monitor display can be connected to the IC-R9500 via the [DATA IN] socket and [EXT-DISPLAY]. You can monitor the LCD monitor information on a large size display.

**NOTE:** Video output from [DATA IN] is available an NTSC system only.

The IC-R9500 includes a picture signal decoder. When connecting a TV set equipped with a VIDEO IN jack, you can monitor TV signals such as amateur TV.

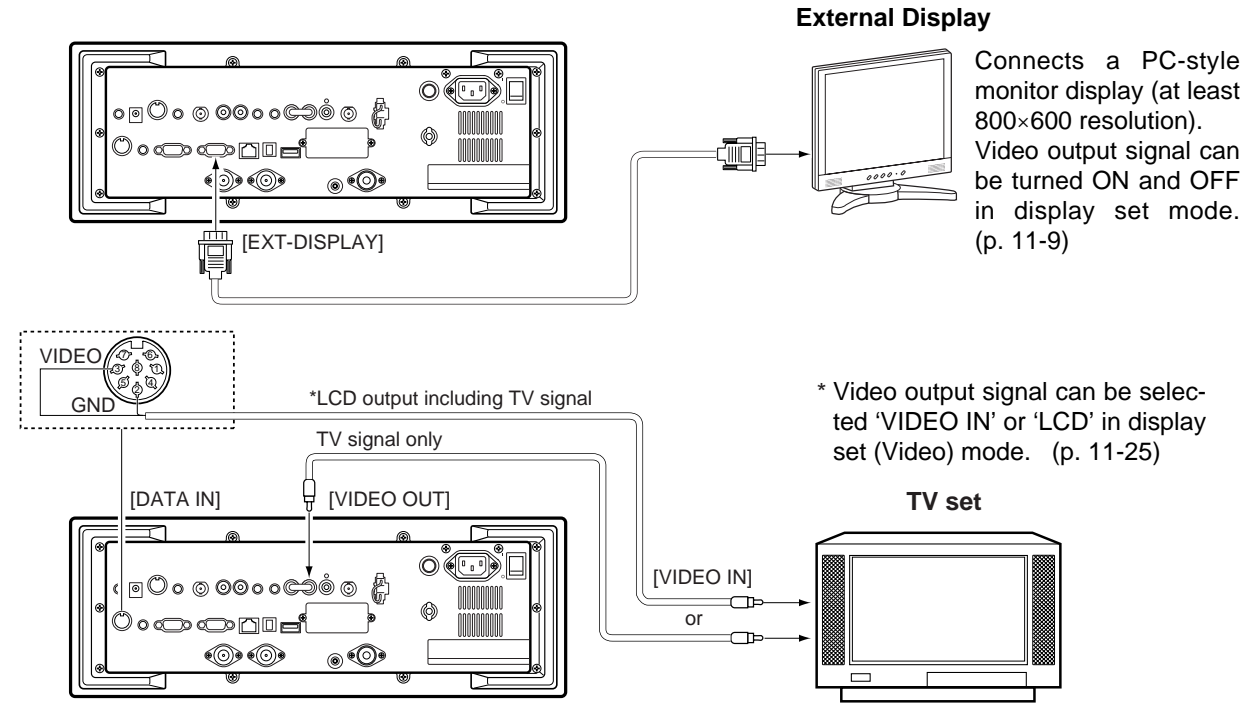

## ■ Transceive function

Icom CI-V transceivers or receivers can be connected via the [REMOTE] jack. The frequency and mode settings will follow\* when either radio is changed.

\* When a set frequency is out-of-range for one of the connected transceivers or receivers, the connected radio's frequency/mode does not change.

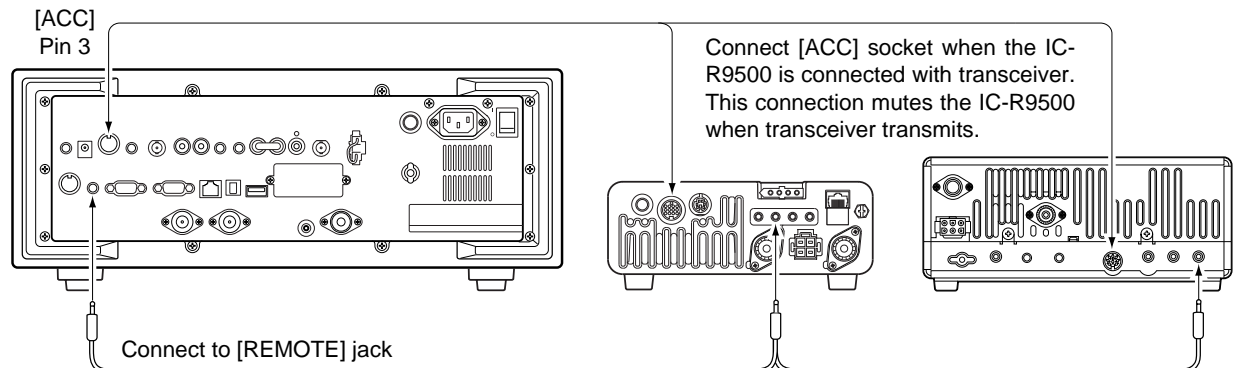

• Be sure the "CI-V Transceive" item is turned ON in the others set mode (p. 11-14).



## ■ FSK and AFSK (SSTV) connections

To connect a terminal unit, TNC or scan converter, refer to the diagram below.

- ① Connect a terminal unit as below.
- ② Select FSK mode (or USB, CW modes for HF band data communications).
- ③ Set the receiver to the desired frequency as shown to the right.
- ④ Set the connected terminal unit to the appropriate settings.
  - Refer to the terminal unit's instructions.

/// The narrow filter settings may not pass FSK signals. Be sure to select the appropriate IF filters corresponding to the signal width. (p. 5-12)

• **Frequency settings depend on the mode used.**

FM mode:

$$[\text{Setting frequency (displayed freq.)}] = [\text{Desired freq.}]$$

USB mode:

$$[\text{Setting frequency (displayed freq.)}] = [\text{Desired freq.}] - [\text{Center of Mark and Space freq.}]$$

CW narrow mode:

$$[\text{Setting frequency (displayed freq.)}] = [\text{Desired freq.}] - [\text{Center of Mark and Space freq.}] + [600 \text{ Hz}]$$

LSB mode (for amateur RTTY):

$$[\text{Setting frequency (displayed freq.)}] = [\text{Desired freq.}] + [\text{Mark freq.}]$$

• **When using a PC application**

Rear panel view

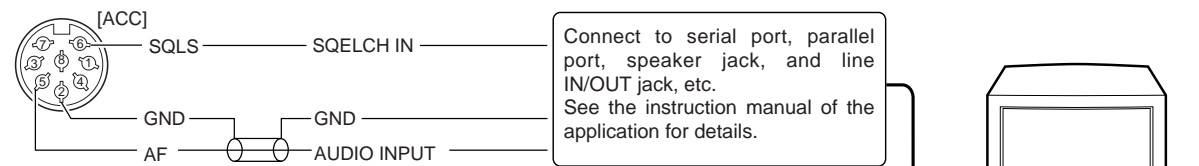

• **When using a TNC**

Rear panel view

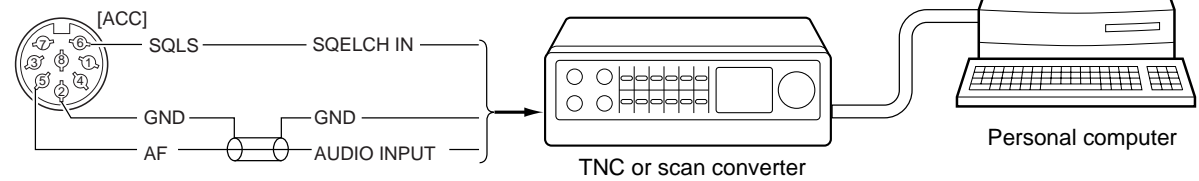

## ■ Accessory connector information

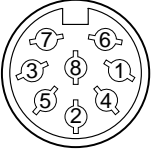
ACC	PIN No.	NAME	DESCRIPTION	SPECIFICATIONS
	1	ANTS	Outputs 5 V when the [ANTENNA] switch is ON.	Output current : Less than 100 $\mu$ A Output impedance : 10 k $\Omega$
	2	GND	Connects to ground.	
	3	SEND	When grounded, attenuator activates and then audio is muted.	GROUND level : -0.5 to +0.8 V Input current : Less than 20 mA
	4	NC	No connection	
	5	AF	AF detector output. Fixed, regardless of [AF] position in default settings. (see notes below)	Output impedance : 47 k $\Omega$ Output level : 100–300 mV rms
	6	SQLS	Squelch output. Goes to ground when squelch opens.	Squelch open : Less than 0.3 V/5 mA Squelch closed : More than 6.0 V/100 $\mu$ A
	7	13.8 V	13.8 V output when power is ON.	Output current : 100 mA
	8	MOUT	Output S-meter level.	Output voltage : 0 to approx. 4 V Output impedance : 10 k $\Omega$

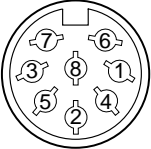
DATA IN	PIN No.	NAME	DESCRIPTION	SPECIFICATIONS
	1	DATA IN	—	
	2	GND	Connects to video ground.	
	3	VIDEO	Video signal output. (NTSC system only)	Output level : 1 V p-p $\pm$ 0.2 V Output impedance : 75 $\Omega$
	4	GND	—	
	5	NC	No connection	
	6	DATA OUT	—	
	7, 8	NC	No connection	

**NOTE:** If the beep level limit is in use, the beep tone decreases from the fixed level when the [AF] control is rotated above a specified level. (p. 11-6)

■ When first applying power (CPU resetting) .....	3-2
■ Initial settings .....	3-2
■ Selecting VFO mode .....	3-3
■ Selecting memory mode .....	3-3
■ Frequency setting .....	3-4
◇ Direct frequency entry with the keypad .....	3-4
◇ Tuning with the main dial .....	3-5
◇ Selecting a tuning step .....	3-5
◇ Auto tuning step function .....	3-6
◇ 1/4 tuning step function .....	3-6
■ Operating mode selection .....	3-7
■ Volume setting .....	3-8
■ RF gain adjustment .....	3-8
■ Squelch level adjustment .....	3-8
■ Audio tone adjustment .....	3-9
◇ Treble level adjustment .....	3-9
◇ Bass level adjustment .....	3-9
■ Meter indication selection .....	3-10
◇ Meter type selection .....	3-10

## ■ When first applying power (CPU resetting)

Before first applying power, make sure all connections required for your system are complete by referring to Section 2. Then, reset the receiver using the following procedure.

Resetting **CLEARs** all programmed contents in memory channels and returns programmed values in set mode to default values.

- ① Turn the main power ON with [I/O] on the rear panel.
  - The receiver power is still OFF and the [POWER] indicator lights orange.
- ② While pushing and holding [CE] and [M-CL], push [POWER] to turn power ON.
  - The CPU is reset.
  - The CPU start-up takes approx. 5 sec.
  - The receiver displays its initial VFO frequencies when resetting is complete.
- ③ Change the set mode settings after resetting, if desired.

In cooler temperatures, the LCD may appear dark and unstable after turning power ON. This is normal and does not indicate any equipment malfunction.

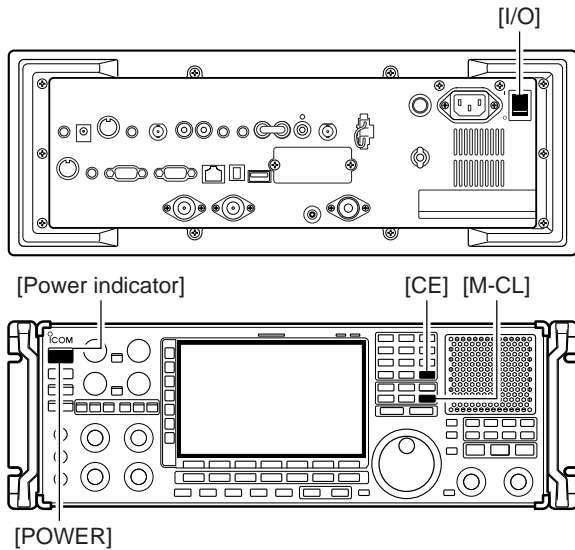

## ■ Initial settings

After resetting the receiver, set controls as shown in the figure below.

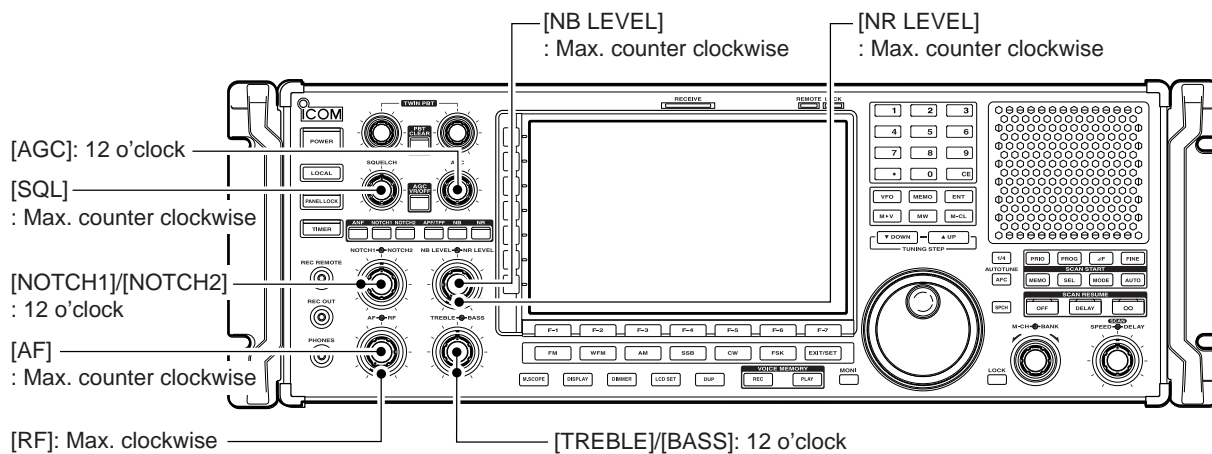

## ■ Selecting VFO mode

VFO is an abbreviation of Variable Frequency Oscillator, and is commonly referred to as a main tuning function. Frequency, mode and other receiver settings are stored as a set of VFO data.

The main dial is often called the “VFO knob.”

The IC-R9500 stores ten sets of VFO data. You can use the desired VFO to call up a frequency and operating mode for operation.

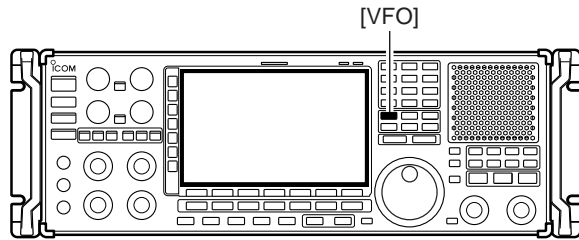

- Push [VFO] to select (last selected) VFO mode.
  - One of “VFO-0” to “VFO-9” appears when in VFO mode.
- Push the desired VFO number (0 to 9) using the keypad, then push [VFO] to select the desired VFO mode.
  - One of “VFO-0” to “VFO-9” appears when in VFO mode.

## ■ Selecting memory mode

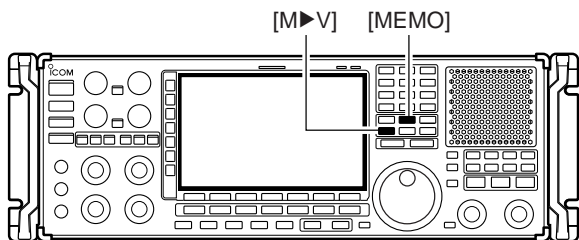

- Push [MEMO] to select memory mode.
  - The memory indicator appears when in memory mode.
  - Pushing and holding [M>V] for 1 sec. transfers the contents of the selected memory channel to VFO\*. (p. 7-5)
  - \*Only last selected VFO (VFO-0 to VFO-9) is overwritten.

## Frequency setting

There are two ways to set a frequency: with the main dial or keypad. Use both in combination for quick tuning.

- If the panel lock function is activated, the panel lock indicator lights, and any switches, keys and controls do not function. In this case, push [PANEL LOCK] to deactivate the panel lock function. (see p. 9-2 for details)
- The dial lock function also locks the main dial. To deactivate the dial lock function, push [LOCK].

### Direct frequency entry with the keypad

The receiver has a keypad for direct frequency entry as described below.

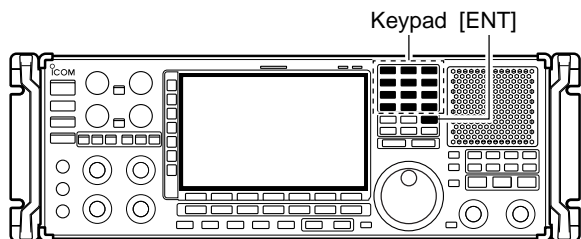

- ① Input the desired frequency.
  - Push [•] to input “. (decimal point)” between the MHz units and kHz units.
- ② Push [ENT] to set the input frequency.
  - To cancel the input, push [CE] instead of [ENT].

#### [EXAMPLE]

145.000000 MHz

Push



1296.24000 MHz

Push



1296.24000 MHz ≅ 1296.36000 MHz

Push



850 kHz (0.85 MHz)

Push



◇ Tuning with the main dial

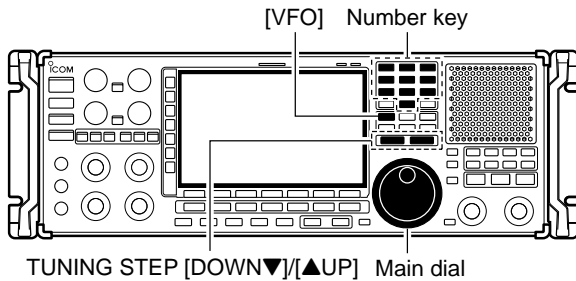

Rotate the main dial to change the frequency.  
 • The frequency changes in increments determined by the selected tuning step (see below).

- ① Push the desired VFO number (0 to 9) and [VFO].  
 • 10 different sets of VFO data can be selected.
- ② Select the desired operating mode. (p.3-7)  
 • 10 different sets of VFO data can be selected.
- ③ Push [▲UP] or [▼DOWN] to select the desired tuning step.  
 • Selectable tuning steps can be changed for each operating mode as shown below.
- ④ Rotate the main dial to set the desired frequency.

◇ Selecting a tuning step

14 preset tuning steps plus 1 programmable tuning step are available. As a default setting, selectable tuning steps can be programmed, depending on the operating mode. Selectable tuning steps can be changed in TS select screen.

• Selecting selectable tuning steps

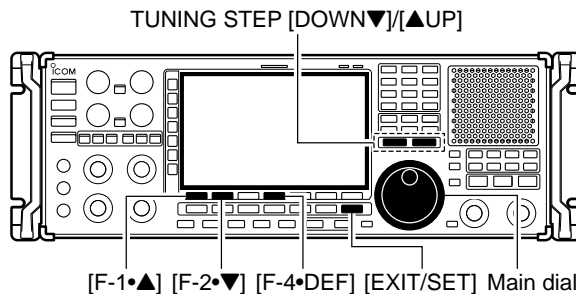

		TS SELECT	
AGC	FM	1Hz	ON
FAST	FM	10Hz	ON
	FM	100Hz	ON
TO	FM	1kHz	ON
NE	FM	2.5kHz	ON
	FM	5kHz	ON
V	FM	6.25kHz	ON
S	FM	9kHz	ON
OFF			

- ① Push and hold [▲UP] or [▼DOWN] for 1 sec. to enter the TS select screen to set the selectable tuning steps for each operating mode.
- ② Select the desired operating mode. (p.3-7)
- ③ Push [F-1 ▲] or [F-2 ▼] to select the desired tuning step.  
 • 1 Hz, 10 Hz, 100 Hz, 1 kHz, 2.5 kHz, 5 kHz, 6.25 kHz, 9 kHz, 10 kHz, 12.5 kHz, 20 kHz, 25 kHz, 100 kHz, 1 MHz and programmable are selectable.
- ④ Rotate the main dial to set the tuning step as the selectable tuning step if desired.  
 • Push and hold [F-4•DEF] for 1 sec. to select the default setting.
- ⑤ Repeat steps ③ to ④ to choose the selectable tuning steps.
- ⑥ Repeat steps ② to ④ to set the selectable tuning steps for each operating mode.
- ⑦ Push [EXIT/SET] (or [▲UP]/[▼DOWN]) to exit the TS select screen.

**Default settings**

- FM : All ON
- WFM : 20 k, 25 k, 100 k, 1 M, ProgTS
- AM : 1 k, 5k, 9 k, 10 k, 1 MHz
- SSB : 1, 10, 1 k, 1 MHz
- CW : 1, 10, 1 k, 1 MHz
- FSK : 1, 10, 1 k, 1 MHz
- P25 : 1 k, 2.5 k, 5 k, 6.25 k, 10 k, 12.5 k, 20 k, 25 k, 100 k, 1 MHz

### 3 BASIC OPERATIONS

#### • Setting the programmable tuning step

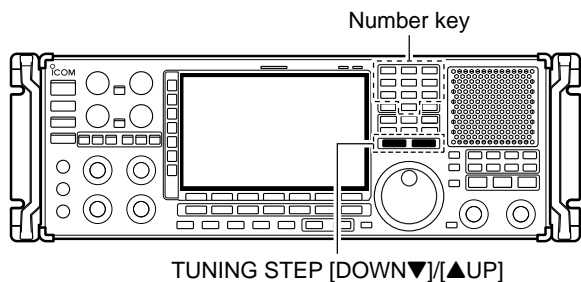

- ① Push the numeral keys on the keypad that correspond to the tuning step you wish to program.
  - Programmable tuning steps can be set between 0.1 and 999.9 kHz in 0.1 kHz steps.
  - ➡ To set programmable tuning steps, enter the desired steps via the keypad, then push [▲UP] or [▼DOWN].
- ② Push [▲UP] or [▼DOWN] to set the programmable tuning step.
  - Programmable tuning step is automatically selected as the active tuning step.

#### ◇ Auto tuning step function

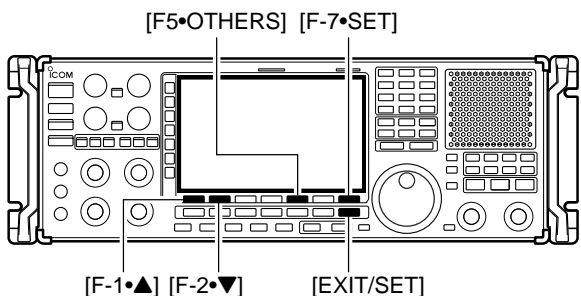

When rotating the main dial rapidly, the tuning speed accelerates automatically.

- ① Push [EXIT/SET] several times to close a multi-function screen, if necessary.
- ② Push [F-7•SET] to select set mode menu screen.
  - Pushing and holding [EXIT/SET] for 1 sec. also selects set mode menu screen.
- ③ Push [F-5•OTHERS] to enter the others set mode.
- ④ Push [F-1•▲] or [F-2•▼] to select "MAIN DIAL Auto TS."
- ⑤ Rotate main dial to select the desired condition from HIGH, LOW or OFF.
- ⑥ Push [EXIT/SET] to exit the set mode.
  - HIGH: Approx. 5 times faster
  - LOW: Approx. twice faster
  - OFF : Auto tuning step is turned OFF.

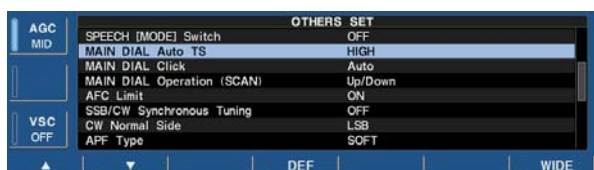

#### ◇ 1/4 tuning step function

When operating in CW or FSK, the 1/4 tuning function is available. Dial rotation is reduced to 1/4 of normal speed when the 1/4 tuning function is ON for finer tuning control.

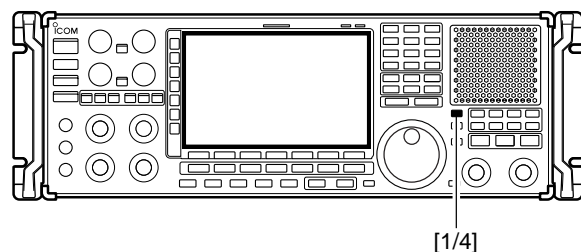

- ➡ Push [1/4] to toggle the 1/4 tuning function ON or OFF.
  - "1/4" appears when the 1/4 tuning function is ON.



## ■ Operating mode selection

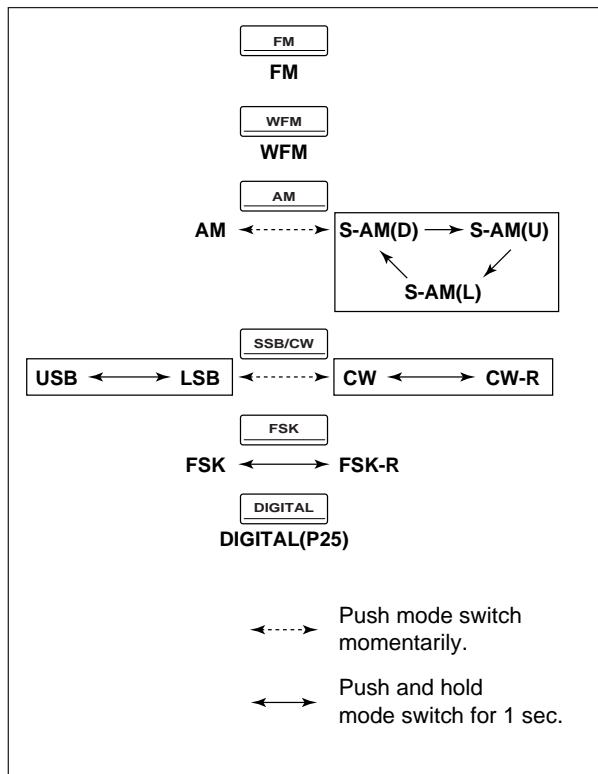
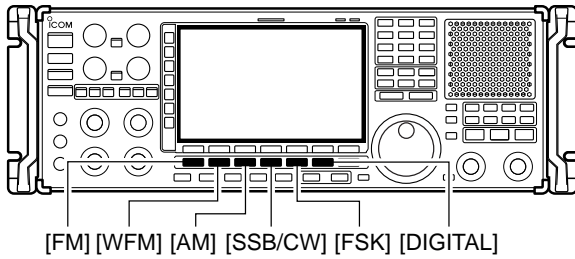

FM, WFM, AM, Synchronous-AM (S-AM(D)/S-AM(U)/S-AM(L)), SSB (USB/LSB), CW, CW reverse (CW-R), FSK, FSK reverse (FSK-R) and DIGITAL (P25\*) modes are available in the IC-R9500. Select the desired operation mode as follows. \* P25 requires optional UT-122.

To select a mode of operation, push the desired mode switch momentarily. Push the switch again to toggle between AM and S-AM(D)/S-AM(U)/S-AM(L), USB/LSB and CW/CW-R, if desired. Push and hold the switch for 1 sec. to toggle between S-AM(D), S-AM(U) and S-AM(L), USB and LSB, CW and CW-R, FSK and FSK-R, if desired.

See the diagram below left for the order of selection.

### • Selecting FM mode

➔ Push [FM] to select FM.

### • Selecting WFM mode

➔ Push [WFM] to select WFM.

### • Selecting AM mode

➔ Push [AM] to select AM or S-AM.

- After AM or S-AM is selected, push [AM] to toggle between AM and S-AM.

- After S-AM is selected, push and hold [AM] for 1 sec. to toggle between S-AM(DSB), S-AM(USB) and S-AM(LSB).

### • Selecting SSB/CW mode

➔ Push [SSB/CW] to select SSB or CW.

- After SSB or CW is selected, push [SSB/CW] to toggle between SSB and CW.

- After SSB or CW is selected, push [SSB/CW] for 1 sec. to toggle between USB and LSB, or, CW and CW reverse mode, respectively.

### • Selecting FSK mode

➔ Push [FSK] to select FSK.

- After FSK is selected, push [FSK] to toggle between FSK and FSK reverse mode.

### • Selecting DIGITAL mode (Requires optional U-122)

➔ Push [DIGITAL] to select digital (P25) mode.

### ■ Volume setting

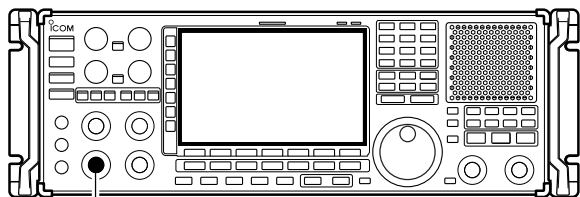

[AF]

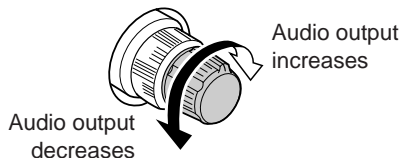

- ➔ Rotate [AF] control clockwise to increase, counterclockwise to decrease the audio output level.
  - Set a suitable audio level.

### ■ RF gain adjustment

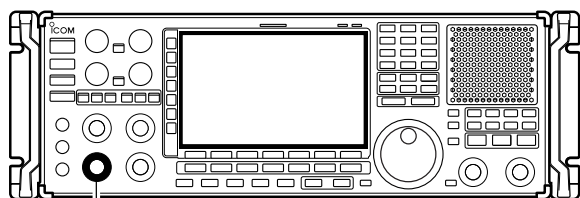

[RF]

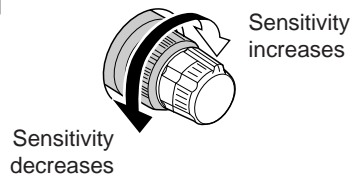

- ➔ Rotate [RF] control clockwise to increase, counterclockwise to decrease the receiver sensitivity.

- NOTE:**
- When [RF] control is adjusted CCW in FM mode, audio output decreases then disappears. This is normal, not a malfunction.
  - When WFM mode is selected, RF gain is fixed MAX regardless of any [RF] control settings.

### ■ Squelch level adjustment

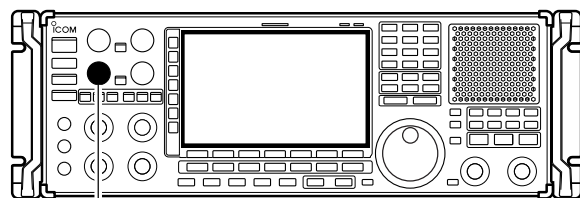

[SQUELCH]

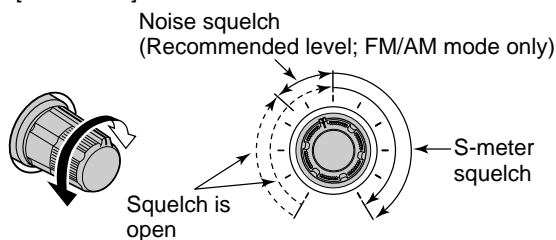

The squelch disables output from the speaker (closed position) when no signal is received.

- ➔ When no signal is received, rotate [SQUELCH] control fully counterclockwise first, then rotate [SQUELCH] clockwise to the point that the noise just disappears.
  - Push and hold [MONI] to open the squelch temporarily.

## ■ Audio tone adjustment

### ◇ Treble level adjustment

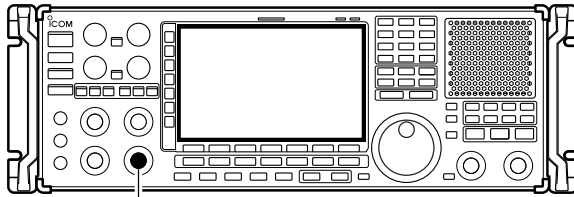

[TREBLE]

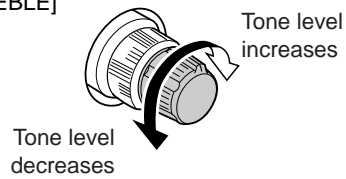

- ➔ Rotate [TREBLE] control clockwise to increase, counterclockwise to decrease the treble level of the audio tone.

### ◇ Bass level adjustment

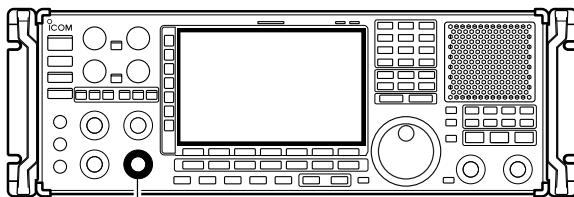

[BASS]

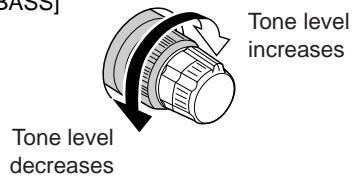

- ➔ Rotate [BASS] control clockwise to increase, counterclockwise to decrease the bass level of the audio tone.

## ■ Meter indication selection

### ◇ Meter type selection

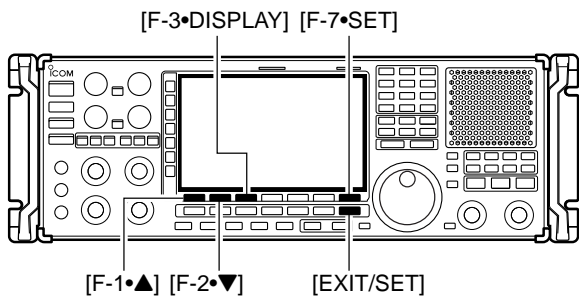

A total of 4 meter types are available in the IC-R9500— S-meter,  $\text{dB}\mu$ ,  $\text{dB}\mu(\text{EMF})$  and  $\text{dBm}$  meters. Follow the instructions below for the meter type selection.

- ① Push [EXIT/SET] several times to return to normal screen, if necessary.
- ② Push [F-7•SET], then push [F-3•DISPLAY] to select the display set mode.
- ③ Push [F-1•▲] or [F-2•▼] to select “Signal Meter” item.
- ④ Rotate main dial to select the desired meter type from “S,” “ $\text{dB}\mu$ ,” “ $\text{dB}\mu(\text{EMF})$ ” and “ $\text{dBm}$ .”
- ⑤ Push [EXIT/SET] to exit the display set mode.

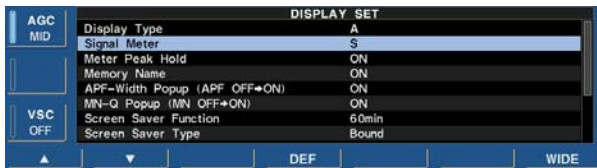

#### • S meter



#### • $\text{dB}\mu$ meter

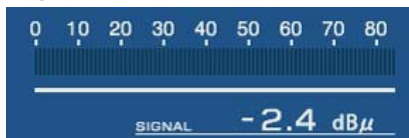

#### • $\text{dB}\mu(\text{EMF})$ meter

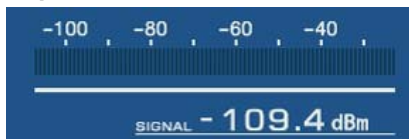

#### • $\text{dBm}$ meter

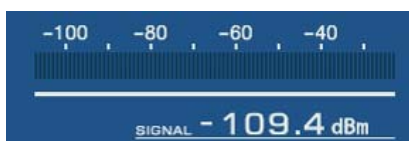

#### Signal meter squelch indicator



↑ Appears

“▲” indicates the signal meter squelch level and appears while [SQUELCH] control is rotating.

---

■ Operating FM .....	4-2
◇ Convenient functions for FM .....	4-2
■ Duplex operation .....	4-3
◇ Offset frequency setting .....	4-3
■ Tone/DTCS squelch operation .....	4-4
■ Operating WFM .....	4-5
◇ Convenient functions for WFM .....	4-5
■ TV channel operation .....	4-6
◇ Convenient functions for TV operation .....	4-6
■ Operating AM .....	4-7
◇ Convenient functions for AM .....	4-7
■ Operating SSB .....	4-8
◇ Convenient functions for SSB .....	4-8
■ Operating CW .....	4-9
◇ Convenient functions for CW .....	4-9
◇ APF (Audio Peak Filter) operation .....	4-10
◇ About CW reverse mode .....	4-10
◇ About CW pitch control .....	4-10
■ Operating FSK .....	4-11
◇ Convenient functions for FSK .....	4-12
◇ About FSK reverse mode .....	4-12
◇ Twin peak filter .....	4-12
◇ Functions for the FSK decoder indication .....	4-13
◇ Setting the decoder threshold level .....	4-13
◇ FSK decode set mode .....	4-14
◇ Time stamp function .....	4-15
◇ Setting FSK tone frequency .....	4-16
◇ Setting FSK Baud rate .....	4-16
◇ Data saving .....	4-17
■ Operating P25 (Requires optional UT-122) .....	4-18
◇ Convenient functions for P25 .....	4-18
■ Digital squelch operation .....	4-19

## ■ Operating FM

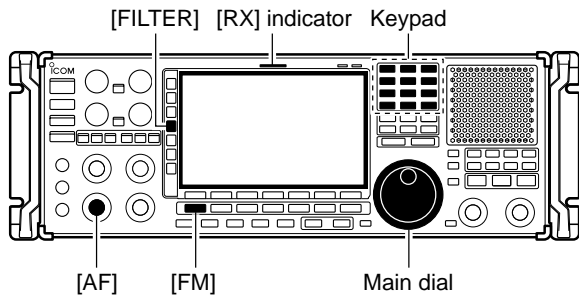

- ① Edit the desired frequency using the keypad.
- ② Push [FM] to select FM.
  - “FM” indicator appears.
- ③ Rotate the main dial to tune the desired frequency.
  - [RX] indicator lights green and the S-meter indicates received signal strength when signal is received.
  - 10 kHz tuning step is preset for the FM mode.
  - Push [FILTER] several times to select the desired filter width.
- ④ Rotate [AF] to set audio to a comfortable listening level.

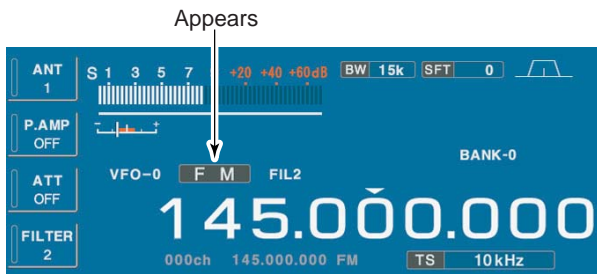

### ◇ Convenient functions for FM

- **Preamp** (p. 5-9)
  - ➔ Push [P.AMP] several times to set the preamp OFF, preamp 1 ON or preamp 2 ON. Only ON/OFF is available above 30 MHz.
    - “P.AMP1” or “P.AMP2” appears when the preamp 1 or preamp 2 is ON below 30 MHz. “P.AMP ON” appears above 30 MHz.
- **Attenuator** (p. 5-9)
  - ➔ Push [ATT] several times to set the attenuator in 6 dB steps for HF bands, or 10 dB step for 30–1150 MHz. Only 20 dB is available for 1150–3335 MHz.
    - “ATT” and attenuation level appear when the attenuator is ON.
- **Auto notch filter** (p. 5-16)
  - ➔ Push [NOTCH] switch to turn the auto notch function ON or OFF.
    - Notch indicator (above [NOTCH] switch) lights when either the manual notch is ON.
- **VSC (voice squelch control)** (p. 8-3)
  - ➔ Push [VSC] to turn the VSC function ON or OFF.
    - The VSC indicator appears when the voice squelch function is set to ON.
- **AFC (Auto Frequency Control)** (p. 5-17)
  - ➔ Push [AFC] to turn the AFC function ON or OFF.
    - The AFC indicator appears when the AFC function is set to ON.

## ■ Duplex operation

Duplex operation uses two different frequencies for transmitting and receiving. Generally, duplex is used in communication through a repeater, some utility communications, etc.

During repeater operation, the transmit station frequency is shifted from the receive station frequency by the offset frequency. Repeater information (offset frequency and shift direction) can be programmed into memory channels.

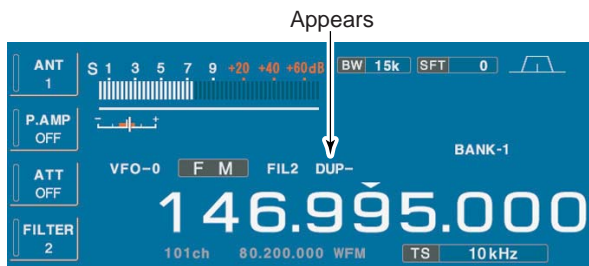
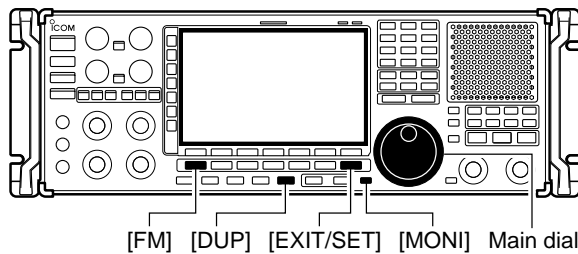

- ① Edit the desired receive frequency (repeater output frequency) using the keypad.
- ② Push [FM] to select FM.
  - "FM" indicator appears.
- ③ Push [DUP] several times to select the duplex direction.
  - "DUP-" or "DUP+" appears on the LCD.
- ④ Push and hold [DUP] for 1 sec. to enter the offset frequency setting screen, then rotate the main dial to set the desired offset frequency or edit the desired offset frequency directly with the keypad.
- ⑤ Push and hold [MONI] to monitor the transmit station frequency (repeater input frequency) directly.
- ⑥ To return to simplex, push [DUP] once or twice.

## ◇ Offset frequency setting

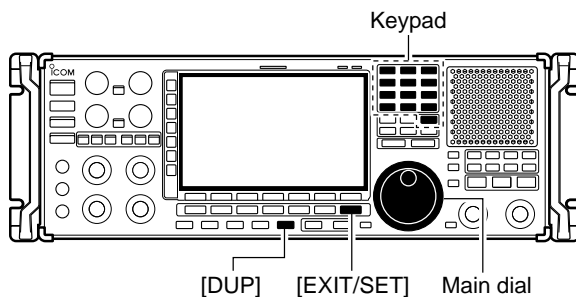

- ① Push and hold [DUP] for 1 sec. to enter offset frequency set mode.
- ② Rotate the main dial to select the desired offset frequency or edit the desired offset frequency directly with the keypad.
- ③ Push [EXIT/SET] to return to the previous indication.

## ■ Tone /DTCS squelch operation

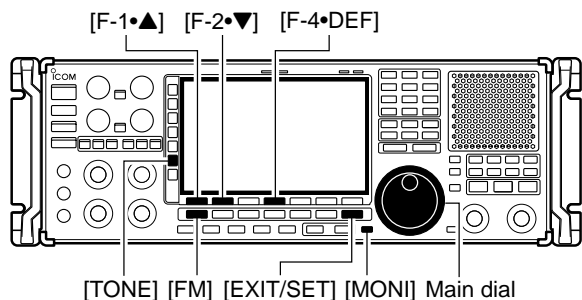

The tone or DTCS squelch opens only when receiving a signal containing a matching subaudible tone or DTCS code. You can silently wait for calls from group members using the same tone.

- ① Set the desired frequency and select FM mode.
- ② Push [TONE] several times to turn the tone or DTCS squelch function ON.
  - “TSQL” appears when the tone squelch function is ON.
  - “DTCS” appears when the DTCS squelch function is ON.
- ③ Push and hold [TONE] for 1 sec. to enter tone frequency set mode.
- ④ Push [F-1•▲] or [F-2•▼] to select the items, “T-SQL TONE” or “DTCS CODE.”
- ⑤ Rotate the main dial to select the desired tone frequency or DTCS code.
  - Push and hold [F-4•DEF] for 1 sec. to select the default setting.
- ⑥ Push [EXIT/SET] to return to the previous indication.
- ⑦ When the received signal includes a matching tone (or DTCS code), squelch opens and the signal can be heard.
  - When the received signal's tone (or DTCS code) does not match, tone (DTCS) squelch does not open, however, the S-indicator shows signal strength.
- ⑧ To open the squelch manually, push [MONI].
  - The squelch opens temporarily while pushing and holding [MONI].
- ⑨ To cancel the tone squelch or DTCS squelch, push [TONE] several times to clear the tone or DTCS squelch.
  - “TSQL” or “DTCS” disappears.

• Available tone frequencies (unit: Hz)

67.0	85.4	107.2	136.5	165.5	186.2	210.7	254.1
69.3	88.5	110.9	141.3	167.9	189.9	218.1	150.0
71.9	91.5	114.8	146.2	171.3	192.8	225.7	
74.4	94.8	118.8	151.4	173.8	196.6	229.1	
77.0	97.4	123.0	156.7	177.3	199.5	233.6	
79.7	100.0	127.3	159.8	179.9	203.5	241.8	
82.5	103.5	131.8	162.2	183.5	206.5	250.3	

• Available DTCS codes

023	072	152	244	311	412	466	631
025	073	155	245	315	413	503	632
026	074	156	246	325	423	506	654
031	114	162	251	331	431	516	662
032	115	165	252	332	432	523	664
036	116	172	255	343	445	526	703
043	122	174	261	346	446	532	712
047	125	205	263	351	452	546	723
051	131	212	265	356	454	565	731
053	132	223	266	364	455	606	732
054	134	225	271	365	462	612	734
065	143	226	274	371	464	624	743
071	145	243	306	411	465	627	754



## ■ Operating WFM

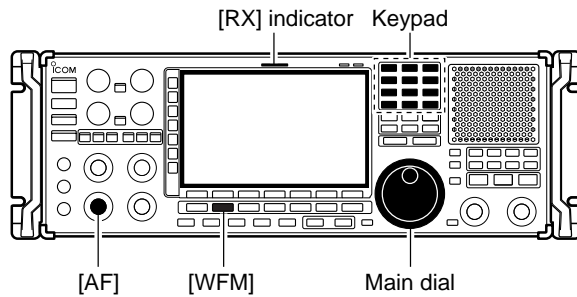

- ① Edit the desired frequency using the keypad.
- ② Push [WFM] to select WFM.
  - “WFM” indicator appears.
- ③ Rotate the main dial to tune the desired frequency.
  - [RX] indicator lights green and the S-meter indicates received signal strength when signal is received.
  - 25 kHz tuning step is preset for the WFM mode.
- ④ Rotate [AF] to set audio to a comfortable listening level.

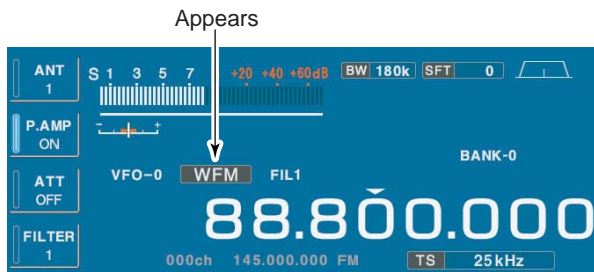

### ◇ Convenient functions for WFM

- **Preamp** (p. 5-9)
  - Push [P.AMP] several times to set the preamp OFF, preamp 1 ON or preamp 2 ON. Only ON/OFF is available above 30 MHz.
    - “P.AMP1” or “P.AMP2” appears when the preamp 1 or preamp 2 is ON below 30 MHz. “P.AMP ON” appears above 30 MHz.
- **Attenuator** (p. 5-9)
  - Push [ATT] several times to set the attenuator in 6 dB steps for HF bands, or 10 dB step for 30–1150 MHz. Only 20 dB is available for 1150–3335 MHz.
    - “ATT” and attenuation level appear when the attenuator is ON.
- **Auto notch filter** (p. 5-16)
  - Push [NOTCH] switch to turn the auto notch function ON or OFF.
    - Notch indicator (above [NOTCH] switch) lights when either the manual notch is ON.
- **VSC (voice squelch control)** (p. 8-3)
  - Push [VSC] to turn the VSC function ON or OFF.
    - The VSC indicator appears when the voice squelch function is set to ON.
- **AFC (Auto Frequency Control)** (p. 5-17)
  - Push [AFC] to turn the AFC function ON or OFF.
    - The AFC indicator appears when the AFC function is set to ON.

## ■ TV channel operation

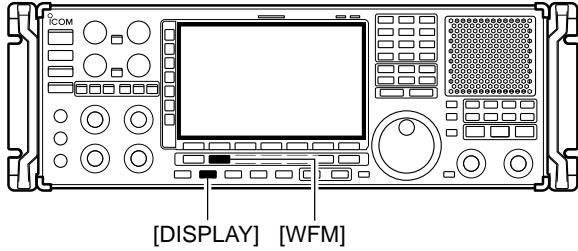

A TV tuner is built-in to the IC-R9500, and connects to the [VIDEO IN] and [VIDEO OUT] on the rear panel using a TV jumper cable to monitor the TV programs.

If you would rather use your TV tuner, connect the external tuner to [VIDEO IN] on the rear panel.

- ① Push [DISPLAY] once or twice to turn ON the desired TV screen.
  - Push once to turn ON the mini TV screen, push again to turn ON the full TV screen and push again to close the TV screen.
- ② Set the desired frequency and select WFM mode.
- ③ Push [DISPLAY] to close the TV screen.

▨ The TV display settings can be adjusted in display set (Video) mode. (p. 11-24)

## ◇ Convenient functions for TV operation

- **Preamp** (p. 5-9)
  - ➔ Push [P.AMP] several times to set the preamp OFF, preamp 1 ON or preamp 2 ON. Only ON/OFF is available above 30 MHz.
    - "P.AMP1" or "P.AMP2" appears when the preamp 1 or preamp 2 is ON below 30 MHz. "P.AMP ON" appears above 30 MHz.
- **Attenuator** (p. 5-9)
  - ➔ Push [ATT] several times to set the attenuator in 6 dB steps for HF bands, or 10 dB step for 30–1150 MHz. Only 20 dB is available for 1150–3335 MHz.
    - "ATT" and attenuation level appear when the attenuator is ON.
- **Auto notch filter** (p. 5-16)
  - ➔ Push [NOTCH] switch to turn the auto notch function ON or OFF.
    - Notch indicator (above [NOTCH] switch) lights when either the manual notch is ON.
- **VSC (voice squelch control)** (p. 8-3)
  - ➔ Push [VSC] to turn the VSC function ON or OFF.
    - The VSC indicator appears when the voice squelch function is set to ON.
- **AFC (Auto Frequency Control)** (p. 5-17)
  - ➔ Push [AFC] to turn the AFC function ON or OFF.
    - The AFC indicator appears when the AFC function is set to ON.

## ■ Operating AM

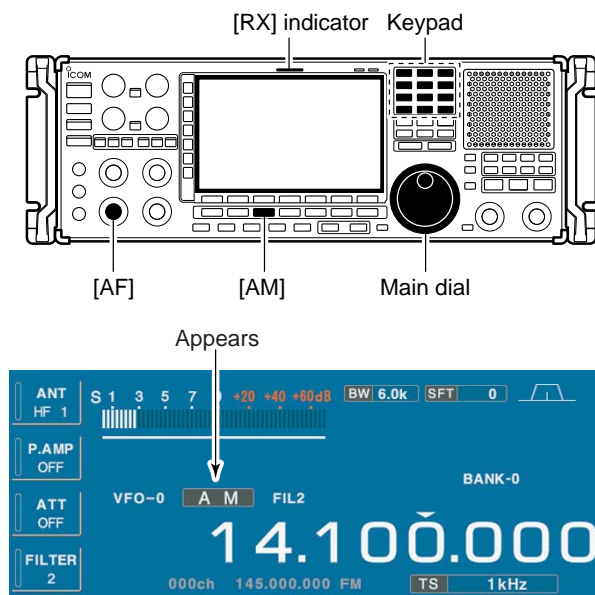

- ① Edit the desired frequency using the keypad.
- ② Push [AM] to select AM.
  - “AM” indicator appears.
  - After AM mode is selected, push and hold [AM] for 1 sec. to toggle between AM and S-AM modes.
- ③ Rotate the main dial to tune the desired frequency.
  - [RX] indicator lights green and the S-meter indicates received signal strength when signal is received.
- ④ Rotate [AF] to set audio to a comfortable listening level.

### ◇ Convenient functions for AM

- **Preamp** (p. 5-9)
  - ➔ Push [P.AMP] several times to set the preamp OFF, preamp 1 ON or preamp 2 ON. Only ON/OFF is available above 30 MHz.
    - “P.AMP1” or “P.AMP2” appears when the preamp 1 or preamp 2 is ON below 30 MHz. “P.AMP ON” appears above 30 MHz.
- **Attenuator** (p. 5-9)
  - ➔ Push [ATT] several times to set the attenuator in 6 dB steps for HF bands, or 10 dB step for 30–1150 MHz. Only 20 dB is available for 1150–3335 MHz.
    - “ATT” and attenuation level appear when the attenuator is ON.
- **Noise blanker** (p. 5-15)
  - ➔ Push [NB] switch to turn the noise blanker ON and OFF, and then rotate [NB] control to adjust the threshold level.
    - Noise blanker indicator (above [NB] switch) lights when the noise blanker is ON.
    - Push [NB] for 1 sec. to enter noise blanker set mode.
- **Noise reduction** (p. 5-16)
  - ➔ Push [NR] switch to turn the noise reduction ON and OFF.
    - Rotate [NR] control to adjust the noise reduction level.
    - Noise reduction indicator (above [NR] switch) lights when the noise reduction is ON.
- **Twin PBT (passband tuning)** (p. 5-11)
  - ➔ Rotate [TWIN PBT] controls (inner/outer).
    - Push [PBT CLEAR] to clear the settings.
- **Auto notch filter** (p. 5-16)
  - ➔ Push [ANF] switch to turn the auto notch function ON or OFF.
    - Notch indicator (above [ANF] switch) lights when the auto notch is ON.
- **Manual notch filter** (p. 5-16)
  - ➔ Push [NOTCH1] or [NOTCH2] switch to turn the manual notch function ON or OFF.
    - Rotate [NOTCH] control to set the notch frequency.
    - Notch indicator (above [NOTCH1] or [NOTCH2] switch) lights when either the manual notch is ON.
- **AGC (auto gain control)** (p. 5-10)
  - ➔ Push [AGC] switch several times to select AGC FAST, AGC MID or AGC SLOW.
  - ➔ Push [AGC VR] to turn the AGC time constant manual setting ON or OFF.
    - Rotate [AGC] control to adjust the time constant.
- **Auto tuning function** (p. 5-17)
  - ➔ Push [AUTOTUNE] to turn the auto tuning function ON or OFF.
    - The receiver automatically tunes the desired signal within  $\pm 5$  kHz range.

#### **IMPORTANT!**

When receiving a weak signal, or receiving a signal with interference, the automatic tuning function may not tune, or may tune to an undesired signal.

## ■ Operating SSB

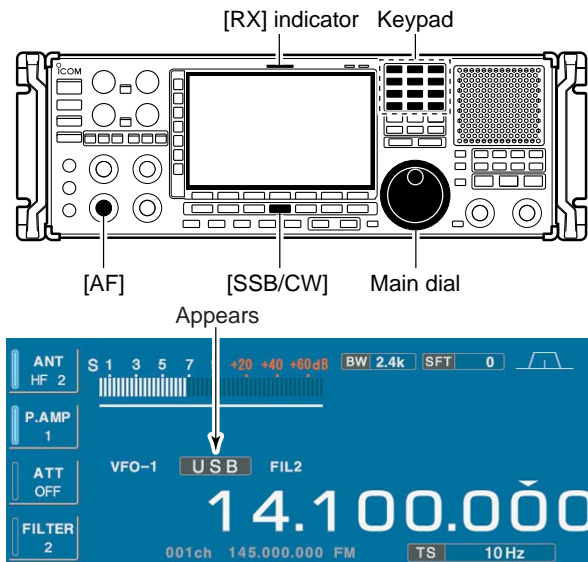

- ① Edit the desired frequency using the keypad.
- ② Push [SSB/CW] to select SSB (LSB or USB).
  - After SSB mode is selected, push and hold [SSB/CW] for 1 sec. to toggle between LSB and USB modes.
  - “LSB” or “USB” appears.
- ③ Rotate the main dial to tune a desired signal.
  - [RX] indicator lights green and the S-meter indicates received signal strength when signal is received.
- ④ Rotate [AF] to set audio to a comfortable listening level.

## ◇ Convenient functions for SSB

- **Preamp** (p. 5-9)
    - ➔ Push [P.AMP] several times to set the preamp OFF, preamp 1 ON or preamp 2 ON. Only ON/OFF is available above 30 MHz.
      - “P.AMP1” or “P.AMP2” appears when the preamp 1 or preamp 2 is ON below 30 MHz. “P.AMP ON” appears above 30 MHz.
  - **Attenuator** (p. 5-9)
    - ➔ Push [ATT] several times to set the attenuator in 6 dB steps for HF bands, or 10 dB step for 30–1150 MHz. Only 20 dB is available for 1150–3335 MHz.
      - “ATT” and attenuation level appear when the attenuator is ON.
  - **Noise blanker** (p. 5-15)
    - ➔ Push [NB] switch several times to select the noise blanker 1 ON, noise blanker 2 ON and noise blanker OFF, and then rotate [NB] control to adjust the threshold level.
      - Noise blanker indicator (above [NB] switch) lights when the noise blanker is ON.
      - Push [NB] for 1 sec. to enter noise blanker set mode.
  - **Twin PBT (passband tuning)** (p. 5-11)
    - ➔ Rotate [TWIN PBT] controls.
      - Push [PBT CLEAR] to clear the settings.
  - **Noise reduction** (p. 5-16)
    - ➔ Push [NR] switch to turn the noise reduction ON and OFF.
      - Rotate [NR] control to adjust the noise reduction level.
      - Noise reduction indicator (above [NR] switch) lights when the noise reduction is ON.
  - **Auto notch filter** (p. 5-16)
    - ➔ Push [ANF] switch to turn the auto notch function ON or OFF.
      - Notch indicator (above [ANF] switch) lights when the auto notch is ON.
  - **Manual notch filter** (p. 5-16)
    - ➔ Push [NOTCH1] or [NOTCH2] switch to turn the manual notch function ON or OFF.
      - Rotate [NOTCH] control to set the attenuating frequency.
      - Notch indicator (above [NOTCH1] or [NOTCH2] switch) lights when either the manual notch is ON.
  - **AGC (auto gain control)** (p. 5-10)
    - ➔ Push [AGC] switch several times to select AGC FAST, AGC MID or AGC SLOW.
    - ➔ Push [AGC VR] to turn the AGC time constant manual setting ON or OFF.
      - Rotate [AGC] control to adjust the time constant.
  - **VSC (voice squelch control)** (p. 8-3)
    - ➔ Push [VSC] to turn the VSC function ON or OFF.
      - The VSC indicator appears when the voice squelch function is set to ON.
  - **Auto tuning function** (p. 5-17)
    - ➔ Push [AUTOTUNE] to turn the auto tuning function ON or OFF.
      - The receiver automatically tunes the desired signal within  $\pm 5$  kHz range.
- IMPORTANT!**  
When receiving a weak signal, or receiving a signal with interference, the automatic tuning function may not tune, or may tune to an undesired signal.

## ■ Operating CW

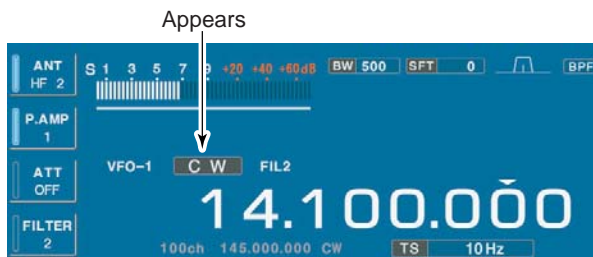
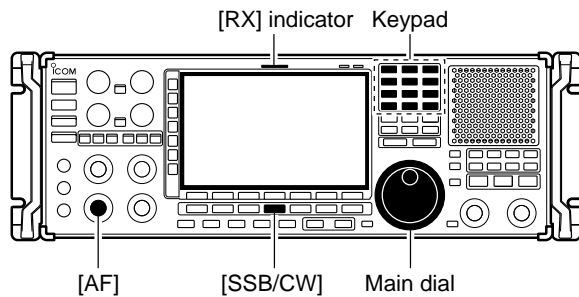

- ① Edit the desired frequency using the keypad.
- ② Push [SSB/CW] to select CW.
  - After CW mode is selected, push and hold [SSB/CW] for 1 sec. to toggle between CW and CW-R modes.
  - “CW” or “CW-R” appears.
- ③ Rotate the main dial to tune a desired signal.
  - Try to match the specified signal's tone to the side tone frequency.
  - [RX] indicator lights green and the S-meter indicates received signal strength when signal is received.
- ④ Rotate [AF] to set audio to a comfortable listening level.

## ◇ Convenient functions for CW

- **Preamp** (p. 5-9)
    - ➔ Push [P.AMP] several times to set the preamp OFF, preamp 1 ON or preamp 2 ON. Only ON/OFF is available above 30 MHz.
      - “P.AMP1” or “P.AMP2” appears when the preamp 1 or preamp 2 is ON below 30 MHz. “P.AMP ON” appears above 30 MHz.
  - **Attenuator** (p. 5-9)
    - ➔ Push [ATT] several times to set the attenuator in 6 dB steps for HF bands, or 10 dB step for 30–1150 MHz. Only 20 dB is available for 1150–3335 MHz.
      - “ATT” and attenuation level appear when the attenuator is ON.
  - **Noise blanker** (p. 5-15)
    - ➔ Push [NB] switch to turn the noise blanker ON and OFF, and then rotate [NB] control to adjust the threshold level.
      - Noise blanker indicator (above [NB] switch) lights when the noise blanker is ON.
      - Push [NB] for 1 sec. to enter noise blanker set mode.
  - **Noise reduction** (p. 5-16)
    - ➔ Push [NR] switch to turn the noise reduction ON and OFF.
      - Rotate [NR] control to adjust the noise reduction level.
      - Noise reduction indicator (above [NR] switch) lights when the noise reduction is ON.
  - **Twin PBT (passband tuning)** (p. 5-11)
    - ➔ Rotate [TWIN PBT] controls (inner/outer).
      - Push [PBT CLEAR] to clear the settings.
  - **Manual notch filter** (p. 5-16)
    - ➔ Push [NOTCH1] or [NOTCH2] switch to turn the manual notch function ON or OFF.
      - Rotate [NOTCH] control to set the notch frequency.
      - Notch indicator (above [NOTCH1] or [NOTCH2] switch) lights when either the manual notch is ON.
  - **AGC (auto gain control)** (p. 5-10)
    - ➔ Push [AGC] switch several times to select AGC FAST, AGC MID or AGC SLOW.
    - ➔ Push [AGC VR] to turn the AGC time constant manual setting ON or OFF.
      - Rotate [AGC] control to adjust the time constant.
  - **1/4 function** (p. 3-6)
    - ➔ Push [1/4] to turn the 1/4 function ON or OFF.
  - **Auto tuning function** (p. 5-17)
    - ➔ Push [AUTOTUNE] to turn the auto tuning function ON or OFF.
      - The receiver automatically tunes the desired signal within a  $\pm 500$  Hz range.
- IMPORTANT!**  
When receiving a weak signal, or receiving a signal with interference, the automatic tuning function may not tune properly, or tune onto an undesired signal.

◇ APF (Audio Peak Filter) operation

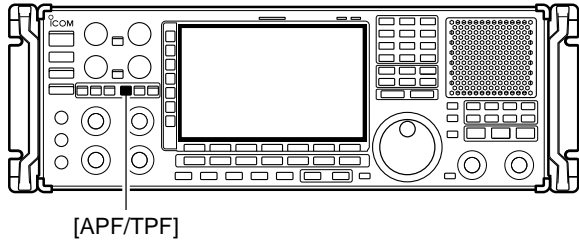

The APF changes the audio frequency response by boosting a particular frequency to enhance a desired CW signal.

The audio filter shape is also selectable from “SOFT” and “SHARP” in the others set mode. (p. 11-13)

- ① During CW mode, push [APF/TPF] to turn the audio peak filter ON and OFF.
  - “APF” appears in the display and [APF/TPF] indicator above this switch lights green.
- ② Push and hold [APF/TPF] for 1 sec. several times to select the desired audio filter width.
  - 320, 160 and 80 Hz filters are available.

◇ About CW reverse mode

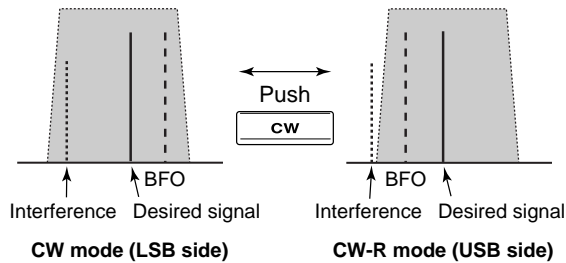

CW-R (CW Reverse) mode uses the opposite side band to receive CW signals.

Use when interfering signals are near a desired signal and you want to use CW-R to reduce the interference.

- ➔ During CW mode, push and hold [SSB/CW] for 1 sec. to select CW and CW-R mode.

◇ About CW pitch control

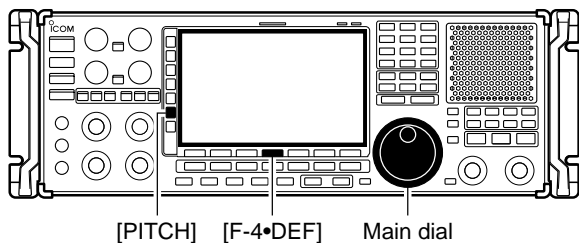

The received CW audio pitch can be adjusted to suit your preference (from 300 to 900 Hz in 5 Hz steps). This does not change the operating frequency.

- ① During CW mode, push [PITCH] to turn the CW pitch setting screen ON and OFF.
- ② Rotate the main dial to suit your preference.
  - Adjustable within 300 to 900 Hz in 5 Hz steps.
  - Push and hold [F-4•DEF] for 1 sec. to return to the default setting.



**CW Pitch**

**800**

Sets the desired CW pitch within 300 to 900 Hz in 5 Hz steps. (default: 800 Hz)



## ■ Operating FSK

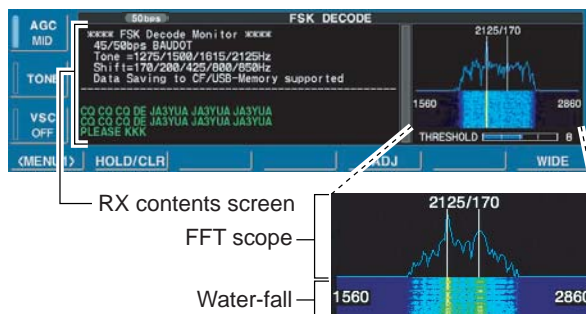
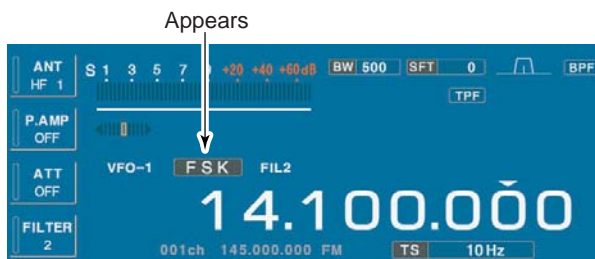
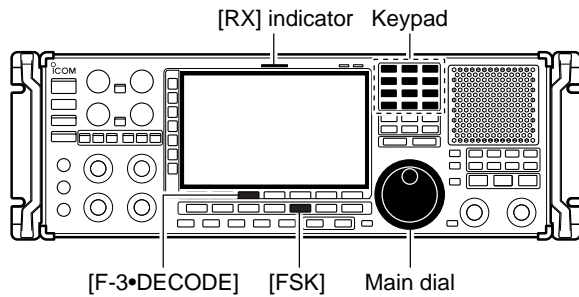

A DSP-based high-quality Baudot FSK decoder is built-in to the IC-R9500.

If you would rather use your FSK terminal or TNC, consult the manual that comes with the FSK terminal or TNC.

- ① Edit the desired frequency using the keypad.
- ② Push [FSK] to select FSK.
  - After FSK mode is selected, push and hold [FSK] for 1 sec. to toggle between FSK and FSK-R modes.
  - "FSK" or "FSK-R" appears.
- ③ Push [F-3•DECODE] to display the decoder screen.
  - The IC-R9500 has a built-in Baudot decoder.
- ④ To tune the desired signal, aim for a symmetrical wave form and ensure the signal peaks align with the mark (2125 Hz) and shift (170 Hz) frequency lines in the FFT scope.
  - [RX] indicator lights green and the S-meter indicates received signal strength when signal is received.

◆ Convenient functions for FSK

- **Preamp** (p. 5-9)
  - ➔ Push [P.AMP] several times to set the preamp OFF, preamp 1 ON or preamp 2 ON. Only ON/OFF is available above 30 MHz.
    - “P.AMP1” or “P.AMP2” appears when the preamp 1 or preamp 2 is ON below 30 MHz. “P.AMP ON” appears above 30 MHz.
- **Attenuator** (p. 5-9)
  - ➔ Push [ATT] several times to set the attenuator in 6 dB steps for HF bands, or 10 dB step for 30–1150 MHz. Only 20 dB is available for 1150–3335 MHz.
    - “ATT” and attenuation level appear when the attenuator is ON.
- **Noise blanker** (p. 5-15)
  - ➔ Push [NB] switch to turn the noise blanker ON and OFF, and then rotate [NB] control to adjust the threshold level.
    - Noise blanker indicator (above [NB] switch) lights when the noise blanker is ON.
    - Push [NB] for 1 sec. to enter noise blanker set mode.
- **Twin PBT (passband tuning)** (p. 5-11)
  - ➔ Rotate [TWIN PBT] controls (inner/outer).
    - Push [PBT CLEAR] to clear the settings.
- **Noise reduction** (p. 5-16)
  - ➔ Push [NR] switch to turn the noise reduction ON and OFF.
    - Rotate [NR] control to adjust the noise reduction level.
    - Noise reduction indicator (above [NR] switch) lights when the noise reduction is ON.
- **Manual notch filter** (p. 5-16)
  - ➔ Push [NOTCH1] or [NOTCH2] switch to turn the manual notch function ON or OFF.
    - Rotate [NOTCH] control to set the notch frequency.
    - Notch indicator (above [NOTCH1] or [NOTCH2] switch) lights when either the manual notch is ON.
- **AGC (auto gain control)** (p. 5-10)
  - ➔ Push [AGC] switch several times to select AGC FAST, AGC MID or AGC SLOW.
  - ➔ Push [AGC VR] to turn the AGC time constant manual setting ON or OFF.
    - Rotate [AGC] control to adjust the time constant.
- **1/4 function** (p. 3-6)
  - ➔ Push [1/4] to turn the 1/4 function ON or OFF.

◆ About FSK reverse mode

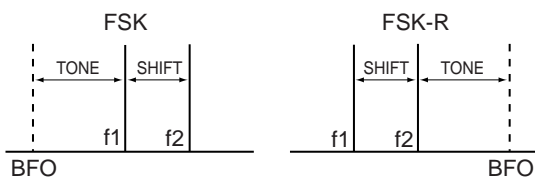

Received characters are occasionally garbled when the received signal has Mark and Space tones reversed. This reversal can be caused by incorrect TNC connections, setting, commands, etc. To receive reversed FSK signals correctly, select FSK-R mode.

- ➔ During FSK mode, push and hold [FSK] for 1 sec. to select FSK and FSK-R mode.

◆ Twin peak filter

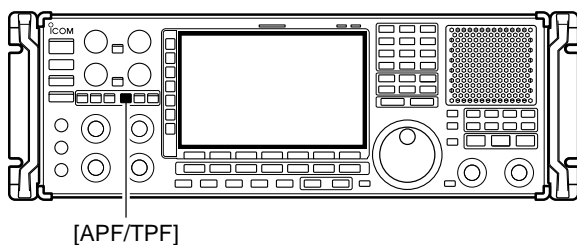

The twin peak filter changes audio frequency response by boosting the mark and space frequencies (2125 and 2295 Hz) for better reception of FSK signals.

- ➔ During FSK mode, push [APF/TPF] to turn the twin peak filter ON and OFF.
  - “TPF” appears in the LCD and the [APF/TPF] indicator above this switch lights green while the filter is in use.

/// **NOTE:** When the twin peak filter is in use, the received audio output may increase. This is normal, not a malfunction.



### ◆ Functions for the FSK decoder indication

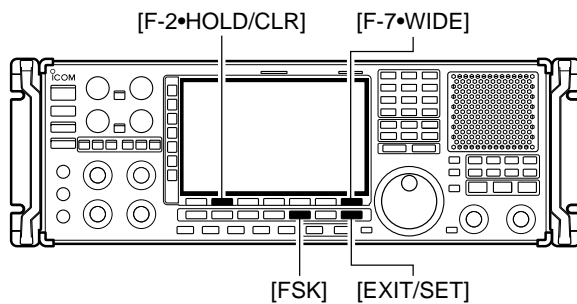

### • Wide screen indication



### ◆ Setting the decoder threshold level



- ① Push [FSK] to select FSK.
  - After FSK mode is selected, push and hold [FSK] for 1 sec. to toggle between FSK and FSK-R modes.
  - “FSK” or “FSK-R” appears.
- ② Push [F-3•DECODE] to display the decoder screen.
  - When tuned into an FSK signal, decoded characters are displayed in the contents screen.
- ③ Push [F-2•HOLD/CLR] to freeze the current screen.
  - “HOLD” appears while the function is in use.
  - Push [F-2•HOLD/CLR] again to release the function.
- ④ Push and hold [F-2•HOLD/CLR] for 1 sec. to clear the displayed characters.
  - “HOLD” indicator disappears at the same time when the hold function is in use.
- ⑤ Push [F-7•WIDE] to toggle the FSK decode screen size from normal and wide.
- ⑥ Push [EXIT/SET] to close the FSK decode screen.

Adjust the FSK decoder threshold level if some characters are displayed when no signal is received.

- ① Select the FSK decoder screen as described above.
- ② Push [F-5•ADJ] to select the threshold level setting condition.
- ③ Rotate the main dial to adjust the FSK decoder threshold level.
  - Push and [F-6•DEF] for 1 sec. to select the default setting.
- ④ Push [F-5•ADJ] to exit from the threshold level setting condition.

▨ The UnShift On Space (USOS) function and new line code can be set in the FSK set mode. (p. 4-14)

◆ FSK decode set mode

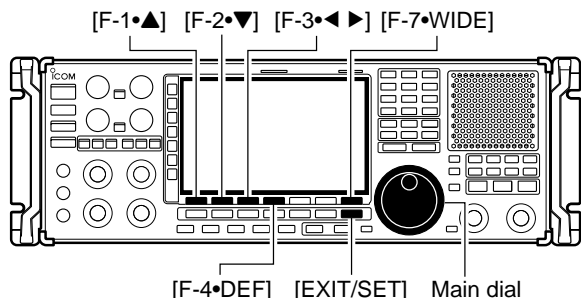

• FSK decode set mode screen



This set mode is used to set the decode USOS function, time stamp setting, etc.

• Setting contents

- ① During FSK mode operation, push [F-3•DECODE] to select FSK decode screen.
- ② Push [F-1•◀MENU1▶] to select FSK decode menu 2, then push [F-6•SET] to select FSK decode set mode.
  - Push [F-7•WIDE] to toggle the screen size from normal and wide.
- ③ Push [F-1•▲] or [F-2•▼] to select the desired set item.
- ④ Set the desired condition using the main dial.
  - Push and hold [F-4•DEF] for 1 sec. to select a default condition or value.
  - Push [F-3•◀▶] to select the set contents for some items.
- ⑤ Push [EXIT/SET] to exit from set mode.

**FSK FFT Scope Averaging**

**OFF**

Set the FFT scope waveform averaging function from 2 to 4 and OFF. (default: OFF)

**Recommendation!**

If you use the FFT scope waveform for tuning, use of the default, or smaller number setting is recommended.

**FSK FFT Scope Waveform Color**



Set the color for the FFT scope waveform.

- The color is set in RGB format.
- The set color is indicated in the box beside the RGB scale.

- Push [F-3•◀▶] to select R (Red), G (Green) and B (Blue), and then rotate the main dial to set the ratio from 0 to 255.

**FSK Decode USOS**

**ON**

Turn letter code decoding after receiving a “space” (USOS; UnShift On Space function) capability ON and OFF.

- ON : Decode as letter code.
- OFF : Decode as character code.



**FSK Decode New Line Code**

**CR,LF,CR+LF**

Selects the new line code of the internal FSK decoder.  
CR: Carriage Return, LF: Line Feed

- CR,LF,CR;LF : Makes new line with any codes.
- CR+LF : Makes new line with CR+LF code only.

### ◇ FSK decode set mode (continued)

<p><b>FSK Time Stamp (Time)</b></p> <p>Selects the clock indication for time stamp usage.</p> <p><b>NOTE:</b> The time will be displayed when [F-4•TIME] is pushed in “FSK DECODE” screen as at page 4-13.</p>	<p><b>Local</b></p> <ul style="list-style-type: none"> <li>Local : Selects the time that set in “Time (Now).”</li> <li>UTC* : Selects the time that set in “CLOCK2.” *The name of choice may differ according to “CLOCK2 Name” setting (p, 10-2). “UTC” is the default name of CLOCK2.</li> </ul>
<p><b>FSK Time Stamp (Frequency)</b></p> <p>Selects the operating frequency indication for time stamp usage.</p>	<p><b>ON</b></p> <ul style="list-style-type: none"> <li>ON : Displays the operating frequency. (default)</li> <li>OFF : No operating frequency displays.</li> </ul>
<p><b>FSK Font Color (Receive)</b></p> <p>Set the text color for received characters.</p> <ul style="list-style-type: none"> <li>The color is set in RGB format.</li> <li>The set color is indicated in the box beside the RGB scale.</li> </ul>	 <ul style="list-style-type: none"> <li>Push [F-3•◀▶] to select R (Red), G (Green) and B (Blue), and then rotate the main dial to set the ratio from 0 to 255.</li> </ul>
<p><b>FSK Font Color (Time Stamp)</b></p> <p>Set the text color for time stamp indication.</p> <ul style="list-style-type: none"> <li>The color is set in RGB format.</li> <li>The set color is indicated in the box beside the RGB scale.</li> </ul>	 <ul style="list-style-type: none"> <li>Push [F-3•◀▶] to select R (Red), G (Green) and B (Blue), and then rotate the main dial to set the ratio from 0 to 255.</li> </ul>

### ◇ Time stamp function

Time stamp function is used to add the time or frequency information when receiving a signal. Frequency information can be turned OFF in FSK decode set mode.

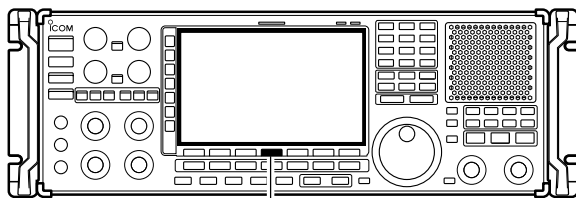

[F-4•TIME]

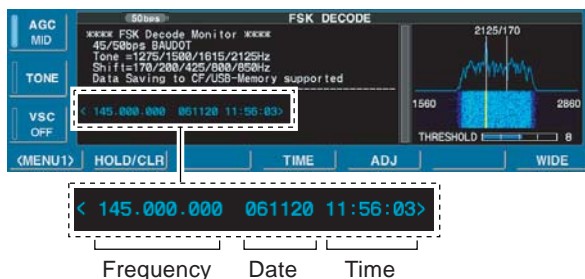

- ① Select the FSK decoder screen as described on page 4-13.
- ② Push [F-4•TIME] to add the time stamp information.
  - Frequency, date and time information are added on the decoder screen.
- ③ Continue receiving.

## 4 RECEIVE MODES

### ◇ Setting FSK tone frequency



Select the FSK tone frequency and adjust the FSK shift width.

- ① Select the FSK decoder screen as described on page 4-13.
- ② Push [TONE] on the multifunction menu to enter FSK tone set mode.
- ③ Push [F-1•▲] or [F-2•▼] to select the items, “FSK Tone Frequency” or “FSK Shift Width.”
- ④ Rotate the main dial to select the desired tone frequency or shift width.
  - Push and hold [F-4•DEF] for 1 sec. to select the default setting.
- ⑤ Push [EXIT/SET] to return to the previous indication.

#### FSK RX Frequency

Selects the FSK receive frequency from Mark/Space Center and Mark(Space).  
(default: Mark/Space Center)

#### Mark/Space Center

- Mark/Space Center: Displayed frequency is set to the center of Mark and Space.
- Mark(Space): Displayed frequency is set as Mark (FSK mode) or Space (FSK-R mode).

#### FSK Tone Frequency

2125

Selects the FSK mark frequency. FSK mark frequency is switched between 1275, 1615 and 2125 Hz.  
(default: 2125 Hz)

#### FSK Shift Width

170

Selects the FSK shift width. There are 3 selectable values: 170, 200 and 425 Hz. (default: 170 Hz)

### ◇ Setting FSK baud rate

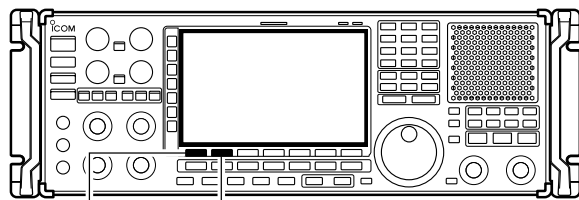

[F-1•<MENU1>] [F-2•BAUD]

50 bps Selected baud rate appears



The data transfer rate can be selected from two speeds, 45 bps and 50 bps.

- ① Select the FSK decoder screen as described on page 4-13.
- ② Push [F-1•<MENU1>] to select the second FSK decode menu.
- ③ Push [F-2•BAUD] to select the desired data transfer rate.
  - 45 bps and 50 bps are available.

## ◆ Data saving

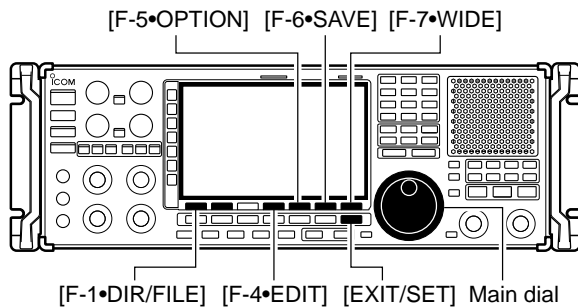

### • Decode file save screen

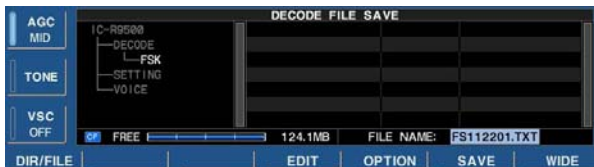

### • Decode file save screen— file name edit

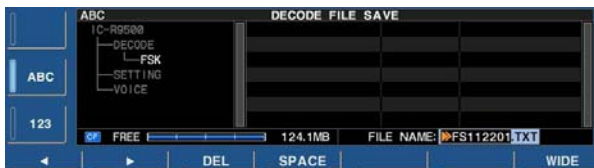

### • Save option screen

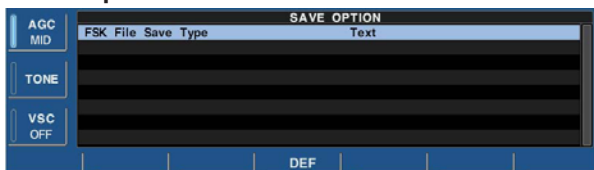

#### When USB-Memory is Inserted:

Push and hold [F-1•DIR/FILE] for 1 sec. to select the USB-Memory, or push and hold [F-1•DIR/FILE] for 1 sec. again to return to CF memory card when selecting the saving location.

The contents of the received signal can be saved in the CF memory card.

- ① In the FSK decode screen, push [F-1•<MENU1>] to select the second FSK decode menu.
- ② Push [F-5•SAVE] to select decode file save screen.
- ③ Change the following conditions if desired.

#### • File name:

- ① Push [F-4•EDIT] to select file name edit condition.
  - Push [F-1•DIR/FILE] several times to select the file name, if necessary.
- ② Push [ABC], [123] or [Symbol] to select the character group, then rotate the main dial to select the character.
  - Push [123] or [Symbol] to toggle numerals and symbols.
  - [ABC] : A to Z (capital letters); [123]: 0 to 9 (numerals); [Symbol]: ! # \$ % & ' ` ^ - ( ) { } \_ ~ @ can be selected.
  - Push [F-1•◀] to move the cursor left, push [F-2•▶] to move the cursor right, [F-3•DEL] delete a character and push [F-4•SPACE] to insert a space.
- ③ Push [EXIT/SET] to set the file name.

#### • File format

- ① Push [F-5•OPTION] to enter save option screen.
- ② Rotate the main dial to select the save format from Text or HTML.
  - “Text” is the default setting.
  - Push and hold [F-4•DEF] for 1 sec. to select the default setting.
- ③ Push [EXIT/SET] to return to the previous indication.

#### • Saving location

- ① Push [F-1•DIR/FILE] to select tree view screen.
- ② Select the desired directory or folder in the CF memory card.
  - Push [F-4•◀▶] to select the upper directory.
  - Push [F-2•▲] or [F-3•▼] to select folder in the same directory.
  - Push and hold [F-4•◀▶] for 1 sec. to select a folder in the directory.
  - Push [F-5•REN/DEL] to rename the folder.
  - Push and hold [F-5•REN/DEL] for 1 sec. to delete the folder.
  - Push and hold [F-6•MAKE] for 1 sec. to making a new folder. (Edit the name in the same manner as the “• File name” above.)
- ③ Push [F-1•DIR/FILE] twice to select the file name.

- ④ Push [F-6•SAVE].

• After the save is completed, returns to FSK decode menu 2 automatically.

#### ✓ For your convenience!

Two formats, Text and HTML, are available for storage of data to your PC.

## ■ Operating P25 (Requires optional UT-122)

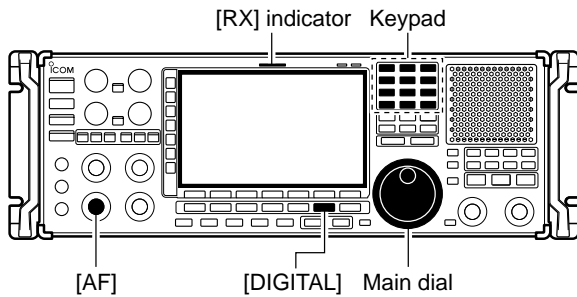

- ① Edit the desired frequency using the keypad.
- ② Push [DIGITAL] to select P25.
  - “P25” indicator appears.
- ③ Rotate the main dial to tune the desired frequency.
  - [RX] indicator lights green and the S-meter indicates received signal strength when signal is received.
- ④ Rotate [AF] to set audio to a comfortable listening level.

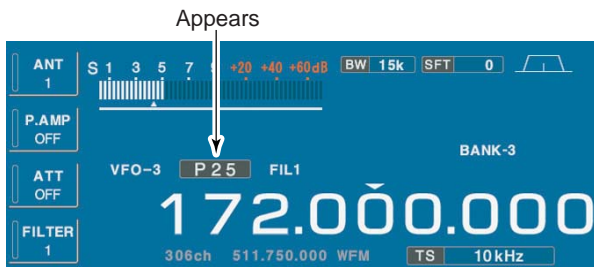

### ◇ Convenient functions for P25

- **Preamp** (p. 5-9)
  - ➔ Push [P.AMP] several times to set the preamp OFF, preamp 1 ON or preamp 2 ON. Only ON/OFF is available above 30 MHz.
    - “P.AMP1” or “P.AMP2” appears when the preamp 1 or preamp 2 is ON below 30 MHz. “P.AMP ON” appears above 30 MHz.
- **Attenuator** (p. 5-9)
  - ➔ Push [ATT] several times to set the attenuator in 6 dB steps for HF bands, or 10 dB step for 30–1150 MHz. Only 20 dB is available for 1150–3335 MHz.
    - “ATT” and attenuation level appear when the attenuator is ON.
- **Twin PBT (passband tuning)** (p. 5-11)
  - ➔ Rotate [TWIN PBT] controls (inner/outer).
    - Push [PBT CLEAR] to clear the settings.