



## INSTRUCTION MANUAL

VHF AIR BAND TRANSCEIVER

# IC-A14 IC-A14S

This device complies with Part 15 of the FCC Rules. Operation is subject to the condition that this device does not cause harmful interference.

Icom Inc.



▲IC-A14



▲IC-A14S

---

## PREFACE

---

Thank you for choosing this Icom product. This product is designed and built with Icom's state of the art technology and craftsmanship. With proper care, this product should provide you with years of trouble-free operation.

---

## IMPORTANT

---

**READ ALL INSTRUCTIONS** carefully and completely before using the transceiver.

**SAVE THIS INSTRUCTION MANUAL**— This instruction manual contains important operating instructions for the IC-A14/IC-A14S VHF AIR BAND TRANSCEIVER.

---

## EXPLICIT DEFINITIONS

---

WORD	DEFINITION
⚠ <b>DANGER!</b>	Personal death, serious injury or an explosion may occur.
⚠ <b>WARNING!</b>	Personal injury, fire hazard or electric shock may occur.
<b>CAUTION</b>	Equipment damage may occur.
<b>NOTE</b>	If disregarded, inconvenience only. No risk of personal injury, fire or electric shock.

---

## SUPPLIED ACCESSORIES

---

The following accessories are supplied with the transceiver.

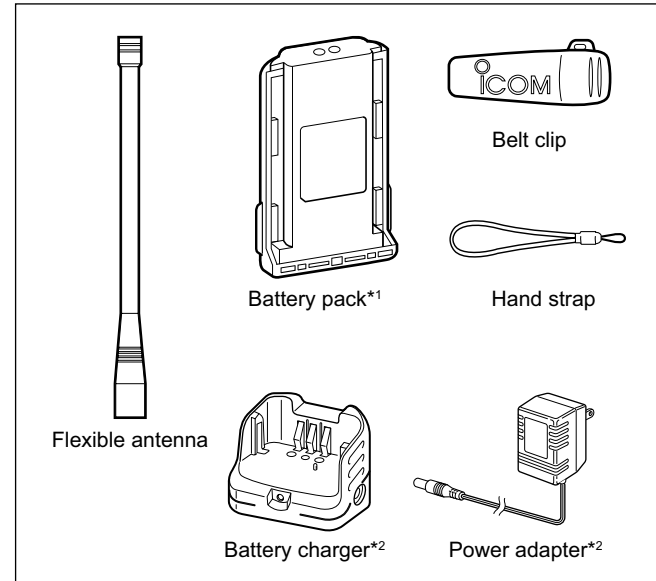

\*1 Battery case is supplied with some versions.

\*2 Not supplied with the battery case supplied versions.

---

## PRECAUTIONS

---

⚠ **DANGER! NEVER** short the terminals of the battery pack. Also, current may flow into nearby metal objects, such as keys, and so on. Therefore, be careful when carrying with, or placing near metal objects, carrying in bags, and so on.

⚠ **DANGER!** Use and charge only specified Icom battery packs with Icom transceivers or Icom chargers. Only Icom battery packs are tested and approved for use with Icom transceivers or charged with Icom chargers. Using third-party or counterfeit battery packs or chargers may cause smoke, fire, or cause the battery to burst.

⚠ **WARNING! NEVER** hold the transceiver so that the antenna is very close to, or touching exposed parts of the body, especially the face or eyes, while transmitting.

⚠ **WARNING! NEVER** operate the transceiver with a headset or other audio accessories at high volume levels. Hearing experts advise against continuous high volume operation. If you experience a ringing in your ears, reduce the volume level or discontinue use.

⚠ **WARNING! NEVER** operate the transceiver near unshielded electrical blasting caps or in an explosive atmosphere.

**CAUTION: DO NOT** use harsh solvents such as Benzine or alcohol to clean the transceiver, because they can damage the transceiver's surfaces.

**DO NOT** place the transceiver in direct sunlight or in areas with temperatures below  $-10^{\circ}\text{C}$  ( $+14^{\circ}\text{F}$ ) or above  $+60^{\circ}\text{C}$  ( $+140^{\circ}\text{F}$ ).

**KEEP** the transceiver in a secure place to prevent use by unauthorized persons.

**KEEP** the transceiver away from the heavy rain, and **NEVER** immerse it in the water. The transceiver construction is water resistant, not waterproof.

**CLEAN** and wipe dry the battery terminals after using the transceiver in wet conditions. The terminals may rust if not dried before using.

Icom is not responsible for the destruction or damage to the Icom transceiver, if the malfunction is because of:

- Force majeure, including, but not limited to, fires, earthquakes, storms, floods, lightning, other natural disasters, disturbances, riots, war, or radioactive contamination.
- The use of Icom transceivers with any equipment that is not manufactured or approved by Icom.

Icom, Icom Inc. and the Icom logo are registered trademarks of Icom Incorporated (Japan) in Japan, the United States, the United Kingdom, Germany, France, Spain, Russia, Australia, New Zealand, and/or other countries.

---

## FCC INFORMATION

---

• **FOR CLASS A UNINTENTIONAL RADIATORS:**

This equipment has been tested and found to comply with the limits for a Class A digital device, pursuant to part 15 of the FCC Rules. These limits are designed to provide reasonable protection against harmful interference when the equipment is operated in a commercial environment. This equipment generates, uses and can radiate radio frequency energy and, if not installed and used in accordance with the instruction manual, may cause harmful interference to radio communications. Operation of this equipment in a residential area is likely to cause harmful interference in which case the user will be required to correct the interference at his own expense.

**CAUTION:** Changes or modifications to this transceiver, not expressly approved by Icom Inc., could void your authority to operate this transceiver under FCC regulations.

---

# TABLE OF CONTENTS

---

PREFACE .....	i	5. SCAN OPERATION .....	18–20
IMPORTANT .....	i	■ Scan types .....	18
EXPLICIT DEFINITIONS .....	i	■ COM band scan .....	18
SUPPLIED ACCESSORIES .....	i	■ Memory scan .....	19
PRECAUTIONS .....	ii	■ Weather channel scan (Available with the IC-A14 only) .....	19
FCC INFORMATION .....	iii	■ “TAG” channel setting .....	20
1. PANEL DESCRIPTION .....	1–5	6. OTHER FUNCTIONS .....	21–26
■ Panel description .....	1	■ Home function .....	21
■ Function display .....	5	■ Accessing the 121.5 MHz emergency frequency (Selectable on only the IC-A14) .....	21
2. ACCESSORY ATTACHMENT .....	6–7	■ Key touch beep tone .....	22
3. BASIC OPERATION .....	8–11	■ ANL function .....	22
■ Setting a frequency .....	8	■ Weather channel operation (Available with the IC-A14 only) .....	23
■ Setting the squelch level .....	9	■ Duplex operation (Available with the IC-A14 only) .....	24
■ Lock function .....	9	■ Set mode setting .....	25
■ Receiving .....	10	7. BATTERY PACKS AND CASE .....	27–33
■ Transmitting .....	10	■ Battery charging .....	27
■ Side tone function .....	11	■ Charging the battery .....	29
■ LCD backlight .....	11	■ Battery case (optional for some versions) .....	31
■ Low battery indicator .....	11	8. CLONING .....	34–35
4. MEMORY OPERATION .....	12–17	9. TROUBLESHOOTING .....	36
■ Memory channel selection .....	12	10. SPECIFICATIONS .....	37
■ Memory bank selection (Available with the IC-A14 only) .....	12	11. OPTIONS .....	38
■ Entering a memory channel .....	13	12. OPTIONAL HEADSET CONNECTION .....	39
■ Memory names .....	15	13. SAFETY TRAINING INFORMATION .....	40–41
■ Copying memory contents .....	16		
■ Clearing the memory contents (Available with the IC-A14 only) .....	17		

# 1

## PANEL DESCRIPTION

### ■ Panel description

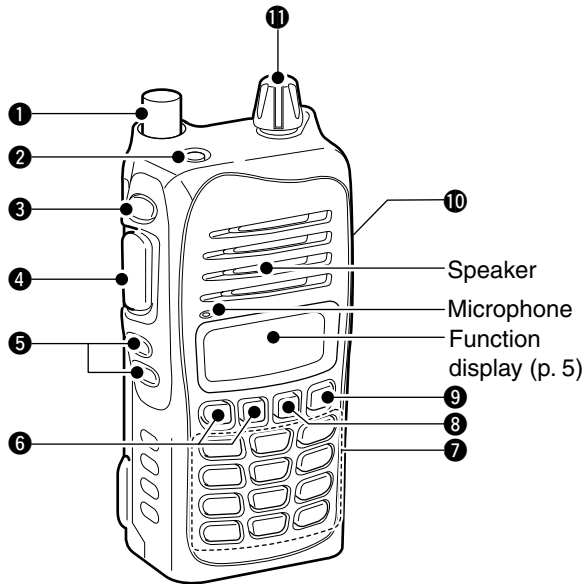

- 1 ANTENNA CONNECTOR [ANT]** (p. 6)  
Connects to the supplied antenna.
- 2 KEY LOCK SWITCH [ ]** (p. 9)
  - Push to turn ON the key lock function.
  - Hold down for 2 seconds to turn OFF the key lock function.
- 3 LIGHT SWITCH [LIGHT]**  
Push to toggle the LCD backlight ON or OFF. (p. 11)  
**For the IC-A14S only**  
In the memory mode, hold down for 2 seconds to turn the "TAG" setting ON or OFF. (p. 20)
- 4 PTT SWITCH [PTT]**  
Hold down to transmit, release to receive.
- 5 SQUELCH UP/DOWN KEYS [SQL▲]/[SQL▼]** (p. 9)  
Push either key to select the squelch level.
  - 10 squelch levels, 1–10, and squelch open, 0, are selectable.
- 6 UP/DOWN KEYS [▲]/[▼]**
  - Push to change or select the operating frequency, memory channel, Set mode setting, and so on. (p. 8)
  - While scanning, push to change the scanning direction. (pp. 18, 19)**For the IC-A14S only**  
Hold down for 1 second to start scanning. (pp. 18, 19)

**7 KEYPAD** (Available with only the IC-A14) (pp. 3, 4)

**8 MEMORY MODE/MEMORY WRITE KEY [MR]/[MW]**

Push to select the memory mode. (p. 12)

**For the IC-A14**

- ➔ Push [**FUNC**], then push this key to enter the select memory write mode. (p. 13)
- ➔ In the memory mode, push [**FUNC**] then push this key to copy the memory content to the frequency mode. (p. 16)

**For the IC-A14S**

- ➔ Hold down for 1 second to enter the select memory write mode. (p. 14)
- ➔ In the memory mode, hold down for 1 second to copy the memory content to the frequency mode. (p. 16)

**9 CLEAR/HOME SWITCH [CLR]/[HOME]**

- ➔ Push to select the frequency mode. (p. 8)
- ➔ Hold down for 2 seconds to reset the transceiver to the user-default state without changing the memory contents (Home function). (p. 21)

**10 EXTERNAL SPEAKER AND MICROPHONE JACKS [MIC/SP]** (p. 39)

If desired, connects the optional speaker microphone or a headset using the optional OPC-499 HEADSET ADAPTER.



Jack cover

**NOTE:** Attach the jack cover when optional equipment is not used.

**NEVER** connect an optional speaker-microphone, headset adapter, while the transceiver power is ON.

**11 VOLUME CONTROL KNOB [VOL]**

Rotate to turn the transceiver power ON or OFF and adjust the audio level.

# 1 PANEL DESCRIPTION

## ◇ **KEYPAD** (Available with IC-A14 only)

- 1 ANL** ➔ Inputs digit “1” for frequency entry or memory channel selection. (pp. 8, 12)
  - ➔ Inputs “1,” “Q,” or “Z” when entering memory names. (p. 15)
  - ➔ After pushing **[FUNC]**, turns the ANL (Automatic Noise Limiter) function ON or OFF. (p. 22)
- 2 SCAN** ➔ Inputs digit “2” for frequency entry or memory channel selection. (pp. 8, 12)
  - ➔ Inputs “2,” “A,” “B,” or “C” when entering memory names. (p. 15)
  - ➔ After pushing **[FUNC]**, the scan starts. (pp. 18, 19)
- 3 BANK** ➔ Inputs digit “3” for frequency entry or memory channel selection. (pp. 8, 12)
  - ➔ Inputs “3,” “D,” “E,” or “F” when entering memory names. (p. 15)
  - ➔ After pushing **[FUNC]**, selects memory bank mode, in the memory mode. (p. 12)
- 4 WX-ALT** ➔ Inputs digit “4” for frequency entry or memory channel selection. (pp. 8, 12)
  - ➔ Inputs “4,” “G,” “H,” or “I” when entering memory names. (p. 15)
  - ➔ After pushing **[FUNC]**, turns the weather alert function ON or OFF. (p. 23)
- 5 DUP-W** ➔ Inputs digit “5” for frequency entry or memory channel selection. (pp. 8, 12)
  - ➔ Inputs “5,” “J,” “K,” or “L” when entering memory names. (p. 15)
  - ➔ After pushing **[FUNC]**, enters duplex transmit frequency entry mode during NAVI band operation. (p. 24)
- 6 DUP** ➔ Inputs digit “6” for frequency entry or memory channel selection. (pp. 8, 12)
  - ➔ Inputs “6,” “M,” “N,” or “O” when entering memory names. (p. 15)
  - ➔ After pushing **[FUNC]**, selects duplex operation during NAVI band operation. (p. 24)
- 7 WX** ➔ Inputs digit “7” for frequency entry or memory channel selection. (pp. 8, 12)
  - ➔ Inputs “7,” “P,” “R,” or “S” when entering memory names. (p. 15)
  - ➔ After pushing **[FUNC]**, selects weather channel mode. (p. 23)
- 8 BEEP** ➔ Inputs digit “8” for frequency entry or memory channel selection. (pp. 8, 12)
  - ➔ Inputs “8,” “T,” “U,” or “V” when entering memory names. (p. 15)
  - ➔ After pushing **[FUNC]**, key touch beep output ON or OFF. (p. 22)



- 9 TAG** ➔ Inputs digit “9” for frequency entry or memory channel selection. (pp. 8, 12)
  - ➔ Inputs “9,” “W,” “X,” or “Y” when entering memory names. (p. 15)
  - ➔ After pushing **[FUNC]**, toggles scan tag setting ON or OFF. (p. 20)
- 0 121.5** ➔ Inputs digit “0” for frequency entry or memory channel selection. (pp. 8, 12)
  - ➔ Inputs “0,” “space” or “\_” when entering memory names. (p. 15)
  - ➔ After pushing **[FUNC]**, selects the emergency frequency, 121.500 MHz. (p. 21)
- ENTSET** ➔ Sets the numeral entry for frequency or memory channel numbers. Enters consecutive zero into the remaining digits. (pp. 8, 12)
  - ➔ After pushing **[FUNC]**, hold down for 1 second to entering into set mode. (p. 25)
- FUNC** ➔ Push to activate the function, then push another key to access its secondary function. When the function is activated, the “**F**” icon appears.

# 1 PANEL DESCRIPTION

## ■ Function display

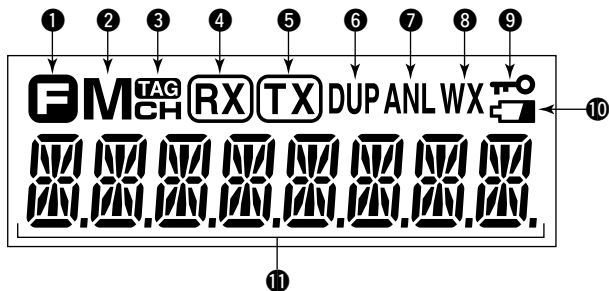

### 1 FUNCTION ICON

Appears when [FUNC] is pushed.

### 2 MEMORY ICON (p. 12)

Appears when memory channel mode is selected.

### 3 TAG ICON (p. 20)

Appears when the selected memory channel is set as a TAG channel.

### 4 RX ICON (p. 10)

Appears while receiving a signal, or when the squelch is open.

### 5 TX ICON (p. 10)

Appears while transmitting.

### 6 DUPLEX ICON (IC-A14 only) (p. 24)

- Appears when the duplex function is activated.
- Blinks while setting the duplex frequency.

### 7 ANL ICON (p. 22)

Appears when the ANL (Automatic Noise Limiter) function is in use.

### 8 WEATHER ALERT ICON (IC-A14 only) (p. 23)

Appears when the weather alert function is in use.

### 9 LOCK ICON (p. 9)

Appears when the lock function is in use.

### 10 LOW BATTERY ICON (p. 11)

- Appears when the battery is nearing exhaustion. The attached battery pack requires recharging when this icon appears.
- Blinks when battery recharging/replacing is immediately needed.

### 11 FREQUENCY READOUT

Displays the operating frequency, memory channel number, memory name or the Set mode item, and so on, depending on the selected mode.

## ◇ Antenna

Insert the supplied antenna into the antenna connector and screw down the antenna, as shown to the right.

### CAUTION!

- **NEVER** carry the transceiver by holding only the antenna.
- **DO NOT** transmit without an antenna. Otherwise the transceiver may be damaged.

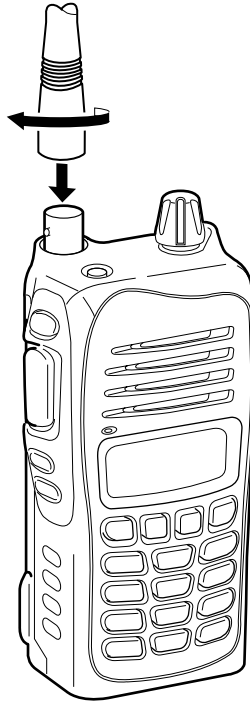

## ◇ Belt clip

Conveniently attaches to your belt.

### - To attach the belt clip

- ① Remove the battery pack if it is attached.
- ② Slide the belt clip in the direction of the arrow until the belt clip is locked and makes a 'click' sound.

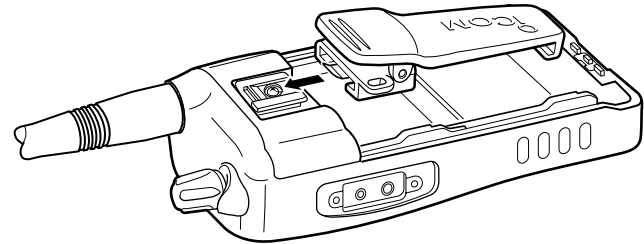

### - To detach the belt clip

- ① Remove the battery pack if it is attached.
- ② Pinch the clip (1), and slide the belt clip in the direction of the arrow (2).

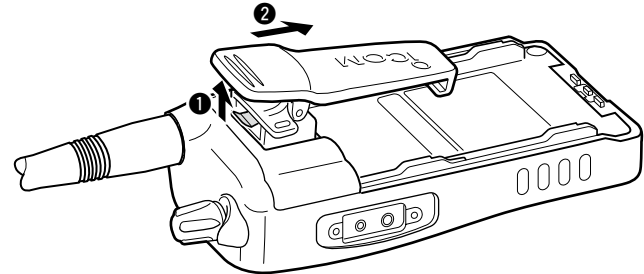

## 2 ACCESSORY ATTACHMENT

### ◇ Battery pack attachment

Turn OFF the transceiver power by rotating [VOL] before attaching or detaching the battery pack.

#### **To attach the battery pack:**

Slide the battery pack in the direction of the arrow (❶), then lock it with the battery release button.

- Slide the battery pack until the battery release button makes a 'click' sound.

#### **To detach the battery pack:**

Slide the battery release button in the direction of the arrow (❷) as shown in the illustration to the right. The battery pack can then be detached.

**NEVER** release or attach the battery pack when the transceiver is wet or soiled. This may result water or dust getting into the transceiver/battery pack and may result in the transceiver being damaged.

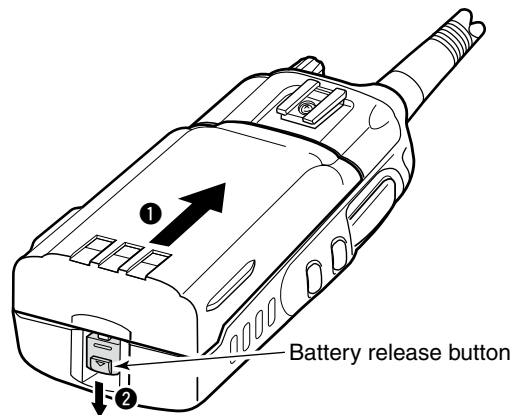

#### **For your information**

If the transceiver power cannot be turned ON after replacing the fully charged battery pack, first detach the battery pack. Wait for approximately 10 seconds, then attach the battery pack and turn ON the power again.

## ■ Setting a frequency

### ◇ Using the [▲]/[▼] keys

- ① Rotate [VOL] to turn ON power, then push [CLR] to select the frequency mode if a memory CH number or WX CH number appears on the function display.
- ② Push [▲]/[▼] to set the desired frequency.
  - For the IC-A14 only -
    - The 1 MHz tuning step is selectable. Push [FUNC], then push [▲]/[▼]. Push [FUNC] again to return to normal tuning.

### ◇ Using keypad (IC-A14 only)

- ① Rotate [VOL] to turn ON power, then push [CLR] to select the frequency mode if a memory CH number or WX CH number appears on the function display.
- ② Push 5 appropriate digit keys to input the frequency.
  - Push [1] as the 1st digit.
  - When a wrong digit is input, push [CLR] to clear, then repeat step ② again.
  - Push [ENT] to enter consecutive zero digits.
  - Only [2], [5], [7] or [0] can be entered as the 5th and final digit.

#### [EXAMPLE]

- 111.225 MHz: Push [1], [1], [1], [2], [2]
- 117.250 MHz: Push [1], [1], [7], [2], [5]
- 120.000 MHz: Push [1], [2], [ENT]
- 125.300 MHz: Push [1], [2], [5], [3], [ENT]

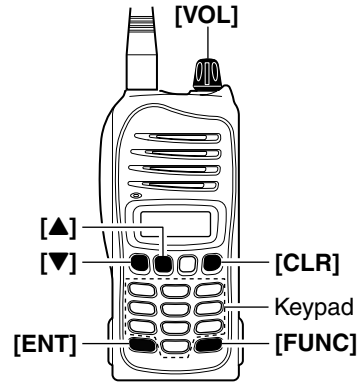

### 3 BASIC OPERATION

#### ■ Setting the squelch level

The transceiver has a noise squelch circuit to mute undesired noise when no signal is received.

- ① Push **[SQL▲]** or **[SQL▼]** to select the squelch level.
  - ‘SQL--0’ is open squelch and ‘SQL--10’ is tight squelch.
  - The “**RX**” icon appears while the squelch is open.
- ② Wait for 1 second to return to the previous display.

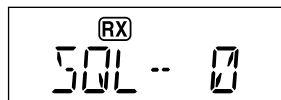

“SQL-- 0” (Squelch open)

#### ■ Lock function

The lock function prevents accidental frequency changes or accidental function activation.

- ① Push **[T-O]** to turn ON the lock function.
  - The “**T-O**” icon appears.
- ② To turn OFF the function, hold down **[T-O]** for 2 seconds.
  - The “**T-O**” icon disappears.



Appears while the key lock function is activated.

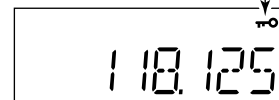

## Receiving

- ① Rotate [VOL] to turn ON the power.
- ② Push [SQL▼] several times to open the squelch.
  - Select the squelch level 0.
- ③ Rotate [VOL] to adjust the audio level.
- ④ Push [SQL▲] several times until the noise is muted.
  - The “RX” icon disappears.
- ⑤ Set the desired frequency using [▲]/[▼] keys or the keypad keys.
- ⑥ When a signal is received on the set frequency:
  - The “RX” icon appears.
  - Squelch opens and audio is emitted from the speaker.

Appears when a signal is received.



When the squelch setting is too “tight” (large number setting), squelch may not open for weak signals. To receive weaker signals, loosen (small number setting) the squelch.

## Transmitting

**NOTE:** To prevent interference, listen on the frequency before transmitting. If the frequency is busy, wait until it is clear.

**CAUTION:** Transmitting without an antenna may damage the transceiver.

- ① Set the desired frequency in COM band pushing [▲]/[▼] or the keypad keys (IC-A14 only).
  - COM band frequency range: 118.00–136.975 MHz
- ② Hold down [PTT] to transmit.
  - The “TX” icon appears.
- ③ Speak into the microphone at a normal voice level.
  - **DO NOT** hold the transceiver too close to your mouth or speak too loudly. This may distort the signal.
- ④ Release [PTT] to receive.

### NOTE: About Time-Out-Timer function

To prevent prolonged transmission, according to regulatory requirements, the IC-A14/S has a Time-Out Timer function. This timer cuts OFF transmission after the set time period of continuous transmission. The Time-Out Timer is set in the Set mode. See page 26 for details.

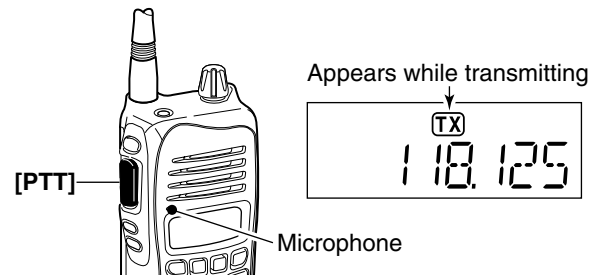

### 3 BASIC OPERATION

#### ■ Side tone function

When using a headset (user supplied), the transceiver outputs your transmitted voice to the headset for monitoring. Connect an optional headset to use this function (The OPC-499 HEADSET ADAPTER and headset are required). (p. 39)

##### ◇ Setting the side tone level

- ① Push [PTT] to turn ON the transmit mode.
- ② While transmitting, push [▲]/[▼] to adjust the level.
  - 'ST-0' is OFF and 'ST-10' is the maximum level.



Side tone level is indicated

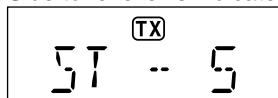

##### **IMPORTANT!**

Select 'ST-0' when a speaker microphone is connected, otherwise your voice will be heard from the speaker during transmit.

**WARNING!** NEVER operate the transceiver with a headset at high volume or monitor levels for a long periods time. If a ringing in your ears occurs, reduce the volume or monitor level, or discontinue use.

#### ■ LCD backlight

The IC-A14/S has an LCD backlight for convenience during night time operation.

- Push [LIGHT] to turn the LCD backlight ON or OFF.

##### **IMPORTANT!**

Turn OFF the LCD backlight when no backlight is necessary.

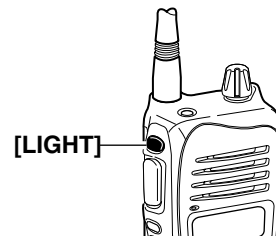

#### ■ Low battery icon

The low battery icon appears or blinks when the battery power has decreased to a specified level. The attached battery pack or battery case requires recharging or the battery case cells need replacing.

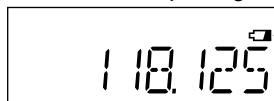

Appears when the battery is nearly exhausted. Blinks when the battery recharging or replacing is immediately necessary.

If the batteries are not charging or replaced, even when the low battery indicator blinks, a long beep sounds and then the transceiver will automatically turn OFF.



## Memory channel selection

The IC-A14 has 200 memory channels (20 channels in 10 banks, default setting) and the IC-A14S has 100 memory channels for storing often-used frequencies.

- ① Push **[MR]** to enter the memory mode.
  - The memory mode icon appears and a memory channel number is briefly displayed.
  - The memory bank number is also displayed on the IC-A14.

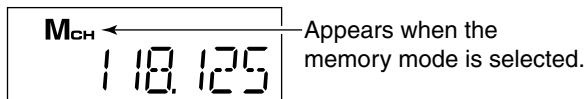

### Using **[▲]/[▼]**:

- ② Push **[▲]/[▼]** to select the desired memory CH number.
  - The memory channel number is briefly displayed, then the entered frequency (or memory name, if entered) is displayed.
  - If no memory channel is entered, no memory channel can be selected.

### Using the Keypad— IC-A14 only:

- ② Push 2 appropriate digit key (00 to 99, depending on the bank setting) to select the desired memory channel number, then push **[ENT]**.
  - The memory channel number is briefly displayed, then the entered frequency (or memory name, if entered) is displayed.
  - If no memory channel is entered in the selected BANK, no memory channel can be selected.

## Memory bank selection

(Available with the IC-A14 only)

A total of 200 memory channels in the IC-A14, are divided into bank (up to 10 banks are selectable, depending on the setting) for simple memory grouping.

- ① Push **[MR]** to select the memory mode.
- ② Push **[FUNC]**, and push **[BANK](3)** to enter the bank selection mode.

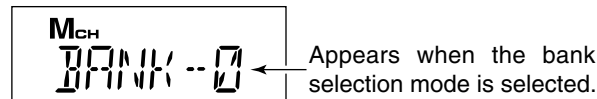

- ③ Push **[▲]/[▼]** or an appropriate digit key (**[0]** to **[9]**) to select a memory BANK number, then push **[ENT]**.
- ④ Push **[▲]/[▼]**, or 2 appropriate digit keys and then **[ENT]** to select a memory channel.

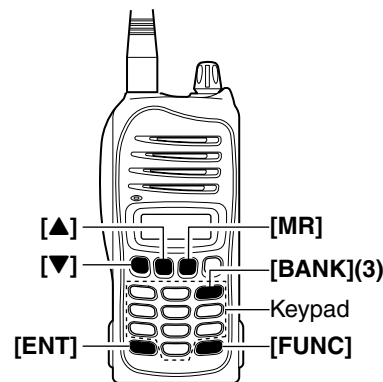

## 4 MEMORY OPERATION

### ■ Entering a memory channel

Enter often-used frequencies using the following instructions.

#### ◇ For the IC-A14

- 1 Push **[CLR]** to select the frequency mode, if necessary.
- 2 Set the desired frequency. (p. 8)
  - Push **[FUNC]**, then push **[WX](7)** to select a weather channel mode, and then select the desired weather channel using **[▲]/[▼]** or keypad if desired. (p. 23)
- 3 Push **[FUNC]**, then push **[MW](MR)** to enter the select memory write mode.
  - The memory mode icon blinks.

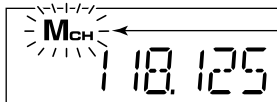

Blinks when the select memory write mode is selected.

No frequency is displayed when a blank channel is selected.

- 4 Push **[▲]/[▼]** to select a memory channel number.
  - Push **[FUNC]**, then push **[BANK](3)** to enter the bank selection mode, and push **[▲]/[▼]** or an appropriate digit keys (**[0]–[9]**), then push **[ENT]** to select the BANK number, if desired.
- 5 Push **[ENT]** to program the entry and return to the frequency mode.

- **EXAMPLE:** Entering WX-05 into memory channel 9 in memory BANK 3.

Push **[CLR HOME]**

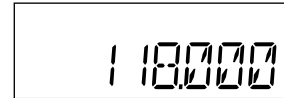

Push **[FUNC]** then **[7 WX]**

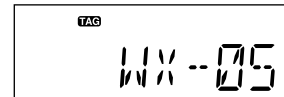

Push **[▼]** or **[▲]**,

or, push **[5 DUP-W] [ENTSET]**

Push **[FUNC]** then **[MR MW]**



Push **[FUNC]** then **[3 BANK]**

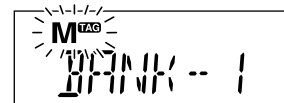

Push **[3 BANK]** then **[ENTSET]**

\*Briefly appears.

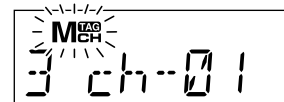

Push **[▼]** or **[▲]**,

or, push **[9 TAG] [ENTSET]**

\*Briefly appears.

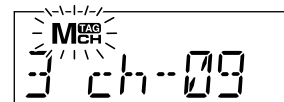

Push **[ENTSET]** to complete the entry.

### ◇ For the IC-A14S

- ① Push **[CLR]** to select the frequency mode, if necessary.
- ② Set the desired frequency. (p. 8)
- ③ Hold down **[MR]** for 1 second to enter the select memory write mode.
  - The memory mode icon blinks.

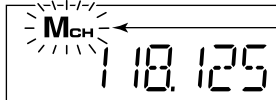

Blinks when the select memory write mode is selected.

No frequency is displayed when a blank channel is selected.

- ④ Push **[▲]/[▼]** to select the desired memory channel number.
- ⑤ Hold down **[MR]** for 1 second to set the entry and return to the frequency mode.

- **EXAMPLE:** Entering 123.450 MHz into memory channel 51.

Push <b>[CLR]</b>	
Push <b>[▼]</b> or <b>[▲]</b>	
Hold down <b>[MR]</b> for 1 second.	
Push <b>[▼]</b> or <b>[▲]</b> *Briefly appears.	
Hold down <b>[MR]</b> for 1 second.	

## 4 MEMORY OPERATION

### ■ Memory names

The memory channel can display an 8 character name instead of the entered frequency.

#### ◇ Entering memory names

- ① Set the desired frequency in the frequency mode. (p. 8)
- ② Enter the select memory write mode.
  - For the IC-A14, push **[FUNC]** then push **[MW](MR)**.
  - For the IC-A14S, hold down **[MR]** for 1 second.
- ③ Select the desired memory channel to be entered by pushing **[▲]/[▼]** (or on only the IC-A14, push the keys on the keypad then **[ENT]**).
- ④ Push **[MR]** momentarily to enter the memory name entry mode.
  - “-----” appears and 1st digits blink.

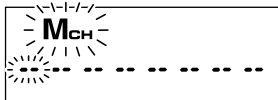

#### • Available characters

KEY	CHARACTER	KEY	CHARACTER
[1]	1, Q, Z	[6]	6, M, N, O,
[2]	2, A, B, C	[7]	7, P, R, S
[3]	3, D, E, F	[8]	8, T, U, V
[4]	4, G, H, I	[9]	9, W, X, Y
[5]	5, J, K, L	[0]	0, _ (space), -

#### *For the IC-A14*

- ⑤ Push the appropriate digit key several times to select the desired character, as shown to the left.
  - To move the cursor forwards or backwards, use **[▲]/[▼]**.
  - The cursor automatically moves forward when a different key is pushed.
  - To erase a character, overwrite with a space (displayed as “\_”).
- ⑥ Push **[ENT]** to enter the name and frequency at the same time.
  - Return to the frequency display.
  - If no name is entered, the entered frequency is displayed.
  - To clear the entered memory names, push **[CLR]** before pushing **[ENT]**.

#### *For the IC-A14S*

- ⑤ Push **[▲]/[▼]** several times to select the desired character.
  - To move the cursor forwards, push **[MR]**.
  - To erase a character, overwrite with a space (displayed as “\_”).
- ⑥ Hold down **[MR]** for 1 second to enter the name and frequency at the same time.
  - Return to the frequency display.
  - If no name is entered, the entered frequency is displayed.
  - To clear the entered memory names, push **[CLR]** before holding down **[MR]** for 1 second.

**NOTE:** When entering a memory name to the programmed memory channel, operate as follow.

- ① Select the desired memory channel that requires a name. (see p. 12).

#### **For the IC-A14**

- ② Push **[FUNC]**, then push **[MW](MR)**.
  - The selected memory contents copied into frequency mode and frequency mode is selected automatically.
- ③ Push **[FUNC]**, then push **[MW](MR)** again.
- ④ Push **[MR]** momentarily to select memory name entry mode.
- ⑤ Perform the steps ⑤ and ⑥ described at left page in “**For the IC-A14**” to enter the desired memory name.

#### **For the IC-A14S**

- ② Hold down **[MR]** for 1 second.
  - The selected memory contents copied into frequency mode and frequency mode is selected automatically.
- ③ Hold down **[MR]** for 1 second again.
- ④ Push **[MR]** momentarily to select memory name entry mode.
- ⑤ Perform the steps ⑤ and ⑥ described at left page in “**For the IC-A14S**” to enter the desired memory name.

## ■ Copying memory contents

This function copies a memory channel’s contents into the frequency mode. This is useful when searching for signals around a memory channel’s frequency.

- ① Push **[MR]** to select the memory mode.
- ② Select the desired memory channel to be copied using **[▲]/[▼]** (or keypad and **[ENT]**, For the IC-A14 only).
  - Select the desired bank if desired.

#### **For the IC-A14**

- ③ Push **[FUNC]**, then push **[MW](MR)** to copy the memory channel’s contents into the frequency mode.
  - Frequency mode is automatically selected.

#### **For the IC-A14S**

- ③ Hold down **[MR]** for 1 second to copy the memory channel’s contents into the frequency mode.
  - Frequency mode is automatically selected.

### ■ Clearing the memory contents

(Available with the IC-A14 only)

Unwanted memory channels can be cleared.

- ① Select the desired memory channel to be cleared. (p. 12)
  - Select the desired bank if desired. (p. 12)
- ② Push **[FUNC]**, then hold down **[CLR]** for 1 second.
  - “-----” appears briefly, then the next selectable channel appears.

## Scan types

The IC-A14 has 3 scan types to suit your needs. IC-A14S has 2 scan types.

### COM BAND SCAN

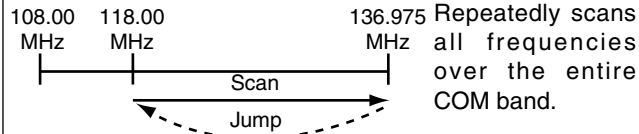

### MEMORY SCAN

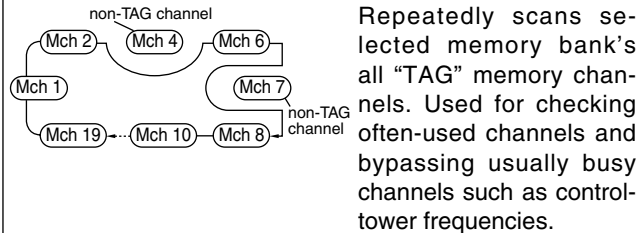

### WEATHER CHANNEL SCAN

Repeatedly scans all "TAG" weather channels. Weather channels are available for the IC-A14 only.

## COM band scan

- ① Push **[CLR]** to select the frequency mode.
- ② Push **[SQL▲]/[SQL▼]** to set the squelch level to the point where noise just disappears.

### For the IC-A14

- ③ Push **[FUNC]**, then push **[SCAN](2)** to start the scan.
  - When a signal is received, the scan pauses until the signal disappears.
  - To change the scanning direction, push **[▲]/[▼]**.

### For the IC-A14S

- ③ Hold down **[▲]/[▼]** for 1 second to start the scan.
  - When a signal is received, the scan pauses until the signal disappears.
  - To change the scanning direction, push **[▲]/[▼]**.
- ④ To stop the scan, push **[CLR]**.



Decimal point blinks during a scan.

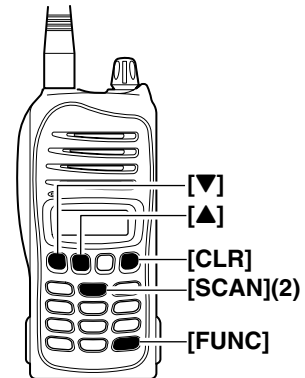

## 5 SCAN OPERATION

### Memory scan

**NOTE:** Program 2 or more memory channels with a “TAG” setting to start a memory scan.

- 1 Push **[MR]** to enter the memory mode.
  - For the IC-A14, select the desired BANK if desired. (p. 12)
- 2 Push **[SQL▲]/[SQL▼]** to set the squelch level to the point where noise just disappears.

#### For the IC-A14

- 3 Push **[FUNC]**, then push **[SCAN] (2)** to start the scan.
  - When a signal is received, the scan pauses until the signal disappears.
  - To change the scanning direction, push **[▲]/[▼]**.

#### For the IC-A14S

- 3 Hold down **[▲]/[▼]** for 1 second to start the scan.
  - When a signal is received, the scan pauses until the signal disappears.
  - To change the scanning direction, push **[▲]/[▼]**.
- 4 To stop the scan, push **[CLR]**.

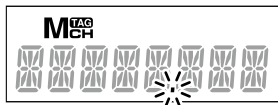

Decimal point blinks during a scan.

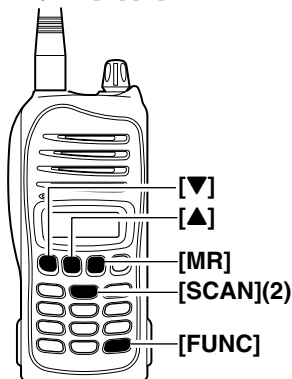

### Weather channel scan

(Available with the IC-A14 only)

- 1 Push **[FUNC]**, then push **[WX](7)** to enter the weather channel mode.
- 2 Set squelch to the point where noise just disappears with **[SQL▲]/[SQL▼]**.
- 3 Push **[FUNC]**, then push **[SCAN] (2)** to start the scan.
  - When a signal is received, the scan pauses until it disappears.
  - To change the scanning direction, push **[▲]/[▼]**.
- 4 To stop the scan, push **[CLR]**.

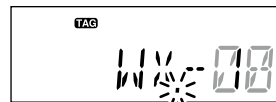

Decimal point blinks during a scan.

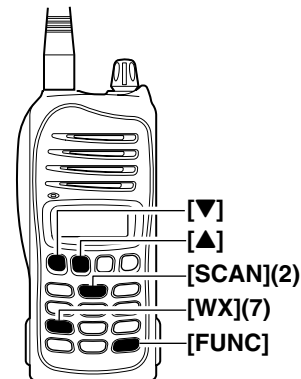



## ■ “TAG” channel setting

Memory and weather channels\* can be specified to be skipped for the memory and weather channel\* scans respectively. The “TAG” channel function is only selectable in the scan mode.  
\*For the IC-A14 only

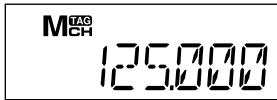

The “TAG” icon appears with the scanned channel.

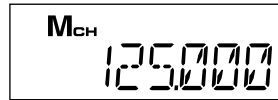

No “TAG” icon appears with the skipped channel.

### For the IC-A14

- ① Push **[MR]** to enter the memory mode, or push **[FUNC]**, then push **[WX](7)** to select a weather channel.
  - Select the desired BANK, if desired.
- ② Select the desired memory/weather channel to be a “TAG” channel.
  - Select the desired BANK, if desired.
- ③ Push **[FUNC]**, then push **[TAG](9)** to set a “TAG.”
  - “TAG” appears.
  - Non-“TAG” channels are skipped during scan.
- ④ To cancel the “TAG” setting, repeat above steps.

### For the IC-A14S

- ① Push **[MR]** to select the memory mode.
- ② Select the desired memory channel to be a “TAG” channel.
- ③ Hold down **[LIGHT]** for 2 seconds to set a “TAG.”
- ④ To cancel the “TAG” setting, repeat the above steps.

## ■ Home function

The Home function is convenient if you want to return the transceiver to default settings without memory channels. The following transceiver's settings will return to the default value.

- Operating mode (Frequency, memory or weather\* channel mode with frequency or channel number, including bank\*)
- Duplex setting • ANL setting • Key touch beep
- Squelch level • Side tone level • Microphone gain
- Internal microphone usage • Time-Out timer setting

The default settings can be modified to suits your preference using with the optional cloning software, CS-A14.

- ➔ Hold down **[CLR]** for 2 seconds to return the transceiver into the default setting.

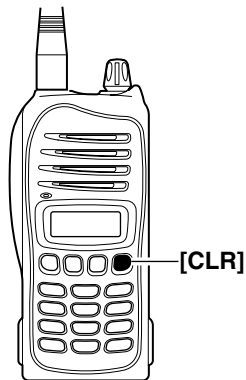

## ■ Accessing the 121.5 MHz emergency frequency

(Selectable on only the IC-A14)

The IC-A14 can quickly be set to the 121.5 MHz emergency frequency. This function can be activated even when the key lock function is in use.

- ① Push **[FUNC]**, then **[121.5](0)** to call the emergency frequency.
- ② Push **[CLR]** to return to the frequency mode.

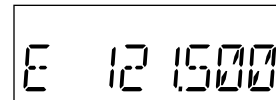

Emergency initial, "E," appears with the frequency.



\*For only the IC-A14

## ■ Key touch beep tone

The beep tone, which sounds at the push of a switch can be set, if desired.

### For the IC-A14

- Push **[FUNC]**, then push **[BEEP](8)** to turn the key touch beep tone ON or OFF.
  - The Key touch beep setting is briefly displayed.

### For the IC-A14S

- ① Rotate **[VOL]** to turn the transceiver power OFF.
- ② While holding down **[▲]/[▼]**, rotate **[VOL]** to enter the set mode.
- ③ Push **[MR]** several times to select the key touch beep item, "BEEP."
- ④ Push **[▲]/[▼]** to select either ON or OFF.
- ⑤ Push **[CLR]** to return to the frequency mode.

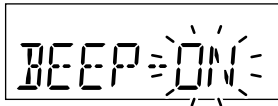

## ■ ANL function

The ANL (Automatic Noise Limiter) function reduces noise components on received signals, such as those caused by engine ignition systems.

### For the IC-A14

- Push **[FUNC]**, then push **[ANL](1)** to turn the ANL function ON or OFF.
  - The "ANL" icon appears when the ANL function is ON.

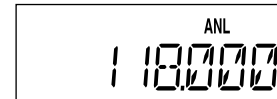

The "ANL" indicator appears when the ANL function is ON.

### For the IC-A14S

- ① Rotate **[VOL]** to turn the transceiver power OFF.
- ② While holding down **[▲]/[▼]**, rotate **[VOL]** to enter the Set mode.
- ③ Push **[MR]** several times to select the ANL item, "ANL."
- ④ Push **[▲]/[▼]** to select either ON or OFF.
  - The "ANL" icon appears when the ANL function is ON.
- ⑤ Push **[CLR]** to return to the frequency mode.

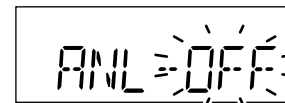

### ■ Weather channel operation

(Selectable on only the IC-A14)

The IC-A14 has VHF marine WX (weather) channel receiving capability for flight planning.

#### ◇ Weather channel selection

- ① Push **[FUNC]**, then push **[WX](7)** to select the WX channel mode.
  - “WX--” and the previously selected WX channel number appears.
- ② Push **[▲]/[▼]** to select the desired WX channel.
- ③ Push **[CLR]** to exit the WX channel mode and return to the frequency mode.

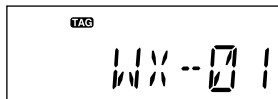

Weather channel appears.



#### ◇ Setting weather alert function

An NOAA broadcast station transmits a weather alert tone before any important weather announcements. When the weather alert function is turned ON, the transceiver detects the alert, and sounds a beep tone until the transceiver is operated. The previously selected (used) weather channel is checked any time during standby, or while scanning.

- ➔ Push **[FUNC]**, then push **[WX-ALT](4)** to turn the weather alert function ON or OFF.

- The “WX” icon appears when the weather alert function is ON.

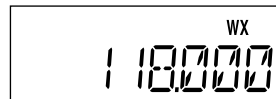

The “WX” icon appears when the weather alert is ON.



## ■ Duplex operation (Selectable on only the IC-A14)

The duplex function allows you to call a flight service station while receiving a VOR station. The duplex function requires that you first enter the frequency entry of the flight service station.

### ◇ Entering a duplex frequency

- ① Push **[CLR]** to select the frequency mode.
- ② Set a NAVI band frequency using **[▲]/[▼]** or the keypad.
  - NAVI band frequency range: 108.00–117.975 MHz
- ③ Push **[FUNC]**, then push **[DUP-W](5)**.
  - The “DUP” icon blinks and the transmit frequency is displayed.
- ④ Set the desired flight service station frequency using **[▲]/[▼]** or keypad, then push **[ENT]**.
  - The displayed frequency returns to the NAVI band frequency.

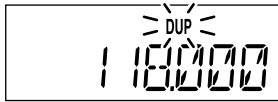

The “DUP” indicator blinks while setting the transmit frequency.

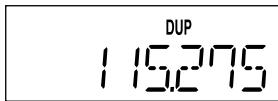

“DUP” appears while in the duplex mode.

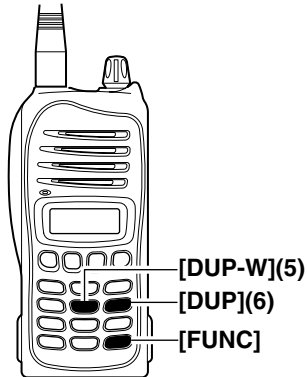

### ◇ Using the duplex function

- ① Set the desired frequency in the NAVI band.
  - NAVI band frequency range: 108.00–117.975 MHz
- ② Push **[FUNC]**, then push **[DUP](6)** to turn the duplex function ON.
  - The “DUP” icon appears.
- ③ Hold down **[PTT]** to transmit on the pre-entered transmit frequency.
- ④ Release **[PTT]** to return to receive.
- ⑤ Push **[FUNC]**, then push **[DUP](6)** to cancel the function.
  - The “DUP” icon disappears.

**NOTE:** A duplex frequency can be entered into each memory channel independently. Set a duplex frequency before entering the memory channel, if desired. The duplex ON/OFF setting can also be entered into a memory channel.

## 6 OTHER FUNCTIONS

### ■ Set mode setting

The Set mode is used to enter infrequently changed function items or options.

#### ◇ Entering the Set mode

- ① Rotate **[VOL]** to turn the transceiver power OFF.
- ② While holding down **[▲]** and **[▼]**, rotate **[VOL]** to turn ON power and enter the Set mode.
- ③ Push **[MR]** several times to select the desired Set mode item.
- ④ Push **[▲]**/**[▼]** to select the desired option or value for the item.
- ⑤ Push **[CLR]** to return to the frequency mode.

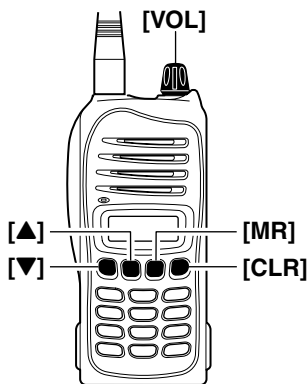

#### *For the IC-A14 only*

Push **[FUNC]**, then hold down **[SET]** (**ENT**) for 1 second to also enter the Set mode.

#### *For your information:*

The default value of the Set mode items can be changed with the optional CS-A14 cloning software. The default settings are recalled by the Home function.

#### ◇ Set mode items

- **ANL— ANL function** (selectable in only the IC-A14S)  
Turns the ANL (Automatic Noise Limiter) function ON or OFF. The ANL reduces received noise components such as those caused by engine ignition systems.

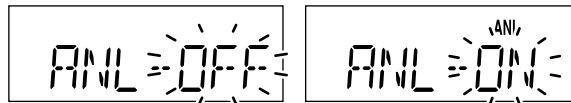

- **BEEP— Key touch beep** (selectable in only the IC-A14S)  
The beep tone sounds when you push a switch.

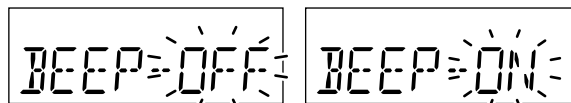

- **MIC— Microphone gain**

The internal microphone gain can be set to suit your needs. "H" (High gain), "M" (Medium gain) and "L" (Low gain) can be selected.

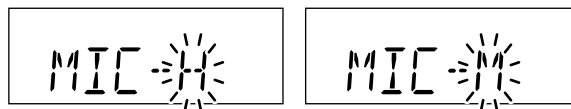

**• I.MIC— Using the internal microphone**

The internal microphone can be turned OFF to use a headset.

This setting prevents unwanted audio or noise from the internal microphone when [PTT] is pushed.

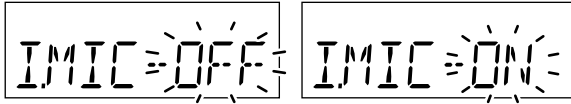
**• TOT— Time-out timer**

Sets the time-out timer period to prevent prolonged transmissions, according to regulatory requirements. This timer cuts OFF a transmission after the set time period.

Set the timer to between 20 and 180 seconds (in 10 second steps) or to OFF.

Ask your dealer for local regulation details.

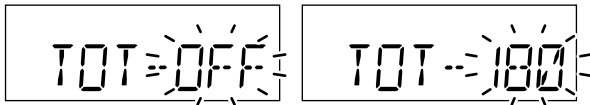

## ■ Battery charging

Misuse of Lithium-ion batteries may result in the following hazards: smoke, fire, or the battery may rupture. Misuse can also cause damage to the battery or degradation of battery performance.

### ◇ Battery caution

△ **DANGER! DO NOT** hammer or otherwise impact the battery. Do not use the battery if it has been severely impacted or dropped, or if the battery has been subjected to heavy pressure. Battery damage may not be visible on the outside of the case. Even if the surface of the battery does not show cracks or any other damage, the cells inside the battery may rupture or catch fire.

△ **DANGER! NEVER** use or leave battery pack in places with temperatures above +60°C (+140°F). High temperature buildup in the battery, such as could occur near fires or stoves, inside a sun heated vehicle, or in direct sunlight for long periods of time may cause the battery to rupture or catch fire. Excessive temperatures may also degrade battery performance or shorten battery life.

△ **DANGER! DO NOT** expose the battery to rain, snow, seawater, or any other liquids. Never charge or use a wet battery. If the battery gets wet, be sure to wipe it dry before using.

△ **DANGER! KEEP** battery packs away from fire. Fire or heat may cause them to rupture or explode. Dispose of an used battery pack in accordance with local regulations.

△ **DANGER! NEVER** solder the battery terminals or NEVER modify the battery pack. This may generate heat in the battery, and the battery pack may burst, emit smoke or catch fire.

△ **DANGER!** Use the battery only with the transceiver for which it is specified. Never use a battery with any other equipment, or for any purpose that is not specified in this instruction manual.

△ **DANGER!** If fluid from inside the battery gets in your eyes, blindness can result. Rinse your eyes with clean water, without rubbing them, and see doctor immediately.

△ **WARNING!** Immediately stop using the battery if it emits an abnormal odor, heats up, or is discolored or deformed. If any of these conditions occur, contact your Icom dealer or distributor.

△ **WARNING!** Immediately wash, using clean water, any part of the body that comes into contact with fluid from inside the battery.

△ **WARNING! NEVER** put the battery in a microwave oven, high-pressure container, or in an induction heating cooker. This could cause a fire, overheating, or cause the battery to rupture.



**CAUTION:** Always use the battery within the specified temperature range for the transceiver (−10°C to +60°C, +14°F to +140°F) and the battery itself (−20°C to +60°C, −4°F to +140°F). Using the battery out of its specified temperature range will reduce the battery's performance and battery life. Please note that the specified temperature range of the battery may exceed that of the transceiver. In such cases, the transceiver may not work properly because it is out of its operating temperature range.

**CAUTION:** Shorter battery life could occur if the battery is left fully charged, completely discharged, or in an excessive temperature environment (above +50°C) for an extended period of time. If the battery must be left unused for a long time, it must be detached from the transceiver after discharging. You may use the battery until the remaining capacity is about half, then keep it safely in a cool dry place with the temperature range as below:

- −20°C to +50°C, −4°F to +122°F (up to a month)
- −20°C to +35°C, −4°F to +95°F (up to three months)
- −20°C to +20°C, −4°F to +68°F (up to a year)

**BE SURE** to replace the battery pack with a new one approximately five years after manufacturing, even if it still holds a charge. The inside battery material will become weak after a period of time, even with little use. The estimated number of times you can charge the battery is between 300 and 500. Even when the battery appears to be fully charged, the operating time of the transceiver may become short when:

- Approximately five years have passed since the battery was manufactured.
- The battery has been repeatedly charged.

## ◇ Charging caution

⚠ **DANGER! NEVER** charge the battery pack in areas with extremely high temperatures, such as near fires or stoves, inside a sun-heated vehicle, or in direct sunlight. In such environments, the safety/protection circuit in the battery will activate, causing the battery to stop charging.

⚠ **WARNING! NEVER** charge the transceiver during a lightning storm. It may result in an electric shock, cause a fire or damage the transceiver. Always disconnect the power adapter before a storm.

⚠ **WARNING! NEVER** charge or leave the battery in the battery charger beyond the specified time for charging. If the battery is not completely charged by the specified time, stop charging and remove the battery from the battery charger. Continuing to charge the battery beyond the specified time limit may cause a fire, overheating, or the battery may rupture.

⚠ **WARNING! NEVER** insert the transceiver (battery attached to the transceiver) into the charger if it is wet or soiled. This could corrode the battery charger terminals or damage the charger. The charger is not waterproof.

**CAUTION: NEVER** charge the battery outside of the specified temperature range: BC-179 (0°C to +40°C, +32°F to +104°F). Icom recommends charging the battery at +20°C (+68°F). The battery may heat up or rupture if charged out of the specified temperature range. Additionally, battery performance or battery life may be reduced.

## 7 BATTERY PACKS AND CASE

### ■ Charging the battery

#### ◇ Regular charging with the BC-179+BC-174

The BC-179 provides regular charging of battery packs. The following accessories are additionally required.

- A power adapter (may be supplied, depending on the transceiver versions) or the optional cigarette lighter cable (CP-22).

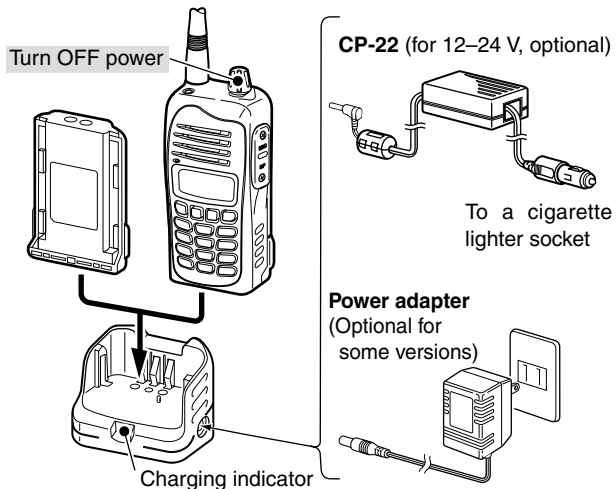

Be sure to turn OFF the transceiver power, when charging the battery pack along with the transceiver.

#### CAUTION!

- **DO NOT** modify the CP-22. A modification could cause a fire or electric shock.
- **BE CAREFUL** not to cut or fray the CP-22's power cable when disconnecting or connecting the CP-22 from or to the cigarette lighter socket.

#### • Charging period

Approximately 12 hours (for the BP-232N)  
Approximately 13.5 hours (for the BP-232H)

#### • Charging indicator color information

Orange: While charging

Green: When charging is completed

Orange or green (blink):

The battery pack or the charger has a problem.

◆ Installing AD-106

- Connect the AD-106 charger adapter and the BC-119N or BC-121N as shown below (①). Then install the AD-106 into the holder space of the BC-119N or BC-121N with the supplied screws (②).

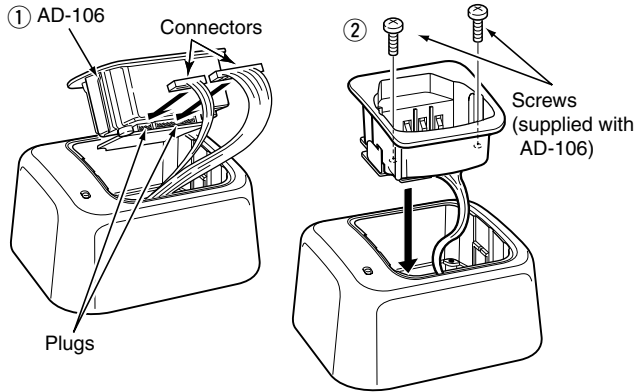

◆ Rapid charging with the BC-119N+AD-106

The optional BC-119N provides rapid charging of battery packs. The following accessories are additionally required.

- AD-106 charger adapter.
- A power adapter (may be supplied with BC-119N depending on the charger versions) or the OPC-515L DC power cable.

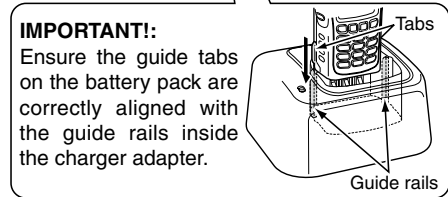
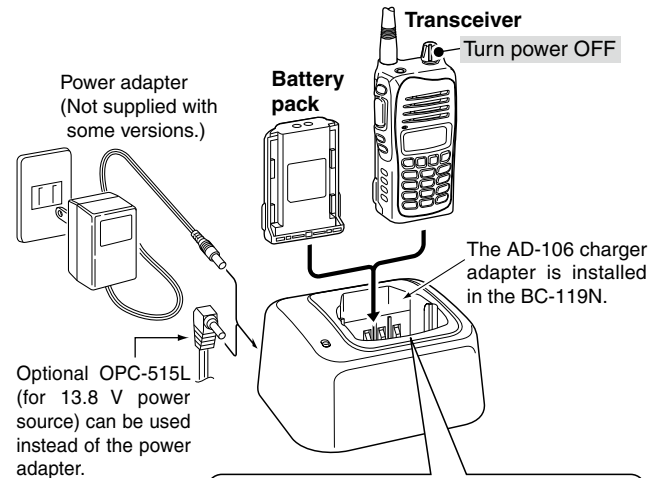

## 7 BATTERY PACKS AND CASE

### ◇ Rapid charging with the BC-121N+AD-106

The optional BC-121N allows up to 6 battery packs to be simultaneously charged. The following are additionally required.

- Six AD-106 charger adapters.
- A power adapter (BC-157S) or the DC power cable (OPC-656).

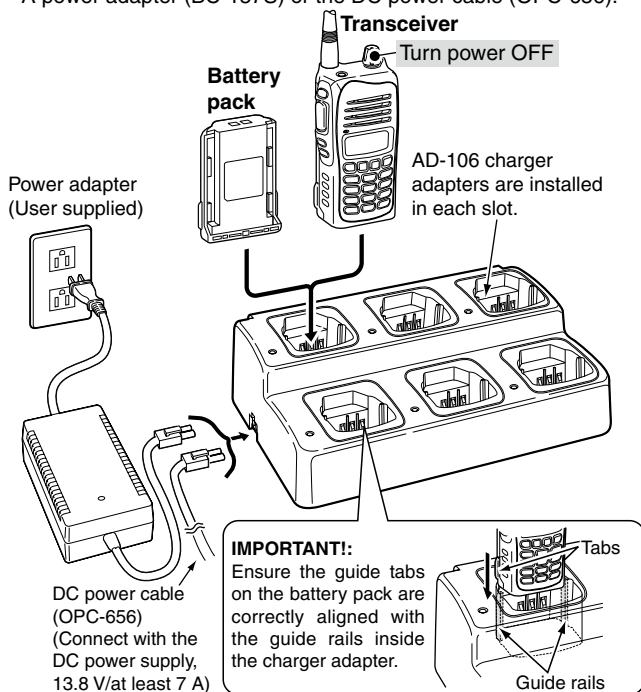

### ■ Battery case

(optional for some versions)

#### ◇ Precaution

**NEVER** incinerate used battery cells since internal battery gas may cause them to rupture.

**NEVER** expose a detached battery case to water. If the battery case gets wet, be sure to wipe it dry before using it.

**NEVER** short the terminals of the battery case. Also, current may flow into nearby metal objects. Therefore, be careful when carrying with, or placing near metal objects, carrying in bags and so on.

When installing battery cells, make sure they are all the same brand, type and capacity. Also, do not mix new and old battery cells together.

Install conventional alkaline cells only. Other type of batteries, such as Ni-Cd, Ni-MH, Li-ion, cannot be used.

Remove the alkaline cells when leaving the battery case unused for long time.

Keep battery contacts clean. It's a good idea to occasionally clean the battery terminals.

Alkaline cells have a shorter operating time compared to Li-ion battery cells. Also, the operating time differs by brand, as well as the model type of the alkaline cell being used. Therefore, it is recommended that you use the Li-ion battery pack, or take spare alkaline cells with you when intending to use the transceiver frequently, or for long periods.

### ◇ Alkaline cells installation

Install 6 AA (LR6) size alkaline cells as described below.

- ① Release the latch, and open the cover.

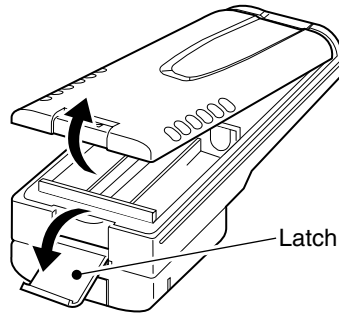

#### CAUTION:

**NEVER** use your finger nail when releasing the latch. Because the latch is tightly locked— you could damage your finger nail. Instead, use something relatively flat, like the edge of a coin or the tip of a screwdriver, to carefully release the latch.

- ② Install 6 AA (LR6) size alkaline cells.
  - Install the conventional alkaline cells only.
  - Be sure to observe the correct polarity.

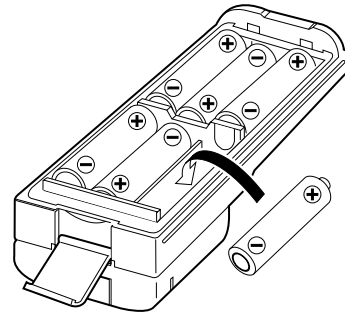

- ③ Attach the cover, then close. And lock the latch until it makes a 'click' sound.

#### CAUTION:

- When installing batteries, make sure they are all the same brand, type and capacity. Also, do not mix new and old batteries together.
- Keep battery contacts clean. It's a good idea to occasionally clean the battery terminals.

## 7 BATTERY PACKS AND CASE

### ◇ Battery case attachment

Slide the battery case in the direction of the arrow.

- Slide the battery case until the transceiver's battery release button makes a 'click' sound.

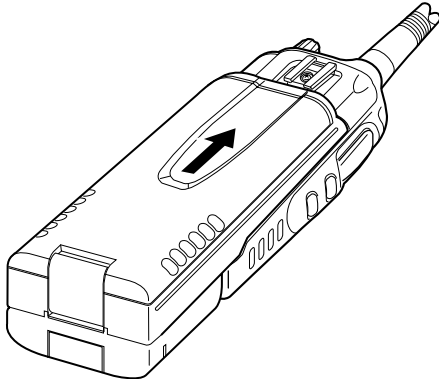

### *To release the battery case:*

Slide out the battery case's battery release button in the direction of the arrow (1), and then push the release button in the direction of the arrow (2) as shown in the illustration below. The battery pack is then released.

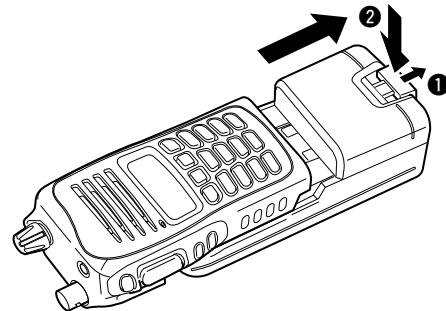

**NEVER** release or attach the battery case when the transceiver is wet or soiled. This may result water or dust getting into the transceiver/battery case and may result in the transceiver being damaged.

Cloning allows you to quickly and easily transfer the entered data from one transceiver to another transceiver, or, data from PC to a transceiver using the optional CS-A14 cloning software.

## ◆ Transceiver to transceiver cloning

- ① Connect the OPC-474 CLONING CABLE to the [MIC/SP] jack of the master and sub transceivers.
  - The master transceiver is used to send data to the sub transceiver.
- ② Turn OFF the master and sub transceivers.

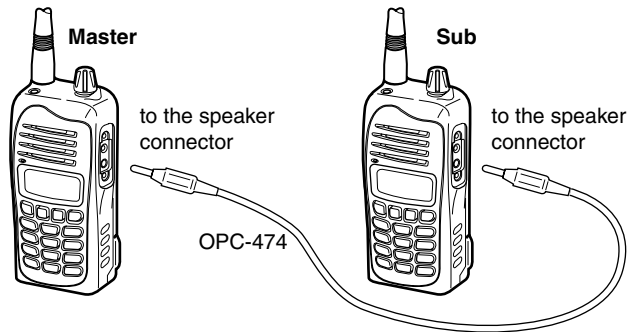

- ③ While holding down [MR], rotate [VOL] to enter the cloning mode (for the master transceiver only).
  - “CLONE” appears and the transceivers enter the clone standby condition.

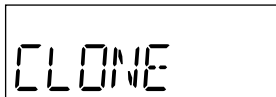

- ③ Push [PTT] on the master transceiver.
  - “CL.OUT” appears in the master transceiver’s display.
  - “CL.IN” automatically appears on the sub transceiver’s display.

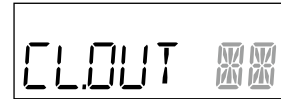

Master transceiver's indication during clone



Sub transceiver's indication during clone

- ④ When the cloning is finished, turn OFF power, then turn ON again to exit the cloning mode.

**NOTE:** Transceiver to transceiver cloning between the IC-A14 and the IC-A14S cannot be performed.

---

## 8 CLONING

### ◇ Cloning using PC

Data can be cloned to and from a PC (Microsoft® Windows® 2000/XP and Windows Vista™) using the optional CS-A14 CLONING SOFTWARE and the optional OPC-478 (RS-232C type) or OPC-478UC (USB type) CLONING CABLE. Consult the CS-A14 CLONING SOFTWARE HELP file for details.

### ◇ Cloning error

When the display as below appears, a cloning error has occurred.

In this case, both transceivers automatically return to the clone standby condition and cloning must be repeated.

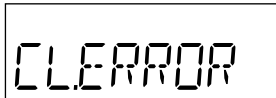

Microsoft, Windows and Windows Vista are registered trademarks or trademarks of Microsoft Corporation in the U.S.A. and/or other countries.



If your transceiver seems to be malfunctioning, please check the following points before sending it to a service center.

PROBLEM	POSSIBLE CAUSE	SOLUTION	REF.
No power comes on.	<ul style="list-style-type: none"> <li>The battery is exhausted.</li> <li>Bad connection for the battery pack.</li> </ul>	<ul style="list-style-type: none"> <li>Recharge the battery pack.</li> <li>Reattach the battery to the transceiver.</li> </ul>	pp. 29–31 p. 7
No sound comes from the speaker.	<ul style="list-style-type: none"> <li>The Squelch level is too deep.</li> <li>The Volume level is too low.</li> </ul>	<ul style="list-style-type: none"> <li>Set the squelch to the threshold point.</li> <li>Set <b>[VOL]</b> to a suitable level.</li> </ul>	p. 9
Transmitting impossible.	<ul style="list-style-type: none"> <li>A WX channel or the NAVI band is selected.</li> <li>The battery is exhausted.</li> </ul>	<ul style="list-style-type: none"> <li>Set to COM band in frequency mode.</li> <li>Recharge the battery pack.</li> </ul>	p. 8 pp. 29–31
The operating frequency or memory channel can not be changed.	<ul style="list-style-type: none"> <li>The lock function is activated.</li> </ul>	<ul style="list-style-type: none"> <li>Hold down <b>[]</b> for 2 seconds to turn the Lock function OFF.</li> </ul>	p. 9
Scan does not start.	<ul style="list-style-type: none"> <li>All memory channels in the selected bank are not programmed as “TAG” channels.</li> <li>The Squelch is open.</li> <li>There is not more than 2 memorized channels</li> </ul>	<ul style="list-style-type: none"> <li>Set the “TAG” settings of desired channels.</li> <li>Set the squelch level tighter.</li> <li>Program 2 or more memory channels.</li> </ul>	p. 20 p. 9 pp. 13, 14
No beep sounds.	<ul style="list-style-type: none"> <li>Beep tones are turned OFF.</li> </ul>	<ul style="list-style-type: none"> <li>Turn ON the beep tone.</li> <li>➔ IC-A14: Push <b>[FUNC]</b>, then push <b>[BEEP](8)</b>.</li> <li>➔ IC-A14S: Turn the beep tone ON in set mode.</li> </ul>	p. 22 pp. 22, 25

## ◇ CP-22 fuse replacement

If the fuse blows, or the receiver stops functioning while using the optional CP-22 CIGARETTE LIGHTER CABLE, find the source of the problem and repair it. Replace any blown fuse with a new rated one (FGB 8 A) as shown to the right.

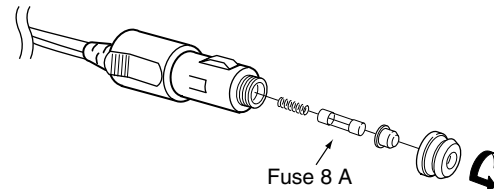

# 10 SPECIFICATIONS

## ◇ General

- Frequency coverage:
  - IC-A14 TX 118.000 to 136.975 MHz
  - RX 108.000 to 136.975 MHz
  - WX (Rx only) 161.650 to 163.275 MHz
  - IC-A14S TX/RX 118.000 to 136.975 MHz
- Mode: 6K00A3E  
16K0G3E (IC-A14/Rx only)
- Channel spacing: 25 kHz
- Number of memory channels:
  - IC-A14 200 (20 CH × 10 BANKS)
  - IC-A14S 100
- Power supply requirement: Specified Icom's battery packs  
7.4 V DC standard
- Usable temperature range: -10°C to +60°C (+14°F to +140°F)
- Current drain (at 7.4 V DC):
  - Tx 1.5 A
  - Rx at stand by 50 mA typical
  - at AF max. 500 mA
- Antenna connector: BNC 50 Ω (nominal)
- Dimensions: 53 (W) × 120 (H) × 36.9 (D) mm  
(projections not included) 2.1 (W) × 4.7 (H) × 1.5 (D) inch
- Weight: Approximately 180 g (6.35 oz)  
(Without the battery pack and antenna.)

## ◇ Transmitter

- Output power: 5.0 W (PEP) typical  
1.5 W (CW)
- Modulation: Low level modulation
- Modulation limiting: 70 to 100%
- Frequency stability: ±5 ppm

- Audio harmonic distortion: Less than 10% (at 60% modulation)
- Hum and noise ratio: More than 35 dB
- Spurious emissions: More than 46 dB (except operating frequency ±62.5 kHz range)
- External MIC connector: 3-conductor 2.5(d) mm (1/10")/  
150 Ω

## ◇ Receiver

- Receive system: Double conversion superheterodyne
- Intermediate frequencies: 1st 46.35 MHz, 2nd 450 kHz
- Sensitivity:
  - COM band (6 dB S/N) -6 dBμ typical
  - NAVI band (6 dB S/N) -3 dBμ typical (IC-A14 only)
  - WX channels (12 dB SINAD) -13 dBμ typical (IC-A14 only)
- Squelch sensitivity (threshold): AM Less than 0 dBμ  
FM Less than -5 dBμ  
(IC-A14 only)
- Selectivity: 6 dB (More than 7.5 kHz)  
60 dB (Less than 25 kHz)
- Spurious response rejection: AM More than 60 dB  
FM More than 30 dB  
(IC-A14 only)
- Audio output power: More than 700 mW (internal SP)  
More than 500 mW (external SP)  
(at 10% distortion into an 8 Ω load, 30% modulation)
- Hum and noise: More than 35 dB at 30% mod.
- External SP connector: 3-conductor 3.5 (d) mm (1/8")/8 Ω

All stated specifications are subject to change without notice or obligation.

## ◇ BATTERY PACKS

- **BP-230N/BP-232N/BP-232H** Li-ion BATTERY PACKS  
BP-230N: 7.4 V/980 mAh (typical), 950 mAh (minimum)  
BP-232H: 7.4 V/2300 mAh (typical), 2250 mAh (minimum)
- **BP-261** BATTERY CASE  
Battery case for LR6 (AA) × 6 alkaline batteries.

## ◇ CHARGERS

- **BC-119N** DESKTOP CHARGER + **AD-106** CHARGER ADAPTER  
+ **BC-145S** AC ADAPTER  
For rapid charging of battery packs. A power adapter is supplied with the charger depending on versions.  
Charging time: approx. 3 hours when BP-232H is attached.
- **BC-121N** MULTI-CHARGER + **AD-106** CHARGER ADAPTER (6 pcs.)  
+ **BC-157S** AC ADAPTER  
For rapid charging of up to 6 battery packs (six AD-106's are required) simultaneously. A power adapter should be purchased separately. Charging time: approximately 3 hours when BP-232H is attached.
- **BC-160** DESKTOP CHARGER + **BC-145S** AC ADAPTER  
For rapid charging of BP-230N and BP-232H (Li-ion).
- **BC-171** DESKTOP CHARGER + **BC-147S** AC ADAPTER  
For regular charging of BP-230N (Li-ion).
- **BC-179** DESKTOP CHARGER + **BC-147S** AC ADAPTER  
For regular charging of BP-230N and BP-232H (Li-ion).

## ◇ MICROPHONE

- **HM-234** SPEAKER MICROPHONE  
Combination speaker and microphone.

## ◇ BELT CLIPS

- **MB-94** BELT CLIP  
Alligator type belt clip.
- **MB-96F** LEATHER BELT HANGER  
Attaches with the supplied belt clip (Fixed type).

## ◇ DC CABLES

- **CP-22** CIGARETTE LIGHTER CABLE  
DC-DC converter is built-in. Charges the battery pack using 12/24 V DC power source instead of the power adapter for BC-171/179.
- **OPC-515L** DC POWER CABLE FOR BC-119N  
Charges the battery pack using 13.8 V power source instead of the power adapter for BC-119N.
- **OPC-656** DC POWER CABLE FOR BC-121N  
Charges the battery pack using 13.8 V power source instead of the power adapter for BC-121N.

## ◇ OTHER OPTIONS

- **CS-A14** CLONING SOFTWARE + **OPC-478/UC** CLONING CABLE  
Provides quick and easy entering of items, such as memory channels or set mode contents, from a PC using the cloning cable, OPC-478 (RS-232C, DB-9 type) or OPC-478UC (USB type).
- **MB-130** VEHICLE CHARGER BRACKET  
Vehicle mounting bracket for BC-160 battery charger.
- **OPC-499** HEADSET ADAPTER CABLE  
When using an optional headset (3rd party) through the adapter, the transceiver outputs your transmitted voice to the headset for monitoring.
- **OPC-474** CLONING CABLE  
For data cloning between transceivers.

Available options may differ according to countries. Ask your authorized dealer for details.

# 12 OPTIONAL HEADSET CONNECTION

## ◇ OPC-499 (HEADSET ADAPTER) connection

When using a headset (3rd party product) with the OPC-499 HEADSET ADAPTER, the transceiver outputs your transmitted voice to the headset for monitoring. See “■ Side tone function” (p. 11) when setting the side tone level.

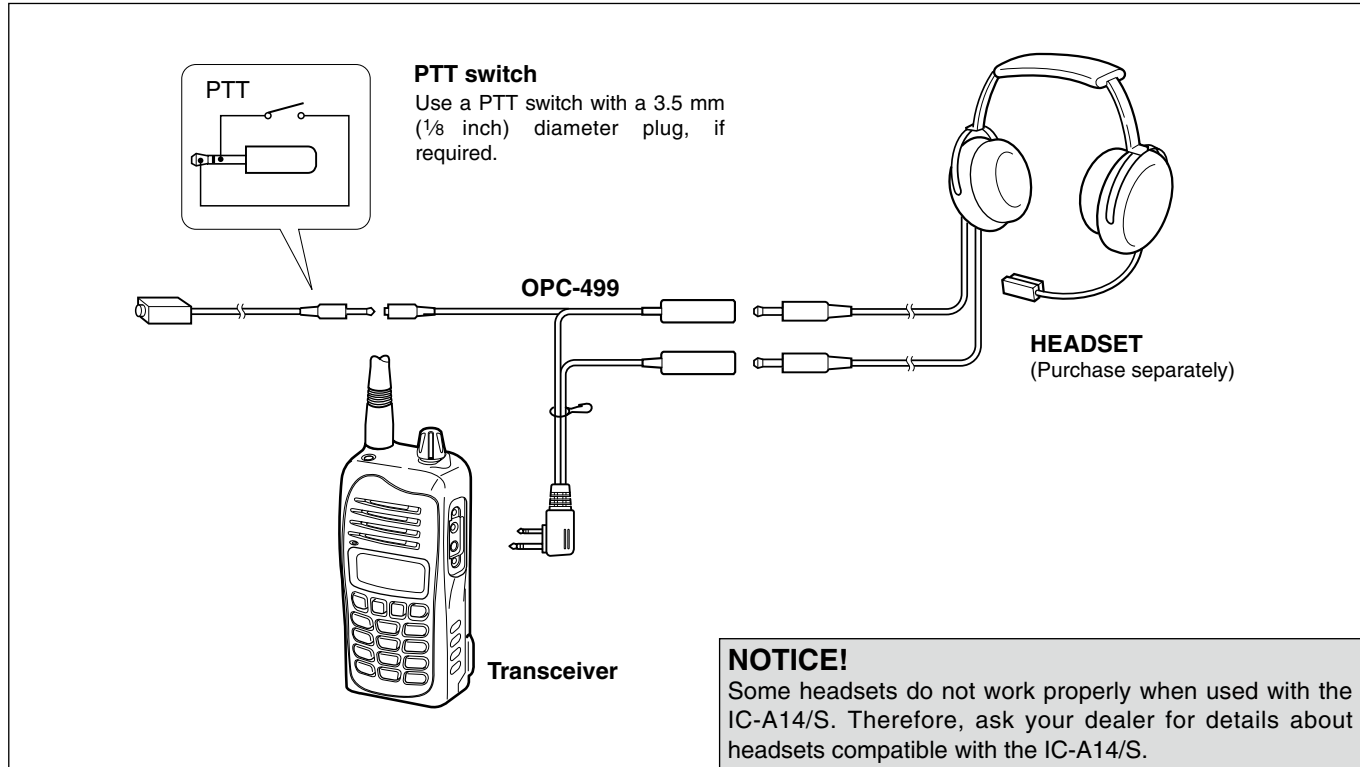



Your Icom radio generates RF electromagnetic energy during transmit mode. This radio is designed for and classified as “Occupational Use Only”, meaning it must be used only during the course of employment by individuals aware of the hazards, and the ways to minimize such hazards. This radio is NOT intended for use by the “General Population” in an uncontrolled environment.

This radio has been tested and complies with the FCC and IC RF exposure limits for “Occupational Use Only”. In addition, your Icom radio complies with the following Standards and Guidelines with regard to RF energy and electromagnetic energy levels and evaluation of such levels for exposure to humans:

- FCC OET Bulletin 65 Edition 97-01 Supplement C, Evaluating Compliance with FCC Guidelines for Human Exposure to Radio Frequency Electromagnetic Fields.
- American National Standards Institute (C95.1-1992), IEEE Standard for Safety Levels with Respect to Human Exposure to Radio Frequency Electromagnetic Fields, 3 kHz to 300 GHz.
- American National Standards Institute (C95.3-1992), IEEE Recommended Practice for the Measurement of Potentially Hazardous Electromagnetic Fields— RF and Microwave.
- The following accessories are authorized for use with this product. Use of accessories other than those specified may result in RF exposure levels exceeding the FCC and IC requirements for wireless RF exposure.; Belt Clip (MB-94/96F), Rechargeable Li-ion Battery Pack (BP-230N/232N/BP-232H), and Microphone (HM-234).



**To ensure that your exposure to RF electromagnetic energy is within the FCC and IC allowable limits for occupational use, always adhere to the following guidelines:**

- **DO NOT** operate the radio without a proper antenna attached, as this may damage the radio and may also cause you to exceed FCC and IC RF exposure limits. A proper antenna is the antenna supplied with this radio by the manufacturer or antenna specifically authorized by the manufacturer for use with this radio.
- **DO NOT** transmit for more than 50% of total radio use time (“50% duty cycle”). Transmitting more than 50% of the time can cause FCC and IC RF exposure compliance requirements to be exceeded. The radio is transmitting when “**TX**” appears on the function display. You can cause the radio to transmit by pressing the “PTT” switch.
- **ALWAYS keep** the antenna at least 2.5 cm (1 inch) away from the body when transmitting and only use the Icom belt-clips listed on page 38 when attaching the radio to your belt, etc., to ensure FCC and IC RF exposure compliance requirements are not exceeded. To provide the recipients of your transmission the best sound quality, hold the antenna at least 5 cm (2 inches) from your mouth, and slightly off to one side.

The information listed above provides the user with the information needed to make him or her aware of RF exposure, and what to do to assure that this radio operates with the FCC and IC RF exposure limits of this radio.

### **Electromagnetic Interference/Compatibility**

During transmissions, your Icom radio generates RF energy that can possibly cause interference with other devices or systems. To avoid such interference, turn off the radio in areas where signs are posted to do so. **DO NOT** operate the transmitter in areas that are sensitive to electromagnetic radiation such as hospitals, aircraft, and blasting sites.

### **Occupational/Controlled Use**

The radio transmitter is used in situations in which persons are exposed as a consequence of their employment provided those persons are fully aware of the potential for exposure and can exercise control over their exposure.

## 13 SAFETY TRAINING INFORMATION



AVERTISSEMENT

Votre radio Icom produit une énergie électromagnétique de radiofréquences (RF), en mode de transmission. Cette radio est conçue pour un «usage professionnel seulement» et classée comme tel, ce qui signifie qu'elle doit être utilisée uniquement dans le cadre d'un travail par des personnes conscientes des dangers et des mesures visant à minimiser ces dangers. Elle N'EST PAS conçue pour une «utilisation grand public», dans un environnement non contrôlé.

Cet appareil a été évalué et jugé conforme, aux limites d'exposition aux RF de la FCC et d'IC, pour une «utilisation grand public». En outre, votre radio Icom satisfait les normes et directives qui suivent en matière de niveaux d'énergie et d'énergie électromagnétique de RF et d'évaluation de tels niveaux en ce qui concerne l'exposition humaine:

- Supplément C, édition 97-01, du Bulletin OET n° 65 de la FCC, «Evaluating Compliance with FCC Guidelines for Human Exposure to Radio Frequency Electromagnetic Fields».
- Norme de l'American National Standards Institute (ANSI): IEEE C95.1-1992 sur les niveaux de sécurité compatibles avec l'exposition humaine aux champs électromagnétiques de radiofréquences (3 kHz à 300 GHz).
- Norme de l'ANSI: IEEE C95.3-1992 sur la méthode d'évaluation recommandée du champ magnétique potentiellement dangereux des radiofréquences et des micro-ondes.
- Les accessoires illustrés à la p. 38 sont approuvés pour une utilisation avec ce produit. L'utilisation d'accessoires autres que ceux précisés peut entraîner des niveaux d'exposition aux RF supérieures aux limites établies par la FCC et d'IC en matière d'exposition aux RF sans fil.



MISE EN GARDE

**Afin de vous assurer que votre exposition à une énergie électromagnétique de RF se situe dans les limites permises par la FCC et d'IC pour une utilisation grand public, veuillez en tout temps respecter les directives suivantes:**

- **NE PAS** faire fonctionner la radio sans qu'une antenne appropriée y soit fixée, car ceci risque d'endommager la radio et causer une exposition supérieure aux limites établies par la FCC et d'IC. L'antenne appropriée est celle qui est fournie avec cette radio par le fabricant ou une antenne spécialement autorisée par le fabricant pour être utilisée avec cette radio.
- **NE PAS** émettre pendant plus de 50 % du temps total d'utilisation de l'appareil («50 % du facteur d'utilisation»). La notion «50% du facteur d'utilisation» s'applique également au mode VOX/PTT. Émettre pendant plus de 50 % du temps total d'utilisation peut causer une exposition aux RF supérieure aux limites établies par la FCC et d'IC. Lorsque le voyant DEL rouge s'allume, cette radio est en train d'émettre. La radio émettra si vous appuyez sur le bouton du microphone.
- **TOUJOURS tenir** l'antenne éloignée d'au moins 2,5 cm de votre corps au moment d'émettre et utiliser uniquement l'attache pour ceinture Icom illustrée à la p. 38, lorsque vous attachez la radio à votre ceinture, ou à autre chose, de façon à vous assurer de ne pas provoquer une exposition aux RF supérieure aux limites fixées par la FCC et d'IC. Pour offrir à vos interlocuteurs la meilleure qualité de transmission possible, tenez l'antenne à au moins 5 cm de votre bouche et légèrement de côté.

Les renseignements ci-dessus fournissent à l'utilisateur toute l'information nécessaire sur l'exposition aux RF et sur ce qu'il faut faire pour assurer que cette radio fonctionne en respectant les limites d'exposition aux RF établies par la FCC et d'IC.

### Interférence électromagnétique et compatibilité

En mode de transmission, votre radio Icom produit de l'énergie de RF qui peut provoquer des interférences avec d'autres appareils ou systèmes. Pour éviter de telles interférences, mettez la radio hors tension dans les secteurs où une signalisation l'exige. **NE PAS** faire fonctionner l'émetteur dans des secteurs sensibles au rayonnement électromagnétique tels que les hôpitaux, les aéronefs et les sites de dynamitage.

### Usage professionnel/contrôlé

Ce radio émetteur est utilisé dans des cas où des personnes sont exposées en raison de leur travail, pourvu qu'elles soient conscientes du risque d'exposition et qu'elles puissent exercer un contrôle sur cette exposition.

---

---

---

---

---

---

---

---

---

---

---

---

---

---

---

---

---

---

---

---

---

---

---

---

---



---

---

---

---

---

---

---

---

---

---

---

---

---

---

---

---

---

---

---

---

---

---

---

---

---

**Count on us!**

A-6631H-1EX-③a

Printed in Japan

© 2007–2017 Icom Inc.

Printed on recycled paper with soy ink.

**Icom Inc.**

1-1-32 Kamiminami, Hirano-ku, Osaka 547-0003, Japan