



## INSTRUCTION MANUAL

VHF P25 TRUNKING  
HANDHELD TRANSCEIVERS

**IC-F9011B/S/T**

UHF P25 TRUNKING  
HANDHELD TRANSCEIVERS

**IC-F9021B/S/T**  
**IC-F9023B/S/T**

**Icom Inc.**



The photo shows the 10-key type VHF transceiver.

---

## IMPORTANT

---

**READ ALL INSTRUCTIONS** carefully and completely before using the transceiver.

**SAVE THIS INSTRUCTION MANUAL** — This instruction manual contains important operating instructions for the **IC-F9011B/S/T VHF P25 TRUNKING HANDHELD TRANSCEIVERS** and the **IC-F9021B/S/T, IC-F9023B/S/T UHF P25 TRUNKING HANDHELD TRANSCEIVERS**.

✓ **When the optional UT-125 AES/DES ENCRYPTION UNIT is installed:**

When you attempt to re-export this product and/or AES encryption of this product is activated, you must comply with the export regulations of your country, which can be highly restrictive. YOUR FAILURE TO COMPLY WITH EXPORT REGULATIONS MAY SUBJECT YOU TO FINES OR PENALTIES. AES encryption products including this software fall under the control of the Japanese Government as described in Appendix I: Export Legal Controls and Appendix: Exchange Legal Controls. Please consult with your dealer or sales representative for details.

Icom, Icom Inc. and the Icom logo are registered trademarks of Icom Incorporated (Japan) in Japan, the United States, the United Kingdom, Germany, France, Spain, Russia and/or other countries.

All other products or brands are registered trademarks or trademarks of their respective holders.

---

## EXPLICIT DEFINITIONS

---

WORD	DEFINITION
⚠ <b>DANGER!</b>	Personal death, serious injury or an explosion may occur.
⚠ <b>WARNING!</b>	Personal injury, fire hazard or electric shock may occur.
<b>CAUTION</b>	Equipment damage may occur.
<b>NOTE</b>	If disregarded, inconvenience only. No risk of personal injury, fire or electric shock.

/// See the operating guide for details of Analog, MDC and P25 Trunking/Conventional system operations. Consult your Icom dealer or system operator for details concerning your transceivers programming.

✓ **INFORMATION:**

In this instruction manual, the following descriptions are used;  
IC-F9011B/IC-F9021B/IC-F9023B : “**Non-display type**”  
IC-F9011S/IC-F9021S/IC-F9023S : “**Simple type**”  
IC-F9011T/IC-F9021T/IC-F9023T : “**10-key type**”



Non-display type



Simple type



10-key type

---

## FCC INFORMATION

---

### • FOR CLASS B UNINTENTIONAL RADIATORS:

This equipment has been tested and found to comply with the limits for a Class B digital device, pursuant to part 15 of the FCC Rules. These limits are designed to provide reasonable protection against harmful interference in a residential installation. This equipment generates, uses and can radiate radio frequency energy and, if not installed and used in accordance with the instructions, may cause harmful interference to radio communications. However, there is no guarantee that interference will not occur in a particular installation. If this equipment does cause harmful interference to radio or television reception, which can be determined by turning the equipment off and on, the user is encouraged to try to correct the interference by one or more of the following measures:

- Reorient or relocate the receiving antenna.
- Increase the separation between the equipment and receiver.
- Connect the equipment into an outlet on a circuit different from that to which the receiver is connected.
- Consult the dealer or an experienced radio/TV technician for help.

---

## ABOUT IPR

---

This device is made under license under one or more of the following U.S. Patents: #4,590,473; #4,636,791; #5,148,482; #5,185,796; #5,271,017; #5,377,229; #4,716,407; #4,972,460; #5,502,767; #5,146,497; #5,164,986; #5,185,795; #5,164,986, #5,185,795, and #5,146,497.

\* IPR means 'Intellectual Property Rights.'

---

## VOICE CODING TECHNOLOGY

---

The AMBE+2™ voice coding Technology embodied in this product is protected by intellectual property rights including patent rights, copyrights and trade secrets of Digital Voice Systems, Inc. This voice coding Technology is licensed solely for use within this Communications Equipment. The user of this Technology is explicitly prohibited from attempting to extract, remove, decompile, reverse engineer, or disassemble the Object Code, or in any other way convert the Object Code into a human-readable form. U.S. Patent Nos. #5,870,405, #5,826,222, #5,754,974, #5,701,390, #5,715,365, #5,649,050, #5,630,011, #5,581,656, #5,517,511, #5,491,772, #5,247,579, #5,226,084 and #5,195,166.

---

## PRECAUTIONS

---

⚠ **DANGER! NEVER** short the terminals of the battery pack.

⚠ **WARNING! NEVER** hold the transceiver so that the antenna is very close to, or touching exposed parts of the body, especially the face or eyes, while transmitting. The transceiver will perform best if the microphone is 5 to 10 cm (2 to 4 in.) away from the lips and the transceiver is vertical.

⚠ **WARNING! NEVER** operate the transceiver with a headset or other audio accessories at high volume levels.

**CAUTION: NEVER** use non-Icom battery packs/chargers to prevent the loss of the transceiver's good performance and warranty.

**DO NOT** push [PTT] when not actually desiring to transmit.

**DO NOT** use or place the transceiver in direct sunlight or in areas with temperatures below  $-30^{\circ}\text{C}$  ( $+22^{\circ}\text{F}$ ) or above  $+60^{\circ}\text{C}$  ( $+140^{\circ}\text{F}$ ).

The basic operations, transmission and reception of the transceiver are guaranteed within the specified operating temperature range. However, the LCD display may not operate correctly, or show an indication in the case of long hours of operation, or after being placed in extremely cold areas.

**DO NOT** modify the transceiver. The transceiver warranty does not cover any problems caused by unauthorized modification.

**BE CAREFUL!** The transceiver meets IP57 requirements for dust-protection and waterproof protection. However, once the transceiver has been dropped, dust-protection and waterproof protection cannot be guaranteed due to the fact that the transceiver may be cracked, or the waterproof seal damaged, etc.

### *For U.S.A. only*

**CAUTION:** Changes or modifications to this transceiver, not expressly approved by Icom Inc., could void your authority to operate this transceiver under FCC regulations.

Approved Icom optional equipment is designed for optimal performance when used with an Icom transceiver.

Icom is not responsible for the destruction or damage to an Icom transceiver in the event it is used with equipment that is not manufactured or approved by Icom.

---

# TABLE OF CONTENTS

---

IMPORTANT .....	i
EXPLICIT DEFINITIONS .....	i
FCC INFORMATION .....	ii
ABOUT IPR .....	ii
VOICE CODING TECHNOLOGY .....	ii
PRECAUTIONS .....	iii
TABLE OF CONTENTS .....	iv
<b>1 ACCESSORIES .....</b>	<b>1-2</b>
■ Supplied accessories .....	1
■ Accessory attachments .....	1
<b>2 PANEL DESCRIPTION .....</b>	<b>3-11</b>
■ Front panel .....	3
■ Function display (Simple/10-key types only) .....	5
■ Programmable function keys .....	6
<b>3 BASIC OPERATION .....</b>	<b>12-16</b>
■ Turning power ON .....	12
■ Channel selection .....	12
■ Receiving and transmitting .....	13
■ User set mode .....	14
■ Clock function .....	15
■ LED indicator (Non-display type only) .....	16
<b>4 BATTERY CHARGING .....</b>	<b>17-20</b>
■ Caution .....	17
■ Optional battery chargers .....	19
<b>5 BATTERY CASE .....</b>	<b>21</b>
■ Optional battery case (BP-237) .....	21
<b>6 SPEAKER MICROPHONE .....</b>	<b>22</b>
■ Optional HM-184 description .....	22
■ To attach .....	22
<b>7 OPTIONS .....</b>	<b>23-25</b>
<b>8 SAFETY TRAINING INFORMATION .....</b>	<b>26</b>

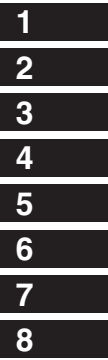

# 1

## ACCESSORIES

### ■ Supplied accessories

The following accessories are supplied.

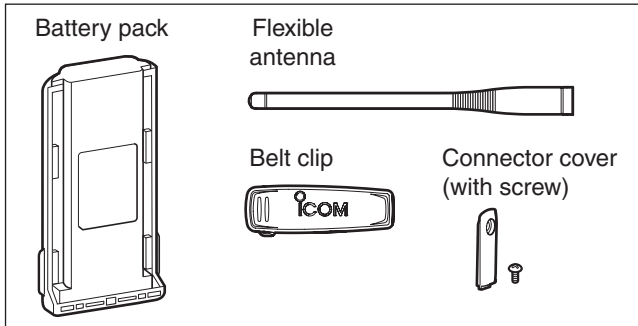

### ■ Accessory attachments

#### ◇ Flexible antenna

Connect the supplied flexible antenna to the antenna connector.

#### CAUTION:

- **NEVER** carry the transceiver by holding the antenna.
- **DO NOT** connect the antenna other than listed on p. 23.
- Transmitting without an antenna may damage the transceiver.

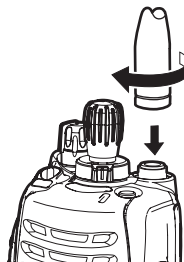

#### ◇ Battery pack

##### To attach the battery pack:

Slide the battery pack on the back of the transceiver in the direction of the arrow (1), then lock it with the battery release button.

- Slide the battery pack until the battery release button makes a 'click' sound.

##### To release the battery pack:

Slide the battery release button in the direction of the arrow (2) as shown below. The battery pack is then released.

NEVER release or attach the battery pack when the transceiver is wet or soiled. This may result water or dust getting into the transceiver/battery pack and may result in the transceiver being damaged.

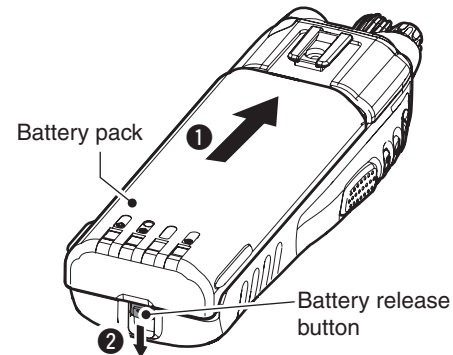

NOTE: Keep the battery pack terminals clean. It's a good idea to clean the battery pack terminals once a week.

### ◇ Belt clip

#### **To attach the belt clip:**

- ① Release the battery pack if it is attached.
- ② Slide the belt clip in the direction of the arrow until the belt clip is locked and makes a 'click' sound.

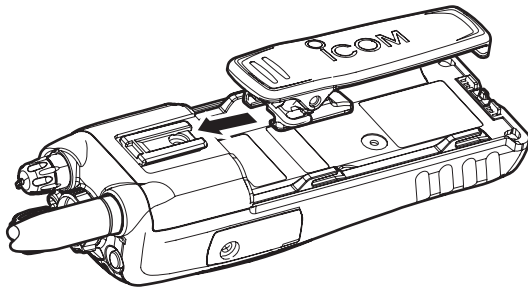

#### **To detach the belt clip:**

- ① Release the battery pack if it is attached.
- ② Pinch the clip (1), and slide the belt clip in the direction of the arrow (2).

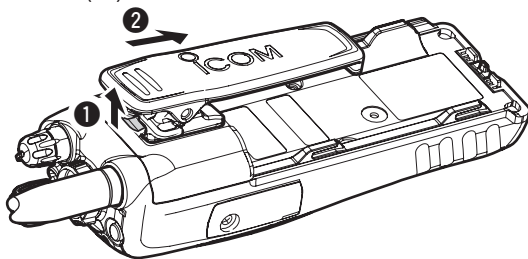

### ◇ Connector cover

Attach the connector cover when the optional equipment is not used.

#### **To attach the connector cover:**

- ① Insert the connector cover into the multi-connector.
- ② Tighten the screw.

**CAUTION:**  
Attach the connector cover when the optional equipment is not used. Otherwise the terminals of the multi-connector may be shorted by metal object, etc., and this could damage the transceiver.

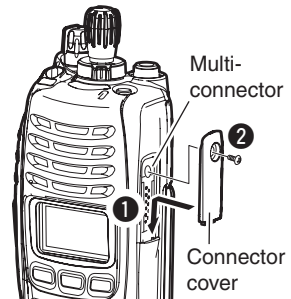

#### **To detach the connector cover:**

- ① Unscrew the screw using a phillips screwdriver.
- ② Detach the connector cover for the optional equipment connector.

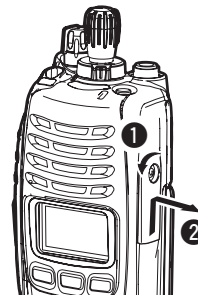

# 2

## PANEL DESCRIPTION

### ■ Front panel

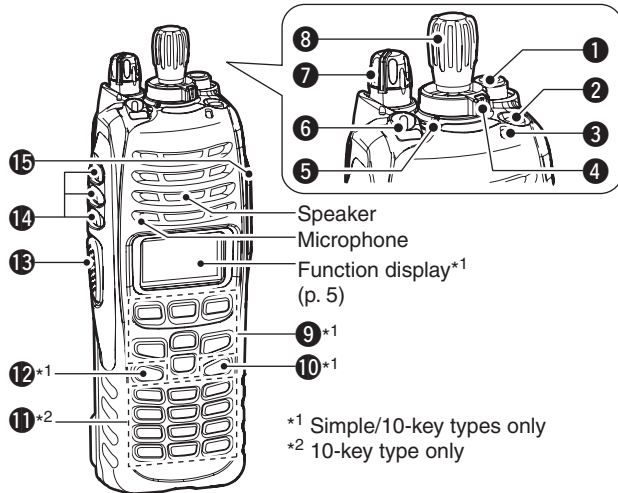

#### 1 ANTENNA CONNECTOR

Connects the supplied antenna. (p. 1)

#### 2 DEALER-PROGRAMMABLE KEY [EMR]

Desired function can be programmed by your dealer. (p. 6)

- [Emergency] is pre-programmed as default. (See the operating guide for details.)

#### 3 LED INDICATOR

- Lights green while receiving a signal, or when the squelch is open.
- Lights red while transmitting.
- The LED indicator indicates some information. (Non-display type only) (p. 16)

#### 4 DEALER-PROGRAMMABLE ABC SWITCH

Desired function can be programmed to each position (A, B or C) independently by your dealer. (p. 11)

To activate the pre-programmed function, set the white line of the ABC switch to the position A, B or C.

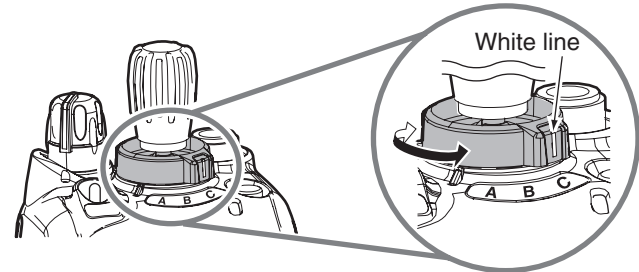

When the white line of the ABC switch is set to the position C, the pre-programmed function at position C will be activated.



**5 CHANNEL INDICATOR**

- ➔ Lights white according to the “Backlight” setting of the user set mode.
- ➔ When you rotate [Rotary selector] to select the channel or zone, set the desired channel/zone number to this point.

**6 DEALER-PROGRAMMABLE TOGGLE SWITCH**

Desired function can be programmed by your dealer. (p. 11)  
 When the toggle switch is set to the left side ('Ø'), the pre-programmed function will be activated.

**7 VOLUME CONTROL [VOL]**

Rotate to turn the power ON/OFF and adjust the audio level.

**8 ROTARY SELECTOR**

Rotate to select the pre-programmed memory channels or the operating zone. (Depending on the pre-setting)

- The channel/zone that is positioned to the channel indicator (5) is selected as the operating channel/zone.
- Depending on the pre-setting, selecting channel 1 using the rotary selector starts a scan. (Rotary Selector Home function)

**9 DEALER-PROGRAMMABLE KEYS**

[1]/[11]/[111]/[◀]/[▶]/[▲]/[▼] (Simple/10-key types only)  
 Desired function can be programmed independently by your dealer. (p. 6)

**10 APP KEY [APP] (Simple/10-key types only)**

Desired function can be programmed by your dealer. (p. 6)

**11 10-KEYPAD (10-key type only)**

The keypad allows you to enter digits to:

- Select memory channels, tone channels and DTMF codes (while in the DTMF code channel selection mode.)
- Start up with the password
- Input the Individual ID code for digital operation. (Depending on the pre-setting)

**12 HOME KEY [HOME] (Simple/10-key types only)**

Desired function can be programmed by your dealer. (p. 6)  
 • [Home] is pre-programmed as default. (See p. 7 for details.)

**13 PTT SWITCH [PTT]**

Push and hold to transmit; release to receive.

- Depending on the pre-setting, when an external unit with its own PTT switch\* is connected to the multi-connector, the transceiver's [PTT] is disabled.

\* Such as an optional speaker-microphone or headset.

**14 DEALER-PROGRAMMABLE KEYS**

[Side1]/[Side2]/[Side3]  
 Desired function can be programmed independently by your dealer. (p. 6)

**15 MULTI-CONNECTOR**

Connect optional equipment.



Connector cover

**NOTE:** Attach the connector cover when the optional equipment is not used.  
 See p. 2 for details.

## 2 PANEL DESCRIPTION

### ■ Function display (Simple/10-key types only)

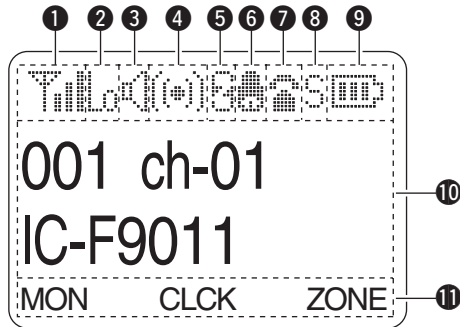

#### 1 SIGNAL STRENGTH INDICATOR

Indicates relative signal strength level.



#### 2 LOW POWER INDICATOR

Appears when low output power is selected.

- When high output power is selected, no indicator appears.

#### 3 AUDIBLE INDICATOR

Appears when the channel is in the 'audible' (unmute) condition.

#### 4 COMPANDER INDICATOR

Appears when the compander function\* is activated.

- \* Analog mode operation only.

#### 5 SCRAMBLER INDICATOR

Appears when the voice scrambler or encryption function is activated.

#### 6 BELL INDICATOR

Appears/blinks when the matched signal is received, according to the pre-programming.

#### 7 TELEPHONE INDICATOR

Appears when a phone call\* is received.

- \* P25 operation only.

#### 8 SHORT MESSAGE INDICATOR

Appears when an Status message or Short message is received.

#### 9 BATTERY INDICATOR

Appears or blinks when the battery power decreases to a specified level.

Indication				
Battery level	Full	Middle	Charging required	No battery

blinks when the battery is exhausted.

**⑩ ALPHANUMERIC DISPLAY**

Displays an operating channel number, channel name, Set mode contents, DTMF code, etc.

**⑪ KEY INDICATOR**

Indicate the programmed function of the front panel keys ([I], [II] and [III]).

See the operating guide for details of Analog, MDC and P25 Trunking/Conventional system operations. Consult your Icom dealer or system operator for details concerning your transceiver's programming.

**■ Programmable function keys**

The following functions can be assigned to the following programmable function keys and switches;

[EMR], [Side1], [Side2], [Side3], [I]\*, [II]\*, [III]\*, [◀]\*, [▶]\*, [▲]\*, [▼]\*, [APP]\*, [HOME]\*, ABC switch and Toggle switch.

\*Simple/10-key types only

Consult your Icom dealer or system operator for details concerning your transceiver's programming.

If the key indicator shows the programmed function key name, push the front panel key ([I], [II] or [III]) under the key indicator to activate the programmed function.

(The function key name in parentheses in the following explanation is displayed for that key indicator; e.g. "UF")

**For Non-display type:**

The programmable key functions are limited and some key functions should be operated differently from Simple and 10-key types. (See pp. 8 and 9 for details.)

**For ABC and Toggle switches:**

The programmable key functions to ABC and Toggle switches are limited. (See p. 11 for details.)

---

## 2 PANEL DESCRIPTION

### ◇ For All types (Common operation)

#### **PRIO A AND PRIO B KEYS** "PRA" "PRB"

Push to select Priority A or Priority B channel.

#### **MR-CH 1, MR-CH 2, MR-CH 3 AND MR-CH 4 KEYS**

"CH1" "CH2" "CH3" "CH4"

Push to select the memory channels 1, 2, 3 and 4 directly.

#### **MONI KEY** "MON"

- ➔ Push to mute and release the CTCSS (DTCS), 2-tone, NAC or Talkgroup ID squelch mute. Open any squelch/de-activate any mute while pushing and holding this key.
  - Depending on the pre-setting, the 'Audible' (unmute) condition may automatically return to the 'Inaudible' (mute) condition, after a specified time period.
- ➔ Depending on the pre-setting, pushing and holding this key for 1 sec. cancels the scan.

#### **LOCK KEY** "LOCK"

- ➔ Push and hold for 1 sec. to electronically lock all programmable keys except the following:  
[PTT], [Moni], [Light], [Lock], [Emergency], [Surveillance] and [OPT 1/2/3].
- ➔ Push and hold for 1 sec. again to turn the function OFF.

#### **LIGHT KEY** "LIGT"

Push to turn the transceiver's backlight ON for about 5 sec. when the backlight function is turned OFF in user set mode.

(p. 14)

#### **HOME KEY** "HOME"

Push to return to the stand-by mode.

- After editing some information that requires to be memorized, push this key to save the editing contents in the memory before returning to the stand-by mode.

#### **OPT MOMENTARY KEYS** "O1M" "O2M" "O3M"

Push to control the output signal level from the optional unit connector.

### ◇ **For All types** (Different operation with Non-display type)

When the following key functions are programmed to Non-display type, the key functions may be limited and some key functions should be operated differently from Simple and 10-key types.

#### **HIGH/LOW KEY** “H/L”

Push to select the transmit output power temporarily or permanently, depending on the pre-setting.

- Ask your dealer for the output power level for each selection.
- Emits one beep when Low 1 is selected, two beeps when Low 2 is selected and three beeps when High is selected. (Non-display type only)

#### **SCAN KEY** “SCAN”

##### ○ *For Simple/10-key types*

- ➡ Push to start and cancel scanning operation.
  - When the Power ON Scan, Auto Scan, or Rotary Selector Home function starts a scan, push this key to cancel the scan. The canceled scan resumes after the specified time period has passed.
- ➡ Push and hold this key for 1 sec. to indicate the scan list, then push [CH Up] or [CH Down] to select a desired list. (Depending on the presetting.)

##### ○ *For Non-display type*

Push to start and cancel scanning operation.

- When the Power ON Scan, Auto Scan, or Rotary Selector Home function starts a scan, push this key to cancel the scan. The canceled scan resumes after the specified time period has passed.
- The LED indicator blinks green slowly while scanning.

#### **SURVEILLANCE KEY** “SURV”

When this function is turned ON, the beep is not emitted and the LCD backlight does not light when a signal is received or a key is pushed.

##### ○ *For Simple/10-key types*

Push to turn the surveillance function ON or OFF.

##### ○ *For Non-display type*

- ➡ Push and hold for 1 sec. to turn the surveillance function ON.
- ➡ When the surveillance function is ON, push to turn the function OFF.

#### **TALK AROUND KEY** “TA” (Conventional operation only)

The talk around function equalizes the transmit frequency to the receive frequency for transceiver-to-transceiver communication.

##### ○ *For Simple/10-key types*

Push to turn the talk around function ON or OFF.

##### ○ *For Non-display type*

- ➡ Push and hold for 1 sec. to turn the talk around function ON.
- ➡ When the talk around function is ON, push to turn the function OFF.

---

## 2 PANEL DESCRIPTION

### **PRIO A REWRITE AND PRIO B REWRITE KEYS**

“PRAR” “PRBR”

○ *For Simple/10-key types*

- ➔ Push to select Priority A or Priority B channel.
- ➔ Push and hold [Prio A (Rewrite)] or [Prio B (Rewrite)] for 1 sec. to rewrite the operating channel as the Priority A or Priority B channel.

○ *For Non-display type*

Push to select Priority A or Priority B channel.

### **COMPANDER KEY “COMP”**

The compander function reduces noise components from the transmitted audio to provide clear communication.

○ *For Simple/10-key types*

Push to toggle the compander function ON and OFF.

○ *For Non-display type*

- ➔ Push and hold for 1 sec. to turn the compander function ON.
- ➔ When the compander function is ON, push to turn the function OFF.

### **OPT OUT KEYS “OP1” “OP2” “OP3”**

○ *For Simple/10-key types*

Push to control the output signal level from the optional unit connector.

○ *For Non-display type*

- ➔ Push and hold for 1 sec. to control the output signal level from the optional unit connector.
- ➔ When this key function is activated, push to deactivate the function.

### **◇ For Simple/10-key types only**

Following key functions cannot be programmed to Non-display types.

### **CH UP AND DOWN KEYS “UP” “DOWN”**

- ➔ Push to select an operating channel. When [Rotary selector] selection mode is “operating channel,” this function is not available.
- ➔ Push to select a scan group after pushing and holding [Scan].

### **ZONE KEY “ZONE”**

Push this key, then push [CH Up] or [CH Down] to select the desired zone.

When [Rotary selector] selects “operating zone,” push this key to switch the range of selectable zones.

▨ **What is “zone”?**— Selected channels are assigned to a zone according to how they are to be used in a group. For example, ‘Staff A’ and ‘Staff B’ are assigned into a “Business” zone, and ‘John’ and ‘Cindy’ are assigned into a “Private” zone.

### **USER SET MODE KEY “SET”**

- ➔ Push and hold for 1 sec. to enter user set mode.
  - During in the user set mode, push this key to select an item that is enabled by your dealer, and change the value or condition by pushing [CH Up] or [CH Down].
- ➔ Push and hold this key for 1 sec. again to exit user set mode.

▨ User set mode is also available via the ‘Power ON function.’ Refer to p. 14 also.

**CLOCK KEY “CLK”**

Push to indicate the current time on the LCD. (p. 15)

- While the current time is indicated, push and hold this key for 1 sec. to enter the time data edit mode.

**SCAN ADD/DEL (TAG) KEY “SCAD”**

- ➔ Push to add the selected channel to or delete it from the scan list.
  1. Push to indicate the scan list, then push [CH Up] or [CH Down] to select the desired list.
  2. Push to add the channel to or delete it from the selected scan list.
  3. Push and hold for 1 sec. to exit the scan list selection mode.
- ➔ While a scan is paused on a non-priority channel, push this key to delete the selected channel from the scan group.
  - Depending on the pre-setting, the deleted channel is added to the scan group again, after the scan is canceled. (Nuisance Delete function)

**MENU ◀ AND MENU ▶ KEYS**

([Menu ◀] and [Menu ▶]) can only be assigned to [◀] and [▶], respectively.)

The menu mode is available when either [Menu ◀] or [Menu ▶] is assigned to [◀] or [▶].

During menu mode, the pre-programmed menu items (up to 15) become effective with [I], [II] and [III] keys.

Push [Menu ◀]/[Menu ▶] to switch the previous/next 3 menu items, and push [I], [II] or [III] to activate the programmed function.

*During menu mode*

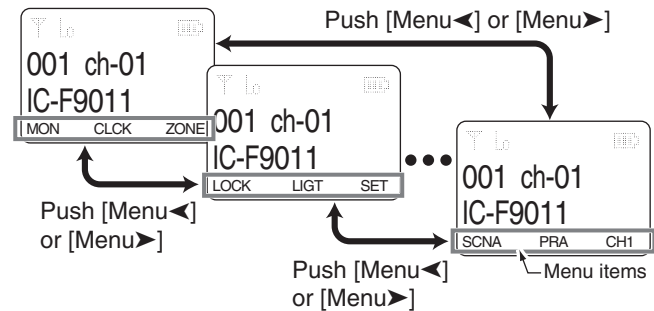

---

## 2 PANEL DESCRIPTION

### ◇ For ABC and Toggle switches only

#### **ZONE SWITCH**

Selects the pre-programmed zone directly.

#### **PRIO A AND PRIO B SWITCHES**

Selects Priority A or Priority B channel.

#### **MR-CH 1, MR-CH 2, MR-CH 3 AND MR-CH 4 SWITCHES**

Selects the memory channels 1, 2, 3 and 4, directly.

#### **TALK AROUND SWITCH** (Conventional operation only)

Turns the talk around function ON and OFF.

- The talk around function equalizes the transmit frequency to the receive frequency for transceiver-to-transceiver communication.

#### **LOCK SWITCH**

Turns the lock function ON and OFF.

All programmable keys except the following are locked:  
[PTT], [Moni], [Light], [Lock], [Emergency], [Surveillance]  
and [OPT 1/2/3].

#### **HIGH/LOW SWITCH**

Selects the transmit output power temporarily.

- Ask your dealer for the output power level for each selection.

#### **SURVEILLANCE SWITCH**

Turns the surveillance function ON or OFF.

When this function is turned ON, the beep is not emitted and the LCD backlight does not light when a signal is received or a key is pushed, etc.

#### **COMPANDER SWITCH**

Turns the compander function ON and OFF.

The compander function reduces noise components from the transmitted audio to provide clear communication.

#### **OPT MOMENTARY SWITCHES**





Controls the output signal level from the optional unit connector.



## ■ Turning power ON

- Prior to using the transceiver for the first time, the battery pack must be fully charged for optimum life and operation. (p. 17)
- When you use the transceiver for the first time, or after the transceiver has sat unused for a long time, make sure to check the date and time indication after turning the power ON. If the time and date are not correct, reset them. (p. 15)

- ① Rotate [VOL] to turn the power ON.
- ② If the transceiver is programmed for a start up password, input the digit codes as directed by your dealer.
  - 10-keypad can be used for password input depending on version.
  - The keys in the table below can be used for password input.
  - The transceiver detects numbers in the same block as identical. Therefore "01234" and "56789" are the same.

KEY					
NUMBER	0	1	2	3	4
	5	6	7	8	9

- ③ When the "PASSWORD" indication does not clear after inputting 6 digits, the input code number may be incorrect. Turn the power OFF and start over in this case.

When you operate Non-display type, the password setting is not available.

## ■ Channel selection

Several types of channel selections are available. Methods may differ according to your system set up.

**NOTE:** Depending on the pre-setting, "EMPTY" appears on the LCD when selecting an empty channel (no frequency is programmed). (Simple/10-key types only)

### NON-ZONE TYPE:

To select the desired operating channel:

- Push [CH Up] or [CH Down].
- Rotate [ROTARY SELECTOR]\*.
  - Up to pre-programmed 16 channels can be selected.
- Push one of [MR-CH 1] to [MR-CH 4].

### ZONE TYPE:

To select the desired zone:

- Push [Zone], then push [CH Up] or [CH Down].
- Rotate [ROTARY SELECTOR]\*.
  - Up to pre-programmed 16 zones can be selected.

### AUTOMATIC SCAN TYPE:

Channel setting is not necessary for this type. When turning power ON, the transceiver automatically starts scanning. Scanning stops when receiving a call.

\* Depending on the pre-setting.

When [Rotary selector] selects "Operating channel," [CH Up]/[CH Down] are not available, and when [Rotary selector] selects "Operating zone," [Zone]/[Zone Up]/ [Zone Down] are not available.

---

## 3 BASIC OPERATION

### ■ Receiving and transmitting

▨ **NOTE:** Transmitting without an antenna may damage the transceiver. See p. 1 for accessory attachments.

#### **Receiving:**

- ① Rotate [VOL] to turn the power ON.
- ② Push [CH Up] or [CH Down], or rotate [ROTARY SELECTOR]\* to select a channel, in sequence.  
\*Depending on the pre-setting.
- ③ When receiving a call, adjust the audio output level to a comfortable listening level.

#### **Transmitting:**

Wait for the channel to become clear to avoid interference.

- ① While pushing and holding [PTT], speak into the microphone at a normal voice level.
- ② Release [PTT] to return to receive.

▨ **IMPORTANT:** To maximize the audio quality of your signal;

1. Pause briefly after pushing [PTT].
2. Hold the microphone 5 to 10 cm (2 to 4 in.) from your mouth, then speak into the microphone at a normal voice level.

#### ◇ **Transmitting notes**

##### • **Transmit inhibit function**

The transceiver has several inhibit functions which restrict transmission under the following conditions:

- The channel is in mute condition ('Inaudible' condition; "🔇" does not appear.)
- The channel is busy.
- Un-matched (or matched) CTCSS is received. (Depending on the pre-setting.)
- Un-matched (or matched) NAC is received\*. (Depending on the pre-setting.)  
\*Digital mode operation only.
- The selected channel is a 'receive only' channel.

##### • **Time-out timer**

After continuous transmission for the pre-programmed time period, the time-out timer is activated, causing the transceiver to stop transmitting.

##### • **Penalty timer**

Once the time-out timer is activated, transmission is further inhibited for a period determined by the penalty timer.

## ■ User set mode

The user set mode is accessed at power ON and allows you to set seldom-changed settings. You can “customize” the transceiver operation to suit your preferences and operating style.

When you operate Non-display type, this function is not available.

### Entering the user set mode:

- ① While pushing and holding [I] and [II], rotate [VOL] to turn the power ON.
  - Turn power OFF in advance.
  - “SET MODE” appears for 1 sec. at power ON.

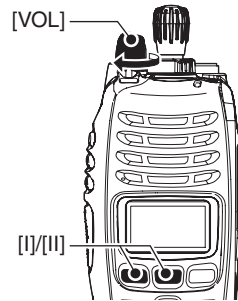

- ② Push and hold [◀] to enter user set mode.



- ③ Push [◀] several times to select the appropriate item. Then push [▲] or [▼] to set the desired level/condition.
  - Available set mode functions are **Backlight, LCD contrast, Beep, Beep Level, Ringer Level, SQL Level, AF Min Level, Mic Gain, VOX Gain\*, VOX Delay\*, Horn, Battery Voltage, Signal Moni, Lone Worker and System info.**
  - \* Appears only when the external VOX unit is connected.
- ④ Push and hold [◀] again to exit [▲]/[▼]

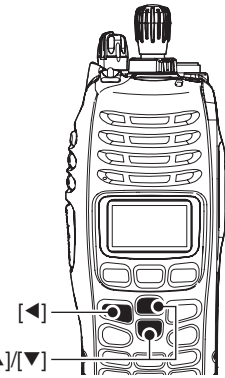

3

User set mode is also available using a programmable key. Refer to p. 9 [User Set Mode] section for instructions regarding using the key assigned for user set mode. [User Set Mode] allows for quick item selection. Set “Enable” for the often used items with the CS-F9010/F9510 CLONING SFOTWARE. Ask your dealer for details.

**NOTE:** While in the user set mode, [◀], [▲] and [▼] activate regardless of the assigned key functions.

### 3 BASIC OPERATION

## ■ Clock function

The transceiver indicates the current time and date when [Clock] is pushed. And you can change the indication format and time/date settings.

When you operate Non-display type, this function is not available.

When you use the transceiver for the first time, or after the transceiver has sat unused for a long time, make sure to check the date and time indication after turning the power ON. If the time and date are not correct, reset them. (See 'Time and date settings' to the right.)

### ◇ Time and date indication

- Push [Clock] to indicate the current time and date on the LCD.
  - When the indication format is set to 12-hour, "AM" or "PM" is indicated.
  - The LCD indication returns to the stand-by mode after 30 sec. has passed with no operation.

The time indication format (12-hour/24-hour)

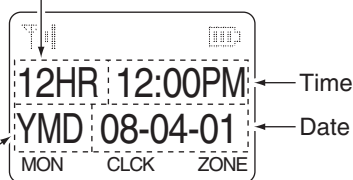

Date indication format (Y: Year, M: Month, D: Day)

- Push [Clock] again to return to the stand-by mode.

### ◇ Time and date settings

- Push [Clock] to indicate the current time and date on the LCD.

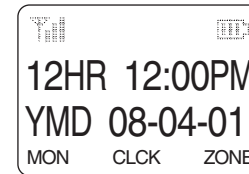

- Push and hold [Clock] for 1 sec. to enter the time and date setting mode.
  - The time indication format, "24HR" or "12HR" blinks.

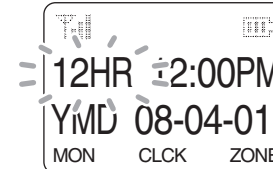

- Push [Clock] to select the desired item to be changed.

- ④ Push [CH Up] or [CH Down] to set the selected item.

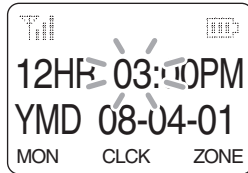

- ⑤ Push [Clock] to set.  
• The next item blinks.

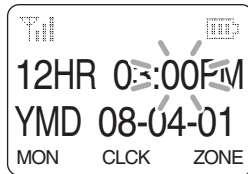

- ⑥ Repeat steps ③ to ⑤ to set items.  
⑦ After setting, push and hold [Clock] for 1 sec. to program.  
• Return to the time and date setting mode.  
⑧ Push [Clock] to return to the stand-by mode.

## LED indicator (Non-display type only)

The LED indicator indicates some information as follows;  
(Ref.; R=Red, G=Green, O=Orange)

- TX: Lights Red while transmitting a signal.
- TX low BATT1: TX is performed at Low BATT1.
- TX low BATT2: Low BATT2 was detected during TX mode.
- Fast/Slow scan: Blinks while Fast/Slow scan is activated.
- RX: Turns Green while receiving a signal.
- Low BATT1: You should charge the battery. (blinks slowly)
- Low BATT2: You must charge the battery. (blinks fast)
- CH err: Non-programmed channel is selected.

\* Lights (or blinks) orange when the optional battery case is attached.

# 4

## BATTERY CHARGING

### ■ Caution

Misuse of Lithium-Ion batteries may result in the following hazards: smoke, fire, or the battery may rupture. Misuse can also cause damage to the battery or degradation of battery performance.

- ⚠ **DANGER!** Use and charge only specified Icom battery packs with Icom radios or Icom chargers. Only Icom battery packs are tested and approved for use and charge with Icom radios or Icom chargers. Using third-party or counterfeit battery packs or chargers may cause smoke, fire, or cause the battery to burst.

#### ◇ Battery caution

- ⚠ **DANGER! DO NOT** hammer or otherwise impact the battery. Do not use the battery if it has been severely impacted or dropped, or if the battery has been subjected to heavy pressure. Battery damage may not be visible on the outside of the case. Even if the surface of the battery does not show cracks or any other damage, the cells inside the battery may rupture or catch fire.

- ⚠ **DANGER! NEVER** use or leave battery packs in areas with temperatures above +60°C (+140°F). High temperature buildup in the battery, such as could occur near fires or stoves, inside a sun heated car, or in direct sunlight may cause the battery to rupture or catch fire. Excessive temperatures may also degrade battery performance or shorten battery life.
- ⚠ **DANGER! DO NOT** expose the battery to rain, snow, seawater, or any other liquids. Never charge or use a wet battery. If the battery gets wet, be sure to wipe it dry before using.
- ⚠ **DANGER! NEVER** incinerate used battery packs since internal battery gas may cause them to rupture, or may cause an explosion.
- ⚠ **DANGER! NEVER** solder the battery terminals or NEVER modify the battery pack. This may cause heat generation, and the battery may rupture, emit smoke or catch fire.
- ⚠ **DANGER!** Use the battery only with the transceiver for which it is specified. Never use a battery with any other equipment, or for any purpose that is not specified in this instruction manual.
- ⚠ **DANGER!** If fluid from inside the battery gets in your eyes, blindness can result. Rinse your eyes with clean water, without rubbing them, and see a doctor immediately.

- **⚠ WARNING!** Immediately stop using the battery if it emits an abnormal odor, heats up, or is discolored or deformed. If any of these conditions occur, contact your Icom dealer or distributor.
- **⚠ WARNING!** Immediately wash, using clean water, any part of the body that comes into contact with fluid from inside the battery.
- **⚠ WARNING! NEVER** put the battery in a microwave oven, high-pressure container, or in an induction heating cooker. This could cause a fire, overheating, or cause the battery to rupture.
- **CAUTION:** Always use the battery within the specified temperature range for the transceiver ( $-30^{\circ}\text{C}$  to  $+60^{\circ}\text{C}$ ;  $-22^{\circ}\text{F}$  to  $+140^{\circ}\text{F}$ ) and the battery itself ( $-20^{\circ}\text{C}$  to  $+60^{\circ}\text{C}$ ;  $-4^{\circ}\text{F}$  to  $+140^{\circ}\text{F}$ ). Using the battery out of its specified temperature range will reduce the battery's performance and battery life.
- **CAUTION:** Shorter battery life could occur if the battery is left fully charged, completely discharged, or in an excessive temperature environment (above  $+45^{\circ}\text{C}$ ;  $+113^{\circ}\text{F}$ ) for an extended period of time. If the battery must be left unused for a long time, it must be detached from the radio after discharging. You may use the battery until the remaining capacity is about half, then keep it safely in a cool dry place with the temperature range as below;
  - $-20^{\circ}\text{C}$  to  $+45^{\circ}\text{C}$  ( $-4^{\circ}\text{F}$  to  $+113^{\circ}\text{F}$ ) (within a month)
  - $-20^{\circ}\text{C}$  to  $+35^{\circ}\text{C}$  ( $-4^{\circ}\text{F}$  to  $+95^{\circ}\text{F}$ ) (within three months)
  - $-20^{\circ}\text{C}$  to  $+25^{\circ}\text{C}$  ( $-4^{\circ}\text{F}$  to  $+77^{\circ}\text{F}$ ) (within a year)

#### ◇ Charging caution

- **⚠ DANGER! NEVER** charge the battery pack in areas with extremely high temperatures, such as near fires or stoves, inside a sun heated car, or in direct sunlight. In such environments, the safety/protection circuit in the battery will activate, causing the battery to stop charging.
- **⚠ WARNING! NEVER** charge or leave the battery in the battery charger beyond the specified time for charging. If the battery is not completely charged by the specified time, stop charging and remove the battery from the battery charger. Continuing to charge the battery beyond the specified time limit may cause a fire, overheating, or the battery may rupture.
- **⚠ WARNING! NEVER** insert the transceiver (battery attached to the transceiver) into the chargers if it is wet or soiled. This could corrode the battery charger terminals or damage the chargers. The chargers are not waterproof.
- **CAUTION: NEVER** charge the battery outside of the specified temperature range:  $0^{\circ}\text{C}$  to  $+40^{\circ}\text{C}$  ( $+32^{\circ}\text{F}$  to  $+104^{\circ}\text{F}$ ). Icom recommends charging the battery at  $+20^{\circ}\text{C}$  ( $+68^{\circ}\text{F}$ ). The battery may heat up or rupture if charged out of the specified temperature range. Additionally, battery performance or battery life may be reduced.

## 4 BATTERY CHARGING

### ■ Optional battery chargers

#### ◇ AD-110 installation

The AD-110 CHARGER ADAPTER must be installed into the BC-119N or BC-121N before battery charging.

- ① Attach the plugs from the BC-119N/BC-121N to the AD-110 CHARGER ADAPTER.
- ② Secure the AD-110 into the holder space of the BC-119N or BC-121N with the supplied screws.

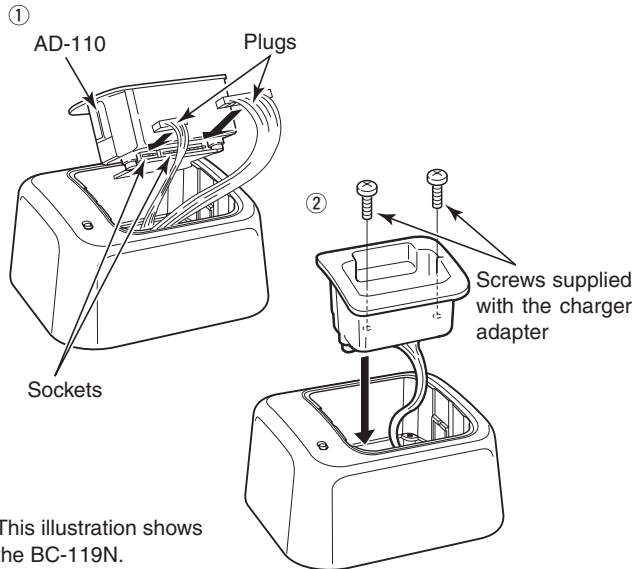

#### ◇ Rapid charging with the BC-119N+AD-110

The optional BC-119N provides rapid charging of the Li-Ion battery pack. Charging period: Approx. 4 hours (with BP-254)

The following items are additionally required.

- AD-110 CHARGER ADAPTER (purchase separately)
- An AC adapter (may be supplied with BC-119N depending on version) or the DC power cable (OPC-515L/CP-23L).

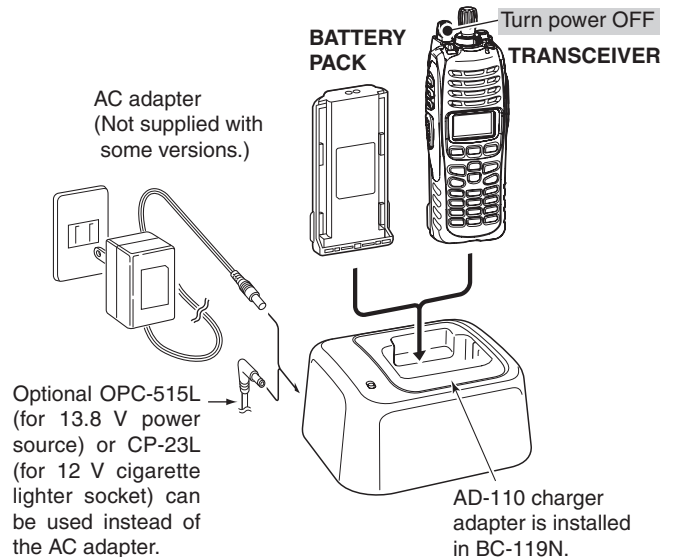



◇ **Rapid charging with the BC-121N+AD-110**

The optional BC-121N allows up to 6 battery packs to be charged simultaneously. Charging period: Approx. 4 hours (with BP-254)

The following items are additionally required.

- Six AD-110 CHARGER ADAPTERS (purchase separately)
- An AC adapter (BC-157S) or the DC power cable (OPC-656)

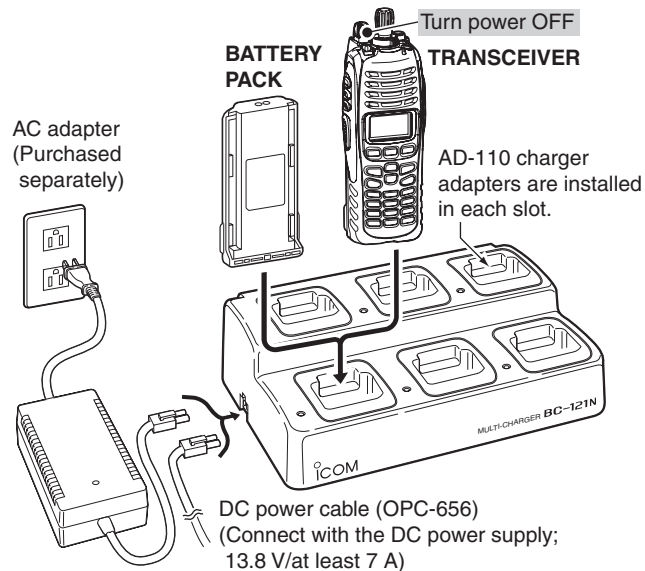

**IMPORTANT: Battery charging caution**  
 Ensure the guide tabs on the battery pack are correctly aligned with the guide rails inside the charger adapter.  
 (This illustration shows the BC-119N.)

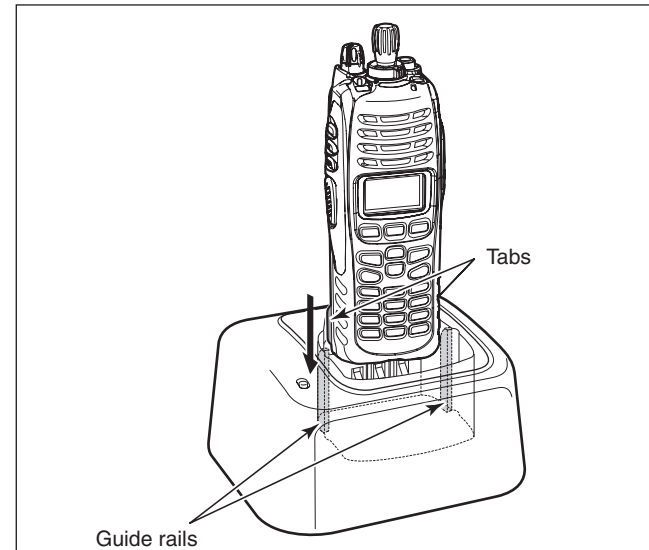

# 5

## BATTERY CASE

### ■ Optional battery case (BP-237)

The optional battery case uses 6 × AA (LR6) size alkaline batteries. The battery case offers low output power.

- ① Hook your finger under the latch, and open the cover in the direction of the arrow (①). (Fig.1)
- ② Then, install 6 × AA (LR6) size alkaline batteries. (Fig.2)
  - Install the alkaline batteries only.
  - Be sure to observe the correct polarity.
  - Do not pin the ribbon under the batteries.
- ③ Close the cover by fitting in the direction of the arrow (②) first, then check the latch is in place (③). (Fig.1)
  - Be sure the gasket is set correctly, and do not protrude from the battery case. (Fig.3)

#### CAUTION:

- When installing batteries, make sure they are all the same brand, type and capacity. Also, do not mix new and old batteries together.
- Keep battery terminals clean. It's a good idea to clean battery terminals once a week.
- Never incinerate used battery cells since internal battery gas may cause them to rupture.
- Never expose a detached battery case to water. If the battery case gets wet, be sure to wipe it dry before using it.

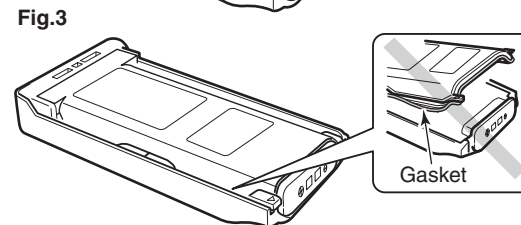
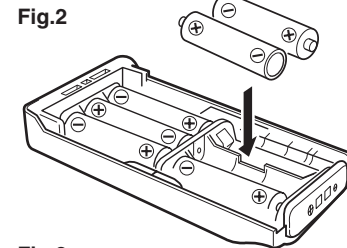
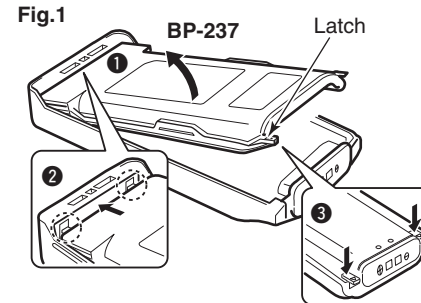

## ■ Optional HM-184 description

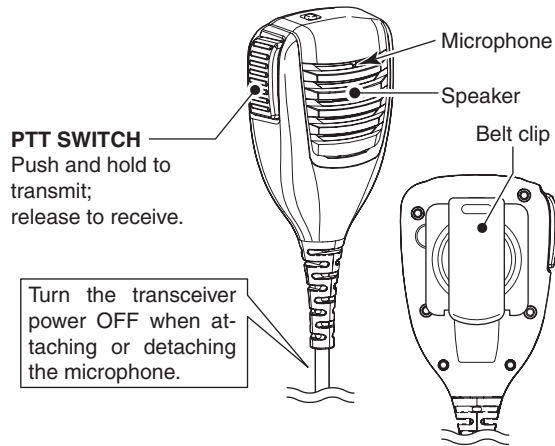

**NEVER** immerse the connector in water. If the connector gets wet, be sure to dry it **BEFORE** attaching it to the transceiver.

**NOTE:** The microphone is located as shown in the diagram above. To maximize the readability of your transmitted signal (voice), hold the microphone approx. 5 to 10 cm (2 to 4 in.) from your mouth, and speak in a normal voice level.

## ■ To attach

Attach the connector of the speaker-microphone into the multi connector on the transceiver and tighten the screw with a coin or flat head screwdriver.

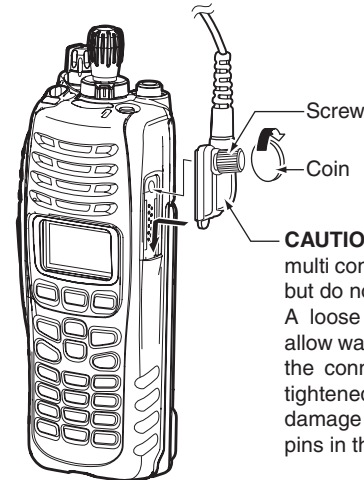

**IMPORTANT: KEEP** the connector cover attached to the transceiver when the speaker-microphone is not in use. (p. 3)  
Water will not get into the transceiver even if the cover is not attached; however, the terminals (pins) will become rusty, or the transceiver will function abnormally if the connector gets wet.

### ◇ BATTERY PACKS

Battery pack	Voltage	Capacity	Battery life*3
<b>BP-254</b> *1	7.4 V	2900 mAh (min.) 3040 mAh (typ.)	9.5 hrs.
<b>BP-237</b> *2	Battery case for A6 × AA (LR6) alkaline		—*4

\*1 The BP-254 meets IPX7\* requirements for waterproof protection. When it is connected, the transceiver corresponds to IPX7.

\*2 The BP-237 meets IPX4\* requirements for splash resistance. When it is connected, the transceiver corresponds to IPX4.

\*3 When the power save function is turned ON, and the operating periods are calculated under the following conditions;  
TX : RX : standby = 5 : 5 : 90

\*4 Operating period depends on the alkaline cells used.

### ◇ CHARGERS

- **BC-119N** DESKTOP CHARGER + **AD-110** CHARGER ADAPTER + **BC-145S** AC ADAPTER

For rapid charging of battery pack. An AC adapter is supplied with the charger depending on versions.

Charging time: approx. 4 hours when BP-254 is attached.

- **BC-121N** MULTI-CHARGER + **AD-110** CHARGER ADAPTER (6 pcs.) + **BC-157S** AC ADAPTER

For rapid charging of up to 6 battery packs (six AD-110s are required) simultaneously. An AC adapter should be purchased separately.

Charging time: approx. 4 hours when BP-254 is attached.

### ◇ CABLES

- **CP-23L** CIGARETTE LIGHTER CABLE

Allows charging of the battery pack through a 12 V cigarette lighter socket. (For BC-119N)

- **OPC-515L/OPC-656** DC POWER CABLES

Allows charging of the battery pack using a 13.8 V power source instead of the AC adapter.

OPC-515L : For BC-119N

OPC-656 : For BC-121N

- **OPC-1870/OPC-1871** ZONE COPY CABLES

OPC-1870 : Portable to portable zone copy cable.

OPC-1871 : Portable to mobile zone copy cable.

See the operating guide for details.

### ◇ OPTIONAL UNITS

- **UT-124R** MAN DOWN UNIT

Provides a measure of safety when working in a hazardous environment, etc.

- **UT-125** AES/DES ENCRYPTION UNIT

- **UT-128** DES ENCRYPTION UNIT

### ◇ ANTENNAS

- **FA-S25V/S65V/S66V/S30U/S58U/S75U** FLEXIBLE ANTENNAS

FA-S25V : 136–148 MHz

FA-S30U : 380–430 MHz

FA-S65V : 148–160 MHz

FA-S58U : 430–470 MHz

FA-S66V : 160–174 MHz

FA-S75U : 470–520 MHz

- **FA-S67VC/S76UC** CUT ANTENNA

FA-S67VC : 136–174 MHz

FA-S76UC : 380–520 MHz

◇ OTHER OPTIONS

• **MB-115** BELT CLIP

Exclusive alligator-type belt clip.

• **AD-118** ACC ADAPTER

Allows you to connect an accessory which uses a HIROSE plug. See the instruction sheet of the AD-118 for details of the recommended accessories.

**CAUTION:** The AD-118 does not have any waterproof protection. When it is connected, **NEVER** expose the adapter and the transceiver to rain, snow or any liquids.

• **HM-184** SPEAKER-MICROPHONE

Rugged type speaker-microphone.

The HM-184 meets IP57\* requirements for waterproof protection.

• **VS-1MC** VOX/PTT CASE + **HS-94/HS-95/HS-97** HEADSET

VS-1MC : VOX/PTT switch box for hands-free operation, etc.

HS-94 : Ear-hook type

HS-95 : Neck-arm type

HS-97 : Throat microphone

These items have IPX4\* waterproof protection. When in use, the transceiver's waterproof rating meets IPX4 when they are connected.

\* Once these items have been dropped, the IP rating cannot be guaranteed because of possible damage to these cases or the waterproof seal.

Some options may not be available in some countries. Please ask your dealer for details.

◇ About VS-1MC VOX/PTT CASE

The VS-1MC is a VOX/PTT unit for Icom handheld transceivers, and allows you hands-free operation.

An optional headset (HS-94, etc.) is required for operation.

- The VOX (Voice Operated Transmission) function starts transmission without pushing PTT switch when you speak into the microphone; then, automatically returns to receive when you stop speaking.

**Features**

- ➔ 14-pin Spring-plug type head SP/MIC plug is equipped
- ➔ Water resistant construction
- ➔ Durable construction
- ➔ Equipped with a PTT switch and revolving clip

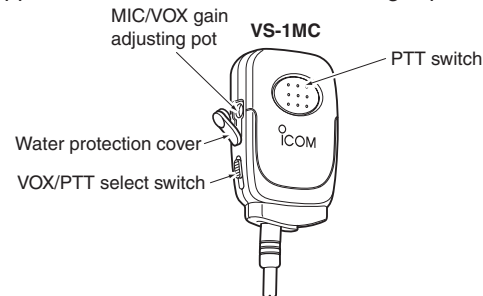

☞ Continues to the next page

## 7 OPTIONS

◇ About VS-1MC VOX/PTT CASE (Continued)

### **VOX gain and delay adjustment**

- ① Attach the connector of the VS-1MC into the multi-connector on the transceiver and tighten the screw.
  - Toggle the VOX/PTT select switch to [VOX].
- ② Enter user set mode. (p. 14)
- ③ Push [◀] several times to select the “VOX Gain” or “VOX Delay” items. Then, push [▲] or [▼] to set the desired level/condition.
- ④ Push and hold [◀] again to exit the user set mode.
  - Until turning power OFF, [◀], [▲] and [▼] is not activated as the assigned key function.

⚡ These adjustments are for Simple/10-key types only.

#### **• VOX Gain**

The VOX sensitivity level can be adjusted from OFF or 1 to 6 (more sensitive).

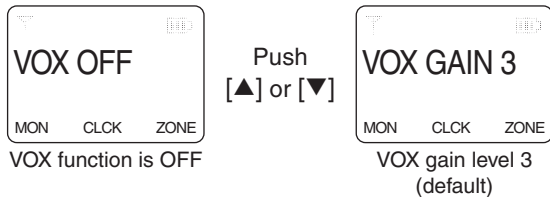

#### **• VOX Delay**

The VOX delay time can be set from 0.5 to 3.0 sec. (0.5 sec. step) for a convenient interval before returning to receive.

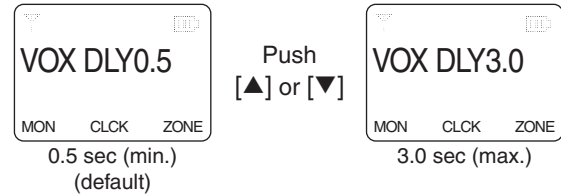

⚡ If your voice is detected, “TX” appears on the LCD as shown below during the VOX gain or VOX delay adjustment. (The transmission is not performed.)

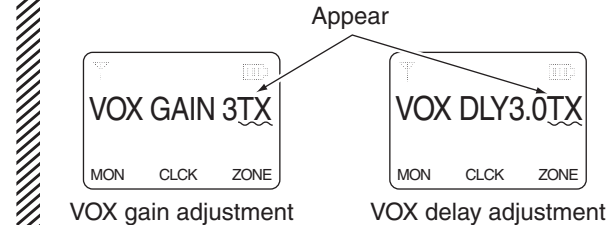

⚡ **NOTE:** MIC/VOX gain can be adjusted via the Adjusting pot using a thin screw driver.



**WARNING**

Your Icom radio generates RF electromagnetic energy during transmit mode. This radio is designed for and classified as “Occupational Use Only”, meaning it must be used only during the course of employment by individuals aware of the hazards, and the ways to minimize such hazards. This radio is NOT intended for use by the “General Population” in an uncontrolled environment.

This radio has been tested and complies with the FCC RF exposure limits for “Occupational Use Only”. In addition, your Icom radio complies with the following Standards and Guidelines with regard to RF energy and electromagnetic energy levels and evaluation of such levels for exposure to humans:

- FCC OET Bulletin 65 Edition 97-01 Supplement C, Evaluating Compliance with FCC Guidelines for Human Exposure to Radio Frequency Electromagnetic Fields.
- American National Standards Institute (C95.1-1992), IEEE Standard for Safety Levels with Respect to Human Exposure to Radio Frequency Electromagnetic Fields, 3 kHz to 300 GHz.
- American National Standards Institute (C95.3-1992), IEEE Recommended Practice for the Measurement of Potentially Hazardous Electromagnetic Fields— RF and Microwave.
- The following accessories are authorized for use with this product. Use of accessories other than those specified may result in RF exposure levels exceeding the FCC requirements for wireless RF exposure.; Belt Clip (MB-115), Rechargeable Li-Ion Battery Pack (BP-254), Alkaline Battery Case (BP-237), Speaker-microphone (HM-184), VOX/PTT case (VS-1MC) and ACC adapter (AD-118).



**CAUTION**

**To ensure that your exposure to RF electromagnetic energy is within the FCC allowable limits for occupational use, always adhere to the following guidelines:**

- **DO NOT** operate the radio without a proper antenna attached, as this may damage the radio and may also exceed FCC RF exposure limits. A proper antenna is the antenna supplied with this radio by Icom Inc. or antenna specifically authorized by Icom Inc. for use with this radio.
- **DO NOT** transmit for more than 50% of total radio use time (“50% duty cycle”). “50% duty cycle” is also applicable to PSTN (Public Switched Telephone Network) mode. Transmitting more than 50% of the time can cause FCC RF exposure compliance requirements to be exceeded. The radio is transmitting when the TX indicator lights red. You can cause the radio to transmit by pressing the “PTT” switch.
- **ALWAYS keep** the antenna at least 2.5 cm (1 in.) away from the body when transmitting and only use the Icom belt-clips listed on p. 24 when attaching the radio to your belt, etc., to ensure FCC RF exposure compliance requirements are not exceeded. To provide the recipients of your transmission the best sound quality, hold the antenna at least 5 cm (2 in.) from your mouth, and slightly off to one side.

The information listed above provides the user with the information needed to make him or her aware of RF exposure, and what to do to assure that this radio operates with the FCC RF exposure limits of this radio.

### **Electromagnetic Interference/Compatibility**

During transmissions, your Icom radio generates RF energy that could possibly cause interference with other devices or systems. To avoid such interference, turn off the radio in areas where signs are posted to do so. **DO NOT** operate the transmitter in areas that are sensitive to electromagnetic radiation such as hospitals, aircraft, and blasting sites.

### **Occupational/Controlled Use**

The radio transmitter is used in situations in which persons are exposed as consequence of their employment provided those persons are fully aware of the potential for exposure and can exercise control over their exposure.

**Count on us!**

A-6662D-1US-⑤

Printed in Japan

© 2008–2010 Icom Inc.

Printed on recycled paper with soy ink.

**Icom Inc.**

1-1-32 Kamiminami, Hirano-ku, Osaka 547-0003, Japan