

■ R - RR

DR (D-STAR Repeater) mode is used for the D-STAR repeater operation. In this mode, you can select the pre-programmed repeaters and your call sign by using [DIAL].

① Push [DR] to enter DR mode.

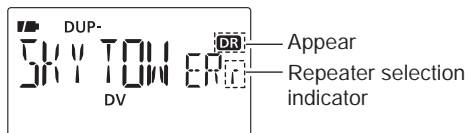

② Select the repeater group.

Selecting the repeater group

① Push [L], then rotate [L] to select the desired repeater group.

- Only assigned groups from GRP 1 GRP 9 and GRP 0 are selectable.

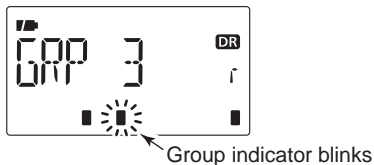

② Push [L] again to release the group selection.

- Push [9] to select the repeater group directly.

③ Rotate [L] to select the access repeater.

- Only the repeaters that are programmed access repeater settings, are selectable.
- Group indicator appears momentarily when rotating [L].

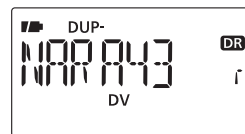

④ Push and hold [R] for 1 sec. to enter the your call sign selection.



⑤ Select the group as step ②.

- Only assigned GRP 1 GRP 9, GRP 0, GRP UR and GRP CQ are selectable.
- UR (your) call signs are selectable in GRP UR. "CQCQCQ" is selectable in GRP CQ.
- Push [L] several times to select "GRP UR," "GRP CQ" and "GRP RP."

7 DV MODE OPERATION



Continued instruction from step ⑤ on page 53.

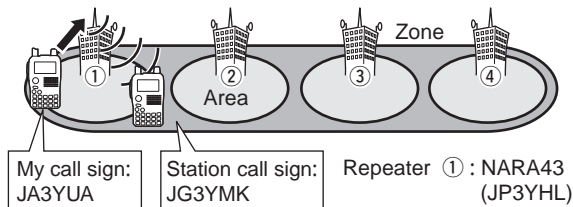

- ⑥ Rotate **L** to select a specified station call sign.
 - Push several times to select "GRP UR" in advance.
- ⑦ Push and hold **R ()** for 1 sec. to enter the link repeater (RPT2) selection.

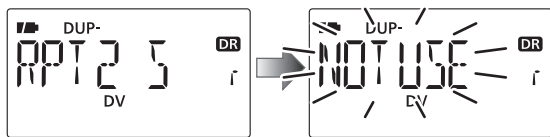

- ⑧ Rotate **L** to select "NOT USE."
- ⑨ Push **R ()** to exit the link repeater selection.
- ⑩ Push **P** to transmit; release to receive.



Continued instruction from step ⑤ on page 53.

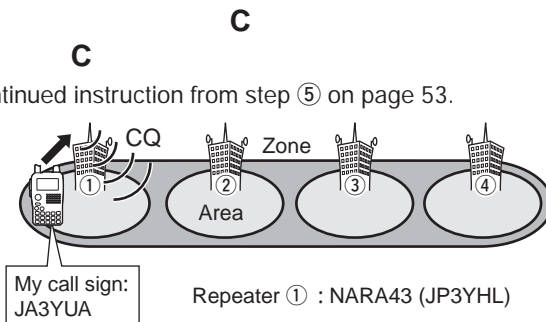

- ⑥ Push several times to select "GRP CQ," then "CQCQCQ" is selected as your call sign automatically.
 - The link repeater (RPT2) setting is set to "NOT USE" automatically.
- ⑦ Push **P** to transmit; release to receive.



Continued instruction from step ⑤ on page 53.

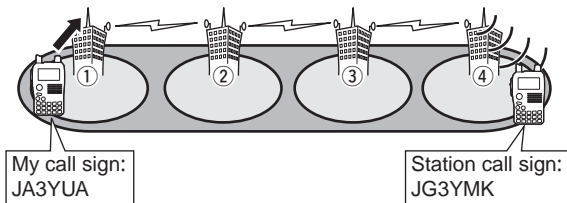

Repeater ① : NARA43 (JP3YHL)

Repeater ④ : IKOMA43 (JP3YHJ)

⑥ Rotate **L** to select a specified station call sign.
 • Push **F** several times to select "GRP UR" in advance.

⑦ Push and hold **R** () for 1 sec. to enter the link repeater (RPT2) selection.

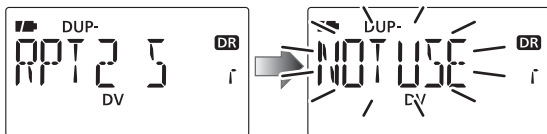

⑧ Rotate **L** to select the link repeater in the same zone.

⑨ Push **R** () to exit the link repeater selection.

⑩ Push **P** to transmit; release to receive.



Continued instruction from step ⑤ on page 53.

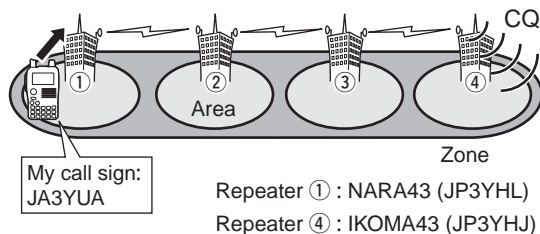

Repeater ① : NARA43 (JP3YHL)

Repeater ④ : IKOMA43 (JP3YHJ)

⑥ Rotate **L** to select a repeater call sign in the same zone.

• Push **F** several times to select "GRP RP" or push **F-9** to select the repeater group in advance.

• The link repeater (RPT2) setting is set to the selected repeater call sign automatically.

⑦ Push **P** to transmit; release to receive.

7 DV MODE OPERATION



Continued instruction from step ⑤ on page 53.

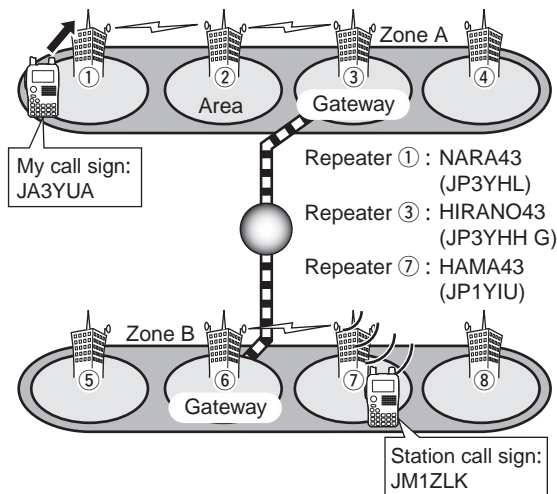

- ⑥ Rotate **L** to select a specified station call sign.
 - Push several times to select “GRP UR” in advance.
- ⑦ Push and hold **R** () for 1 sec. to enter the link repeater (RPT2) selection.

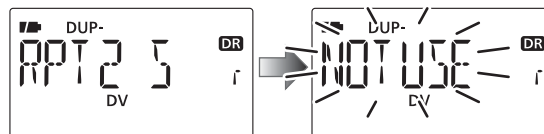

- ⑧ Rotate **L** to select the preset gateway repeater “GW” or other gateway repeater in the same zone.
 - Only the repeaters that have gateway capability appear.

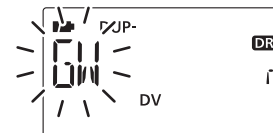

- ⑨ Push **R** () to exit the link repeater selection.
- ⑩ Push **P** to transmit; release to receive.

◇ **C**

Continued instruction from step ⑤ on page 53.

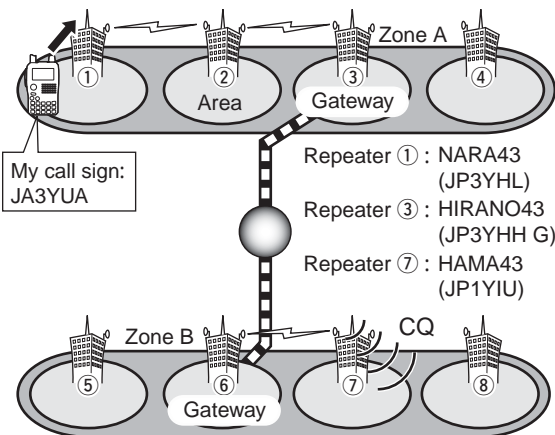

⑥ Rotate **L** to select a repeater call sign in the another zone.

- Push **L** several times to select "GRP RP" or push **9** to select the repeater group in advance.
- The link repeater (RPT2) setting is set to the preset gateway repeater call sign automatically.

⑦ Push **P** to transmit; release to receive.

◇ **C**

① Push and hold **C** (9) for 1 sec. to enter the setting confirmation screen.

- UR (your) call sign is displayed.

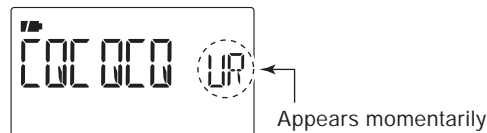

② Push **▲** (2) or **▼** (8) to select and confirm the other current call sign.

- ("UR"), "R1," "R2" and "MY" appears in sequence.

③ Push and hold **C** (9) for 1sec. to toggle the name indication and call sign indication.

- Name indication is available only for the repeater call sign that are programmed repeater name.



④ Push **C** (9) again to exit the setting confirmation screen.

7 DV MODE OPERATION



- ① Set the desired frequency. (p. 23)
 - Select output power, if desired. (p. 27)
- ② Select DV mode. (p. 25)
- ③ Set the current call sign as described at pages 47, 48.
 - Set specified station call sign to "UR."



- ④ Push and hold **P** to transmit and speak into the microphone at normal voice level.
 - Tx/Rx indicator lights red and the RF meter shows the output power.
- ⑥ Release **P** to return to receive.
 - The other station's call sign will be received.
 - Received call signs can be stored into the received call record automatically. See page 131 for details.

O The digital mode operation is vastly different from FM mode. One of the differences is that in digital mode the squelch does not function as in FM mode. Changing the squelch setting will not open it to hear the hiss of "white noise." It only activates for digital squelch functions such as CSQL (Digital code squelch) or D SQL (Digital call sign squelch).

• **C**

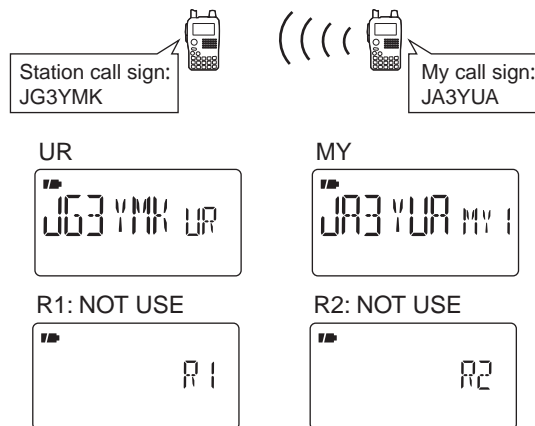

R

- ① Push and hold **R** () for 1 sec. to enter UR (your) call sign selection mode.
 - Push **R** several times to select "GRP CQ" (CQCQCQ) "GRP UR" (UR call sign memories) and "CS" (current call sign).
- ② Rotate **L** to select the desired call sign.
- ③ Push **R** () to return to frequency indication mode.



C

- ① Set the desired frequency. (p. 23)
 - Select output power, if desired. (p. 27)
- ② Select DV mode. (p. 25)
- ③ Set the current call sign as described at pages 47, 48.
 - Set specified station call sign to "UR."



- ④ Push and hold **P** to transmit and speak into the microphone at normal voice level.
 - Tx/Rx indicator lights red and the RF meter shows the output power.
- ⑥ Release **P** to return to receive.
 - The other station's call sign will be received.
 - Received call signs can be stored into the received call record automatically. See page 131 for details.

• **C**

C

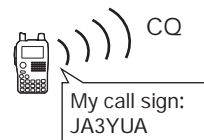

UR



R1: NOT USE

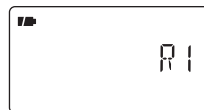

MY



R2: NOT USE

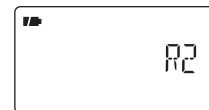

7 DV MODE OPERATION

■ - R



- ① Set the desired repeater's frequency, offset and shift direction (pgs. 23, 31), then select the DV mode (p. 25).
- ② Set the current your own call sign.
 - See p. ?? for current call sign setting detail.
- ③ Set the current station call sign as follow;
 - ① Push and hold **R** (.) for 1 sec. to enter UR (your) call sign selection mode, then .
 - ② Rotate **L** to select the desired station call sign.
 - Push several times to select "GRP UR" in advance.
 - ③ Push **R** (.) again to return to frequency indication.
- ④ Set the current repeater's call sign as follows;
 - ① Push and hold **C** (9) for 1 sec. to enter the current call sign mode.
 - UR (your) call sign is displayed.
 - Push and hold **C** (9) for 1 sec. to toggle the call sign and repeater name indications.
 - ② Push **▲** (2) or **▼** (8) to select "R1," access repeater's call sign, then push **←** (5) to enter the current call sign selection mode.
 - ③ Push **▲** (2) or **▼** (8) to select the desired access repeater's call sign, then push **←** 5 to set the call sign for "RPT1."
 - Return to the current call sign mode.

Pushing **R** selects the repeater group when selection.

O

- ④ Push **▲** (2) or **▼** (8) to select "R2," link repeater's call sign, then push **←** (5) to set the current call sign selection mode.
 - "RPT2" call sign screen is displayed.
- ⑤ Push **▲** (2) or **▼** (8) to select "NOT USE," then push **←** 5 .
 - Return to the current call sign mode.
- ⑥ Push **←** (5) to return to frequency indication.
- ⑤ Push **P** to transmit; release to receive.

• C

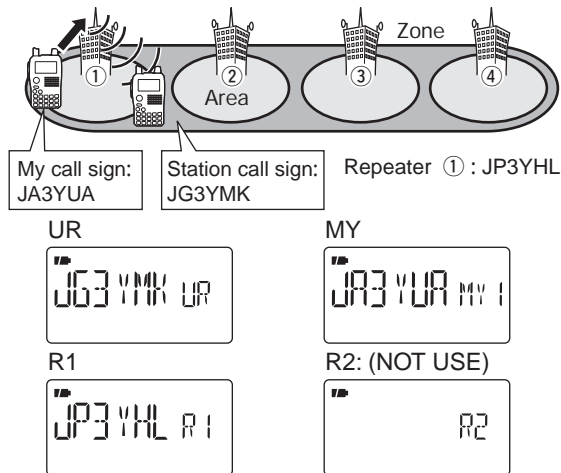

◇ C

- ① Set the desired repeater's frequency, offset and shift direction (pgs. 23, 31), then select the DV mode (p. 25).
- ② Set the current your own call sign.
 - See p. ?? for current call sign setting detail.
- ③ Set the current station call sign as follow;
 - ➔ Push and hold **R** (.) for 1 sec. to enter UR (your) call sign selection mode.
 - Push several times to select "GRP CQ," then "CQC-QCQ" is selected automatically.
- ④ Set the current repeater's call sign as follows;
 - ① Push and hold **C** (9) for 1 sec. to enter the current call sign mode.
 - UR (your) call sign is displayed.
 - Push and hold **C** (9) for 1 sec. to toggle the call sign and repeater name indications.
 - ② Push **▲** (2) or **▼** (8) to select "R1," access repeater's call sign, then push **←** (5) to enter the current call sign selection mode.
 - ③ Push **▲** (2) or **▼** (8) to select the desired access repeater's call sign, then push **←** 5 to set the call sign for "RPT1."
 - Return to the current call sign mode.
 - ④ Push **▲** (2) or **▼** (8) to select "R2," link repeater's call sign, then push **←** (5) to set the current call sign selection mode.
 - "RPT2" call sign screen is displayed.

Pushing selects the repeater group when selection.

C

- ⑤ Push **▲** (2) or **▼** (8) to select "NOT USE," then push **←** 5 .
 - Return to the current call sign mode.
- ⑥ Push to return to frequency indication.
- ⑤ Push **P** to transmit; release to receive.

• C

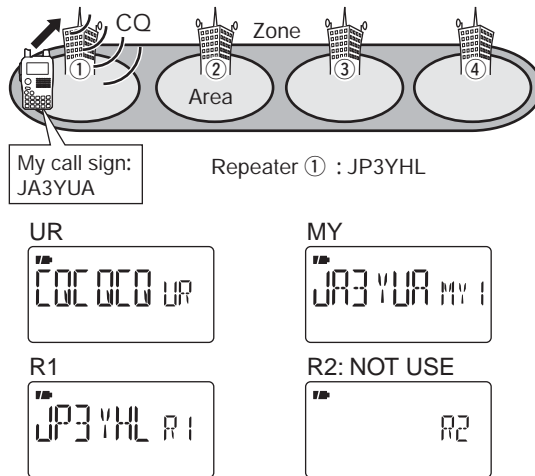

7 DV MODE OPERATION



- ① Set the desired repeater's frequency, offset and shift direction (pgs. 23, 31), then select the DV mode (p. 25).
- ② Set the current your own call sign.
 - See p. ?? for current call sign setting detail.
- ③ Set the current station call sign as follow;
 - ① Push and hold **R** (.) for 1 sec. to enter UR (your) call sign selection mode, then .
 - ② Rotate **L** to select the desired station call sign.
 - Push several times to select "GRP UR" in advance.
 - ③ Push **R** (.) again to return to frequency indication.
- ④ Set the current repeater's call sign as follows;
 - ① Push and hold **C** (9) for 1 sec. to enter the current call sign mode.
 - UR (your) call sign is displayed.
 - Push and hold **C** (9) for 1 sec. to toggle the call sign and repeater name indications.
 - ② Push **▲** (2) or **▼** (8) to select "R1," access repeater's call sign, then push **←** (5) to enter the current call sign selection mode.
 - ③ Push **▲** (2) or **▼** (8) to select the desired access repeater's call sign, then push **←** 5 to set the call sign for "RPT1."
 - Return to the current call sign mode.
 - ④ Push **▲** (2) or **▼** (8) to select "R2," link repeater's call sign, then push **←** (5) to set the current call sign selection mode.
 - "RPT2" call sign screen is displayed.

- ⑤ Push **▲** (2) or **▼** (8) to select the desired repeater call sign in the same zone, then push **←** 5 .
 - Return to the current call sign mode.
- ⑥ Push to return to frequency indication.
- ⑤ Push **P** to transmit; release to receive.

• C

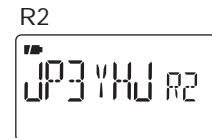
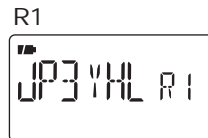
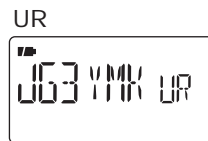
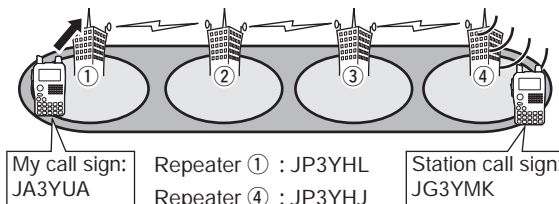

Pushing selects the repeater group when selection.



- ① Set the desired repeater's frequency, offset and shift direction (pgs. 23, 31), then select the DV mode (p. 25).
- ② Set the current your own call sign.
 - See p. ?? for current call sign setting detail.
- ③ Set the current station call sign as follow;
 - ➔ Push and hold **R** (.) for 1 sec. to enter UR (your) call sign selection mode.
 - Push **▲** several times to select "GRP CQ," then "CQC-QCQ" is selected automatically.
- ④ Set the current repeater's call sign as follows;
 - ① Push and hold **C** (9) for 1 sec. to enter the current call sign mode.
 - UR (your) call sign is displayed.
 - Push and hold **C** (9) for 1 sec. to toggle the call sign and repeater name indications.
 - ② Push **▲** (2) or **▼** (8) to select "R1," access repeater's call sign, then push **←** (5) to enter the current call sign selection mode.
 - ③ Push **▲** (2) or **▼** (8) to select the desired access repeater's call sign, then push **←** (5) to set the call sign for "RPT1."
 - Return to the current call sign mode.
 - ④ Push **▲** (2) or **▼** (8) to select "R2," link repeater's call sign, then push **←** (5) to set the current call sign selection mode.
 - "RPT2" call sign screen is displayed.

- ⑤ Push **▲** (2) or **▼** (8) to select the desired repeater call sign in the same zone, then push **←** (5) .
 - Return to the current call sign mode.
- ⑥ Push **←** (5) to return to frequency indication.
- ⑤ Push **P** to transmit; release to receive.

• C

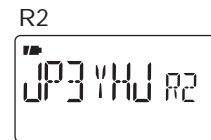
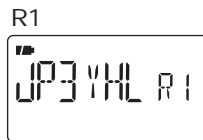
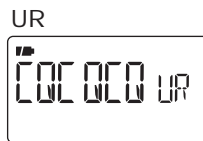
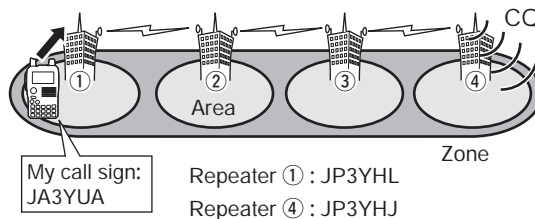

Pushing **▲** selects the repeater group when selection.

7 DV MODE OPERATION



- ① Set the desired repeater's frequency, offset and shift direction (pgs. 23, 31), then select the DV mode (p. 25).
- ② Set the current your own call sign.
 - See p. ?? for current call sign setting detail.
- ③ Set the current station call sign and repeater call signs as follow;

① Push and hold **C** (9) for 1 sec. to enter the current call sign mode.

- UR (your) call sign is displayed.
- Push and hold **C** (9) for 1 sec. to toggle the call sign and repeater name indications.

② Push **←** (5) to enter the current call sign selection mode.

③ Push **▲** (2) or **▼** (8) to select the desired station call sign, then push **←** 5 to set the call sign for "UR."

- Return to the current call sign mode.

④ Push **▲** (2) or **▼** (8) to select "R1," access repeater's call sign, then push **←** (5) to enter the current call sign selection mode.

⑤ Push **▲** (2) or **▼** (8) to select the desired access repeater's call sign, then push **←** 5 to set the call sign for "RPT1."

- Return to the current call sign mode.

⑥ Push **▲** (2) or **▼** (8) to select "R2," link repeater's call sign, then push **←** (5) to set the current call sign selection mode.

- "RPT2" call sign screen is displayed.

- ⑦ Push **▲** (2) or **▼** (8) to select the specified gateway repeater call sign in the same zone, then push **←** 5 .
 - Return to the current call sign mode.
- ⑧ Push **←** (5) to return to frequency indication.
- ⑤ Push **P** to transmit; release to receive.

• C

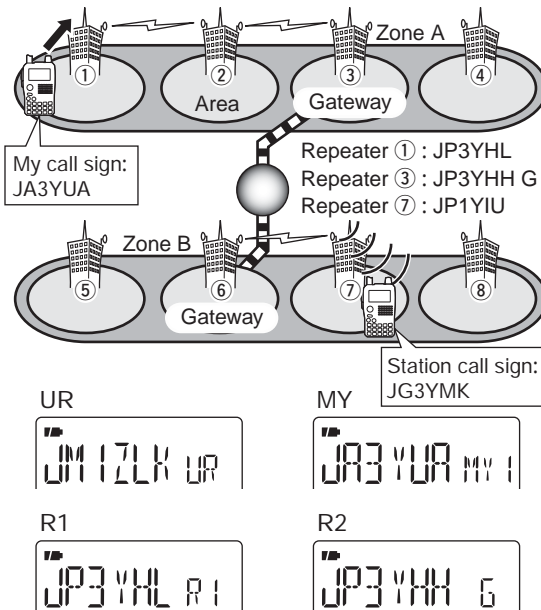

Pushing **←** (5) selects the repeater group when selection.

◇ C

- ① Set the desired repeater's frequency, offset and shift direction (pgs. 23, 31), then select the DV mode (p. 25).
- ② Set the current your own call sign.
 - See p. ?? for current call sign setting detail.
- ③ Set the current station call sign and repeater call signs as follow;
 - ① Push and hold **C** (9) for 1 sec. to enter the current call sign mode.
 - UR (your) call sign is displayed.
 - Push and hold **C** (9) for 1 sec. to toggle the call sign and repeater name indications.
 - ② Push **←** (5) to enter the current call sign selection mode.
 - ③ Push **▲** (2) or **▼** (8) to select the desired repeater call sign, then push **← 5** to set the call sign for "UR."
 - Return to the current call sign mode.
 - ④ Push **▲** (2) or **▼** (8) to select "R1," access repeater's call sign, then push **←** (5) to enter the current call sign selection mode.
 - ⑤ Push **▲** (2) or **▼** (8) to select the desired access repeater's call sign, then push **← 5** to set the call sign for "RPT1."
 - Return to the current call sign mode.
 - ⑥ Push **▲** (2) or **▼** (8) to select "R2," link repeater's call sign, then push **←** (5) to set the current call sign selection mode.
 - "RPT2" call sign screen is displayed.

Pushing **▲** selects the repeater group when selection.

- ⑦ Push **▲** (2) or **▼** (8) to select the specified gateway repeater call sign in the same zone, then push **← 5**.
 - Return to the current call sign mode.
- ⑧ Push **←** (5) to return to frequency indication.
- ⑤ Push **P** to transmit; release to receive.

• C

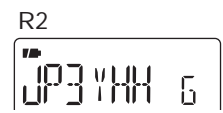
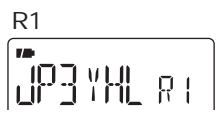
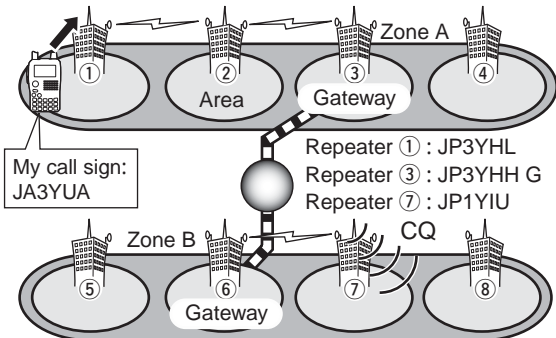

7 DV MODE OPERATION



TX messages are available for up to 5 channels and each channel can be programmed with a message of up to 20 characters. Available characters are to (capital letters), to 9, some symbols and space.

- ① Enter "TX MSG" in MESSAG (message) screen.

MENU ⇨ MESSAG ⇨ **TX MSG**
(Push ) , (Push ▲ (2)/ ▼ (8), then push ← (5).)

- TX MSG screen is displayed.
- ② Push ▲ (2) or ▼ (8) to select the desired transmit message channel.
- TM1 to TM5 and OFF are available.
 - Previously message is displayed if programmed.
- ③ Push ► (6) to select the message edit condition.
- The 1st digit of the message blinks.



- ④ Push ▲ (2) or ▼ (8) to select the desired character or symbol.
- If an un-necessary character is entered, push ► (6) or ◀ (4) to select the character, then push **CLR** (1) to erase the selected character, or push and hold **CLR** (1) for 1 sec. to erase all characters following the cursor.
 - Push ► (6) to move the cursor right; push ◀ (4) to move the cursor left.
- ⑤ Repeat the step ④ to enter the desired message.
- Up to 20 character messages can be set.

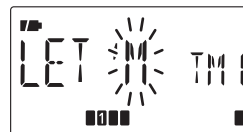

- ⑦ Push ← (5) to store the message.
- ⑧ Push  to return to frequency indication.



Toggle the message transmission function ON (TM1–TM5) and OFF. When a message channel is selected, the transceiver transmits a text message (pre-programmed). (default: OFF)

- ① Set the operating frequency, call signs and other settings, such as repeater operation, as desired.
- ② Enter "TX MSG" in MESSAG (message) screen.

MENU ⇨ MESSAG ⇨ **TX MSG**
 (Push ) , (Push ▲ (2)/ ▼ (8), then push ← (5).)

- TX MSG screen is displayed.
- ③ Push ▲ (2) or ▼ (8) to select the desired transmit message channel.
 - TM1 to TM5 are available.
 - ④ Push ← 5 to set the message for transmission.
 - ⑤ Push P to transmit.
 - The message is transmitted each time when P is pushed.
 - The message is transmitted each 30 sec. automatically during continuous transmission.
 - ⑥ Release P to return to receive.
 - ⑦ When the reply call with a message is received, the call sign and the message scrolls at the frequency display.

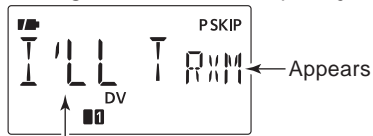

Scrolls the received message.

✓ For your information

The automatic received call sign and/or message indication can be turned OFF in DISP set mode, if desired.

- ➔ RX CS (RX CALL SIGN) (p. 132)
- ➔ RX MSG (RX MESSAGE) (p. 133)

- ⊙ Only one message can be stored in the IC-80AD. The received message is cleared by turning power OFF, or overwritten when another message is received.

7 DV MODE OPERATION

◇ R

The received message can also be checked in MESSAG (message) screen.

- ① Select "RX MSG" in MESSAG (message) screen.

MENU ⇨ MESSAG ⇨ **RX MSG**
(Push ) , (Push ▲ (2)/ ▼ (8), then push ← (5).)



• The received message is displayed.

- ② Push ▲ (2) to display the station call sign (caller).



- ③ Push ← (5) to return to RX MSG screen.
④ Push  to return to frequency indication.



The automatic reply function replies to calls by a station that specified your call sign.



- ① Enter "REPLY" in DV SET mode.

MENU ⇨ DV SET ⇨ **REPLY** (p. 130)
(Push ) , (Push ▲ (2)/ ▼ (8), then push ← (5).)

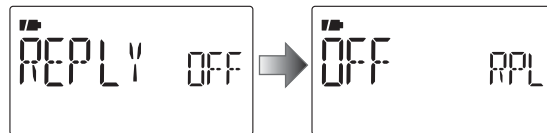

• REPLY (auto reply) screen is displayed.

- ② Push ▲ (2) or ▼ (8) to turn the automatic reply function ON and OFF.
○ : Deactivate the automatic reply function. (default)
○ : Reply to the call with your own call sign.
③ Push ← 5 .
• Returns to DV SET mode automatically.
④ Push  to return to frequency indication.

■ R

The EMR communication mode is available for digital mode operation. In the EMR communication mode, no call sign setting is necessary. When an EMR communication mode signal is received, the audio (voice) will be heard at the specified level even the volume setting level is set to minimum level, or digital call sign/digital code squelch is in use.

- ① Enter "EMR" in DV SET mode.

MENU ⇄ DV SET ⇄ **EMR**
(Push ) , (Push ▲ (2)/ ▼ (8), then push ← (5).)

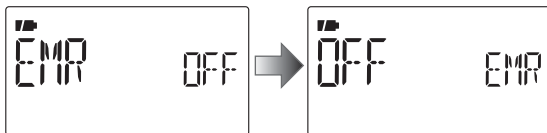

- EMR screen is displayed.
- ② Push ▲ (2) or ▼ (8) to turn the EMR communication mode ON and OFF.
- : EMR communication is set OFF. (default)
 - : EMR communication is set ON.
 - When "ON" is selected, "EMR" appears instead of memory channel indication
- ③ Push ← 5 .
- Returns to DV SET mode.

- ④ Push  to return to frequency indication.

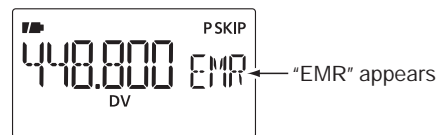

- ⑤ Push **P** to transmit.
- The message is transmitted each time when **P** is pushed.
 - The message is transmitted each 30 sec. automatically during continuous transmission.
- ⑥ Release **P** to return to receive.

○ The EMR communication function is turned OFF automatically when turning transceiver's power OFF

7 DV MODE OPERATION

The break-in function allows you to break into a conversation, where the two original stations are communicating with call sign squelch enabled.

- ① While receiving an another station's communication, push and hold **R** → **C** (8) for 1 sec. to set the communicating station's call sign.
 - When a call sign has not been received correctly, error beeps sound and no call sign is set. Try to set the call sign of a communicating signal again, or set the call sign manually.
- ② Enter "BK" in DV SET mode.

MENU ⇨ DV SET ⇨ **BK**
(Push , (Push **▲** (2)/ **▼** (8), then push **←** (5).)

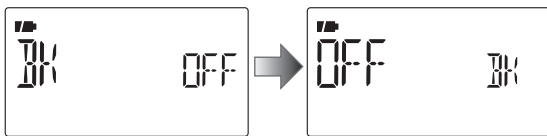

• BK screen is displayed.

- ③ Push **▲** (2) or **▼** (8) to turn the Break-in function ON and OFF.
 - When "ON" is selected, "BK" appears instead of memory channel indication
- ④ Push **←** **5** .
 - Returns to DV SET mode.

- ⑤ Push  to return to frequency indication.

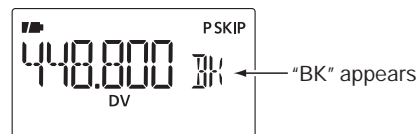

- ⑥ When both stations are in standby, push **P** to transmit a break-in call.
 - The programmed call sign station receives the break-in call as well as your call sign.
- ⑦ Wait for the reply call from the station who receives the break-in call.
- ⑧ After receiving the reply call, communicate normally.
- ⑨ To cancel the break-in function, turn the Break-in function OFF in the DV SET mode as steps ② to ⑤ (p. 134).

 The break-in function is turned OFF automatically when turning transceiver's power OFF

• How to use the break-in?

While operating with the digital call sign squelch (p. 149), the squelch never opens (no audio sounds) even if a call is received, unless your own call sign ("MY") is specified. However, when the call including the "BK ON" signal (break-in call) is received, the squelch will open and audio sounds even if the call is specified for another station.

• Station C calling to Station A with "BK OFF"

Station A and B are communicating using the digital call sign squelch.

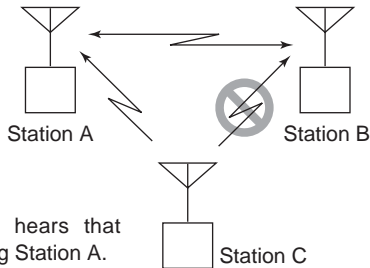

Station B never hears that Station C is calling Station A.

• Station C calling to Station A with "BK ON"

Station A and B are communicating using the digital call sign squelch.

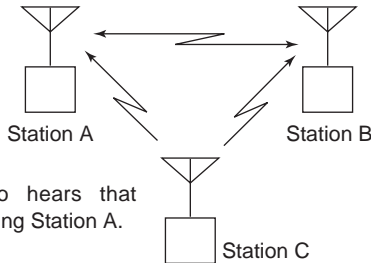

Station B also hears that Station C is calling Station A.

■ L -

In addition to the digital voice communication, low-speed data communication is available.

The optional OPC-1529R DATA COMMUNICATION CABLE and serial data communication software (purchase locally) are required in addition.

☐ Turn OFF "GPS-TX" (p. 136) in advance to operate the low-speed data communication.

◇ C

Connect the transceiver to your PC using with the optional OPC-1529R as illustrated below.

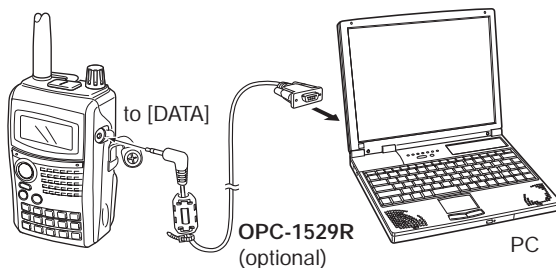

◇ L -

Configure the low-speed data communication application as follows.

- Port : The same COM port number as IC-80AD's
- Baud rate : 9600/4800 bps (p. 126)
- Data : 8 bit
- Parity : None
- Stop : 1 bit
- Flow control : Xon/Xoff

◇ L -

☐ Confirm that in AUTO, the computer controls when **P** is activated to send data and the user doesn't have to operate the radio.

- ① Set the current signs, etc. as described in "Current call sign setting" (p. 47), "Simplex operation in VFO" (p. 58) and "D-STAR repeater operation in VFO" (p. 60).
- ② Refer to the instructions of the low-speed data communication application.
- ③ To transmit data
 - At the same time as your voice audio, push and hold **P** to transmit while sending data from the PC. Release **P** to receive.
 - Under computer control, see Transmission condition setting at right.



- ① Enter "DATATX" in DV SET mode.

MENU ⇨ DV SET ⇨ **DATATX**
 (Push , (Push ▲ (2)/ ▼ (8), then push ← (5).)

- ② Push ▲ (2) or ▼ (8) to select "PTT" or "AUTO."
P : The input data from [DATA] are transmitted when pushing [PTT]. (default)
O : The input data from [DATA] are transmitted automatically when the data are input.
- ③ Push ← (5) to return to DV SET mode, and push  to return to frequency indication.

✓ For your information

While operating low-speed data communication via the internet network from one zone to another zone, some packets may be lost due to network error (poor data throughput performance). In such a case, the IC-80AD displays "P-LOSS" instead of frequency indication on the display to indicate Packet Loss has occurred.

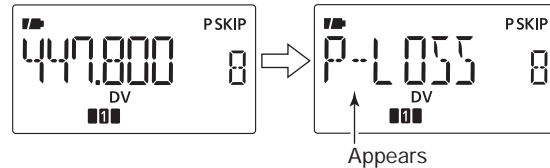

7 DV MODE OPERATION

■ ○





The "DV" mode indicator blinks when a non-DV signal is received during DV mode operation.

When a signal other than DV mode is received, the IC-80AD DV automatic detection switches to monitor in FM mode.

- ① Enter "DV DET" in DV SET mode.

MENU ⇨ DV SET ⇨ **DV DET** (p. 131)
(Push ) , (Push  (2)/  (8), then push  (5).)

- ② Push  (2) or  (8) to turn the DV automatic detect function ON and OFF.

○ : "DV" blinks, however the transceiver receives in DV mode even if non-DV mode signals are received.

○ : "DV" blinks then "FM" also blinks when the transceiver monitors the receiving signal other than DV mode, the signal is in FM mode.

- ③ Push  (5) to return to DV SET mode.



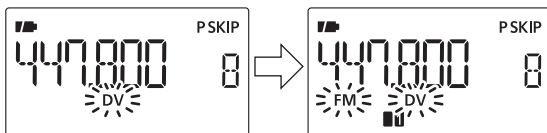

- ④ Push  to return to frequency indication.



▨ ○ The received FM audio may be distorted when receiving an FM signal with DV automatic detect function.



The voice error function displays the voice error level on the display to indicate Voice Error has occurred.

- ① Push and hold **P R** for 1 sec. to turn power OFF.
- ② While pushing and holding , **1** and , then turn power ON to enter the voice error function mode.
- ③ Push and hold  (6) for 1 sec. several times to select "V ERR" to activate the voice error function in DV mode.
 - Push and hold  (6) for 1 sec. again to turn the function OFF.

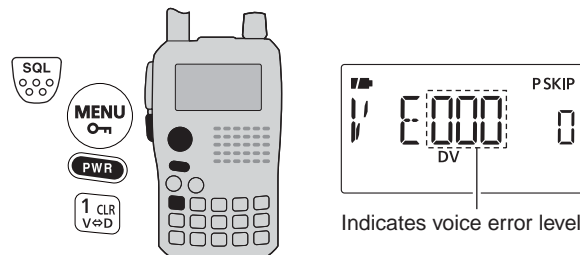

- ④ Repeat steps ① and ② to exit the voice error function mode.

■ P

Displaying (FM/FN-N/WFM/AM/DV mode) or transmitting (DV mode only) GPS data is available when connecting an optional HM-189GPS (GPS speaker microphone) or 3rd party GPS receiver* (RS-232C output/NMEA format). GPS data from the 3rd party GPS receiver pass through the [DATA] jack of the IC-80AD.

In addition, the GPS message transmission is also available in GPS mode operation.

*GPS receiver with RS-232C terminal is required.

*Set "GPS-TX" to "DVG" or "DVA" at step ④ of next page when connecting a 3rd party GPS receiver.



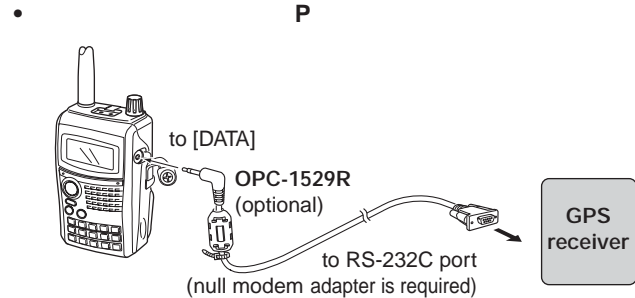
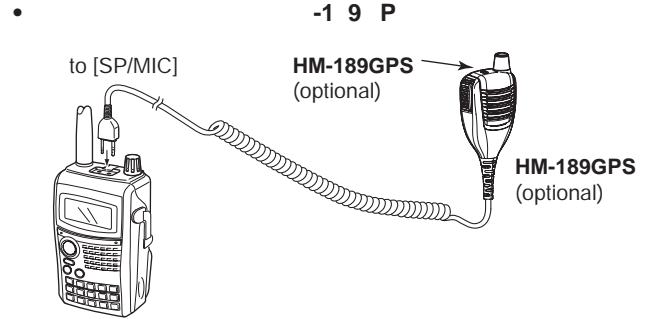

▨ O The optional HM-189GPS outputs GPS data (position data, etc.) to the connected IC-80AD at intervals when the IC-80AD is receiving state, and the IC-80AD is not updated GPS data while transmitting. Therefore, the IC-80AD transmits GPS data that was received prior before transmitting.



8 GPS/GPS-A OPERATION









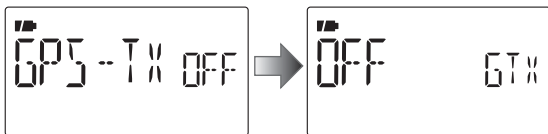



- ① Enter "GPS-TX" in GPS mode.

MENU ⇨ GPS ⇨ **GPS-TX**
(Push ) , (Push  (2)/  (8), then push  (5).)

- GPS TX screen is displayed.



- ② Push  (2) or  (8) to select "DVG."
- ③ Push  (5) to select GPS sentence screen.
- ④ Push  (2) or  (8) to select the desired GPS sentence, then push  (5).
- A total 6 sentences, RMC, GGA, GLL, GSA, VTG and GSV are available.
- ⑤ Push  (2) or  (8) to select to turn the sentence usage ON and OFF.
- ⑥ Push  (5) to return to GPS sentence screen.
- ⑦ Repeat the steps ④ to ⑥ to set another GPS sentence usage.
- Up to 4 GPS sentences are usable at the same time.
- ⑧ Push  to return to frequency indication.



Set the GSV sentence to OFF when sending the GPS message to conventional digital transceivers (IC-2820, ID-800H, IC-91AD, IC-V82, IC-U82).
The GSV sentence is incompatible with them. Those transceivers will not display GPS messages properly if sent as a GSV sentence from the IC-80AD.

◇ P

- ① Enter "TX GPS" in MESSAG screen.

MENU ⇨ MESSAG ⇨ **TX GPS**
(Push ) , (Push ▲ (2)/ ▼ (8), then push ← (5).)

- TX GPS screen is displayed.

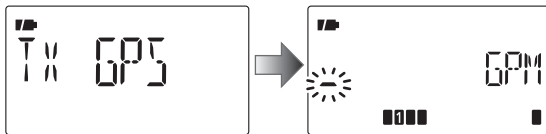

- ② Push ← (5) to select the message edit condition.
• The 1st digit of the message blinks.
- ③ Push ▲ (2) or ▼ (8) to select the desired character or symbol.
- ④ Push ► (6) to select 2nd digit, then push ▲ (2) or ▼ (8) to select the desired character or code.
• Push ► (6) to move the cursor right; push ◀ (4) to move the cursor left.
• 2nd digit blinks (1st digit stops blinking).
- ⑤ Repeat the step ④ to enter the desired message.
• Up to 20-character messages can be set.



- ⑥ Push ← 5 to store the message.
- ⑦ Push  to return to frequency indication.

◇ P

- ① Enter "GPS.ATX" in GPS mode.

MENU ⇨ GPS ⇨ **GPS.ATX** (p. 140)
(Push ) , (Push ▲ (2)/ ▼ (8), then push ← (5).)

- GPS AUTO TX screen is displayed.

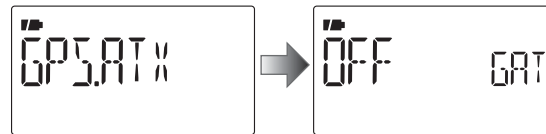

- ② Push ▲ (2) or ▼ (8) to select the desired position data transmitting interval from 5 sec., 10 sec., 30 sec., 1 min., 3 min., 5 min., 10 min., 30 min. and OFF.
• The GPS message is also transmitted if programmed.
- ③ Push ← 5 to return to GPS mode.
- ④ Push  to return to frequency indication.

⚡ O Your own call sign ("MY") must be set to activate the GPS automatic transmission.

O C

"5SEC" cannot be selected when 4 GPS sentences are selected.

- Only use GPS message automatic transmission in simplex mode.
- Automatic GPS message transmission through a repeater may interfere with other communications.

8 GPS/GPS-A OPERATION

◇ R P

① Enter "RX GPS" in MESSAG screen.

MENU ⇨ MESSAG ⇨ **RX GPS**
(Push ) , (Push ▲ (2)/ ▼ (8), then push ← (5).)

• RX GPS screen is displayed.

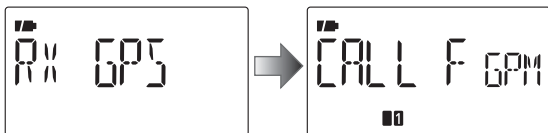

② Push ← 5 several times to scroll the message.

③ Push ← 5 to return to the MESSAG screen.

④ Push  to return to frequency indication.

◇ P

① Enter "GPS.POS" in GPS mode.

MENU ⇨ GPS ⇨ **GPS.POS**
(Push ) , (Push ▲ (2)/ ▼ (8), then push ← (5).)

• GPS POS screen is displayed.

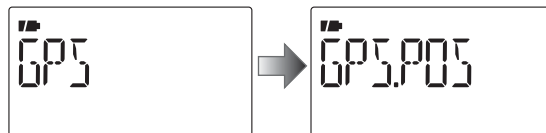

② Push ▲ (2) or ▼ (8) to select the position data indication.

- **PO** Displaying own latitude and longitude.
- **R PO** Displaying (caller) other station latitude and longitude.
- **L** Displaying own elevation.
- Displaying the time.
- Displaying distance from (caller) other station.
- **C LL R** Displaying the call sign of (caller) other station.

③ Push ← 5 to enter the selection.

④ Push ← 5 to return to the "GPS.POS" screen. See "MY POS" and "RX POS" operations at next page.

⑤ Push  to return to frequency indication.

○ The elevation may change depending on receive condition.

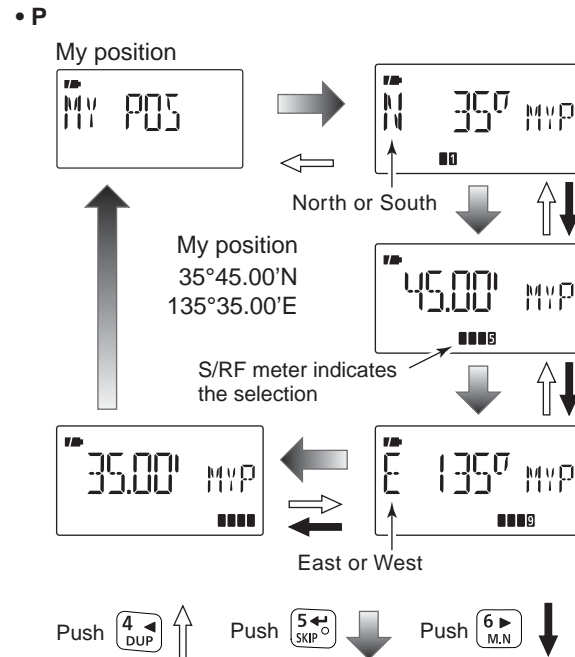
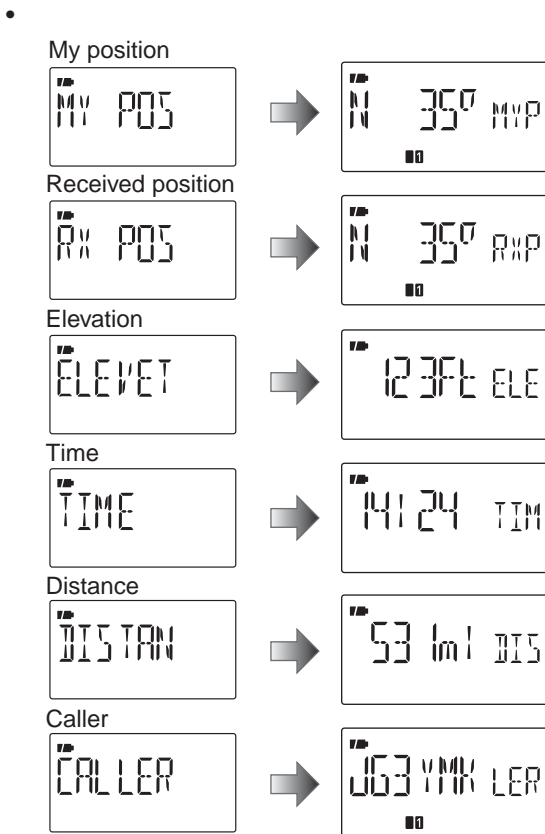

The display example are described when "P FORM" is selected "mm.mm" and "UNITS" is selected "FT/ml." (p. 134)

8 GPS/GPS-A OPERATION



① Enter "GPS.POS" in GPS mode.

MENU ⇨ GPS ⇨ **GPS.POS**
(Push ) , (Push ▲ (2)/ ▼ (8), then push ← (5).)

- GPS POS screen is displayed.

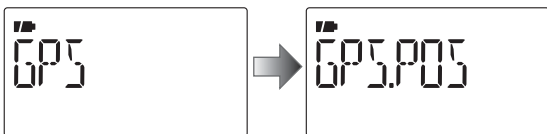

② Push ▲ (2) or ▼ (8) to select the position data indication.

- **PO** Displaying own latitude and longitude.
- **R PO** Displaying (caller) other station latitude and longitude.
- **L** Displaying own elevation.
- Displaying the time.
- Displaying distance from (caller) other station.
- **C LL R** Displaying the call sign of (caller) other station.

③ Push ← **5** to enter the selection.

④ Push and hold  (M/CALL) for 1 sec. to save the selected position data to GPS memory (G00).

- The M-CH number advances automatically in case the next M-CH is already contains information.
- 50 GPS M-CH are available.
- Push **C LL** to display stored position data.



Displaying own direction, received station's direction and set position and direction in the GPS memory.

① Enter "D/F" in GPS mode.

MENU ⇨ GPS ⇨ **D/F**
(Push ) , (Push ▲ (2)/ ▼ (8), then push ← (5).)

- D/F (Direction/Forward) screen is displayed.

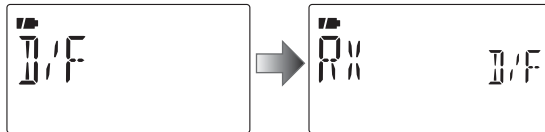

② Push ▲ (2) or ▼ (8) to select "RX," "MY" and "GPS.M"

- Displays own direction, elevation and the time.
- **R** Displays other station's direction and distance from own position.
- **P** Displays the direction and distance from own position of alarm setting for the memorized position in the GPS memory.

③ Push ← **5** to enter the selection.

- 16 compass points are available.

④ Push ← **5** several times to select other informations.

⑤ Push  to return to frequency indication.

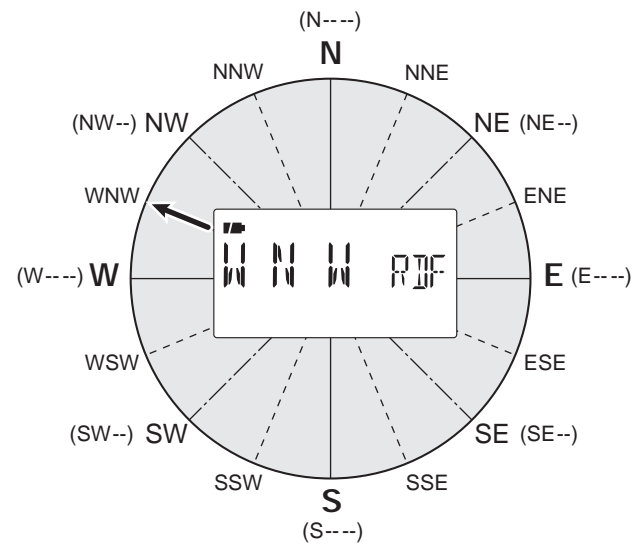

8 GPS/GPS-A OPERATION

◇ P

① Enter "GPS.MEM" (GPS memory) in GPS mode.

MENU ⇨ GPS ⇨ **GPS.MEM**
(Push ) , (Push ▲ (2)/ ▼ (8), then push ← (5).)

• GPS memory selection screen is displayed.

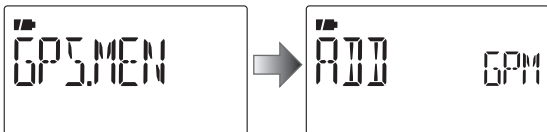

② Push ← (5) to enter the new GPS memory channel programming state.

③ Push ▲ (2) or ▼ (8) to select the desired items, "NAME," "TIME," "LAT" (LATITUDE) or "LON" (LONGITUDE), then push ► (6) to edit the selected item.

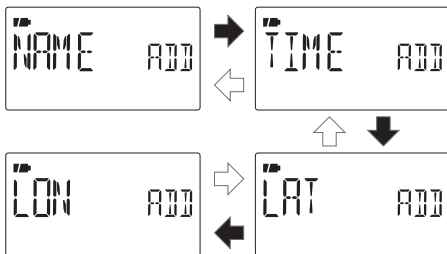

④ Push ▲ (2) or ▼ (8) to select the desired character or number.

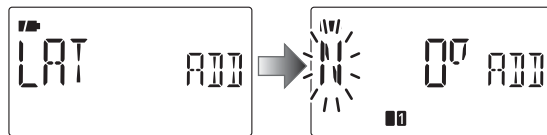

• Push ► (6) to move the cursor right; push ← (4) to move the cursor left.

⑤ Repeat step ④ to enter the desired latitude data, then push ← (5) to program the item.

⑥ Repeat steps ③ to ⑤ to program the other items.

• Up to a 6 character name can be programmed.

⑧ Push  to return to frequency indication.

◇ P

GPS alarm sounds when your own position is close the specified position. This function can be set to use information from the received channel, a specified GPS memory channel or all GPS memory channels.

- ① Enter "ALM-CH" in GPS mode.

MENU ⇨ GPS ⇨ **ALM-CH**
(Push ) , (Push ▲ (2)/ ▼ (8), then push ← (5).)

- Alarm setting screen is displayed.

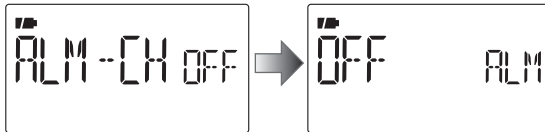

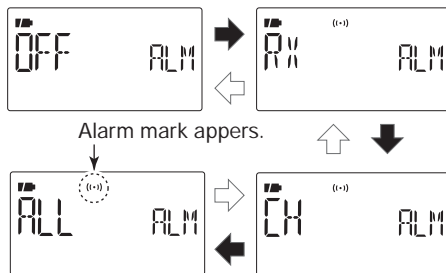

- ② Push ▲ (2) or ▼ (8) to select "RX," "CH," "ALL" or "OFF."

- "RX," "ALL", one of the memory channel can be selected.
- Skip next step ③ when RX, ALL or OFF is selected.

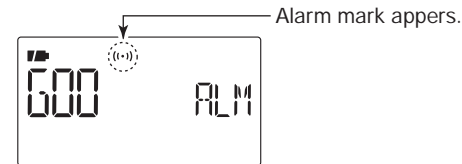

- ③ Push ← (5), then push ▲ (2) or ▼ (8) to select the desired memory channel.
- Memory name or channel number appears when the channel is selected.



- ④ Push ← (5) to set the alarm function and returns to ALM-CH (GPS memory) screen.
- ⑥ Push  to return to frequency indication.

✓ **For your information!**

- When "ALL" or memory channel is selected above step ④, alarm functions depending on "ALM1" setting in GPS mode (p. 86).
- When "RX" is selected above step ④, alarm functions depending on "ALM2" setting in GPS mode (p. 87).

8 GPS/GPS-A OPERATION

◇ P P

GPS alarm setting for a specified GPS memory channel is available on GPS memory channel indication.

① Enter "GPS.MEM" in GPS mode.

MENU ⇨ GPS ⇨ **GPS.MEM**
(Push ) , (Push ▲ (2)/ ▼ (8), then push ← (5).)

• GPS memory selection screen is displayed.

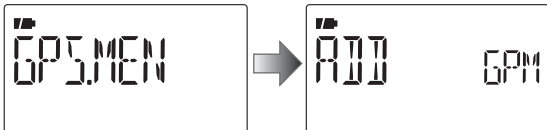

② Push ▲ (2) or ▼ (8) to select the desired memory channel.

• Memory name or channel number appears when the channel is selected.



③ Push **C LL** to switch the alarm function ON or OFF.

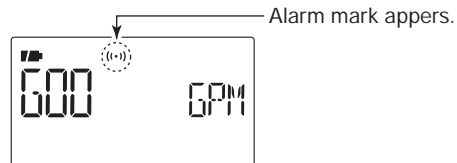

④ Push ◀ (4) to return to GPS.MEM (GPS memory) screen.

⑤ Push  to return to frequency indication.

✓ For your information!

• When a specified memory channel is selected above step ③, alarm functions depending on "ALM1" setting in GPS mode (p. 86).

◇ P

① Enter "GPS.MEM" in GPS set mode.

MENU ⇨ GPS ⇨ **GPS.MEM**
 (Push , (Push ▲ (2)/ ▼ (8), then push ← (5).)

• GPS memory selection screen is displayed.

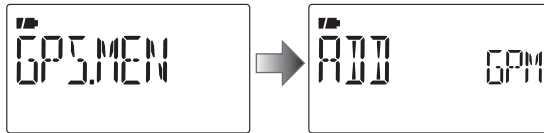

② Push ▲ (2) or ▼ (8) to select the desired GPS memory channel to be cleared or "CLEAR ALL" (all GPS memory channel will be cleared), then push ► (6).

• Skip next step ③ when "CLEAR ALL" is selected.

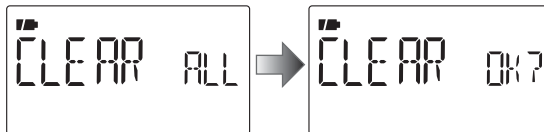
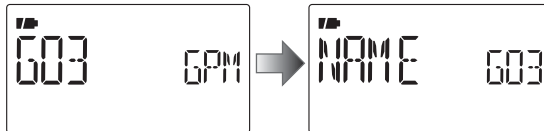

③ Push ▼ (8) several times to select "CLEAR," then push ← (5).

• "CLEAR OK?" appears.

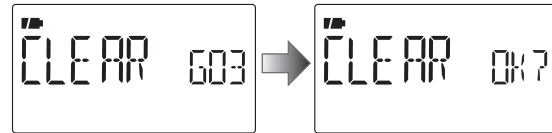

④ Push ← (5) again to clear the list.

• 1 beep sounds, then the memory channel is cleared.
 • Remaining channels scroll up.



⑤ Push ← (4) to return to GPS.MEM (GPS memory) screen.

⑥ Push  to return to frequency indication.

8 GPS/GPS-A OPERATION

◇ 1

Sets GPS alarm active range within 00'05" to 59'59" in 1 sec. (00'01") steps. (default: 00'15")

① Enter "ALM1" in GPS set mode.

MENU ⇨ GPS ⇨ **ALM1**
(Push ) , (Push ▲ (2)/ ▼ (8), then push ⇨ (5).)

• ALM1 setting screen is displayed.

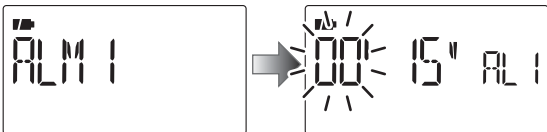

When "P FORM" (position format) (p. 134) is selected "mm.SS."



When "P FORM" (position format) (p. 134) is selected "mm.mm."

② Push ▲ (2) or ▼ (8) to set the desired alarm area.

• Push ▶ (6) to move the cursor right; push ◀ (4) to move the cursor left.

③ Push ⇨ (5) to set the area.

④ Push  to return to frequency indication.

▨ The alarm area 1 function is available when the "GPS ALARM" function of ALL is turned ON.

• **Example:** Your position : 35°N/135°E
ALM AREA1 setting : 00'15" (default)

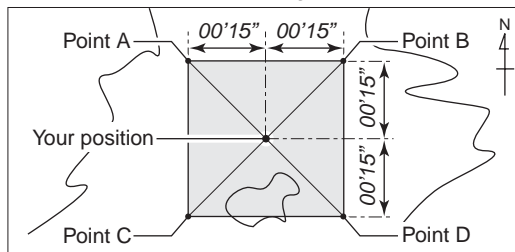

- Position of point A : 35°00'15"N/134°59'45"E
- Position of point B : 35°00'15"N/135°00'15"E
- Position of point C : 34°59'45"N/134°59'45"E
- Position of point D : 34°59'45"N/135°00'15"E

When the target position is coming into the area as above, the GPS alarm will be sound.

Above example are described when "P FORM" is selected "mm.SS." (p. 134)

◇ 2

Selects GPS alarm active range from "BOTH," "EXTEND" and "LIMIT" when "CH" or "RX" is selected at GPS alarm setting.

① Enter "ALM2" in GPS mode.

MENU ⇨ GPS ⇨ **ALM2**
(Push ) , (Push ▲ (2)/ ▼ (8), then push ← (5).)

• ALM2 setting screen is displayed.

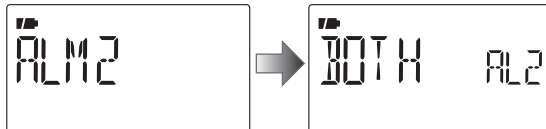

② Push ▲ (2) or ▼ (8) to select the desired alarm setting, then push ← (5) to set.

- BOTH : GPS alarm[†] will sound when a target position enters both 500 m* (547 Y)* and 1 km* (1094 Y)* range. (default)
- EXTEND : GPS alarm[‡] will sound when a target position enters 1 km* (1094 Y)* range.
- LIMITE : GPS alarm[†] will sound when a target position enters 500 m* (547 Y)* range.

*Approximate

[†] One beep sounds when coming into 500 m (547 Y) and three beep sounds when coming into 1 km (1094 Y).

[‡] Three beep sounds.

③ Push  to return to frequency indication.

• **Example:**

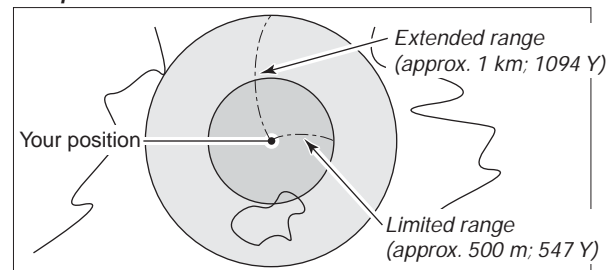

When the target position is coming into either/each area as above, the GPS alarm will be sound.

8 GPS/GPS-A OPERATION

■ P -

◇ P -

Set the following for activate the GPS-A function.

- ① Select the DV mode operation (p. 25)
- ② Select "DATATX" (DV data transmission) to AUTO. (p. 130)
- ③ Select "GPS.ATX" (GPS transmission mode) to DVA.
(p. 136)
- ④ Set "GPS.ATX" (GPS auto transmission timer). (p. 140)
- ⑤ Set the GPS-A set items. (pgs. 137-140)

◇ P -

While in GPS-A operation, following codes are transmitted to your connecting PC. GPS-A code is based on APRS® code. (APRS® : Automatic Position Reporting System)

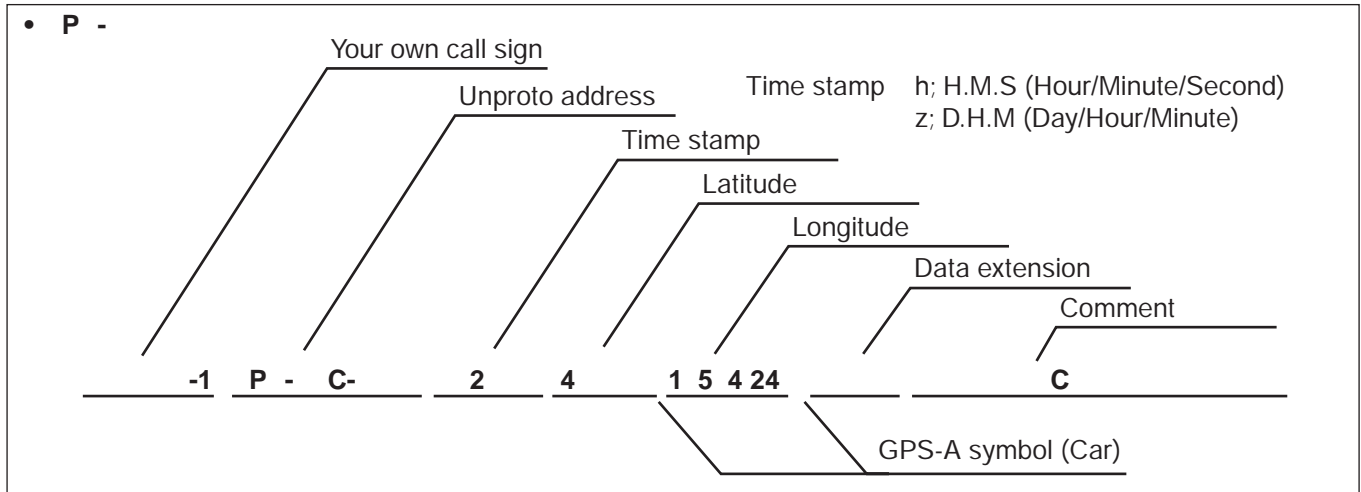

■

The IC-80AD has 1050 memory channels, and 2 call channels. Memory channels include 50 scan edge memory channels (25 pairs) for storage of often-used frequencies. And a total of 26 memory banks, A to Z, are available in each band for storing groups of frequencies, etc. Up to 100 channels can be assigned into a bank.



The following information can be programmed into memory channels:

- Operating frequency (p. 23)
- Operating mode (p. 25)
- Duplex direction (+DUP or -DUP) with an offset frequency (p. 31)
- Subaudible tone encoder (p. 29), tone squelch or DTCS squelch ON/OFF (p. 148)
- Subaudible tone frequency (p. 117), tone squelch frequency or DTCS code with polarity (pgs. 117, 118)
- Scan skip information (p. 106)
- Memory bank (p. 93)
- Memory name (p. 95)
- Tuning step (p. 22)
- Call sign squelch or Digital code squelch* (p. 146)
- Station call sign* (pgs. 37, 47)
- RPT1/RPT2 call sign* (pgs. 38, 47)

*Available for DV mode operation only.

C O

Memory data can be erased by static electricity, electric transients, etc.

In addition, they can be erased by malfunction and during repairs.

Therefore, we recommend that memory data be written down or be saved to a PC using the CS-80/880 CLONING SOFTWARE (free download software).

■ Selecting a memory channel

◇ Using [DIAL]— Programmed channels

- ① Push **[M/CALL]** to select memory mode.
 - Pushing **[M/CALL]** selects memory, call, TV* and weather† channels.
- ② Rotate **[DIAL]** to select the desired memory channel.
 - Only programmed channels are displayed.

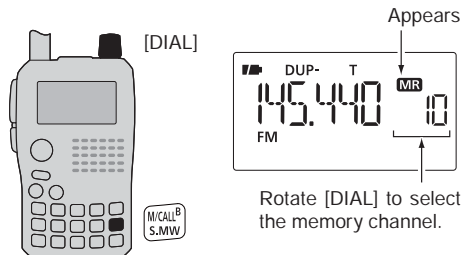

- ▨ *Appears only when TV channels are programmed via the CS-80/880 (free download software).
- †Available for the U.S.A. version only.

◇ Using [DIAL]— All channels

- ① Push **[M/CALL]** to select memory mode.
 - Pushing **[M/CALL]** toggles memory, call, TV* and weather† channels.
- ② Push and hold **[S.MW](M/CALL)** for 1 sec. to enter select memory write mode.
 - 1 short and 1 long beep sound.
 - “**MR**” indication and memory channel number blink.
- ③ Rotate **[DIAL]** to select the desired memory channel.
 - All channels are displayed.
 - Push **[V/MHz]** to return to memory mode indication.

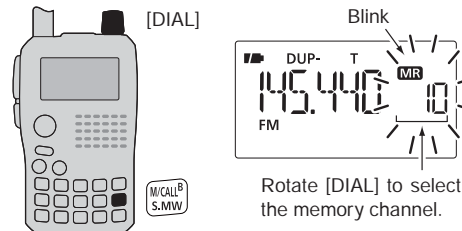

- ▨ *Appears only when TV channels are programmed via the CS-80/880 (free download software).
- †Available for the U.S.A. version only.

◇ Using the Numeral keys

- ① Push **[M/CALL]** to select memory mode.
 - Pushing **[M/CALL]** toggles memory, call, TV* and weather† channels.
- ② Use the numeral keys to enter 3 digits to select the desired memory channel.
 - The blank channels are also selectable.

• Example— selecting memory channel “25”

Push **[M/CALL]**, then push **[0]**, **[2]**, **[5]**.

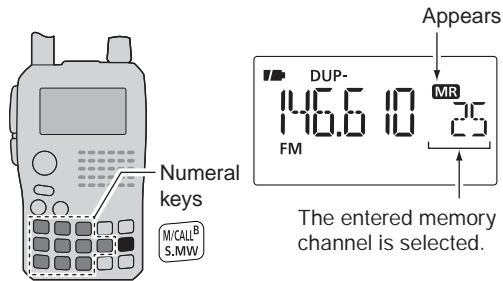

/// *Appears only when TV channels are programmed via the CS-80/880 (free download software).
 †Available for the U.S.A. version only.

■ Selecting a call channel

- ① Push **[M/CALL]** to select call channel mode.
 - Pushing **[M/CALL]** toggles memory, call, TV* and weather† channels.
- ② Rotate **[DIAL]** to select the desired call channel.
 - “C0” and “C1” are selectable.

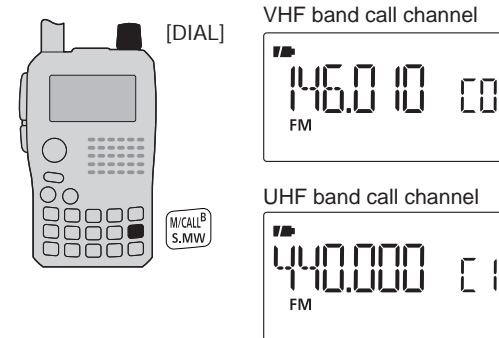

/// *Appears only when TV channels are programmed via the CS-80 (free download software).
 †Available for the U.S.A. version only.

Memory channel programming

- ① Push **[V/MHz]** to select VFO mode.
- ② Set the desired frequency:
 - Select the desired band with **[BAND]**.
 - Set the desired frequency with **[DIAL]**.
 - Or set the desired frequency with keypad directly.
In this case, the band and frequency settings with **[BAND]** and **[DIAL]** as above are not required.
 - Set other data (e.g. offset frequency, duplex direction, tone squelch, current call signs, etc.), if desired.
- ③ Push and hold **[S.MW]**(M/CALL) for 1 sec. to enter select memory write mode.
 - 1 short and 1 long beep sound.
 - “**MR**” indication and memory channel number blink.
- ④ Rotate **[DIAL]** to select the desired channel.
 - Call channels (C0, C1), VFO (VF) and scan edge channels (00A/00B to 24A/24B), as well as regular memory channels, can be programmed in this way.
- ⑤ Push and hold **[S.MW]**(M/CALL) for 1 sec. to program.
 - 3 beeps sound.
 - Memory channel number automatically increases when continuing to push and hold **[S.MW]**(M/CALL) for 1 sec. after programming.

[EXAMPLE]: Programming 145.440 MHz into memory channel 11 (blank channel).

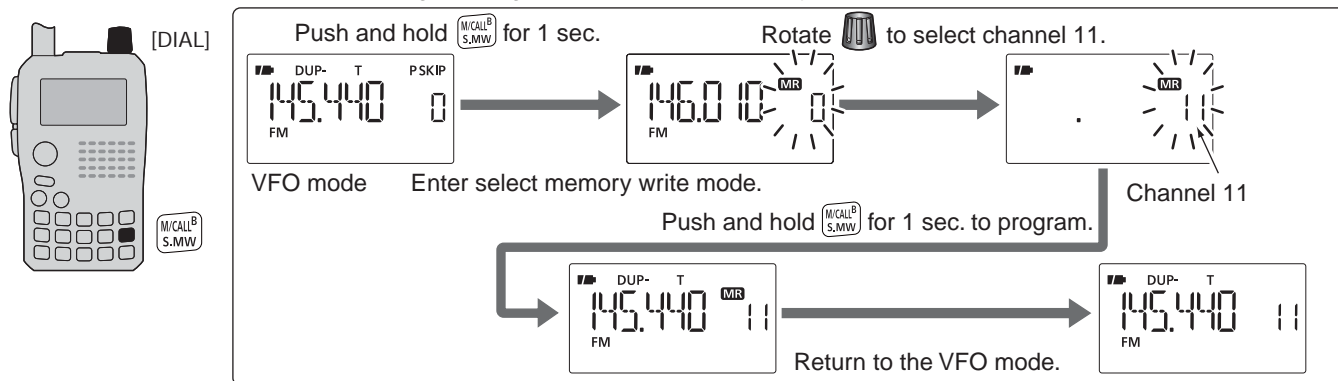

Memory bank setting

The IC-80AD has a total of 26 banks (A to Z). Regular memory channels, 000 to 999, are assigned to the desired bank for easy memory management.

- ① Push and hold **[S.MW]**(M/CALL) for 1 sec. to enter select memory write mode.
 - 1 short and 1 long beep sound.
 - Memory channel number blinks.
- ② Rotate **[DIAL]** to select the desired memory channel.
- ③ Push **[▼]**(8) to select “BANK” setting.
 - Bank group and channel number is displayed if the selected memory channel has already been previously assigned to a bank.

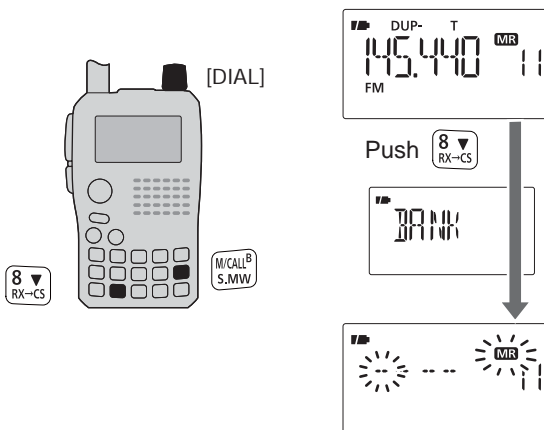

- ④ Rotate **[DIAL]** to select the desired bank group from “A” to “Z.”

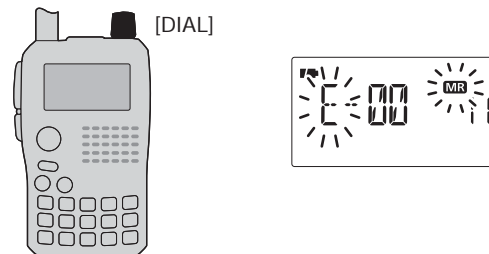

- ⑤ Push **[▶]**(6) to select the bank channel digit, then rotate **[DIAL]** to select the bank channel number from “00” to “99.”
 - Push **[◀]**(4) to return to the bank group selection, if desired.

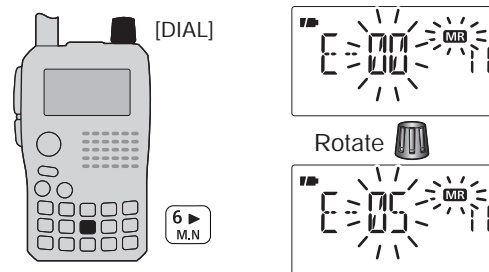

- ⑥ Push and hold **[S.MW]**(M/CALL) for 1 sec. to assign the channel to the bank.
 - Return to the previous indication before entering select memory write mode.

Memory bank selection

- ① Push **[M/CALL]** to select memory mode.
- ② Push **[BAND]** to enter the bank selection state.
- ③ Rotate **[DIAL]** to select the desired bank (A to Z), then push **[BAND]**.
 - Only programmed banks are displayed.
 - Also regular memory channel can be selected.

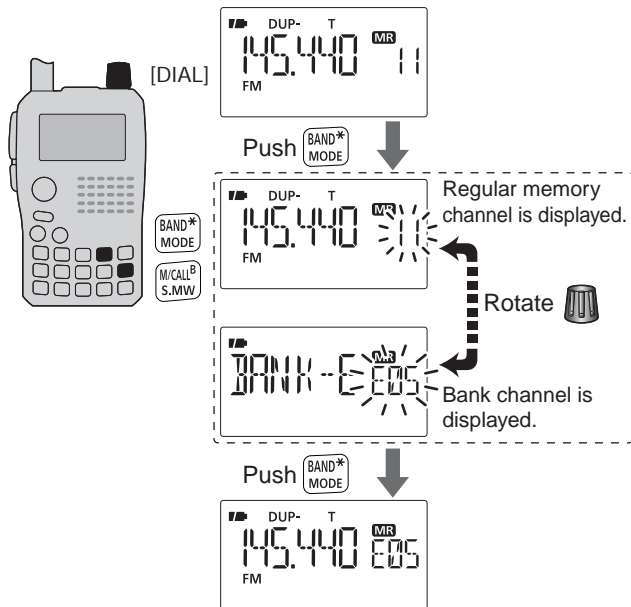

- ④ Rotate **[DIAL]** to select the bank channel.
 - Only programmed channels are displayed.

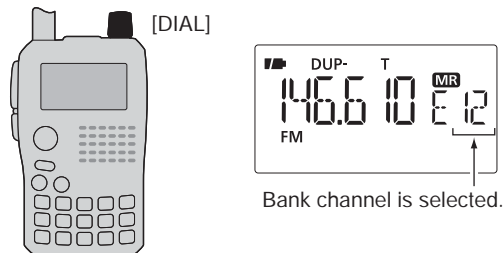

Bank channel is selected.

■ Programming memory/bank/scan name

Each memory channel can be programmed with an alphanumeric channel name for easy recognition and can be indicated independently by channel. Names can be a maximum of 8 characters.

NOTE: Scan name indication can be turned ON or OFF in DISP set mode (SET). (p. 128)

- ① Push **[M/CALL]** to select memory mode.
- ② Push and hold **[S.MW](M/CALL)** for 1 sec. to enter select memory write mode.
 - 1 short and 1 long beep sound.
 - “**MR**” indication and memory channel number blink.
- ③ Rotate **[DIAL]** to select the desired memory channel.
 - Select call channels (C0 or C1) or scan edge channels (00A/00B to 24A/24B) to program a call channel name or scan name, respectively.
- ④ Push **[▲](2)** or **[▼](8)** several times to select “BNAME,” “MNAME” or “SNAME” when programming the bank name, the memory name or the scan name, respectively.
 - After selecting the name to be programmed, a cursor blinks for the first character.
- ⑤ Rotate **[DIAL]** to select the desired character.
 - The selected character blinks.
 - Push **[▶](6)** to move the cursor right; push **[◀](4)** to move the cursor left.
 - Push **[CLR](1)** to erase the selected character, or push and hold **[CLR](1)** for 1 sec. to erase all characters following the cursor.

- ⑥ Repeat step ⑤ until the desired channel name is programmed.
- ⑦ Push and hold **[S.MW](M/CALL)** for 1 sec. to set the name and exit channel name programming state.
 - 3 beeps sound.

NOTE: Only one bank name can be programmed into each bank. Therefore, the previously programmed bank name will be displayed when bank name indication is selected. Also, the programmed bank name is assigned for the other bank channels automatically.

◇ Available characters

A	B	C	D	E	F	G	H	I	J	K	L	M
(A)	(B)	(C)	(D)	(E)	(F)	(G)	(H)	(I)	(J)	(K)	(L)	(M)
N	O	P	Q	R	S	T	U	V	W	X	Y	Z
(N)	(O)	(P)	(Q)	(R)	(S)	(T)	(U)	(V)	(W)	(X)	(Y)	(Z)
0	1	2	3	4	5	6	7	8	9			
(0)	(1)	(2)	(3)	(4)	(5)	(6)	(7)	(8)	(9)			
"	#	\$	%	&	'	()	*	+	.	-	.
(")	(#)	(\$)	(%)	(&)	(')	(())	(*)	(+)	(.)	(-)	(.)	
/		=	?	@	-							
(/)	()	(=)	(?)	(@)	(Space)							

9 MEMORY/CALL CHANNELS

[EXAMPLE]: Programming the bank name "AIR" into the scan edge channel 03A.

During memory mode, rotate  to select scan edge channel 03A. Rotate  to enter "A," then push .



Push and hold  for 1 sec.



Enter select memory write mode.

Push  to select " ".



Rotate  to enter "A," then push .



Enter "I" and "R" with  and .

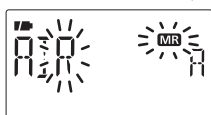

Push and hold  for 1 sec. to program.



Select " " or " " when programming the memory name or the scan name, respectively.

■ Selecting memory/bank name indication

During memory mode operation, either the programmed memory name or bank name can be displayed.

- ① Push **[M/CALL]** to select memory mode.
- ② Push and hold **[M.N](6)** to select display indication type from memory name, bank name and OFF.
 - While pushing and holding **[M.N](6)**, rotating **[DIAL]** is also selectable. (Name indication OFF ⇔ Memory Name indication ⇔ Bank name indication)

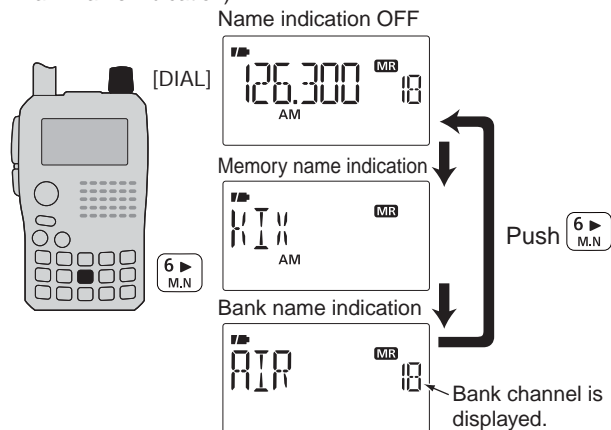

NOTE: The programmed scan name is displayed during the programmed scan selection.

■ Copying memory/call contents

This function transfers a memory channel's contents to VFO (or another memory/call channel). This is useful when searching for signals around a memory channel frequency and for recalling the offset frequency, subaudible tone frequency etc.

◇ Memory/call ↔ VFO

- ① Select the memory (call) channel to be copied.
 - ➔ Push **[M/CALL]** several times to select memory write mode or call channel mode, then rotate **[DIAL]** to select the desired channel.
- ② Push and hold **[S.MW]**(M/CALL) for 1 sec. to enter select memory write mode.
 - 1 short and 1 long beep sound.
 - “**MR**” indication and memory channel number blink.
- ③ Rotate **[DIAL]** to select “VF.”
- ④ Push and hold **[S.MW]**(M/CALL) for 1 sec. to write the selected channel contents to VFO mode.
 - Returns to VFO mode automatically.

/// Pushing and holding **[S.MW]**(M/CALL) for 2 sec. at the step ②, will also copy the memory contents to VFO. In this case, the steps ③ and ④ are not necessary.

◇ Memory/call ↔ memory/call

- ① Select the memory (call) channel to be copied.
 - ➔ Push **[M/CALL]** several times to select memory mode or call channel mode, then rotate **[DIAL]** to select the desired memory channel.
- ② Push and hold **[S.MW]**(M/CALL) for 1 sec. to enter select memory write mode.
 - 1 short and 1 long beep sound.
 - “**MR**” indication and memory channel number blink.
 - Do not hold **[S.MW]**(M/CALL) for more than 2 sec. otherwise the memory contents will be copied to VFO.
- ③ Rotate **[DIAL]** to select the target memory (call) channel.
- ④ Push and hold **[S.MW]**(M/CALL) for 1 sec. again to copy.

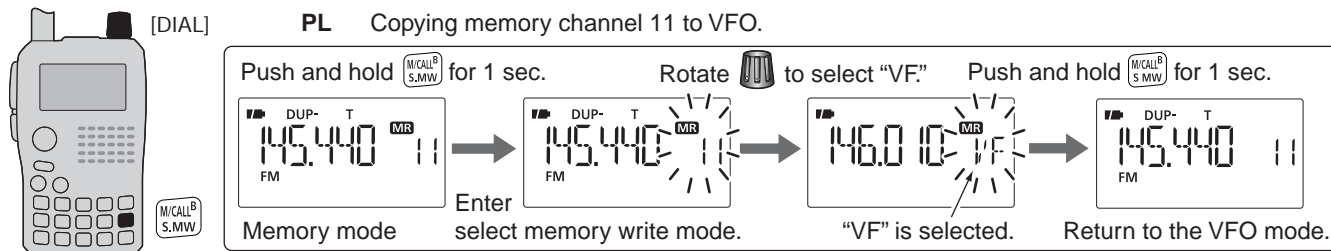

Memory clearing

Contents of programmed memories can be cleared (erased), if desired.

- ① Push and hold **[S.MW]**(M/CALL) for 1 sec. to enter select memory write mode.
 - 1 short and 1 long beeps sound.
 - Memory channel number blinks.
 - Do not hold **[S.MW]**(M/CALL) for more than 2 sec. otherwise the memory contents will be copied to VFO.
- ② Rotate **[DIAL]** to select the desired memory channel to be cleared.

- ③ Push **[▲]**(2) or **[▼]**(8) to select “CLEAR.”
- ④ Push and hold **[S.MW]**(M/CALL) for 1 sec. to clear the contents.
 - 3 beeps sound.
 - The cleared channel changes to blank channel
 - Return to select memory write mode.— Memory channel number blinks. Push **[V/MHz]** to exit select memory write mode.

NOTE: Be careful!— the contents of cleared memories **CANNOT** be recalled.

[EXAMPLE]: Clearing memory channel 14.

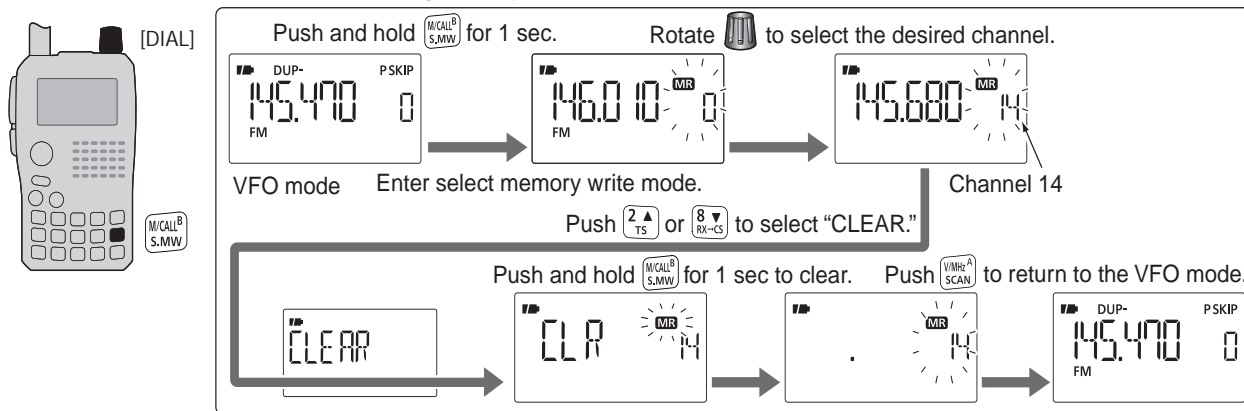

■ Erasing/transferring bank contents

The bank contents of programmed memory channels can be cleared or reassigned to another memory bank.

INFORMATION: Even if the memory bank contents are cleared, the memory channel contents still remain programmed.

- ① Select the desired bank contents to be transferred or erased from the bank. (p. 99)
 - ➔ Push **[BAND]** to enter memory bank selection state.
 - ➔ Rotate **[DIAL]** to select the desired memory bank group, then push **[BAND]**.
 - ➔ Rotate **[DIAL]** to select the bank channel.

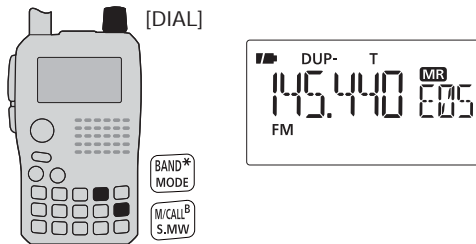

- ② Push **[S.MW]**(M/CALL) for 1 sec. to enter select memory write mode.
 - 1 short and 1 long beeps sound.
 - Displays the original memory channel number automatically, and then “**MR**” indication and memory channel number blink.
 - Do not hold **[S.MW]**(M/CALL) for more than 2 sec., otherwise the memory contents will be copied to VFO.

- ③ Push **[▲]**(2) or **[▼]**(8) several times to select “BANK.”

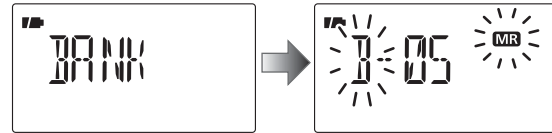

- ④ Push **[▶]**(6) to select the bank channels selection or push **[◀]**(4) to select the bank group selection to be transferred.
- ⑤ Rotate **[DIAL]** to select the desired bank group or channel.
 - Select “----” indication when erasing the contents from the bank.

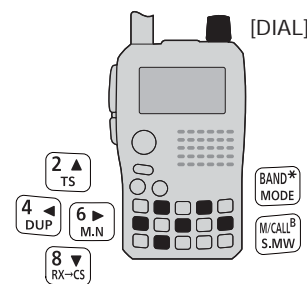

To transfer the bank contents to ch 11 in Bank B.

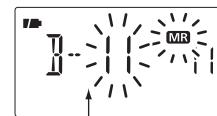

Bank channel is displayed.

To erase

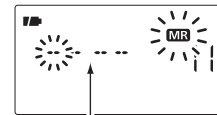

“----” is displayed.

- ⑥ Push **[S.MW]**(M/CALL) for 1 sec. to erase/transfer the bank contents.

10 SCAN OPERATION

■ Scan types

Scanning searches for signals automatically and makes it easier to locate new stations for contact or listening purposes.

FULL SCAN (p. 102)

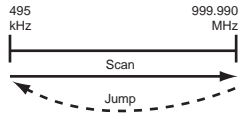

Repeatedly scans all frequencies over the entire band. Some frequency ranges are not scanned according to the frequency coverage of the transceiver's version.

SELECTED BAND SCAN (p. 102)

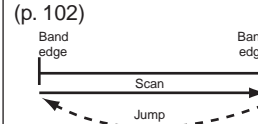

Repeatedly scans all frequencies over the entire selected band.

PROGRAMMED SCAN (p. 102)

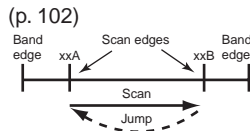

Repeatedly scans between two user-programmed frequencies. Used for checking for frequencies within a specified range such as repeater output frequencies, etc.

FREQUENCY/MEMORY SKIP FUNCTION (p. 106)

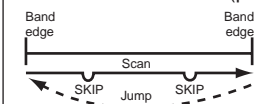

Skips unwanted frequencies or channels that inconveniently stop scanning. This function can be turned ON and OFF by pushing and holding **[SKIP](5)** in either VFO or memory mode.

PROGRAMMED LINK SCAN (pgs. 102, 121)

Repeatedly programmed scans user-programmed frequencies selected at P-LINK items in the menu mode.

MEMORY (SKIP) SCAN

(pgs. 104, 106)

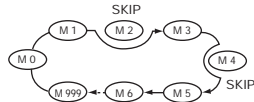

Repeatedly scans memory channels except those set as skip channel. Skip channels can be turned ON and OFF by pushing and holding **[SKIP](5)** in memory mode.

ALL/SELECTED BANK SCAN

(p. 105)



Repeatedly scans all bank channels or selected bank channels. The skip scan is also available.

BAND MEMORY (SKIP) SCAN (p. 104)

Repeatedly scans memory channels in the same band as displaying band.

MODE MEMORY (SKIP) SCAN (p. 104)

Repeatedly scans memory channels in the same mode as displaying mode.

BANK-LINK SCAN (pgs. 105, 120)

Repeatedly scans bank channels selected at BANK-LINK items in the menu mode.

10 SCAN OPERATION

■ Full/band/programmed scan

- ① Push **[V/MHz]** to select VFO mode.
 - Select the desired frequency band with **[BAND]**, if desired.
- ② Set the squelch level.
- ③ Push and hold **[SCAN]**(V/MHz) for 1 sec. to enter the scanning type selection.
- ④ Rotate **[DIAL]** to select the desired scanning type.
 - “ALL” for full scan; “BAND” for band scan, “P-LINK x” for programmed link scan (x= 0 to 9), “PROGxx (or scan name if programmed)” for programmed scan (xx= 0 to 24; programmed scan edges numbers are only displayed), “DUP” (appears only when duplex operation is set) for duplex scan.

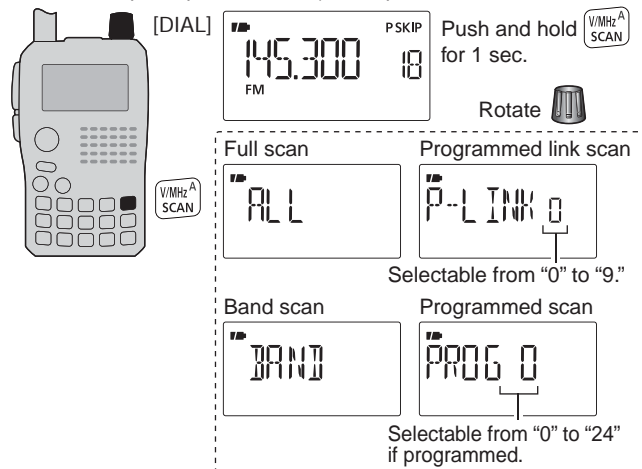

- ⑤ Push **[V/MHz]** to start the scan.
 - Scan pauses when a signal is received.
 - Rotate **[DIAL]** to change the scanning direction, or resumes manually.
 - Push **[V/MHz]** to stop the scan.

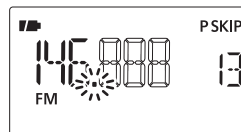

During full/band scan

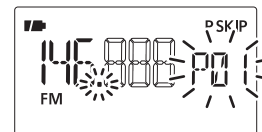

During programmed scan

/// **About the scanning steps:** The selected tuning step in each frequency band (in VFO mode) is used during scan.

/// **Duplex scan function:** Repeatedly scans two frequencies (transmission/reception) during duplex scan operation.

Scan name can be displayed instead of “P-LINK x” for program link scan (x= 0 to 9), “PROGxx” for programmed scan (xx= 0 to 24) when scan name is programmed and set to ON in DISP set mode.

MENU → SET → DISP → **SCAN N** (p. 128)

Scan name is not displayed during scan.

■ Scan edges programming

Scan edges can be programmed in the same manner as memory channels. Scan edges are programmed into scan edges, 00A/00B to 24A/24B, in memory channels.

- ① Push **[V/MHz]** to select VFO mode.
- ② Set the desired frequency:
 - ➔ Select the desired band with **[BAND]**.
 - ➔ Set the desired frequency with **[DIAL]**.
 - ➔ Program different frequencies in “**A” and “**B” respectively.
 - ➔ Set other data (e.g. offset frequency, duplex direction, tone squelch, etc.), if desired.
- ③ Push and hold **[S.MW]**(M/CALL) for 1 sec. to enter the select memory write mode.
 - 1 short and 1 long beeps sound.
 - “**MR**” indication and memory channel number blink.

- ④ Rotate **[DIAL]** to select the desired programmed scan edge channel from 00A to 24A.
- ⑤ Push and hold **[S.MW]**(M/CALL) for 1 sec.
 - 3 beeps sound.
 - The other scan edge channel “B,” 00B to 24B, is automatically selected when continuing to push **[S.MW]**(M/CALL) after programming.
- ⑥ To program a frequency for the other pair of scan edges, 00B to 24B, repeat steps ② and ④.
 - If the same frequency is programmed into a pair of scan edges, programmed scan will not function.

[EXAMPLE]: Programming 145.300 MHz into scan edges 04A.

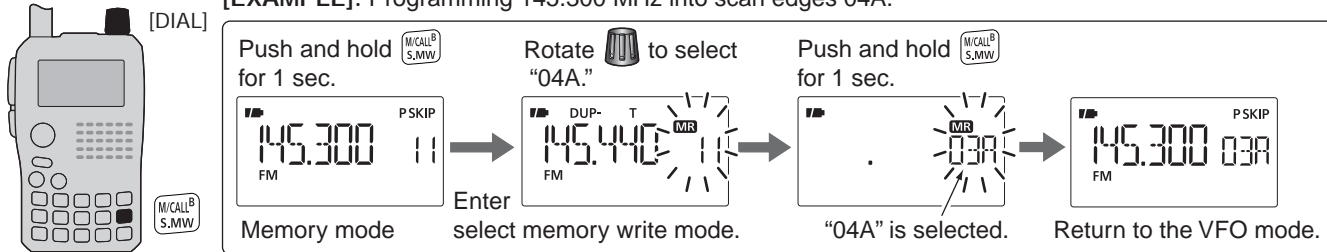

10 SCAN OPERATION

Memory scan

IMPORTANT!: To perform memory scan, 2 or more memory channels **MUST** be programmed, otherwise the scan will not start.

- 1 Push **[M/CALL]** several times to select memory mode.
- 2 Set the squelch level.
- 3 Push and hold **[SCAN]**(V/MHz) for 1 sec. to enter the scanning type selection.
- 4 Rotate **[DIAL]** to select the desired scanning type.
 - “ALL” for all memory scan; “BAND” for band memory scan, “MODE” for mode scan, “DUP” (appears only when duplex operation is set) for duplex scan.

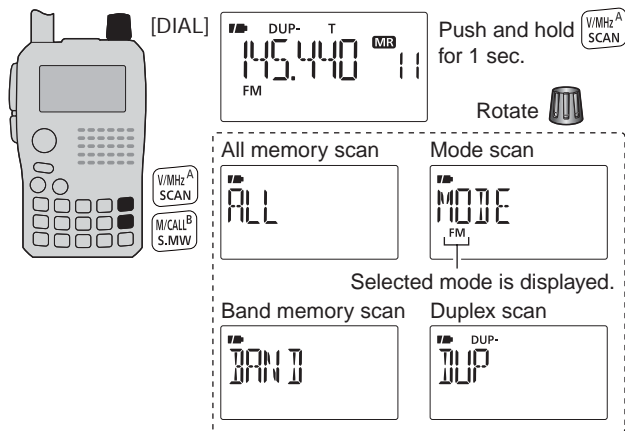

- 5 Push **[V/MHz]** to start the scan.
 - Scan pauses when a signal is received.
 - Rotate **[DIAL]** to change the scanning direction, or resumes manually.
 - Push **[V/MHz]** to stop the scan.

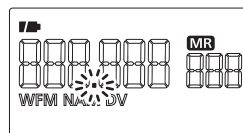

During memory scan

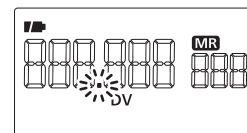

During mode scan

Band memory scan function: Repeatedly scans all memory channels programmed with any frequencies of the band programmed in the memory channel selected for scanning.

Mode scan function: Repeatedly scans all memory channels in which the same operating mode as the selected memory channel has been programmed.

Duplex scan function: Repeatedly scans two frequencies (transmission/reception) during duplex scan operation.

Memory bank scan

IMPORTANT!: To perform memory bank scan, 2 or more bank channels MUST be programmed, otherwise the scan will not start.

- ① Select memory bank mode.
 - ➔ Select memory mode with **[M/CALL]**.
 - ➔ Enter the bank selection state with **[BAND]**.
 - ➔ Set the desired bank (A to Z) with **[DIAL]**, then push **[BAND]**.
- ② Set the squelch level.
- ③ Push and hold **[SCAN]**(V/MHz) for 1 sec. to enter the scanning type selection.

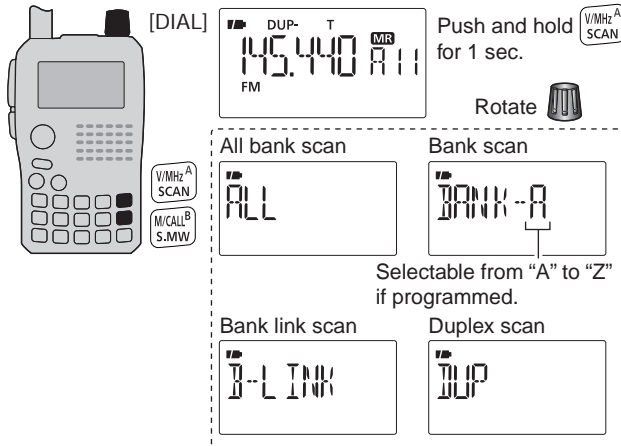

- ④ Rotate **[DIAL]** to select the desired scanning type.
 - "ALL" for all bank scan; "B-LINK" for bank link scan or "BANK-x" for bank scan (X= A to Z; programmed bank groups are only displayed.), "DUP" (appears only when duplex operation is set) for duplex scan.
- ⑤ Push **[V/MHz]** to start the scan.
 - Scan pauses when a signal is received.
 - Rotate **[DIAL]** to change the scanning direction, or resumes manually.
 - Push **[V/MHz]** to stop the scan.

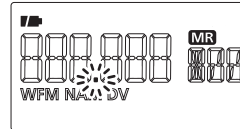

During all bank/bank link scan

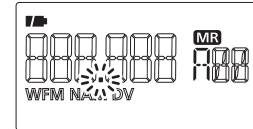

During bank scan

The bank-link setting can be changed in SCAN set mode. See page 120 for details.

Duplex scan function: Repeatedly scans two frequencies (transmission/reception) during duplex scan operation.

Memory bank scan skips any memory channels in the selected bank that are set to "SKIP" or "PSKIP"

Memory bank scan stops at the first channel when all channels in a bank are set to "SKIP" or "PSKIP"

10 SCAN OPERATION

■ Skip channel/frequency setting

Memory channels can be set to be skipped during memory skip scan. In addition, memory channels can be set to be skipped during both memory skip scan and frequency skip scan. This is useful to speed up the scan rate.

① Select a memory channel:

- Push **[M/CALL]** to select memory mode.
- Rotate **[DIAL]** to select the desired channel to be a skip channel/frequency.

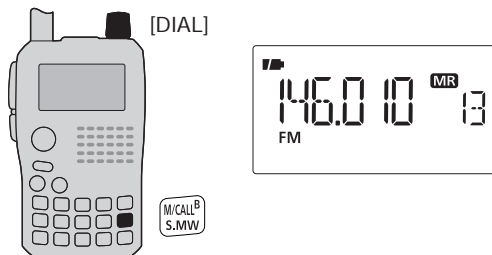

② Push and hold **[S.MW]**(M/CALL) for 1 sec. to enter select memory write mode.



③ Push **[▲]**(2) or **[▼]**(8) several times to select “SKIP.”

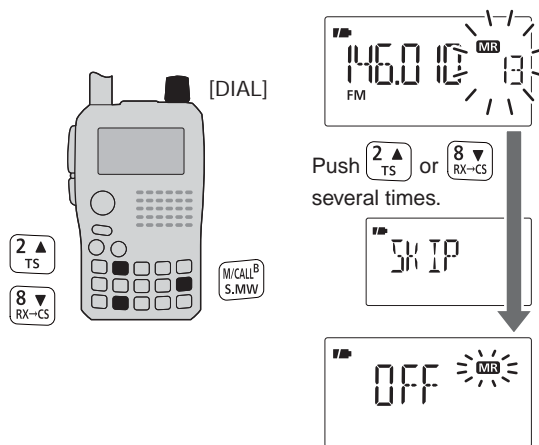

④ Rotate **[DIAL]** to select the skip condition from “SKIP,” “PSKIP” or “OFF” for the selected channel.

- PSKIP : The channel is skipped during memory/bank scan and the programmed frequency is skipped during VFO scan, such as programmed scan.
- SKIP : The channel is skipped during memory or bank scan.
- OFF : The channel is scanned during any scan.

(Continue to the next page.)

- ⑤ Push and hold **[S.MW]**(M/CALL) for 1 sec. to store the skip condition into the memory.
- “SKIP” or “PSKIP” indicator appears, according to the skip selection in the step ④.

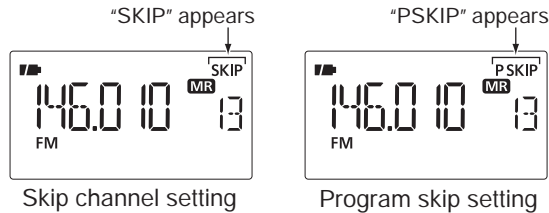

✓ CONVENIENT!

The skip setting can be set with the following operation.

- ① Select the desired memory channel to be set as a skip channel/frequency.
- ② While pushing **[SKIP]**(5), rotate **[DIAL]** to select the skip condition from “PSKIP,” “SKIP” and “OFF (no indication).”



✓ CONVENIENT!

During VFO scanning, such as programmed scan, the skip setting can be programmed into the highest blank memory channel which is automatically selected with the following operation.

- ① Start the VFO scan.
 - Push **[V/MHz]** to select VFO mode.
 - Select the desired frequency band with **[BAND]**, if desired.
 - Set the squelch level.
 - While pushing and holding **[SCAN]**(V/MHz) for 1 sec. to enter scan type selection, then rotate **[DIAL]** to select the desired scan type.
 - “ALL” for full scan; “BAND” for band scan, “P-LINK x” for programmed link scan (x= 0 to 9), “PROGxx (or scan name if programmed)” for programmed scan (xx= 0 to 24; programmed scan edges numbers are only displayed), “DUP” for duplex scan.
 - Push **[SCAN]**(V/MHz) again to start the scan.
 - Scan pauses when a signal is received.
 - Rotate **[DIAL]** to change the scanning direction, or resumes manually.
- ② When scan pauses and you want to set the paused frequency as a skip frequency.
 - Push and hold **[SKIP]**(5) for 1 sec. to store the paused frequency into the highest blank memory channel.
 - While pushing and holding **[SKIP]**(5), scan pauses; and when releasing **[SKIP]**(5) scan resumes.

10 SCAN OPERATION

■ Scan resume condition

◇ Scan pause timer

The scan pauses when receiving signals according to the scan pause time. It can be set from 2 to 20 sec. or unlimited.

- ① Enter "PAUSE" in SCAN set mode.

MENU ⇄ SCAN ⇄ **PAUSE** (p. 119)
(Push [MENU , (Push [▲](2)/[▼](8), then push [←](5).)

- ② Push [▲](2) or [▼](8) to select the desired scan pausing time from 2–20 sec. (2 sec. steps) or "HOLD."

- "2SEC"–"20SEC": Scan pauses for 2–20 sec. while receiving a signal.
- "HOLD" : Scan pauses on a received a signal until it disappears.

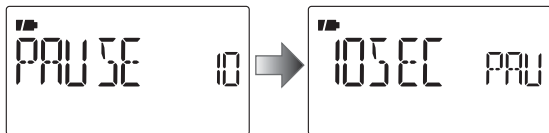

- ③ Push [←](5) to return to SCAN set mode.
④ [MENU ] to return to frequency indication.

◇ Scan resume timer

The scan restarts after the signal disappears according to the resume time. It can be set from 0–5 sec. or unlimited.

- ① Enter "RESUME TIMER" in SCAN set mode.

MENU ⇄ SCAN ⇄ **RESUME** (p. 119)
(Push [MENU , (Push [▲](2)/[▼](8), then push [←](5).)

- ② Push [▲](2) or [▼](8) to select the desired scan resume time from 0–5 sec. (1 sec. steps) and "HOLD."

- "0SEC" : Scan restarts immediately after the signal disappears.
- "1SEC"–"5SEC": Scan restarts 1–5 sec. after the signal disappears.
- "HOLD" : Scan remains paused on the received signal according to the scan pause timer even if it disappears. Rotate [DIAL] to resume manually.

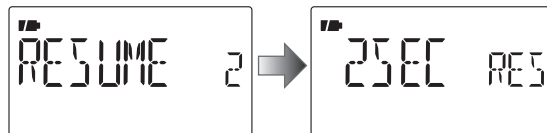

- ③ Push [←](5) to return to SCAN set mode.
④ [MENU ] to return to frequency indication.

/// Scan resume timer must be set shorter than the scan pause timer, otherwise this timer does not activate.

■ Priority watch types

Priority watch checks for signals on the frequency every 5 sec. while operating on a VFO frequency or scanning (except DR mode watch). The transceiver has 4 priority watch types to suit your needs.

The watch resumes according to the selected scan resume condition. See page 108 for details.

NOTE: If the pocket beep function is activated, the transceiver automatically selects the tone squelch function when priority watch starts.

◇ About priority beep function

When receiving a signal on the priority frequency, you can be alerted with beeps and a blink “(•)”. This function can be activated when setting the priority watch function ON.

MEMORY/CALL CHANNEL WATCH

While operating on a VFO frequency, priority watch checks for a signal on the selected channel every 5 sec.

- A memory channel with skip information can be watched.

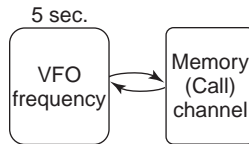

MEMORY SCAN WATCH

While operating on a VFO frequency, priority watch checks for signals on each memory channel in sequence.

- The memory skip function and/or memory bank scan is useful to speed up the scan.

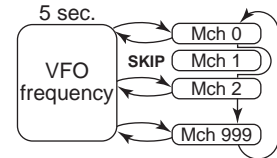

VFO SCAN WATCH

While scanning in VFO mode, priority watch checks for signals on the selected channel every 5 sec.



DR MODE WATCH

While operating in DR mode, priority watch checks for a signal on the VFO frequency every 5 sec.

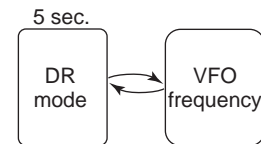

Priority watch operation

◆ Memory/call channel and memory scan watch

- ① Select VFO mode; then, set an operating frequency.
- ② Select the channel(s) to be watched.

For memory channel watch:

Select the desired memory channel.

For call channel watch:

Select the desired call channel.

For memory scan watch:

Select memory mode, or the desired bank group; then, push and hold **[SCAN]**(V/MHz) for 1 sec. to start memory/bank scan.

- ③ Enter "PRIO" in SCAN set mode.

MENU ⇄ SCAN ⇄ **PRIO** (p. 119)
 (Push **[MENU]**), (Push **[▲]**(2)/**[▼]**(8), then push **[←]**(5.)

- ④ Push **[▲]**(2) or **[▼]**(8) to select "ON."
 - Select "BELL" if the priority beep function is desired.
- ⑤ Push **[MENU]** to exit SCAN set mode and start the watch.
 - "PRIO" indicator appears.
 - The transceiver checks the memory/bank channel(s) or call channel every 5 sec.
 - The watch resumes according to the selected scan resume condition. (p. 108)
- ⑥ Push **[V/MHz]** to cancel the watch.

• During priority watch



Monitors VFO frequency for 5 sec.

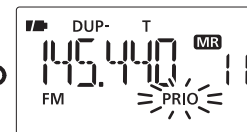

Pauses on a memory or call channel when a signal is received.

• During priority watch with priority beep

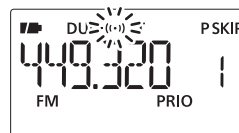

Emits beep and blinks "(*)" indicator when a signal is received on a memory or call channel.

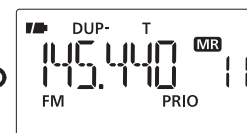

◇ **VFO scan watch**

① Select the channel(s) to be watched.

For memory channel watch:

Select the desired memory channel.

For call channel watch:

Select the desired call channel.

For memory scan watch:

Select memory mode, or the desired bank group; then, push and hold **[SCAN]**(V/MHz) for 1 sec. to start memory/bank scan.

② Enter "PRIO" in SCAN set mode.

MENU ⇄ SCAN ⇄ **PRIO** (p. 119)
 (Push **[MENU]** (), (Push **[▲]**(2)/**[▼]**(8), then push **[←]**(5).)

③ Push **[▲]**(2) or **[▼]**(8) to select "ON."

- Select "BELL" if the priority beep function is desired.

④ Push **[MENU]** () to exit SCAN set mode and start the watch.

- "PRIO" indicator appears.

⑤ Push and hold **[SCAN]**(V/MHz) for 1 sec. to enter scan type selection.

⑥ Rotate **[DIAL]** to select the desired scan type from "ALL," "BAND" "P-LINK x (x= 0-9)" and "PROGxx (xx= 0-24)," "DUP."

⑦ Push **[SCAN]**(V/MHz) to start the VFO scan watch.

- The transceiver checks the memory/bank channel(s) or call channel every 5 sec.
- The watch resumes according to the selected scan resume condition. (p. 108)

⑧ Push **[V/MHz]** to cancel the watch.

• **During priority watch**

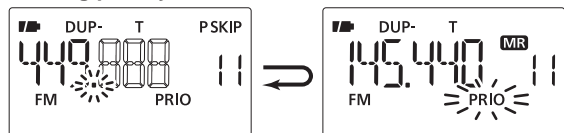

Searches VFO frequencies for 5 sec.

Pauses on a memory or call channel when a signal is received.

• **During priority watch with priority beep**

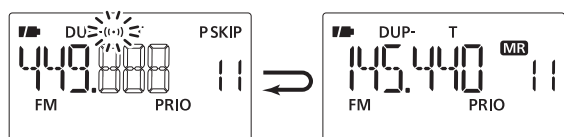

Emits beep and blinks "(•)" indicator when a signal is received on a memory or call channel.

11 PRIORITY WATCH

◇ Digital Repeater/VFO watch

- ① Select VFO mode; then, set an operating frequency.
- ② Push **[DR]** to enter DR mode.
- ③ Select the access repeater to be watched.
- ④ Enter "PRIO" in SCAN set mode.

MENU ⇨ SCAN ⇨ **PRIO** (p. 119)
(Push **[MENU]**), (Push **[▲]**(2)/**[▼]**(8), then push **[←]**(5).)

- ③ Rotate **[DIAL]** to select "ON."
 - Select "BELL" if the priority beep function is desired.
- ④ Push **[MENU]** to exit SCAN set mode and start the watch.
 - "PRIO" indicator appears.
 - The transceiver checks VFO mode every 5 sec.
 - The watch resume according to the selected scan resume condition. (p. 108)
- ⑥ Push **[V/MHz]** to cancel the watch.

• During priority watch

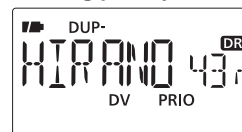

Monitors DR mode for 5 sec.



Pauses on a VFO mode when a signal is received.

• During priority watch with priority beep

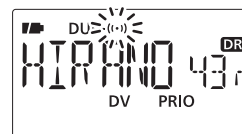

Emits beep and blinks "((•))" indicator when a signal is received on a VFO mode.

