



INSTRUCTION MANUAL

CLASS B AIS TRANSPONDER **MA-500TR**



Icom Inc.

FOREWORD

Thank you for purchasing this Icom product. The MA-500TR CLASS B AIS TRANSPONDER is designed and built with Icom's state of the art technology and craftsmanship. With proper care, this product should provide you with years of trouble-free operation.

We appreciate you making the MA-500TR your transponder of choice, and hope you agree with Icom's philosophy of "technology first." Many hours of research and development went into the design of your MA-500TR.

◇ **FEATURES**

- *Full dot-matrix display visually shows real-time vessel traffic information*
- *IPX7 waterproof protection*
- *3 lines of NMEA0183 Input/Output*
- *GPS receiver comes with the MA-500TR*
- *Collision-risk management functions*
- *Integration with Icom VHF transceivers**

* See the leaflet that comes with the transponder for details of the corresponding transceiver.

IMPORTANT

READ ALL INSTRUCTIONS carefully and completely before using the transponder.

SAVE THIS INSTRUCTION MANUAL — This instruction manual contains important operating instructions for the MA-500TR.

EXPLICIT DEFINITIONS

WORD	DEFINITION
⚠ WARNING!	Personal injury, fire hazard or electric shock may occur.
CAUTION	Equipment damage may occur.
NOTE	If disregarded, inconvenience only. No risk of personal injury, fire or electric shock.

CLEAN THE TRANSPONDER THOROUGHLY WITH FRESH WATER after exposure to saltwater, otherwise, the keys and switch may become inoperable due to salt crystallization.

FCC INFORMATION

• FOR CLASS B UNINTENTIONAL RADIATORS

This equipment has been tested and found to comply with the limits for a Class B digital device, pursuant to part 15 of the FCC Rules. These limits are designed to provide reasonable protection against harmful interference in a residential installation. This equipment generates, uses and can radiate radio frequency energy and, if not installed and used in accordance with the instructions, may cause harmful interference to radio communications. However, there is no guarantee that interference will not occur in a particular installation. If this equipment does cause harmful interference to radio or television reception, which can be determined by turning the equipment off and on, the user is encouraged to try to correct the interference by one or more of the following measures:

- Reorient or relocate the receiving antenna.
- Increase the separation between the equipment and receiver.
- Connect the equipment into an outlet on a circuit different from that to which the receiver is connected.
- Consult the dealer or an experienced radio/TV technician for help.

SUPPLIED ACCESSORIES

DC power cable (OPC-2059)

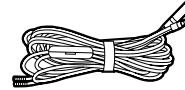

NMEA connector cable (OPC-2014)

- The OPC-2014 has 15 leads, numbered 1 to 15.

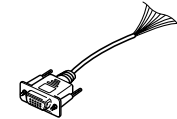

Mounting bracket

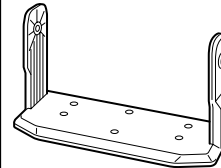

For the mounting bracket

Knob bolts



Flat washers (M5)



Screws (5x20)



Spring washers (M5)



MXG-5000 GPS RECEIVER is included with MA-500TR.

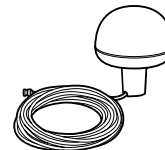

MXG-5000 (Referred to as Internal GPS)
Cable length: Approx. 10 m (32.8 ft)

- An instruction sheet comes with the MXG-5000. Please read it before installing and operating the MXG-5000.

RADIO OPERATOR WARNING



WARNING

Icom requires the radio operator to meet the FCC Requirements for Radio Frequency Exposure. An omnidirectional antenna with gain not greater than 9 dBi must be mounted a minimum of 5 meters (measured from the lowest point of the antenna) vertically above the main deck and all possible personnel. This is the minimum safe separation distance estimated to meet all RF exposure compliance requirements. This 5 meter distance is based on the FCC Safe Maximum Permissible Exposure (MPE) distance of 3 meters added to the height of an adult (2 meters) and is appropriate for all vessels.

For watercraft without suitable structures, the antenna must be mounted so as to maintain a minimum of 1 meter vertically between the antenna, (measured from the lowest point of the antenna), to the heads of all persons AND all persons must stay outside of the 3 meter MPE radius.

Do not transmit with radio and antenna when persons are within the MPE radius of the antenna, unless such persons (such as driver or radio operator) are shielded from antenna field by a grounded metallic barrier. The MPE Radius is the minimum distance from the antenna axis that person should maintain in order to avoid RF exposure higher than the allowable MPE level set by FCC.

FAILURE TO OBSERVE THESE LIMITS MAY ALLOW THOSE WITHIN THE MPE RADIUS TO EXPERIENCE RF RADIATION ABSORPTION WHICH EXCEEDS THE FCC MAXIMUM PERMISSIBLE EXPOSURE (MPE) LIMIT.

IT IS THE RESPONSIBILITY OF THE RADIO OPERATOR TO ENSURE THAT THE MAXIMUM PERMISSIBLE EXPOSURE LIMITS ARE OBSERVED AT ALL TIMES DURING RADIO TRANSMISSION. THE RADIO OPERATOR IS TO ENSURE THAT NO BYSTANDERS COME WITHIN THE RADIUS OF THE MAXIMUM PERMISSIBLE EXPOSURE LIMITS.

Determining MPE Radius

THE MAXIMUM PERMISSIBLE EXPOSURE (MPE) RADIUS HAS BEEN ESTIMATED TO BE A RADIUS OF ABOUT 3M PER OET BULLETIN 65 OF THE FCC.

THIS ESTIMATE IS MADE ASSUMING THE MAXIMUM POWER OF THE RADIO AND ANTENNAS WITH A MAXIMUM GAIN OF 9dBi ARE USED FOR A VESSEL MOUNTED SYSTEM.

ABOUT CE

• INSTALLATION NOTES

The installation of this equipment should be made in such a manner as to respect the EC recommended electromagnetic field exposure limits (1999/519/EC).

The maximum RF power available from this device is 2 watts. The antenna should be installed as high as possible for maximum efficiency and that this installation height should be at least 5 meters above ground (or accessible) level. In the case where an antenna cannot be installed at a reasonable height, then the transmitter should neither be continuously operated for long periods if any person is within 5 meters of the antenna, nor operated at all if any person is touching the antenna.

In all cases any possible risk depends on the transmitter being activated for long periods. (actual recommendation limits are specified as an average of 6 minutes) Normally the transmitter is not active for long periods of time. Some radio licenses will require that a timer circuit automatically cuts the transmitter after 1 to 2 minutes etc.

Similarly some types of transmitter, SSB, CW, AM, etc. have a lower 'average' output power and the perceived risk is even lower.



CE versions of the MA-500TR which display the "CE" symbol on the serial number label, comply with the essential requirements of the European Radio and Telecommunication Terminal Directive 1999/5/EC.



This warning symbol indicates that this equipment operates in non-harmonised frequency bands and/or may be subject to licensing conditions in the country of use. Be sure to check that you have the correct version of this radio or the correct programming of this radio, to comply with national licensing requirement.

ABOUT CE

	DECLARATION OF CONFORMITY
<p>We Icom Inc. Japan 1-1-32, Kamiminami, Hirano-ku Osaka 547-0003, Japan</p>	
	
<p>Declare on our sole responsibility that this equipment complies with the essential requirements of the Radio and Telecommunications Terminal Equipment Directive, 1999/5/EC, and that any applicable Essential Test Suite measurements have been performed.</p>	
<p>Kind of equipment: <u>CLASS B AIS TRANSPONDER</u></p>	<p><small>Bad Soden 2nd Dec. 2010</small> <small>Place and date of issue</small></p>
<p>Type-designation: <u>MA-500TR</u></p>	<p><small>Icom (Europe) GmbH</small> <small>Communication Equipment</small> <small>Auf der Krautweide 24,</small> <small>65812 Bad Soden am Taunus,</small> <small>Germany</small></p>
<p>Version (where applicable): _____</p> <p>This compliance is based on conformity with the following harmonised standards, specifications or documents:</p> <p>i) <u>IEC 62287-1</u> _____</p> <p>ii) <u>ITU-R M.1371-3</u> _____</p> <p>iii) <u>ITU-R M.825-3</u> _____</p> <p>iv) <u>IEC 60945 2002</u> _____</p> <p>v) <u>EN 60950-1 2006 A11 : 2009</u> _____</p> <p>vi) _____</p>	<p><small>Authorized representative name</small></p> <p><small>Y. Furukawa</small> <small>General Manager</small></p>  <p><small>Signature</small></p> <p style="text-align: center;">Icom Inc.</p>

• List of Country codes (ISO 3166-1)

	Country	Codes		Country	Codes
1	Austria	AT	18	Liechtenstein	LI
2	Belgium	BE	19	Lithuania	LT
3	Bulgaria	BG	20	Luxembourg	LU
4	Croatia	HR	21	Malta	MT
5	Czech Republic	CZ	22	Netherlands	NL
6	Cyprus	CY	23	Norway	NO
7	Denmark	DK	24	Poland	PL
8	Estonia	EE	25	Portugal	PT
9	Finland	FI	26	Romania	RO
10	France	FR	27	Slovakia	SK
11	Germany	DE	28	Slovenia	SI
12	Greece	GR	29	Spain	ES
13	Hungary	HU	30	Sweden	SE
14	Iceland	IS	31	Switzerland	CH
15	Ireland	IE	32	Turkey	TR
16	Italy	IT	33	United Kingdom	GB
17	Latvia	LV			

PRECAUTIONS

⚠ WARNING! NEVER connect the transponder to an AC outlet. This may pose a fire hazard or result in an electric shock.

⚠ WARNING! NEVER connect the transponder to a power source of more than 16 V DC or use reverse polarity. This could cause a fire or damage the transponder.

⚠ WARNING! NEVER cut the DC power cable between the DC plug at the back of the transponder and fuse holder. If an incorrect connection is made after cutting, the transponder may be damaged.

CAUTION: NEVER place the transponder where normal operation of the vessel may be hindered or where it could cause bodily injury.

KEEP the transponder at least 1 m (3.3 ft) away from the vessel's magnetic navigation compass.

DO NOT use or place the transponder in areas with temperatures below -20°C (-4°F) or above $+60^{\circ}\text{C}$ ($+140^{\circ}\text{F}$) or, in areas subject to direct sunlight, such as the dashboard.

DO NOT use harsh solvents such as benzine or alcohol when cleaning, as they will damage the transponder surfaces. If the transponder becomes dusty or dirty, wipe it clean with a soft, dry cloth.

BE CAREFUL! The transponder rear panel will become hot when operating continuously for long periods of time. Place the transponder in a secure place to avoid inadvertent use by children.

BE CAREFUL! The transponder meets IPX7* requirements for waterproof protection. However, once the transponder has been dropped, waterproof protection cannot be guaranteed because of possible damage to the transponder's case or the waterproof seal.

* Except for the DC power and cloning cable connectors.

For U.S.A. only

CAUTION: Changes or modifications to this device, not expressly approved by Icom Inc., could void your authority to operate this device under FCC regulations.

Approved Icom optional equipment is designed for optimal performance when used with an Icom transponder.

Icom is not responsible for the destruction or damage to an Icom transponder in the event Icom transponder is used with equipment that is not manufactured or approved by Icom.

Icom, Icom Inc. and the Icom logo are registered trademarks of Icom Incorporated (Japan) in Japan, the United States, the United Kingdom, Germany, France, Spain, Russia and/or other countries.

MarineCommander is a trademark of Icom Incorporated.

All other products or brands are registered trademarks or trademarks of their respective holders.

TABLE OF CONTENTS

FOREWORD	i	5 OTHER FUNCTIONS.....	23–27
IMPORTANT	i	■ Message.....	23
EXPLICIT DEFINITIONS.....	i	■ Waypoint.....	24
FCC INFORMATION	ii	■ Lost target	27
SUPPLIED ACCESSORIES.....	ii	6 MENU MODE OPERATION.....	28–34
RADIO OPERATOR WARNING	iii	■ General.....	28
ABOUT CE	iv	■ Menu mode items.....	28
PRECAUTIONS.....	vi	7 INSTALLATION AND CONNECTIONS	35–42
TABLE OF CONTENTS.....	vii	■ Connections	35
1 OVERVIEW.....	1	■ Fuse replacement	38
2 PANEL DESCRIPTION.....	2–6	■ Antenna.....	38
■ Front panel.....	2	■ Transceiver connection.....	39
■ Function display.....	4	■ Mounting the transponder	41
3 PREPARATION.....	7–13	■ MB-75 installation.....	42
■ MMSI code setting.....	7	8 MAINTENANCE	43–45
■ Initial setting mode	9	■ Troubleshooting	43
4 BASIC OPERATION.....	14–22	■ Error message.....	44
■ Turning power ON.....	14	■ Diagnostics.....	44
■ Display backlight and contrast settings	15	9 SPECIFICATIONS AND OPTION.....	46
■ Plotter display operation.....	15	■ Specifications	46
■ Target list display operation	16	■ Option.....	46
■ Danger list display operation	17	10 TEMPLATE.....	47
■ About the detail screen	17	11 AtoN CODE AND DESCRIPTION.....	49
■ Individual DSC call (Possible only when a transceiver is connected)	22		

◇ ABOUT AIS

AIS is an acronym for “Automatic Identification System.” An AIS transponder is a short range data radio unit, used primarily for collision-risk management and navigation safety. It automatically transmits and receives vessel information such as the vessel name, MMSI code, vessel type, position data, speed, course, destination and more. Information is exchanged among the vessels and/or base stations on the VHF maritime mobile band. The information helps to identify other nearby vessels or stations by displaying the received data on a plotter or a radar screen.

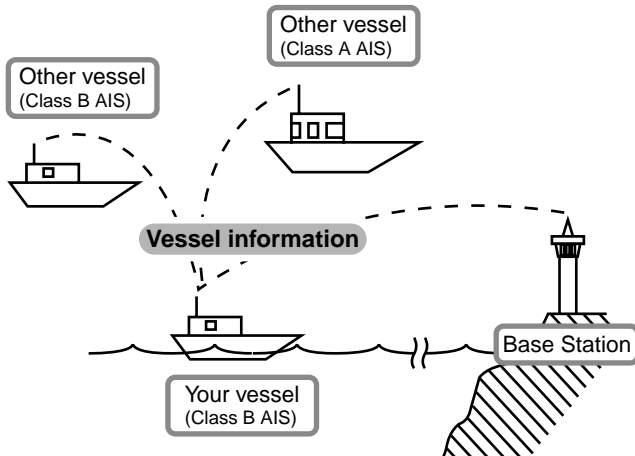

◇ AIS Classes

There are four types of AIS stations; vessels, base stations, Aids to Navigation (AtoN) and Search and Rescue (SAR).

There are two classes of AIS units, which are installed on vessels; Class A and Class B.

Under the Safety Of Life At Sea (SOLAS) convention, all SOLAS vessels, as described below, are required to install a Class A AIS transponder:

- Upwards of 300 gross tonnage engaged on international voyages.
- Passenger vessels, irrespective of size, engaged on international voyages.
- Upwards of 500 gross tonnage not engaged on international voyages.

A Class B AIS transponder is designed to be interoperability with Class A units, but not to impact the Class A network. Many commercial vessels, and some leisure craft, not classified as requiring a Class A unit, choose to install a Class B unit to avoid accidents at sea.

Front panel

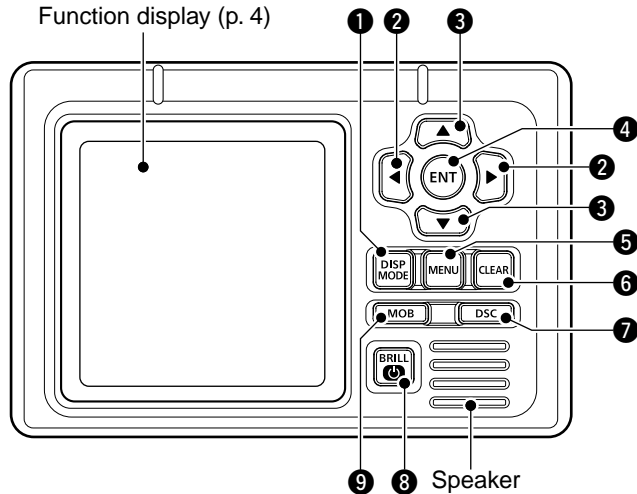

The angle brackets show common or special display operations, as described below:

- **<Common>** shows the common operation.
- **<In the plotter display>** shows the plotter display operation.
- **<In the target list display>** shows the target list display operation.
- **<In the danger list display>** shows the danger list display operation.

1 DISPLAY MODE KEY [DISP MODE]

<Common>

- ➔ Push to switch the display mode between the plotter, target list and danger list. (pp. 4–6)
- ➔ While in the Menu mode, push to exit it, and return to the plotter, target list or danger list display which was selected before you entered the Menu mode.

2 LEFT AND RIGHT KEYS [◀/▶]

<Common>

While in the Menu item setting mode, push to select a menu option. (pp. 29, 33)

<In the plotter display>

- ➔ Push [◀] to sequentially select each AIS target icon farthest from your vessel (or waypoint, if it is set; see page 24 for setting detail). (p. 15)
- ➔ Push [▶] to sequentially select each AIS target icon closest to your vessel (or waypoint, if it is set; see page 24 for setting detail). (p. 15)
 - A target box will appear around the selected target or waypoint icon.

<In the danger list display>

- ➔ Push [◀] to sort the AIS target data by CPA (Closest Point of Approach). (p. 17)
- ➔ Push [▶] to sort the AIS target data by TCPA (Time to CPA). (p. 17)

3 UP AND DOWN KEYS [▲]/[▼]**<Common>**

- ➔ While in the Menu mode, push to select a menu item. (pp. 9, 28)
- ➔ Push to select a voice channel in the voice channel selection screen. (p. 21)

<In the plotter display>

Push to select the display range. (p. 15)

<In the target or danger list display>

Push to select an AIS target in the target or danger list display. (pp. 16, 17)

4 ENTER KEY [ENT]**<Common>**

- ➔ Push to display the detail screen of the selected AIS target. (pp. 15–17)
- ➔ Push to save the input data. (pp. 8, 10, 15)
- ➔ Push to enter the Menu item setting mode. (pp. 9, 28)
- ➔ While in the Menu item setting mode, push to select a menu option. (pp. 11, 12, 16, 29, 32–34)
- ➔ While searching for a GPS satellite, push [ENT] to display the GPS information screen. (p. 14, 31)

5 MENU KEY [MENU]**<Common>**

- ➔ Push to enter the Menu mode. (pp. 9, 28)
- ➔ While in the Menu mode, push to exit it, and return to the plotter, target list or danger list display which was selected before you entered the Menu mode.

6 CLEAR KEY [CLEAR]**<Common>**

- ➔ Push to cancel the entered function, or return to the previous screen. (pp. 10, 13, 23)
- ➔ While in the Menu mode, push to exit it, and return to the previous screen. (pp. 9, 28)
- ➔ Push to stop an alarm. (pp. 15–17)

7 DSC KEY [DSC]**<Common>**

- ➔ When the AIS target is selected, or the detail screen is displayed, push to display the voice channel selection screen. (p. 22)
- ➔ After selecting the voice channel, push to transmit an Individual DSC call to the selected AIS target. (p. 22)

/// This function is available only when a transceiver is connected to the transponder. (p. 39)

8 POWER/BRILL KEY [POWER•BRILL]**<Common>**

- ➔ Hold down for 1 second to turn the power ON or OFF. (p. 14)
 - After turning ON the power, the opening screen will appear.
- ➔ Push to show the display backlight and contrast adjusting screen. (p. 15)

9 MAN OVERBOARD KEY [MOB]**<Common>**

Hold down for 1 second to set the waypoint. (p. 25)

- The MOB alarm sounds, and a flag icon appears on your current position.

2 PANEL DESCRIPTION

■ Function display

There are three display types; plotter, target list and danger list, and you can select your desired type using the **[DISP MODE]** key.

NOTE: When one of the following messages is displayed on the function display, push **[CLEAR]** to clear it.

- “PRIORITY INTERRUPTED LAST ATTEMPTS” is displayed when the transponder cannot make a periodic transmission because the transponder detects a transmit signal.
- “BASE STATION INHIBITING AIS TX FOR * * MIN” is displayed when the transmission is inhibited by a base station for the displayed time period.

The transmission inhibit period is displayed instead of “ *.”

- “TX OFF” is also displayed while transmission is inhibited.

◇ Plotter display

After the transponder is turned ON, the plotter display automatically appears, if the GPS receiver is connected and it receives signals from a satellite. It shows the display range and the icons of the AIS targets.

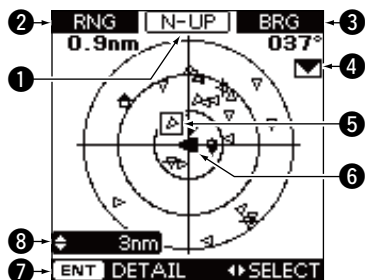

① DISPLAY TYPE

Shows the selected display type.

- When “N-UP” is displayed, the top of the plotter display represents North.
- When “AC-UP” is displayed, the top of the plotter display represents the direction your course is heading.

② RANGE/CPA INFORMATION

- ➔ Shows the range information from your vessel to the selected AIS target.
- ➔ Shows the CPA (Closest Point of Approach) information of the selected AIS target whose CPA is within 6 nm (nautical miles) and TCPA (Time to CPA) is within 60 minutes of your vessel.

③ BEARING/TCPA INFORMATION

- ➔ Shows the bearing information from your vessel to the selected AIS target.
- ➔ Shows TCPA information of the selected AIS target whose CPA is within 6 nm (nautical miles) and TCPA is within 60 minutes of your vessel.

④ MESSAGE ICON

Appears when a message is received.

- The message icon stays on the plotter display as long as the unread message is stored in the RX log memory.

5 TARGET BOX

Shows the selected AIS target (or waypoint, if it is set; see pages 24–26 for setting detail).

- When a target box appears, push **[ENT]** to display the detail screen of the selected AIS target or waypoint.

6 YOUR VESSEL ICON

Your vessel icon is displayed in the center of the display.

- When “N-UP” is displayed, the vessel icon automatically points in the direction you are heading, in 45 degrees steps.
- When “AC-UP” is displayed, the vessel icon constantly points to the top of the plotter display.
- When your vessel moves less than 2 knots, the icon is displayed as “●”

7 KEY ENTRY GUIDE

Shows the key entry guide.







- ➔ Push **[◀]** or **[▶]** to select each AIS target icon (or waypoint), in sequence. (p. 15)
 - A target box will appear around the selected target icon.
- ➔ Push **[ENT]** to display the detail screen of the selected AIS target or waypoint. (pp. 15–17)

8 DISPLAY RANGE

Shows the selected display range.

- 0.125, 0.25, 0.5, 0.75, 1.5, 3, 6, 12, 24 nm (nautical miles) are selectable.

• Description of the icons

Icon	Description
	AIS target: Vessel The tip of the target triangle automatically points in the direction it's heading. The icon blinks when the AIS target is closer than your CPA and TCPA settings. (Dangerous target)
	AIS target: Lost target* The target triangle is marked with a diagonal line.
	AIS target: Base Station
	AIS target: Search and Rescue (SAR)
	AIS target: Aids to Navigation (AtoN)
	Waypoint

*A vessel is regarded as a “Lost target” after a specified period of time has passed since the vessel last transmitted data. (p. 27)

The “Lost target” icon disappears from the plotter display 6 minutes and 40 seconds (default) after the vessel was regarded as a “Lost target.” Ask your dealer for details.

2 PANEL DESCRIPTION

■ Function display (Continued)

◇ Target list display

In the plotter display, push **[DISP MODE]** to switch to the target list display, which shows all AIS targets being detected by the transponder.

The AIS target data is sorted by the distance from your vessel, and the closest target is located on the top of the list.

MMSI/Name	RNG	BRG
004310505	0.6	323
WOOYANG	1.0	195
GLOBAL SER	1.1	087
357918	1.2	097
LONG BEACH	1.3	130
HOPE STAR	1.6	124
431100	1.6	173

① THE NUMBER OF TARGETS

Shows the number of AIS targets which are being detected by the transponder.

② KEY ENTRY GUIDE

Shows the key entry guide.

➔ Push **[▲]** or **[▼]** to select an AIS target. (p. 16)

➔ Push **[ENT]** to display the detail screen of the selected AIS target. (pp. 16, 17)

③ TARGET INFORMATION

Shows the following AIS target information:

- MMSI code or name, if the name is programmed.
- Range (RNG) from your vessel to the target (unit: nautical mile)
- Bearing (BRG) from your vessel to the target (unit: degree)

◇ Danger list display

In the target list display, push **[DISP MODE]** to switch to the danger list display, which helps you to find any dangerous target whose CPA is within 6 nm (nautical miles) and TCPA is within 60 minutes of your vessel.

MMSI/Name	CPA	TCPA
376019	0.1	17.6
DONGHAI	0.1	13.0
RBD JUTLAN	0.2	0.0
412630	0.5	3.4
SEA PLAIN S	1.0	0.6
WAN HAI 30	3.1	21.8
371567	3.7	15.9

① THE NUMBER OF DANGEROUS TARGETS

Shows the number of AIS targets which are being detected by the transponder.

② KEY ENTRY GUIDE

Shows the key entry guide.

➔ Push **[◀]** or **[▶]** to sort the danger target data. (p. 17)

➔ Push **[ENT]** to display the detail screen of the selected AIS target. (p. 17)

③ DANGER TARGET INFORMATION

Shows the following dangerous target information:

- MMSI code or name, if the name is programmed.
- CPA : Closest Point of Approach (unit: nautical mile)
- TCPA: Time to CPA (unit: minute)

■ MMSI code setting

The 9-digit MMSI (Maritime Mobile Service Identity: DSC self ID) code can be set at power ON. If the MMSI code has already been set, the following steps are not needed. Go to page 9.

/// This initial code setting can be performed only once.
 /// After being set, it can be changed by only your dealer or distributor.

- ① Hold down **[POWER•BRILL]** for 1 second to turn ON the power.
 - A long beep sounds, and the opening screen appears.

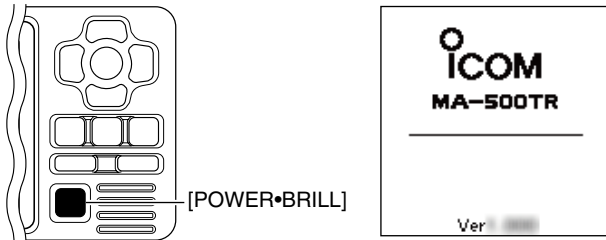

- ② The opening screen displays the results of the opening test (ROM, RAM and backup data test); “OK” or “NG” (No Good).
 - If “NG” is displayed, hold down **[POWER•BRILL]** for 1 second to turn OFF the power, then ON again to reset the transponder. If there is no change, contact your dealer or service center.

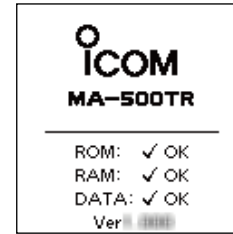

- ③ After the opening test is completed, “No MMSI” appears when no MMSI code is set.
 - If the MMSI code has already been set, the MMSI code appears. Go to page 9.
 - Push **[CLEAR]** to skip the setting, and go to the plotter display. In this case, the transponder operates as just an AIS receiver.

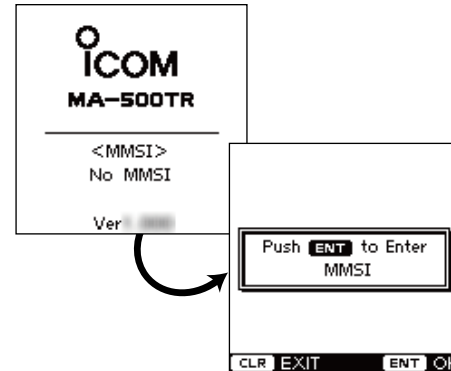

☞ Continued on the next page.

3 PREPARATION

■ MMSI code setting (Continued)

- ④ Push [ENT] to enter the MMSI code setting mode.
- ⑤ Push [▲] or [▼] to input the specific 9-digit MMSI code.
 - Push [▶] to move the cursor forward.
 - Push [◀] to move the cursor backward.
 - Push [CLEAR] to cancel, and go to the plotter display. In this case, the transponder operates as just an AIS receiver.

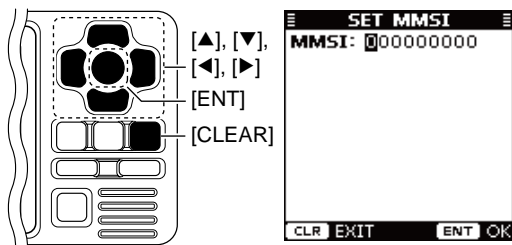

NOTE: The coast station ID or the group ID cannot be entered as your MMSI code.

- Group ID : The first one digit is "0."
- Coast station ID : The first two digits are "0."

If you enter a code that starts with "0" or "00," an error beep sounds after pushing [ENT] in step ⑥.

- ⑥ After inputting the 9-digit code, push [ENT].
 - The MMSI confirmation screen appears.

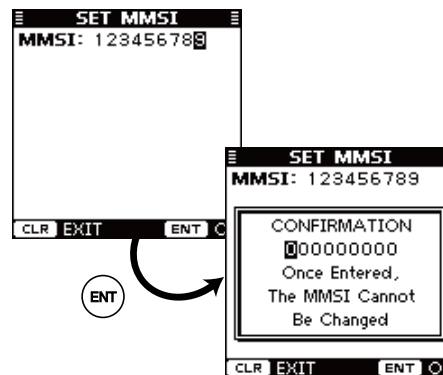

- ⑦ Input the same MMSI code which was entered in steps ⑤ and ⑥ for the confirmation. Then, push [ENT] to save.
- ⑧ After the MMSI code has been saved, the transponder automatically enters the Initial setting mode. See pages 9 to 13 for setting details.

/// The Initial setting mode can also be entered from the Menu mode. (p. 9)

■ Initial setting mode

The Initial setting mode allows you to set the vessel's information that is exchanged among the vessels and/or base stations. And, you can set the seldom-changed NMEA Input/Output settings.

NOTE: After the MMSI code programming, the transponder automatically enters the Initial setting mode. In this case, skip steps ① and ②.

- ① Push **[MENU]** to enter the Menu mode.
 - ② Push **[▲]** or **[▼]** to select "Initial Setting," then push **[ENT]**.
 - ③ Push **[▲]** or **[▼]** to select the desired item, then push **[ENT]**.
 - ④ Enter the characters or select the desired option.
- The procedures are described on pages 10 to 13.
- ⑤ Repeat steps ③ and ④ to set other items.
 - ⑥ Push **[CLEAR]** to exit the Initial setting mode, and return to the Menu mode.
 - ⑦ Push **[CLEAR]** to exit the Menu mode.

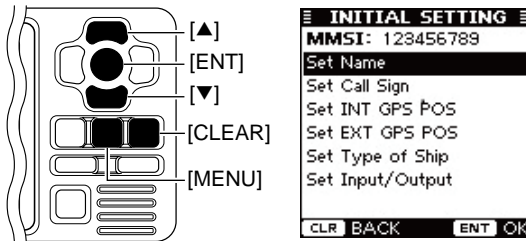

◇ MMSI code

Enter the vessel's MMSI code.

See page 7 for setting details.

- If the MMSI code has already been set, you cannot change this.

◇ Name

Enter the vessel's name of up to 20 characters.

See page 13 for setting details.

◇ Call Sign

Enter the Call Sign of up to 7 characters.

The Call Sign is a unique designation ID for a station.

See page 13 for setting details.

3 PREPARATION

■ Initial setting mode (Continued)

◇ Internal/External GPS Antenna Position

Set these measurements to indicate the internal and/or external GPS antenna position on the vessel.

- Internal GPS antenna : The GPS antenna which is connected to the [GPS] connector.
- External GPS antenna : The GPS antenna which is connected to one of the NMEA lines. (p. 37)

- ① Push **[▲]** or **[▼]** to select “A,” “B,” “C” or “D.”
 - A : Bow to Antenna
 - B : Stern to Antenna
 - C : Port side to Antenna
 - D : Starboard side to Antenna
 - Push **[CLEAR]** to cancel and return to the previous screen.
- ② Push **[◀]** or **[▶]** to input the value into that item.
 A and B : Between 0 and 511 meters (0 and 1676.5 feet)
 C and D : Between 0 and 63 meters (0 and 206.6 feet)
- ③ Repeat steps ① and ② to input other values.
- ④ Push **[ENT]** to save and return to the Initial setting mode.

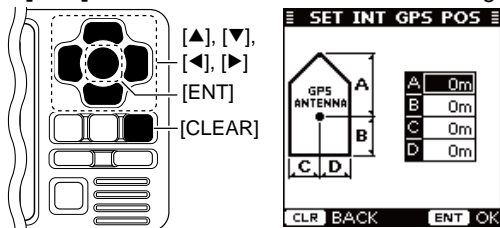

This screen shows the internal GPS antenna set screen.

▨ To show the external GPS antenna set screen, select “Set EXT GPS POS” in the “Initial Setting” mode. (p. 9)

◇ Type of Ship

Select your vessel type.

- ➔ Push **[▲]** or **[▼]** to select your vessel type from the list, then push **[ENT]** to save and return to the Initial setting mode.

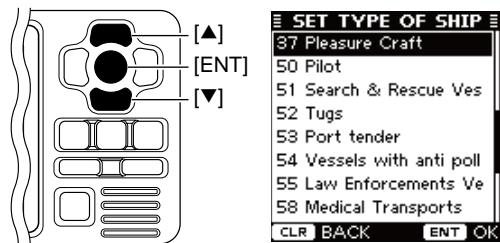

• Type of Ship List

30	Fishing	52	Tugs
31	Towing	53	Port tender
32	Towing & two < 200m	54	Vessels with anti pollution
33	Engaged in Dredging	55	Law enforcements Vessel
34	Engaged in Diving	58	Medical Transports
35	Engaged in Military	59	Ships RR Resolution NO18
36	Sailing	60	Passenger Ship
37	Pleasure Craft	70	Cargo Ship
50	Pilot	80	Tanker
51	Search & Rescue Vessel		

◇ NMEA Input/Output ports

• NMEA1/NMEA2/NMEA3 data speed

The data communication speed (baud rate) can be set for each Input/Output port; NMEA1 and NMEA3.

NOTE: The data communication speed of NMEA2 is fixed to 38400 bps. NMEA2 is used for communication between the transponder and the Icom MarineCommander™ system or a GPS receiver.

- ① Push **[▲]** or **[▼]** to select “NMEA1” or “NMEA3.”
 - NMEA1: Used for communication between the transponder and a transceiver or a GPS receiver. (Default: 4800 bps)
 - NMEA3: Used for communication between the transponder and a navigational equipment or a GPS receiver. (Default: 4800 bps)
 - You cannot select “NMEA2.”
- ② Push **[ENT]** to select the data communication speed between 4800 bps and 38400 bps into that item.
 - You can also select the option by pushing **[◀]** or **[▶]**.
- ③ Repeat steps ① and ② to set another port.
- ④ Push **[CLR]** to save and return to the Initial setting mode.

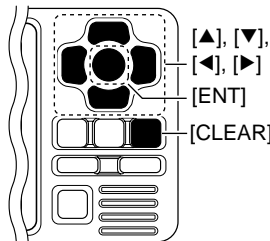

SET INPUT/OUTPUT	
NMEA1	4800bps
NMEA2	38400bps
NMEA3	4800bps
GPS Input1	OFF
GPS Input2	ON
GPS Input3	ON
AIS Output	AIS
Remote ID	84
CLR BACK ENT SELECT	

• GPS Input1/GPS Input2/GPS Input3

Set the NMEA1, NMEA2 and NMEA3 Input ports' capability.

- ① Push **[▲]** or **[▼]** to select “GPS Input1,” “GPS Input2” or “GPS Input3.”
 - “GPS Input1” is for the NMEA1, “GPS Input2” is for the NMEA2 and “GPS Input3” is for the NMEA3 ports setting.
- ② Push **[ENT]** to toggle this function ON or OFF.
 - You can also turn the function ON by pushing **[▶]**, or OFF by pushing **[◀]**.

ON : The GPS information that is received from the external GPS receiver of the selected port is sent to the transponder.

(Default for “GPS Input2” and “GPS Input3”)

OFF : The GPS information that is received from the external GPS receiver of the selected port is not sent to the transponder. (Default for “GPS Input1”)

- ③ Repeat steps ① and ② to set other ports' capability.
- ④ Push **[CLR]** to save and return to the Initial setting mode.

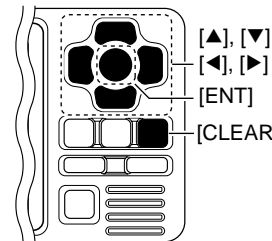

SET INPUT/OUTPUT	
NMEA1	4800bps
NMEA2	38400bps
NMEA3	4800bps
GPS Input1	OFF
GPS Input2	ON
GPS Input3	ON
AIS Output	AIS
Remote ID	84
CLR BACK ENT SELECT	

3 PREPARATION

■ Initial setting mode

◇ NMEA Input/Output ports (Continued)

• AIS Output

Set the NMEA2 Output port's capability.

This function should normally be set to "AIS."

- ① Push **[▲]** or **[▼]** to select "AIS Output."
- ② Push **[ENT]** to select either "AIS" or "AIS+GPS."
 - You can also select the option by pushing **[◀]** or **[▶]**.

AIS : The NMEA2 Output port sends only the AIS information to the connected device. (Default)

AIS+GPS : The NMEA2 Output port sends both the AIS and GPS information to the connected device. This setting is recommended for use in an area where there are few vessels. In an area crowded with AIS equipped vessels, some AIS information may be missed.

- ③ Push **[CLEAR]** to save and return to the Initial setting mode.

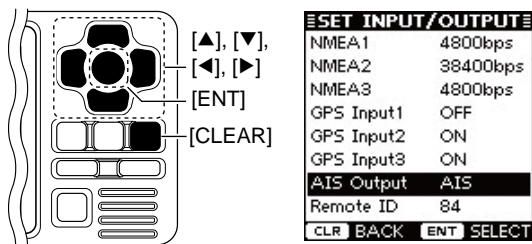

• Remote ID

Set a Remote ID number between 80 and 89.

The Remote ID is included in the sentence of the format for the Icom own NMEA.

- ① Push **[▲]** or **[▼]** to select "Remote ID."
- ② Push **[◀]** or **[▶]** to set a Remote ID number between 80 and 89.
- ③ Push **[CLEAR]** to save and return to the Initial setting mode.

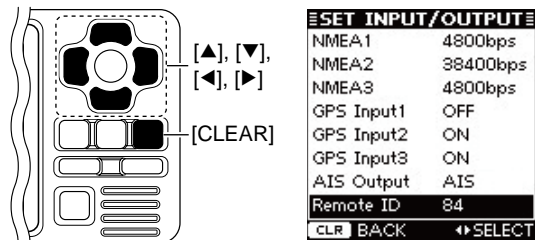

◇ Name and Call Sign settings

- ① Push **[▲]** or **[▼]** to select the “Set Name” or “Set Call Sign” that you want to program, then push **[ENT]** to enter the setting mode.

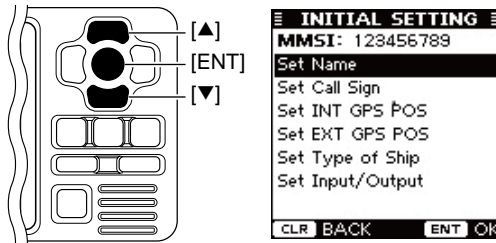

- ③ Repeat step ② to input all characters.
- ④ Push **[▲]**, **[▼]**, **[◀]** or **[▶]** to select “FINISH,” then push **[ENT]** to save and return to the Initial setting mode.

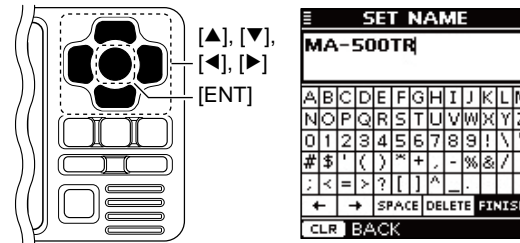

- ② Push **[▲]**, **[▼]**, **[◀]** or **[▶]** to select the desired character in the table, then push **[ENT]** to input it.
 - Select “→,” then push **[ENT]** to move the cursor forward.
 - Select “←,” then push **[ENT]** to move the cursor backward.
 - Select “SPACE,” then push **[ENT]** to input a space.
 - Select “DELETE,” then push **[ENT]** to delete a character.
 - Push **[CLEAR]** to cancel and return to the previous screen.

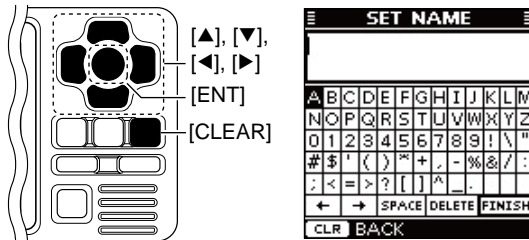

■ Turning power ON

/// **IMPORTANT: BE SURE** to connect the GPS receiver to the transponder before turning the power ON. (p. 35)

- ① Hold down **[POWER•BRILL]** for 1 second to turn ON the power.

• A long beep sounds, and the opening screen appears.

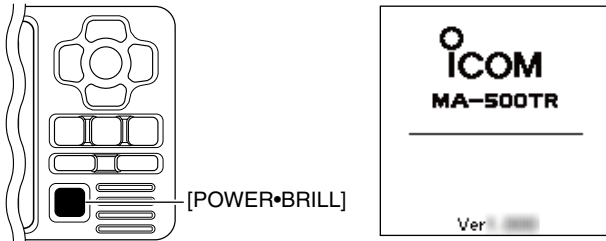

- ② The opening screen displays the results of the ROM, RAM and backup data test, “OK” or “NG” (No Good).

• If “NG” is displayed, hold down **[POWER•BRILL]** for 1 second to turn OFF the power, then ON again to reset the transponder. If there is no change, contact your dealer or service center.

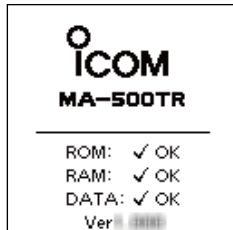

- ③ After the opening test is completed, the MMSI code appears, if the code has already been set.

• “No MMSI” appears when no MMSI code is set. (p. 7)

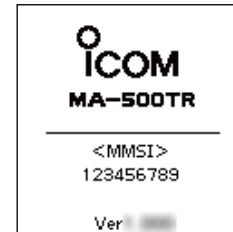

- ④ The GPS search display appears while searching for a GPS satellite.

• While searching, the GPS information screen can be displayed by pushing **[ENT]**, or you can enter the Menu mode by pushing **[MENU]**. (pp. 28, 31)

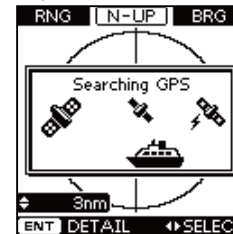

- ⑤ When the GPS receiver receives signals from a satellite, the transponder automatically displays the position data on the plotter display. (p. 15)

■ Display backlight and contrast settings

You can adjust the display backlight and contrast settings. The display backlight lights the function display and keys, and is convenient for nighttime operation.

Also, you can adjust the display contrast between objects and the background.

- ① Push [**POWER•BRILL**] to display the popup screen to adjust the display backlight and contrast level.
- ② Push [**▲**] or [**▼**] to select “Backlight” or “Contrast,” whichever one you want to adjust.
- ③ Push [**◀**] or [**▶**] to adjust the level.
 - Backlight : Between 1 and 7, or OFF
 - Contrast : Between 1 and 8
- ④ Push [**ENT**] to save the settings and turn OFF the popup screen.
 - If no key operation is performed for 5 seconds, the backlight and contrast levels are saved, and the popup screen automatically turns OFF.

Convenient!

Each push of [**POWER•BRILL**] after the popup screen is displayed, also adjusts the display backlight level.

■ Plotter display operation

When the plotter display is selected, the display range and the icons of the AIS targets appear. You can change the display range and type (North up or COG up) to suit your operating style.

- ① Push [**DISP MODE**] several times to select the plotter display.
- ② Push [**▲**] or [**▼**] to select the desired display range.
 - 0.125, 0.25, 0.5, 0.75, 1.5, 3, 6, 12, 24 nm (nautical miles) are selectable.
- ③ Push [**▶**] to sequentially select each AIS target icon closest to your vessel (or waypoint, if it is set; see page 24 for setting detail), in sequence.

Or, push [**◀**] to select each AIS target (or waypoint) icon farthest from your vessel, in sequence.

 - A target box will appear around the selected target (or waypoint) icon.
 - Shows the range and bearing information from your vessel to the selected AIS target.
 - Shows the CPA (Closest Point of Approach) and TCPA (Time to CPA) information of the selected AIS target whose CPA is less than 6 nm (nautical miles) and TCPA is less than 60 minutes to your vessel.
- ④ Push [**ENT**] to display it's detail screen. (p. 17)

NOTE: The alarm buzzer sounds when a malfunction occurs or an AIS target is closer than your CPA and TCPA settings, depending on the presetting. (pp. 29, 30, 33, 44)

- ➡ To stop the alarm buzzer, push [**CLEAR**].
 - If the popup screen is displayed, push [**CLEAR**] again to turn it OFF.

4 BASIC OPERATION

■ Plotter display operation (Continued)

◇ Setting the display type (North up/COG up)

Select the display type between “North up” and “COG up.”

- ① Push **[MENU]** to enter the Menu mode.
- ② Push **[▲]** or **[▼]** to select “North up/COG up,” then push **[ENT]**.
- ③ Push **[ENT]** to select either “North up” or “COG up.”
 - You can also select the option by pushing **[◀]** or **[▶]**.

North up : The top of the plotter display represents North.

COG up : The top of the plotter display represents the direction your course is heading.

- ④ Push **[CLEAR]** to save and return to the Menu mode.
- ⑤ Push **[CLEAR]** to exit the Menu mode.

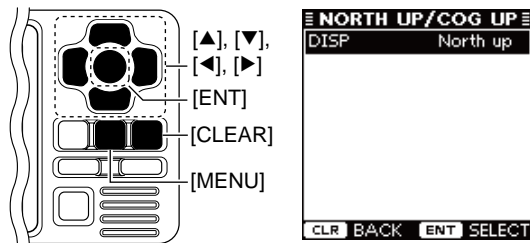

■ Target list display operation

The target list display shows all AIS targets being detected by the transponder, including their range and bearing information.

The AIS target data is sorted by the distance from your vessel, and the closest target is located on the top of the list. Their range and bearing information is automatically updated every 5 seconds, then the AIS target data is sorted.

- ① Push **[DISP MODE]** several times to select the target list display.
- ② Push **[▲]** or **[▼]** to select the desired AIS target.
- ③ Push **[ENT]** to display its detail screen. (p. 17)

NOTE: The alarm buzzer sounds when a malfunction occurs or an AIS target is closer than your CPA and TCPA settings, depending on the presetting. (pp. 29, 30, 33, 44)

➔ To stop the alarm buzzer, push **[CLEAR]**.

- If the popup screen is displayed, push **[CLEAR]** again to turn it OFF.

■ Danger list display operation

The danger list display shows any dangerous target whose CPA (Closest Point of Approach) distance is less than 6 nm (nautical miles), and TCPA (Time to CPA) time is less than 60 minutes to your vessel.

The dangerous target data is sorted by CPA or TCPA (you can choose either; see step ①).

Their CPA and TCPA information is automatically updated every 5 seconds, then the dangerous target data is sorted.

- ① Push **[DISP MODE]** several times to select the danger list display.
 - Push **[◀]** to sort the AIS target data by CPA.
 - Push **[▶]** to sort the AIS target data by TCPA.
- ② Push **[▲]** or **[▼]** to select the desired AIS target.
- ③ Push **[ENT]** to display it's detail screen. (See to the right)

NOTE: The alarm buzzer sounds when a malfunction occurs or an AIS target is closer than your CPA and TCPA settings, depending on the presetting. (pp. 29, 30, 33, 44)

- ➡ To stop the alarm buzzer, push **[CLEAR]**.
 - If the popup screen is displayed, push **[CLEAR]** again to turn it OFF.

■ About the detail screen

The detail screen shows information about the selected AIS target. The contents differ, depending on the AIS class.

In the detail screen, pushing **[CLEAR]** returns to the previous screen, which was displayed before entering the details screen.

See pages 18 to 21 for the detail screen of each AIS class.

4 BASIC OPERATION

■ About the detail screen (Continued)

◇ The detail screens of "Class A" vessels

DETAIL 1/5

CLASS A
MMSI: 431300
 ICOM
 JAPAN
CALL SIGN:
 MA500TR
IMO NO: 012345678
 CLR EXIT

- AIS Class
- MMSI Code
- Ship Name
- Country Name
- Call Sign
- IMO Number

DETAIL 2/5

CPA: 0.8nm
TCPA: 0min
LAT: 34°37.8870N
LON: 135°24.1870E
SOG: 0.0kt
COG: 199.0°
 CLR EXIT

- CPA
- TCPA
- Latitude
- Longitude
- Speed Over Ground
- Course Over Ground

DETAIL 3/5

HDG: 088°
PA: H
RANGE: 0.8nm
BEARING: 104°
ROT: 000° /min
 CLR EXIT

- Heading
- Position Accuracy (H: High, L: Low)
- Range
- Bearing
- Rate Of Turn

Detail screen 4/6

Detail screen 3/6

DETAIL 4/6

A: 86m
 B: 15m
 C: 7m
 D: 12m
LENGTH: 101m
BEAM: 19m
DRAUGHT: 5.8m
 CLR EXIT

- A: Bow to Antenna
- B: Stern to Antenna
- C: Port side to Antenna
- D: Starboard side to Antenna
- Length
- Beam
- Draught

DETAIL 5/6

TYPE OF SHIP:
 70 CARGO
 ALL SHIPS OF THIS TYPE
NAV STATUS:
 00 UNDER WAY USING ENGINE
 CLR EXIT

- Type of Ship
- Navigation Status

DETAIL 6/6

DESTINATION:
 OSAKA
DATE: NOV/17
TIME: 12:00
 CLR EXIT

- Destination
- Date
- Time

◆ The detail screens of “Class B” vessels



- AIS Class
- MMSI Code
- Ship Name
- Country Name
- Call Sign

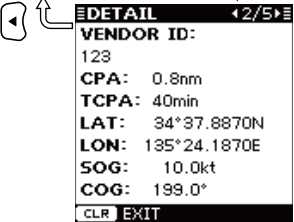

- Vendor ID
- CPA
- TCPA
- Latitude
- Longitude
- Speed Over Ground
- Course Over Ground



- Heading
- Position Accuracy (H: High, L: Low)
- Range
- Bearing

Detail screen 4/5

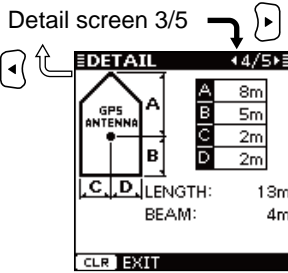

- A: Bow to Antenna
- B: Stern to Antenna
- C: Port side to Antenna
- D: Starboard side to Antenna
- Length
- Beam



- Type of Ship

4 BASIC OPERATION

■ About the detail screen (Continued)

◇ The detail screens of a “Base Station”

DETAIL 1/2

BASE STATION

MMSI: 004310505

LAT: 34°38.6100N

LON: 135°22.7500E

CLR LIST

- AIS Class
- MMSI Code
- Latitude
- Longitude

DETAIL 2/2

PA: L

RANGE: 0.6nm

BEARING: 323°

CLR LIST

- Position Accuracy (H: High, L: Low)
- Range
- Bearing

◇ The detail screens of an “SAR”

DETAIL 1/2

SAR

MMSI: 123456789

LAT: 34°38.6100N

LON: 135°22.7500E

CLR LIST

- AIS Class
- MMSI Code
- Latitude
- Longitude

DETAIL 2/2

SOG: 500kt

COG: 199.0°

PA: H

RANGE: 10.8nm

BEARING: 104°

ALT: 800m

CLR EXIT

- Speed Over Ground
- Course Over Ground
- Position Accuracy (H: High, L: Low)
- Range
- Bearing
- Altitude

◆ The detail screens of an “AtoN”



- AIS Class
- MMSI Code



- CPA
- TCPA
- Latitude
- Longitude
- Position Accuracy (H: High, L: Low)
- Range
- Bearing

Detail screen 3/4

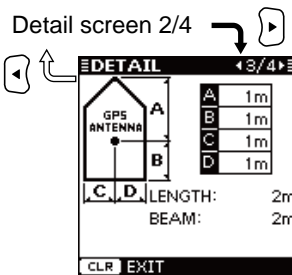

- A: Bow to Antenna
- B: Stern to Antenna
- C: Port side to Antenna
- D: Starboard side to Antenna
- Length
- Beam

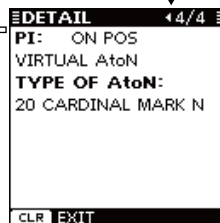

- Position Indicator (ON POS : ON Position, OFF POS : OFF Position)
- AtoN existence (REAL, VIRTUAL)
- Type of AtoN (See page 49)
- Description of AtoN

4 BASIC OPERATION

■ Individual DSC call (Possible only when a transceiver is connected)

When a transceiver* is connected to the transponder, you can transmit an Individual DSC call without needing to enter the vessel's MMSI code, by simply selecting its AIS target and the voice channel you wish to use on the transponder.

The transceiver will use the transponder's data information and make the DSC call on channel 70, then wait for the target vessel to acknowledge it. After receiving the acknowledgement 'Able to comply,' use the transceiver to communicate with the target vessel on the predetermined voice channel.

*See the leaflet that comes with the transponder for details of the transceivers which can operate with this function.

See pages 39 and 40 for connecting instructions.

/// **NOTE:** The data communication speed (baud rate) of NMEA1 must be set to 4800 bps to send an Individual DSC call using the transponder. (p. 11)

- ① Select the desired AIS target on the plotter, target list or danger list display. (pp. 15–17)
 - You can also go to the next step whenever the detail screen of the AIS target is displayed.
- ② Push **[DSC]** to display the voice channel selection screen, then push **[▲]** or **[▼]** to select the desired voice channel.
 - Voice channels are already preset into the transponder in recommended order.

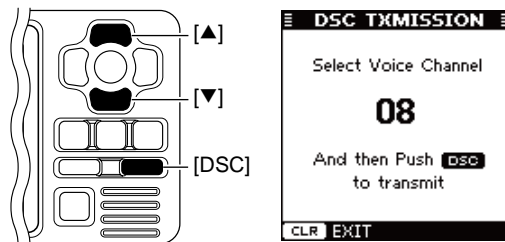

/// **NOTE:** When a base station is selected in step ①, a voice channel will be specified by the base station, therefore you cannot change the channel. The transponder will display "Voice Channel is specified by the Base station," in this case.

- ③ Push **[DSC]** to make the Individual DSC call.
 - "DSC Transmitting" appears.
 - If Channel 70 is busy, the transceiver stands by until the channel becomes clear.
 - If the transceiver cannot make the call, "DSC Transmission FAILED" appears.
- ④ After making the Individual DSC call, "DSC Transmission COMPLETED" appears.
- ⑤ Push **[CLEAR]** to return to the previous screen before you entered the voice channel selection screen in step ②.
- ⑥ After receiving the acknowledgement from the AIS target, use the transceiver to communicate. See the transceiver's manual for details.

■ Message

◇ Receiving a message

A safety-related message of up to 161 characters can be received from an AIS equipped vessel in the area.

When a message is received, a beep sounds three times, and the message icon appears on the plotter display. (The message icon does not appear on the target list or danger list display.)

The contents of the message can be checked in the receive message log, as described to the right.

The message icon stays on the plotter display as long as the unread message is stored in the RX log memory.

NOTE: The transponder automatically stores the received messages in the RX log memory. (See to the right)

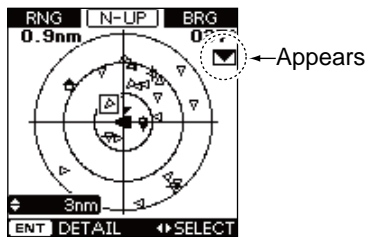

Plotter display

◇ Message logs

The transponder automatically stores the last 20 received messages in the log memory.

The oldest message is automatically deleted when a new message is received.

- ① Push **[MENU]** to enter the Menu mode.
- ② Push **[▲]** or **[▼]** to select “Message,” then push **[ENT]**.
- ③ Push **[▲]** or **[▼]** to select “RX Log,” then push **[ENT]**.
- ④ Push **[▲]** or **[▼]** to select the message that you want to read, then push **[ENT]**.
 - The contents of the selected message are displayed.
- ⑤ Push **[CLEAR]** to return to the previous screen.
- ⑥ Push **[CLEAR]** three times to exit the Menu mode.

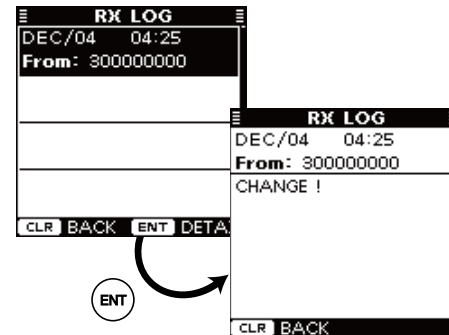

5 OTHER FUNCTIONS

Waypoint

Display a waypoint list

Up to 100 waypoints can be stored in the waypoint list.

- 1 Push **[MENU]** to enter the Menu mode.
- 2 Push **[▲]** or **[▼]** to select "Waypoint," then push **[ENT]**.
- 3 Push **[▲]** or **[▼]** to select "List," then push **[ENT]**.
- 4 Push **[▲]** or **[▼]** to select the desired waypoint.
 - Push **[◀]** to sort the waypoint data by Name.
 - Push **[▶]** to sort the waypoint data by Range.
- 5 Push **[ENT]** to display the detail screen of the selected waypoint.

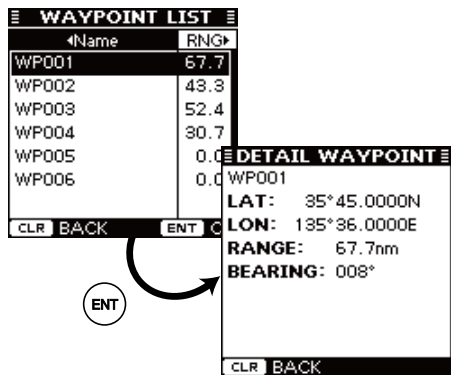

- 6 Push **[CLEAR]** to return to the previous screen.
- 7 Push **[CLEAR]** three times to exit the Menu mode.

Add a waypoint

The position information that you want to memorize can be added as a waypoint.

- 1 Push **[MENU]** to enter the Menu mode.
- 2 Push **[▲]** or **[▼]** to select "Waypoint," then push **[ENT]**.
- 3 Push **[▲]** or **[▼]** to select "Add," then push **[ENT]**.
 - Your current position information is displayed.
- 4 Push **[▲]** or **[▼]** to select "Name," then push **[ENT]**.
- 5 Push **[▲]**, **[▼]**, **[◀]** or **[▶]** to select the desired character in the table, then push **[ENT]** to input it.
 - Select "→," then push **[ENT]** to move the cursor forward.
 - Select "←," then push **[ENT]** to move the cursor backward.
 - Select "SPACE," then push **[ENT]** to input a space.
 - Select "DELETE," then push **[ENT]** to delete a character.
 - Push **[CLEAR]** to cancel and return to the previous screen.

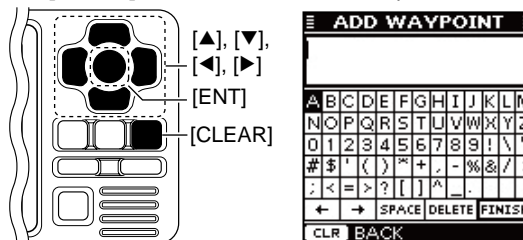

- 6 Repeat step 5 to input a waypoint name of up to 10 characters.
- 7 Push **[▲]**, **[▼]**, **[◀]** or **[▶]** to select "FINISH," then push **[ENT]** to set and return to the previous screen.

- ⑧ Push **[▲]** or **[▼]** to select “LAT:,” then push **[ENT]**.
- ⑨ Push **[▲]**, **[▼]**, **[◀]** or **[▶]** to set the desired latitude data in the table, then push **[ENT]** to input it.
- Select “→,” then push **[ENT]** to move the cursor forward.
 - Select “←,” then push **[ENT]** to move the cursor backward.
 - Select “N,” then push **[ENT]** to input N; North latitude.
 - Select “S,” then push **[ENT]** to input S; South latitude.
 - “W” and “E” cannot be input.
 - Push **[CLEAR]** to cancel and return to the previous screen.

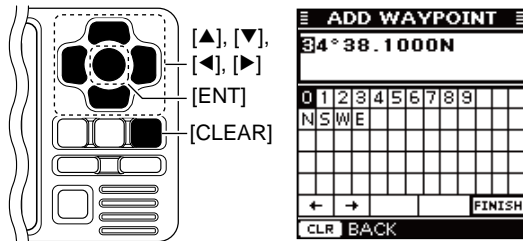

- ⑩ Push **[▲]**, **[▼]**, **[◀]** or **[▶]** to select “FINISH,” then push **[ENT]** to set and return to the previous screen.
- ⑪ Push **[▲]** or **[▼]** to select “LON:,” then push **[ENT]**.
- ⑫ Push **[▲]**, **[▼]**, **[◀]** or **[▶]** to set the desired longitude data in the table, then push **[ENT]** to input it.
- Select “→,” then push **[ENT]** to move the cursor forward.
 - Select “←,” then push **[ENT]** to move the cursor backward.
 - Select “W,” then push **[ENT]** to input W; West longitude.
 - Select “E,” then push **[ENT]** to input E; East longitude.
 - “N” and “S” cannot be input.
 - Push **[CLEAR]** to cancel and return to the previous screen.

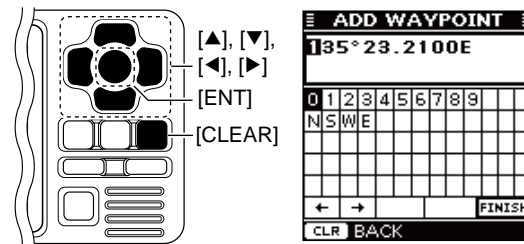

- ⑬ Push **[▲]**, **[▼]**, **[◀]** or **[▶]** to select “FINISH,” then push **[ENT]** to set and return to the previous screen.
- ⑭ Push **[▲]** or **[▼]** to select “SAVE,” then push **[ENT]** to save the waypoint data and return to the “WAYPOINT” screen.
- Push **[CLEAR]** to cancel and return to the previous screen.

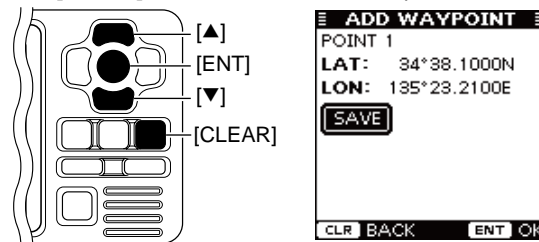

- ⑮ Push **[CLEAR]** twice to exit the Menu mode.

Convenient!

Each time you hold down of **[MOB]** also adds a waypoint. See page 26 to edit the waypoint data.

5 OTHER FUNCTIONS

■ Waypoint (Continued)

◇ Edit a waypoint

A waypoint's name, latitude and longitude data can be edited.

- ① Push **[MENU]** to enter the Menu mode.
- ② Push **[▲]** or **[▼]** to select "Waypoint," then push **[ENT]**.
- ③ Push **[▲]** or **[▼]** to select "Edit," then push **[ENT]**.
 - The "EDIT WAYPOINT" list is displayed.
- ④ Push **[▲]** or **[▼]** to select the desired waypoint.
 - Push **[◀]** to sort the waypoint data by Name.
 - Push **[▶]** to sort the waypoint data by Range.
- ⑤ Push **[ENT]** to enter the edit item selection screen.

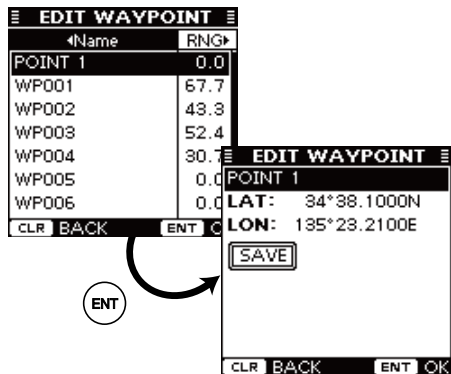

- ⑥ Push **[▲]** or **[▼]** to select the top item (waypoint name), then push **[ENT]**.

- ⑦ Enter a waypoint name, latitude data and longitude data, as described in steps ⑤ to ⑬ of "◇ Add a Waypoint" on pages 24 and 25.
- ⑧ Push **[▲]** or **[▼]** to select "SAVE," then push **[ENT]** to save the edited data and return to the "EDIT WAYPOINT" list screen.
 - Push **[CLEAR]** to cancel and return to the previous screen.

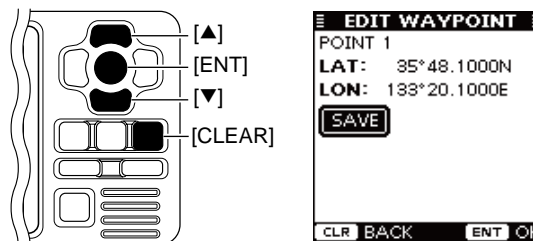

- ⑨ Push **[CLEAR]** three times to exit the Menu mode.

◇ Delete a waypoint

A waypoint can be deleted from the waypoint list.

- ① Push **[MENU]** to enter the Menu mode.
- ② Push **[▲]** or **[▼]** to select “Waypoint,” then push **[ENT]**.
- ③ Push **[▲]** or **[▼]** to select “Delete,” then push **[ENT]**.
 - The “DELETE WAYPOINT” list is displayed.
- ④ Push **[▲]** or **[▼]** to select the desired waypoint.
 - Push **[◀]** to sort the waypoint data by Name.
 - Push **[▶]** to sort the waypoint data by Range.
- ⑤ Push **[ENT]** to display the detail screen of the selected waypoint.
- ⑥ Push **[ENT]** to display the confirmation screen.
- ⑦ Push **[◀]** or **[▶]** to select “OK,” then push **[ENT]** to delete the selected waypoint data and return to the “DELETE WAYPOINT” list screen.
 - Select “Cancel” to cancel deleting.

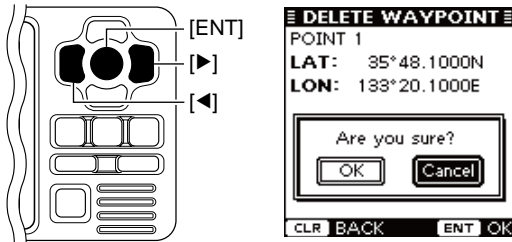

- ⑧ Push **[CLEAR]** three times to exit the Menu mode.

■ Lost target

A vessel is regarded as a “Lost target” after a specified period of time has passed since the vessel last transmitted data, as described below.

The “Lost target” icon disappears from the plotter display 6 minutes and 40 seconds after the vessel was regarded as a “Lost target.” (default) Ask your dealer for details.

The criteria to become a Lost target (Default):

Vessel type		Except Class B	Class B
1	Except Class B: Vessel is at anchor, moored and moving less than 3 knots Class B : Vessel is moving less than 2 knots	18 min.	18 min.
2	Vessel is at anchor, moored and moving more than 3 knots	1 min.	N/A
3	Vessel is moving between 0 and 14 knots (Except Class B), or between 2 and 14 knots (Class B)	1 min.	3 min.
4	Vessel is moving between 0 and 14 knots while changing course	1 min.	N/A
5	Vessel is moving between 14 and 23 knots	36 sec.	90 sec.
6	Vessel is moving between 14 and 23 knots while changing course	36 sec.	N/A
7	Vessel is moving more than 23 knots	12 sec.	30 sec.
8	Vessel is moving more than 23 knots while changing course	12 sec.	N/A

6

MENU MODE OPERATION

General

- ① Push **[MENU]** to enter the Menu mode.
- ② Push **[▲]** or **[▼]** to select the desired item, then push **[ENT]**.
- ③ Select the desired option or check the screen contents.
The procedures are described on pages 29 to 34.
• Some items are not described in this section. See the list to the right for the specified pages.
- ④ Repeat steps ② and ③ to select or check other items.
- ⑤ Push **[CLEAR]** to exit the Menu mode.

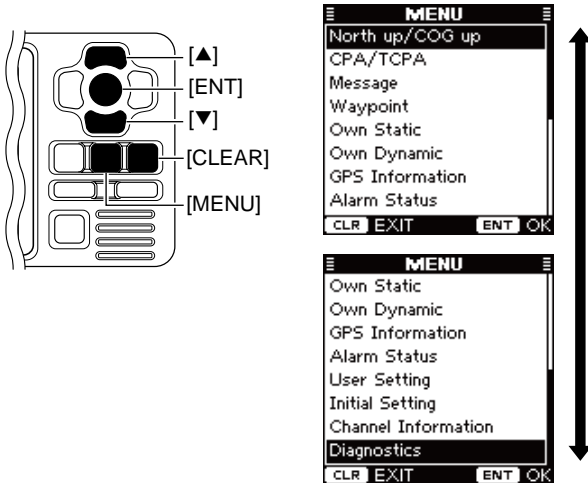

Menu mode items

The Menu mode contains the following items.

Item	Ref.	Item	Ref.
North up/COG up*	p. 16	User Setting	
CPA/TCPA		• RCV MSG BUZZ	p. 33
• Alarm	p. 29	• Internal GPS	p. 33
• Slow Warn	p. 29	- SBAS Function	p. 34
• CPA, TCPA	p. 30	- SBAS Search	p. 34
Message		- SBAS Satellite	p. 34
• RX Log*	p. 23	Initial Setting	
Waypoint		• Set MMSI*	pp. 7, 9
• List*	p. 24	• Set Name*	pp. 9, 13
• Add*	p. 24	• Set Call Sign*	pp. 9, 13
• Edit*	p. 26	• Set INT GPS POS*	p. 10
• Delete*	p. 27	• Set EXT GPS POS*	p. 10
Own Static	p. 30	• Set Type of Ship*	p. 10
Own Dynamic	p. 31	• Set Input/Output*	p. 11
GPS Information	p. 31	Channel Information	p. 34
Alarm Status	p. 32	Diagnostics	
User Setting		• Monitor Test*	p. 44
• Key Beep	p. 32	• Transponder Test*	p. 45
• Alarm Buzzer	p. 33	• Version Information*	p. 45

*These items are not described in this section. See the specified page.

◇ CPA/TCPA

• Alarm

You can turn the collision alarm function ON or OFF.

- ① Push [▲] or [▼] to select “Alarm.”
- ② Push [ENT] to toggle this function ON or OFF.
 - You can also turn ON the function by pushing [▶], or OFF by pushing [◀].

ON : “COLLISION ALARM” appears on the display, and the alarm buzzer sounds* repeatedly when an AIS target is closer than your CPA and TCPA settings, as explained to page 30. (default)

*The alarm buzzer sounds only when the alarm buzzer function is turned ON. (p. 33)

OFF : The collision alarm function is OFF.

- ③ Push [CLEAR] to save and return to the Menu mode.

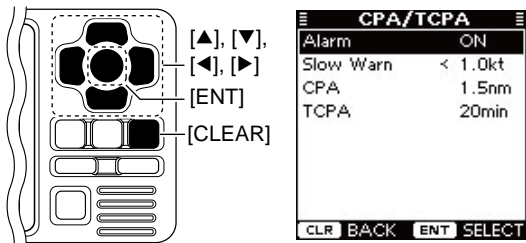

• Slow Warn

The GPS receiver calculated COG data of a vessel that is at anchor or drifting is unreliable, and therefore the CPA and TCPA data may not be calculated correctly. If a vessel is anchored in your alarm zone, the unreliable data can cause the collision alarm to sound many times, even if there is no real danger. To prevent this, when the anchored vessel's SOG is less than this set value, the Slow Warn function assumes that vessel's COG is fixed towards your vessel and an alarm will sound.

- ① Push [▲] or [▼] to select “Slow Warn.”
- ② Push [◀] or [▶] to input the value between 0.1 and 4.9 kt (in 0.1 kt steps), or select OFF. (default: 1.0 kt)
- ③ Push [CLEAR] to save and return to the Menu mode.

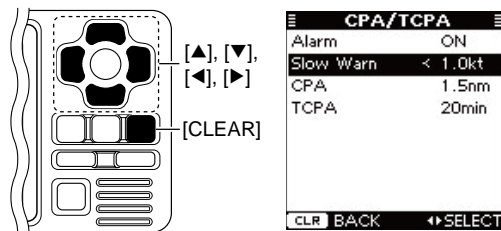

NOTE: If other vessels at anchor or drifting come into your alarm zone, the Slow Warn alarm will sound again. Only if the previous vessel disappears from the Dangerous List (pp. 6, 17), and then re-enters the list, can a new Slow Warn or regular alarm sound, depending on the vessels SOG, or CPA and TCPA. The Slow Warn function operates in the same way if your vessel is at anchor and other vessels enter your alarm zone area.

6 MENU MODE OPERATION

■ Menu mode items

◇ CPA/TCPA (Continued)

• CPA, TCPA

Enter CPA (Closest Point of Approach) and TCPA (Time to CPA) values.

These settings help you find a dangerous target to avoid a collision. The icon blinks on the plotter display and/or the alarm buzzer sounds, when the AIS target is closer than your CPA and TCPA settings.

- ① Push **[▲]** or **[▼]** to select either “CPA” or “TCPA.”
- ② Push **[◀]** or **[▶]** to input the value into that item.
 - CPA : Between 0.1 and 6.0 nm (in 0.1 nm steps)
(default: 1.5 nm)
 - TCPA : Between 1 and 60 minutes (in 1 minute steps)
(default: 20 min)
- ③ Repeat steps ① and ② to input the value into the other item.
- ④ Push **[CLEAR]** to save and return to the Menu mode.

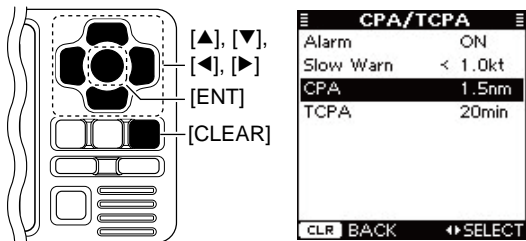

◇ Own Static

This screen shows your static vessel information such as MMSI code, Vessel Name, Call Sign, Internal/External GPS antenna position and Type of Ship.

- ① When the Own Static screen is displayed, push **[▶]** to select the next page, or push **[◀]** to select the previous page.
- ② Push **[CLEAR]** to return to the Menu mode.

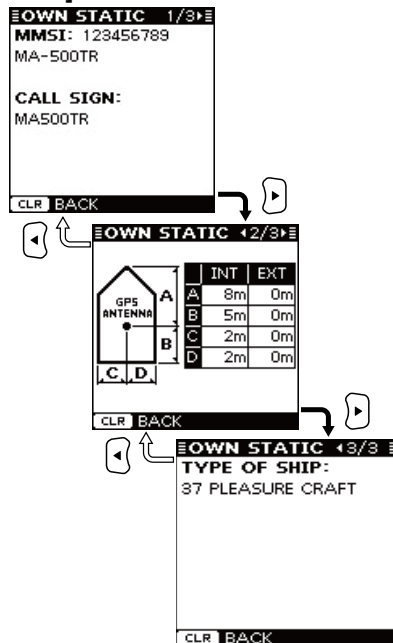

◇ Own Dynamic

This screen shows your dynamic vessel information such as Latitude and Longitude data, SOG, COG, GPS receiver type, UTC date and time, PA, RAIM (Receiver Autonomous Integrity Monitoring) function availability and Latitude and Longitude error data.

- An internal GPS has no RAIM function. When the internal GPS is used, "RAIM," "LAT ERROR" and "LON ERROR" are not displayed.
- An external GPS requires a RAIM function. When the external GPS is used, "RAIM," "LAT ERROR" and "LON ERROR" are displayed.

- ① When the Own Dynamic screen is displayed, push [▶] to select the next page, or push [◀] to select the previous page.
- ② Push [CLEAR] to return to the Menu mode.

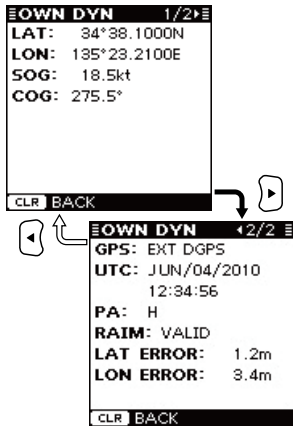

When a non-differential GPS receiver is connected, PA is normally 'L.' However, if the values of "LAT ERROR" and "LON ERROR" are less than 5.0 meters (16.4 feet), PA changes to 'H.'

When a differential GPS receiver is connected, PA is normally 'H.' However, if the values of "LAT ERROR" and "LON ERROR" are more than 15.0 meters (49.2 feet), PA changes to 'L.'

◇ GPS Information

The GPS Information screen shows the viewable GPS satellite's information, when the internal or external* GPS receiver is connected.

*Only when the transponder receives the sentence format "GSA" or "GSV" from the external GPS receiver.

- ① When the GPS Information screen is displayed, push [▶] to select the next page, or push [◀] to select the previous page.

- The icons of the satellites being used, blink.

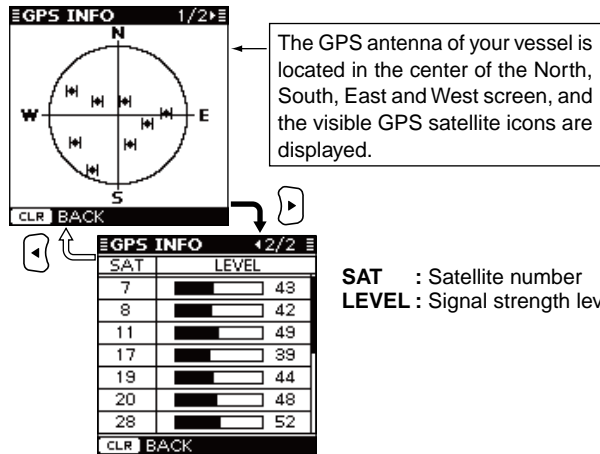

SAT : Satellite number
LEVEL : Signal strength level

- ② Push [CLEAR] to return to the Menu mode.

6 MENU MODE OPERATION

■ Menu mode items (Continued)

◇ Alarm Status

The Alarm Status screen shows the type, date and time of the last 25 malfunctions that were detected.

Even if the alarm buzzer function is turned OFF, the alarm status is displayed here. (p. 33)

- ① When the Alarm Status screen is displayed, push [▲] or [▼] to scroll the screen.
- ② Push [CLEAR] to return to the Menu mode.

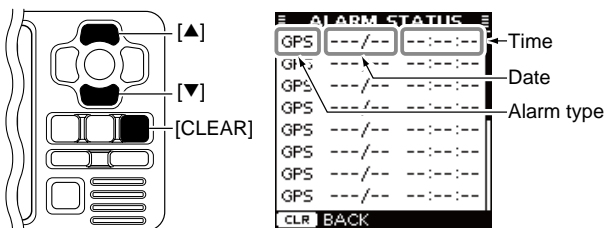

• Description of the Alarm type

Alarm type	Description
GPS	Appears when “GPS Malfunction” is detected.
RX	Appears when “RX Malfunction” is detected.
CH A	Appears when “CH A Noise Level Malfunction” is detected.
CH B	Appears when “CH B Noise Level Malfunction” is detected.
TX	Appears when “TX Malfunction” is detected.
ANT	Appears when “Antenna Open or Short Malfunction” or “Antenna High VSWR Malfunction” is detected.

◇ User Setting

The User setting mode allows you to set the seldom-changed settings, and you can “customize” the transponder operation to suit your preferences and operating style.

- ① Push [MENU] to enter the Menu mode.
- ② Push [▲] or [▼] to select “User Setting,” then push [ENT].
- ③ Push [▲] or [▼] to select the desired item, then push [ENT].
- ④ Select the desired option, shown in the Menu below.
The procedures are described to the right and continued on the next page.
- ⑤ Repeat steps ③ and ④ to select other items.
- ⑥ Push [CLEAR] to save and return to the Menu mode.
- ⑦ Push [CLEAR] to exit the Menu mode.

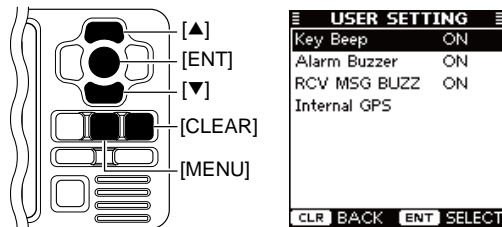

<SETTING ITEMS>

• Key Beep

You can select the silent operation, or you can have confirmation beeps sound when you push a key.

- ➡ Push [ENT] to toggle this function ON or OFF.*

ON : A beep sounds when pushing a key. (default)
OFF : The key beep is OFF. (Silent operation)

• **Alarm Buzzer**

Turn the alarm buzzer function ON or OFF.

➔ Push **[ENT]** to toggle this function ON or OFF.*

ON : The alarm buzzer sounds when a malfunction occurs or an AIS target is closer than your CPA and TCPA settings*. (default)

*The alarm buzzer sounds only when the collision alarm function is turned ON. (p. 29)

OFF : The alarm buzzer is OFF.

• **Received Message Buzzer (RCV MSG BUZZ)**

Turn the received message buzzer function ON or OFF.

➔ Push **[ENT]** to toggle this function ON or OFF.*

ON : The buzzer sounds three times when a message is received. (default)

OFF : The received message buzzer is OFF.

*You can also turn ON the function by pushing **[▶]**, or OFF by pushing **[◀]**.

• **Internal GPS**

The Internal GPS setting mode allows you to set the internal GPS settings.

- ① Push **[MENU]** to enter the Menu mode.
- ② Push **[▲]** or **[▼]** to select "User Setting," then push **[ENT]**.
- ③ Push **[▲]** or **[▼]** to select "Internal GPS," then push **[ENT]**.
- ④ Push **[▲]** or **[▼]** to select the desired item, then push **[ENT]**.
- ⑤ Select the desired option, shown in the Menu below.

The procedures are described to the right and continued on the next page.

- ⑥ Repeat steps ④ and ⑤ to select other items.
- ⑦ Push **[CLEAR]** to save and return to the User Setting mode.
- ⑧ Push **[CLEAR]** twice to exit the Menu mode.

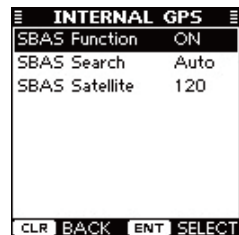
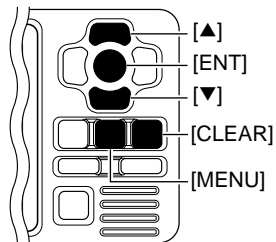

6 MENU MODE OPERATION

■ Menu mode items

◇ User Setting (Continued)

<SETTING ITEMS>

- SBAS (Satellite Based Augmentation System) Function

The SBAS transmits signals to correct errors and improve accuracy and reliability in data received from regular GPS satellites. When this function is ON, the transponder uses the corrected data.

- Push **[ENT]** to toggle this function ON or OFF.
 - You can also turn ON the function by pushing **[▶]**, or OFF by pushing **[◀]**.

ON : The SBAS function is ON. (default)

OFF : The SBAS function is OFF.

- SBAS Search

Set the SBAS search function to “Manual” or “Auto.”

This function should normally be set to “Auto.”

- Push **[ENT]** to select either “Manual” or “Auto.”
 - You can also select the option by pushing **[◀]** or **[▶]**.

Manual : You have to manually select the SBAS satellite.
This option can be useful when your vessel is in an area where 2 satellite zones overlap.

Auto : The transponder automatically searches for the SBAS satellite that is determined according to the position of your vessel. (default)

- SBAS Satellite

When “Manual” option is selected in the SBAS Search item, you should manually select the SBAS Satellite which covers the zone your vessel is monitoring.

- Push **[◀]** or **[▶]** to select an SBAS Satellite number between 120 and 138. (default: 120)

◇ Channel information

The channel information screen shows the channels 2087 and 2088 information in which safety-related messages are transmitted to, and received from, the AIS targets.

The channel to be used is automatically set according to the message received from an AIS Base Station.

- Push **[CLEAR]** to return to the Menu mode.

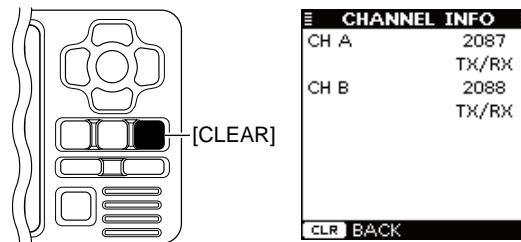

■ Connections

/// **About the installation distance from the compass:**
KEEP the transponder at least 1 m (3.3 ft) away from the vessel's magnetic navigation compass.

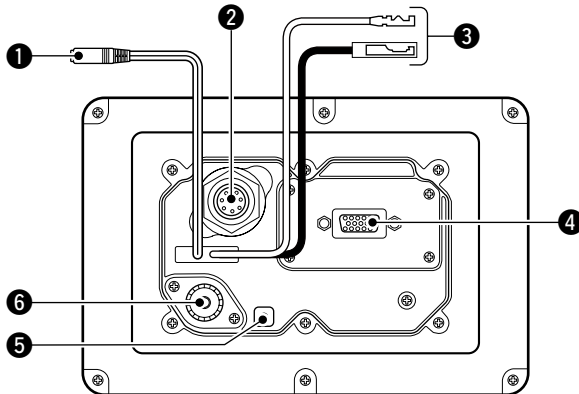

1 CLONING CABLE CONNECTOR

Connects the cloning cable from this connector to a PC. Ask your dealer for details.

2 INTERNAL GPS RECEIVER CONNECTOR

Connects to the MXG-5000 to receive position data and transmit it with other AIS information.

/// **NOTE:** Important notes and how to install the MXG-5000 are described on the instruction sheet that comes with it. Be sure to read them before installing and operating the MXG-5000.

3 DC POWER CONNECTOR

Connects the supplied DC power cable between this connector and a 12 V power source.

4 HIGH-DENSITY D-SUB 15 PIN (NMEA IN/OUT)

Connects an Icom MarineCommander™ system, navigation equipment, external GPS receiver, etc. using the supplied OPC-2014 NMEA CONNECTOR CABLE.

See page 37 for the pin assignment.

/// Requirements of the external GPS:

- The datum of the external GPS receiver must be "WGS-84."
- GBS sentence can be input using the RAIM function.
- The external GPS antenna must be installed within 26 m (85.3 ft) of the internal GPS antenna.

/// **CAUTION:** After connecting the DC power cable and NMEA connector cable leads, cover the cable and leads with a rubber vulcanizing tape, to prevent water seeping into the transponder.

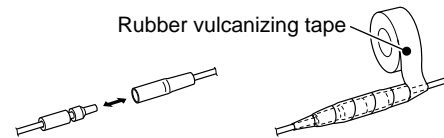

7 INSTALLATION AND CONNECTIONS

■ Connections (Continued)

5 GROUND TERMINAL

Connects to a vessel ground to prevent electrical shocks and interference from other equipment occurring. Use a self-tapping screw (3 × 8 mm).

6 ANTENNA CONNECTOR

Connects to a marine VHF antenna with a PL-259 connector for AIS signal transmission and reception. (p. 38)

/// **CAUTION:** Transmitting without an antenna may damage the transponder.

◇ High-density D-sub 15 pin assignment

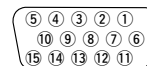

Rear panel view

/// **NOTE:** The OPC-2014 NMEA CONNECTOR CABLE has 15 leads, numbered 1 to 15.

PIN No.	PIN No.	SPECIFICATIONS	SENTENCE FORMAT	DESCRIPTION
1	GND	—	—	Connects to ground.
2	NMEA1 OUT (-)	• Output level : 5 V/40 mA max. (RS-422 balanced type)	DSC, RMC, GGA, VTG, GSA, GSV, GBS, DTM, DSE, GNS, GLL	Connects to the NMEA input/output connector of a transceiver to transmit an Individual DSC call, or to connect to a GPS receiver. (p. 39) The data communication speed (baud rate) can be selected between 4800 bps (IEC61162-1) and 38400 bps (IEC61162-2) for each Input/Output port. (Default: 4800 bps)
3	NMEA1 OUT (+)			
4	NMEA1 IN (-)	• Input level : Less than 2 mA (at 2 V applied)	RMC, GGA, VTG, GSA, GSV, GBS [†] , DTM, GNS, GLL	
5	NMEA1 IN (+)			
6	ALERT1	• Load rating : DC 24 V/500 mA max.	—	A short occurs between pins 6 and 11 when the alarm buzzer sounds if a malfunction occurs, or an AIS target is closer than your CPA and TCPA settings.
11	ALERT2			
7	NMEA2 OUT (-)	Same as pins 2 and 3	VDM, VDO, ALR, ACA, ACS, TXT, RMC*, GGA*, GNS*, GLL*, VTG*, GSA*, GSV*, GBS*, DTM*	Connects to the Icom MarineCommander™ system or to a GPS receiver. The data communication speed (baud rate) is fixed to 38400 bps (IEC61162-2) for each Input/Output port.
8	NMEA2 OUT (+)			
9	NMEA2 IN (-)	Same as pins 4 and 5	RMC, GGA, VTG, GSA, GSV, GBS [†] , DTM, GNS, GLL	
10	NMEA2 IN (+)			
12	NMEA3 OUT (-)	Same as pins 2 and 3	RMC, GGA, VTG, GSA, GSV, GBS, DTM, GNS, GLL	Connects to a piece of navigation equipment or to a GPS receiver. The data communication speed (baud rate) can be selected between 4800 bps (IEC61162-1) and 38400 bps (IEC61162-2) for each Input/Output port. (Default: 4800 bps)
13	NMEA3 OUT (+)			
14	NMEA3 IN (-)	Same as pins 4 and 5	RMC, GGA, VTG, GSA, GSV, GBS [†] , DTM, GNS, GLL	
15	NMEA3 IN (+)			

[†]When a received GPS signal includes no GBS sentence, the transponder will not receive the signal from the external GPS receiver.

*Sent only when the “AIS+GPS” option is set in “AIS Output.” (p. 12)

■ Fuse replacement

One fuse is installed in the DC power cable. If the fuse blows, track down the source of the problem, have it repaired, and replace the damaged fuse with a new one of the proper rating.

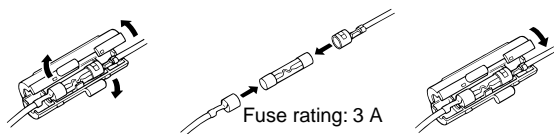

■ About the VHF antenna

A key element in the performance of any communication system is the antenna. The VHF AIS/radio antennas should be mounted in a location that has a clear, unobstructed view in all directions and as far away from interference as possible, for the best reception and transmission. When selecting a mounting location, follow the guidelines below.

- Mount the VHF AIS/radio antennas at least 3 m (9.85 ft.) away from each other.
- Mount the VHF AIS/radio antennas as high as possible.
- Be sure the location is out of the radar beam.
- Be sure the location will not be shaded by a random antenna or mast.

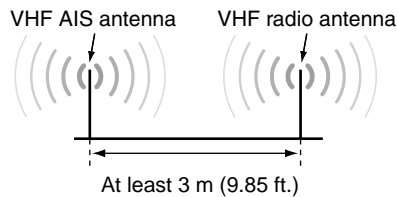

• **Antenna connector**

The antenna uses a PL-259 connector.

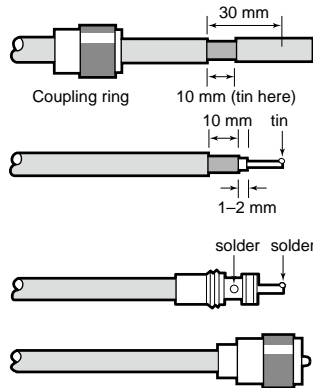

① Slide the coupling ring down. Strip the cable jacket and tin the shield.

② Strip the cable as shown at left. Tin the center conductor.

③ Slide the connector body on and solder it.

④ Screw the coupling ring onto the connector body.

30 mm (1³/₁₆ in) 10 mm (1³/₃₂ in) 1–2 mm (1³²–³/₃₂ in)

NOTE: There are many publications covering antennas and their proper installation. Check with your local dealer for more information and recommendations.

■ Transceiver connection

Connect the transponder and a transceiver using the OPC-2014 NMEA CONNECTOR CABLE. After connecting, an individual DSC call can be made to the AIS target using the transponder without entering the target's MMSI code. (p. 22) See the leaflet that comes with the transponder for details of the transceivers which can operate with this function.

In this section, the connecting instructions of the IC-M504*1, IC-M505*1, IC-M603*2 and IC-M604*2 are described as an example. See the instruction manual of each for transceiver's connecting instructions.

*1 Requires the first two digits of the serial number to be "21" or higher.

*2 Requires the first two digits of the serial number to be "31" or higher.

☞ Continued on the next page.

7 INSTALLATION AND CONNECTIONS

■ Transceiver connection (Continued)

◇ IC-M504/M505

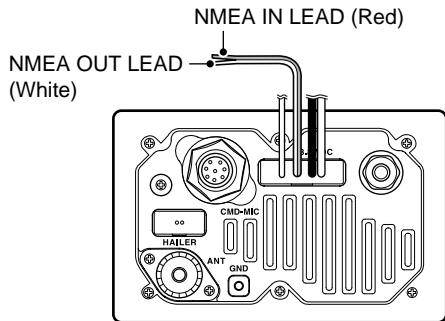

Transceiver's rear panel

• NMEA IN LEAD (Red)

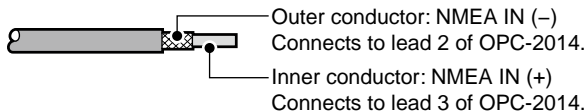

• NMEA OUT LEAD (White)

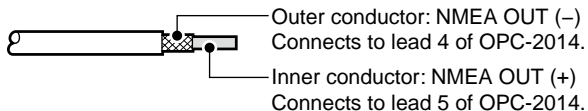

◇ IC-M603/M604

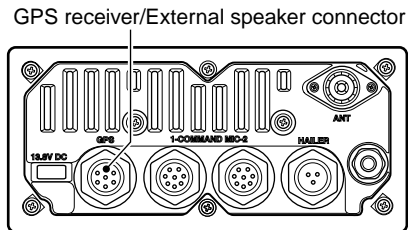

Transceiver's rear panel

• GPS receiver/External speaker connector

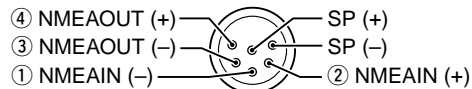

- ① NMEA IN (-)
Connects to lead 2 of OPC-2014.
- ② NMEA IN (+)
Connects to lead 3 of OPC-2014.
- ③ NMEA OUT (-)
Connects to lead 4 of OPC-2014.
- ④ NMEA OUT (+)
Connects to lead 5 of OPC-2014.

■ Mounting the transponder

◇ Using the mounting bracket

The universal mounting bracket supplied with your transponder allows overhead or dashboard mounting.

- ① Mount the bracket securely with the 4 supplied screws (5 × 20 mm) to a surface which is more than 10 mm (13/32 in) thick and can support more than 3 kg (6 lb 61 oz).
- ② Attach the transponder to the bracket so that the face of the transponder is at 90° to your line of sight when operating it.

/// About the installation distance from the compass:

KEEP the transponder at least 1 m (3.3 ft) away from the vessel's magnetic navigation compass.

NOTE: Check the installation angle; the function display may not be easy to read at some angles.

• OVERHEAD MOUNTING

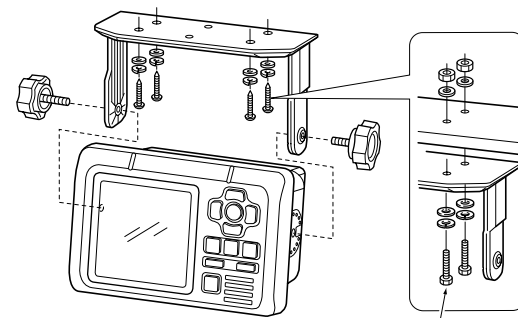

• MOUNTING ON THE BOARD

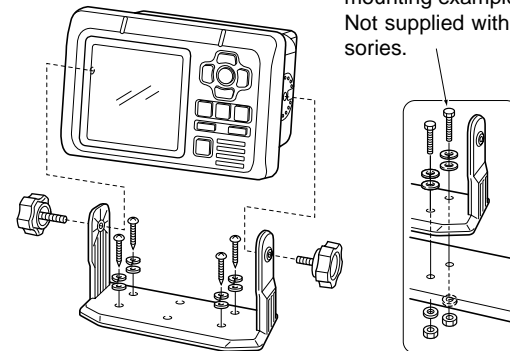

7 INSTALLATION AND CONNECTIONS

■ MB-75 installation

An optional MB-75 FLUSH MOUNT KIT is available for mounting the transponder to a flat surface, such as an instrument panel.

/// **KEEP** the transponder at least 1 m (3.3 ft) away from your vessel's magnetic navigation compass.

- ① Using the template on the page 47, carefully cut a hole into the instrument panel (or wherever you plan to mount the transponder).
- ② Slide the transponder through the hole.

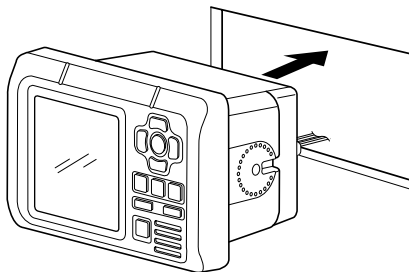

- ③ Attach the 2 supplied bolts (M5 × 8 mm) on either side of the transponder.
- ④ Attach the clamps on either side of the transponder.
 - Make sure that the clamps align parallel to the transponder's body.

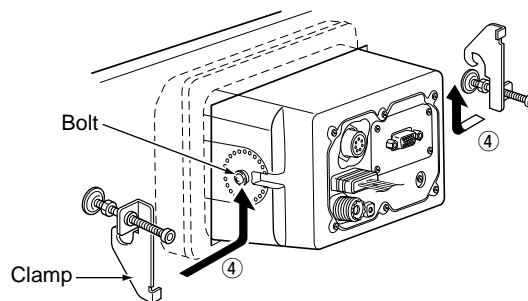

- ⑤ Tighten the end bolts on the clamps (rotate clockwise) so that the clamps press firmly against the inside of the instrument control panel.
- ⑥ Tighten the locking nuts (rotate counterclockwise) so that the transponder is securely mounted in position.

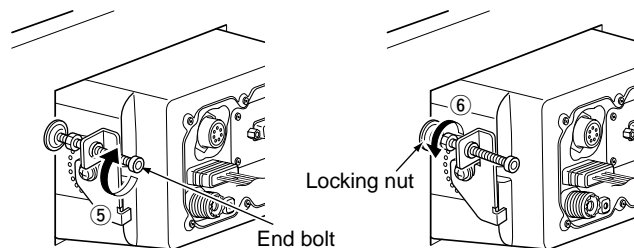

- ⑦ Connect the antenna, power cable, GPS receiver and OPC-2014, then return the instrument control panel to its original place.

■ Troubleshooting

The following chart is designed to help you correct problems which are not equipment malfunctions.

If you are unable to locate the cause of a problem or solve it through the use of this chart, contact your nearest Icom Dealer or Service Center.

PROBLEM	POSSIBLE CAUSE	SOLUTION	REF.
The transponder does not turn ON.	<ul style="list-style-type: none">• Bad connection at the power source.	<ul style="list-style-type: none">• Check the connection to the transponder.	p. 35
Cannot transmit.	<ul style="list-style-type: none">• 1 minute has not passed from turning ON the transponder power.	<ul style="list-style-type: none">• Wait for 1 minute from turning ON the transponder power.	—
The plotter display does not appear.	<ul style="list-style-type: none">• The results of the opening test is “NG” (No Good).• The transponder is still searching for GPS satellites.	<ul style="list-style-type: none">• Hold down [POWER•BRILL] for 1 second to turn the power OFF, then push to turn it ON again to reset the transponder.• Wait until the transponder detects a GPS satellite.	pp. 7, 14 —
The GPS search display does not disappear.	<ul style="list-style-type: none">• The GPS receiver is not connected to the transponder.	<ul style="list-style-type: none">• Connect the GPS receiver to the transponder.	p. 35
An error beep sounds after pushing [DSC].	<ul style="list-style-type: none">• An AIS target is not selected.• A transceiver is not connected to the transponder.	<ul style="list-style-type: none">• Select the desired AIS target or display the detail screen of the AIS target.• Connect the transceiver to the transponder.	pp. 15, 16, 17 p. 39
The collision alarm does not sound.	<ul style="list-style-type: none">• The collision alarm function is OFF.• The alarm buzzer function is OFF.	<ul style="list-style-type: none">• Turn ON the collision alarm function.• Turn ON the alarm buzzer function.	p. 29 p. 33

■ Error message

Error message is displayed when a malfunction occurs that has an error message programmed for it.

Message contents	Description
GPS MALFUNCTION NO GPS DATA	Appears when no GPS data is received.
RX MALFUNCTION NO RCV	Appears when the transponder receive circuit has failed.
RX MALFUNCTION CH A NOISE LEVEL	Appears when the transponder receives excessively strong noise signals from another piece of navigation equipment on Channel A.
RX MALFUNCTION CH B NOISE LEVEL	Appears when the transponder receives excessively strong noise signals from another piece of navigation equipment on Channel B.
TX MALFUNCTION NO TX POWER	Appears when no RF power is output, or the transmit circuit has failed.
TX MALFUNCTION CONTINUOUS TX	Appears when the protective circuit cuts off the AIS signal after 1 second of continuous transmission.
ANT MALFUNCTION OPEN OR SHORT	Appears when the antenna is open or shorted.
ANT MALFUNCTION HIGH VSWR	Appears when the high VSWR* is detected (the antenna is mismatched). *Voltage Standing Wave Ratio

■ Diagnostics

There are two types of diagnostic tests performed — Monitor test, Transponder test and Version information.

• Monitor Test

You can check whether all LCD segments turn ON and OFF properly.

- ① Push **[MENU]** to enter the Menu mode.
- ② Push **[▲]** or **[▼]** to select “Diagnostics,” then push **[ENT]**.
- ③ Push **[▲]** or **[▼]** to select “Monitor Test,” then push **[ENT]**.
- ④ Push **[▲]** or **[▼]** to select “All ON 2 Sec” or “All OFF 2 Sec,” then push **[ENT]**.
 - All ON 2 Sec : All LCD segments turn ON for 2 seconds.
 - All OFF 2 Sec : All LCD segments turn OFF for 2 seconds.
- ⑤ Push **[CLEAR]** to return to the “DIAGNOSTICS” screen.
- ⑥ Push **[CLEAR]** twice to exit the Menu mode.

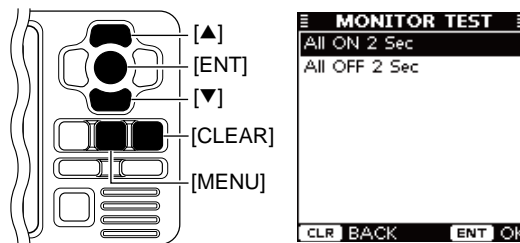

• **Transponder Test**

You can check whether the transponder units work properly.

- ① Push **[MENU]** to enter the Menu mode.
- ② Push **[▲]** or **[▼]** to select “Diagnostics,” then push **[ENT]**.
- ③ Push **[▲]** or **[▼]** to select “Transponder Test,” then push **[ENT]**.
- ④ The screen shows the results of the ROM, RAM, RX/TX unit, antenna and GPS receiver tests; “OK” or “NG” (No Good).
- ⑤ Push **[CLEAR]** to return to the “DIAGNOSTICS” screen.
- ⑥ Push **[CLEAR]** twice to exit the Menu mode.

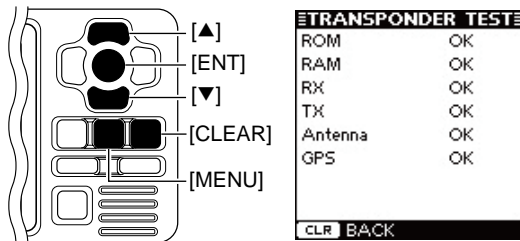

• **Version Information**

You can check the version information of SW (Software), FI (Function Image) and the Internal GPS receiver.

- ① Push **[MENU]** to enter the Menu mode.
- ② Push **[▲]** or **[▼]** to select “Diagnostics,” then push **[ENT]**.
- ③ Push **[▲]** or **[▼]** to select “Version Information,” then push **[ENT]**.
- ④ The screen shows the version information of each item.
- ⑤ Push **[CLEAR]** to return to the “DIAGNOSTICS” screen.
- ⑥ Push **[CLEAR]** twice to exit the Menu mode.

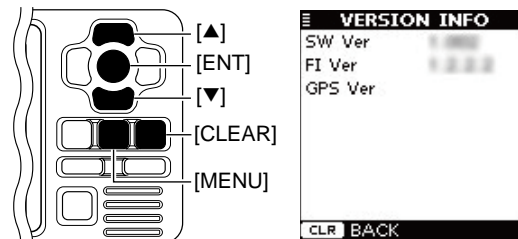

■ Specifications

◇ General

- Frequency coverage : 161.975, 162.025 MHz (default)
156.025–162.025 MHz
- Type of emission : 16K0GXW (GMSK)
- Current drain (at 12 V nominal) : TX: 1.5 A, RX: 0.7 A
- Power supply requirement : 9.6 to 15.6 V DC
(negative ground)
- Operating temperature range : –20°C to +60°C; –4°F to +140°F
- Antenna impedance : 50 Ω nominal
- Intermediate frequency
 - AIS1 : 1st: 21.700 MHz, 2nd: 450 kHz
 - AIS2 : 1st: 30.875 MHz, 2nd: 450 kHz
- Dimensions : 165(W) × 110(H) × 123.3(D) mm,
(Projections not included) 6 1/2(W) × 4 11/32(H) × 4 27/32(D) in
- Weight : Approximately 1.0 kg; 2 lb 20 oz
- I/O connector : High-density D-sub 15 pin

◇ Transmitter

- Output power : 2 W
- Modulation system : GMSK
- Conducted Spurious emissions : Less than –36 dBm

◇ Receiver

- Sensitivity (20% Packet Error Rate) : –110 dBm
- Intermodulation rejection ratio : More than 65 dB
- Spurious response rejection ratio : More than 74 dB (AIS)
More than 70 dB (DSC)
- Adjacent channel selectivity : More than 70 dB
- Conducted spurious emission : Less than –57 dBm (AIS)

This equipment meets IEC 62287-1 specifications.

◇ Dimensions

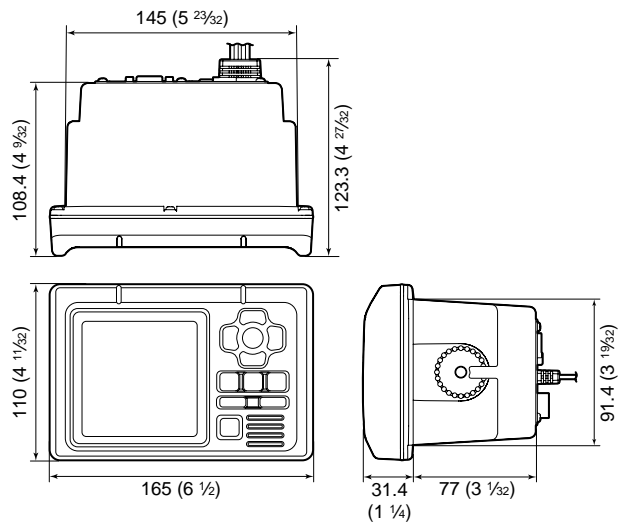

Unit: mm (inch)

All stated specifications are subject to change without notice or obligation.

■ Option

- **MB-75 FLUSH MOUNT KIT**
Used to mount the transponder to a panel.

TEMPLATE 10

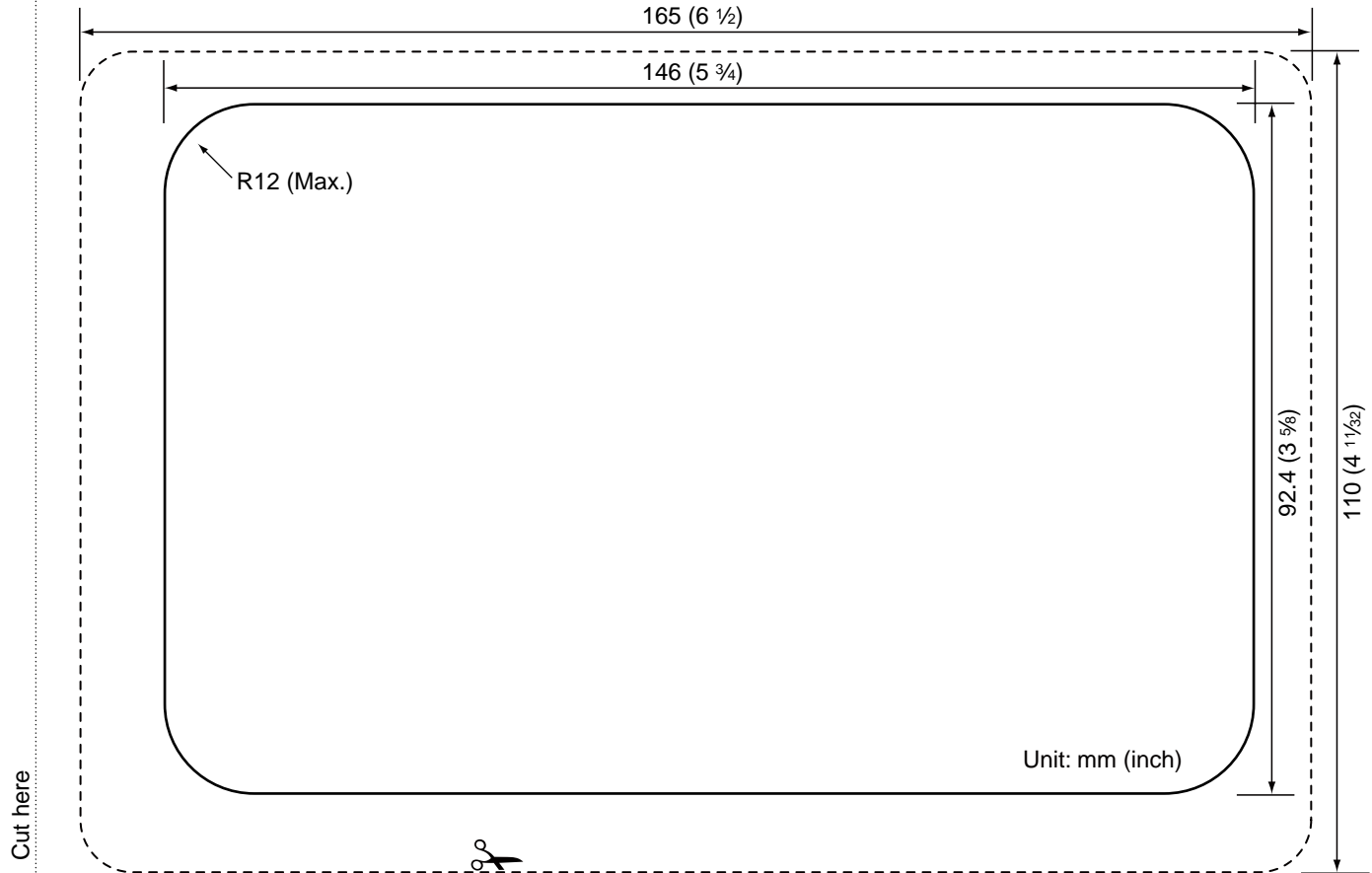

9
10

AtoN CODE AND DESCRIPTION

11

The following table shows all the AtoN codes which appear on the detail screens of an "AtoN." (p. 21)

Code	Description
0	DEFAULT, TYPE OF ATON NOT SPECIFIED
1	REFERENCE POINT
2	RACON
3	OFF SHORE STRUCTURE
4	SPARE
5	LIGHT, WITHOUT SECTORS
6	LIGHT, WITH SECTORS
7	LEADING LIGHT FRONT
8	LEADING LIGHT REAR
9	BEACON, CARDINAL N
10	BEACON, CARDINAL E
11	BEACON, CARDINAL S
12	BEACON, CARDINAL W
13	BEACON, PORT HAND
14	BEACON, STARBOARD HAND
15	BEACON, PREFERRED CHANNEL PORT HAND

Code	Description
16	BEACON, PREFERRED CHANNEL STARBOARD HAND
17	BEACON, ISOLATED DANGER
18	BEACON, SAFE WATER
19	BEACON, SPECIAL MARK
20	CARDINAL MARK N
21	CARDINAL MARK E
22	CARDINAL MARK S
23	CARDINAL MARK W
24	PORT HAND MARK
25	STARBOARD HAND MARK
26	PREFERRED CHANNEL PORT HAND
27	PREFERRED CHANNEL STARBOARD HAND
28	ISOLATED DANGER
29	SAFE WATER
30	SPECIAL MARK
31	LIGHT VESSEL / LANBY

Count on us!

< Intended Country of Use >

AT BE CY CZ DK EE
FI FR DE GR HU IE
IT LV LT LU MT NL
PL PT SK SI ES SE
GB IS LI NO CH BG
RO TR HR

A-6860D-1EX
Printed in Japan
© 2010 Icom Inc.

Printed on recycled paper with soy ink.

Icom Inc.

1-1-32 Kamiminami, Hirano-ku, Osaka 547-0003, Japan

PRECAUTIONS

NEVER immerse the GPS receiver in water. The GPS receiver meets IPX6 requirements for high-pressure water jet resistance. However, once it has been dropped, high-pressure water jet resistance cannot be guaranteed because of possible damage to its case or the waterproof seal.

DO NOT use or place the GPS receiver in areas with temperatures below -20°C (-4°F) or above $+60^{\circ}\text{C}$ ($+140^{\circ}\text{F}$).

DO NOT use chemical agents such as benzene or alcohol when cleaning, as they can damage the GPS receiver's surfaces.

The GPS receiver is for Icom MarineCommander™ only! —Other manufacturer's equipment may have different pin assignments and can damage the equipment or GPS receiver if attached.

SPECIFICATIONS

- Power supply voltage : 4.75 to 5.25 V DC (supplied from the MarineCommander™)
- Operating temp. range : -20°C to $+60^{\circ}\text{C}$; -4°F to $+140^{\circ}\text{F}$
- Relative humidity : Less than 95% (at $+35^{\circ}\text{C}$; $+95^{\circ}\text{F}$)
- Dimensions : 140(d) \times 157.2(H) mm; 5 $\frac{1}{2}$ (d) \times 6 $\frac{3}{16}$ (H) in.
- Weight (approx.) : 710 g; 1.57 oz
- Cable length (approx.) : 10 m; 32 ft. 9 $\frac{3}{4}$ in.
- Receiving frequency : 1575.42 MHz
- Receiving channels : 12
- Receiving codes : L1, C/A-code, SPS
- Satellite differential type : WAAS, EGNOS, MSAS
- TTFF (Time to First Fix)
 - Cold start (typical) : 40 sec.
 - Hot start (typical) : 4 sec.

All stated specifications are subject to change without notice or obligation.

Thank you for purchasing the **MXG-5000** GPS RECEIVER. Please read these instructions thoroughly before installing and operating the GPS receiver.

SUPPLIED ACCESSORIES

Item	Qty.
① Hose clamp (HAS-40)	2
② Extension pipe (2273 pipe)	1
③ GPS receiver	1

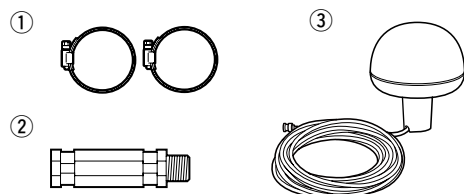

FCC INFORMATION

For CLASS A UNINTENTIONAL RADIATORS

This equipment has been tested and found to comply with the limits for a Class A digital device, pursuant to part 15 of the FCC Rules. These limits are designed to provide reasonable protection against harmful interference when the equipment is operated in a commercial environment. This equipment generates, uses, and can radiate radio frequency energy and, if not installed and used in accordance with the instruction manual, may cause harmful interference to radio communications. Operation of this equipment in a residential area is likely to cause harmful interference in which case the user will be required to correct the interference at his own expense.

This device complies with Part 15 of the FCC Rules. Operation is subject to the following two conditions: (1) this device may not cause harmful interference, and (2) this device must accept any interference received, including interference that may cause undesired operation.

CAUTION: Changes or modifications not expressly approved by the party responsible for compliance could void the user's authority to operate the equipment.

CE The GPS receiver complies with the essential requirements of the 2004/108/EC directive for Electromagnetic Compatibility. This compliance is based upon the harmonised CENELEC generic standard EN60945 Ed4.0: 2002, EN60950-1 Ed2.0: 2005, EN61162-1 Ed3.0: 2007.

MOUNTING

◇ Mounting locations

The GPS receiver should be mounted in a location that has a clear, unobstructed view in all directions and as far away from interference as possible, for the best reception. When selecting a mounting location, follow the guidelines below.

- The location should be at least 1 m (3.28 ft.) away from a VHF/UHF antenna, and 4 m (13.12 ft.) away from a MF/HF antenna.
- The location should be at least 5 m (16.40 ft.) away from an Inmarsat antenna.

- Be sure the location is out of the radar beam.
- Be sure the location will not be shaded by a random antenna or mast.
- Mount the GPS receiver as high as possible.

We recommend that you place the GPS receiver in the desired location temporarily, and see if it receives any interference.

◇ Installation

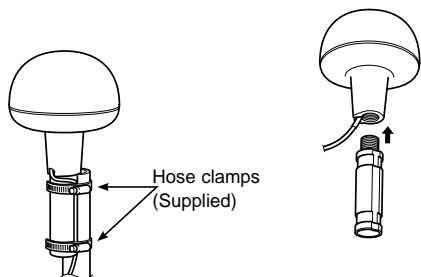

The supplied extension pipe is to be inserted firmly into the base of the GPS receiver and screwed in a clockwise direction.

Using the supplied hose clamps, the GPS receiver can be stabilized to the mounting mast.

CONNECTION

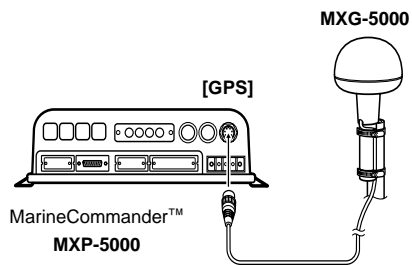

Prior to any operation, it is important to make sure that all connections are made accurately. All connections should be made only by certified persons.

The output connector is to be connected from the GPS receiver to the GPS data input terminal of the MarineCommander™.

ATTENTION

About calculating position

The GPS receiver acquires signals from GPS satellites. It calculates its position by the orbit information of the GPS satellites and needs to measure the distance between itself and three or more GPS satellites to obtain a reliable position. The GPS receiver acquires all available satellites when it is first powered up, powered off for a long time, or powered up again at a place a long way from when it was last powered off. Normally, it takes approximately 1 minute for determining a position.

In places where the GPS signals cannot reach the GPS receiver, such as around tall buildings, it may show position errors (misplacement) or no position reading at all.

As the satellites are continuously moving, measurement of the position or time by the GPS receiver may take a while, and/or no position reading can be made in some instances. Even if the GPS receiver acquires signals from three or more GPS satellites, it may take a longer time to determine a position depending on the satellite locations.

About Almanac and Ephemeris Data

To reduce the time for calculating position, the GPS receiver stores the Almanac Data (the orbit course/orbital parameters of the satellites) in its internal memory. When the GPS receiver is left with the power OFF for a long time, it needs to acquire the Almanac Data again. In this case, the GPS receiver starts as a "cold" start.

The GPS receiver stores Ephemeris Data of the satellite's orbital course, and refers to this data when it is turned OFF for a short time.

This is called a "hot" start, and uses the Ephemeris Data that is valid to within less than 4 hours.

Location precision

The GPS receiver automatically calculates its position when it acquires signals from three or more GPS satellites.

The GPS satellite's measurement error is about ± 10 meters, however this can vary up to several hundred meters depending on the surrounding environment.

When the GPS receiver is powered up again at a place a long way from when it was last powered off, the first calculation of its position may be incorrect in some cases.

The GPS information and its accuracy varies, depending on the GPS system being acquired, place and time.

About NMEA sentence

At times, the current position data cannot be received due to the GPS signal being blocked by something, or it takes a long time to acquire the position data from a cold start. In those cases, the GPS receiver sends the last memorized NMEA sentence, but the sentence may also include invalid data.

Icom, Icom Inc. and the Icom logo are registered trademarks of Icom Incorporated (Japan) in Japan, the United States, United Kingdom, Germany, France, Spain, Russia and/or other countries.

MarineCommander is a trademark of Icom Incorporated.

Icom Inc.

1-1-32 Kamiminami, Hirano-ku, Osaka 547-0003, Japan.

Count on us!

A-6747H-1EX-① Printed in Japan
© 2009–2010 Icom Inc.