



## INSTRUCTION MANUAL

# COMMUNICATIONS RECEIVER IC-R6

This device complies with Part 15 of the FCC Rules. Operation is subject to the following two conditions: (1) this device may not cause harmful interference, and (2) this device must accept any interference received, including interference that may cause undesired operation.

**WARNING:** MODIFICATION OF THIS DEVICE TO RECEIVE CELLULAR RADIOTELEPHONE SERVICE SIGNALS IS PROHIBITED UNDER FCC RULES AND FEDERAL LAW.

**Icom Inc.**



---

## FOREWORD

---

Thank you for purchasing this Icom product. The IC-R6 COMMUNICATIONS RECEIVER is designed and built with Icom's superior technology and craftsmanship. With proper care, this product should provide you with years of trouble-free operation.

We want to take a moment of your time to thank you for making your IC-R6 your radio of choice, and hope you agree with Icom's philosophy of "technology first." Many hours of research and development went into the design of your IC-R6.

### ◇ **FEATURES**

- *Covers 0.100–1309.995 MHz\* wide frequency range*

\*Some frequency bands are inhibited, depending on the version

- *External power supply operation*
- *1350 memory channels\* with 22 banks available*  
\*Including 200 auto write and 50 scan edge channels
- *Built-in bar-antenna*
- *New DMS (Dynamic Memory Scan) System*

---

## IMPORTANT

---

**READ ALL INSTRUCTIONS** carefully and completely before using the receiver.

**SAVE THIS INSTRUCTION MANUAL—** This instruction manual contains important operating instructions for the IC-R6.

---

## EXPLICIT DEFINITIONS

---

| WORD              | DEFINITION   |
|-------------------|--|
| ⚠ <b>WARNING!</b> | Personal injury, fire hazard or electric shock may occur.                        |
| <b>CAUTION</b>    | Equipment damage may occur.  |
| <b>NOTE</b>       | Recommended for optimum use. No risk of personal injury, fire or electric shock. |

---

## PRECAUTIONS

---

⚠ **WARNING! NEVER** operate the receiver with a earphone, headphones or other audio accessories at high volume levels. Hearing experts advise against continuous high volume operation. If you experience a ringing in your ears, reduce the volume level or discontinue use.

⚠ **WARNING! NEVER** operate the receiver while driving a vehicle. Safe driving requires your full attention—anything less may result in an accident.

⚠ **WARNING! NEVER** connect the receiver to an AC outlet. This may pose a fire hazard or result in an electric shock.

⚠ **WARNING! NEVER** throw a battery cell into a fire since as internal battery gas can cause explosion.

⚠ **WARNING! NEVER** disassemble the battery cell. If the battery cell's internal material (electrolyte liquid) gets into your eyes, wash your eyes with water and obtain treatment from an eye doctor immediately.

**NEVER** connect the receiver to a power source of more than 6 V DC directly. This will damage the receiver.

**NEVER** connect the receiver to a power source using reverse polarity. This will damage the receiver.

**NEVER** expose the receiver to rain, snow or any liquids. The receiver may be damaged.

**NEVER** operate or touch the receiver with wet hands. This may result in an electric shock or damage the receiver.

**NEVER** solder the battery cell. This may damage the battery.

**DO NOT** use or place the receiver in direct sunlight or in areas with temperatures below  $-10^{\circ}\text{C}$  ( $+14^{\circ}\text{F}$ ) or above  $+60^{\circ}\text{C}$  ( $+140^{\circ}\text{F}$ ).

**DO NOT** use harsh solvents such as benzine or alcohol to clean the transceiver, because they can damage the transceiver's surfaces.

Even when the receiver power is OFF, a slight current still flows in the circuits. Remove batteries from the receiver when not using it for a long time. Otherwise, the installed batteries will become exhausted, and will need to be recharged.

---

## FCC INFORMATION

---

### • FOR CLASS B UNINTENTIONAL RADIATORS:

This equipment has been tested and found to comply with the limits for a Class B digital device, pursuant to part 15 of the FCC Rules. These limits are designed to provide reasonable protection against harmful interference in a residential installation. This equipment generates, uses and can radiate radio frequency energy and, if not installed and used in accordance with the instructions, may cause harmful interference to radio communications. However, there is no guarantee that interference will not occur in a particular installation. If this equipment does cause harmful interference to radio or television reception, which can be determined by turning the equipment off and on, the user is encouraged to try to correct the interference by one or more of the following measures:

- Reorient or relocate the receiving antenna.
- Increase the separation between the equipment and receiver.
- Connect the equipment into an outlet on a circuit different from that to which the receiver is connected.
- Consult the dealer or an experienced radio/TV technician for help.

**CAUTION:** Changes or modifications to this device, not expressly approved by Icom Inc., could void your authority to operate this device under FCC regulations.

---

## OPERATING THEORY

---

Electromagnetic radiation, which has frequencies of 20,000 Hz (20 kHz\*) and above, is called radio frequency (RF) energy because, it is useful in radio transmissions. The IC-R6 receives RF energy from 0.150 MHz\* to 1309.995 MHz and converts it into audio frequency (AF) energy which in turn actuates a loudspeaker to create sound waves. AF energy is in the range of 20 to 20,000 Hz.

\*kHz is an abbreviation of kilohertz or 1000 hertz, MHz is abbreviation of megahertz or 1,000,000 hertz, where hertz is a unit of frequency.

---

## OPERATING NOTES

---

The IC-R6 may receive its own oscillated frequency, resulting in no reception or only noise reception, on some frequencies.

The IC-R6 may receive interference from extremely strong signals on different frequencies or when using an external high-gain antenna.

Icom, Icom Inc. and the Icom logo are registered trademarks of Icom Incorporated (Japan) in Japan, the United States, the United Kingdom, Germany, France, Spain, Russia and/or other countries.

# TABLE OF CONTENTS

|  |              |   |              |
|--|--------------|---|--------------|
| FOREWORD .....                               | i            | 4 BASIC OPERATION .....                           | 13–17        |
| IMPORTANT .....                              | i            | ■ Receiving .....                                 | 13           |
| EXPLICIT DEFINITIONS .....                   | i            | ■ Setting audio volume .....                      | 13           |
| PRECAUTIONS .....                            | ii           | ■ Squelch level setting .....                     | 14           |
| FCC INFORMATION .....                        | iii          | ■ Receive mode selection .....                    | 14           |
| OPERATING THEORY .....                       | iii          | ■ Monitor function .....                          | 15           |
| OPERATING NOTES .....                        | iii          | ■ Attenuator function .....                       | 15           |
| TABLE OF CONTENTS .....                      | iv–v         | ■ Duplex operation .....                          | 16           |
| SUPPLIED ACCESSORIES .....                   | v            | ■ Dial select step .....                          | 17           |
| <b>QUICK REFERENCE GUIDE .....</b>           | <b>I–VII</b> | <b>5 MEMORY CHANNELS .....</b>                    | <b>18–27</b> |
| ■ Preparation .....                          | I            | ■ General description.....                        | 18           |
| ■ Your first scanning experience .....       | III          | ■ Selecting a memory channel.....                 | 18           |
| ■ Memory programming .....                   | IV           | ■ Memory channel programming.....                 | 19           |
| ■ Programmed scan operation.....             | V            | ■ Memory bank setting .....                       | 20           |
| <b>1 PANEL DESCRIPTION .....</b>             | <b>1–4</b>   | ■ Memory bank selection .....                     | 21           |
| ■ Front, top and side panels .....           | 1            | ■ Programming memory/bank name .....              | 22           |
| ■ Function display .....                     | 3            | ■ Selecting display type.....                     | 23           |
| <b>2 BATTERY CHARGING .....</b>              | <b>5–8</b>   | ■ Copying memory contents.....                    | 24           |
| ■ Battery installation .....                 | 5            | ■ Memory clearing .....                           | 25           |
| ■ Caution .....                              | 5            | ■ Transferring memory contents .....              | 26           |
| ■ Battery charging .....                     | 7            | ■ Erasing/transferring bank contents .....        | 27           |
| <b>3 FREQUENCY AND CHANNEL SETTING .....</b> | <b>9–18</b>  | <b>6 SCAN OPERATION .....</b>                     | <b>28–35</b> |
| ■ VFO and memory channels .....              | 9            | ■ Scan types .....                                | 28           |
| ■ Operating band selection .....             | 9            | ■ Full/band/programmed link/programmed scan ..... | 29           |
| ■ Setting a frequency.....                   | 11           | ■ Scan edges programming .....                    | 30           |
| ■ Setting a tuning step .....                | 11           | ■ Memory/all bank/bank link/bank scan .....       | 31           |
| ■ Selecting a memory channel.....            | 12           | ■ Auto memory write scan .....                    | 32           |
| ■ Lock function .....                        | 12           | ■ Skip channel/frequency setting.....             | 34           |
|  |              | ■ Scan resume setting .....                       | 35           |



# TABLE OF CONTENTS

|  |              |
|--|--------------|
| <b>7 PRIORITY WATCH</b> .....                    | <b>36–38</b> |
| ■ Priority watch types.....                      | 36           |
| ■ Priority watch operation .....                 | 37           |
| <b>8 TONE SQUELCH AND POCKET BEEP</b> .....      | <b>39–41</b> |
| ■ Tone/DTCS squelch operation .....              | 39           |
| ■ Tone squelch frequency/DTCS code setting ..... | 40           |
| ■ DTCS polarity setting .....                    | 41           |
| ■ Tone scan .....                                | 42           |
| <b>9 Set mode</b> .....                          | <b>43–54</b> |
| ■ General .....                                  | 43           |
| ■ Set mode items .....                           | 44           |
| <b>10 OTHER FUNCTIONS</b> .....                  | <b>55–59</b> |
| ■ [DIAL] function assignment .....               | 55           |
| ■ Weather channel operation .....                | 55           |
| ■ Data cloning .....                             | 57           |
| ■ Auto power-off function .....                  | 58           |
| ■ Partial reset .....                            | 59           |
| ■ All reset .....                                | 59           |
| <b>11 FREQUENCY TABLE</b> .....                  | <b>60–67</b> |
| ■ TV channels .....                              | 60           |
| ■ VHF marine channels .....                      | 63           |
| ■ Weather channels .....                         | 63           |
| ■ Other communications in the USA .....          | 64           |
| ■ Other communications— other countries .....    | 66           |
| <b>12 MAINTENANCE</b> .....                      | <b>68–69</b> |
| ■ Troubleshooting .....                          | 68           |
| ■ CP-18A/E fuse replacement .....                | 69           |

|                                |              |
|--------------------------------|--------------|
| <b>13 SPECIFICATIONS</b> ..... | <b>70</b>    |
| <b>14 OPTIONS</b> .....        | <b>71</b>    |
| <b>15 POCKET GUIDE</b> .....   | <b>72–73</b> |
| <b>16 CE</b> .....             | <b>73–74</b> |

# SUPPLIED ACCESSORIES

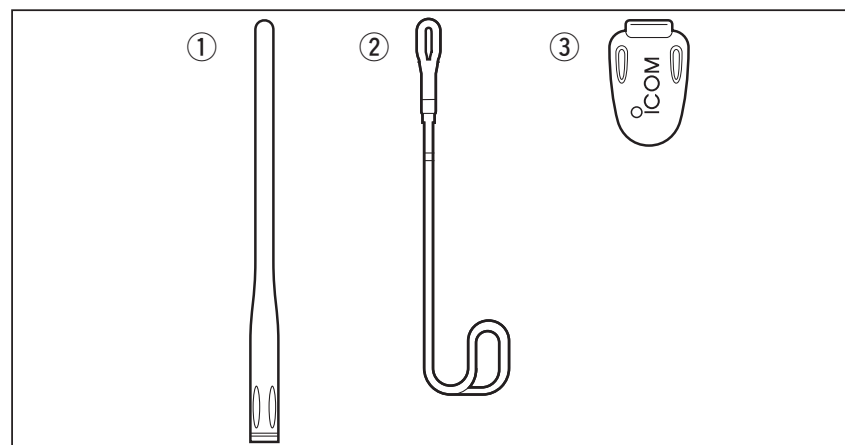

|                    |   |
|--------------------|---|
| ① Antenna .....    | 1 |
| ② Hand strap ..... | 1 |
| ③ Belt clip .....  | 1 |

# QUICK REFERENCE GUIDE

## ■ Preparation

### ◇ Battery installation

- ① Remove the battery cover from the receiver.
- ② Install 2 R6(AA) size Ni-MH or alkaline cell batteries.
  - Be sure to observe the correct polarity.
  - Charge the Ni-MH batteries before use. (See p.III for charging instructions.)

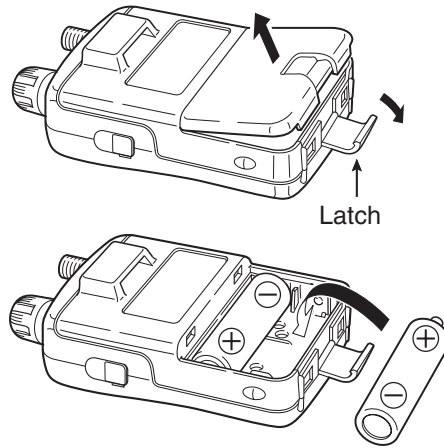

Keep the battery terminals clean. It's a good idea to clean the battery terminals once a week.

### ◇ Belt clip

Conveniently attaches to your belt.

Slide the belt clip into the plastic loop on the back of the receiver.

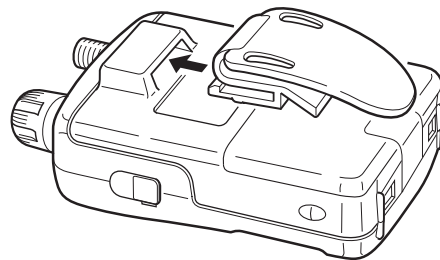

### ◇ Antenna

Insert the antenna connector into the antenna base and tighten the antenna screw.

- **NEVER** carry the receiver by holding only the antenna.
- When the jack is not in use, **keep** the jack cover attached to protect the connectors from dust and moisture.

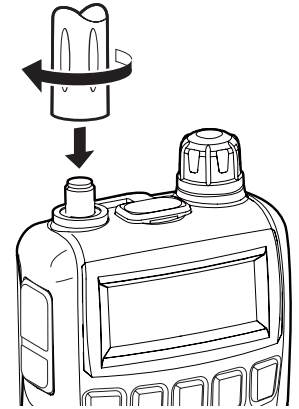

### ✓ For your information

Third-party antennas may increase receiver performance. An optional AD-92SMA ANTENNA CONNECTOR ADAPTER is available to connect an antenna with a BNC connector.

### ◇ Handstrap

To facilitate carrying the receiver, slide the hand strap through the loop on the top of the belt clip.

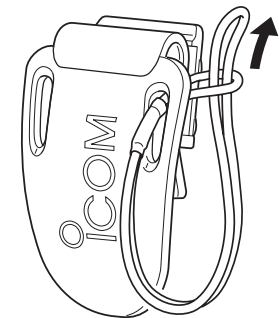

## QUICK REFERENCE GUIDE

### ◇ Charging the battery

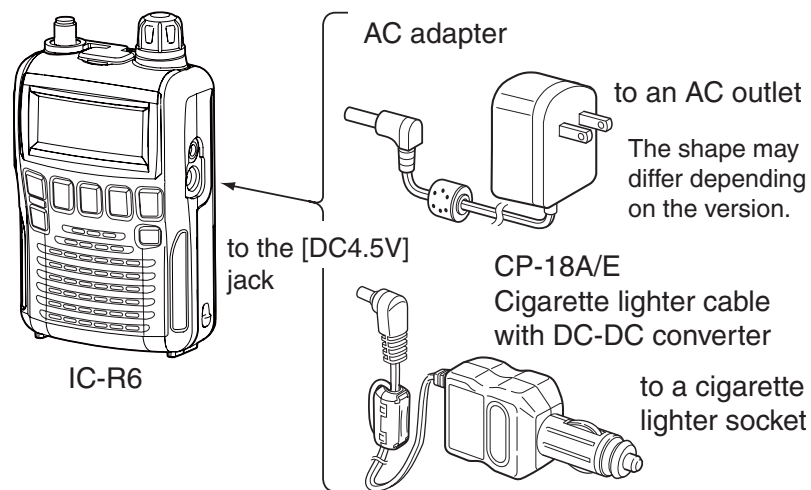

- ① Install the Ni-MH batteries.
- ② Plug the optional AC adapter into an AC outlet.
- ③ Insert the optional adapter plug into the [DC4.5V] of the receiver.
  - The battery confirmation is displayed.

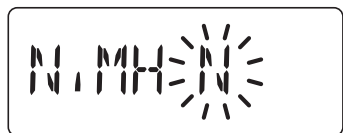

**⚠ WARNING!:**  
**NEVER** attempt to charge the alkaline batteries.

- ⑤ Rotate [DIAL] to select "Y," then push [BAND].

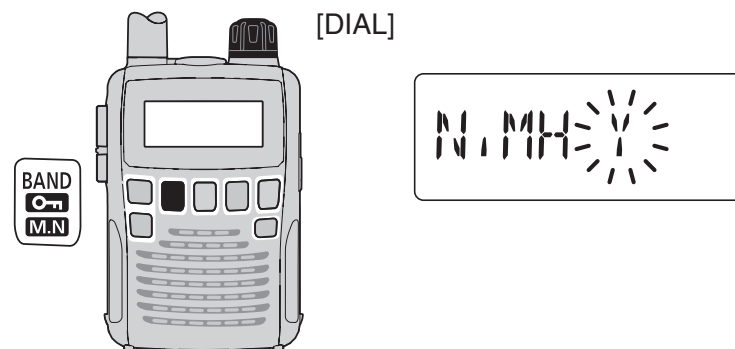

- The charging confirmation is displayed.



- ⑦ Rotate [DIAL] to select "Y," then push [BAND] to start the battery charging.

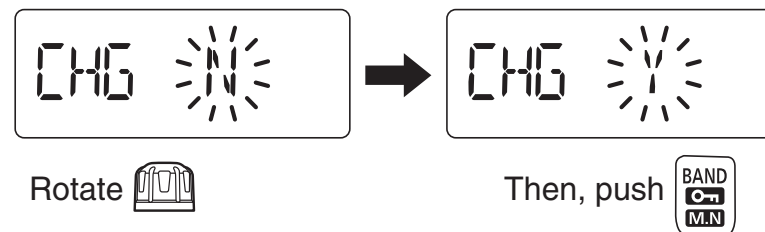

- The battery icon scrolls during charge.



- Both segments blink when completely charged.



## ■ Your first scanning experience

Now that you have your IC-R6 ready, you are probably excited to start listening. We would like to take you through a few basic operation steps to make your first “Listening Experience” enjoyable.

### ◇ About the default settings

The **[DIAL]** control function can be traded with the **[▲]/[▼]** keys function in the Set mode. However, in this QUICK REFERENCE GUIDE, the factory default setting (**[DIAL]** selects the operating frequency) is used for simple instruction.

### ◇ Basic operation

#### 1. Turning ON the receiver

- ➔ Hold down **[⏻]** for 1 second to turn the power ON.



#### 2. Adjusting audio level

- ➔ Push **[▲]/[▼]** to set a desired audio level.

#### 3. Adjusting squelch level

- ➔ While holding down **[SQL]**, rotate **[DIAL]** to set the squelch level.



#### 4. Setting a desired frequency

The tuning dial will allow you to dial in the frequency you want to listen to. Pages 9 and 15 will instruct you on how to set the tuning speed.

- ① Push **[BAND]** repeatedly to select a frequency band.
  - Holding down **[BAND]**, rotating **[DIAL]** will also select a frequency band.
- ② Rotate **[DIAL]** to set the receive frequency.
  - While holding down **[FUNC]**, rotate **[DIAL]** to select frequencies in 1 MHz steps.



## QUICK REFERENCE GUIDE

### ■ Your first scanning experience (continued)

#### 5. Receive mode selection

- ➔ Push **[MODE]** repeatedly to select a desired receive mode.
  - The FM, WFM or AM is selectable.

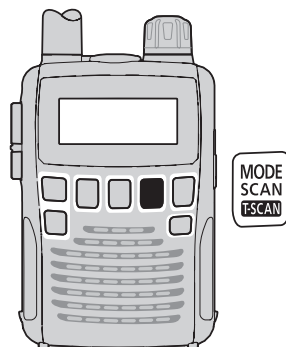

## ■ Memory programming

The IC-R6 has a total of 1300 memory channels for storing often used receive frequency, mode, etc. The memory channels include 200 auto write channels and 50 scan edge channels.

### 1. Setting frequency

In the VFO mode, set a desired receive frequency mode.

- When the “**MR**” icon is displayed, push **[V/M]** to select the VFO mode.

### 2. Selecting a memory channel

Hold down **[S.MW](V/M)** for 1 second, then rotate **[DIAL]** to select a desired memory channel.

- The “**MR**” icon and memory channel number blink.

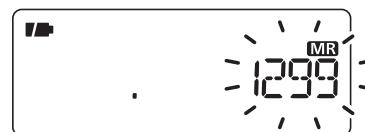

### 3. Writing a memory channel

Hold down **[S.MW](V/M)** for 1 second until 3 beeps sound.

- The memory channel number automatically increases when holding down **[S.MW](V/M,.)** after programming.

## ■ Programmed scan operation

25 pairs, 50 channels of memories are used for programmed scan operation, that specifies a scanning ranges. The programmed scan scans between “xxA” and “xxB” (xx=00 to 24) frequencies. Therefore, before operating the programmed scan, different frequencies must be programmed into “A” and “B” scan edge channels.

### ◇ Programming scan edges

A start frequency must be programmed into a “xxA,” and end frequency must be programmed into a “xxB” memory channel.

#### 1. Setting frequency

In the VFO mode, set a desired receive frequency selection mode.

- When the “**MR**” icon is displayed, push **[V/M]** to select the VFO mode.

#### 2. Selecting a scan edge “A” channel

Hold down **[S.MW]**(V/M) for 1 second, then rotate **[DIAL]** to select one of the 25 scan edge “A” channels.

- The “**MR**” icon and scan edge channel number blink.

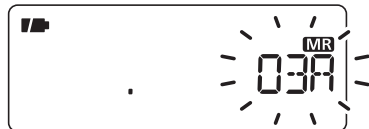

#### 3. Writing a memory channel

Hold down **[S.MW]**(V/M) for 1 second until 3 beeps sound.

- The paired scan edge “B” channel is automatically selected when holding down **[S.MW]**(V/M) after programming.
- When programming is completed, return to the VFO mode.

#### 4. Selecting a scan edge “B” channel

Hold down **[S.MW]**(V/M) for 1 second, then rotate **[DIAL]** to select one of the 25 scan edge channel “B.”

- The “**MR**” icon and the scan edge channel number blink.
- When the scan edge “B” channel is already selected in step 3. (by holding down **[S.MW]**(V/M) after programming), skip this step.



#### 5. Writing a memory channel

Hold down **[S.MW]**(V/M) for 1 second until 3 beeps sound.

- The next scan edge “A” channel is automatically selected when holding down **[S.MW]**(V/M) after programming.
- When programming is completed, return to the VFO mode.

## QUICK REFERENCE GUIDE

### ◇ Starting scan

#### 1. Select the VFO mode.

Push [V/M] to select the VFO mode for a VFO scan operation, such as full scan, band scan and programmed scan.

- Select the memory mode by pushing [V/M] again for a memory scan operation, such as all memory scan, bank link scan or bank scan.

#### 2. Selecting a scan type

Hold down [SCAN](MODE) for 1 second, and then rotate [DIAL] to select one of a desired scanning types.

- Select “ALL” for full scan, “BAND” for band scan, “P-LINK x” for programmed link scan (x= 0 to 9), “PROGxx” for programmed scan (xx= 0 to 24; only programmed scan edge numbers are displayed).
- Select “M-ALL” for all memory scan, “B-ALL” for all bank scan, “B-LINK” for bank link scan or “BANK-x” for bank scan (x= A to R, T, U, W, Y; only programmed bank groups are displayed).



#### Scan type display examples

##### In the VFO mode

- Full scan



- Band scan



- Program link scan



- Program scan



##### In the memory mode

- All memory scan



- All bank scan



- Bank link scan



- Bank scan

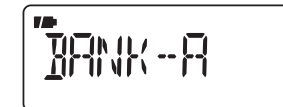

### 3. Starting scan

Push **[SCAN]**(MODE) to start the scan.

- Rotate **[DIAL]** to change the scanning direction.

#### In the VFO mode

- Full/Band scan

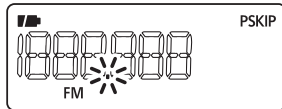

- Program link  
Program scan

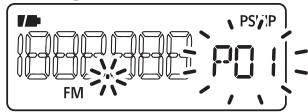

#### In the memory mode

- All memory/All bank  
bank link scan

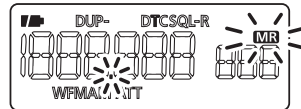

- Bank scan

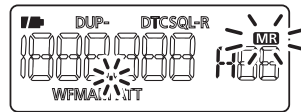

### 4. Cancelling scan

Push **[SCAN]**(MODE) again to stop the scan.

#### ✓ For your information

The memory channel number you program the scan edges into correlates “PROGxx” as follows:

00A/00B: Selects “PROG 00” to scan between frequencies programmed in channels 00A and 00B.

01A/01B: Selects “PROG 01” to scan between frequencies programmed in channels 01A and 01B.

•  
•  
•  
•

23A/23B: Selects “PROG 23” to scan between frequencies programmed in channels 23A and 23B.

24A/24B: Selects “PROG 24” to scan between frequencies programmed in channels 24A and 24B.

# 1

## PANEL DESCRIPTION

### ■ Front, top and side panels

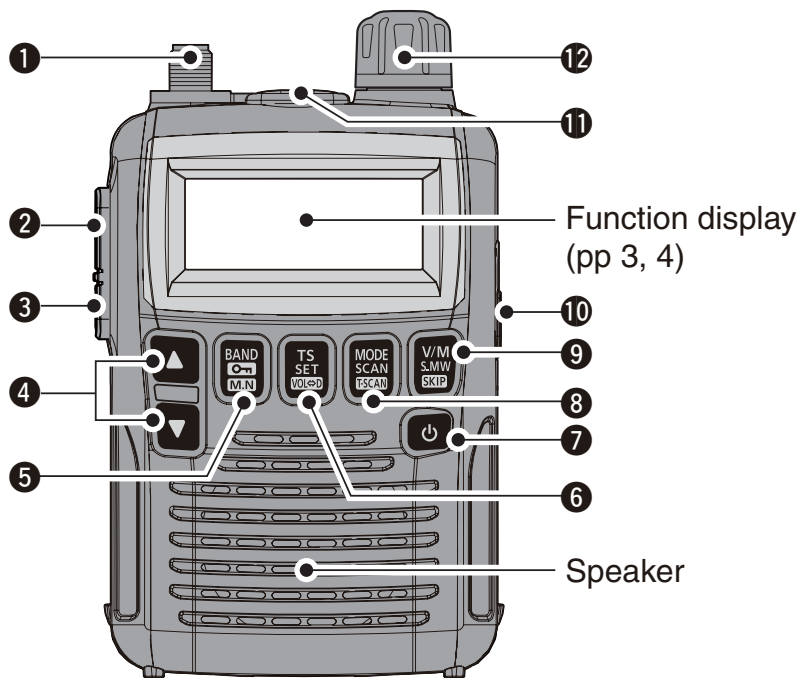

#### ① ANTENNA CONNECTOR (p. 1)

Connect the supplied antenna.

- An optional AD-92SMA is available for connecting an antenna with a BNC connector.

#### ② FUNCTION KEY [FUNC]

While holding down this switch, access a key's secondary or third function.

#### ③ SQUELCH • ATTENUATOR KEY [SQL] • [ATT](SQL)

- ➔ Hold down to temporarily open the squelch and monitor the operating frequency. (p. 13)
- ➔ While holding down this switch, rotate [DIAL]\* to adjust the squelch level. (p. 12)
- ➔ While holding down [FUNC], push to toggle the attenuator function ON or OFF. (p. 10)

#### ④ UP/DOWN KEYS [▲]/[▼]\*

Adjusts the audio volume level. (p. 11)

#### ⑤ BAND • LOCK • MEMORY NAME KEY [BAND] • [C.M](BAND) • [M.N](BAND)

- ➔ Push to select the operating frequency band. (p. 7)
- ➔ While holding down [FUNC], push and hold for 1 second to toggle the lock function ON or OFF. (p. 10)
- ➔ During memory mode operation, hold down [FUNC], then push this key to select the display type.
  - The display shows the memory bank name<sup>†</sup>, memory name<sup>†</sup> and channel number in sequence, and then returns to the frequency display.
  - <sup>†</sup>The memory bank name or memory name must have pre-programmed.

\*The functions of [DIAL] and [▲]/[▼] can be exchanged. See page 49 for details.

**6 TUNING STEP • SET • DIAL EXCHANGE KEY**

[TS] • [SET](TS) • [VOL↔D](TS)

- ➔ Push to enter tuning step selecting mode. (p. 9)
- ➔ Hold down for 1 second to enter the Set mode. (p. 39)
- ➔ While holding down [FUNC], push to exchange the [DIAL] and [▲]/[▼] keys' functions. (p. 49)

**7 POWER KEY [⏻]**

Hold down for 1 second to turn the receiver power ON or OFF.

**8 MODE • SCAN • TONE SCAN KEY**

[MODE] • [SCAN](MODE) • [TSCAN](MODE)

- ➔ Push to select the receive mode. (p. 12)
- ➔ Hold down for 1 second to enter the scan type selection mode. (p. 26)
  - Push again to start the scan.
- ➔ While holding down [FUNC], push to start a tone scan. (p. 38)

**9 VFO/MEMORY • MEMORY WRITE • SKIP KEY**

[V/M] • [S.MW](V/M) • [SKIP](V/M)

- ➔ Toggles between the VFO or the memory mode. (p. 7)
- ➔ Hold down for 1 second to enter memory edit condition. (p. 16)
- ➔ During VFO mode operation, hold down [FUNC], then push this key to select the programmed skip scan setting ON or OFF.
- ➔ During memory mode operation, hold down [FUNC], then push this key to select the scan skip condition for the selected channel. (p. 30)

**10 EXTERNAL DC-IN CONNECTOR [DC4.5V] (p. 6)**

Connects an AC adapter or an optional cigarette lighter cable for both charging the installed re-chargeable battery and operating. Connectable voltage is from 4.5 V DC to 6.3 V DC.

**11 EXTERNAL SPEAKER CONNECTOR [SP]**

Connect an optional earphone or headphones. The internal speaker will not function when any external equipment is connected. (See page 65 for a list of available options.)

**12 CONTROL DIAL [DIAL]\***

- ➔ Rotate to select the operating frequency.\* (p. 9)
- ➔ While scanning, changes the scanning direction. (p. 26)
- ➔ While holding down [SQL], sets the squelch level. (p. 12)
- ➔ While holding down [FUNC], sets the operating frequency in 100 kHz, 1 MHz or 10 MHz in the VFO mode. (p. 9)
- ➔ While holding down [FUNC], selects the memory channel in 10 channels steps in the memory mode. (p. 10)
- ➔ While holding down [BAND], selects the operating band in the VFO mode. (p. 7)

\*The functions of [DIAL] and [▲]/[▼] can be exchanged. See page 49 for details.

|    |
|----|
| 1  |
| 2  |
| 3  |
| 4  |
| 5  |
| 6  |
| 7  |
| 8  |
| 9  |
| 10 |
| 11 |
| 12 |
| 13 |
| 14 |
| 15 |
| 16 |

# 1 PANEL DESCRIPTION

## ■ Function display

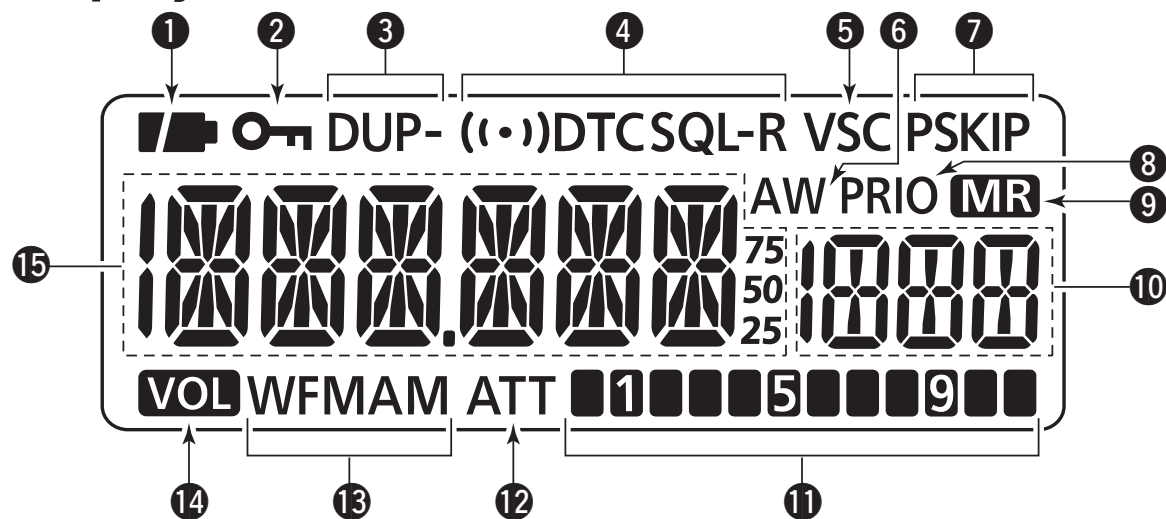

### ① BATTERY ICON

- Both segments appear when the batteries have ample capacity.
  - They do not appear when operating with an external power source.
- Only the right segment “” appears when the batteries have less than half capacity.
- Scrolls while charging the rechargeable batteries. (p. 6)



- Both segments blink when completely charged.

### ② LOCK ICON (p. 10)

Appears when the lock function is activated.

### ③ DUPLEX ICONS (p. 14)

“DUP” appears when plus duplex, and “DUP-” appears when minus duplex operation is selected.

### ④ TONE ICONS

- “T SQL” appears while the tone squelch function is in use. (p. 35)
- “DTCS” appears while the DTCS squelch function is in use. (p. 35)
- “((•))” appears with the “T SQL” or “DTCS” icon while the pocket beep function (with CTCSS or DTCS) is in use. (p. 35)

### ⑤ VSC ICON (p. ??)

Appears while the VSC function is in use.



- ⑥ **AUTO WRITE CHANNEL ICON** (p. 29)  
Appears when an auto write channel is selected.
- ⑦ **SKIP ICONS** (p. 30)
  - ➔ “SKIP” appears when the selected memory channel is specified as a skip channel.
  - ➔ “PSKIP” appears when the displayed frequency is specified as a skip frequency.
- ⑧ **PRIORITY WATCH ICON** (p. 33)  
Appears while priority watch is in use.
- ⑨ **MEMORY ICON** (pgs. 7, 10)  
Appears when the memory mode is selected.
- ⑩ **MEMORY CHANNEL NUMBER**  
Shows the selected memory channel number. (pgs. 7, 10)
- ⑪ **SIGNAL STRENGTH INDICATOR** (p. 11)  
Shows the relative signal strength while receiving signals.
- ⑫ **ATTENUATOR ICON** (p. 13)  
Appears while the RF attenuator is in use.
- ⑬ **RECEIVE MODE ICON** (p. 12)  
Shows the selected receive mode.
  - FM, WFM and AM modes are selectable.
- ⑭ **VOLUME EXCHANGE ICON** (p. 49)  
Appears when the function of [DIAL] and [▲]/[▼] are exchanged.

- ⑮ **FREQUENCY READOUT**  
Shows a variety of information, such as the operating frequency, Set mode contents, memory names.
  - The smaller “75,” “50” and “25” to the right of the readout indicate 0.75, 0.5 and 0.25 kHz, respectively.
  - The decimal point blinks during a scan.

# 2

## BATTERY CHARGING

### ■ Battery installation

Before installing, or replacing the batteries, hold down [⏻] for 1 second to turn the power OFF.

- ① Remove the battery cover from the receiver.

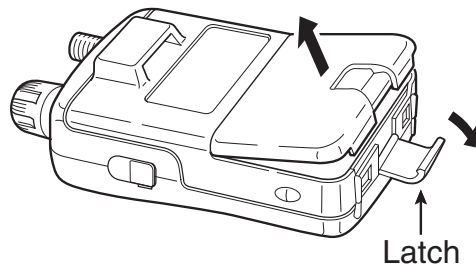

- ② Install 2 R6 (AA) size Ni-MH batteries.
  - Be sure to observe the correct polarity.

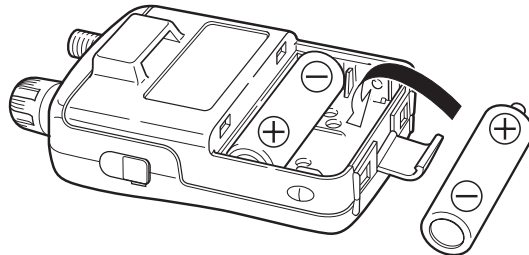

### ■ Caution



- ⚠ **DANGER! NEVER** short the battery terminals (or charging terminals). Also, current may flow into nearby metal objects such as a necklace, so be careful when placing batteries (or the receiver) in handbags, etc. Simply carrying with or placing near metal objects such as a necklace, etc. may cause shorting. This may damage not only the batteries, but also the receiver.
- ⚠ **DANGER! NEVER** incinerate used batteries. Internal battery gas may cause an explosion.
- ⚠ **DANGER! NEVER** immerse the batteries in water. If the batteries become wet, be sure to wipe them dry **BEFORE** installing them to the receiver.
- When installing batteries, make sure they are all the same brand, type and capacity. Also, do not mix new and old batteries together.
- Never use batteries whose insulated covering is damaged.
- **Keep** battery terminals clean to avoid rust or misscontact. It's a good idea to clean battery terminals once a week.

### ◇ Caution for the Ni-MH batteries

- **CAUTION:** Always use the batteries within the specified temperature range,  $-5^{\circ}\text{C}$  to  $+60^{\circ}\text{C}$  ( $+23^{\circ}\text{F}$  to  $+140^{\circ}\text{F}$ ). Using the batteries out of their specified temperature range will reduce the battery's performance and battery life.

- **CAUTION:** Shorter battery life could occur if the batteries are left completely discharged, or in an excessive temperature environment (above +55°C; +131°F) for an extended period of time. If the batteries must be left unused for a long time, they must be detached from the receiver after charging. Keep them safely in a cool dry place at the following temperature range:
  - 20°C to +45°C (–4°F to +113°F) (up to a month)
  - 20°C to +35°C (–4°F to +95°F) (up to six months)
  - 20°C to +25°C (–4°F to +77°F) (up to a year\*)
 \* We recommend charging the batteries every 6 months.
- If your Ni-MH batteries seem to have no capacity, even after being charged, completely discharge them by leaving the power ON overnight. Then, fully charge the batteries again. If the batteries still do not retain a charge (or only very little charge), a new batteries must be purchased. Prior to using the receiver for the first time, the batteries must be fully charged for optimum life and operation.
- The supplied batteries are rechargeable batteries. Charge the batteries before first operating the receiver, or when the batteries become exhausted. If you want to prolong the battery life, the following points should be observed:
  - Avoid over charging.
  - Use the batteries until it becomes almost completely exhausted, under normal conditions.

◇ **Charging caution**

- ⚠ **WARNING! NEVER** charge alkaline batteries. The receiver can charge only the Ni-MH batteries (1.2 V, 1400 mAH typ.). Other types of rechargeable battery, such as Ni-Cd or Li-Ion cannot be charged.
- **AVOID over charging**— The installed rechargeable batteries can be charged during operation when the AC adapter or the cigarette lighter cable is connected. To prevent over charging, the IC-R6 has charging timer that automatically disconnecting\* the charging line electronically after 15 hours from charging. However, the charging timer will reset and start charging again when disconnect then reconnecting the AC adapter or CP-18A/E more than 1 minute interval.
  - \* When the “CHARGE” setting in the Set mode is set to “CHG2,” the receiver continues to trickle charge after 15 hours have past.
- Recommended temperature range for charging: between 0°C (+32°F) and +40°C (+140°F) by the receiver.
- Use the BC-196S/BC-153SC AC adapter or CP-18A/E cigarette liter cable only. **NEVER** use other manufacturers’ chargers.
- The external DC power supply voltage must be between 12–16 V to charge the batteries and for operation when using an optional CP-18A/E.
- If the battery icons (“” and “”) disappear only 1 minute after connecting to the DC power supply, the batteries may have problem. In this case, contact your Icom dealer/distributor, or purchase a new batteries.

## 2 BATTERY CHARGING

### ■ Battery charging

#### ◇ Charging connections

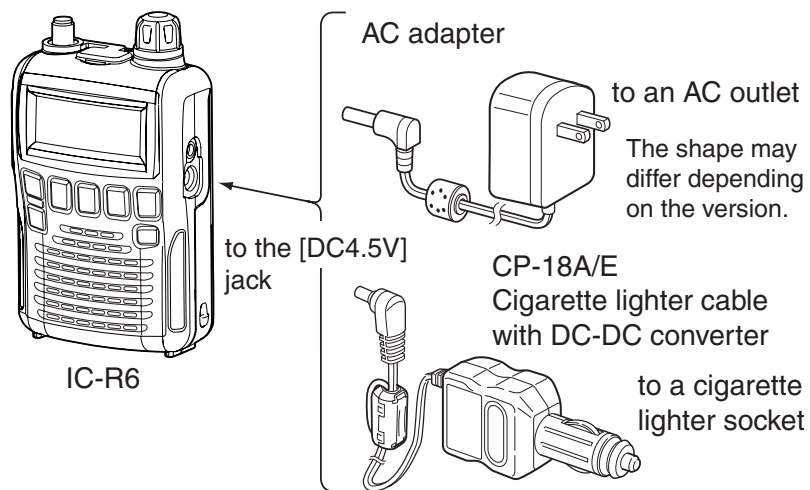

• **Charging periods:** Approx. 15 hours

**⚠ WARNING!:**  
**NEVER** attempt to charge the alkaline batteries.

**⚠ CAUTION: BE SURE** to disconnect the CP-18A/E from the cigarette lighter socket when charging is finished, because, a slight current still follows in the CP-18A/E and the vehicle's battery will become exhausted.

#### ◇ Charging description

- ① Install the Ni-MH batteries. (See page 5.)
- ② Plug the AC adapter into an AC outlet; or the CP-18A/E into a cigarette lighter socket.
- ③ Insert the adapter plug into [DC4.5V] of the receiver.
  - Once the batteries are removed for more than 2 seconds, the following operations are necessary.
  - The battery confirmation is displayed.

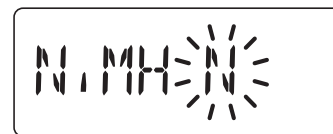

- ⚠ If the confirmation does not appear, following operation is necessary.
- ① Disconnect the adapter plug from [DC4.5V].
  - ② Holding down **[FUNC]**, insert the adapter plug again.
  - ③ Release **[FUNC]**.

- ④ Rotate **[DIAL]** to select "Y," then push **[BAND]**.

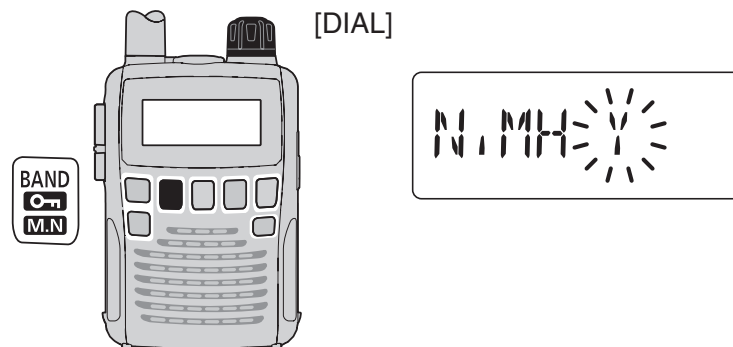

- The charging confirmation is displayed.

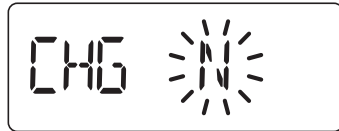

- ⑦ Rotate [DIAL] to select “Y,” then push [BAND] to start the battery charging.

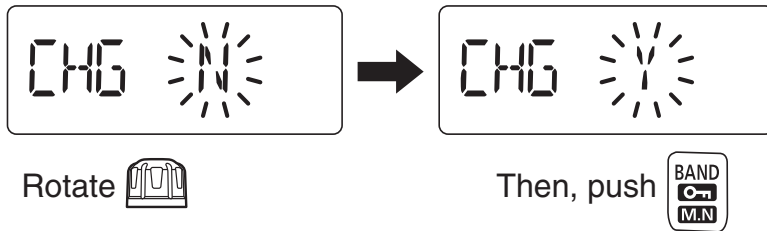

- The battery icon scrolls during charge.



- Both segments blink when completely charged.
- It takes approximately 13 hours to fully charge the Ni-MH batteries.

### ◇ Charge adapter BC-194

The BC-194, charge adapter, is useful to charge, and the receiver is easy to attach to or detach from the BC-194. The BC-194 can be used the BC-196S/BC-153SC or CP-18A/E to a power source.

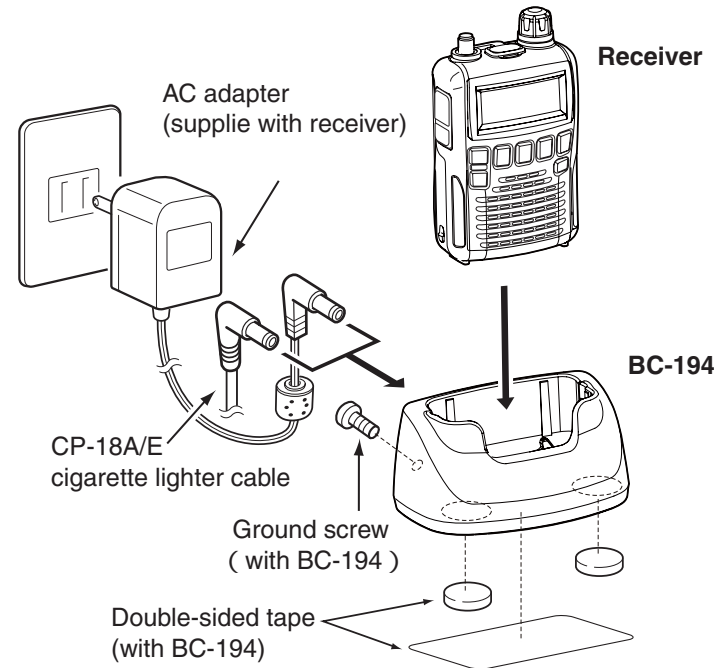

|    |
|----|
| 1  |
| 2  |
| 3  |
| 4  |
| 5  |
| 6  |
| 7  |
| 8  |
| 9  |
| 10 |
| 11 |
| 12 |
| 13 |
| 14 |
| 15 |
| 16 |

# 3

## FREQUENCY AND CHANNEL SETTING

### ■ VFO and memory channels

The IC-R6 has 2 normal operating modes: the VFO mode and the memory mode.

**The VFO mode** is used for a desired frequency setting within the frequency coverage.

➔ Push **[V/M]** to select the VFO mode.

**The memory mode** is used for quick recall the preprogrammed memory channels.

➔ Push **[V/M]** to select the memory mode.

- See p. 16 for memory programming details.

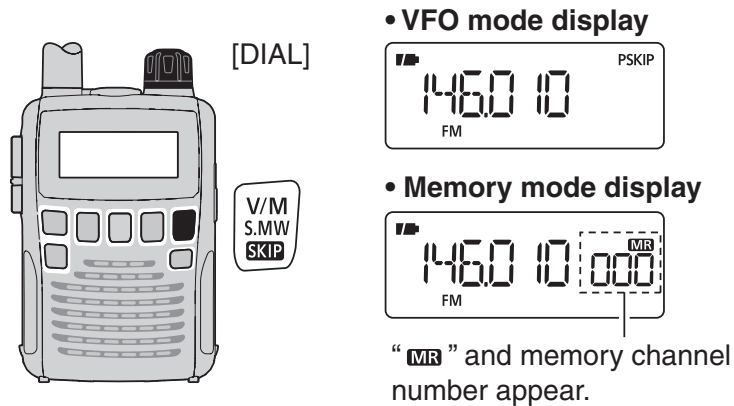

#### **What is VFO?**

VFO is an abbreviation of Variable Frequency Oscillator. Operating frequencies are generated and controlled by the VFO.

### ■ Operating band selection

The receiver can receive the AM broadcast, HF band, 50 MHz, FM broadcast, VHF air, 144 MHz, 300 MHz, 400 MHz, 800 MHz,\* 1200 MHz, television channels or Weather channels†.

- ➔ Push **[BAND]** repeatedly to select a desired frequency band.
  - When the memory mode is selected, push **[V/M]** to select the VFO mode first, then push **[BAND]** to select a desired band.
- ➔ While holding down **[BAND]**, rotating **[DIAL]** also selects frequency band.



- ▨ Available frequency bands are differ depending on version. See the specification for details.
- ▨ \*Some frequency ranges are inhibited for the USA version due to local regulation.
- ▨ †Available in only the USA version.

• Available frequency bands

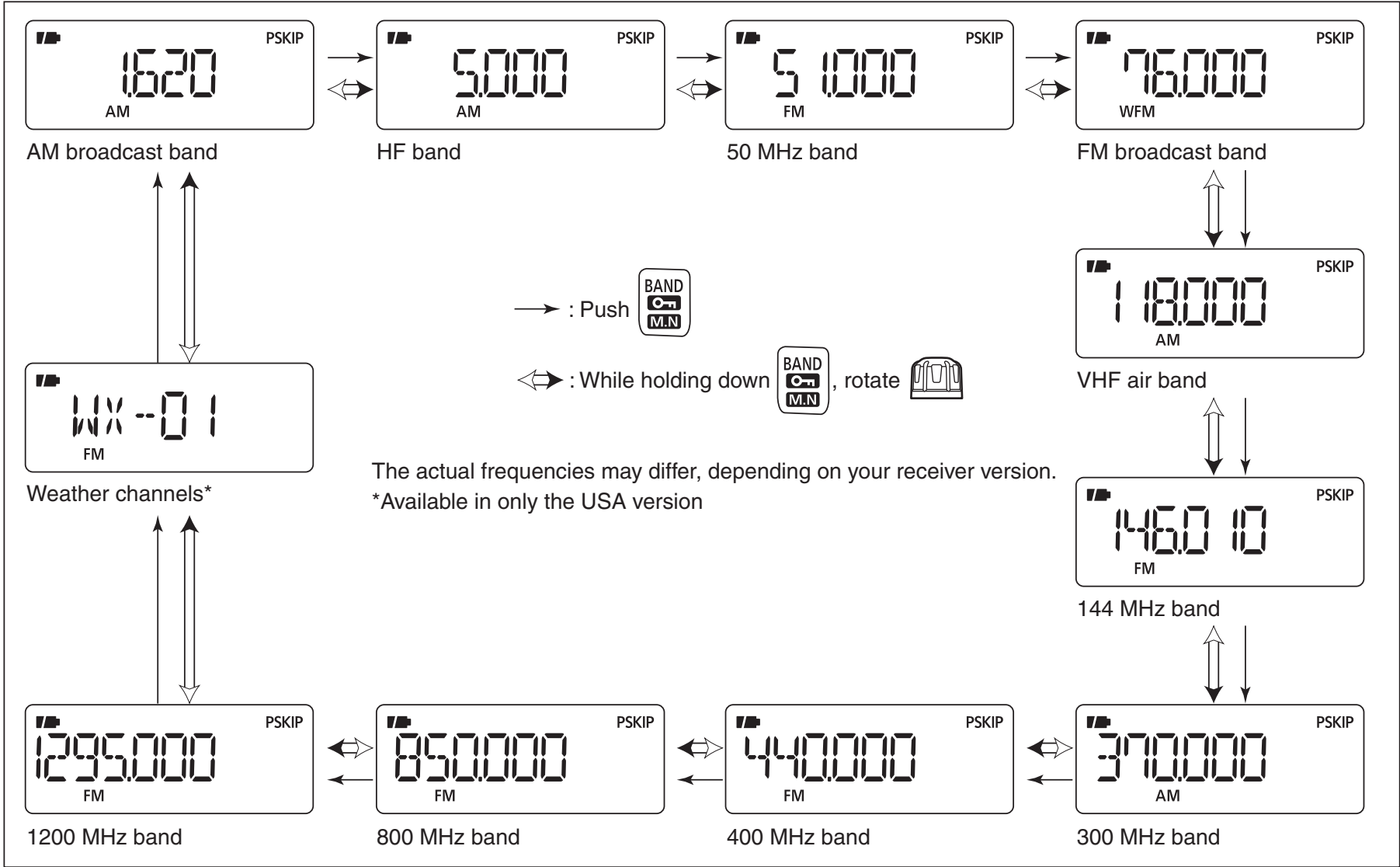

## 3 FREQUENCY AND CHANNEL SETTING

### ■ Setting a frequency

- ① Push **[V/M]** to select the VFO mode, if necessary.
- ② Select a desired frequency band with **[BAND]**.
  - Or, while holding down **[BAND]**, rotate the **[DIAL]** to select a desired frequency band.
- ③ Rotate **[DIAL]** to select a desired frequency band.
  - The frequency changes according to the preset tuning steps. See the section to the right for setting the tuning step.
  - While holding down **[FUNC]**, rotate **[DIAL]** to change the frequency in 1 MHz steps (default).



[DIAL] changes the frequency according to the selected tuning step.



While continuing to push **[FUNC]**, **[DIAL]** changes the frequency in 1 MHz steps (default).

▨ The 1 MHz tuning step (dial select step) can be set to 100 kHz, 1 MHz or 10 MHz tuning steps in the Set mode. See p. 15 for details.

### ■ Setting a tuning step

The tuning step can be selected for each frequency band. However, additional steps become selectable only in the VHF Air band (8.33 kHz) and in the AM broadcast band (9 kHz)\*. The following tuning steps are available for the IC-R6.

- 5.0 kHz
- 6.25 kHz
- 8.33 kHz\*
- 9.0 kHz\*
- 10.0 kHz
- 12.5 kHz
- 15.0 kHz
- 20.0 kHz
- 25.0 kHz
- 30.0 kHz
- 50.0 kHz
- 100.0 kHz

#### ◇ Tuning step selection

- ① Push **[V/M]** to select the VFO mode, if necessary.
- ② Push **[BAND]** to select a desired frequency band.
  - Or, while holding down **[BAND]**, rotate **[DIAL]** to select a desired frequency band.
- ③ Push **[TS]** to enter tuning step selecting condition.
- ④ Rotate **[DIAL]** to select a desired tuning step.
- ⑤ Push **[TS]** to return to the VFO mode.



5 kHz tuning step



## ■ Selecting a memory channel

- ① Push **[V/M]** to select the memory mode.
  - “**MR**” appears when the memory mode is selected.
- ② Rotate **[DIAL]** to select a desired memory channel.
  - Only programmed memory channels can be selected.
  - While holding down **[FUNC]**, rotate **[DIAL]** to select a memory channel in 10 channels steps.

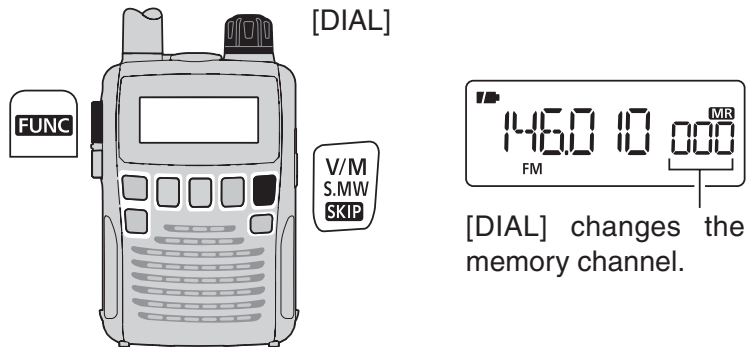

## ■ Lock function

To prevent accidental frequency changes and unnecessary function access, use the lock function.

- ➔ While holding down **[FUNC]**, push and hold **[BAND]** for 1 second to turn the lock function ON or OFF.
  - “**LO**” appears while the lock function is activated.
  - **[SQL]** and **[▲]/[▼]** can be used while the lock function is in use with default setting. Either or both **[SQL]** and **[▲]/[▼]** keys can also be locked in the Set mode. (p. 43)

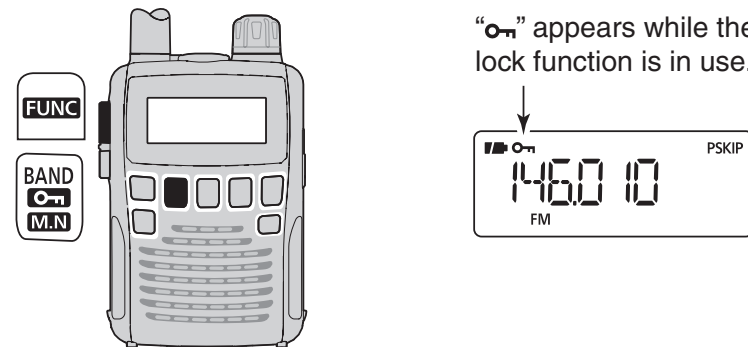

# 4

## BASIC OPERATION

### ■ Receiving

Make sure charged Ni-MH or brand new alkaline batteries are installed (p. 5).

- ① Hold down [⏻] for 1 second to turn power ON.
- ② Push [▲] or [▼] to set a desired audio level.
  - The function display shows the volume level while setting. See the section to the right for details.
- ③ Set the receive frequency. (p. 9)
- ④ Set the squelch level. (p. 12)
  - While holding down [SQL], rotate [DIAL].
  - The first click of [DIAL] indicates the current squelch level.
  - “LEVEL 1” is loose squelch and “LEVEL 9” is tight squelch.
  - “AUTO” indicates automatic level adjustment with a noise pulse count system.
  - Hold down [SQL] to open the squelch manually.
- ⑤ When a signal is received:
  - Squelch opens and audio is heard.
  - The S-meter shows the relative signal strength.

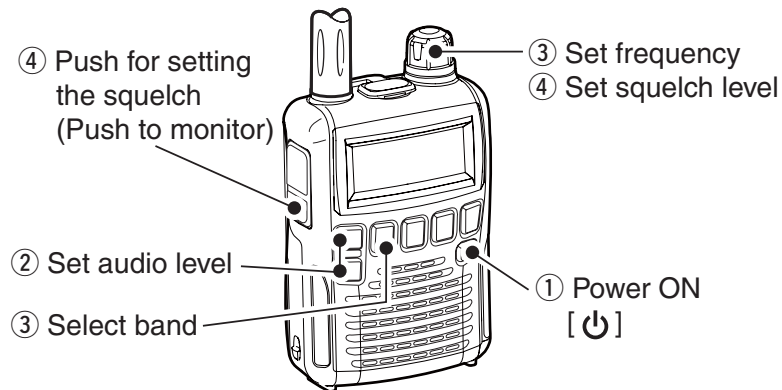

### ■ Setting audio volume

The audio level can be adjusted through 40 levels.

- ➔ Push [▲] or [▼] to adjust the audio level.
  - A beep tone sounds while adjusting. The tone sound let you know the approximate sound level.
  - Holding down either key will continuously change the audio level.
  - The display shows the volume level while setting.

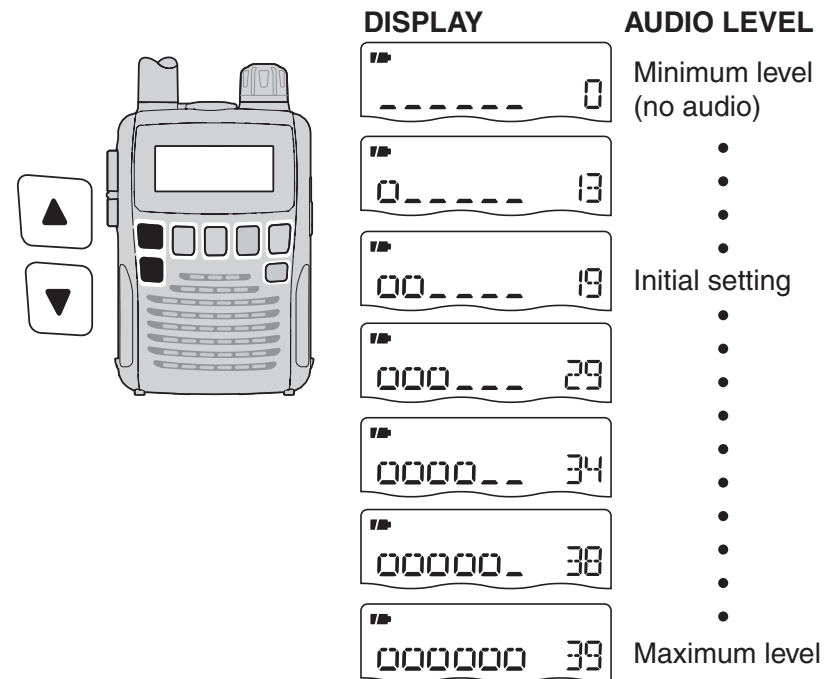

## ■ Squelch level setting

The squelch circuit mutes the received audio signal, depending on the signal strength. The receiver has 9 squelch levels, a continuously open setting and an automatic squelch setting.

- ➔ While holding down **[SQL]**, rotate **[DIAL]** to select the squelch level.
  - “LEVEL 1” is loose squelch (for weak signals) and “LEVEL 9” is tight squelch (for strong signals).
  - “AUTO” indicates the automatic level adjustment by a noise pulse count system.
  - “OPEN” indicates the continuously open setting.

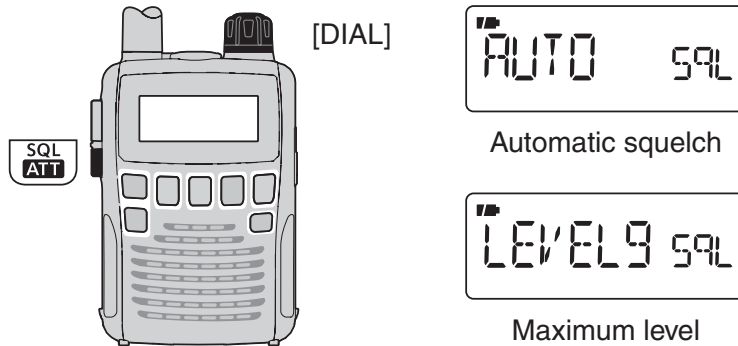

## ■ Receive mode selection

The receiver has three receive modes, FM, AM and WFM. The mode selection is stored independently in each band and memory channels.

Typically, the AM mode is used for the AM broadcast stations (0.495–1.620 MHz) and air band (118–135.995 MHz), and WFM is used for FM broadcast stations (76–107.9 MHz).

- ➔ Push **[MODE]** repeatedly to select a desired receive mode.

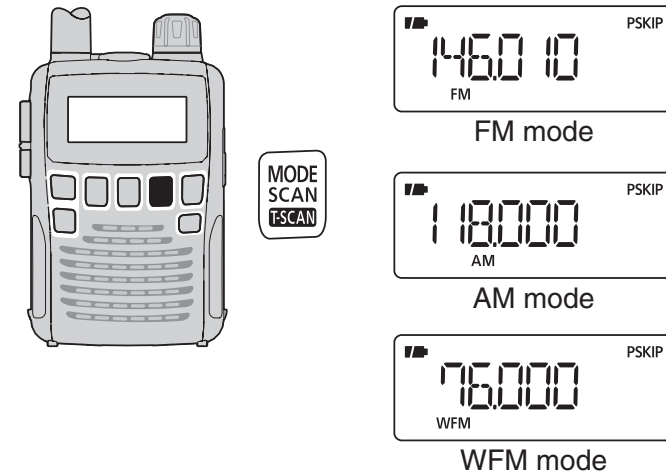

## 4 BASIC OPERATION

### ■ Monitor function

This function is used to listen to weak signals, without disturbing the squelch setting. It can also be used to open the squelch manually, even when mute functions such as the tone squelch are in use.

- ➔ Hold down **[SQL]** to monitor the receive frequency.
  - The 1st segment of the S-meter blinks.



The 1st/2nd segments blink

/// The **[SQL]** switch can be set to a 'sticky' operation in the Expand set mode. See page 43 for details.

### ■ Attenuator function

The attenuator prevents a received signal from distorting when very strong signals are near a desired frequency, or when very strong electric fields, such as from a broadcasting station, are near your location.

- ➔ While holding down **[FUNC]**, push **[ATT]**(SQL) to toggle the attenuator function ON or OFF.
  - "ATT" appears when the attenuator functions is in use.



"ATT" appears while the attenuator functions is in use.

## Duplex operation

### USING EXPAND SET MODE

Duplex communication uses 2 different frequencies for transmitting and receiving. Generally, duplex is used in communication through a repeater, some utility communications, etc.

During duplex operation, the transmit station frequency is shifted from the receive station frequency by the offset frequency. Repeater information (offset frequency and shift direction) can be programmed into memory channels. (p. 16)

#### ◇ Setting

- ① Set the receive station frequency (repeater output frequency).
- ② Hold down **[SET]**(TS) for 1 second to enter the Set mode.
- ③ Rotate **[DIAL]** to select the “EXPAND” item.
  - “EXPAND” disappears after 1 second and “OFF” (default) and “EX” appear.

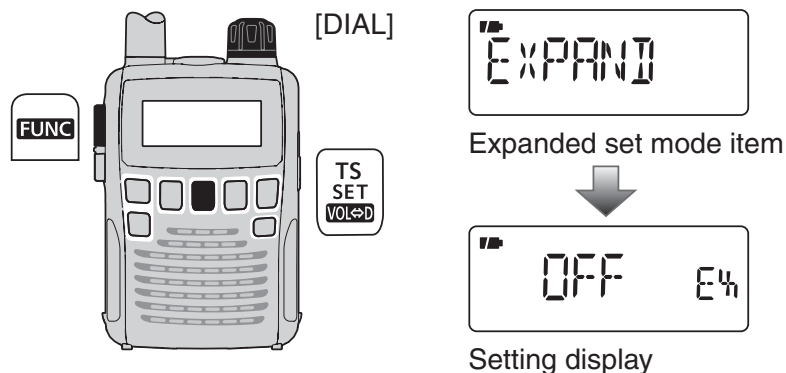

- ④ While holding down **[FUNC]**, rotate **[DIAL]** to select “ON.”

- ⑤ Rotate **[DIAL]** to select the “OFFSET” item.
  - “OFFSET” disappears after 1 second and “0.600” (default) and “OW” appear.  
(Default offset differs depending on the frequency band or receiver version.)

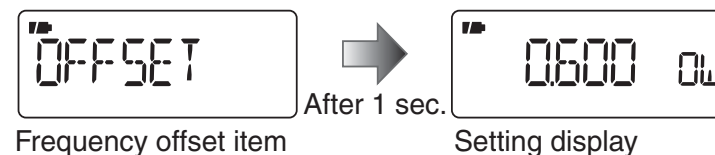

- ⑥ While holding down **[FUNC]**, rotate **[DIAL]** to set a desired offset frequency within 0.000–159.995 MHz range.
  - The tuning step, selected in the VFO mode, is used for setting.
- ⑦ Rotate **[DIAL]** to select the “DUP” item.
  - “DUP” disappears after 1 second and “OFF” (default) and “DP” appear.

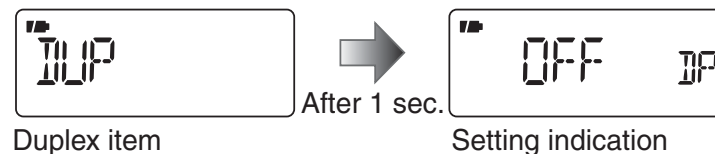

- ⑧ While holding down **[FUNC]**, rotate **[DIAL]** to select “-DUP” or “+DUP.”
- ⑨ Push **[SET]**(TS) to exit the Set mode.
- ⑩ Hold down **[SQL]** to monitor the transmit station frequency (repeater input frequency) directly.

## 4 BASIC OPERATION

### ■ Dial select step

USING SET MODE

This receiver has a 1 MHz tuning step for quick frequency setting. You can select 100 kHz, 1 MHz or 10 MHz steps, as desired.

#### ◇ Setting dial select step

- ① Push **[V/M]** to select the VFO mode.
- ② Hold down **[SET](TS)** for 1 second to enter the Set mode.
- ③ Rotate **[DIAL]** to select the “D SEL” item.
  - “D SEL” disappears after 1 second and “1M” (default) and “DS” appear.
- ④ While holding down **[FUNC]**, rotate **[DIAL]** to select a desired dial select step.
  - 100 kHz, 1 MHz and 10 MHz can be selected.
- ⑤ Push **[SET](TS)** to exit the Set mode.

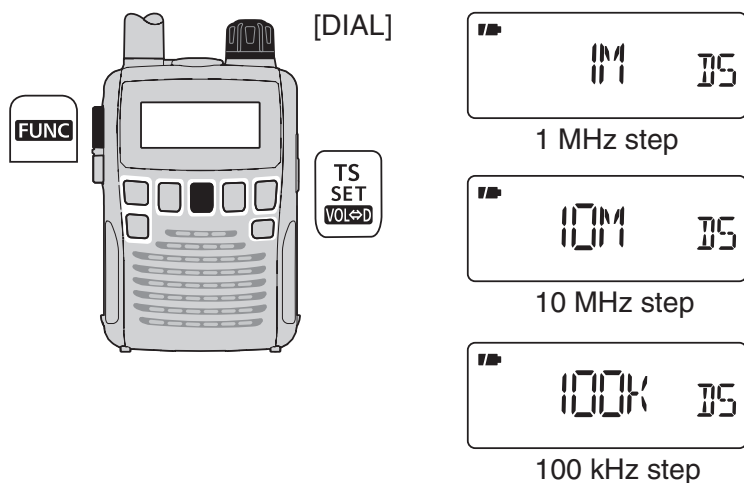

## ■ General description

The receiver has **1350** memory channels, including 50 scan edge memory channels (25 pairs) for storage of often-used frequencies. A total of 18 memory banks, A to R, T, U, W and Y can be selected. Up to 100 channels can be assigned to each bank.

### ◇ Memory channel contents

The following information can be programmed into memory channels:

- Receive frequency (p. 9)
- Receive mode (p. 12)
- Duplex direction (+DUP or -DUP) with a frequency offset (p. 14)
- Tone squelch or DTCS squelch ON/OFF (p. 35)
- Tone squelch frequency or DTCS code with polarity (pp. 36, 37)
- Scan skip setting (p. 30)
- **Memory bank (p. 95)**
- **Memory name (p. 97)**
- Tuning step (p. 22)

**NOTE:** Memory data can be erased by static electricity, electric transients, etc.

In addition, it can be erased by malfunction and during repairs. Therefore, we recommend that memory data be written down or saved to a PC using the CS-R6 CLONING SOFTWARE.

## ■ Selecting a memory channel

- ① Push **[V/M]** to select the memory mode.
  - Push **[V/M]** to toggle between the VFO mode and the memory channel mode.
- ② Rotate **[DIAL]** to select a desired memory channel.
  - Only programmed channels are displayed.
  - While holding down **[FUNC]**, rotate **[DIAL]** to select the memory channel in 10 channel steps.

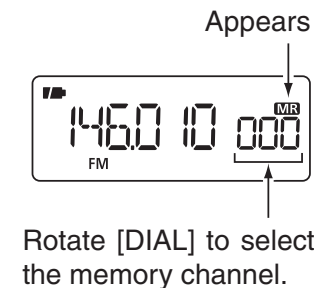

## 5 MEMORY CHANNELS

### Memory channel programming

- ① Push **[V/M]** to select the VFO mode.
- ② Set a desired frequency:
  - Select a desired band with **[BAND]**.
  - Set a desired frequency with **[DIAL]**.
  - Set other data (e.g. frequency offset, duplex direction, tone squelch, etc.), if desired.
- ③ Hold down **[S.MW](V/M)** for 1 second to enter the select memory write mode.
  - 1 short and 1 long beep sound.
  - The “**MR**” icon and memory channel number blink.
- ④ Rotate **[DIAL]** to select a desired channel.
  - Scan edge channels, 00A/B to 24A/B can also be selected.
  - While holding down **[FUNC]**, rotate **[DIAL]** to select memory channels in 10 channel steps.
- ⑤ Hold down **[S.MW](V/M)** for 1 second.
  - 3 beeps sound
  - The memory channel number automatically increases when holding down **[S.MW](V/M)** after programming.

**NOTE:** Push **[V/M]** to cancel programming and exit the select memory write mode, before memory programming is finished.

**[EXAMPLE]:** Programming 145.870 MHz into memory channel 20 (a blank channel).

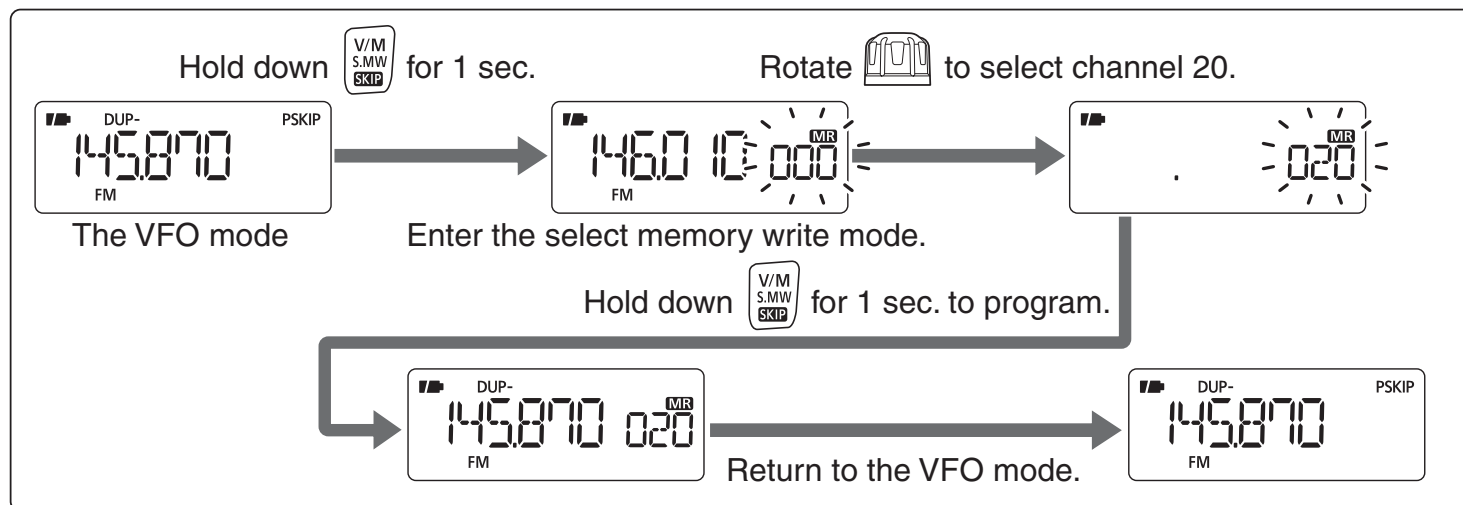



## Memory bank setting

The IC-R6 has a total of 22 banks (A to R, T, U, W and Y). Regular memory channels 000 to 1299, and scan edge memory channels 00A to 24B, can be assigned to any desired bank, for easy memory management.

- ① Hold down **[S.MW]**(V/M) for 1 second to enter the select memory write mode.
  - 1 short and 1 long beep sound.
  - The “**MR**” icon and memory channel number blink.
- ② Rotate **[DIAL]** to select a desired memory channel.
- ③ While holding down **[MODE]**, rotate **[DIAL]** to select the “**BANK**” item.
  - The bank group and channel number are displayed if the selected memory channel has already been assigned to a bank.
  - The “**BANK**” item can also be selected by pushing **[MODE]** repeatedly.

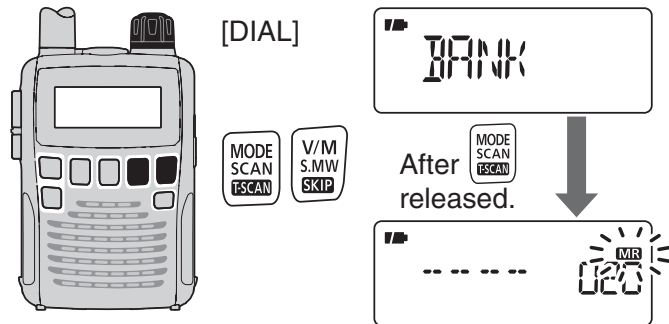

- After releasing **[MODE]**, “-- -- -- --” is displayed instead of the frequency display, and only the “**MR**” icon blinks.

- ④ While holding down **[BAND]**, rotate **[DIAL]** to select a desired bank group.
  - Bank groups A to R, T, U, W and Y are available.
  - The bank groups can also be selected by repeatedly pushing **[BAND]**.

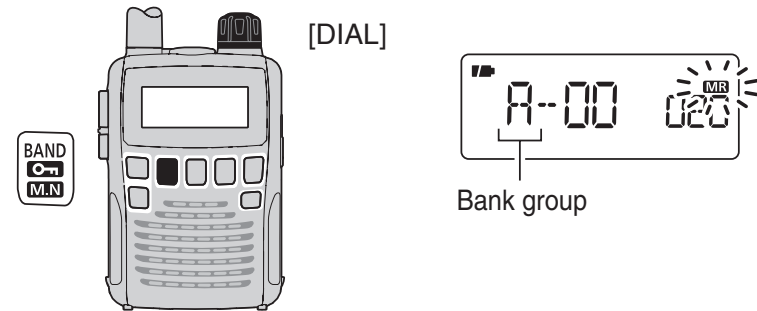

- ⑤ Rotate **[DIAL]** to select a desired bank channel number.
  - Only vacant bank channel numbers are displayed.

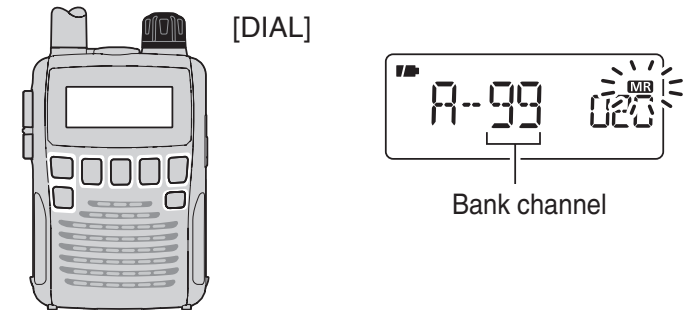

- ⑥ Hold down **[S.MW]**(V/M) for 1 second to assign the channel to the bank.
  - Return to the previous screen before entering the select memory write mode.

## 5 MEMORY CHANNELS

### Memory bank selection

- ① Push **[V/M]** to select the memory mode.
- ② While holding down **[BAND]**, rotate **[DIAL]** to select a desired bank.
  - The bank can also be selected by pushing **[BAND]** repeatedly.
  - Only banks with entries are displayed.

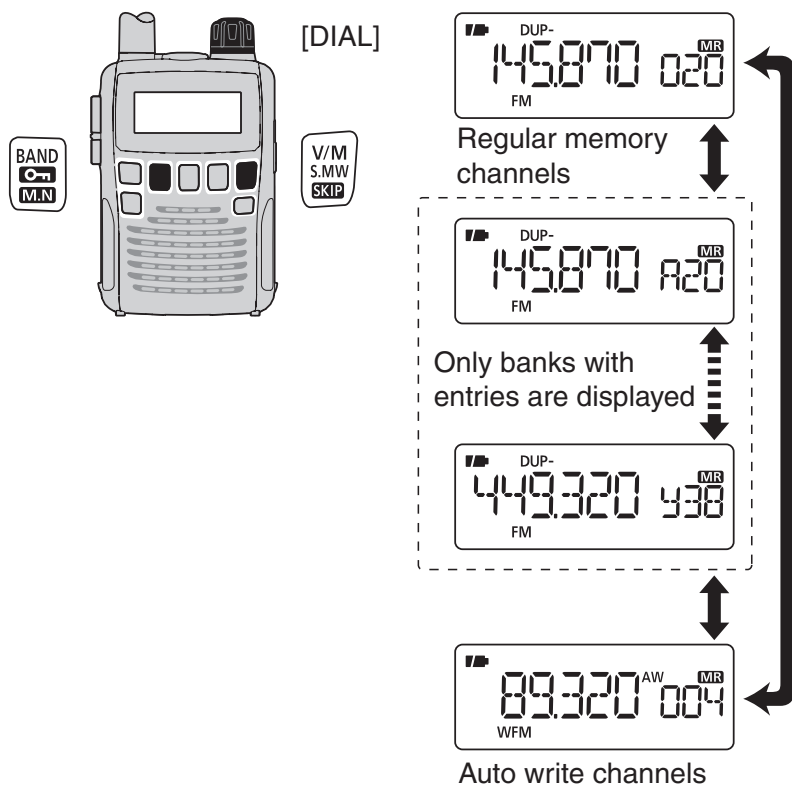

- ③ Rotate **[DIAL]** to select the bank channel.
  - Only programmed channels are displayed.

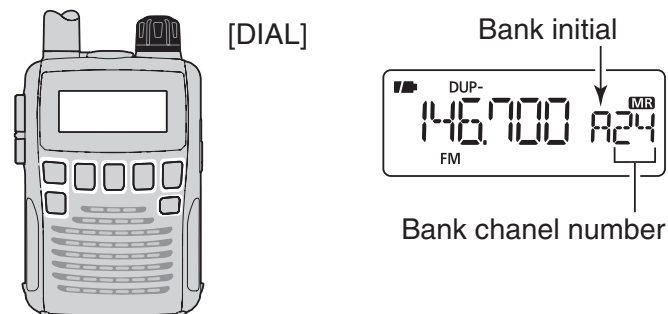

- ④ To return to a regular memory channel, rotate **[DIAL]** while holding down **[BAND]**, or repeatedly push **[BAND]**.

## ■ Programming memory/bank name

Each memory channel can be programmed with an alphanumeric channel name for easy recognition, and can be displayed independently by channel. Names can be a maximum of 6 characters.

- ① Push **[V/M]** to select the memory mode.
- ② Rotate **[DIAL]** to select a desired memory channel.
- ③ Hold down **[S.MW](V/M)** for 1 second to enter the select memory write mode.
  - 1 short and 1 long beep sound.
  - The “**MR**” icon and memory channel number blink.



- ④ While holding down **[MODE]**, rotate **[DIAL]** to select the “M NAME” or “B NAME” item when programming the memory name or the bank name, respectively.
  - The item can also be selected by pushing **[MODE]** repeatedly.

Memory name selection



Bank name selection



- After releasing **[MODE]**, a line blinks under the first digit, and the “**MR**” icon blinks.

- ⑤ While holding down **[FUNC]**, rotate **[DIAL]** to select a desired character.
  - The selected character blinks.
- ⑥ Rotate **[DIAL]** to move the cursor to the left or to the right.

Memory name

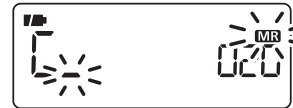

Bank name



- ⑦ Repeat steps ⑤ and ⑥ until a desired 6-character channel name is displayed.
- ⑧ Push **[MODE]** repeatedly, or rotate **[DIAL]** while holding down **[MODE]** to select the “S.MW” item.

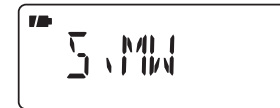

- ⑨ Hold down **[S.MW](V/M)** for 1 second to program the name and exit the programming mode.
  - 3 beeps sound.

### • Available characters

A to Z, 0 to 9, ( , ) , \* , + , - , , / , | , = and space.

**NOTE:** Only one bank name can be programmed into each bank. Therefore, the previously programmed bank name will be displayed when bank name is selected. Also, the programmed bank name is automatically assigned to another bank channel.

## 5 MEMORY CHANNELS

### ■ Selecting display type

During memory mode operation, either the programmed bank name, memory name or the channel number can be displayed instead of the frequency display.

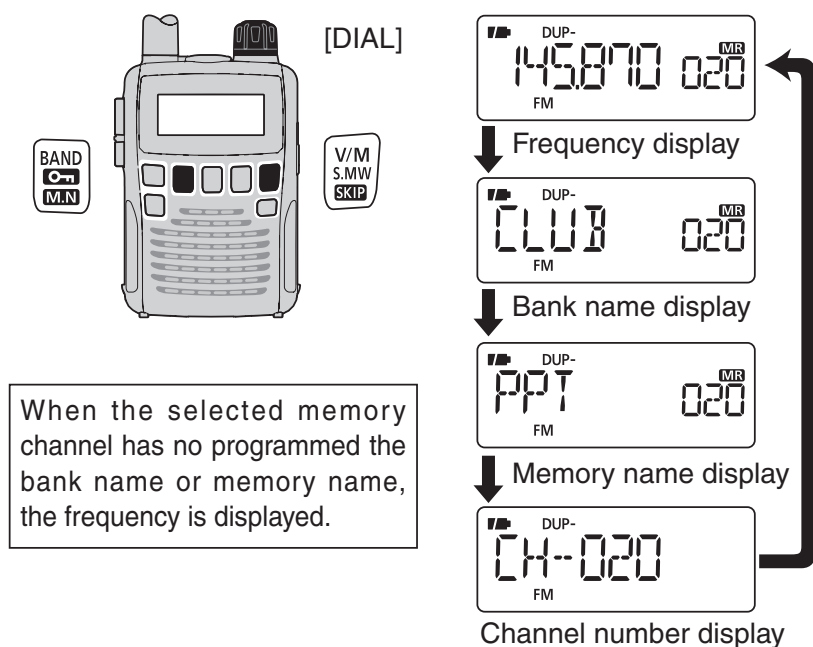

- ① Push **[V/M]** to select the memory mode.
  - If desired, push **[BAND]** repeatedly to select a desired bank group.
- ② While holding down **[FUNC]**, push **[BAND]** repeatedly to select the display type from frequency, bank name, memory name or the channel number.

### ◇ Selecting bank channel display

During bank channel operation, the bank channel number can also be displayed, instead of the memory channel number.

- ① Select the channel number display as described to the left.
- ② While holding down **[BAND]**, rotate **[DIAL]** to select a desired bank.
  - The bank can also be selected by pushing **[BAND]** repeatedly.

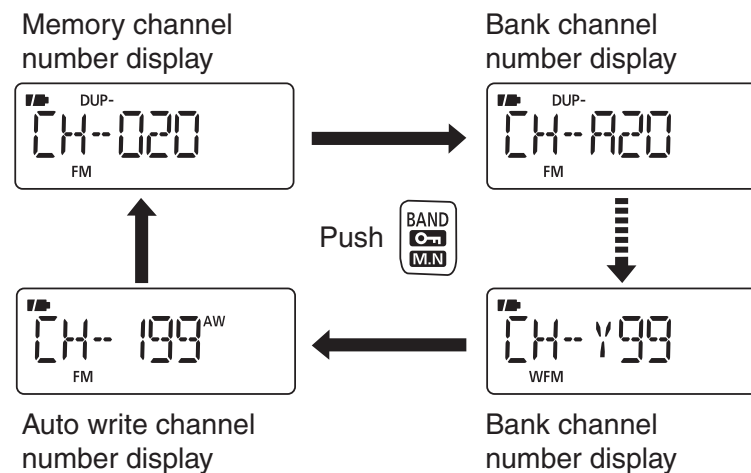

## ■ Copying memory contents

This function transfers a memory channel's contents to the VFO (or another memory channel). This is useful when searching for signals around a memory channel frequency and for recalling the frequency offset, subaudible tone frequency etc.

### ◇ Memory → VFO

- ① Select the memory channel to be copied.
  - ➔ Push **[V/M]** to select the memory mode, then rotate **[DIAL]** to select a desired channel.
    - If desired, push **[BAND]** repeatedly to select a desired bank group, then rotate **[DIAL]** to select a desired bank channel.
- ② Hold down **[S.MW](V/M)** for 1 second to enter the select memory write mode.
  - 1 short and 1 long beep sound.
  - The “**MR**” icon and memory channel number blink.
- ③ Rotate **[DIAL]** to select “VF.”
- ④ Hold down **[S.MW](V/M)** for 1 second to write the selected channel contents into the VFO.
  - Automatically returns to the VFO mode.

▨ Holding down **[S.MW](V/M)** for 2 seconds in step ② will also copy the memory contents to the VFO. In that case, steps ③ and ④ are not necessary.

### ◇ Memory → memory

- ① Select the memory channel to be copied.
  - ➔ Push **[V/M]** to select the memory mode, then rotate **[DIAL]** to select a desired channel.
- ② Hold down **[S.MW](V/M)** for 1 second to enter the select memory write mode.
  - 1 short and 1 long beep sound.
  - The “**MR**” icon and memory channel number blink.
  - Do not hold down **[S.MW](V/M)** for more than 2 seconds. Otherwise the memory contents will be copied to the VFO.
- ③ Rotate **[DIAL]** to select the target memory channel.
- ④ Hold down **[S.MW](V/M)** for 1 second again to copy.

**[EXAMPLE]:** Copying channel 20 to 51.

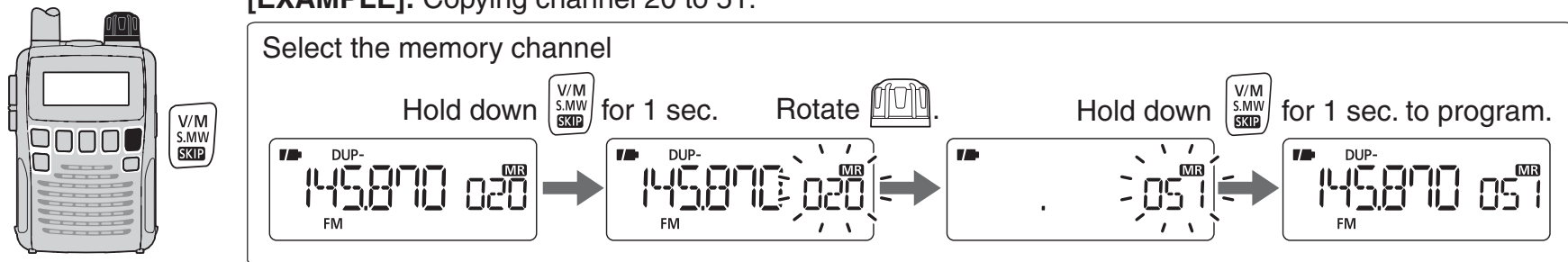

## 5 MEMORY CHANNELS

### ■ Memory clearing

Contents of programmed memories can be cleared (erased), if desired.

- ① Hold down **[S.MW]**(V/M) for 1 second to enter the select memory write mode.
  - 1 short and 1 long beep sounds.
  - The “**MR**” icon and memory channel number blink.
  - Do not hold down **[S.MW]**(V/M) for more than 2 seconds. Otherwise the memory contents will be copied to the VFO.
- ② Rotate **[DIAL]** to select a desired memory channel to be cleared.
- ③ While holding down **[MODE]**, rotate **[DIAL]** to select the “CLEAR” item.
  - The “CLEAR” item can also be selected by pushing **[MODE]** repeatedly.

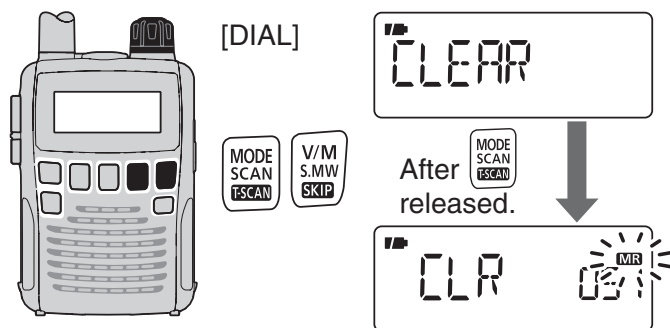

- After releasing **[MODE]**, “CLR” is displayed and the “**MR**” icon blinks.

- ④ Hold down **[S.MW]**(V/M) for 1 second to clear the contents.
  - 3 beeps sound.
  - The cleared channel changes to a blank channel.
  - Return to the select memory write mode.— The “**MR**” icon and memory channel number blink.

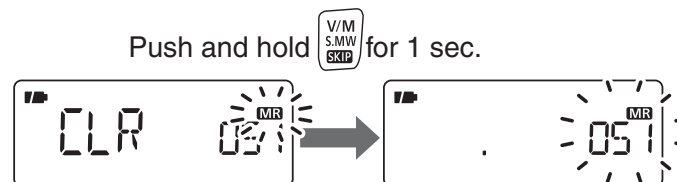

- ⑤ Push **[V/M]** to return to the screen displayed before you the select memory write mode in step ①.

After step ②, while holding down **[FUNC]**, push and hold **[S.MW]** (V/M) for 1 second can also be clear the contents. In that case, steps ③ and ④ are not necessary.

**BE CAREFUL!**— The contents of cleared memories **CANNOT** be recalled, even in the bank channel mode.

## ■ Transferring memory contents

The contents of programmed memory channels can be transferred to another memory channels.

- ① Hold down **[S.MW]**(V/M) for 1 second to enter the select memory write mode.
  - 1 short and 1 long beep sounds.
  - The “**MR**” icon and memory channel number blink.
  - Do not hold down **[S.MW]**(V/M) for more than 2 seconds. Otherwise the memory contents will be copied to the VFO.
- ② Rotate **[DIAL]** to select a desired memory channel to be transferred.
- ③ While holding down **[MODE]**, rotate **[DIAL]** to select the “CLEAR” item, then release **[MODE]**.
  - Pushing **[MODE]** repeatedly also selects the “CLEAR” item.
- ④ Hold down **[S.MW]**(V/M) for 1 second.
  - The displayed contents are cleared.

### /// **CONVENIENT!:**

Instead of doing steps ③ and ④, while holding down **[FUNC]**, push and hold **[S.MW]**(V/M) for 1 second also clears the contents.

- ⑤ Rotate **[DIAL]** to select a desired target memory channel.
- ⑥ Hold down **[S.MW]**(V/M) for 1 second to transfer the contents.

### • Example

Transferring the contents of memory channel 51 to channel 33.

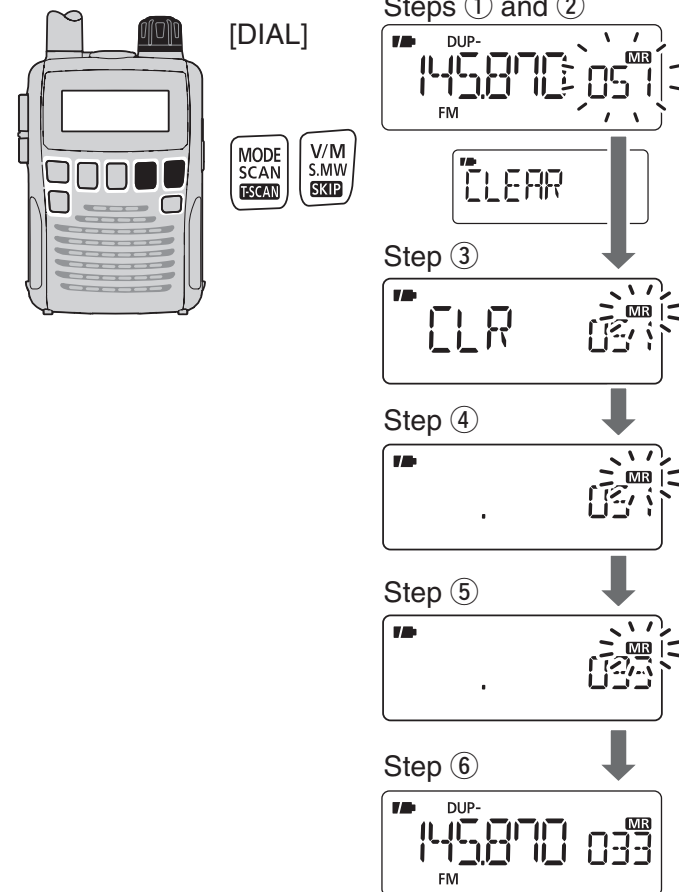

## 5 MEMORY CHANNELS

### Erasing/transferring bank contents

The contents of programmed memory channels can be erased or transferred to another memory.

**INFORMATION:** Even if the memory bank contents are erased, the memory channel contents still remain programmed.

- ① Select a desired bank contents to be transferred or erased from the bank.
  - ➔ Push **[V/M]** to select the memory mode.
  - ➔ While holding down **[BAND]**, rotate **[DIAL]** to select a desired memory bank group.
  - ➔ Rotate **[DIAL]** to select the bank channel.
- ② Hold down **[S.MW]**(V/M) for 1 second to enter the select memory write mode.
  - 1 short and 1 long beep sounds.
  - Do not hold down **[S.MW]**(V/M) for more than 2 seconds. Otherwise the bank contents will be copied to the VFO.

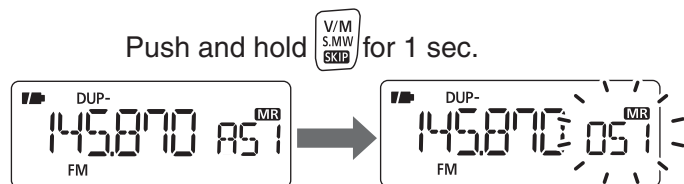

- The original memory channel number is automatically displayed, then the “**MR**” icon and the memory channel number blink.

- ③ While holding down **[MODE]**, rotate **[DIAL]** to select the “**BANK**” item.
  - Pushing **[MODE]** repeatedly also selects the “**BANK**” item.
- ④ While holding down **[BAND]**, rotate **[DIAL]** to select a desired bank group to transfer.
  - Select the “-- -- -- --” display when erasing the contents from the bank.

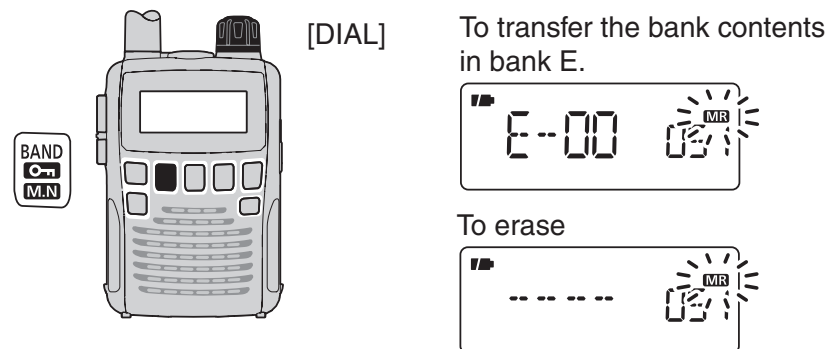

- ⑤ Rotate **[DIAL]** to select a desired bank channel.
- ⑥ While holding down **[MODE]**, rotate **[DIAL]** to select the “**S.MW**” item.
  - Pushing **[MODE]** repeatedly also selects the “**S.MW**” item.
- ⑦ Hold down **[S.MW]**(V/M) for 1 second to erase or transfer the bank contents.



## Scan types

Scanning automatically searches for signals and makes it easier to locate new stations for listening purposes.

There are 7 scan types and 4 resume options to suit your operating needs.

### FULL SCAN (p. 26)

Repeatedly scans all frequencies over the entire band.

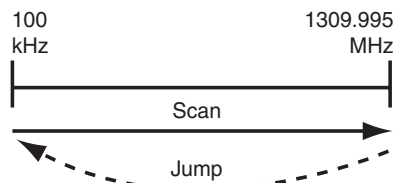

Some frequency ranges are not scanned, depending on the frequency coverage of the receiver version.

### SELECTED BAND SCAN (p. 26)

Repeatedly scans all frequencies over the entire selected band.

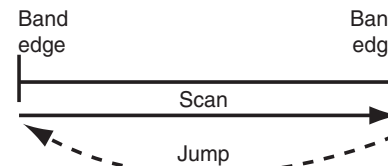

### PROGRAMMED SCAN (p. 26)

Repeatedly scans between two user-programmed frequencies. Used to check for frequencies within a specified range, such as repeater output frequencies, etc.

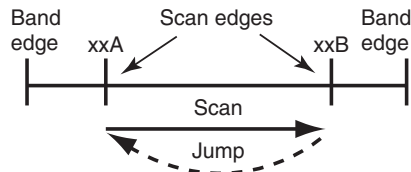

### MEMORY (SKIP) SCAN (p. 28)

Repeatedly scans memory channels, except those set as skip channels. Skip channels can be turned ON or OFF by pushing [FUNC] + [SKIP](V/M) in the memory mode.

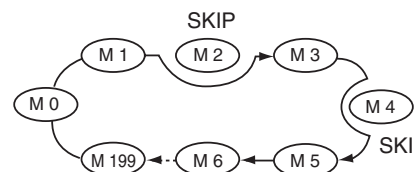

### ALL/SELECTED BANK SCAN (p. 28)

Repeatedly scans all bank channels or selected bank channels. The skip scan is also selectable.

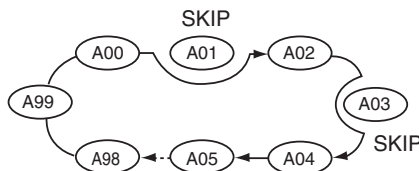

### FREQUENCY/MEMORY SKIP FUNCTION (p. 30)

Skips unwanted frequencies or channels that inconveniently stop scanning. This function can be turned ON or OFF by pushing [FUNC] + [SKIP](V/M) in either the VFO or the memory mode.

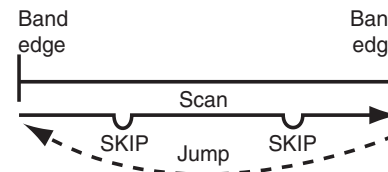

## 6 SCAN OPERATION

### ■ Full/band/programmed link/programmed scan

- ① Push **[V/M]** to select the VFO mode.
  - Push **[BAND]** to select a desired frequency band.
- ② Set the squelch level.
- ③ Hold down **[SCAN](MODE)** for 1 second to enter the scan type selection mode.
- ④ Rotate **[DIAL]** to select a desired scanning type.
  - Select "ALL" for full scan, "BAND" for band scan, "P-LINK x" for programmed link scan (x= 0 to 9), "PROGxx" for programmed scan (xx= 0 to 24; only programmed scan edge numbers are displayed).

- ⑤ To start the scan, push **[SCAN](MODE)**.
  - The scan pauses when a signal is received.
  - Rotate **[DIAL]** to change the scanning direction. This also resumes scanning.
  - Push **[SCAN](MODE)** again to stop the scan.

#### During full/band scan

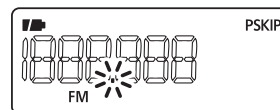

#### During programmed/ link program scan

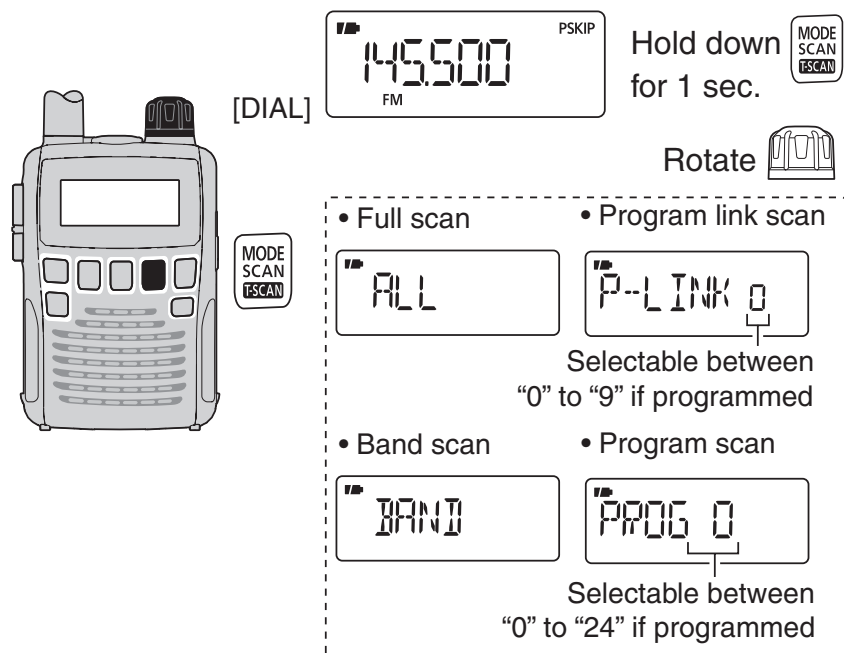
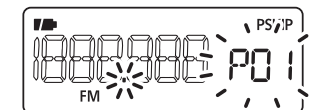

**NOTE:** Instead of doing steps ③ to ⑤, while holding down **[SCAN](MODE)**, rotate **[DIAL]** to select a desired scan type. In this case, the scan starts after releasing **[SCAN](MODE)**.

**About the scanning steps:** The VFO mode, the selected tuning step in each frequency band is used during the scan.

## ■ Scan edges programming

Scan edges can be programmed in the same manner as memory channels. Scan edges are programmed into scan edge memory channels, 00A/00B to 24A/24B.

- ① Push **[V/M]** to select the VFO mode.
- ② Set a desired frequency:
  - ➔ Push **[BAND]** to select a desired band.
  - ➔ Rotate **[DIAL]** to set a desired frequency.
  - ➔ Set other data (e.g. offset frequency, duplex direction, tone squelch, etc.), if desired.
- ③ Hold down **[S.MW]**(V/M) for 1 second to enter the select memory write mode.
  - 1 short and 1 long beep sounds.
  - The “**MR**” icon and memory channel number blink.

- ④ Rotate **[DIAL]** to select a desired programmed scan edge channel from 00A to 24A.
- ⑤ Hold down **[S.MW]**(V/M) for 1 second.
  - 3 beeps sound
  - The matched “B” channel is automatically selected when holding down **[S.MW]**(V/M) after programming.
- ⑥ To program a frequency for the other pair of scan edges, 00B or 24B, repeat steps ② and ④.
  - If the same frequency is programmed into a pair of scan edges, programmed scan will not function.

**[EXAMPLE]:** Programming 145.370 MHz into scan edge channel 03A (a blank channel).

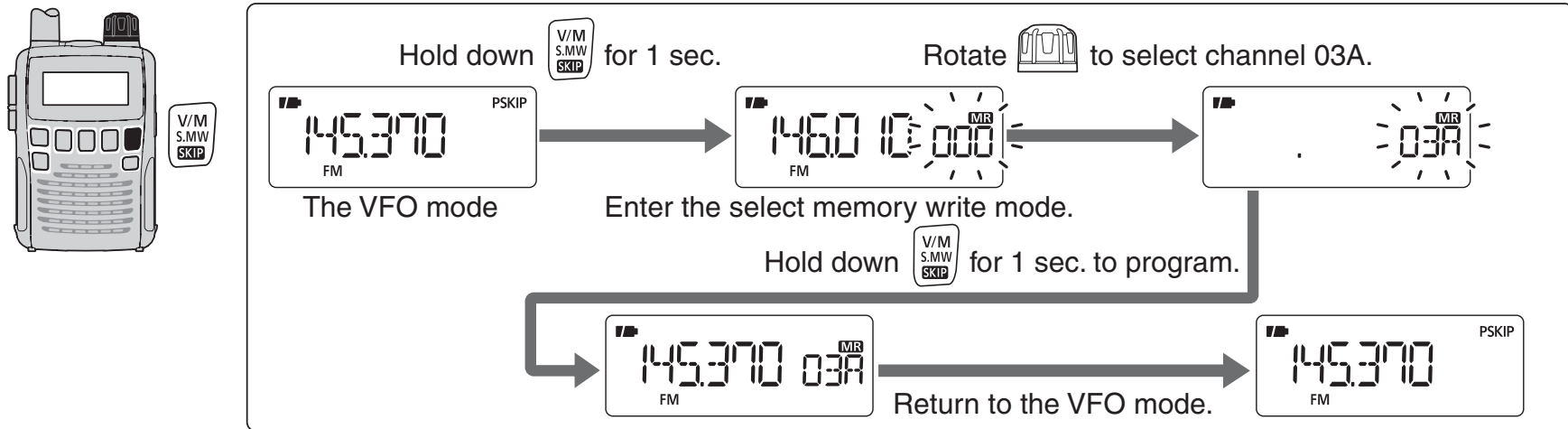

|    |
|----|
| 1  |
| 2  |
| 3  |
| 4  |
| 5  |
| 6  |
| 7  |
| 8  |
| 9  |
| 10 |
| 11 |
| 12 |
| 13 |
| 14 |
| 15 |
| 16 |

## 6 SCAN OPERATION

### Memory/all bank/bank link/bank scan

- ① Push [V/M] to select the memory mode.
- ② Set the squelch level.
- ③ Hold down [SCAN](MODE) for 1 second to enter the scan type selection mode.
- ④ Rotate [DIAL] to select a desired scanning type.
  - Select "M-ALL" for all memory scan, "B-ALL" for all bank scan, "B-LINK" for bank link scan or "BANK-x" for bank scan (x= A to R, T, U, W, Y; only programmed bank groups are displayed).

- Rotate [DIAL] to change the scanning direction. This also resumes scanning.
- Push [SCAN](MODE) again to stop the scan.

During memory/  
all bank/bank link scan

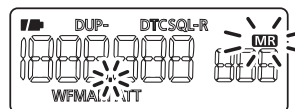

During bank scan

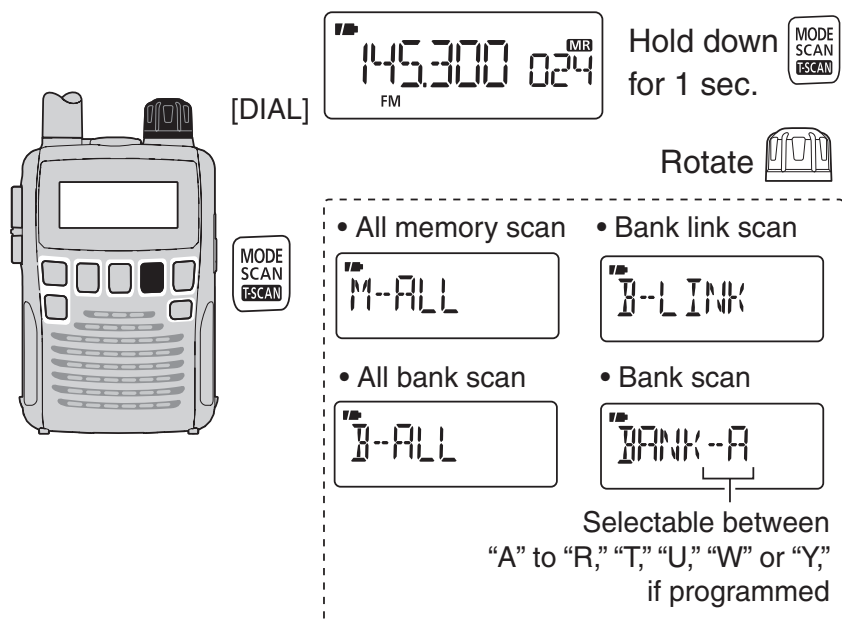
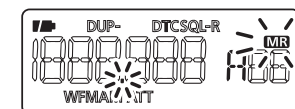

**IMPORTANT!** To perform a memory or bank scan, two or more memory/bank channels **MUST** be programmed, otherwise the scan will not start.

- ⑤ To start the scan, push [SCAN](MODE).
  - The scan pauses when a signal is received.

## ■ Auto memory write scan

This scan is useful for searching a specified frequency range, and automatically storing busy frequencies into memory channels. The same frequency ranges used for a program scan are used for an auto memory write scan.

- ① Start a VFO scan.
  - ➔ Push **[V/M]** to select the VFO mode.
  - ➔ Set the squelch level.
  - ➔ Hold down **[SCAN](MODE)** for 1 second to enter the scan type selection mode.
  - ➔ Rotate **[DIAL]** to select a desired scanning type.
    - Select “ALL” for full scan, “BAND” for band scan, “P-LINK x” for programmed link scan (x= 0 to 9), “PROGxx” for programmed scan (xx= 0 to 24; only programmed scan edge numbers are displayed).
  - ➔ Push **[SCAN](MODE)** to start the scan.
- ② Push **[V/M]** to turn the auto memory write function ON or OFF.
  - The “**MR**” icon blinks.
  - Push **[SCAN](MODE)** to stop the scan.

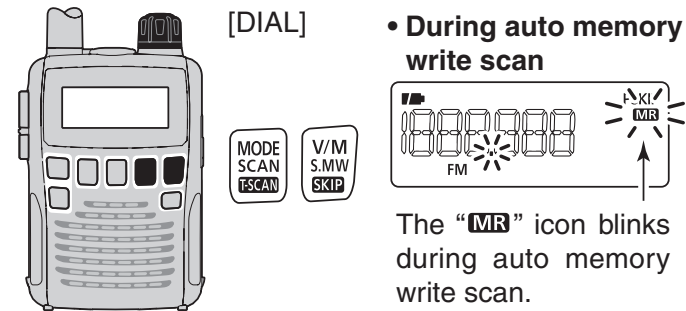

## 6 SCAN OPERATION

### ◇ During auto memory write scanning:

- When a signal is received, the scan pauses and the frequency is stored into an auto memory write channel group (<sup>AW</sup>000–<sup>AW</sup>199).
  - 2 short beeps sound when stored.
- Scan resumes after frequency storing.
- When all channels are stored, the scan automatically stops and 1 long beep sounds.

### ◇ Re-calling the stored frequencies:

- ① Push [**V/M**] to select the memory mode.
- ② Push [**BAND**] repeatedly, or while holding down [**BAND**], rotate [**DIAL**], to select the auto memory write channel group.
  - “AW” appears.
- ③ Rotate [**DIAL**] to select a desired channel.



“AW” appears when the auto memory write channel group is selected.

### ◇ Clearing the stored frequencies:

- ① Select the auto memory write channel group.
- ② While holding down [**FUNC**], push and hold [**S.MW**](V/M) for 1 second to clear the all channels contents.
  - 1 short and 1 long beep sounds.

**NOTE:** The auto memory write channel contents CANNOT be cleared by an independent channel. Thus it is good idea to copy the contents into a regular memory channel.

## ■ Skip channel/frequency setting

Memory channels can be set to be skipped for a memory skip scan. In addition, memory channels can be set to be skipped for both a memory skip scan and a frequency skip scan. These are useful to speed up the scan time.

- ① Select a memory channel:
  - ➔ Push **[V/M]** to select the memory mode.
  - ➔ Rotate **[DIAL]** to select a desired channel to be a skip channel/frequency.
- ② Hold down **[S.MW]**(V/M) for 1 second to enter the select memory write mode.
- ③ Push **[MODE]** repeatedly to select the “SKIP” item.
  - While holding down **[MODE]**, rotating **[DIAL]** can also select the “SKIP” item.

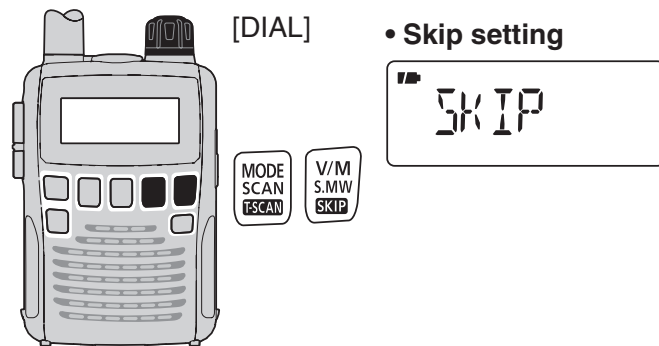

- ④ While holding down **[FUNC]**, rotate **[DIAL]** to select the skip option from “SKIP,” “PSKIP” or “OFF,” for the selected channel.
  - SKIP : The channel is skipped during a memory or bank scan.
  - PSKIP : The channel is skipped during a memory/bank scan. The programmed frequency is skipped during a VFO scan, such as a programmed scan.
  - OFF : The channel or programmed frequency is scanned during any scan.
- ⑤ Push **[MODE]** repeatedly, or while holding down **[MODE]**, rotate **[DIAL]** to select the “S.MW” item.
- ⑥ Hold down **[S.MW]**(V/M) for 1 second to store the skip status.
  - The “SKIP” or “PSKIP” icon appears, according to the skip selection in step ④.

• Skip channel setting

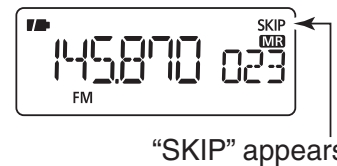

• Program skip setting

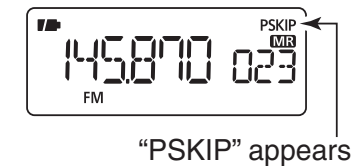

✓ **CONVENIENT!**

The skip setting can also be set using the following steps, for easy setting.

- ① Select a desired memory channel to be set as a skip channel/frequency.
- ② While holding down **[FUNC]**, push **[SKIP]**(V/M) to select the skip status from “SKIP,” “PSKIP” and “OFF (no indication).”

## 6 SCAN OPERATION

### ■ Scan resume setting

#### ◇ Scan pause timer

The scan pauses when receiving signals according to the scan pause time. It can be set from 2–20 seconds, or unlimited.

- ① Hold down **[SET]**(TS) for 1 second to enter the Set mode.
- ② Rotate **[DIAL]** to select the “EXPAND” item.
- ③ While holding down **[FUNC]**, rotate **[DIAL]** to turn the Expand set mode selection ON.
- ④ Rotate **[DIAL]** to select the “PAUSE” item.
- ⑤ While holding down **[FUNC]**, rotate **[DIAL]** to set a desired scan pausing time from 2–20 seconds (2 seconds steps) or “HOLD.”
  - “2SEC”–“20SEC”: Scan pauses 2–20 seconds while receiving a signal.
  - “HOLD” : Scan pauses on a received a signal until it disappears.
- ⑥ Push **[SET]**(TS) to exit the Set mode.

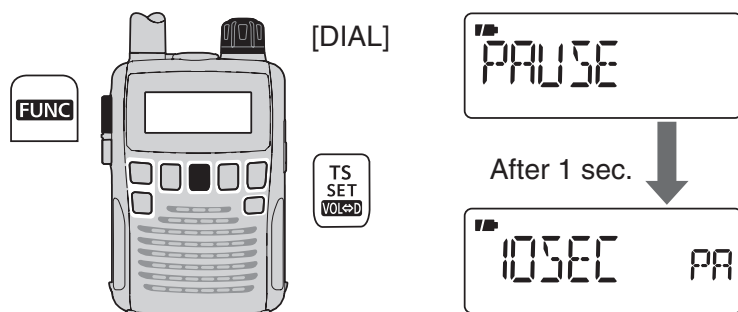

#### USING EXPAND SET MODE

#### ◇ Scan resume timer

The scan resumes after a signal disappears according to the resume time. It can be set from 0–5 seconds, or unlimited.

- ① Hold down **[SET]**(TS) for 1 second to enter the Set mode.
- ② Rotate **[DIAL]** to select the “EXPAND” item.
- ③ While holding down **[FUNC]**, rotate **[DIAL]** to turn the Expand set mode selection ON.
- ④ Rotate **[DIAL]** to select the “RESUME” item.
- ⑤ While holding down **[FUNC]**, rotate **[DIAL]** to set a desired scan pausing time from 0–5 seconds (1 second steps) or “HOLD.”
  - “0SEC” : Scan resumes immediately after the signal disappears.
  - “1SEC”–“5SEC” : Scan resumes 1–5 seconds after the signal disappears.
  - “HOLD” : Scan resumes by rotating **[DIAL]** only.
- ⑥ Push **[SET]**(TS) to exit the Set mode.

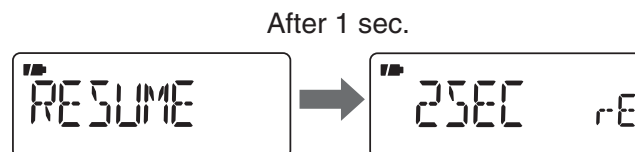

/// The scan resume timer must be set shorter than the scan pause timer, otherwise this timer will not be activated.



## Priority watch types

Priority watch checks for signals on a frequency every 5 seconds, while operating on a VFO frequency or scanning. The receiver has four priority watch types to suit your needs.

The watch resumes according to the selected scan resume setting. See the left page for details.

**NOTE:**  
If the pocket beep function is activated, the receiver automatically selects the tone squelch or DTCS squelch function, when priority watch starts.

◇ **About the priority beep function**  
When receiving a signal on the priority frequency, you can be alerted with beeps and a blinking “((•))”. This function is activated when setting the priority watch function ON.

**MEMORY CHANNEL WATCH**  
While operating on a VFO frequency, priority watch checks for a signal on the selected memory channel every 5 seconds.

- A memory channel with skip information can be watched.

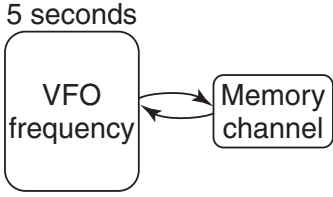

**MEMORY SCAN WATCH**  
While operating on a VFO frequency, priority watch sequentially checks for signals on each memory channel.

- The memory skip function and/or memory bank scan is useful to speed up the scan.

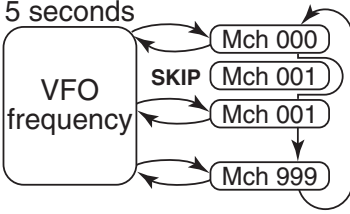

**VFO SCAN WATCH**  
While scanning in the VFO mode, priority watch checks for signals on the selected memory channel every 5 seconds.

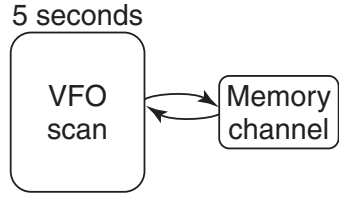

**VFO SCAN WATCH**  
While scanning in the VFO mode, priority watch sequentially checks for signals on each memory channel every 5 seconds.

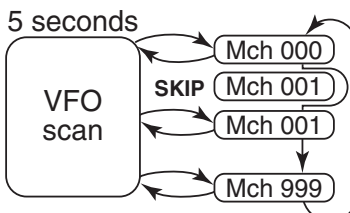

## Priority watch operation

### Memory channel/memory scan watch

- ① Select the VFO mode; then, set an operating frequency.
- ② Select the channel(s) to be watched.
  - For memory channel watch:**  
Select a desired memory channel.
  - For memory scan watch:**
    - ➔ Push **[V/M]** to select the memory mode.
    - ➔ Hold down **[SCAN](MODE)** for 1 second to enter the scan type selection mode.
    - ➔ Rotate **[DIAL]** to select a desired scan type, then push **[SCAN](H/M/L)** again to start the memory/bank scan.
- ③ Hold down **[SET](TS)** for 1 second to enter the Set mode.
- ④ Rotate **[DIAL]** to select the priority watch set item.
- ⑤ While holding down **[FUNC]**, rotate **[DIAL]** to select "ON."
  - Select "BELL" if the priority beep function is desired.

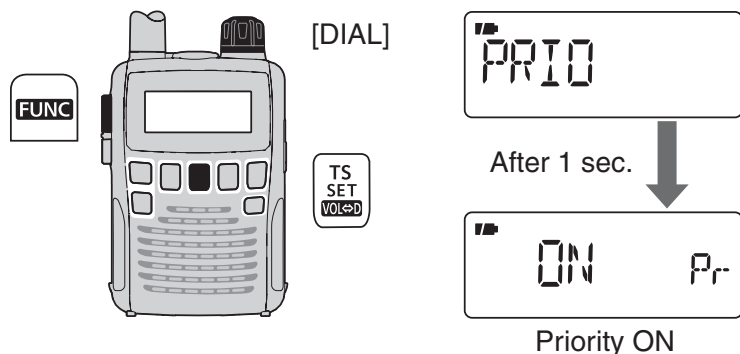

- ⑥ Push **[TS]** to exit the Set mode and start the watch.
  - The "PRIO" icon appears.
  - The receiver checks the memory/bank channel(s) every 5 seconds.
  - The watch resumes according to the selected scan resume setting. (p. 31)

#### During priority watch



Monitors VFO frequency for 5 seconds.



Pauses on a memory channel when a signal is received.

#### During priority watch with the priority beep



A beep tone sounds and "((.))" icon blinks when a signal is received on a memory channel.



- ⑦ Push **[SET](TS)** to cancel the watch.

◇ VFO scan watch

- ① Select the channel(s) to be watched.
  - For memory channel watch:**  
Select a desired memory channel.
  - For memory scan watch:**
    - ➔ Push [V/M] to select the memory mode.
    - ➔ Hold down [SCAN](MODE) for 1 second to enter the scan type selection mode.
    - ➔ Rotate [DIAL] to select a desired scan type, then push [SCAN](H/M/L) again to start the memory/bank scan.
- ② Hold down [SET](TS) for 1 second to enter the Set mode.
- ③ Rotate [DIAL] to select the priority watch set item.
- ④ While holding down [FUNC], rotate [DIAL] to select "ON."
  - Select "BELL" if the priority beep function is desired.

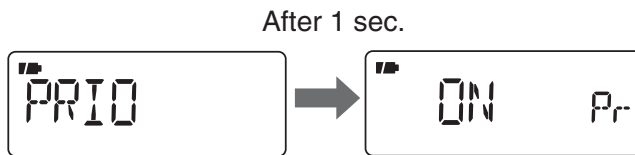

- ⑤ Push [SET](TS) to exit the Set mode and start the watch.
  - The "PRIO" icon appears.
- ⑥ Hold down [SCAN](MODE) for 1 second to enter scan type selection mode.
- ⑦ Rotate [DIAL] to select a desired scan type from "ALL," "BAND," "P-LINK x (x= 0 to 9)" or "PROGxx (xx= 0-24)."

- ⑧ Push [SCAN](MODE) to start the VFO scan watch.
  - The receiver checks the memory channel(s) every 5 seconds.
  - The watch resumes according to the selected scan resume setting. (p. 31)

**During VFO watch**

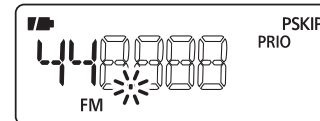

Searches VFO frequencies for 5 seconds.



Pauses on a memory channel when a signal is received.

**During VFO scan watch with the priority beep**

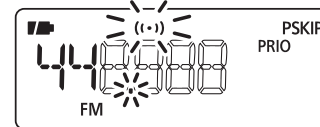

A beep tone sounds and "((.))" icon blinks when a signal is received on a memory channel.



- ⑨ Push [TS] to cancel the watch and scan.

# 8

## 8 TONE SQUELCH AND POCKET BEEP

### ■ Tone/DTCS squelch operation

The tone or DTCS squelch opens only when receiving a signal with the same pre-programmed subaudible tone or DTCS code, respectively. You can silently wait for the specified signal using the same tone.

- ① Set a desired frequency in the FM mode.
- ② Hold down **[SET](TS)** for 1 second to enter the Set mode.
- ③ Rotate **[DIAL]** to select the “EXPAND” item.
- ④ While holding down **[FUNC]**, rotate **[DIAL]** to turn the Expand set mode ON.
- ⑤ Rotate **[DIAL]** to select the “TSQL” item.
- ⑥ While holding down **[FUNC]**, rotate **[DIAL]** to select a desired subaudible tone setting from “TSQL ((·)),” “TSQL,” “DTCS,” “DTCS ((·)),” “TSQL (reverse),” “DTCS (reverse)” or “OFF.”



Tone squelch with pocket beep



DTCS squelch



Tone squelch



Tone squelch (reverse)

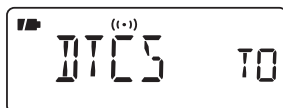

DTCS squelch with pocket beep



DTCS squelch (reverse)

- ⑦ Push **[SET](TS)** to exit the Set mode.
  - One of “((·)) T SQL,” “T SQL,” “((·)) DTCS,” “DTCS,” “T SQL-R” or “DTCS -R” appears according to the tone selection in step ⑥.

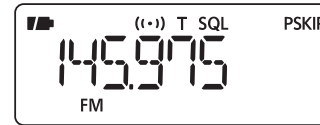

Tone squelch with pocket beep



DTCS squelch

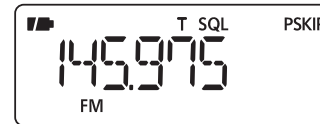

Tone squelch

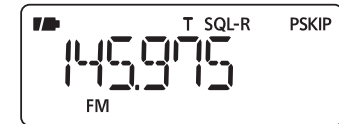

Tone squelch (reverse)

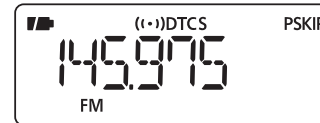

DTCS squelch with pocket beep



DTCS squelch (reverse)

- ⑧ When a signal with the matched tone is received, the squelch opens and the receiver emits audio. When pocket beep function is activated, the receiver also emits beep tones and blinks “((·)).”
  - Beep tones sound and “((·))” blinks for 30 seconds.
- ⑨ Push **[FUNC]** to stop the beeps and blinking manually.
  - “((·))” disappears and the pocket beep function is deactivated.
- ⑩ To cancel the tone squelch or DTCS, select “OFF” with the “TSQL” item in the Expand set mode, as described in step ⑥.

## ■ Tone squelch frequency/DTCS code setting

88.5 Hz and 023 is set as the default for the tone squelch frequency and the DTCS code, respectively. The frequency and code can be selected as desired.

- ① Hold down **[SET]**(TS) for 1 second to enter the Set mode.
- ② Rotate **[DIAL]** to select the “EXPAND” item.
- ③ While holding down **[FUNC]**, rotate **[DIAL]** to turn the Expand set mode ON.
- ④ Rotate **[DIAL]** to select the “TONE” item when selecting the tone squelch frequency; select the “CODE” item when selecting the DTCS code.

Tone squelch frequency selection



DTCS code selection



- ⑤ While holding down **[FUNC]**, rotate **[DIAL]** to select a desired subaudible tone frequency or DTCS code.
  - See the tables at right.
- ⑥ Push **[SET]**(TS) to exit the Set mode.

### • Available tone frequency list

|      |      |       |       |       |       |       |       |       |       |
|------|------|-------|-------|-------|-------|-------|-------|-------|-------|
| 67.0 | 79.7 | 94.8  | 110.9 | 131.8 | 156.7 | 171.3 | 186.2 | 203.5 | 229.1 |
| 69.3 | 82.5 | 97.4  | 114.8 | 136.5 | 159.8 | 173.8 | 189.9 | 206.5 | 233.6 |
| 71.9 | 85.4 | 100.0 | 118.8 | 141.3 | 162.2 | 177.3 | 192.8 | 210.7 | 241.8 |
| 74.4 | 88.5 | 103.5 | 123.0 | 146.2 | 165.5 | 179.9 | 196.6 | 218.1 | 250.3 |
| 77.0 | 91.5 | 107.2 | 127.3 | 151.4 | 167.9 | 183.5 | 199.5 | 225.7 | 254.1 |

**NOTE:** The receiver has 50 tone frequencies and consequently their spacing is narrow compared to units having 38 tones. Therefore, some tone frequencies may receive interference from adjacent tone frequencies.

### • Available DTCS code list

|     |     |     |     |     |     |     |     |     |     |     |
|-----|-----|-----|-----|-----|-----|-----|-----|-----|-----|-----|
| 023 | 054 | 125 | 165 | 245 | 274 | 356 | 445 | 506 | 627 | 732 |
| 025 | 065 | 131 | 172 | 246 | 306 | 364 | 446 | 516 | 631 | 734 |
| 026 | 071 | 132 | 174 | 251 | 311 | 365 | 452 | 523 | 632 | 743 |
| 031 | 072 | 134 | 205 | 252 | 315 | 371 | 454 | 526 | 654 | 754 |
| 032 | 073 | 143 | 212 | 255 | 325 | 411 | 455 | 532 | 662 |     |
| 036 | 074 | 145 | 223 | 261 | 331 | 412 | 462 | 546 | 664 |     |
| 043 | 114 | 152 | 225 | 263 | 332 | 413 | 464 | 565 | 703 |     |
| 047 | 115 | 155 | 226 | 265 | 343 | 423 | 465 | 606 | 712 |     |
| 051 | 116 | 156 | 243 | 266 | 346 | 431 | 466 | 612 | 723 |     |
| 053 | 122 | 162 | 244 | 271 | 351 | 432 | 503 | 624 | 731 |     |

## 8 TONE SQUELCH AND POCKET BEEP

### ■ DTCS polarity setting

As well as the code setting, the polarity setting is also available for the DTCS operation. When a different polarity is set, the DTCS never releases audio mute even a signal with matched code number is received.

- ① Hold down **[SET]**(TS) for 1 second to enter the Set mode.
- ② Rotate **[DIAL]** to select the “EXPAND” item.
- ③ While holding down **[FUNC]**, rotate **[DIAL]** to turn the Expand set mode ON.
- ④ Rotate **[DIAL]** to select the “DTCS P” item.

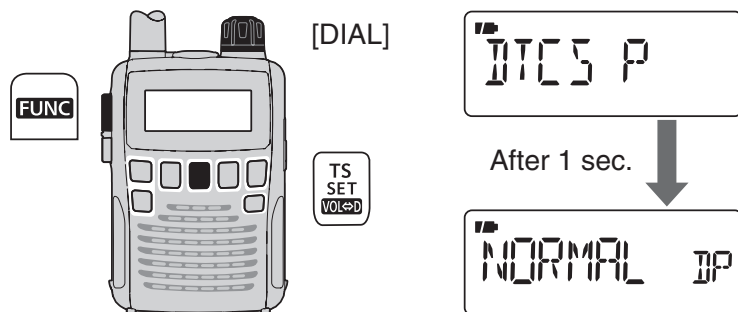

- ⑤ While holding down **[FUNC]**, rotate **[DIAL]** to select the polarity from normal (NORMAL) and reverse (REV).



Normal polarity



Reverse polarity

- ⑥ Push **[SET]**(TS) to exit the Set mode.

## ■ Tone scan

By monitoring a signal that is being operated with pocket beep, tone or DTCS squelch function, you can determine the tone frequency or DTCS code necessary to open a squelch.

- ① Set the frequency to be checked for a tone frequency or code.
- ② Turn a desired tone type, tone squelch or DTCS ON in the Expand set mode.
  - One of “TSQL” or “DTCS” appears.
  - Even the pocket beep function is activated, the function is cancelled when starts the tone scan.
- ③ While holding down [FUNC], push [FSCAN](MODE) to start the tone scan.
  - To change the scanning direction, rotate [DIAL].

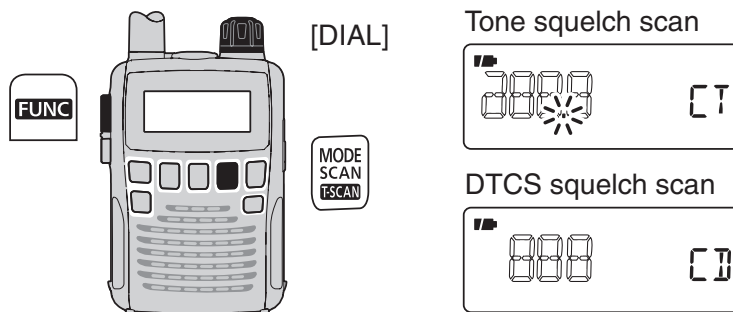

- ④ When the CTCSS tone frequency or 3-digit DTCS code is matched, the squelch opens and the tone frequency or code is temporarily programmed into the selected condition, such as memory channel.
  - The tone scan pauses when a CTCSS tone frequency or 3-digit DTCS code is detected.

**NOTE:** The decoded tone frequency or code is programmed temporarily when a memory channel is selected. However, this will be cleared when the other memory channel is selected.

### ✓ *For your convenient!*

Even no tone type is selected, either tone squelch or DTCS, pushing [FSCAN](MODE) while holding down [FUNC] also start tone scan. In this case, the tone scan searching for tone squelch frequency only.

## ■ General

Set mode is used for programming infrequently changed values or options of the functions.

In addition, the IC-R6 has the Expand set mode which is used for programming even more infrequently changed values or options of the functions. When turning the Expand set mode OFF, only half of the Set mode items are displayed for simple operation.

### ◇ Set mode entering and operation

- ① Hold down **[SET]**(TS) for 1 second to enter the Set mode.
- ② Rotate **[DIAL]** to select a desired item.
- ③ While holding down **[FUNC]**, rotate **[DIAL]** to select a desired value or option.
- ④ Push **[SET]**(TS) to exit the Set mode, or repeat ② and ③ to set other items.



### ◇ Expand set mode ON/OFF

- ① Hold down **[SET]**(TS) for 1 second to enter the Set mode.
- ② Rotate **[DIAL]** to select the "EXPAND" item.



- ③ While holding down **[FUNC]**, rotate **[DIAL]** to turn the Expand set mode ON or OFF.



Expand set mode OFF



Expand set mode ON

- ④ Rotate **[DIAL]** to select a desired item.
- ⑤ While holding down **[FUNC]**, rotate **[DIAL]** to select a desired value or option.
- ⑥ Push **[SET]**(TS) to exit the Set mode, or repeat ④ and ⑤ to set other items.



## ■ Set mode items

The following items are available in the Set mode and the Expand set mode.

### ◇ General Set mode items

\*Appears when accessing the Set mode in only the AM or FM broadcast band mode.

| Guide  | Item name            | Ref. |
|--------|----------------------|------|
| D SEL  | Dial select step     | ??   |
| PRIO   | Priority watch       | ??   |
| BEEP   | Key-touch beep       | ??   |
| BEEPLV | Beep output level    | ??   |
| LIGHT  | Display backlighting | ??   |
| P SAVE | Power save           | ??   |
| ANT*   | Antenna selection    | ??   |
| EXPAND | Expand set mode      | ??   |

### ◇ Expand set mode items

| Guide               | Item name               | Ref. |
|---------------------|-------------------------|------|
| LOCK                | Key lock effect         | ??   |
| SPEED               | Dial speed acceleration | ??   |
| MONI                | Monitor switch action   | ??   |
| AP OFF              | Auto power OFF          | ??   |
| PAUSE               | Scan pause timer        | ??   |
| RESUME              | Scan resume timer       | ??   |
| STOP B              | Scan stop beep          | ??   |
| OFFSET              | Frequency offset        | ??   |
| DUP                 | Duplex direction        | ??   |
| TSQL                | Tone squelch            | ??   |
| TONE                | Tone frequency          | ??   |
| CODE                | DTCS code               | ??   |
| DTCS P              | DTCS polarity           | ??   |
| VSC                 | Voice squelch control   | ??   |
| B-LINK              | Band link               | ??   |
| P-LINK              | Program link            | ??   |
| CONT                | LCD contrast            | ??   |
| WX ALT <sup>†</sup> | Weather alert           | ??   |
| AF FIL              | AF filter               | ??   |
| CHARGE              | Charge                  | ??   |
| CIVADR              | CI-V address            | ??   |
| CIVBAU              | CI-V baud rate          | ??   |
| CIVTRN              | CI-V transceive         | ??   |

<sup>†</sup>Available in only the USA version.

## 9 SET MODE

### ◇ Dial select step

Select the tuning step between 100 kHz, 1 MHz (default) and 10 MHz for a temporary faster frequency setting. When setting a frequency with the increased tuning step, hold down [FUNC], and then rotate [DIAL].

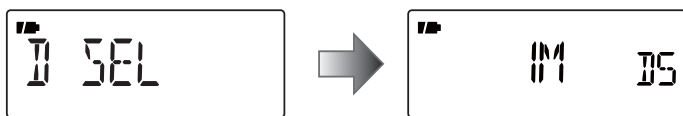

### ◇ Priority watch

Turn the priority watch or priority beep (priority watch with beep sounds) ON. (default: OFF)

- OFF : Turns the function OFF.
- ON : Starts priority watch after exiting the Set mode.
- BELL : When a signal is received on the priority frequency, beeps sound and the ((\*)) icon blinks.

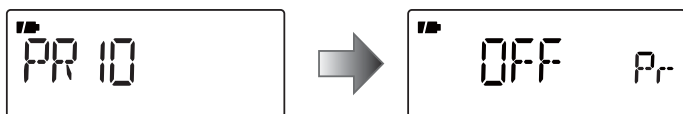

### ◇ Key-touch beep

The key-touch beep can be turned OFF for silent operation. (default: ON)

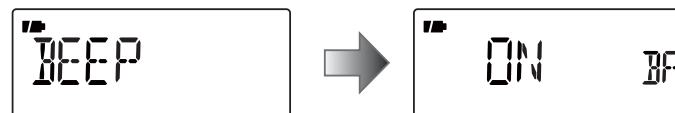

### ◇ Beep output level

Adjust the key-touch beep tone level to one of 32 set levels, or set it to follow the volume control level.

- VOLUME : The beep tone level is linked to the volume set level. (default)
- \_\_\_\_\_ - 000 000 : The beep tone level is independently adjustable at one of 32 levels.

▨ The key-touch beep (previous item) must be set to ON to have a beep tone.

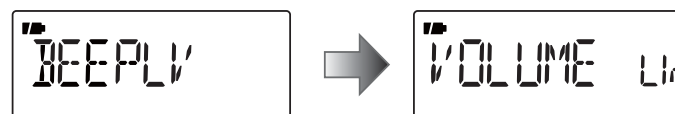

◇ **Display backlighting**

The receiver has a backlit display with a 5 seconds timer, for dim light operation. The backlighting can be turned ON continuously or turned OFF, if desired.

- OFF : Never lights.
- ON : Lights continuously while receiver power is ON.
- AUTO1: Lights when an operation is performed, goes out after 5 seconds. (default)
- AUTO2: Lights when an operation is performed, goes out after 5 seconds. However, while operating with an external DC power source, the backlight stays ON.

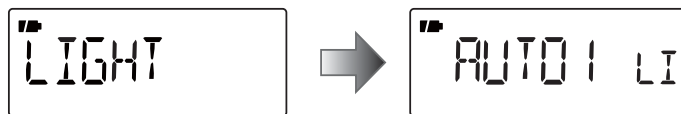

◇ **Power save**

The power save function reduces the current drain to conserve battery power. This power save function can be turned OFF, if desired.

In the default setting (“ON”), the power save function is activated in 1:4 (125 msec.: 500 msec.) ratio when no signal is received for 5 seconds. The ratio becomes 1:8 (125 msec.: 1 sec.) when no signal is received for another 60 seconds.

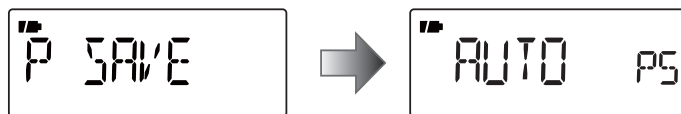

◇ **Antenna selection**

▨ This item appears only when accessing the Set mode in the AM or FM broadcast band mode (frequencies may differ, depending on the receiver version.)

Independently select the antenna to use for AM or FM broadcast band reception.

- EXT : Uses the antenna connected to the antenna connector. (default)
- BAR : Uses the internal bar antenna for the AM broadcast band reception. (This selection appears only when accessing the Set mode in the AM broadcast band mode.)
- EAR : Uses the connected earphone’s wire as the antenna for FM broadcast band reception. (This selection appears only when accessing the Set mode in the FM broadcast band mode.)

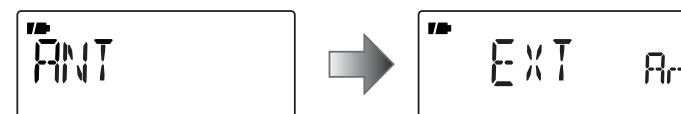

## 9 SET MODE

### ◇ Expand set mode

Turn the Expand set mode ON or OFF.

- OFF : Displays only the regular set mode. (default)
- ON : Displays the regular set mode and the expand set mode.

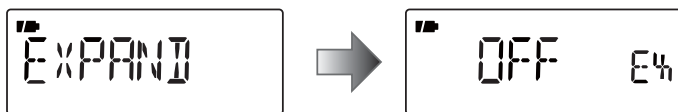

### ◇ Key lock effect

Even while the key lock function is ON, [▲]/[▼] and [SQL] can still be usable. Usable switches can be set to one of 4 groups.

[⏻] and [FUNC]+[📶](BAND) are also usable during the locked state, however, these switches are not effected by this setting.

- NORMAL : [▲]/[▼] and [SQL] are accessible. (default)
- NO SQL : [SQL] is accessible. (The function of [SQL] is not locked.)\*
- NO VOL : [▲]/[▼] are accessible. (The function of [▲]/[▼] is not locked.)\*
- ALL : No key function is usable, except [⏻] and [FUNC]+[📶](BAND).

\*"NO" indicates no lock on the function.

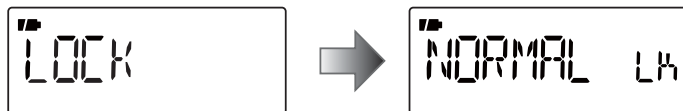

### ◇ Dial speed acceleration

The dial speed acceleration automatically speeds up the tuning dial speed, when rotating [DIAL] rapidly.

- OFF : The dial speed acceleration is turned OFF.
- ON : The dial speed acceleration is tuned ON. (default)

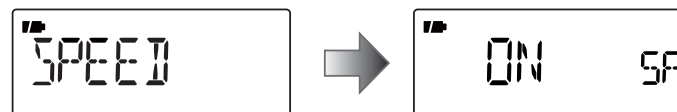

### ◇ Monitor switch action

The monitor switch, [SQL], can be set as a 'sticky' switch. When set to the sticky condition, each push of [SQL] toggles the monitor function ON or OFF.

- PUSH : Pushing and holding [SQL] to monitor the frequency. (default)
- HOLD : Push [SQL] momentarily to monitor the frequency and push momentarily again to cancel it.

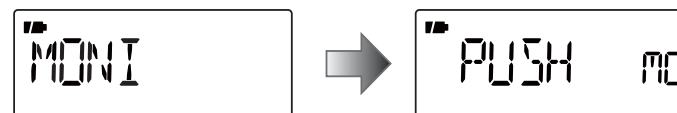

### ◇ Auto power OFF

The receiver can be set to automatically turn OFF, and sound a beep, after a specified period when no key operations are performed.

OFF (default), times of 30 minutes, 1 hour, 1.5 hours, 2 hours and BUSY can be specified. The (repetitive) period is retained even when the receiver is turned OFF, even by the auto power OFF function. To cancel the function, select "OFF".

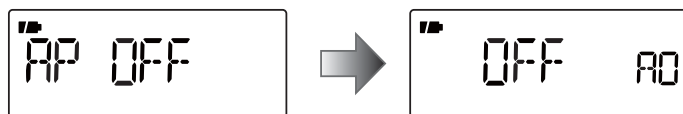

### ◇ Scan pause timer

Selects the scan pause time. When receiving signals, the scan pauses according to the scan pause time.

- 2-20 : The scan pauses for 2-20 seconds on a received signal, and is selected in 2 second steps. (default: 10 seconds)
- HOLD : The scan pauses on a received signal until it disappears. Rotate [DIAL] to resume manually.

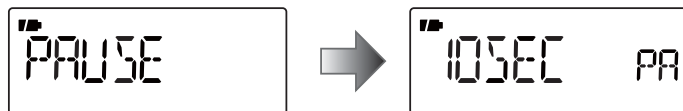

### ◇ Scan resume timer

Selects the scan resume time. The scan resumes after the specified period after the received signal disappears.

- 0 : The scan resumes immediately after the received signal disappears.
- 1-5 : The scan pause 1-5 seconds after the received signal disappears. (default: 2 seconds)
- HOLD : The scan pauses on the received signal, even if it disappears. Rotate [DIAL] to resume manually.

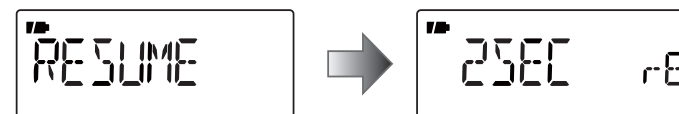

### ◇ Scan stop beep

Turns the scan stop beep function ON or OFF (default). When the function is activated ("ON" is selected), a long beep will sound each time when signal is received during a scan.

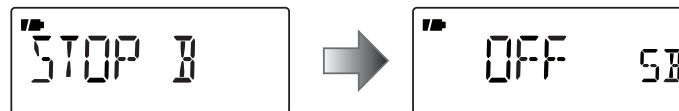

## 9 SET MODE

### ◇ Frequency offset

Sets the frequency offset for each frequency band independently within 0 to 159.995 MHz range. During duplex operation (–DUP or +DUP), the monitoring frequency (while [SQL] is pushed) shifts the set frequency.

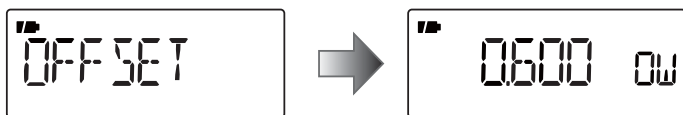

The default value may differ depending on the selected frequency band, before accessing the Set mode, and the receiver version.

▨ The selected tuning step in the VFO mode is used for the frequency offset setting.

### ◇ Duplex direction

Selects the duplex direction. The displaying frequency shifts the programmed frequency in frequency offset above when monitor function is in use (while holding down [SQL]).

- OFF : Simplex operation. (default)
- –DUP : The displayed frequency shifts down during monitor.
- +DUP : The displayed frequency shifts up during monitor.

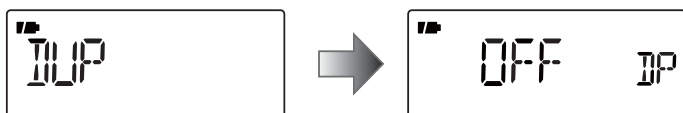

### ◇ Tone squelch

Selects the tone or DTCS squelch operation and pocket beep capability, when waiting for a desired signal.

- OFF : Regular noise squelch operation. (default)
- TSQL(( . )) : In addition to the “TSQL” setting, alert beeps will sound when a signal with the matched subaudible tone is received.
- TSQL : Selects tone squelch. The squelch opens only when a signal with a matched subaudible tone is received.
- DTCS(( . )) : In addition to the “DTCS” setting, alert beeps will sound when a signal with a matched DTCS code is received.
- DTCS : Selects DTCS squelch. The squelch opens only when a signal with a matched DTCS code is received.
- TSQL-R : Selects reverse tone squelch. The squelch becomes mute only when a signal with a matched subaudible tone is received.
- DTCS-R : Selects reverse DTCS squelch. The squelch becomes mute only when a signal with a matched DTCS code is received.

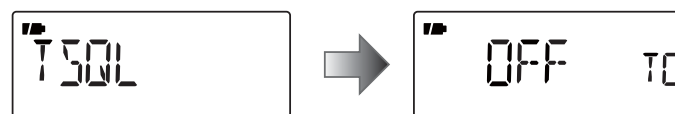

▨ The subaudible tone frequency is programmed in the tone frequency and DTCS code is programmed into the DTCS code option.

◇ **Tone frequency**

Selects a subaudible tone frequency for tone squelch operation. A total of 50 tone frequencies (67.0–254.1 Hz) are selectable. (default: 88.5 Hz)

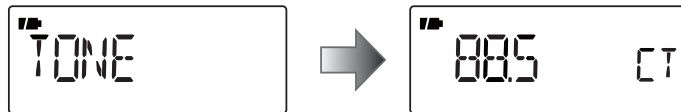

• **Available subaudible tone frequencies**

|      |      |       |       |       |       |       |       |       |       |
|------|------|-------|-------|-------|-------|-------|-------|-------|-------|
| 67.0 | 79.7 | 94.8  | 110.9 | 131.8 | 156.7 | 171.3 | 186.2 | 203.5 | 229.1 |
| 69.3 | 82.5 | 97.4  | 114.8 | 136.5 | 159.8 | 173.8 | 189.9 | 206.5 | 233.6 |
| 71.9 | 85.4 | 100.0 | 118.8 | 141.3 | 162.2 | 177.3 | 192.8 | 210.7 | 241.8 |
| 74.4 | 88.5 | 103.5 | 123.0 | 146.2 | 165.5 | 179.9 | 196.6 | 218.1 | 250.3 |
| 77.0 | 91.5 | 107.2 | 127.3 | 151.4 | 167.9 | 183.5 | 199.5 | 225.7 | 254.1 |

◇ **DTCS code**

Selects a DTCS code for DTCS squelch operation. A total of 104 codes (023–754) are selectable. (default: 023)

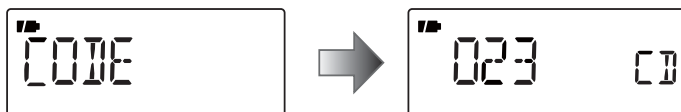

• **Available DTCS code**

|     |     |     |     |     |     |     |     |     |     |     |
|-----|-----|-----|-----|-----|-----|-----|-----|-----|-----|-----|
| 023 | 054 | 125 | 165 | 245 | 274 | 356 | 445 | 506 | 627 | 732 |
| 025 | 065 | 131 | 172 | 246 | 306 | 364 | 446 | 516 | 631 | 734 |
| 026 | 071 | 132 | 174 | 251 | 311 | 365 | 452 | 523 | 632 | 743 |
| 031 | 072 | 134 | 205 | 252 | 315 | 371 | 454 | 526 | 654 | 754 |
| 032 | 073 | 143 | 212 | 255 | 325 | 411 | 455 | 532 | 662 |     |
| 036 | 074 | 145 | 223 | 261 | 331 | 412 | 462 | 546 | 664 |     |
| 043 | 114 | 152 | 225 | 263 | 332 | 413 | 464 | 565 | 703 |     |
| 047 | 115 | 155 | 226 | 265 | 343 | 423 | 465 | 606 | 712 |     |
| 051 | 116 | 156 | 243 | 266 | 346 | 431 | 466 | 612 | 723 |     |
| 053 | 122 | 162 | 244 | 271 | 351 | 432 | 503 | 624 | 731 |     |

◇ **DTCS polarity**

Selects the DTCS polarity between normal and reverse. (default: NORMAL)

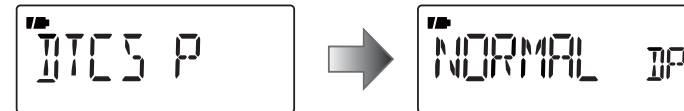

◇ **VSC**

This function is useful when you don't want unmodulated signals pausing a scan. When the voice squelch control function is activated, the receiver checks received signals for voice components. If a received signal includes voice components, and the tone of the voice components changes within 1 second, scan pauses (or stops). If the received signal includes no voice components or the tone of the voice components does not change within 1 second, scan resumes.

(default: OFF)

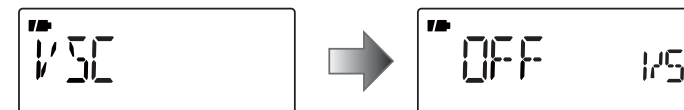

## 9 SET MODE

### ◇ Memory bank link function (B-LINK)

Turns the memory bank link function ON (default) or OFF. The link function provides continuous bank scan, scanning all channels in the selected banks during bank scan.



#### • Bank link setting

- ① Push **[MODE]** to enter the bank link setting mode.
- ② Rotate **[DIAL]** to select a bank that you want to change the link setting.



- ③ While holding down **[FUNC]**, rotate **[DIAL]** to set the link setting ON or OFF.

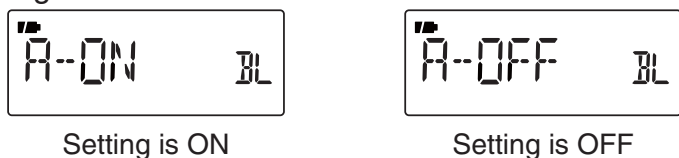

- ④ Repeat steps ② and ③ until the bank link setting is finished.
- ⑤ Push **[TS]** to exit the bank link setting mode.

### ◇ Program scan link function (P-LINK)

Sets the program scan link function. During program scan, link function performs a continuous program scan in the selected program scan number during program scan.

Default settings for LINK0 to LINK9; PROG 1 to PROG 24 are linked, but PROG 0 is not linked.



#### • Confirming program scan link

- ① Push to **[MODE]** to enter the program scan link setting.

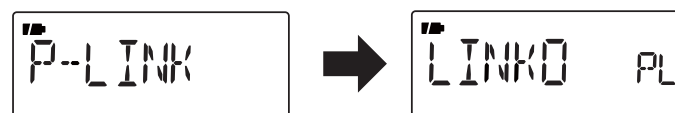

- ② Rotate **[DIAL]** to select the program scan link number that you want to confirm, then push **[MODE]**.

• "LINK" appears.



- ③ Push **[MODE]**, then rotate **[DIAL]** to confirm the linked program scans.



- ④ Push **[TS]** three times to exit the program scan link setting.



• Program scan link setting

- ① Push to [MODE] to enter the program scan link setting.



- ② Rotate [DIAL] to select the program scan link number that you want to change.  
 ③ Push [MODE], then rotate [DIAL] to select the option, "ADD" or "CLEAR".



- ④ Rotate [DIAL] to select the desired program scan.  
 • When "ADD" is selected in step ③, only non-linked program scans are displayed. When "CLEAR" is selected in step ③, only linked program scans are displayed.



- ⑤ Push [MODE] to set the program scan link setting.  
 ⑥ Repeat steps ④ and ⑤ to add or clear the program scan to or from the link, or push [TS] twice to exit the program scan link setting.

• Program scan link name programming

- ① Push to [MODE] to enter the program scan link setting.



- ② Rotate [DIAL] to select the program scan link number that you want to change.  
 ③ Push [MODE], then rotate [DIAL] to select "NAME."  
 ④ Push [MODE] to enter the name programming.  
 ⑤ While holding down [FUNC], rotate [DIAL] to select the desired character, number, symbol or space.  
 • Rotate [DIAL] right or left to move the cursor right or left, respectively.

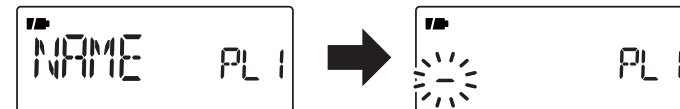

- ⑥ When finishing entering a name, push [MODE] to set the name and then exit the name programming.

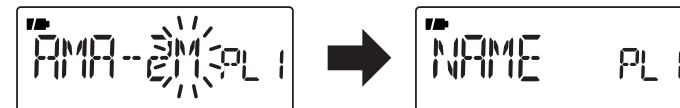

- ⑦ Push [TS] twice to exit the program scan link setting.  
 ⑧ Push [TS] to exit the Set mode.

## 9 SET MODE

### ◇ LCD contrast

Selects the LCD contrast level between 1 (light) and 5 (dark), as desired. (default: 3)

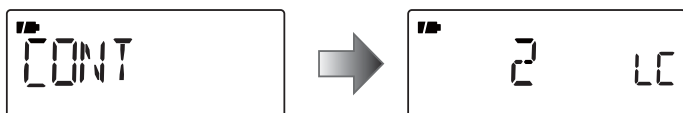

### ◇ Weather alert function

*U.S.A. version only*

Turns the weather alert function ON or OFF.

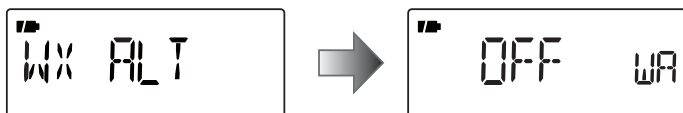

### ◇ AF filter

The AF filter suppresses high-pitch tone when this setting is ON. This function can be set for AM and WFM mode, but it does not appear for FM mode. Default setting for AM mode is "ON," and for WFM mode is "OFF."

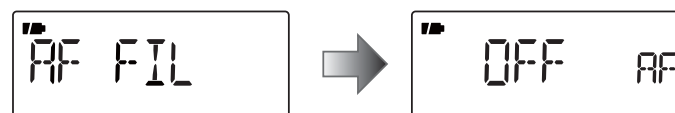

### ◇ Charge

Select the CHG1 or CHG2 charge, which will be activated after the charge timer ends. (default: CHG2)

- CHG1 : Stops charging after 15 hours have passed.
- CHG2 : Continues to trickle charge the battery, even after 15 hours have passed.

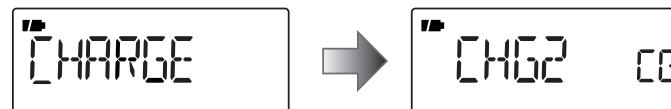

◇ **CI-V Address**

To distinguish equipments, each CI-V transceiver/receiver has its own Icom standard address in hexadecimal number. The IC-R6's address is "7E."

When 2 or more IC-R6 receivers are connected with an optional CT-17 CI-V level converter, set a different address for each of them in the range "01" to "DF." (default: 7E)

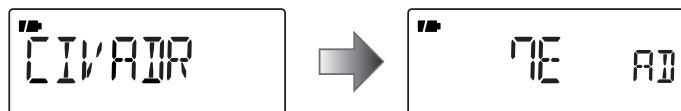

◇ **CI-V baud rate**

Sets the baud rate. When "AUTO" is selected, the baud rate is automatically set according to the connected controller or other Icom CI-V radio. (default: AUTO)

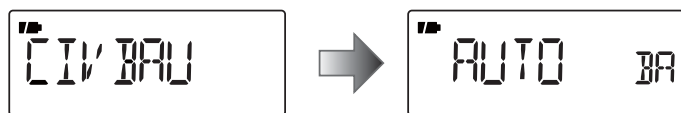

◇ **CI-V transceiver**

CI-V transceive operation is possible even if the IC-R6 receiver is connected to an Icom CI-V radio. When set to "ON", the frequency and the operating mode of the IC-R6 automatically change to those of connected radios, and vice versa. (default: ON)

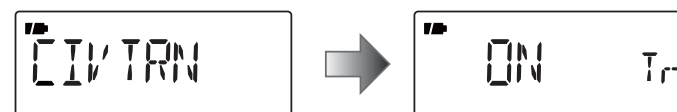

# 10 OTHER FUNCTIONS

## ■ [DIAL] function assignment

The [DIAL] control can be used as an audio volume control, instead of [▲]/[▼] keys. However, while [DIAL] functions as an audio volume control, the [▲]/[▼] keys function as tuning controls.

- ➔ While holding down [FUNC], push [VOL↔D](TS) to toggle the [DIAL] function between tuning dial and audio volume.
  - “VOL” icon appears when [DIAL] functions as the volume control.



### • [DIAL] and [▲]/[▼] functions

|         | No “VOL” icon   | “VOL” appears   |
|---------|---|---|
| [DIAL]  | Frequency, Memory channel, Squelch level, Scanning direction, Set mode item and condition set | Audio volume  |
| [▲]/[▼] | Audio volume set  | Frequency, Memory channel, Squelch level, Scanning direction, Set mode item and condition set |

## ■ Weather channel operation

U.S.A. version only

### ◇ Weather channel selection

- ① Push [V/M] to select the VFO mode, if any other mode is selected.
- ② While holding down [BAND], rotate [DIAL] to select the weather channel group.
  - The weather channel group can also be selected by pushing [BAND] repeatedly.
- ③ Rotate [DIAL] to select a desired weather channel.

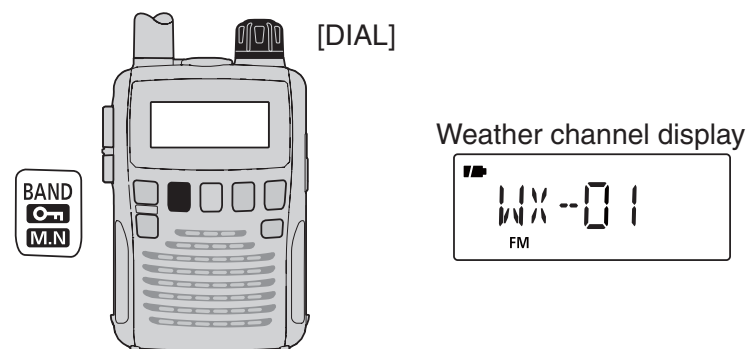

- ④ Push [BAND] to change frequency band, or push [V/M] to select the memory mode.

### ◇ Weather alert function

NOAA broadcast stations transmit weather alert tones before important weather announcements. When the weather alert function is turned ON, the selected weather channel is monitored every 5 seconds for the announcement. When the alert signal is detected, the “ALT” and the WX channel are displayed alternately and a beep tone sounds until the receiver is operated. The previously selected (used) weather channel is checked periodically during standby, or while scanning.

- ① Select a desired weather channel.
- ② Turn the weather alert function ON in the Set mode.
  - ➔ Push **[SET]**(TS) to enter the Set mode.
  - ➔ Rotate **[DIAL]** to select the weather alert option. Then, while holding down **[FUNC]**, rotate **[DIAL]** to set “ON”.
  - ➔ Push **[SET]**(TS) to exit the Set mode.
- ③ Set a desired stand-by condition.
  - Select the VFO or a memory channel.
  - Scan or priority watch operation can also be selected.
- ④ When the alert is detected, a beep sounds and the following indicator will be displayed.

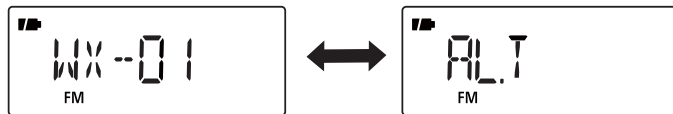

The above icons are alternately displayed.

- ⑤ Turn the weather alert function OFF in the Set mode.

**NOTE:** While receiving a signal (on a frequency other than the weather alert ON frequency), the receiving signal or audio will be interrupted momentarily every 5 seconds (approx.) when the alert function is turned ON. This is caused by the WX alert function. To eliminate the interruption, set the weather alert item OFF in the Set mode.

## 10 OTHER FUNCTIONS

### ■ Data cloning

Cloning allows you to quickly and easily transfer the programmed contents from one receiver to another; or data from a personal computer to a receiver, using the optional CS-R6 CLONING SOFTWARE.

#### ◇ Cloning between receivers

- ① Connect the OPC-474 cloning cable to the [SP] jack of the master and sub-receivers.

- The master receiver is used to send data to the sub-receiver.

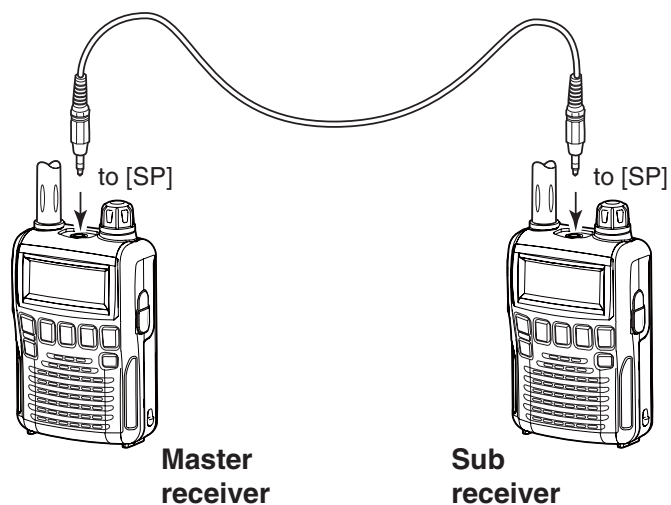

/// **NOTE: DO NOT** push any key on the sub-receiver during cloning. This will cause a cloning error.

- ② While holding down [V/M], turn only the master receiver power ON, to enter the cloning mode (master receiver only—power ON only for sub-receiver).

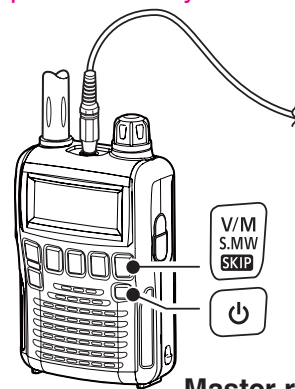

Master receiver



“CLONE” and “m” appear when entered the cloning mode.

- ③ Push [SQL] on the master receiver.

- The receiver displays the following.

#### Master receiver display



#### Sub-receiver display



During cloning



After cloning

- ④ When cloning is finished, turn power OFF, then ON to exit the cloning mode.

### ◇ Cloning using a personal computer

Data can be cloned to and from a personal computer (Microsoft® Windows® 2000/XP/Windows Vista® or Windows 7) using the optional CS-R6 CLONING SOFTWARE and the optional OPC-478/OPC-478UC CLONING CABLE. Consult the CS-R6 CLONING SOFTWARE HELP file for details.

### ◇ Cloning error

☞ **NOTE: DO NOT** push any key on the sub-receiver during cloning. This will cause a cloning error.

When the display appears as below, a cloning error has occurred.

In such a case, both receivers automatically return to the clone standby condition and cloning must be repeated.



## ■ Auto power-off function

The IC-R6 can be set to automatically turn OFF after a specified period in which no operation is performed.

120, 90, 60, 30 minutes and OFF can be specified. The specified period is retained even when the receiver is turned OFF by the auto power-off function. To cancel the function, select "OFF" in step ③ below.

- ① Push **[SET]**(TS) for 1 second to enter the Set mode.
- ② Rotate **[DIAL]** to select the "AP OFF" item.
  - Turn the Expand set mode ON for selection. (p. 39)

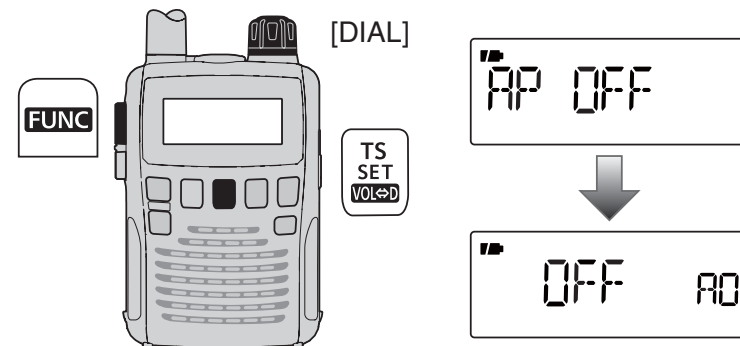

- ③ While holding down **[FUNC]**, rotate **[DIAL]** to select a desired time or to turn the function OFF.
- ④ Push **[SET]**(TS) to exit the Set mode.

## 10 OTHER FUNCTIONS

### ■ Partial reset

If you want to initialize the operating settings (VFO frequency, VFO settings, Set mode contents) without clearing the memory contents, a partial resetting function is available for the receiver.

- ➔ While holding down **[FUNC]** and **[TS]**, turn the power ON to partially reset the receiver.



- ➔ While holding down **[FUNC]** and **[TS]**, turn the power OFF, then ON again to partially reset the receiver.

### ■ All reset

The function display may occasionally display erroneous information (e.g. when first applying power). This may be caused externally by static electricity or by other factors.

If this problem occurs, turn power OFF. After waiting a few seconds, turn power ON again. If the problem persists, perform the following procedure.

- Partial resetting is also available. See to the left for details.

#### ▨ IMPORTANT!:

Resetting the receiver **CLEARs** all memory information and initializes all values in the receiver, including TV channel skip setting.

- ➔ While holding down **[FUNC]** and **[▼]**, turn the power ON to reset the CPU.

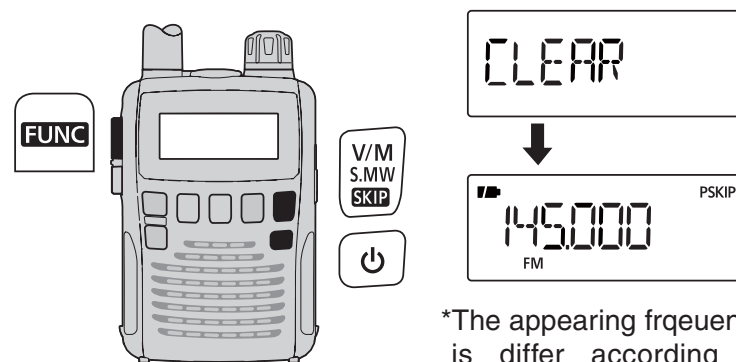

\*The appearing frequency is differ according to receiver version.



# FREQUENCY TABLE 11

## TV channels

The following tables show the channels versus video and audio frequencies, depending on each version.

### ◇ U.S.A. channels

(unit: MHz)

| CH | Freq.  | CH | Freq.  | CH | Freq.  |
|----|--------|----|--------|----|--------|
| 2  | 59.75  | 27 | 553.75 | 52 | 703.75 |
| 3  | 65.75  | 28 | 559.75 | 53 | 709.75 |
| 4  | 71.75  | 29 | 565.75 | 54 | 715.75 |
| 5  | 81.75  | 30 | 571.75 | 55 | 721.75 |
| 6  | 87.75  | 31 | 577.75 | 56 | 727.75 |
| 7  | 179.75 | 32 | 583.75 | 57 | 733.75 |
| 8  | 185.75 | 33 | 589.75 | 58 | 739.75 |
| 9  | 191.75 | 34 | 595.75 | 59 | 745.75 |
| 10 | 197.75 | 35 | 601.75 | 60 | 751.75 |
| 11 | 203.75 | 36 | 607.75 | 61 | 757.75 |
| 12 | 209.75 | 37 | 613.75 | 62 | 763.75 |
| 13 | 215.75 | 38 | 619.75 | 63 | 769.75 |
| 14 | 475.75 | 39 | 625.75 | 64 | 775.75 |
| 15 | 481.75 | 40 | 631.75 | 65 | 781.75 |
| 16 | 487.75 | 41 | 637.75 | 66 | 787.75 |
| 17 | 493.75 | 42 | 643.75 | 67 | 793.75 |
| 18 | 499.75 | 43 | 649.75 | 68 | 799.75 |
| 19 | 505.75 | 44 | 655.75 | 69 | 805.75 |
| 20 | 511.75 | 45 | 661.75 |    |        |
| 21 | 517.75 | 46 | 667.75 |    |        |
| 22 | 523.75 | 47 | 673.75 |    |        |
| 23 | 529.75 | 48 | 679.75 |    |        |
| 24 | 535.75 | 49 | 685.75 |    |        |
| 25 | 541.75 | 50 | 691.75 |    |        |
| 26 | 547.75 | 51 | 697.75 |    |        |

### ◇ CCIR channels (unit: MHz)

| CH | Freq.  | CH | Freq.  |
|----|--------|----|--------|
| 1  | 46.75  | 40 | 628.75 |
| 2  | 53.75  | 41 | 636.75 |
| 3  | 60.75  | 42 | 644.75 |
| 4  | 67.75  | 43 | 652.75 |
| 5  | 180.75 | 44 | 660.75 |
| 6  | 187.75 | 45 | 668.75 |
| 7  | 194.75 | 46 | 676.75 |
| 8  | 201.75 | 47 | 684.75 |
| 9  | 208.75 | 48 | 692.75 |
| 10 | 215.75 | 49 | 700.75 |
| 11 | 222.75 | 50 | 708.75 |
| 12 | 229.75 | 51 | 716.75 |
| 21 | 476.75 | 52 | 724.75 |
| 22 | 484.75 | 53 | 732.75 |
| 23 | 492.75 | 54 | 740.75 |
| 24 | 500.75 | 55 | 748.75 |
| 25 | 508.75 | 56 | 756.75 |
| 26 | 516.75 | 57 | 764.75 |
| 27 | 524.75 | 58 | 772.75 |
| 28 | 532.75 | 59 | 780.75 |
| 29 | 540.75 | 60 | 788.75 |
| 30 | 548.75 | 61 | 796.75 |
| 31 | 556.75 | 62 | 804.75 |
| 32 | 564.75 | 63 | 812.75 |
| 33 | 572.75 | 64 | 820.75 |
| 34 | 580.75 | 65 | 828.75 |
| 35 | 588.75 | 66 | 836.75 |
| 36 | 596.75 | 67 | 844.75 |
| 37 | 604.75 | 68 | 852.75 |
| 38 | 612.75 | 69 | 860.75 |
| 39 | 620.75 |    |        |

### ◇ Australian channels

(unit: MHz)

| CH | Freq.  | CH | Freq.  |
|----|--------|----|--------|
| 0  | 51.75  | 43 | 637.75 |
| 1  | 62.75  | 44 | 644.75 |
| 2  | 69.75  | 45 | 651.75 |
| 3  | 91.75  | 46 | 658.75 |
| 4  | 100.75 | 47 | 665.75 |
| 5  | 107.75 | 48 | 672.75 |
| 5A | 143.75 | 49 | 679.75 |
| 6  | 180.75 | 50 | 686.75 |
| 7  | 187.75 | 51 | 693.75 |
| 8  | 194.75 | 52 | 700.75 |
| 9  | 201.75 | 53 | 707.75 |
| 10 | 214.75 | 54 | 714.75 |
| 11 | 221.75 | 55 | 721.75 |
| 28 | 532.75 | 56 | 728.75 |
| 29 | 539.75 | 57 | 735.75 |
| 30 | 546.75 | 58 | 742.75 |
| 31 | 553.75 | 59 | 749.75 |
| 32 | 560.75 | 60 | 756.75 |
| 33 | 567.75 | 61 | 763.75 |
| 34 | 574.75 | 62 | 770.75 |
| 35 | 581.75 | 63 | 777.75 |
| 36 | 588.75 | 64 | 784.75 |
| 37 | 595.75 | 65 | 791.75 |
| 38 | 602.75 | 66 | 798.75 |
| 39 | 609.75 | 67 | 805.75 |
| 40 | 616.75 | 68 | 812.75 |
| 41 | 623.75 | 69 | 819.75 |
| 42 | 630.75 |    |        |

# 11 FREQUENCY TABLE

## ◇ China channels

| CH | Freq.  | CH | Freq.  |
|----|--------|----|--------|
| 1  | 56.25  | 32 | 669.75 |
| 2  | 64.25  | 33 | 677.75 |
| 3  | 72.25  | 34 | 685.75 |
| 4  | 83.75  | 35 | 693.75 |
| 5  | 91.75  | 36 | 701.75 |
| 6  | 174.75 | 37 | 709.75 |
| 7  | 182.75 | 38 | 717.75 |
| 8  | 190.75 | 39 | 725.75 |
| 9  | 198.75 | 40 | 733.75 |
| 10 | 206.75 | 41 | 741.75 |
| 11 | 214.75 | 42 | 749.75 |
| 12 | 222.75 | 43 | 757.75 |
| 13 | 477.75 | 44 | 765.75 |
| 14 | 485.75 | 45 | 773.75 |
| 15 | 493.75 | 46 | 781.75 |
| 16 | 501.75 | 47 | 789.75 |
| 17 | 509.75 | 48 | 797.75 |
| 18 | 517.75 | 49 | 805.75 |
| 19 | 525.75 | 50 | 813.75 |
| 20 | 533.75 | 51 | 821.75 |
| 21 | 541.75 | 52 | 829.75 |
| 22 | 549.75 | 53 | 837.75 |
| 23 | 557.75 | 54 | 845.75 |
| 24 | 565.75 | 55 | 853.75 |
| 25 | 613.75 | 56 | 861.75 |
| 26 | 621.75 | 57 | 869.75 |
| 27 | 629.75 | 58 | 877.75 |
| 28 | 637.75 | 59 | 885.75 |
| 29 | 645.75 | 60 | 893.75 |
| 30 | 653.75 | 61 | 901.75 |
| 31 | 661.75 | 62 | 909.75 |

(unit: MHz)

| CH | Freq.  |
|----|--------|
| 63 | 917.75 |
| 64 | 925.75 |
| 65 | 933.75 |
| 66 | 941.75 |
| 67 | 949.75 |
| 68 | 957.75 |

## ◇ New Zealand channels

(unit: MHz)

| CH | Freq.  |
|----|--------|
| 1  | 50.75  |
| 2  | 60.75  |
| 3  | 67.75  |
| 4  | 180.75 |
| 5  | 187.75 |
| 6  | 194.75 |
| 7  | 201.75 |
| 8  | 208.75 |
| 9  | 215.75 |
| 10 | 222.75 |
| 11 | 229.75 |

## ◇ UK channels

(unit: MHz)

| CH | Freq.  |
|----|--------|
| 21 | 477.25 |
| 22 | 485.25 |
| 23 | 493.25 |
| 24 | 501.25 |
| 25 | 509.25 |
| 26 | 517.25 |
| 27 | 525.25 |
| 28 | 533.25 |
| 29 | 541.25 |
| 30 | 549.25 |
| 31 | 557.25 |
| 32 | 565.25 |
| 33 | 573.25 |
| 34 | 581.25 |
| 35 | 589.25 |
| 36 | 597.25 |
| 37 | 605.25 |
| 38 | 613.25 |
| 39 | 621.25 |
| 40 | 629.25 |
| 41 | 637.25 |
| 42 | 645.25 |
| 43 | 653.25 |
| 44 | 661.25 |
| 45 | 669.25 |
| 46 | 677.25 |
| 47 | 685.25 |
| 48 | 693.25 |
| 49 | 701.25 |
| 50 | 709.25 |
| 51 | 717.25 |

## ◇ French channels (unit: MHz)

| CH | Freq.  | CH | Freq.  |
|----|--------|----|--------|
| 2  | 49.25  | 43 | 653.75 |
| 3  | 54.00  | 44 | 661.75 |
| 4  | 57.25  | 45 | 669.75 |
| 5  | 182.50 | 46 | 677.75 |
| 6  | 190.50 | 47 | 685.75 |
| 7  | 198.50 | 48 | 693.75 |
| 8  | 206.50 | 49 | 701.75 |
| 9  | 214.50 | 50 | 709.75 |
| 10 | 222.50 | 51 | 717.75 |
| 21 | 477.75 | 52 | 725.75 |
| 22 | 485.75 | 53 | 733.75 |
| 23 | 493.75 | 54 | 741.75 |
| 24 | 501.75 | 55 | 749.75 |
| 25 | 509.75 | 56 | 757.75 |
| 26 | 517.75 | 57 | 765.75 |
| 27 | 525.75 | 58 | 773.75 |
| 28 | 533.75 | 59 | 781.75 |
| 29 | 541.75 | 60 | 789.75 |
| 30 | 549.75 | 61 | 797.75 |
| 31 | 557.75 | 62 | 805.75 |
| 32 | 565.75 | 63 | 813.75 |
| 33 | 573.75 | 64 | 821.75 |
| 34 | 581.75 | 65 | 829.75 |
| 35 | 589.75 | 66 | 837.75 |
| 36 | 597.75 | 67 | 845.75 |
| 37 | 605.75 | 68 | 853.75 |
| 38 | 613.75 | 69 | 861.75 |
| 39 | 621.75 |    |        |
| 40 | 629.75 |    |        |
| 41 | 637.75 |    |        |
| 42 | 645.75 |    |        |

◇ Indonesian channels

(unit: MHz)

| CH | Freq.  | CH | Freq.  |
|----|--------|----|--------|
| 2  | 53.75  | 40 | 628.75 |
| 3  | 60.75  | 41 | 636.75 |
| 4  | 67.75  | 42 | 644.75 |
| 5  | 180.75 | 43 | 652.75 |
| 6  | 187.75 | 44 | 660.75 |
| 7  | 194.75 | 45 | 668.75 |
| 8  | 201.75 | 46 | 676.75 |
| 9  | 208.75 | 47 | 684.75 |
| 10 | 215.75 | 48 | 692.75 |
| 11 | 222.75 | 49 | 700.75 |
| 12 | 229.75 | 50 | 708.75 |
| 21 | 476.75 | 51 | 716.75 |
| 22 | 484.75 | 52 | 724.75 |
| 23 | 492.75 | 53 | 732.75 |
| 24 | 500.75 | 54 | 740.75 |
| 25 | 508.75 | 55 | 748.75 |
| 26 | 516.75 | 56 | 756.75 |
| 27 | 524.75 | 57 | 764.75 |
| 28 | 532.75 | 58 | 772.75 |
| 29 | 540.75 | 59 | 780.75 |
| 30 | 548.75 | 60 | 788.75 |
| 31 | 556.75 | 61 | 796.75 |
| 32 | 564.75 | 62 | 804.75 |
| 33 | 572.75 | 63 | 812.75 |
| 34 | 580.75 | 64 | 820.75 |
| 35 | 588.75 | 65 | 828.75 |
| 36 | 596.75 | 66 | 836.75 |
| 37 | 604.75 | 67 | 844.75 |
| 38 | 612.75 | 68 | 852.75 |
| 39 | 620.75 | 69 | 860.75 |

◇ Italian channels (unit: MHz)

| CH | Freq.  | CH | Freq.  |
|----|--------|----|--------|
| A  | 59.25  | 42 | 644.75 |
| B  | 67.75  | 43 | 652.75 |
| C  | 87.75  | 44 | 660.75 |
| D  | 180.75 | 45 | 668.75 |
| E  | 188.75 | 46 | 676.75 |
| F  | 197.75 | 47 | 684.75 |
| G  | 206.75 | 48 | 692.75 |
| H  | 215.75 | 49 | 700.75 |
| H1 | 222.75 | 50 | 708.75 |
| H2 | 229.75 | 51 | 716.75 |
| 21 | 476.75 | 52 | 724.75 |
| 22 | 484.75 | 53 | 732.75 |
| 23 | 492.75 | 54 | 740.75 |
| 24 | 500.75 | 55 | 748.75 |
| 25 | 508.75 | 56 | 756.75 |
| 26 | 516.75 | 57 | 764.75 |
| 27 | 524.75 | 58 | 772.75 |
| 28 | 532.75 | 59 | 780.75 |
| 29 | 540.75 | 60 | 788.75 |
| 30 | 548.75 | 61 | 796.75 |
| 31 | 556.75 | 62 | 804.75 |
| 32 | 564.75 | 63 | 812.75 |
| 33 | 572.75 | 64 | 820.75 |
| 34 | 580.75 | 65 | 828.75 |
| 35 | 588.75 | 66 | 836.75 |
| 36 | 596.75 | 67 | 844.75 |
| 37 | 604.75 | 68 | 852.75 |
| 38 | 612.75 | 69 | 860.75 |
| 39 | 620.75 |    |        |
| 40 | 628.75 |    |        |
| 41 | 636.75 |    |        |

◇ Taiwan channels

(unit: MHz)

| CH | Freq.  |
|----|--------|
| 7  | 179.75 |
| 8  | 185.75 |
| 9  | 191.75 |
| 10 | 197.75 |
| 11 | 203.75 |
| 12 | 209.75 |

◇ FOT channels

(unit: MHz)

| CH | Freq.  |
|----|--------|
| 4  | 181.75 |
| 5  | 189.75 |
| 6  | 197.75 |
| 7  | 205.75 |
| 8  | 213.75 |
| 9  | 221.75 |

# 11 FREQUENCY TABLE

## ■ VHF marine channels

(unit: MHz)

| CH No. | Ship Transmit | Ship Receive | CH No. | Ship Transmit | Ship Receive |
|--------|---------------|--------------|--------|---------------|--------------|
| 01     | 156.050       | 160.650      | 21A    | 157.050       | 157.050      |
| 01A    | 156.050       | 156.050      | 21b    | 161.650       | 161.650      |
| 02     | 156.100       | 160.700      | 22     | 157.100       | 161.700      |
| 03     | 156.150       | 160.750      | 22A    | 157.100       | 157.100      |
| 03A    | 156.150       | 156.150      | 23     | 157.150       | 161.750      |
| 04     | 156.200       | 160.800      | 23A    | 157.150       | 157.150      |
| 04A    | 156.200       | 156.200      | 24     | 157.200       | 161.800      |
| 05     | 156.250       | 160.850      | 25     | 157.250       | 161.850      |
| 05A    | 156.250       | 156.250      | 25b    | 161.850       | 161.850      |
| 06     | 156.300       | 156.300      | 26     | 157.300       | 161.900      |
| 07     | 156.350       | 160.950      | 27     | 157.350       | 161.950      |
| 07A    | 156.350       | 156.350      | 28     | 157.400       | 162.000      |
| 08     | 156.400       | 156.400      | 28b    | 162.000       | 162.000      |
| 09     | 156.450       | 156.450      | 60     | 156.025       | 160.625      |
| 10     | 156.500       | 156.500      | 61     | 156.075       | 160.675      |
| 11     | 156.550       | 156.550      | 61A    | 156.075       | 156.075      |
| 12     | 156.600       | 156.600      | 62     | 156.125       | 160.725      |
| 13     | 156.650       | 156.650      | 62A    | 156.125       | 156.125      |
| 14     | 156.700       | 156.700      | 63     | 156.175       | 160.775      |
| 15     | 156.750       | 156.750      | 63A    | 156.175       | 156.175      |
| 16     | 156.800       | 156.800      | 64     | 156.225       | 160.825      |
| 17     | 156.850       | 156.850      | 64A    | 156.225       | 156.225      |
| 18     | 156.900       | 161.500      | 65     | 156.275       | 160.875      |
| 18A    | 156.900       | 156.900      | 65A    | 156.275       | 156.275      |
| 19     | 156.950       | 161.550      | 66     | 156.325       | 160.925      |
| 19A    | 156.950       | 156.950      | 66A    | 156.325       | 156.325      |
| 20     | 157.000       | 161.600      | 67     | 156.375       | 156.375      |
| 20A    | 157.000       | 157.000      | 68     | 156.425       | 156.425      |
| 21     | 157.050       | 161.650      | 69     | 156.475       | 156.475      |

## ■ Weather channels

(unit: MHz)

| WX CH | Frequency |
|-------|-----------|
| 01    | 162.550   |
| 02    | 162.400   |
| 03    | 162.475   |
| 04    | 162.425   |
| 05    | 162.450   |
| 06    | 162.500   |
| 07    | 162.525   |
| 08    | 161.650   |
| 09    | 161.775   |
| 10    | 163.275   |

## Other communications in the USA

### ◇ HF CB (Citizens Band) channels

| CH | Frequency  | CH | Frequency  |
|----|------------|----|------------|
| 1  | 26.965 MHz | 21 | 27.215 MHz |
| 2  | 26.975 MHz | 22 | 27.225 MHz |
| 3  | 26.985 MHz | 23 | 27.255 MHz |
| 4  | 27.005 MHz | 24 | 27.235 MHz |
| 5  | 27.015 MHz | 25 | 27.245 MHz |
| 6  | 27.025 MHz | 26 | 27.265 MHz |
| 7  | 27.035 MHz | 27 | 27.275 MHz |
| 8  | 27.055 MHz | 28 | 27.285 MHz |
| 9  | 27.065 MHz | 29 | 27.295 MHz |
| 10 | 27.075 MHz | 30 | 27.305 MHz |
| 11 | 27.085 MHz | 31 | 27.315 MHz |
| 12 | 27.105 MHz | 32 | 27.325 MHz |
| 13 | 27.115 MHz | 33 | 27.335 MHz |
| 14 | 27.125 MHz | 34 | 27.345 MHz |
| 15 | 27.135 MHz | 35 | 27.355 MHz |
| 16 | 27.155 MHz | 36 | 27.365 MHz |
| 17 | 27.165 MHz | 37 | 27.375 MHz |
| 18 | 27.175 MHz | 38 | 27.385 MHz |
| 19 | 27.185 MHz | 39 | 27.395 MHz |
| 20 | 27.205 MHz | 40 | 27.405 MHz |

### ◇ MURS channels

| CH | Frequency   |
|----|-------------|
| 1  | 151.820 MHz |
| 2  | 151.880 MHz |
| 3  | 151.940 MHz |
| 4  | 154.570 MHz |
| 5  | 154.600 MHz |

### ◇ GMRS (General Mobile Radio Service) channels

| Transceiver Receive | Transceiver transmit |
|---------------------|----------------------|
| 462.5500 MHz        | 467.5500 MHz         |
| 462.5625 MHz        |                      |
| 462.5750 MHz        | 467.5750 MHz         |
| 462.5875 MHz        |                      |
| 462.6000 MHz        | 467.6000 MHz         |
| 462.6125 MHz        |                      |
| 462.6250 MHz        | 467.6250 MHz         |
| 462.6375 MHz        |                      |
| 462.6500 MHz        | 467.6500 MHz         |
| 462.6625 MHz        |                      |
| 462.6750 MHz        | 467.6750 MHz         |
| 462.6875 MHz        |                      |
| 462.7000 MHz        | 467.7000 MHz         |
| 462.7125 MHz        |                      |
| 462.7250 MHz        | 467.7250 MHz         |

### ◇ BRS (Business Radio Service) channels

| Dot color   | Frequency   |
|-------------|-------------|
| Red         | 151.625 MHz |
| Purple      | 151.955 MHz |
| Blue        | 154.570 MHz |
| Green       | 154.600 MHz |
| White       | 462.575 MHz |
| Black       | 462.625 MHz |
| Orange      | 462.675 MHz |
| Brown       | 464.500 MHz |
| Yellow      | 464.550 MHz |
| “J” Dot     | 467.763 MHz |
| “K” Dot     | 467.813 MHz |
| Silver Star | 467.850 MHz |
| Gold Star   | 467.875 MHz |
| Red Star    | 467.900 MHz |
| Blue Star   | 467.925 MHz |

### ◇ FRS (Family Radio Service) channels

| CH | Frequency    | CH | Frequency    |
|----|--------------|----|--------------|
| 1  | 462.5625 MHz | 8  | 467.5625 MHz |
| 2  | 462.5875 MHz | 9  | 467.5875 MHz |
| 3  | 462.6125 MHz | 10 | 467.6125 MHz |
| 4  | 462.6375 MHz | 11 | 467.6375 MHz |
| 5  | 462.6625 MHz | 12 | 467.6625 MHz |
| 6  | 462.6875 MHz | 13 | 467.6875 MHz |
| 7  | 462.7125 MHz | 14 | 467.7125 MHz |

# 11 FREQUENCY TABLE

## ◇ General aviation frequencies

| Frequency | Description                                       |
|-----------|---|
| 121.500   | Emergencies                                       |
| 122.000   | Flight Advisory Service                           |
| 122.200   | Flight Service Stations                           |
| 122.700   | Unicom— Uncontrolled airports                     |
| 122.725   | Unicom— Private airports                          |
| 122.750   | Unicom— Air-to-air communications                 |
| 122.800   | Unicom— Uncontrolled airports                     |
| 122.900   | Search & rescue training, & uncontrolled airports |
| 122.950   | Unicom— Controlled airports                       |
| 123.000   | Unicom— Uncontrolled airports                     |
| 123.025   | Helicopters— Air-to-air communications            |
| 123.050   | Unicom— Heliports                                 |
| 123.075   | Unicom— Heliports                                 |
| 123.100   | Search & Rescue                                   |
| 123.300   | Flight Schools                                    |
| 123.450   | Air-to-air communications (unofficial)            |
| 123.500   | Flight Schools                                    |
| 123.600   | Flight Service Stations— Uncontrolled airports    |
| 148.125   | Civil Air Patrol Repeaters— Secondary             |
| 148.150   | Civil Air Patrol Repeaters— Primary               |
| 156.300   | Aircraft-to-ship— safety                          |
| 156.400   | Aircraft-to-ship— commercial                      |
| 156.425   | Aircraft-to-ship— non-commercial                  |
| 156.450   | Aircraft-to-ship— commercial                      |
| 156.625   | Aircraft-to-ship— non-commercial                  |
| 156.900   | Aircraft-to-ship— commercial                      |
| 243.000   | Military Emergency “Guard”                        |
| 255.400   | Flight Advisory Service                           |
| 257.800   | Civilian Towers                                   |
| 311.000   | SAC Primary                                       |
| 321.000   | SAC Secondary                                     |
| 381.800   | USCG— Primary                                     |

## ◇ Cable TV (IRC)

(unit: MHz)

| CH      | Frequency range | Remarks                 |
|---------|-----------------|-------------------------|
| 2– 13   | 54–216          | (same as broadcast VHF) |
| 14– 22  | 120–174         | Mid band Ch. A–I        |
| 23– 36  | 216–300         | Super band J–W          |
| 37– 53  | 300–402         | Hyper band AA–QQ        |
| 54– 64  | 402–468         |                         |
| 65– 94  | 468–648         | (Ultra band)            |
| 95– 99  | 90–120          | Low band A5–A1          |
| 100–125 | 648–804         | (Ultra band)            |

## ◇ Wireless Microphones

- 169.445 MHz
- 169.505 MHz
- 170.245 MHz
- 170.305 MHz
- 171.045 MHz
- 171.105 MHz
- 171.845 MHz
- 171.905 MHz

\*Power limited to 1/20 watt. These frequencies are also used at drive-in windows at some fast-food restaurants.

**Other communications— other countries**

◇ **LPD (Low Power Device) channels**

(unit: MHz)

◇ **PMR446 channels** (unit: MHz)

| CH | Frequency |
|----|-----------|
| 1  | 433.075   |
| 2  | 433.100   |
| 3  | 433.125   |
| 4  | 433.150   |
| 5  | 433.175   |
| 6  | 433.200   |
| 7  | 433.225   |
| 8  | 433.250   |
| 9  | 433.275   |
| 10 | 433.300   |
| 11 | 433.325   |
| 12 | 433.350   |
| 13 | 433.375   |
| 14 | 433.400   |
| 15 | 433.425   |
| 16 | 433.450   |
| 17 | 433.475   |
| 18 | 433.500   |
| 19 | 433.525   |
| 20 | 433.550   |
| 21 | 433.575   |
| 22 | 433.600   |
| 23 | 433.625   |
| 24 | 433.650   |
| 25 | 433.675   |
| 26 | 433.700   |
| 27 | 433.725   |
| 28 | 433.750   |
| 29 | 433.775   |

| CH | Frequency |
|----|-----------|
| 30 | 433.800   |
| 31 | 433.825   |
| 32 | 433.850   |
| 33 | 433.875   |
| 34 | 433.900   |
| 35 | 433.925   |
| 36 | 433.950   |
| 37 | 433.975   |
| 38 | 434.000   |
| 39 | 434.025   |
| 40 | 434.050   |
| 41 | 434.075   |
| 42 | 434.100   |
| 43 | 434.125   |
| 44 | 434.150   |
| 45 | 434.175   |
| 46 | 434.200   |
| 47 | 434.225   |
| 48 | 434.250   |
| 49 | 434.275   |
| 50 | 434.300   |
| 51 | 434.325   |
| 52 | 434.350   |
| 53 | 434.375   |
| 54 | 434.400   |
| 55 | 434.425   |
| 56 | 434.450   |
| 57 | 434.475   |
| 58 | 434.500   |

| CH | Frequency |
|----|-----------|
| 59 | 434.525   |
| 60 | 434.550   |
| 61 | 434.575   |
| 62 | 434.600   |
| 63 | 434.625   |
| 64 | 434.650   |
| 65 | 434.675   |
| 66 | 434.700   |
| 67 | 434.725   |
| 68 | 434.750   |
| 69 | 434.775   |

| CH | Frequency |
|----|-----------|
| 1  | 446.00625 |
| 2  | 446.01875 |
| 3  | 446.03125 |
| 4  | 446.04375 |
| 5  | 446.05625 |
| 6  | 446.06875 |
| 7  | 446.08125 |
| 8  | 446.09375 |

---

# 11 FREQUENCY TABLE

## ◇ UHF C.R.S (Citizen Radio Service) channels

| CH | Frequency   | CH | Frequency   |
|----|-------------|----|-------------|
| 1  | 476.425 MHz | 21 | 476.925 MHz |
| 2  | 476.450 MHz | 22 | 476.950 MHz |
| 3  | 476.475 MHz | 23 | 476.975 MHz |
| 4  | 476.500 MHz | 24 | 477.000 MHz |
| 5  | 476.525 MHz | 25 | 477.025 MHz |
| 6  | 476.550 MHz | 26 | 477.050 MHz |
| 7  | 476.575 MHz | 27 | 477.075 MHz |
| 8  | 476.600 MHz | 28 | 477.100 MHz |
| 9  | 476.625 MHz | 29 | 477.125 MHz |
| 10 | 476.650 MHz | 30 | 477.150 MHz |
| 11 | 476.675 MHz | 31 | 477.175 MHz |
| 12 | 476.700 MHz | 32 | 477.200 MHz |
| 13 | 476.725 MHz | 33 | 477.225 MHz |
| 14 | 476.750 MHz | 34 | 477.250 MHz |
| 15 | 476.775 MHz | 35 | 477.275 MHz |
| 16 | 476.800 MHz | 36 | 477.300 MHz |
| 17 | 476.825 MHz | 37 | 477.325 MHz |
| 18 | 476.850 MHz | 38 | 477.350 MHz |
| 19 | 476.875 MHz | 39 | 477.375 MHz |
| 20 | 476.900 MHz | 40 | 477.400 MHz |



## ■ Troubleshooting

If your receiver seems to be malfunctioning, please check the following points before sending it to a service center.

| PROBLEM   | POSSIBLE CAUSE   | SOLUTION  | REF.                    |
|---|--|---|-------------------------|
| No power comes on.                                      | <ul style="list-style-type: none"> <li>• The batteries are exhausted.</li> <li>• The battery polarity is reversed.</li> </ul>  | <ul style="list-style-type: none"> <li>• Replace the batteries or charge the batteries.</li> <li>• Check the battery polarity.</li> </ul>   | pgs. 5, 6<br>p. 5       |
| No sound comes from the speaker.                        | <ul style="list-style-type: none"> <li>• Volume level is too low.</li> <li>• Squelch level is set too tight.</li> <li>• Different tone is selected with tone squelch.</li> </ul> | <ul style="list-style-type: none"> <li>• Push [▲] to obtain a suitable level.</li> <li>• While holding down [SQL], rotate [DIAL] to set the squelch level.</li> <li>• Turn the appropriate function OFF.</li> </ul> | p. 11<br>p. 12<br>p. 35 |
| Sensitivity is low and only strong signals are audible. | <ul style="list-style-type: none"> <li>• Attenuator function is activated.</li> </ul>  | <ul style="list-style-type: none"> <li>• While holding down [FUNC], push [SQL] to turn the attenuator function OFF.</li> </ul>  | p. 13                   |
| Frequency cannot be set.                                | <ul style="list-style-type: none"> <li>• The lock function is activated.</li> </ul>  | <ul style="list-style-type: none"> <li>• While holding down [FUNC], push [🔒](BAND) for 1 second to turn the function OFF.</li> </ul>  | p. 10                   |
| No beep sound.  | <ul style="list-style-type: none"> <li>• Beep tones are turned OFF or the beep tone level is too low.</li> </ul>   | <ul style="list-style-type: none"> <li>• Turn beep tone ON or set the beep tone level to appropriate level in the Set mode.</li> </ul>  | p. 41                   |
| Receive audio is distorted.                             | <ul style="list-style-type: none"> <li>• The operating mode is not selected correctly.</li> </ul>  | <ul style="list-style-type: none"> <li>• Push [MODE] repeatedly to select a suitable operating mode.</li> </ul>   | p. 12                   |
| Desired Set mode item cannot be selected.               | <ul style="list-style-type: none"> <li>• “EXPAND” item is set to OFF.</li> <li>• Some Set mode items can be selected in the AM or FM broadcast band only.</li> </ul>             | <ul style="list-style-type: none"> <li>• Turn “EXPAND” item ON.</li> <li>• Choose the AM or FM broadcast band.</li> </ul>   | p. 39<br>p. 7           |
| Programmed scan does not start.                         | <ul style="list-style-type: none"> <li>• Program scan edges are not programmed.</li> </ul>   | <ul style="list-style-type: none"> <li>• Program a pair of scan edge channels.</li> </ul>   | p. 27                   |
| Memory or bank scan does not start.                     | <ul style="list-style-type: none"> <li>• No or only one memory or bank channel is programmed.</li> </ul>   | <ul style="list-style-type: none"> <li>• Program at least 2 memory or bank channels</li> </ul>  | pgs. 16,<br>17          |
| Installed batteries cannot be charged.                  | <ul style="list-style-type: none"> <li>• The batteries over discharged.</li> </ul>   | <ul style="list-style-type: none"> <li>• Re-install the batteries (wait at least for 1 second), then plug the AC adapter while holding down [FUNC].</li> </ul>  | p. 6                    |

---

## 12 MAINTENANCE

### ■ CP-18A/E fuse replacement

If the fuse blows, or the receiver stops functioning while operating with the optional CP-18A/E, find the source of the problem if possible, solve it and only then replace the damaged fuse with a new rated one (FGB 5 A) as shown below.

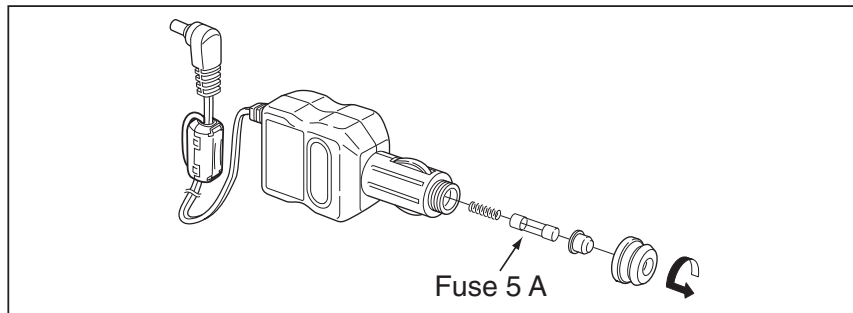

# SPECIFICATIONS 13

## ◇ GENERAL

- Frequency coverage : (Unit: MHz)
  - USA 0.100–823.995, 851.000–866.995, 896.000–1309.995
  - France 0.100–29.995, 50.200–51.200, 87.500–107.995, 144.000–146.000, 430.000–440.000, 1240.000–1300.000
  - Other than above 0.100–1309.995 MHz
- Number of memory channels : 1350 (incl. 50 scan edges and 200 auto write channels)
- Frequency resolution : 5, 6.25, 8.33, \* 9\*, 10, 12.5, 15, 20, 25, 30, 50, 100, 125, 200 kHz
  - \*selectable depending on the operating frequency band.
- Receive modes : FM, WFM, AM
- Operating temperature range : –10°C to +60°C; +14°F to +140°F
- Reference frequency stability : ±1.0 ppm (+25°C)
- Power supply requirement : 2 AA (R6) alkaline cells  
2 AA (R6) Ni-MH cells  
4.5 to 6.3 V DC  
(with AC adapter or CP-18A/E)
- Current drain (backlight OFF at 3.0 V DC):
  - rated audio 130 mA typical
  - receive standby 65 mA typical
  - power save (1:4) 30 mA typical
  - charging 140 mA typical
- Antenna connector : SMA (50 Ω)
- Dimensions : 58(W) × 86(H) × 29.8(D) mm  
(projections not included) 2<sup>9</sup>/<sub>32</sub>(W)×3<sup>3</sup>/<sub>8</sub>(H)×1<sup>3</sup>/<sub>16</sub>(D) in
- Weight (approximately) : 200 g; 7.1 oz  
(with supplied antenna and batteries)
- Ext. speaker connector : 3-conductor 3.5 (d) mm (1/8")/8 Ω

## ◇ RECEIVER

- Receive system : Triple-conversion superheterodyne
- Intermediate frequencies : 1st : 266.7 MHz,  
2nd : 19.65 MHz (FM/AM),  
19.95 MHz (WFM)  
3rd : 450 kHz (FM/AM),  
750 kHz (WFM)
- Sensitivity (except spurious points): when connecting EXT-ANT
  - FM (1 kHz/3.5 kHz Dev.; 12 dB SINAD)
    - 1.625–4.995 MHz 0.32 μV typical
    - 5.000–29.995 MHz 0.25 μV typical
    - 30.000–117.995 MHz 0.18 μV typical
    - 118.000–246.995 MHz 0.18 μV typical
    - 247.000–469.995 MHz 0.18 μV typical
    - 470.000–832.995 MHz 0.32 μV typical
    - 833.000–1029.995 MHz 0.28 μV typical
    - 1030.000–1309.995 MHz 0.35 μV typical
  - WFM (1 kHz/52.5 kHz Dev.; 12 dB SINAD)
    - 76.000–108.000 MHz 1.1 μV typical
    - 175.000–221.995 MHz 1.1 μV typical
    - 470.000–770.000 MHz 1.8 μV typical
  - AM (1 kHz/30% MOD.; 10 dB S/N)
    - 0.495–4.995 MHz 1.3 μV typical
    - 5.000–29.995 MHz 0.89 μV typical
    - 118.000–136.000 MHz 0.63 μV typical
    - 222.000–246.995 MHz 0.63 μV typical
    - 247.000–329.995 MHz 0.79 μV typical
- Selectivity :
  - AM/FM : More than 12 kHz/–9 dB  
Less than 30 kHz/–60 dB
  - WFM : More than 150 kHz/–6 dB
- Audio output power : (at 10% distortion/3.0 V DC)
  - Internal speaker : More than 150 mW with a 16 Ω load
  - External speaker : 80 mW typical with an 8 Ω load

All stated specifications are subject to change without notice or obligation.

# 14 OPTIONS

## Options

### BC-196SA/SD/153SC AC ADAPTER

Regularly charges the installed batteries.

BC-196SA/SD:

4.5 V DC/400 mA output

BC-153SC:

6.0 V DC/1 A output

### CP-18A/E CIGARETTE LIGHTER CABLE WITH DC-DC CONVERTER



Allows you to operate the receiver through a 12 V cigarette lighter socket, and also charges the installed rechargeable batteries regularly. A DC-DC converter is built-in.

### AD-92SMA ANTENNA CONNECTOR ADAPTER



Allows you to connect an external antenna with a BNC connector.

### SP-13 EARPHONE



Provides clear audio in noisy environments.

### BC-194 CHARGE ADAPTER

Allows you to charge the receiver on the desktop. Requires AC adapter or cigarette lighter cable.

### LC-146A CARRYING CASE

Helps protect the receiver from scratches, etc.

### OPC-474 CLONING CABLE

For connection between receivers for data cloning.

### OPC-478/OPC-478UC

CLONING CABLE

Used for data cloning between receiver and PC with CS-R6 (cloning software).

### CS-R6 CLONING SOFTWARE

Provides quick and easy programming of such settings as memory channels and Set mode contents via your PC's RS-232C terminal (using OPC-478), or USB port (OPC-478UC). Either OPC-478 or OPC-478UC is required.

### CT-17 CI-V LEVEL CONVERTER

For receiver remote control using a PC.

### HP-4 HEAD PHONE

Provides clear audio in noisy environments.

# POCKET GUIDE

# 15



Important operating instructions are summed up on this and the following page for your simple reference.

By cutting along the line and folding on the dotted line, it will become a card sized operating guide which can easily be carried in a card case or wallet, etc.

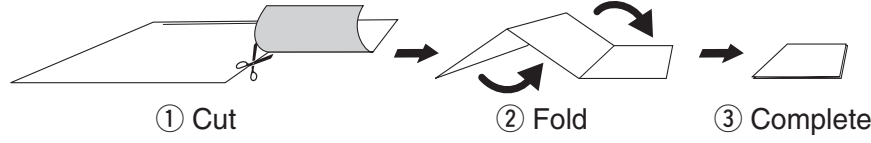

## ICOM POCKET GUIDE IC-R6

- **VFO and memory mode selection**
  - ➔ Push [V/M] to toggle between the VFO and the memory mode.
- **Receive mode selection**
  - ➔ Push [MODE] repeatedly to select the desired mode
- **Audio level setting**
  - ➔ Push [▲] to increase, push [▼] to decrease the audio level.
- **Squelch level setting**
  - ➔ Hold down [SQL], rotate [DIAL] to set the squelch level.

<CUT HERE>

- **Frequency band selection**
  - ➔ Push [BAND] repeatedly, or hold down [BAND], rotate [DIAL] to select the desired frequency band.
- **Tuning step selection**
  - ➔ Push [TS], then rotate [DIAL] to select the desired tuning step.
    - Push [TS] again to return to the previous screen.
- **Key lock function**
  - ➔ Hold down [FUNC], push [ ] (BAND) for 1 sec. to toggle the key lock function ON or OFF.
    - " " appears when the lock function is in use.
- **Attenuator function**
  - ➔ Hold down [FUNC], push [ATT] (SQL) to toggle the attenuator ON or OFF.
    - "ATT" appears when the attenuator function is in use.

- **Frequency setting**
  - ① Push [V/M] to select the VFO mode.
  - ② Rotate [DIAL] to set the desired operating frequency.
- **Memory channel selection**
  - ① Push [V/M] to select the memory mode.
  - ② Rotate [DIAL] to set a desired memory channel.
    - Hold down [FUNC], rotate [DIAL] changes memory channel in 10 channel steps.
- **Memory bank channel selection**
  - ① Push [V/M] to select the memory mode.
  - ② Push [BAND] repeatedly, or while holding down [BAND], rotate [DIAL] selects a desired bank.
  - ③ Rotate [DIAL] to select the desired bank channel.



# 16

# CE



CE Versions of the IC-R6 which display the 'CE' symbol on the serial number label, comply with the essential requirements of the European Radio and Telecommunication Terminal Directive 1999/5/EC

### • List of Country codes (ISO 3166-1)

|    | Country        | Codes |    | Country        | Codes |
|----|----------------|-------|----|----------------|-------|
| 1  | Austria        | AT    | 18 | Liechtenstein  | LI    |
| 2  | Belgium        | BE    | 19 | Lithuania      | LT    |
| 3  | Bulgaria       | BG    | 20 | Luxembourg     | LU    |
| 4  | Croatia        | HR    | 21 | Malta          | MT    |
| 5  | Czech Republic | CZ    | 22 | Netherlands    | NL    |
| 6  | Cyprus         | CY    | 23 | Norway         | NO    |
| 7  | Denmark        | DK    | 24 | Poland         | PL    |
| 8  | Estonia        | EE    | 25 | Portugal       | PT    |
| 9  | Finland        | FI    | 26 | Romania        | RO    |
| 10 | France         | FR    | 27 | Slovakia       | SK    |
| 11 | Germany        | DE    | 28 | Slovenia       | SI    |
| 12 | Greece         | GR    | 29 | Spain          | ES    |
| 13 | Hungary        | HU    | 30 | Sweden         | SE    |
| 14 | Iceland        | IS    | 31 | Switzerland    | CH    |
| 15 | Ireland        | IE    | 32 | Turkey         | TR    |
| 16 | Italy          | IT    | 33 | United Kingdom | GB    |
| 17 | Latvia         | LV    |    |                |       |

### ■ Memory channel programming

- ① Set the desired frequency and other functions in the VFO mode.
- ② Push and hold [S.MW](V/M) for 1 sec. to enter the select memory write mode.
  - 1 short and 1 long beeps sound.
- ③ Rotate [DIAL] to select a desired memory channel.
- ④ Push and hold [S.MW](V/M) for 1 sec. to program the contents into the selected channel.
  - 3 beeps sound.

### ■ Scan skip setting

- ① Push [V/M] to select the memory mode.
- ② Rotate [DIAL] to select a desired memory channel.
- ③ Hold down [FUNC], push [SKIP] (V/M) to set the skip setting (skip channel or skip frequency) ON or OFF.

### ■ VFO scans

- ① Push [V/M] to select the VFO mode.
- ② Push and hold [SCAN] (MODE) for 1 sec.
  - A scan type appears.

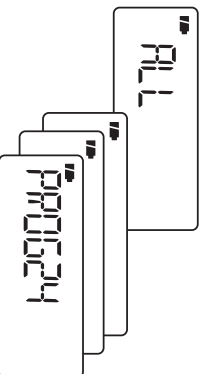

- ③ Rotate [DIAL] to select the desired scan type.
- ④ Push [SCAN] (MODE) to start the scan.
  - Rotate [DIAL] to change the scanning direction.
  - During scan, push [V/M] to start the auto memory write scan.
- ⑤ Push [SCAN](MODE) again to stop the scan.

### ■ Memory scans

- ① Push [V/M] to select the memory mode.
- ② Push and hold [SCAN](MODE) for 1 sec.
  - A scan type appears.

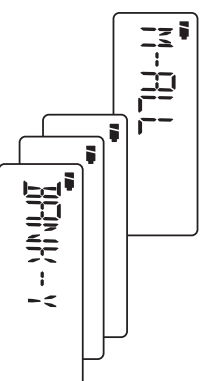

- ③ Rotate [DIAL] to select the desired scan type.
- ④ Push [SCAN] (MODE) to start the scan.
  - Rotate [DIAL] to change the scanning direction.
- ⑤ Push [SCAN](MODE) again to stop scan.



**DECLARATION  
OF CONFORMITY**

We Icom Inc. Japan  
1-1-32, Kamiminami, Hirano-ku  
Osaka 547-0003, Japan



Declare on our sole responsibility that this equipment complies with the essential requirements of the Radio and Telecommunications Terminal Equipment Directive, 1999/5/EC, and that any applicable Essential Test Suite measurements have been performed.

Bad Soden 24th Dec. 2009  
Place and date of issue

**Kind of equipment:** COMMUNICATIONS RECEIVER

Icom (Europe) GmbH  
Communication Equipment  
Auf der Krautweide 24,  
65812 Bad Soden am Taunus,  
Germany

**Type-designation:** IC-R6

Authorized representative name

**Version (where applicable):**

This compliance is based on conformity with the following harmonised standards, specifications or documents:

- i) EN 301 489-1 v1.6.1 (September 2005)
- ii) EN 301 489-15 v1.2.1 (August 2002)
- iii) EN 301 783-2 v1.1.1 (September 2000)
- iv) EN 60950-1 (2001): A11: 2004

Y. Furukawa  
General Manager

Signature

**Icom Inc.**

15

16

# Count on us!

#02 Europe  
#12 Europe-1

| <Intended Country of Use>              |  |  |  |  |  |  |  |  |  |  |  |
|--|--|--|--|--|--|--|--|--|--|--|--|
| <input checked="" type="checkbox"/> AT | <input checked="" type="checkbox"/> BE | <input checked="" type="checkbox"/> CY | <input checked="" type="checkbox"/> CZ | <input checked="" type="checkbox"/> DK | <input checked="" type="checkbox"/> EE |  |  |  |  |  |  |
| <input checked="" type="checkbox"/> FI | <input type="checkbox"/> FR            | <input checked="" type="checkbox"/> DE | <input checked="" type="checkbox"/> GR | <input checked="" type="checkbox"/> HU | <input checked="" type="checkbox"/> IE |  |  |  |  |  |  |
| <input type="checkbox"/> IT            | <input checked="" type="checkbox"/> LV | <input checked="" type="checkbox"/> LT | <input checked="" type="checkbox"/> LU | <input checked="" type="checkbox"/> MT | <input checked="" type="checkbox"/> NL |  |  |  |  |  |  |
| <input checked="" type="checkbox"/> PL | <input checked="" type="checkbox"/> PT | <input checked="" type="checkbox"/> SK | <input checked="" type="checkbox"/> SI | <input type="checkbox"/> ES            | <input checked="" type="checkbox"/> SE |  |  |  |  |  |  |
| <input type="checkbox"/> GB            | <input checked="" type="checkbox"/> IS | <input checked="" type="checkbox"/> LI | <input checked="" type="checkbox"/> NO | <input checked="" type="checkbox"/> CH | <input checked="" type="checkbox"/> BG |  |  |  |  |  |  |
| <input checked="" type="checkbox"/> RO | <input checked="" type="checkbox"/> TR | <input checked="" type="checkbox"/> HR |  |  |  |  |  |  |  |  |  |

#03 U.K.

| <Intended Country of Use>              |                             |                             |                             |                             |                             |  |  |  |  |  |  |
|--|-----------------------------|-----------------------------|-----------------------------|-----------------------------|-----------------------------|--|--|--|--|--|--|
| <input type="checkbox"/> AT            | <input type="checkbox"/> BE | <input type="checkbox"/> CY | <input type="checkbox"/> CZ | <input type="checkbox"/> DK | <input type="checkbox"/> EE |  |  |  |  |  |  |
| <input type="checkbox"/> FI            | <input type="checkbox"/> FR | <input type="checkbox"/> DE | <input type="checkbox"/> GR | <input type="checkbox"/> HU | <input type="checkbox"/> IE |  |  |  |  |  |  |
| <input type="checkbox"/> IT            | <input type="checkbox"/> LV | <input type="checkbox"/> LT | <input type="checkbox"/> LU | <input type="checkbox"/> MT | <input type="checkbox"/> NL |  |  |  |  |  |  |
| <input type="checkbox"/> PL            | <input type="checkbox"/> PT | <input type="checkbox"/> SK | <input type="checkbox"/> SI | <input type="checkbox"/> ES | <input type="checkbox"/> SE |  |  |  |  |  |  |
| <input checked="" type="checkbox"/> GB | <input type="checkbox"/> IS | <input type="checkbox"/> LI | <input type="checkbox"/> NO | <input type="checkbox"/> CH | <input type="checkbox"/> BG |  |  |  |  |  |  |
| <input type="checkbox"/> RO            | <input type="checkbox"/> TR | <input type="checkbox"/> HR |                             |                             |                             |  |  |  |  |  |  |

#04 Italy  
#14 Italy-1

| <Intended Country of Use>              |                             |                             |                             |                             |                             |  |  |  |  |  |  |
|--|-----------------------------|-----------------------------|-----------------------------|-----------------------------|-----------------------------|--|--|--|--|--|--|
| <input type="checkbox"/> AT            | <input type="checkbox"/> BE | <input type="checkbox"/> CY | <input type="checkbox"/> CZ | <input type="checkbox"/> DK | <input type="checkbox"/> EE |  |  |  |  |  |  |
| <input type="checkbox"/> FI            | <input type="checkbox"/> FR | <input type="checkbox"/> DE | <input type="checkbox"/> GR | <input type="checkbox"/> HU | <input type="checkbox"/> IE |  |  |  |  |  |  |
| <input checked="" type="checkbox"/> IT | <input type="checkbox"/> LV | <input type="checkbox"/> LT | <input type="checkbox"/> LU | <input type="checkbox"/> MT | <input type="checkbox"/> NL |  |  |  |  |  |  |
| <input type="checkbox"/> PL            | <input type="checkbox"/> PT | <input type="checkbox"/> SK | <input type="checkbox"/> SI | <input type="checkbox"/> ES | <input type="checkbox"/> SE |  |  |  |  |  |  |
| <input type="checkbox"/> GB            | <input type="checkbox"/> IS | <input type="checkbox"/> LI | <input type="checkbox"/> NO | <input type="checkbox"/> CH | <input type="checkbox"/> BG |  |  |  |  |  |  |
| <input type="checkbox"/> RO            | <input type="checkbox"/> TR | <input type="checkbox"/> HR |                             |                             |                             |  |  |  |  |  |  |

#07 France  
#17 France-1

| <Intended Country of Use>   |  |                             |                             |                             |                             |  |  |  |  |  |  |
|-----------------------------|--|-----------------------------|-----------------------------|-----------------------------|-----------------------------|--|--|--|--|--|--|
| <input type="checkbox"/> AT | <input type="checkbox"/> BE            | <input type="checkbox"/> CY | <input type="checkbox"/> CZ | <input type="checkbox"/> DK | <input type="checkbox"/> EE |  |  |  |  |  |  |
| <input type="checkbox"/> FI | <input checked="" type="checkbox"/> FR | <input type="checkbox"/> DE | <input type="checkbox"/> GR | <input type="checkbox"/> HU | <input type="checkbox"/> IE |  |  |  |  |  |  |
| <input type="checkbox"/> IT | <input type="checkbox"/> LV            | <input type="checkbox"/> LT | <input type="checkbox"/> LU | <input type="checkbox"/> MT | <input type="checkbox"/> NL |  |  |  |  |  |  |
| <input type="checkbox"/> PL | <input type="checkbox"/> PT            | <input type="checkbox"/> SK | <input type="checkbox"/> SI | <input type="checkbox"/> ES | <input type="checkbox"/> SE |  |  |  |  |  |  |
| <input type="checkbox"/> GB | <input type="checkbox"/> IS            | <input type="checkbox"/> LI | <input type="checkbox"/> NO | <input type="checkbox"/> CH | <input type="checkbox"/> BG |  |  |  |  |  |  |
| <input type="checkbox"/> RO | <input type="checkbox"/> TR            | <input type="checkbox"/> HR |                             |                             |                             |  |  |  |  |  |  |

#08 Spain  
#18 Spain-1

| <Intended Country of Use>   |                             |                             |                             |  |                             |  |  |  |  |  |  |
|-----------------------------|-----------------------------|-----------------------------|-----------------------------|--|-----------------------------|--|--|--|--|--|--|
| <input type="checkbox"/> AT | <input type="checkbox"/> BE | <input type="checkbox"/> CY | <input type="checkbox"/> CZ | <input type="checkbox"/> DK            | <input type="checkbox"/> EE |  |  |  |  |  |  |
| <input type="checkbox"/> FI | <input type="checkbox"/> FR | <input type="checkbox"/> DE | <input type="checkbox"/> GR | <input type="checkbox"/> HU            | <input type="checkbox"/> IE |  |  |  |  |  |  |
| <input type="checkbox"/> IT | <input type="checkbox"/> LV | <input type="checkbox"/> LT | <input type="checkbox"/> LU | <input type="checkbox"/> MT            | <input type="checkbox"/> NL |  |  |  |  |  |  |
| <input type="checkbox"/> PL | <input type="checkbox"/> PT | <input type="checkbox"/> SK | <input type="checkbox"/> SI | <input checked="" type="checkbox"/> ES | <input type="checkbox"/> SE |  |  |  |  |  |  |
| <input type="checkbox"/> GB | <input type="checkbox"/> IS | <input type="checkbox"/> LI | <input type="checkbox"/> NO | <input type="checkbox"/> CH            | <input type="checkbox"/> BG |  |  |  |  |  |  |
| <input type="checkbox"/> RO | <input type="checkbox"/> TR | <input type="checkbox"/> HR |                             |  |                             |  |  |  |  |  |  |

A-6810H-1EX  
Printed in Japan  
© 2009 Icom Inc.

Printed on recycled paper with soy ink.

Icom Inc.  
1-1-32 Kamiminami, Hirano-ku, Osaka 547-0003, Japan