



INSTRUCTION MANUAL

VHF MOBILE TRANSCEIVERS

IC-F5120D
Series

UHF MOBILE TRANSCEIVERS

IC-F6120D
Series



Icom Inc.

IMPORTANT

READ ALL INSTRUCTIONS carefully and completely before using the transceiver.

SAVE THIS INSTRUCTION MANUAL — This instruction manual contains important operating instructions for the **IC-F5121D, IC-F5123D, IC-F5128D VHF MOBILE TRANSCEIVERS** and the **IC-F6121D, IC-F6123D, IC-F6128D UHF MOBILE TRANSCEIVERS**.

EXPLICIT DEFINITIONS

WORD	DEFINITION
⚠ WARNING!	Personal injury, fire hazard or electric shock may occur.
CAUTION	Equipment damage may occur.
NOTE	If disregarded, inconvenience only. No risk of personal injury, fire or electric shock.

For Canada:

This device complies with RSS-310 of Industry Canada. Operation is subject to the condition that this device does not cause harmful interference.

Cet appareil est conforme au CNR-310 d'Industrie Canada. Son exploitation est autorisée sous réserve que l'appareil ne cause pas de brouillage préjudiciable.

FCC INFORMATION

• FOR CLASS B UNINTENTIONAL RADIATORS:

This equipment has been tested and found to comply with the limits for a Class B digital device, pursuant to part 15 of the FCC Rules. These limits are designed to provide reasonable protection against harmful interference in a residential installation. This equipment generates, uses and can radiate radio frequency energy and, if not installed and used in accordance with the instructions, may cause harmful interference to radio communications. However, there is no guarantee that interference will not occur in a particular installation. If this equipment does cause harmful interference to radio or television reception, which can be determined by turning the equipment off and on, the user is encouraged to try to correct the interference by one or more of the following measures:

- Reorient or relocate the receiving antenna.
- Increase the separation between the equipment and receiver.
- Connect the equipment into an outlet on a circuit different from that to which the receiver is connected.
- Consult the dealer or an experienced radio/TV technician for help.

CAUTION: Changes or modifications to this transceiver, not expressly approved by Icom Inc., could void your authority to operate this transceiver under FCC regulations.

PRECAUTIONS

⚠ **WARNING! NEVER** connect the transceiver to an AC outlet. This may pose a fire hazard or result in an electric shock.

⚠ **WARNING! NEVER** connect the transceiver to a power source of more than 16 V DC or use reverse polarity. This could cause a fire or damage the transceiver.

⚠ **WARNING! NEVER** cut the DC power cable between the DC plug and fuse holder. If an incorrect connection is made after cutting, the transceiver might be damaged.

⚠ **WARNING! NEVER** place the transceiver where normal operation of the vehicle may be hindered or where it could cause bodily injury.

CAUTION: NEVER allow children to touch the transceiver.

CAUTION: NEVER expose the transceiver to rain, snow or any liquids.

USE the specified microphone only. Other microphones have different pin assignments and may damage the transceiver.

DO NOT use or place the transceiver in areas with temperatures below -30°C (-22°F) or above $+60^{\circ}\text{C}$ ($+140^{\circ}\text{F}$), or in areas subject to direct sunlight, such as the dashboard.

DO NOT operate the transceiver without running the vehicle's engine. The vehicle's battery will quickly run out when the transceiver transmits while the vehicle's engine is OFF.

DO NOT place the transceiver in excessively dusty environments.

DO NOT place the transceiver against walls. This will obstruct heat dissipation.

DO NOT use harsh solvents such as benzene or alcohol when cleaning, as they will damage the transceiver surfaces.

BE CAREFUL! The transceiver will become hot when operating continuously for long periods of time.

Icom, Icom Inc. and the Icom logo are registered trademarks of Icom Incorporated (Japan) in Japan, the United States, the United Kingdom, Germany, France, Spain, Russia and/or other countries.

All other products or brands are registered trademarks or trademarks of their respective holders.

TABLE OF CONTENTS

IMPORTANT	i		
EXPLICIT DEFINITIONS	i		
FCC INFORMATION	i		
PRECAUTIONS	ii		
TABLE OF CONTENTS	iii		
1 PANEL DESCRIPTION	1-7		
■ Front panel	1		
■ Function display	2		
■ Programmable function keys	3		
2 BASIC OPERATION	8-14		
■ Turning ON the power	8		
■ Channel selection	8		
■ Call procedure	9		
■ Receiving and transmitting	9		
■ User Set mode	12		
■ Encryption function	13		
■ Emergency transmission	13		
■ Stun function	14		
■ Priority A channel selection	14		
■ Power OFF Emergency function	14		
3 CONNECTION AND MAINTENANCE	15-17		
■ Rear panel connection	15		
■ Supplied Accessories	16		
■ Mounting the transceiver	16		
■ Antenna	17		
■ Fuse replacement	17		
■ Cleaning	17		
■ Options	17		
4 SAFETY TRAINING INFORMATION	18		

■ Front panel

1

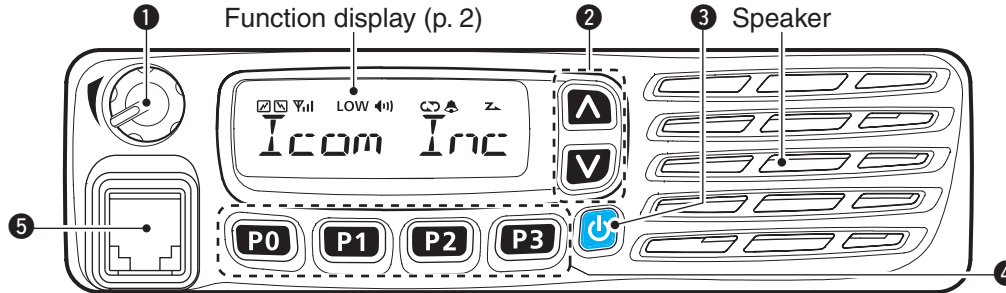

1 AF VOLUME CONTROL KNOB [VOL]

- Rotate the knob to adjust the audio output level.
- Minimum audio level is pre-programmed. (p. 12)

2 UP/DOWN KEYS [CH Up]/[CH Down]

- Push to select an operating channel, etc.
- * The desired function can be assigned by your dealer. (p. 3)

3 POWER KEY [⏻]

- Push to turn the power ON or OFF.
- The following optional functions are available at power ON:
 - Automatic scan start
 - Password prompt

4 DEALER-PROGRAMMABLE KEYS

- Required functions can be independently programmed by your dealer. (p. 3)

5 MICROPHONE CONNECTOR

- Connect the supplied or optional microphone.

NEVER connect non-specified microphones. The pin assignments may be different and may damage the transceiver.

◇ Microphone

The supplied or optional microphone has a PTT switch and a hanger hook.

- The following functions are available when the microphone is ON or OFF hook (depending on the preprogramming):
 - Automatic scan starts when you put it ON hook.
 - Scan is cancelled when you take it OFF hook.
 - Scan is paused when you take it OFF hook.
 - Automatically selects the Priority channel when you take it OFF hook.
 - Sets to the 'Inaudible' mode (mute state) when you put it ON hook.
 - Sets to the 'Audible' mode (unmute state) when you take it OFF hook.

1 PANEL DESCRIPTION

■ Function display

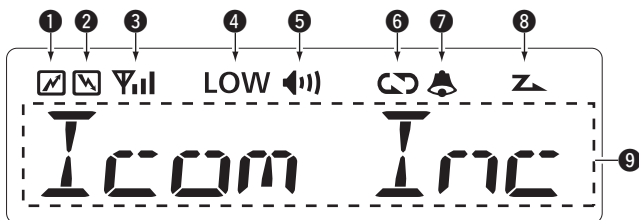

1 TRANSMIT ICON

Appears while transmitting a signal.

2 BUSY ICON

Appears while the channel is busy (receiving).

3 SIGNAL STRENGTH ICON

Shows the relative receive signal strength level.



Weak ← Receive Signal level ⇒ Strong

4 LOW POWER ICON

Appears when low output power is selected.

5 AUDIBLE ICON

- ➔ Appears when the channel is in the 'Audible' (unmute) mode.
- ➔ Appears when a matching signal is received.

6 ENCRYPTION ICON

Appears when the encryption function is activated while operating in the digital mode.

7 BELL ICON

Appears/blinks when a matching 2/5-tone or Digital ID* is received, depending on the preprogramming.

8 SCAN ICON

- ➔ Blinks during a scan.
- ➔ Appears when a scan channel is selected.

9 ALPHANUMERIC DISPLAY

Displays an operating channel number, channel name, User Set mode contents, DTMF code, etc.

* Digital operation only

/// See the operating guide for details of MDC and Digital system operations. Ask your dealer for details.

■ Programmable function keys

The following functions can be assigned to [UP], [DOWN], [P0], [P1], [P2] and [P3] programmable function keys.

Consult your Icom dealer or system operator for details concerning your transceivers programming.

CH UP AND DOWN KEYS

As described in the following topics, after pushing a programmed key, push [CH Up] or [CH Down] to select an option, setting, etc.

ZONE KEY

Push this key, then select the desired zone using [CH Up]/[CH Down].

What is “zone”?— Certain channels are grouped together and assigned to a zone, according to their intended use. For example, ‘Staff A’ and ‘Staff B’ are assigned to a “Business” zone, and ‘John’ and ‘Cindy’ are assigned to a “Private” zone.

SCAN START/STOPKEY

- Push to start and cancel scanning operation.
 - When a scan is started with the Power ON Scan or Automatic scan function, push this key to cancel it. The cancelled scan resumes after the pre-programmed time period.
- Hold down this key for 1 second to display the scan group, then push [CH Up] or [CH Down] to select the desired one.

SCAN ADD/DEL (TAG) KEY

- Push to add the channel to, or delete it from, the current scan group.
 1. Push to display the scan group, then push [CH Up] or [CH Down] to select the desired one.
 2. Push to add the channel to, or delete it from, the selected scan group.
 3. Hold down for 1 second to exit the scan list selection mode.
- While a scan is paused on a non-priority channel, push this key to delete the selected channel from the scan group.
 - ▨ Depending on the setting, the cleared channel is added to the scan group again after the scan is cancelled.

1 PANEL DESCRIPTION

■ Programmable function keys (Continued)

PRIO A/B KEYS

- Push to select the Priority A or Priority B channel.
- Hold down [Prio A (Rewrite)] or [Prio B (Rewrite)] for 1 second to rewrite the operating channel as Priority A or Priority B,

MR-CH 1/2/3/4 KEYS

Push to directly select memory channel 1 to 4.

MONI (AUDI) KEY

- Push to turn the CTCSS (DTCS) or 2/5-tone squelch mute ON or OFF.
 - Only during LMR (Land Mobile Radio) operation, push to open any squelch, or deactivate any mute functions.
 - Only during PMR (Private Mobile Radio) operation, push to activate one or two of the following functions on each channel (depending on the preprogramming):
 - Hold down to unmute the channel ('Audible' mode).
 - Push to mute the channel ('Inaudible' mode).
 - After the communication is finished, push to send a 'reset code' (only 5-tone operation).

 **NOTE:** The 'Audible' (unmute) mode may automatically return to the 'Inaudible' (mute) mode, after the pre-programmed time period.

LIGHT KEY

Push to turn ON the backlight for about 5 seconds, when the backlight function is set to "OFF" in the User Set mode.

LOCK KEY

- Hold down this key until "LOCK ON" is displayed to electronically lock all programmable keys except the following:
[Moni(Audi)], [Lock], [Call] (incl. Call A and Call B), [Emergency], [Surveillance], [Siren], [Lone Worker] and [Light].
- When the Key Lock function is ON, hold down this key until "LOCK OFF" is displayed to turn it OFF.

LONE WORKER KEY

Push to turn the Lone Worker function ON or OFF.

- If the Lone Worker function is turned ON, and no operation occurs during the pre-programmed time period, the Emergency function is automatically turned ON.

HIGH/LOW KEY

Push to select the transmit output power temporarily or permanently, depending on the preprogramming.

- Ask your dealer for the output power level for each selection.

C.TONE CH ENT KEY

Push to enter the continuous tone channel selection mode. Then, push [CH Up] or [CH Down] to change the tone frequency/code setting. The selected channel remains set as the continuous tone channel until another channel is designated as such.

TONE/RAN CH SELECT KEY

- While in analog mode, push to enter the continuous tone channel selection mode. Then push [CH Up] or [CH Down] to select a desired tone frequency/code setting. After the selection, push this key again to set it.
- While in digital mode, push to enter the RAN channel selection mode. Then push [CH Up] or [CH Down] to select a desired RAN code. After the selection, push this key again to set it.
- While in mixed (digital and analog) mode, push to enter the continuous tone channel selection mode. Then push [CH Up] or [CH Down] to select a desired tone frequency/code setting. After setting, push this key to set it. After that, the RAN channel selection mode appears. Select a desired RAN code with [CH Up] or [CH Down]. After the selection, push this key again to set it.

TALK AROUND KEY

Push to turn the Talk Around function ON or OFF.

- The Talk Around function equalizes the transmit frequency to the receive frequency for transceiver-to-transceiver communication.

WIDE/NARROW KEY

Push to toggle the IF bandwidth between wide and narrow.

- The wide passband width can be selected from 25.0 or 20.0 kHz using the CS-F3100D/F5120D CLONING SOFTWARE. (PMR operation only) Ask your dealer for details.

DTMF AUTODIAL KEY

- Push to enter the DTMF channel selection mode, then push [CH Up] or [CH Down] to select the desired DTMF channel.
- After selecting the DTMF channel, push again to transmit the selected DTMF code.

RE-DIAL KEY

Push to transmit the last-transmitted DTMF code.

- TX memories are cleared after turning OFF the transceiver.

EMERGENCY KEY

Hold down for a specified period to transmit an emergency call.

- If you want to cancel the emergency call, hold down the key again, before transmitting it.

1 PANEL DESCRIPTION

■ Programmable function keys (Continued)

CALL KEYS

Push to transmit a 2/5-tone ID code.

- Tone call transmission may be necessary before you call another station, depending on your signalling system.
- [Call A] and/or [Call B] may be selectable when your system employs selective 'Individual/Group' calls. Ask your dealer which call is assigned to each key.

SURVEILLANCE KEY

Push to turn the surveillance function ON or OFF.

When a signal is received, or a key is pushed, while this function is turned ON, the beeps do not sound and the LCD backlight does not light.

SIREN

Hold down for 1 second to sound the siren.

This function can be used for situations other than an emergency alert, such as a security alarm for example.

- The siren can only be stopped by turning OFF the transceiver power.

TX CODE ENTER KEY (PMR operation only)

Push to enter the TX code edit mode, then push [CH Up] or [CH Down] to set a desired digit. (p. 11)

TX CODE CHANNEL SELECT KEY

- ➔ Push to enter the TX code channel selection mode, then push [CH Up] or [CH Down] to set a desired channel. (p. 10)
- ➔ While in the TX code channel selection mode, hold down this key for 1 second to enter the TX code edit mode. Then push [CH Up] or [CH Down] to set a desired digit. (p. 11)

TX CODE CHANNEL UP/DOWN KEYS

Push to select a TX code channel.

ID-MR SELECT KEY (PMR operation only)

- ➔ Push to recall the received ID code.
 - Push this key, then select the ID code using [CH Up]/[CH Down].
 - Up to 5 codes can be memorized.
- ➔ Hold down this key for 1 second to clear the selected ID code.

ENCRYPTION KEY

While operating in the digital mode, push to turn the encryption function ON or OFF.

USER SET MODE KEY

- ➔ Hold down for 1 second to enter the User Set mode.
 - While in the User Set mode, push this key to select an item*, and change the value or setting using [CH Up] or [CH Down].
*Selectable items may differ, depending on the preprogramming.
- ➔ Hold down this key for 1 second again to exit the User Set mode.

The User Set mode is also available via the 'Power ON' function. In this case, all set mode items are available. See page 12.

HOOK SCAN

When the Hook Scan function is pre-programmed, push this key to temporarily disable the function. Push this key again to enable the function.

Ext. CH Sel Mode KEY

Push to turn the Ext. CH Select function ON or OFF.

When the function is turned ON, memory channels can be selected with only and external input.

When the function is turned OFF, memory channels can be selected by pushing [CH Up] or [CH Down], and cannot be externally controlled.

- This function is available when the external unit, such as a dimmer control is connected to the transceiver with an optional OPC-1939 or OPC-2078 cable (p. 17).
- Ask your dealer for more details on external input operation.

POWER OFF EMERGENCY

While holding down this key, turn OFF the transceiver to activate the Power OFF Emergency function. This function makes the transceiver transmit emergency calls, even though it appears to be powered OFF. (p. 14)

2

BASIC OPERATION

■ Turning ON the power

- ① Push **[PWR]** to turn ON the power.
- ② If the transceiver is programmed for a start up password, input the digit codes as directed by your dealer.
 - The keys shown below can be used for password input:
The transceiver detects numbers in the same block as identical. Therefore “01234” and “56789” are the same.

KEY	P0	P1	P2	P3	V
NUMBER	0 5	1 6	2 7	3 8	4 9

- ③ If the “PASSWORD” indication does not clear after inputting 6 digits, the input code number may be incorrect. Turn OFF the power and re-enter your password.

■ Channel selection

There are several methods to select channels, and they may differ, depending on your system set up.

NON-ZONE TYPE:

To select the desired operating channel:

- Push [CH Up] or [CH Down].
- Push one of [MR-CH 1] to [MR-CH 4].

ZONE TYPE:

To select the desired operating channel:

Push [Zone], then push [CH Up] or [CH Down].

AUTOMATIC SCAN TYPE:

Channel setting is not necessary for this type. When turning ON the power, the transceiver automatically starts scanning. Scanning stops when a signal is detected.

■ Call procedure

When your system employs tone signaling (excluding CTCSS and DTCS), a call procedure may be necessary prior to voice transmission. The tone signalling employed may be a selective calling system which allows you to call only specific station(s), and prevents unwanted stations from contacting you.

- ① Select the desired TX code channel or 2/5-tone code, according to your System Operator's instructions.
 - This may not be necessary, depending on the preprogramming.
 - Refer to pages 10 and 11 for selection.
- ② Push [Call] (assigned to one of the dealer programmable keys).
- ③ After transmitting, the remainder of your communication can be carried out in the normal fashion.

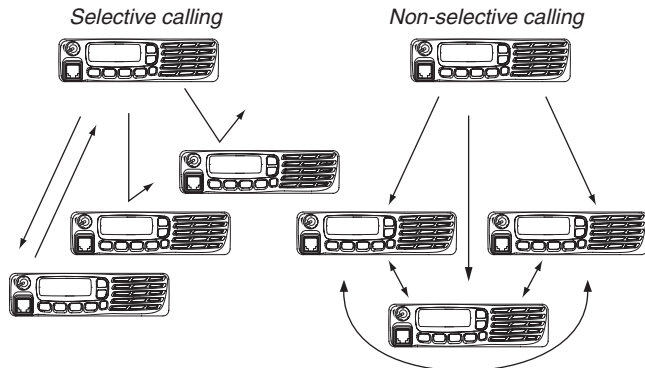

■ Receiving and transmitting

Receiving:

- ① Hold down [ON] for 1 second to turn ON the power.
- ② Push [CH Up] or [CH Down] to select a channel.
- ③ When receiving a call, rotate [VOL] to adjust the audio output level to a comfortable listening level.

NOTE: Depending on the preprogramming, the transceiver automatically transmits the microphone audio for the specified time period*, when a matched RX code signal is received.

- HM-148G or HM-152 HAND MICROPHONE is required.
- * Depending on the preprogramming. Ask your dealer for details.

Transmitting:

Wait for the channel to become clear to avoid interference.

- ① Take the microphone OFF hook.
 - The 'Audible' mode is selected.
 - A priority channel may be automatically selected.
- ② Wait for the channel to become clear.
 - The channel is busy when the BUSY icon appears on the LCD.
- ③ While holding down [PTT], speak into the microphone at your normal voice level.
- ④ Release [PTT] to return to receive.

IMPORTANT: To maximize the readability of your signal;

1. Pause briefly after pushing [PTT].
2. Hold the microphone 5 to 10 cm (2 to 4 inches) from your mouth, then speak into the microphone at a normal voice level.

2 BASIC OPERATION

■ Receiving and transmitting (Continued)

◇ Transmitting notes

• Transmit inhibit function

The transceiver has several inhibit functions which restrict transmission under the following conditions:

- The channel is in the 'Inaudible' (mute) mode; "🔇" (Audible icon) does not appear.
- The channel is busy. However, depending on the pre-programmed settings, you can transmit when the call includes an unmatching (or matching) CTCSS (DTCS), RAN code, or Individual or Talkgroup ID.
- The selected channel is a 'receive only' channel.

• Time-out timer

If continuous transmission exceeds the pre-programmed time-out timer limit, the transmission is cut off.

• Penalty timer

After the transmission is cut off by the time-out timer, transmission is further inhibited for the pre-programmed penalty timer period.

• PTTID call

The transceiver automatically sends the 5-tone, DTMF, BIIS or digital ANI ID code when [PTT] is pushed (at the beginning of the transmission), and/or when it is released (at the end of transmission), depending on the preprogramming. A PTTID call also be made with the MDC 1200 signaling system.

◇ TX code channel selection

If the transceiver has a key assigned to [TX Code CH Select], the display can be toggled between the operating channel number (or name) and TX code channel number (or name). When the TX code channel number (or name) is displayed, [CH Up] or [CH Down] selects the TX code channel.

USING [TX CODE CH SELECT] KEY:

- ① Push [TX Code CH Select]— a TX code channel number (or name) appears.
- ② Push [CH Up] or [CH Down] to select the desired TX code channel.
- ③ After selecting, push [TX Code CH Select] to set.
 - Return to the stand-by mode.
- ④ Push [Call] to transmit the selected TX code.

USING [TX CODE CH UP]/[TX CODE CH DOWN] KEY:

If the transceiver has a key assigned to [TX Code CH Up] or [TX Code CH Down], the programmed TX code channel can be directly selected when pushed.

◇ TX code number edit (PMR operation only)

If the transceiver has a key assigned to [TX Code CH Select] or [TX Code Enter], TX code contents can be edited within the allowable digits.

USING [TX CODE CH SELECT] KEY:

- ① Push [TX Code CH Select] to enter the TX code channel selection mode.
 - Select the desired channel before entering the TX code channel selection mode, if necessary.
- ② Hold down [TX Code CH Select] for 1 second to enter the TX code edit mode.
 - The digit to be edited blinks.
- ③ Push [TX Code CH Select] to select the desired digit to be edited.
- ④ Push [CH Up] or [CH Down] to select the desired digit.
- ⑤ Push [TX Code CH Select] to set. The digit to the right will automatically blink.
- ⑥ Repeat ④ and ⑤ to edit all allowable digits.
- ⑦ After editing, push [TX Code CH Select] to set.
 - Return to the stand-by mode.
- ⑧ Push [Call] to transmit.

USING [TX CODE ENTER] KEY:

- ① Push [TX Code Enter] to enter the TX code edit mode.
 - The digit to be edited blinks.
- ② Push [TX Code Enter] to select the desired digit to be edited.
- ③ Push [CH Up] or [CH Down] to select the desired digit.
- ④ Push [TX Code Enter] to set. The digit to the right will automatically blink.
- ⑤ Repeat ③ and ④ to edit all allowable digits.
- ⑥ After editing, push [TX Code Enter] to set.
 - Return to the stand-by mode.
- ⑦ Push [Call] to transmit.

◇ DTMF transmission

If the transceiver has a key assigned to [DTMF Autodial], the automatic DTMF transmission function is available. Up to 8 DTMF channels are selectable.

- ① Push [DTMF Autodial]— a DTMF channel appears.
- ② Push [CH Up] or [CH Down] to select the desired DTMF channel.
- ③ Push [DTMF Autodial] to transmit the DTMF code.

2 BASIC OPERATION

■ User Set mode

The User Set mode can be accessed with the 'Power ON' function. In this case, all set mode items are selectable. The User Set mode allows you to set seldom-changed settings, and you can "customize" the transceiver operation to suit your preferences and operating style.

NOTE: While in the User Set mode, [Up], [Down] and [P0] activate regardless of the assigned key functions.

Entering the User Set mode:

- 1 Push [P0] to turn OFF the power.
- 2 While holding down [P1] and [P2], push [P0] to turn ON the power.
 - Hold down [P1] and [P2] continuously until "SET MODE" appears on the display.

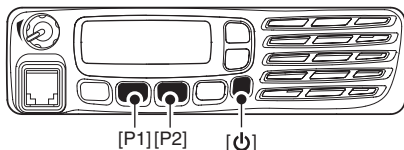

- 3 Hold down [P0] for 1 second to enter the User Set mode.
 - To exit the User Set mode, hold down [P0] for 1 second again.

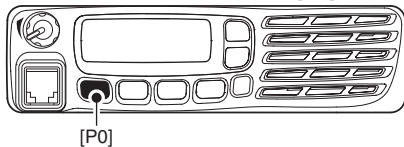

- 4 Push [P0] several times to select the appropriate item, then push [Up] or [Down] to set the desired level or setting.
 - Selectable Set mode items are **Backlight, Beep ON/OFF, Beep Level, Ringer Level, SQL Level, AF Min Level, Mic Gain, Battery Voltage, Horn, Signal Moni, Lone Worker and System Info.**

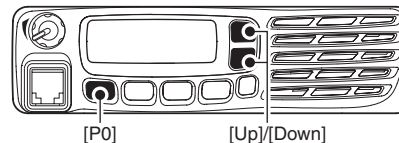

- 5 Hold down [P0] for 1 second to turn OFF the power, then ON again to return to the normal operating mode.

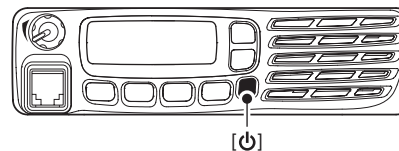

The User Set mode can also be selected using a programmable key. Please refer to the [User Set Mode] section on page 6 for instructions on how to use the key assigned to the User Set mode.

[User Set Mode] can be used for the quick item selection. Set "Enable" for the often used items with the CS-F3100D/F5120D CLONING SOFTWARE.

■ Emergency transmission

When [Emergency] is held down for the specified time period*, the emergency signal is transmitted on the specified emergency channel once or repeatedly.

When no emergency channel is specified, the call is transmitted on the operating channel.

The repeat emergency signal is automatically transmitted until you turn OFF the power.

Depending on the preprogramming, receiving a matching 5-tone code cancels the transmission.

If you want to cancel the Emergency function, hold down [Emergency] for the pre-programmed time period again before transmitting the call.

If your transceiver is programmed for Silent operation, you can transmit emergency calls without the beep sounding and the LCD indication change.

IMPORTANT: It is recommended to set an emergency channel individually to provide the certain emergency call operation.

◇ NOTES

Depending on the preprogramming, the following functions are automatically activated. Ask your dealer for details.

• Auto TX function

After the emergency call transmission, audio from the microphone is automatically transmitted for a specified time period.*

- The HM-148G or HM-152 hand microphone is required.



• Auto RX function

After the emergency call transmission, the transceiver stands by in the audible mode for the specified time period.*

* Depending on the preprogramming. Ask your dealer for details.

■ Encryption function

The encryption function provides private communication between stations while operating in the digital mode.

- ① Push [Encryption] to turn ON the encryption function.
 - “” (Encryption icon) appears.
- ② Push [Encryption] again to turn OFF the encryption function.
 - “” disappears.

2 BASIC OPERATION

■ Stun function

The dispatcher can send a 2/5-tone signal that will stun, kill or revive your transceiver.

When the Stun ID is received, a beep sounds*, and the transceiver becomes unusable. Receiving a Revive command or entering password* (p. 8) is necessary to operate the transceiver again in this case.

When the Kill ID is received, a beep sounds*, and the transceiver becomes unusable (the transceiver switches to the cloning required condition). Cloning the transceiver is necessary to operate the transceiver again in this case.

* Depending on the preprogramming. Ask your dealer for details.

/// See the operating guide for details of the Stun function with the MDC and Digital system operations. Ask your dealer for details.

■ Power OFF Emergency function

When the transceiver has a key assigned to Power OFF Emergency, you can use the function.

This function makes the transceiver transmit emergency calls, even though it appears to be powered OFF.

To activate the Power OFF Emergency function, turn the power OFF while holding down [Power OFF Emergency].

When the function is activated, any key operation, the ON/OFF Hook and Lone Worker functions become invalid. The beep, display and speaker are turned OFF as well.

On the other hand, the transceiver can transmit emergency calls according to the pre-programmed emergency settings.

Depending on the pre-programmed settings, the Remote Monitor function can also be used (digital operation only).

To cancel the Power OFF Emergency function and restore the transceiver, turn the power ON.

■ Priority A channel selection

When one of the following operations is performed, the transceiver automatically selects the Priority A channel.

- **Turning ON the power**

The Priority A channel is selected each time the transceiver power is turned ON.

- **Auto Reset**

The Priority A channel is selected when the Auto Reset timer ends.

- **OFF hook**

The Priority A channel is selected when you take the microphone OFF hook.

■ Rear panel connection

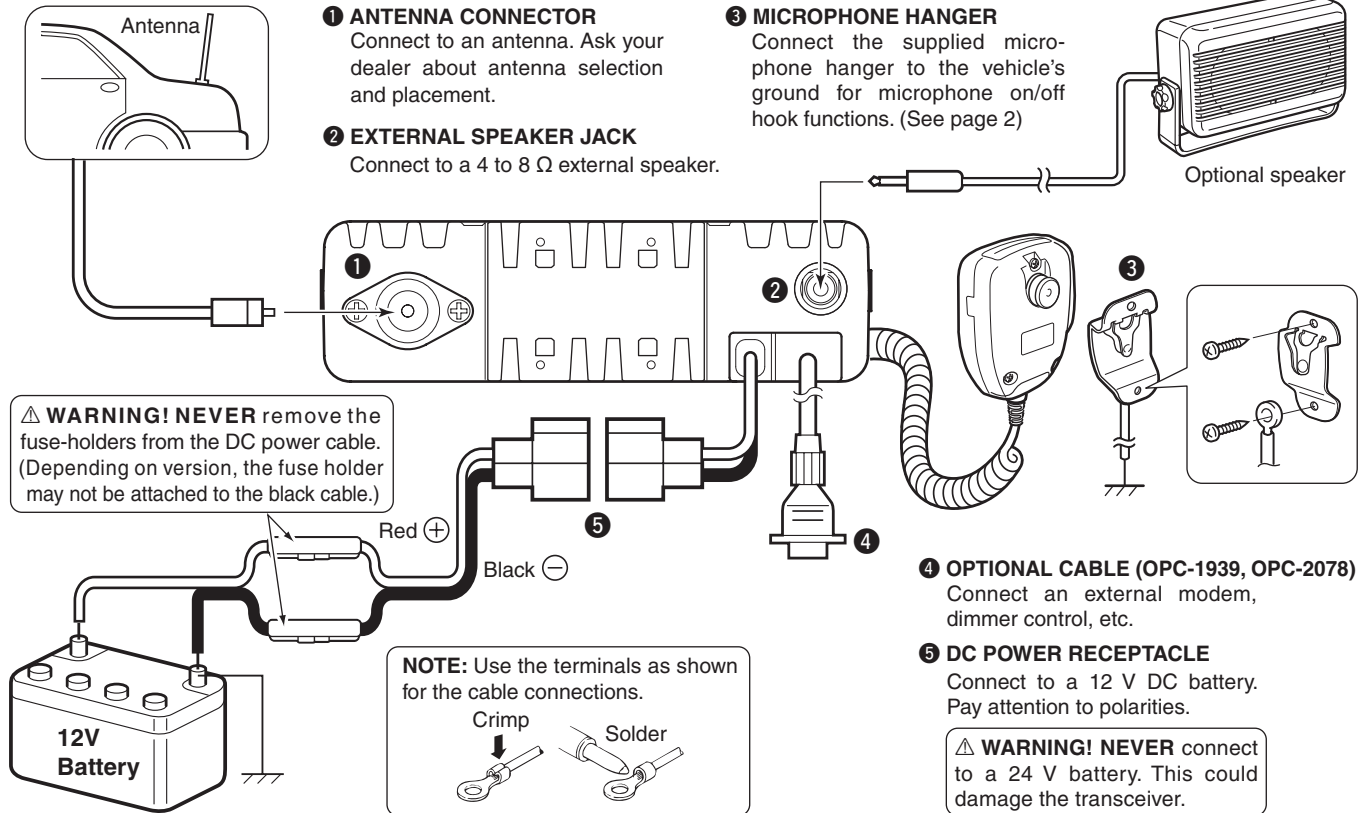

2

3

3 CONNECTION AND MAINTENANCE

■ Supplied Accessories

Microphone

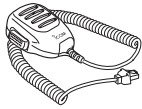

Microphone hanger and screw set



Microphone hanger cable



DC power cable

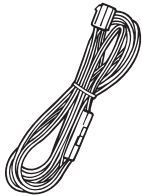

Function name stickers*

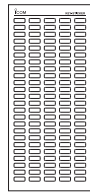

Mounting bracket

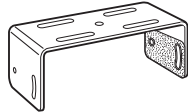

Flat washers



Nuts



Mounting screws (5x12)



Spring washers



Bracket bolts



Self-tapping screws (5x20)



*Used for labelling the programmable function keys according to their assigned functions.

■ Mounting the transceiver

The universal mounting bracket supplied with your transceiver allows overhead mounting.

- Mount the transceiver securely with the 4 supplied screws to a thick surface which can support more than 1.5 kg (3.3 lb).

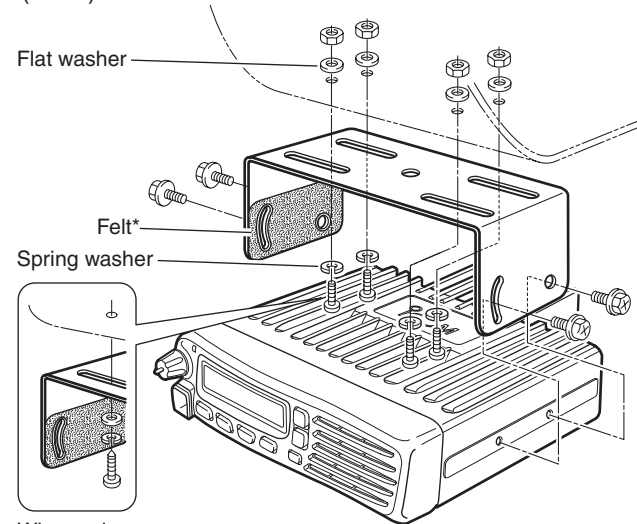

When using self-tapping screws

*Felt reduces the effects of vibration.

■ Antenna

A key element in the performance of any communication systems is its antenna. Contact your dealer for more information regarding antennas and how to install them.

■ Fuse replacement

A fuse is installed in each fuse holder of the supplied DC power cable*. If a fuse blows or the transceiver stops functioning, track down the source of the problem if possible, repair it and then replace the damaged fuse with a new rated one.

*Depending on version, only one fuse holder may be attached.

□ Fuse rating: 10 A (for one fuse holder)/20 A (for Two fuse holders)

USE the applicable fuse only.

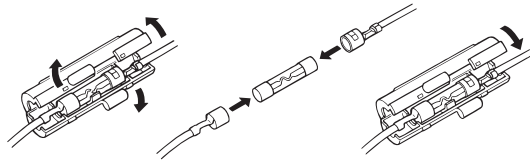

■ Cleaning

If the transceiver becomes dusty or dirty, wipe it clean with a soft, dry cloth.



DO NOT use harsh solvents such as benzine or alcohol, as they will damage the transceiver surfaces.

■ Options

- **OPC-1132A/OPC-347** DC POWER CABLE
Two fuse holders are attached. **USE** the 20 A fuse only.
OPC-1132A: 3 m (9.8 ft)
OPC-347: 7 m (23 ft)
- **OPC-1939/OPC-2078** ACC CABLE
Allows you to connect to an external terminal.
OPC-1939: D-sub 15-pin, OPC-2078: D-sub 25-pin
- **HM-152/HM-152T/HM-148G** HAND MICROPHONE
HM-152 : Hand microphone
HM-152T : DTMF microphone
HM-148G: Self ground heavy duty microphone
- **SM-26** DESKTOP MICROPHONE
- **SP-22/SP-30** EXTERNAL SPEAKER
Input impedance : 4 Ω
SP-22 : Rated input; 5 W, Max. input; 7 W
SP-30 : Rated input; 20 W, Max. input; 30 W

Approved Icom optional equipment is designed for optimal performance when used with an Icom transceiver.

Icom is not responsible for the destruction or damage to an Icom transceiver in the event the Icom transceiver is used with equipment that is not manufactured or approved by Icom.

4

SAFETY TRAINING INFORMATION



Your Icom radio generates RF electromagnetic energy during transmit mode. This radio is designed for and classified as “Occupational Use Only”, meaning it must be used only during the course of employment by individuals aware of the hazards, and the ways to minimize such hazards. This radio is NOT intended for use by the “General Population” in an uncontrolled environment.

- For compliance with FCC and Industry Canada RF Exposure Requirements, the transmitter antenna installation shall comply with the following two conditions:

1. The transmitter antenna gain shall not exceed 0 dBi.
2. IC-F5121D:

The antenna is required to be located outside of a vehicle and kept at a distance of 45 centimeters or more between the transmitting antenna of this device and any persons during operation. For small vehicle as worst case, the antenna shall be located on the roof top at any place on the centre line along the vehicle in order to achieve 45 centimeters separation distance. In order to ensure this distance is met, the installation of the antenna must be mounted at least 45 centimeters away from the nearest edge of the vehicle in order to protect against exposure to bystanders.

2. IC-F6121D:

The antenna is required to be located outside of a vehicle and kept at a distance of 37 centimeters or more between the transmitting antenna of this device and any persons during operation. For small vehicle as worst case, the antenna shall be located on the roof top at any place on the centre line along the vehicle in order to achieve 37 centimeters separation distance. In order to ensure this distance is met, the installation of the antenna must be mounted at least 37 centimeters away from the nearest edge of the vehicle in order to protect against exposure to bystanders.

3. IC-F5121D:

Transmit only when people outside the vehicle are at least the recommended minimum distance of 100 centimeters away from the properly installed antenna. This separation distance will ensure that there is sufficient distance from a properly installed externally-mounted antenna to satisfy the RF exposure requirements in the applicable RF exposure compliance standards.

3. IC-F6121D:

Transmit only when people outside the vehicle are at least the recommended minimum distance of 82 centimeters away from the properly installed antenna. This separation distance will ensure that there is sufficient distance from a properly installed externally-mounted antenna to satisfy the RF exposure requirements in the applicable RF exposure compliance standards.

**CAUTION**

To ensure that your exposure to RF electromagnetic energy is within the FCC allowable limits for occupational use, always adhere to the following guidelines:

- **DO NOT** operate the radio without a proper antenna attached, as this may damage the radio and may also cause you to exceed FCC RF exposure limits. A proper antenna is the antenna supplied with this radio by the manufacturer or an antenna specifically authorized by the manufacturer for use with this radio.
- **DO NOT** transmit for more than 50% of total radio use time (“50% duty cycle”). Transmitting more than 50% of the time can cause FCC RF exposure compliance requirements to be exceeded. The radio is transmitting when the “transmit indicator” appears on the LCD. You can cause the radio to transmit by pressing the “PTT” switch.

Electromagnetic Interference/Compatibility

During transmissions, your Icom radio generates RF energy that can possibly cause interference with other devices or systems. To avoid such interference, turn OFF the radio in areas where signs are posted to do so. **DO NOT** operate the transmitter in areas that are sensitive to electromagnetic radiation such as hospitals, aircraft, and blasting sites.

Count on us!

A-6903H-1EX-0a

Printed in Japan

© 2010–2011 Icom Inc.

Printed on recycled paper with soy ink.

Icom Inc.

1-1-32 Kamiminami, Hirano-ku, Osaka 547-0003, Japan

INFORMATION EN MATIÈRE DE SÉCURITÉ



AVERTISSEMENT

Votre radio Icom produit une énergie électromagnétique de radiofréquences (RF), en mode de transmission. Cette radio est conçue pour un «usage professionnel seulement» et classée comme tel, ce qui signifie qu'elle doit être utilisée uniquement dans le cadre d'un travail par des personnes conscientes des dangers et des mesures visant à minimiser ces dangers. Elle **N'EST PAS** conçue pour une «utilisation grand public», dans un environnement non contrôlé.

- Afin de satisfaire aux exigences de la FCC et d'Industrie Canada en matière d'exposition aux RF, il est nécessaire que l'antenne soit installée conformément aux trois conditions suivantes:

1. Le gain de l'antenne du radio émetteur ne doit pas dépasser 0dBi.

2. IC-F5121D:

Il faut que l'antenne émettrice de cet appareil soit placée à l'extérieur d'un véhicule et tenue éloignée d'au moins 45 centimètres de toute personne pendant le fonctionnement. Dans le pire des cas, pour un petit véhicule, l'antenne doit être placée sur le toit, n'importe où dans l'axe central du véhicule, afin de respecter une distance de 45 cm du bord le plus rapproché du véhicule et ainsi éviter que les personnes présentes soient exposées.

2. IC-F6121D:

Il faut que l'antenne émettrice de cet appareil soit placée à l'extérieur d'un véhicule et tenue éloignée d'au moins 37 centimètres de toute personne pendant le fonctionnement. Dans le pire des cas, pour un petit véhicule, l'antenne doit être placée sur le toit, n'importe où dans l'axe central du véhicule, afin de respecter une distance de 37 cm du bord le plus rapproché du véhicule et ainsi éviter que les personnes présentes soient exposées.

3. IC-F5121D:

Émettre uniquement lorsque les personnes à l'extérieur du véhicule se trouvent à au moins la distance minimale recommandée de 100 cm de l'antenne correctement installée. Cette distance de sécurité assurera que les personnes soient placées suffisamment loin d'une antenne correctement fixée à l'extérieur pour satisfaire aux exigences en matière d'exposition aux RF, en vertu des normes de conformité applicables.

3. IC-F6121D:

Émettre uniquement lorsque les personnes à l'extérieur du véhicule se trouvent à au moins la distance minimale recommandée de 82 cm de l'antenne correctement installée. Cette distance de sécurité assurera que les personnes soient placées suffisamment loin d'une antenne correctement fixée à l'extérieur pour satisfaire aux exigences en matière d'exposition aux RF, en vertu des normes de conformité applicables.



MISE EN GARDE

Afin de vous assurer que votre exposition à une énergie électromagnétique de RF se situe dans les limites permises par la FCC pour une utilisation grand public, veuillez en tout temps respecter les directives suivantes:

- **NE PAS** faire fonctionner la radio sans qu'une antenne appropriée y soit fixée, car ceci risque d'endommager la radio et causer une exposition supérieure aux limites établies par la FCC. L'antenne appropriée est celle qui est fournie avec cette radio par le fabricant ou une antenne spécialement autorisée par le fabricant pour être utilisée avec cette radio.
- **NE PAS** émettre pendant plus de 50 % du temps total d'utilisation de l'appareil («50 % du facteur d'utilisation»). Émettre pendant plus de 50 % du temps total d'utilisation peut causer une exposition aux RF supérieure aux limites établies par la FCC. La radio est en train d'émettre lorsque le témoin du mode de transmission s'affiche sur l'écran ACL. La radio émettra si vous appuyez sur le bouton du microphone.

Interférence électromagnétique et compatibilité

En mode de transmission, votre radio Icom produit de l'énergie de RF qui peut provoquer des interférences avec d'autres appareils ou systèmes. Pour éviter de telles interférences, mettez la radio hors tension dans les secteurs où une signalisation l'exige. **NE PAS** faire fonctionner l'émetteur dans des secteurs sensibles au rayonnement électromagnétique tels que les hôpitaux, les aéronefs et les sites de dynamitage.