



INSTRUCTION MANUAL

HF/VHF/UHF ALL MODE TRANSCEIVER

IC-7100



This device complies with Part 15 of the FCC Rules. Operation is subject to the following two conditions: (1) this device may not cause harmful interference, and (2) this device must accept any interference received, including interference that may cause undesired operation.

WARNING: MODIFICATION OF THIS DEVICE TO RECEIVE CELLULAR RADIOTELEPHONE SERVICE SIGNALS IS PROHIBITED UNDER FCC RULES AND FEDERAL LAW.

FOREWORD

Thank you for purchasing this fine Icom product. The IC-7100 HF/VHF/UHF ALL MODE TRANSCEIVER is designed and built with Icom's superior technology and craftsmanship combining traditional analog technologies with the new digital technology, Digital Smart Technologies for Amateur Radio (D-STAR), for a balanced package. With proper care, this product should provide you with years of trouble-free operation.

We thank you for making your IC-7100 your radio of choice, and hope you agree with Icom's philosophy of "technology first." Many hours of research and development went into the design of your IC-7100.

FEATURES

- *IF DSP features*
- *All mode capability covering 160–2 m and 70 cm (depending on version)*
- *Compact with separated front panel*
- *±0.5 ppm of high frequency stability*
- *Baudot RTTY demodulator*
- *Selectable SSB transmission passband width (For both higher and lower pass frequency)*
- *Standard voice synthesizer/voice recorder*
- *SD card slot ready for several memory storage*
- *Voice recorder to records your communication*
- *DV mode (Digital voice + Low-speed data communication) operation-ready*
 - *Text message and call sign exchange*
 - *Transmit position data*
- *DR (D-STAR Repeater) mode and repeater list allow you to easily operate using a D-STAR repeater*

Icom, Icom Inc. and the Icom logo are registered trademarks of Icom Incorporated (Japan) in Japan, the United States, the United Kingdom, Germany, France, Spain, Russia and/or other countries.

EXPLICIT DEFINITIONS

WORD	DEFINITION
⚠ DANGER!	Personal death, serious injury or an explosion may occur.
⚠ WARNING!	Personal injury, fire hazard or electric shock may occur.
CAUTION	Equipment damage may occur.
NOTE	Recommended for optimum use. No risk of personal injury, fire or electric shock.

IMPORTANT

READ ALL INSTRUCTIONS carefully and completely before using the transceiver.

SAVE THIS INSTRUCTION MANUAL— This instruction manual contains important operating instructions for the IC-7100.

FCC INFORMATION

• FOR CLASS B UNINTENTIONAL RADIATORS:

This equipment has been tested and found to comply with the limits for a Class B digital device, pursuant to part 15 of the FCC Rules. These limits are designed to provide reasonable protection against harmful interference in a residential installation. This equipment generates, uses and can radiate radio frequency energy and, if not installed and used in accordance with the instructions, may cause harmful interference to radio communications. However, there is no guarantee that interference will not occur in a particular installation. If this equipment does cause harmful interference to radio or television reception, which can be determined by turning the equipment off and on, the user is encouraged to try to correct the interference by one or more of the following measures:

- Reorient or relocate the receiving antenna.
- Increase the separation between the equipment and receiver.
- Connect the equipment into an outlet on a circuit different from that to which the receiver is connected.
- Consult the dealer or an experienced radio/TV technician for help.

CAUTION: Changes or modifications to this device, not expressly approved by Icom Inc., could void your authority to operate this device under FCC regulations.

PRECAUTIONS

⚠ **DANGER HIGH VOLTAGE! NEVER** touch an antenna or internal antenna connector during transmission. This may result in an electrical shock or burn.

⚠ **WARNING RF EXPOSURE!** This device emits Radio Frequency (RF) energy. Extreme caution should be observed when operating this device. If you have any questions regarding RF exposure and safety standards please refer to the Federal Communications Commission Office of Engineering and Technology's report on Evaluating Compliance with FCC Guidelines for Human Radio Frequency Electromagnetic Fields (OET Bulletin 65).

⚠ **WARNING! NEVER** operate the transceiver while driving a vehicle. Safe driving requires your full attention—anything less may result in an accident.

⚠ **WARNING! NEVER** operate the transceiver with an earphone, headphones or other audio accessories at high volume levels. Hearing experts advise against continuous high volume operation. If you experience a ringing in your ears, reduce the volume level or discontinue use.

⚠ **WARNING! NEVER** apply AC power to the [DC13.8V] connector on the transceiver rear panel. This could cause a fire or damage the transceiver.

⚠ **WARNING! NEVER** apply more than 16 V DC to the [DC13.8V] connector on the transceiver rear panel or use reverse polarity. This could cause a fire or damage the transceiver.

⚠ **WARNING! NEVER** cut the DC power cable between the DC plug and fuse holder. If an incorrect connection is made after cutting, the transceiver might be damaged.

⚠ **WARNING! NEVER** let metal, wire or other objects touch any internal part or connectors on the rear panel of the transceiver. This may result in an electric shock or this could cause a fire or damage the transceiver.

⚠ **WARNING! NEVER** operate or touch the transceiver with wet hands. This may result in an electric shock or may damage the transceiver.

⚠ **WARNING!** Immediately turn the transceiver power OFF and remove the power cable if it emits an abnormal odor, sound or smoke. Contact your Icom dealer or distributor for advice.

CAUTION: NEVER expose the transceiver to rain, snow or any liquids.

CAUTION: NEVER change the internal settings of the transceiver. This may reduce transceiver performance and/or damage to the transceiver.

DO NOT operate the transceiver near unshielded electrical blasting caps or in an explosive atmosphere.

DO NOT use harsh solvents such as benzine or alcohol to clean the transceiver, as they will damage the transceiver's surfaces. If the transceiver becomes dusty or dirty, wipe it clean with a soft, dry cloth.

DO NOT use or place the transceiver in areas with temperatures below -10°C ($+14^{\circ}\text{F}$) or above $+60^{\circ}\text{C}$ ($+140^{\circ}\text{F}$). Be aware that temperatures on a vehicle's dashboard can exceed $+80^{\circ}\text{C}$ ($+176^{\circ}\text{F}$), resulting in permanent damage to the transceiver if left there for extended periods.

DO NOT place the transceiver in excessively dusty environments or in direct sunlight.

DO NOT place the transceiver against walls or putting anything on top of the transceiver. This will obstruct heat dissipation.

Place the transceiver in a secure place to avoid inadvertent use by children.

During mobile operation, **NEVER** place the transceiver where air bag deployment may be obstructed.

During mobile operation, **DO NOT** place the transceiver where hot or cold air blows directly onto it.

During mobile operation, **DO NOT** operate the transceiver without running the vehicle's engine. When the transceiver's power is ON and your vehicle's engine is OFF, the vehicle's battery will soon become exhausted.

Make sure the transceiver power is OFF before starting the vehicle engine. This will avoid possible damage to the transceiver by ignition voltage spikes.

During maritime mobile operation, keep the transceiver and microphone as far away as possible from the magnetic navigation compass to prevent erroneous indications.

BE CAREFUL! The rear panel will become hot when operating the transceiver continuously for long periods of time.

BE CAREFUL! If a linear amplifier is connected, set the transceiver's RF output power to less than the linear amplifier's maximum input level, otherwise, the linear amplifier will be damaged.

Use Icom microphones only (supplied or optional). Other manufacturer's microphones have different pin assignments, and connection to the IC-7100 may damage the transceiver.

SUPPLIED ACCESSORIES

The following accessories are supplied with the transceiver.

- ① Hand microphone 1
- ② Control cable..... 1
- ③ Ferrite bead..... 1
- ④ 3.5 (d) mm plug..... 1
- ⑤ ACC cable 1
- ⑥ DC power cable* (OPC-1457) 1
or (OPC-1457R) 1
- ⑦ Spare fuse (ATC 5 A) 1
- ⑧ USB cable 1
- ⑨ CD..... 1
- ⑩ Spare fuse (ATC 30 A) 2

* Depending on the version.

* Not supplied, or the shape is different, depending on the transceiver version.

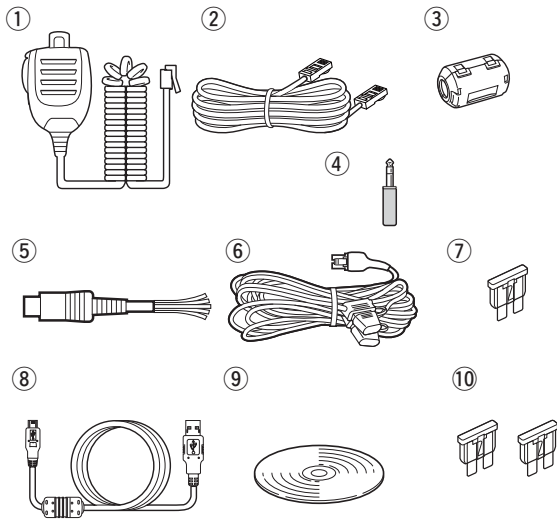

Section 1

PANEL DESCRIPTION

Front panel (Controller).....	1-2
◇ Display.....	1-8
◇ Display.....	1-9
◇ Display.....	1-10
◇ Display.....	1-11
◇ M-1 (M-1 menu) Display.....	1-11
◇ M-2 (M-2 menu) Display.....	1-11
◇ M-3 (M-3 menu) Display.....	1-11
◇ D-1 (D-1 menu) Display.....	1-11
◇ D-2 (D-2 menu) Display.....	1-11

1 PANEL DESCRIPTION

Front panel (Controller)



1 POWER SWITCH/AF VOLUME [PWR]/[AF] (p. 44)

- ➔ Push to turn ON the transceiver power.
 - First, confirm the DC power source is turned ON.
- ➔ Hold down for 1 second to turn OFF the power.
- ➔ Rotate to adjust audio output level.

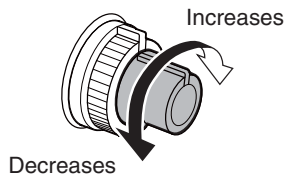

2 RF GAIN CONTROL/ SQUELCH CONTROL [RF/SQL] (p. 44)

Rotate to adjust the RF gain and squelch threshold level.

The squelch removes noise output to the speaker when no signal is received. (closed condition)



- The squelch is particularly effective for AM and FM, but also works in other modes.
- The 12 to 1 o'clock position is recommended for the most effective use of the [RF/SQL] control.
- [RF/SQL] operates as only an RF gain control in SSB, CW and RTTY (Squelch is fixed open), or a squelch control in AM, FM and DV (RF gain is fixed at maximum sensitivity), when "Auto" is selected as the "RF/SQL Control" item in the "Function" Set mode. (p. 162)

[SET] > Function > **RF/SQL Control**

• When used as an RF gain/squelch control

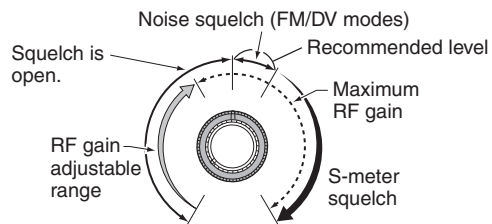

• When used as an RF gain control

(Squelch is fixed open; SSB, CW and RTTY only)

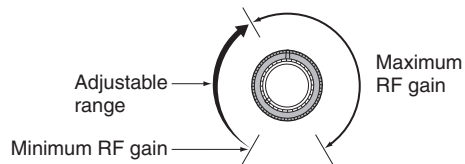

While rotating the RF gain control, a faint noise may be heard. This comes from the DSP unit and does not indicate an equipment malfunction.

• When used as a squelch control

(RF gain is fixed at maximum.)

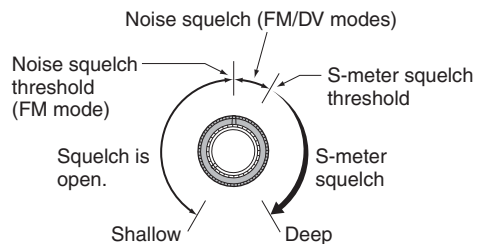

1 PANEL DESCRIPTION

Front panel (Controller) (Continued)



3 TX/RX LED

- ➔ Lights green when the squelch opens, or a signal is received.
- ➔ Lights red during transmit.

4 MEMORY BANK CONTROL [BANK]⊙

- When the both PBT and RIT LEDs are OFF
Rotate to select a Memory bank.
- When the PBT LED (6) rights green
(Mode: SSB/CW/RTTY/AM)
Rotate to adjust the receiver's IF filter passband width using the DSP circuit.
- When the RIT LED (7) rights orange
Disable this control.

5 M-CH CONTROL/CLEAR KEY [M-CH]/[CLR]⊙

- Push to select the action of the [M-CH/BANK]⊙ controls as the Memory/Bank selection, PBT control or RIT control.
- When the both RIT and PBT LEDs are OFF
Rotate to select a Memory channel.
 - When the RIT LED rights orange
 - ➔ Rotate to adjust the RIT frequency shift.
 - The frequency shift range is ±9.99 kHz in 10 Hz steps. The control tunes in 1 Hz steps when the operating frequency readout is set to the 1 Hz step readout.
 - ➔ Hold down for 1 second to clear the RIT shift frequency.

✓ What is the RIT function?

The RIT (Receiver Incremental Tuning) shifts the receive frequency without shifting the transmit frequency. This is useful for fine tuning stations calling you off-frequency or when you prefer to listen to slightly different-sounding voice characteristics, and so on.

○ When the PBT LED rights green

(Mode: SSB/CW/RTTY/AM)

- ➔ Rotate to adjust the receiver's IF filter passband width using the DSP circuit.
- ➔ Hold down for 1 second to reset the PBT settings.
 - The PBT is adjustable in 50 Hz steps in the SSB/CW/RTTY modes, and 200 Hz in the AM mode. In this time, the shift value changes in 25 Hz steps in the SSB/CW/RTTY modes, and 100 Hz in the AM mode.
 - The PBT controls function as an IF shift control.

✓ What is the PBT control?

The PBT function electronically modifies the IF passband width to reject interference. This transceiver uses the DSP circuit for the PBT function.

6 PBT LED

- Lights green when the [M-CH/BANK]⊙ controls act as the PBT control.
- Push the [M-CH]⊙ switch to select as the PBT control.

7 RIT LED

- ➔ Lights orange when the RIT function turns ON.
- ➔ Lights orange when the [M-CH/BANK]⊙ controls act as the RIT control.
 - Push the [M-CH]⊙ switch to select as the RIT control.
 - The RIT control is the inner control. The outer control is disabled.

8 RIT KEY [RIT] (p. 69)

- ➔ Push to turn the RIT function ON or OFF.
 - Use the [M-CH]⊙ control to vary the RIT frequency.
- ➔ Hold down for 1 second to add the shift frequency of the RIT function to or subtract it from the displayed frequency.

1 PANEL DESCRIPTION

Front panel (Controller) (Continued)



9 ANTENNA TUNER/CALL KEY [TUNER/CALL]

- ANTENNA TUNER KEY Operation (p. 139)
(Frequency band: HF/50 MHz)
 - ➔ Push to turn the optional antenna tuner ON or OFF (bypass).
 - ➔ Hold down for 1 second to manually start the antenna tuner.
 - If the tuner cannot tune the antenna within 20 seconds, the tuning circuit is automatically bypassed.
- CALL KEY Operation (p. 139)
(Frequency band: 144/430 MHz)
Push to select the call channel.

10 MENU SWITCH [MENU] (p. 19)

- Push to change the set of functions assigned to touch keys.
- Toggles the function display menu between M-1 (M-1 menu), M-2 (M-2 menu), M-3 (M-3 menu), D-1 (D-1 menu) and D-2 (D-2 menu).

11 MIC GAIN/RF POWER ADJUSTMENT KEY [MIC/RF PWR] (p. 19)

Push to open the MIC gain/RF power adjustment display.

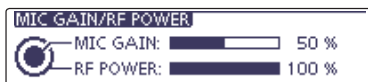

- Rotate [M-CH] to adjust the MIC gain.
- Rotate [BANK] to adjust the RF power.

Frequency band	RF output power range
HF/50 MHz	2 to 100 W (AM: 1 to 30 W)
144 MHz	2 to 100 W
430 MHz	2 to 75 W

- Push again to close the window.

12 NOISE BLANKER KEY [NB] (p. 76) **(Mode: SSB/CW/RTTY/AM)**

- ➔ Push to turn the noise blanker ON or OFF.
The noise blanker reduces pulse-type noise such as that generated by vehicle ignition systems. The noise blanker is not effective for non-pulse-type noise.
 - “NB” appears when the noise blanker is ON.
- ➔ Hold down for 1 second to display the “NB” screen. Push to return to the previous screen.

13 KEY SPEED/CW PITCH ADJUSTMENT KEY [SPEED/PITCH] (p. 19)

Push to open the Key speed/CW pitch adjustment display.



- Rotate [M-CH] to adjust the keying speed of the internal electronic CW keyer to between 6 wpm (minimum) and 48 wpm (maximum).
- Rotate [BANK] to shift the received CW audio pitch and the CW sidetone pitch without changing the operating frequency.
- The CW pitch can be adjusted from 300 to 900 Hz in approximately 5 Hz steps.
- Push again to close the window.

14 NOISE REDUCTION KEY [NR] (p. 77)

- ➔ Push to turn DSP noise reduction ON or OFF.
 - “NR” appears when noise reduction is ON.
- ➔ Hold down for 1 second to display the “NR” screen. Push to return to the previous screen.
 - Rotate the Dial to adjust the DSP noise reduction level. Set for maximum readability.

1 PANEL DESCRIPTION

Front panel (Controller) (Continued)



15 PREAMP•ATTENUATOR KEY **P.AMP/ATT**

- PREAMP KEY Operation (p. 71)
(Frequency band: HF/50 MHz)
 Push to select one of two receive RF preamplifiers, or to bypass them.
 - “P. AMP1” is a wide dynamic range preamplifier. It is most effective for the 1.8 to 21 MHz bands.
 - “P. AMP2” is a high-gain preamplifier. It is most effective for the 24 to 50 MHz bands.
 - No indicator appears when the preamplifiers are not selected.

✓ **What is the preamplifier?**

The preamplifier amplifies signals in the front end to improve the S/N ratio and sensitivity. Select “P. AMP1” or “P. AMP2” when receiving weak signals.

(Frequency band: 144/430 MHz)

Push to turn the preamplifier ON or OFF.
 • “P.AMP” appears when the preamplifier is ON.

- ATTENUATOR KEY Operation (p. 71)
 - ➔ Hold down for 1 second to turn ON the attenuator.
 - “ATT” appears when the attenuator is ON.
 - ➔ Push to turn OFF the attenuator.
 - “ATT” disappears.

✓ **What is the attenuator?**

The attenuator prevents a desired signal from being distorted when very strong signals are near it, or when very strong electromagnetic fields, such as from a broadcasting station, are near your location.

16 NOTCH SWITCH **NOTCH** (p. 77)

**(Mode = Auto notch: SSB/AM/FM
 Manual notch: SSB/CW/RTTY/AM)**

- ➔ In the SSB and AM modes, push to toggle the notch function between auto, manual and OFF.
 - Either the Auto or Manual notch function can be turned OFF in the “[NOTCH] Switch (SSB)/(AM)” items of the “Function” Set mode. (p. 36)
 [SET] > Function > [NOTCH] Switch (SSB)
 [SET] > Function > [NOTCH] Switch (AM)
- ➔ In the FM mode, push to turn the Auto Notch function ON or OFF.
- ➔ In the CW or RTTY mode, push to turn the Manual Notch function ON or OFF.
 - “MN” appears when the Manual Notch function is ON.
 - “AN” appears when the Auto Notch function is ON.
 - No indicator appears when the notch filter is OFF.
- ➔ Hold down for 1 second to display the “NOTCH” screen.
 Push to return to the previous screen.
 - Rotate the Dial to adjust the notch frequency to reject an interfering signal while the manual function is ON.
 - Notch filter center frequency:
 SSB/RTTY: –1040 Hz to +4040 Hz
 CW: CW pitch frequency –2540 Hz to CW pitch frequency +2540 Hz
 AM: –5060 Hz to +5100 Hz

✓ **What is the notch filter?**

The notch filter is a narrow filter that eliminates unwanted CW or AM carrier tones, while preserving the desired voice signal. The DSP circuit automatically adjusts the notch frequency to effectively eliminate unwanted tones.

1 PANEL DESCRIPTION

Front panel (Controller) (Continued)

**17 DR MODE KEY [DR]** (p. 85)

- ➔ Push to select the DR mode.
 - When DR mode is selected, the transceiver automatically selects the DV mode.
- ➔ In the DR mode, push to cancel it.
 - The transceiver returns to the previous screen before entering the DR mode.

18 SET MODE KEY [SET] (p. 85)

- ➔ Push to enter or exit the SET mode.
 - “Voice Memo,” “Call Sign,” “RX History,” “DV Memory,” “My Station,” “DV Set,” “GPS,” “SPEECH,” “QSO/RX Log,” “Function,” “Tone Control,” “Connector,” “Display,” “Time Set,” “SD Card” and “Others” set group are available.

19 QUICK MENU KEY [QUICK] (p. 85)

- ➔ Push to open to close the Quick Menu window.
 - The Quick Menu is used to quickly select various functions.
- ➔ In the setting screen, hold down for 1 second to open the Default set window.
 - Touch “Default” to reset to the default setting.

20 AUTOTUNE/RX→CS KEY [AUTO TUNE/RX→CS] (p. 85)

- AUTOTUNE KEY Operation (p. 71)
(Mode: CW)
 - ➔ Push to automatically adjust for a zero beat with the received signal.
Zero beat means that two signals are exactly the same frequency.
 - “AUTO TUNE” blinks when auto tune function is activated.
 - When the RIT function is ON, the auto tune function changes the RIT frequency, not the displayed frequency.

- RX CALL SIGN CAPTURE KEY Operation (p. 71)

(Mode: DV, when the DR mode is selected)

- ➔ Push to open the “RX>CS” screen.
Push again to retune to the previous screen.
- ➔ Hold down for 1 second to set the received call signs (station and repeaters) as the operating call sign.

21 TRANSMIT FREQUENCY CHECK KEY [XFC]

- ➔ During split frequency or repeater operation, hold down to listen to the transmit frequency. (p. 82)
 - While holding down this switch, the transmit frequency can be changed with the Dial or [MPAD].
 - When the Split Lock function is turned ON, hold down [XFC] to cancel the Dial lock function. (pp. 82, 162)
- ➔ When the RIT function is turned ON, hold down to listen to the receive frequency. (RIT is temporarily cancelled.) (p. 69)
- ➔ In the simplex operation, hold down to monitor the receive frequency.
 - While holding down this key, the squelch is opened and the interference reject function is temporary OFF.
- ➔ In the DV mode, the RX monitoring mode is selected by holding down this key. (p. 118)

1 PANEL DESCRIPTION

Front panel (Controller) (Continued)



22 SPEECH/LOCK SWITCH [SPEECH/LOCK]

- SPEECH KEY Operation (p. 45)
 - Push to audibly announce the S-meter level, the displayed frequency and the operating mode.
 - The S-Level announcement can be turned OFF in the “S-Level SPEECH” item of the “SPEECH” Set mode. (p. 164)
 - [SET] > SPEECH > **S-Level SPEECH**
 - When RIT is ON, the RIT offset is not included in the frequency announcement.
- LOCK KEY Operation (p. 77)
 - Hold down for 1 second to turn the Lock function ON or OFF.
 - The function electronically locks the Dial.
 - “[LOCK]” appears when the function is ON.
 - The function can be select the Dial lock and Panel lock in the “Lock Function” item of the “Function” Set mode. (p. 164)
 - [SET] > Function > **Lock Function**

/// **NOTE:** The [SPEECH/LOCK] switch operation to activate the voice synthesizer or the Lock functions can be replaced in the “[SPEECH/LOCK] Switch” item of the “Function” Set mode. (p. 164)

/// [SET] > Function > **Lock Function**

23 MEMO PAD KEY [MPAD] (p. 144)

- ➔ Push to sequentially call up the contents from the memo pads.
- The 5 (or 10) most recently programmed frequencies and operating modes can be recalled, starting from the most recent.
 - The memo pad capacity can be increased from 5 to 10 in the “Memopad Numbers” item of the “Function” Set mode (p. 164)
 - [SET] > Function > **Memopad Numbers**
- ➔ Hold down for 1 second to write the displayed data into a memo pad.
 - The 5 most recent entries remain in the memo pads.

24 MAIN DIAL

Rotate to change the displayed frequency, select the Set mode settings, and so on.

25 MAIN DIAL TENSION LATCH

Select the Dial drag.

- Three positions are selectable. The upper side setting turns on clicks as the dial is turned.

1 PANEL DESCRIPTION

Front panel (Controller) (Continued)

◇ Display

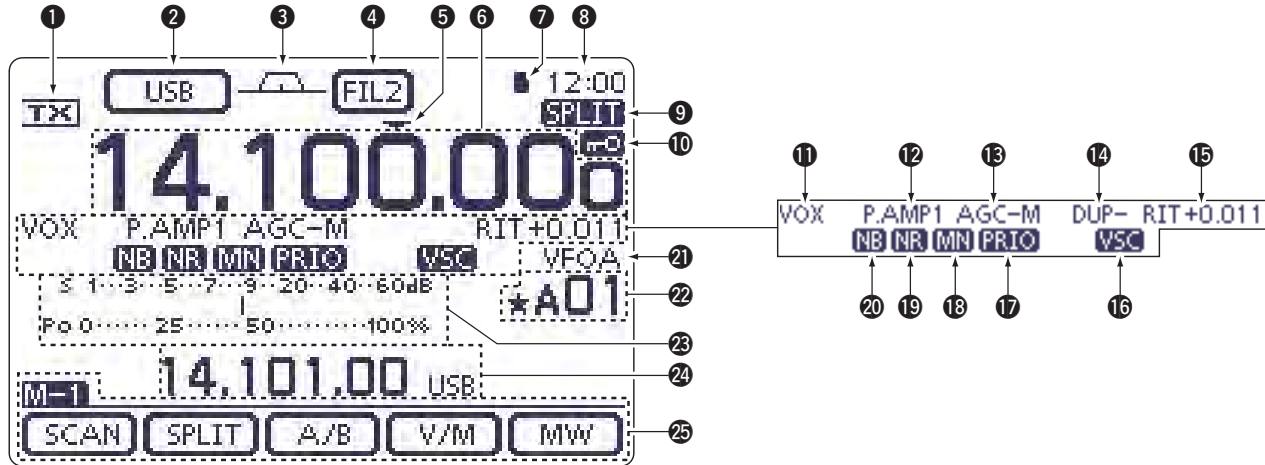

1 TX ICON

Indicates either the displayed frequency can be transmitted, or not.

- ➔ “TX” appears while the operating frequency is in an amateur band.
- ➔ “TX” appears while the operating frequency is not in an amateur band. However, when the “Band Edge Beep” item is set to “OFF” in the “Function” Set mode (p. 85), “TX” does not appear.
- ➔ [SET] > Function > **Band Edge Beep**
- ➔ “LMT” appears while the output power is decreased due to the Power FET’s temperature is high.
- ➔ “HOT” appears while the transmission is inhibited due to the Power FET’s temperature is too high.

2 MODE ICONS (p. 43)

- ➔ Displays the selected operating mode.
 - “-D” appears when SSB data, AM data or FM data mode is selected.
- ➔ Touch to enter the Mode selection screen.
 - On the Mode selection screen, touch the block to select the operating mode.

3 PASSBAND WIDTH ICON (p. 75, 77)

Graphically displays the passband width for twin PBT operation and center frequency for IF shift operation.

4 IF FILTER ICON (p. 75, 77)

- ➔ Shows the selected IF filter.
- ➔ Touch to select one of three IF filter settings.
 - The selected filter passband width and shifting value are displayed for 2 seconds on the window.
- ➔ Touch for 1 second to display the “FILTER” screen (Filter) to adjust the filter passband width.
- ➔ When the “FILTER” screen is displayed, touch for 1 second to return to the previous screen.

5 QUICK TUNING ICON

Appears when the Quick tuning mode is selected.

- When “▼” is displayed, the frequency changes in pre-set kHz or 1 MHz quick tuning steps. (p. 38)
- When “▼” is not displayed, the frequency changes in 10 Hz or 1 Hz steps. (pp. 37, 39)

6 FREQUENCY READOUTS

- ➔ Displays the operating frequency.
- ➔ Touch the MHz digits to enter the Band selection screen.
- ➔ Touch the MHz digits for 1 second to turn the 1 MHz quick tuning mode ON or OFF.
- ➔ Touch the kHz digits to turn the pre-set kHz quick tuning mode ON or OFF.
- ➔ Touch the kHz digits for 1 second to enter the Tuning step selection screen.
- ➔ Touch the Hz digits to for 1 second to toggle between 10 Hz and 1 Hz steps.

7 SD CARD ICON

- ➔ “■” appears when an SD card is inserted.
- ➔ “■” and “□” alternately blinks while accessing the SD card.

8 CLOCK READOUT

Shows the current time.

- UTC time or local time can be selected.

9 SPLIT ICON (p. 82)

Appears when the Split function is turned ON.

9 LOCK INDICATOR (p. 37)

Appears when the Lock function is activated.

10 LOCK ICON (p. 77)

Appears when the Lock function is turned ON.

1 PANEL DESCRIPTION

Front panel (Controller) (Continued)

◇ Display

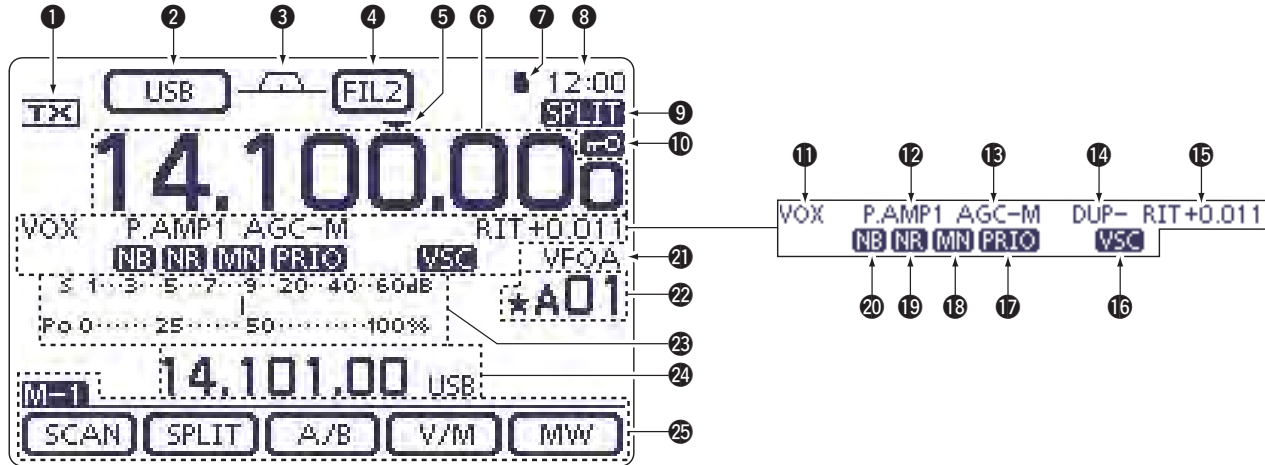

10 1/4 TUNING DIAL SPEED ICON (p. 39)
(Mode: SSB-D/CW/RTTY)

“1/4” appears when the tuning dial speed is set so that one rotation is equal to 1/4 of the normal rotation.

- This function is available only when the quick tuning function is turned OFF.

11 VOX ICON (p. 78)

Appears when the VOX function is activated.

12 PREAMP ICON (p. 71)

Appears when a preamplifier is turned ON.

- In HF/50 MHz frequency band, either “P.AMP1” or “P.AMP2” is displayed when the preamp 1 or preamp 2 is ON.
- In 144/430 MHz frequency band, “P.AMP” is displayed when the preamp is ON.

12 ATTENUATOR ICON (p. 71)

Appears when the Attenuator function is turned ON.

13 AGC ICONS (p. 72)

Displays the selected AGC time constant.

- “AGC-F” for AGC fast; “AGC-M” for AGC middle; “AGC-S” for AGC slow; “AGC-OFF” for AGC OFF.
- In the FM, WFM and DV mode, “AGC-F” for AGC fast is fixed.

14 DUPLEX ICON (p. 65)

“DUP+” appears when plus duplex, “DUP -” appears when minus duplex (repeater) operation is selected.

15 RIT ICON (pp. 69, 81)

- ➔ “RIT” appears when the RIT function is turned ON.
- ➔ Shows the shift frequency of the RIT function.

16 VOICE SQUELCH CONTROL ICON (p. 146)

Appears when the VSC (Voice Squelch Control) function is turned ON.

17 PRIORITY WATCH INDICATOR (p. 113)

Appears while priority scan is activated.

18 NOTCH ICONS (p. 77)

(Mode: SSB/CW/RTTY/AM)

- ➔ “MN” appears when the Manual Notch function is turned ON.

(Mode: SSB/AM/FM)

- ➔ “AN” appears when the Automatic Notch function is turned ON.

19 NOISE REDUCTION ICON (p. 77)

Appears when the Noise Reduction function is turned ON.

20 NOISE BLANKER ICON (p. 76)

Appears when the Noise Blanker function is turned ON.

21 VFO/MEMORY ICONS (p. 34)

- ➔ “VFOA” or “VFOB” appears whether VFO A or VFO B is selected.
- ➔ “MEMO” appears when the memory mode is selected.

1 PANEL DESCRIPTION

Front panel (Controller) (Continued)

◇ Display

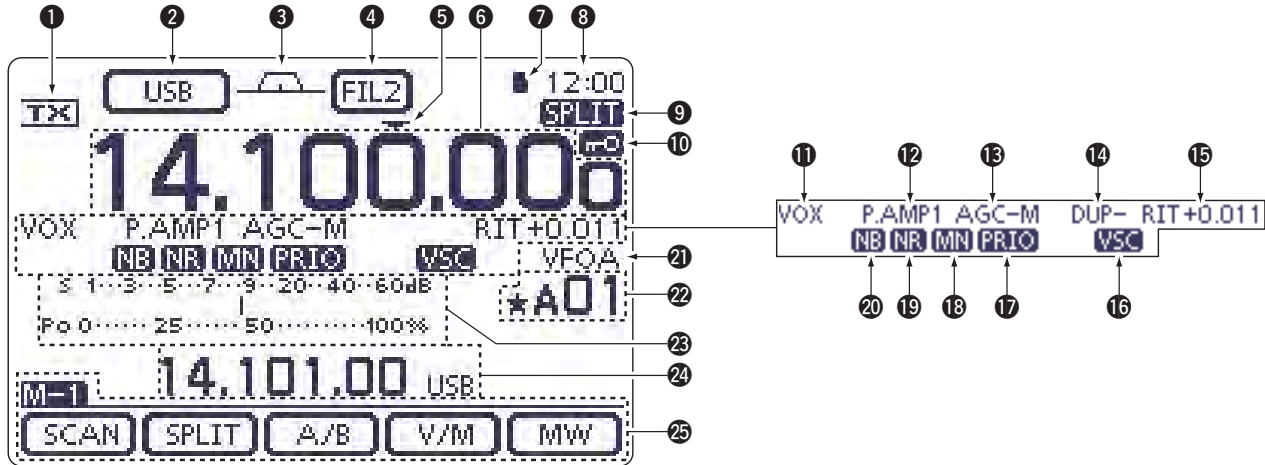

22 MEMORY CHANNEL READOUT (p. 100)

- ➔ Shows the selected memory channel, scan edge channel or Call channel.
 - Memory bank indicator (A to E) appears to the left of memory channel.
- ➔ Touch to toggle between the VFO and Memory modes.

22 SELECT MEMORY CHANNEL ICON

“★” appears when the selected memory channel is set as a select memory channel. (p. 151)

23 MULTI-FUNCTION METER INDICATION

- ➔ Displays the signal strength while receiving.
- ➔ Displays the relative output power, SWR, ALC or compression levels while transmitting.
- ➔ When the Meter Peak Hold function is ON, the peak level of a received signal strength or the output power is displayed for approximately 0.5 seconds.
- ➔ Touch to select the RF power, SWR, ALC or Compression meter.
- ➔ Touch for 1 second to display the Multi-function meter.

24 INFORMATION READOUT (p. 80)

Displays the transmit frequency of the Split operation, descriptions of the memory channel or Received Call sign on the DV mode, and so on.

25 FUNCTION DISPLAY (p. 19)

- Shows the function of the Touch keys.
 - Push [MENU] to change the set of functions assigned to touch keys.
 - Toggles the function display menu between M-1 (M-1 menu), M-2 (M-2 menu), M-3 (M-3 menu), D-1 (D-1 menu) and D-2 (D-2 menu).

1 PANEL DESCRIPTION

Front panel (Controller) (Continued)

◇ Display

- Push **MENU** to change the set of functions assigned to touch keys.
 - Toggles the function display menu between M-1 (M-1 menu), M-2 (M-2 menu), M-3 (M-3 menu), D-1 (D-1 menu) and D-2 (D-2 menu).
 - Functions vary, depending on the operating mode.
 - In the DR mode, the D-1 (D-1 menu) and D-2 (D-2 menu) can be selected.
- Touch or touch for 1 second to select the displayed functions.

◇ M-1 (M-1 menu) Display



◇ M-2 (M-2 menu) Display

(Mode: SSB)



(Mode: SSB-D)



(Mode: CW)



(Mode: RTTY)



(Mode: AM/AM-D)



(Mode: FM/FM-D/WFM)



(Mode: DV)



◇ M-3 (M-3 menu) Display

(Mode: SSB/AM/AM-D)



(Mode: SSB-D/RTTY)



(Mode: CW)



(Mode: FM/FM-D/WFM/DV)



◇ D-1 (D-1 menu) Display

(Mode: DV, when the DR mode is selected)



◇ D-2 (D-2 menu) Display

(Mode: DV, when the DR mode is selected)



1 PANEL DESCRIPTION

◇ Function keys on M-1 display

SCAN KEY [SCAN] (p. 147)

Touch to display the “SCAN” screen.

SPLIT SWITCH [SPLIT] (p. 82)

- ➔ Touch to turn the split function ON or OFF.
 - “SPLIT” appears when the split function is ON.
- ➔ Touch for 1 second to activate the quick split function.
 - The transmit frequency shifts from the receive frequency according to the “SPLIT Offset” option in the Set mode. (p. 162)
 - The quick split function can be turned OFF in the “Quick SPLIT” item of the Set mode. (p. 162)

VFO SELECT SWITCH [A/B] (pp. 32, 34)

- ➔ Touch to select either VFO A or VFO B.
- ➔ Touch for 1 second to equalize the undisplayed VFO settings to that of the displayed VFO.

VFO/MEMORY SWITCH [V/M]

- ➔ Touch to switch between the VFO and memory modes. (pp. 34, 139)
 - Touching Memory channel also selects the VFO or memory modes. (p. 162)
- ➔ Touch for 1 second to copy the memory contents to the displayed VFO on the MAIN Band. (p. 142)

MEMORY WRITE SWITCH [MW] (p. 140)

Touch for 1 second to store VFO data into the selected memory channel.

- This can be done in both the VFO and memory modes.

◇ Function keys on M-2 display

DUPLEX KEY [DUP] (p. 65)

- ➔ Touch to select the duplex direction, or to turn OFF the function.
 - “DUP-” or “DUP+” is displayed during duplex operation.
- ➔ In the FM mode, touch for 1 second to turn the one-touch repeater function ON or OFF.

AGC KEY [AGC] (p. 72)

(Mode: SSB/SSB-D/CW/RTTY/AM/AM-D)

- ➔ Touch to select the time constant of the AGC circuit.
- ➔ Touch for 1 second to display the “AGC” screen.

STONE SQUELCH KEY [TONE] (pp. 62–64)

(Mode: FM)

- ➔ Touch to select a tone function between subaudible (repeater) tone, tone squelch and DTCS code.
- ➔ Touch for 1 second to display the “TONE” screen of the selected tone function.

DIGITAL SQUELCH KEY [DSQL] (p. 114)

(Mode: DV)

- ➔ Push to select a digital squelch function between digital call sign squelch and digital code squelch.
- ➔ Hold down for 1 second to display the “DSQ” screen (digital squelch).

MEMORY KEYSER MENU KEY [KEYER] (p. 50)

(Mode: CW)

Push to display the “KEY” screen (memory keyer) or the “SEND” screen (keyer send), depending on the “KEYER 1st Menu” option in the Set mode (p. 165).

SPEECH COMPRESSOR KEY [COMP] (p. 80)

(Mode: SSB)

- ➔ Touch to turn the speech compressor function ON or OFF.
 - “COMP” is displayed when the speech compressor is ON.
- ➔ Touch for 1 second to display the “COMP” screen.

RTTY MENU KEY [RTTY] (p. 57)

Touch to display the “RTTY” screen.

CALL SIGN KEY [CS](F-1) (p. 85)

(Mode: DV)

Touch to display the “CS” screen.

- The current call sign for DV operation appears.

TRANSMISSION BANDWIDTH KEY [TBW] (p. 80)

(Mode: SSB)

- ➔ Touch to display the selected transmission bandwidth.
- ➔ Touch for 1 second to select the transmission bandwidth.
 - Bandwidth is selectable from wide (WIDE), middle (MID) and narrow (NAR).

¼ TUNING FUNCTION KEY [¼] (p. 39)

(Mode: SSB-D/CW/RTTY)

Touch to turn the ¼ Tuning function ON or OFF.

- “¼” is displayed when the ¼ Tuning function is ON.

CALL RECORD KEY [CD] (p. 95)

(Mode: DV)

Touch to display the “CD” screen.

- The call record channel appears. (RX01 to RX20)

Section 4

RECEIVE AND TRANSMIT

- Operating SSB 4-2**
- Operating CW..... 4-3**
 - ◇ About the CW reverse mode 4-4
 - ◇ About keying speed..... 4-4
 - ◇ About CW pitch control..... 4-4
 - ◇ CW sidetone function 4-5
 - ◇ CW Auto tune function 4-5
- Electronic keyer functions..... 4-6**
 - ◇ Memory keyer menu construction 4-6
 - ◇ Memory keyer send menu 4-7
 - ◇ Editing a memory keyer..... 4-8
 - ◇ Contest number Set mode 4-9
 - ◇ Keyer Set mode..... 4-10
- Operating RTTY (FSK)..... 4-12**
- The functions for RTTY operation..... 4-13**
 - ◇ About RTTY reverse mode..... 4-13
 - ◇ Twin Peak Filter 4-13
 - ◇ RTTY Set mode..... 4-14
 - ◇ RTTY decoder 4-15
 - ◇ RTTY decode Set mode..... 4-16
 - ◇ Transmitting an RTTY memory..... 4-17
 - ◇ Editing an RTTY memory 4-18
 - ◇ Turning ON the RTTY decode log 4-19
 - ◇ RTTY decode log Set mode 4-20
- Operating AM/FM..... 4-21**
- Tone squelch operation 4-22**
- DTCS operation 4-23**
- Tone scan/DTCS code scan operation 4-24**
- Repeater operation..... 4-25**
 - ◇ Repeater access tone frequency setting 4-26
 - ◇ One-touch repeater function..... 4-27
 - ◇ Transmit frequency monitor check..... 4-28
 - ◇ 1750 Hz tone burst..... 4-28
 - ◇ Turning ON the Auto Repeater function
(U.S.A. and Korea versions only)..... 4-29
 - ◇ Storing a non standard repeater 4-30

4 RECEIVE AND TRANSMIT

Operating SSB

- ① Select the desired frequency band. (p. 35)
- ② On the Mode selection screen, touch “SSB” to select the LSB or USB mode.
 - When operating above 10 MHz, USB is selected first; when operating below 10 MHz, LSB is selected first.
 - After selecting LSB or USB, touch “SSB” again to toggle between USB and LSB modes, if necessary.
 - To select the data mode, after selecting LSB or USB, touch “DATA” to select the data mode, if needed.
- ③ Rotate the Dial to tune a desired signal.
 - The S-meter displays the received signal strength.
 - The tuning step can be changed on the Tuning step selection screen by touching “kHz frequency.” (p. 38)
- ④ Rotate [AF] (L) to adjust the audio to a comfortable listening level.
- ⑤ Push [PTT] on the microphone to transmit.
 - The TX/RX indicator lights red.
- ⑥ Speak into the microphone at your normal voice level.
- ⑦ If necessary, adjust the microphone gain or RF power on the Mic gain/RF power adjustment display.

- ① Push [MIC/RF PWR] (C) to open the MIC gain/RF power adjustment display.

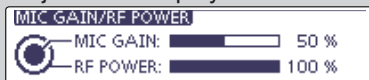

- ② Rotate [M-CH] (L) to adjust the MIC gain, or [BANK] (L) to adjust the RF power.
 - To adjust the MIC gain, touch the TX meter to select the ALC meter. And then, adjust it so that the ALC meter reading stays within the ALC zone.
 - ▨ When the MIC gain is adjusted too high, your transmitted voice may be distorted.
- ③ Push [MENU] (C) to close the display.

- ⑧ Release [PTT] to receive.

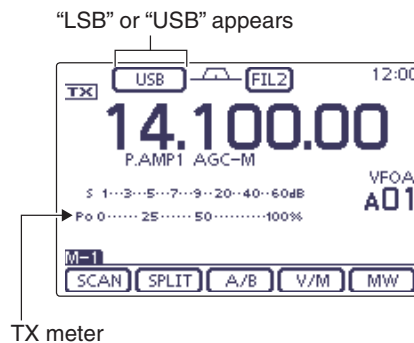
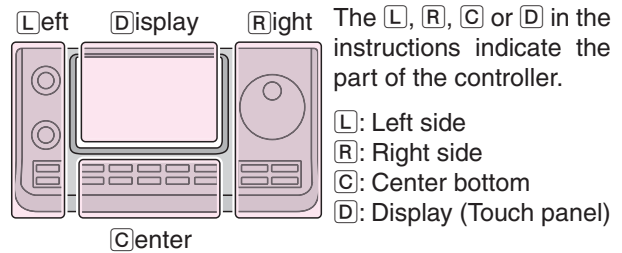

Convenient Receive functions

- Preamp and attenuator (p. 71)
- Twin PBT (passband tuning) (p. 75)
- AGC (auto gain control) (p. 72)
- Noise blanker (p. 76)
- Noise reduction (p. 77)
- Notch filter (p. 77)
- Receive filter width (HPF/LPF) (p. 169)
- Tone control (p. 169)

Convenient Transmit functions

- Speech compressor (p. 78)
- VOX (voice operated transmit) (p. 80)
- Transmit quality monitor (p. 81)
- Transmit filter width (p. 80)
- Tone control (p. 169)

4 RECEIVE AND TRANSMIT

Operating CW

- ① Select the desired frequency band. (p. 35)
- ② On the Mode selection screen, touch “CW” to select the CW mode.
 - After the CW mode is selected, touch “CW” again to toggle between CW and CW-R modes, if necessary.
- ③ Rotate the Dial to tune a desired signal.
 - The S-meter displays the received signal strength.
 - The tuning step can be changed on the Tuning step selection screen by touching “kHz frequency.” (p. 38)
- ④ Rotate [AF] (L) to adjust the audio to a comfortable listening level.
- ⑤ Set the Break-in operation to the semi break-in or full break-in mode.
 - “BKIN,” “F-BKIN” or “OFF (no indication)” appears.

While the “M-3” menu is selected, touch [BK-IN] (D) once or twice to select the Break-in operation.

- BKIN : Semi break-in
- F-BKIN : Full break-in
- OFF : No break-in (ACC socket connection for TX is necessary, as shown on page 22.)
If a microphone is connected, its PTT can be used instead of the external TX switch.

- ⑥ If the Semi break-in operation is selected at step ⑤, set the Break-in delay.

- ① While the “M-3” menu is selected, touch [BK-IN] (D) for 1 second to open the Break-in delay adjustment window.



- ② Rotate the Dial to adjust the delay time.
 - The adjustable delay time is between 2.0 and 13.0 dots.

- ⑦ Use the electric keyer or paddle to key your CW signals.

- The TX/RX indicator lights red.
- The Po meter indicates transmitted CW output power.

- ⑧ If desired, adjust the Key speed or CW pitch.

- ① Push [SPEED/PITCH] (C) to open the Key speed/CW pitch adjustment window.



- ② Rotate [M-CH] (L) to adjust the Key speed, or [BANK] (L) to the CW pitch.
 - The adjustable key speed is between 6 and 48 wpm (words per minute).
 - The adjustable CW pitch is between 300 and 900 Hz.
- ③ Push [MENU] (C) to close the window.

- ⑨ Stop keying to return to receive.

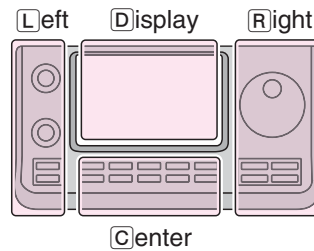

The L, R, C or D in the instructions indicate the part of the controller.

- L: Left side
- R: Right side
- C: Center bottom
- D: Display (Touch panel)

“CW” or “CW-R” appears

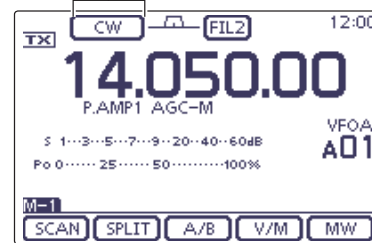

Appears

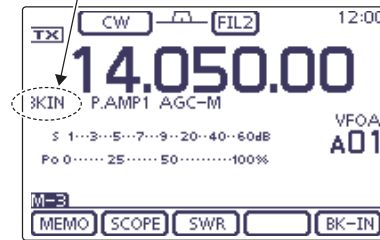

Semi break-in operation is selected

Convenient Receive functions

- Preamp and attenuator (p. 71)
- Twin PBT (passband tuning) (p. 75)
- AGC (auto gain control) (p. 72)
- Noise blanker (p. 76)
- Noise reduction (p. 77)
- Manual Notch filter (p. 77)
- ¼ function (p. 39)
- CW pitch control (p. 49)

Convenient Transmit functions

- Break-in function (p. 79)
- Keying speed setting (p. 49)
- Memory keyer (p. 50)

4 RECEIVE AND TRANSMIT

Operating CW (Continued)

◇ About the CW reverse mode

The CW reverse mode receives signals with a reverse side CW carrier point similar to voice LSB and USB modes.

Use when interfering signals are near a desired signal and you want to reduce the interfering tone.

- ① On the Mode selection screen, touch “CW” to select the CW mode.
- ② After the CW mode is selected, touch “CW” again on the Mode selection screen to toggle between CW and CW-R modes.
 - Check that the interfering tone can be reduced.

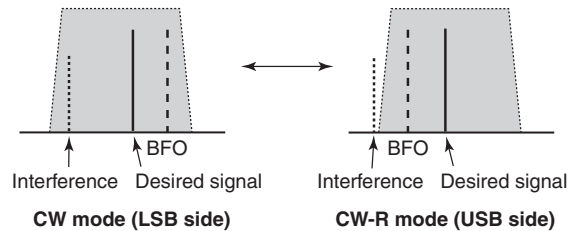

Carrier point

The CW carrier point is set to the LSB side by default, the setting can be changed to USB side in the “CW Normal Side” item of the “Function” Set mode. (p. 165)

SET(C) > Function > **CW Normal Side**

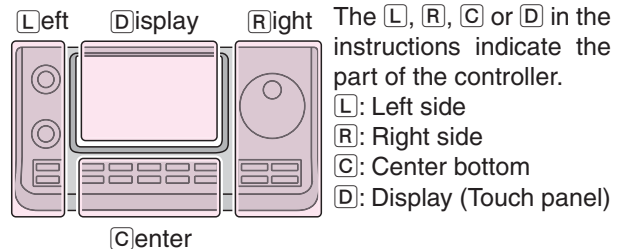

◇ About keying speed

The transceiver’s internal electronic keyer speed can be adjusted to between 6 and 48 wpm (words per minute).

- ① Push **SPEED/PITCH**(C) to open the Key speed/CW pitch adjustment display.
- ② Rotate **[M-CH]**(L) clockwise to increase keying speed; counterclockwise to decrease it.
- ③ Push **MENU**(C) to close the display.

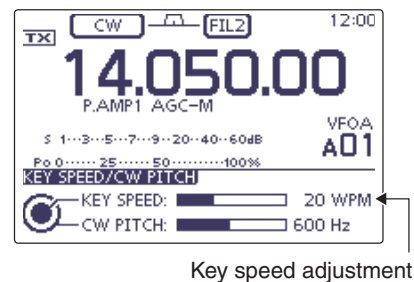

◇ About CW pitch control

The received CW audio pitch can be adjusted to suit your preference without changing the operating frequency.

- ① Push **SPEED/PITCH**(C) to open the Key speed/CW pitch adjustment display.
- ② Rotate **[BANK]**(L) to suit your preference.
 - Adjustable from 300 to 900 Hz (in 5 Hz steps).
- ③ Push **MENU**(C) to close the display.

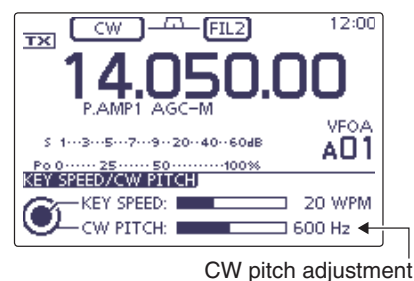

4 RECEIVE AND TRANSMIT

Operating CW (Continued)

◇ CW sidetone function

When the transceiver is in the receive mode (and the Break-in function is OFF— p. 79), you can listen to the CW sidetone without actually transmitting.

You can also use the CW sidetone to practice CW sending, but be sure to turn OFF the Break-in function.

The CW sidetone level can be adjusted in the “Side Tone Level” item of the Keyer Set mode (p. 54).

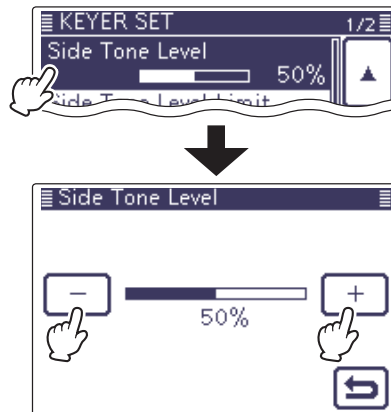

◇ CW Auto tune function

The automatic tuning function automatically tunes the displayed frequency when an off-frequency signal is received. This function is active while in the CW mode is selected.

➔ Push **AUTO TUNE** (R) to automatically adjust for a zero beat with the received signal.

Zero beat means that two signals are exactly the same frequency.

- “AUTO TUNE” blinks when auto tune function is activated.
- If **AUTO TUNE** (R) is pushed when the RIT function is ON, the auto tune function changes the RIT frequency, not the displayed frequency.

IMPORTANT!

When receiving a weak signal, or receiving a signal with interference, the automatic tuning function may tune the receiver to an undesired signal.

If the off-frequency signal is too far away, the Auto tune function may not work. In that case, an error beep sounds.

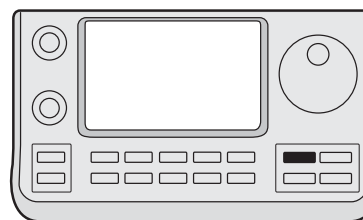

AUTO TUNE (R)

AUTO TUNE icon

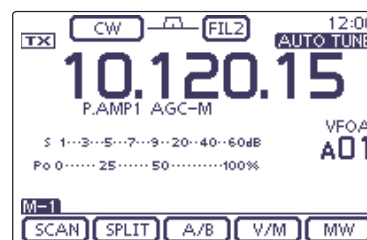

4 RECEIVE AND TRANSMIT

Electronic keyer functions

You can access a number of convenient built-in electronic keyer functions in the memory keyer menu.

- ① In the CW mode, push **MENU**(C) one or more times to select the “M-2” screen (M-2 menu).
 - ② Touch **[KEYER]**(D), and then push **MENU**(C) to display the “KEYER” screen (Memory Keyer).
 - ③ Touch **[SEND]**, **[EDIT]**, **[001]** or **[SET]**(D) to select the desired menu.
See the diagram below.
- Push **MENU**(C) to return to the previous display.

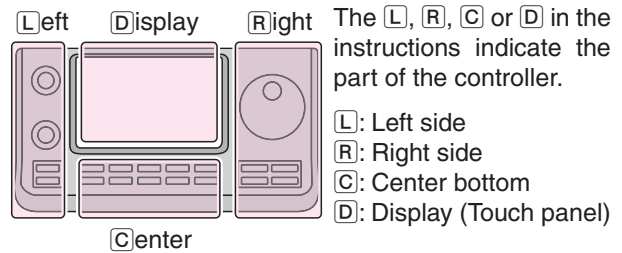

◇ Memory keyer menu construction

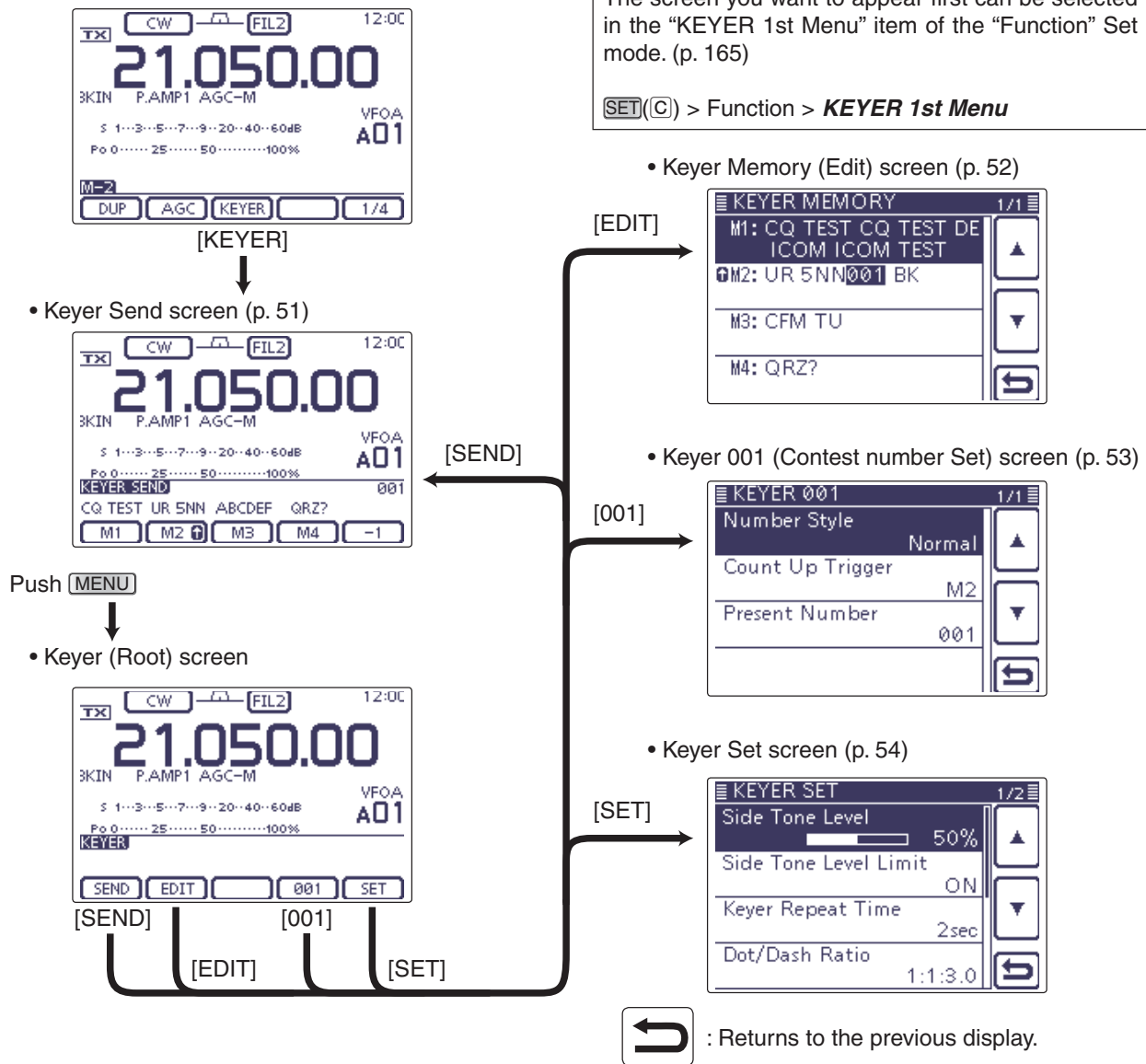

4 RECEIVE AND TRANSMIT

Electronic keyer functions (Continued)

◇ Memory keyer send menu

Preset characters can be sent using the Keyer Send screen. Contents of the memory keyer are entered in the Keyer Memory (Edit) screen.

• Transmitting

- ① In the CW mode, turn ON the Break-in function. (p. 79)
 - When the Break-in function is OFF and you do step ④, you can listen the memory keyer contents without transmitting.
- ② Push **[MENU]**(C) one or more times to select the “M-2” screen (M-2 menu).
- ③ Touch **[KEYER]**(D) to display the “KEYER SEND” screen.
 - If the “KEYER” (Root) screen is displayed, touch **[SEND]**(D) to display the “KEYER SEND” screen.
- ④ Touch one of the Memory keys, **[M1]** to **[M4]**(D), to send the memory keyer contents.
 - Touch a Memory key for 1 second to repeatedly send the contents; touch any Memory key to stop the transmission.
 - Set the repeat interval to between 1 and 60 seconds (1 second steps) in the “Keyer Repeat Time” item of the “KEYER SET” screen. (p. 54)
 - “M1”–“M4” are highlighted while transmitting.
 - The contest number counter advances each time the contents are sent.
 - Push **[-1]**(D) to reduce the contest number advances by one before sending the memory keyer contents to a station a second time.
- ⑤ Push **[MENU]**(C) to return to the “KEYER” (Root) screen.

For your information

When an external keypad is connected to pin 3 and pin 7 of the [MIC] connector, the contents of M1 to M4 can be transmitted without selecting the “KEYER SEND” screen.
See page 167 for details.

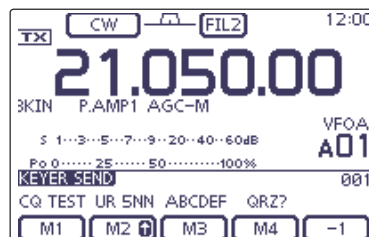
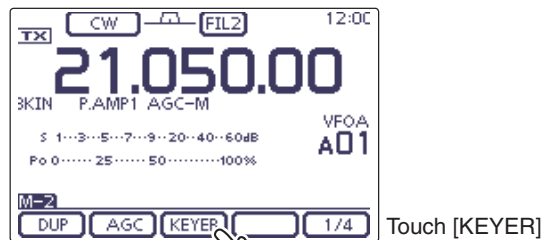

• M1 sending display



• M2 sending display

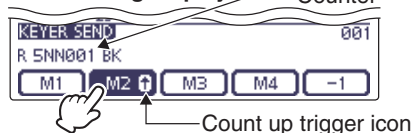

• M3 sending display



• M4 sending display



• While transmitting repeatedly

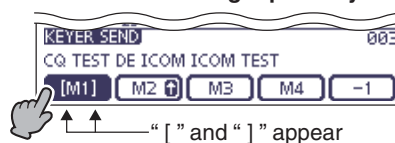

4 RECEIVE AND TRANSMIT

Electronic keyer functions (Continued)

◇ Editing a memory keyer

The contents of the memory keyer memories can be set on the Keyer Memory (Edit) screen. The memory keyer can memorize and retransmit 4 CW key codes for often-used CW sentences, contest numbers or a count up trigger. The total capacity of the memory keyer is 70 characters per memory channel.

• Programming contents

- ① In the CW mode, push **MENU**(C) one or more times to select the “M-2” screen (M-2 menu).
- ② Touch **[KEYER]**(D) to display the “KEYER SEND” screen.
 - If the “KEYER” (Root) screen is displayed, skip step ③.
- ③ Push **MENU**(C) to display the “KEYER” screen.
- ④ Touch **[EDIT]**(D) to display the “KEYER MEMORY” (Edit) screen.
 - The memory contents are displayed.
- ⑤ Touch for 1 second on a desired memory channel to be edited, and then touch “Edit.”
 - The memory programming screen appears.
- ⑥ Touch the desired block one or more times to select the desired character, number or symbol.

Selectable characters, numbers and symbols
A to Z, 0 to 9, / ? ^ . , @ *

- Touch “AB⇔12” to toggle between the Alphabet input and Number input mode.
 - Touch **[CLR]**(D) to delete the selected character, symbol or number.
 - Touch **[SYMB]**(D) to open the Symbol character selection window.
 - Touch “_” to input a space.
- ⑦ Touch **[←]**(D) or **[→]**(D) to move the cursor backwards or forwards.
 - ⑧ Repeat steps ⑥ and ⑦ to program up to 70 characters of memory contents, and then push **[ENT]**(D).
 - ⑨ Touch **[↵]**(D) or push **MENU**(C) to return to the “KEYER” (Root) screen.

NOTE:

“^” is used to transmit a string of characters with no inter-character space. Put a “^” before a text string such as ^AR, and the string “AR” is sent with no space.
 “*” is used to insert the CW contest number. The number automatically advances by 1. This function is available for only one memory keyer channel at a time. “*” is used in memory keyer channel M2 by default.

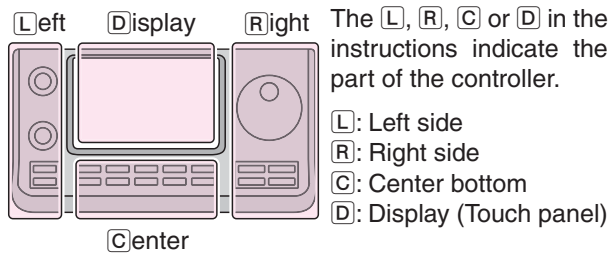

• Memory keyer programming mode

“KEYER” (Root) screen

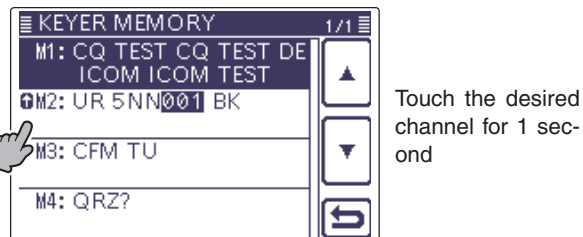
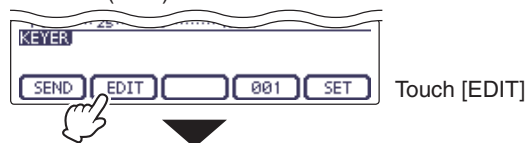

When inputting an asterisk, the counter is incremented by 1.

• M2 default indication

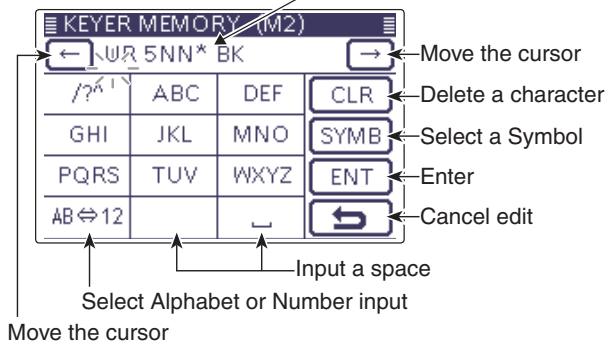

• Preprogrammed memory keyer contents

Memory keyer channel	Contents
M1	CQ TEST CQ TEST DE JA1 JA1 TEST
M2	UR 5NN* BK
M3	CFM TU
M4	QRZ?

4 RECEIVE AND TRANSMIT

Electronic keyer functions (Continued)

◇ Contest number Set mode

This mode is used to set the contest number, count up trigger and Present number.

• Setting contents

- ① In the CW mode, push **MENU**(C) one or more times to select the “M-2” screen (M-2 menu).
- ② Push **[KEYER]**(D) to display the “KEYER SEND” screen.
 - If the “KEYER” (Root) screen is displayed, skip step ③.
- ③ Push **MENU**(C) to display the “KEYER” screen.
- ④ Push **[001]**(D) to enter the “KEYER 001” (Contest Number Set) screen.
- ⑤ Touch the desired item to select.
- ⑥ Touch the desired option or rotate the Dial to change the setting.
 - If desired, touch the item for 1 second to open the Default set window, then select “Default” to reset to the default setting.
- ⑦ Push **MENU**(C) to return to the “KEYER” (Root) screen.

Number Style (Default: Normal)

This item sets the numbering system used for contest numbers— normal or short morse numbers.

Short morse numbers are also referred to as “cut” numbers.

- Normal: Does not use short morse numbers
- 190→ANO: Sets 1 as A, 9 as N and 0 as O.
- 190→ANT: Sets 1 as A, 9 as N and 0 as T.
- 90→NO: Sets 9 as N and 0 as O.
- 90→NT: Sets 9 as N and 0 as T.

Count Up Trigger (Default: M2)

Set the count-up trigger to one of four memory slots for the contest number exchange. The count-up trigger allows the contest number to automatically advance after each complete number exchange is sent.

- M1, M2, M3 or M4 can be set.

Present Number (Default: 001)

This item shows the current number for the count-up trigger channel set above.

- Touch **[+]** or **[-]**(D) or rotate the Dial to change the number.
- Hold down the item for 1 second to display the default set window, then touch “Default” to set the counter to “001.”

The **L**, **R**, **C** or **D** in the instructions indicate the part of the controller.

- L**: Left side, **R**: Right side, **C**: Center bottom
- D**: Display (Touch panel)

• Contest number Set mode

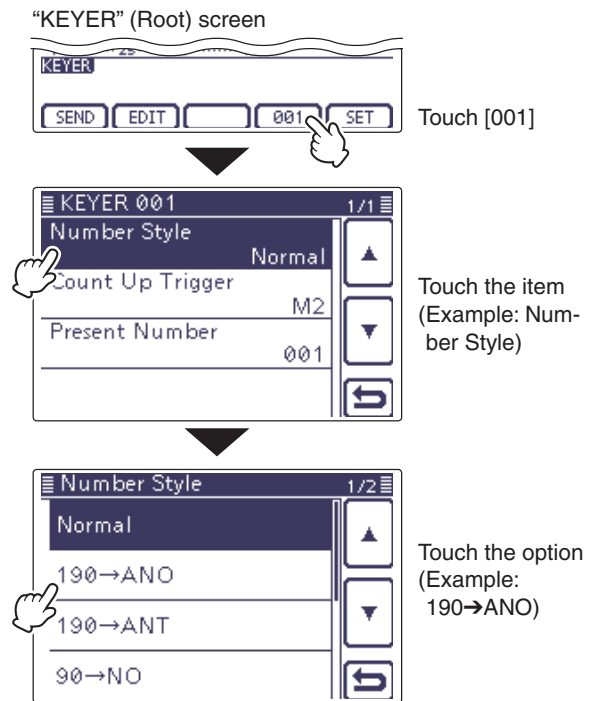

• To the default setting

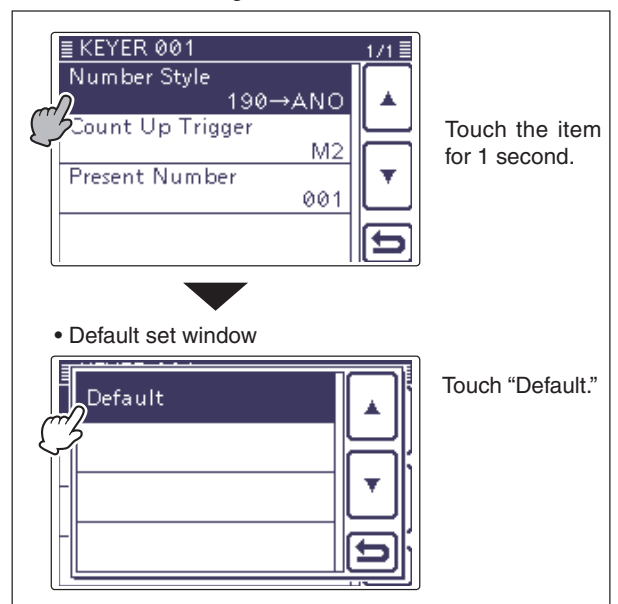

4 RECEIVE AND TRANSMIT

Electronic keyer functions (Continued)

◆ Keyer Set mode

This Set mode is used to set the CW sidetone, memory keyer repeat time, dash weight, paddle specifications, keyer type, and so on.

• Setting contents

- ① In the CW mode, push **MENU**(C) one or more times to select the “M-2” screen (M-2 menu).
- ② Push **[KEYER]**(D) to display the “KEYER SEND” screen.
 - If the “KEYER” (Root) screen is displayed, skip step ③.
- ③ Push **MENU**(C) to display the “KEYER” screen.
- ④ Touch **[SET]**(D) to enter the “KEYER SET” screen.
- ⑤ Touch the desired item to select.
 - See the next page for details of the set items and options.
- ⑥ Touch the desired option or rotate the Dial to change the value.
 - If desired, touch the item for 1 second to open the Default set window, then select the “Default” to reset to the default setting.
- ⑦ Touch **[↵]**(D) or push **MENU**(C) to return to the “KEYER” (Root) screen.

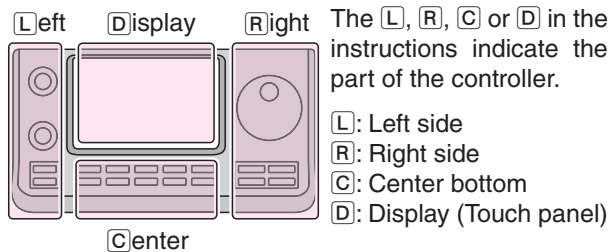

• Keyer Set mode

“KEYER” screen (Memory Keyer)

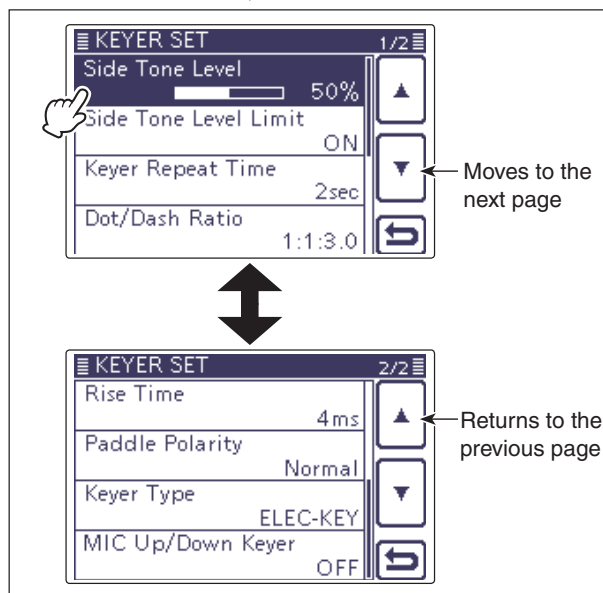
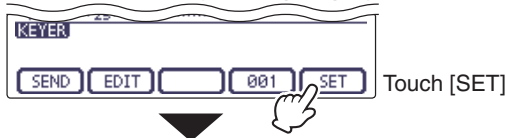

(Example: Touch the “Side Tone Level.”)

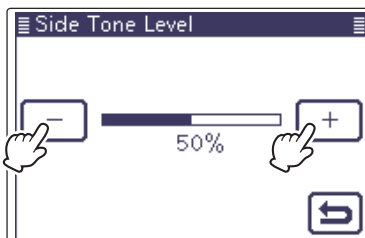

4 RECEIVE AND TRANSMIT

Electronic keyer functions (Continued)

◇ Keyer set mode (Continued)

Side Tone Level (Default: 50%)

Select the CW sidetone output level.

- 0 to 100% can be selected.

Side Tone Level Limit (Default: ON)

Set the CW sidetone level limit. When the [AF]  (L) control is rotated above a specified level, the CW sidetone does not increase.

- OFF: CW sidetone level is not limited.
- ON: CW sidetone level is limited.

Keyer Repeat Time (Default: 2sec)

When sending CW using the repeat timer, set the time between transmissions.

- 1 to 60 seconds in 1 second steps can be selected.

Dot/Dash Ratio (Default: 1:1:3.0)

Set the dot/dash ratio.

- 1:1:2.8 to 1:1:4.5 (in 0.1 steps) can be selected.

Keying weight example: Morse code "K"

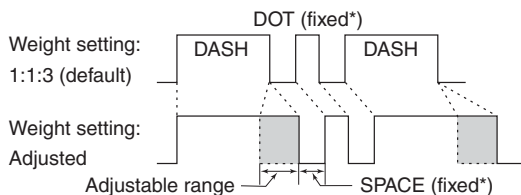

*SPACE and DOT length can be adjusted on the Key Speed/CW pitch adjustment display.

Rise Time (Default: 4ms)

Set the rise time of the transmitted CW envelope.

- 2, 4, 6 or 8 milliseconds can be selected.

About rise time

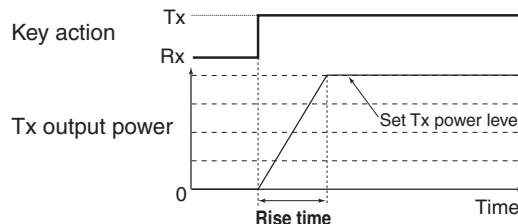

▨ Key clicks on nearby frequencies can be generated if the rise time of a CW waveform is too short.

Paddle Polarity (Default: NORMAL)

Set the paddle polarity.

- Normal or reverse polarity can be selected.

Keyer Type (Default: ELEC-KEY)

Select the keyer type for [ELEC-KEY] connector on the controller.

- Straight key, BUG-KEY or ELEC-KEY can be selected.

▨ Regardless of this setting, the [KEY] connector of the Main unit is for only a straight key.

MIC Up/Down Keyer (Default: OFF)

Set the microphone [UP]/[DN] switches to be used as a key. (The microphone [UP]/[DN] switches do not work as a "squeeze key.")

- ON: The [UP]/[DN] switches can be used as a key for CW.
- OFF: The [UP]/[DN] switches cannot be used as a key for CW.

▨ When "ON" is selected, the frequency and memory channels cannot be changed using the [UP]/[DN] switches.
 ▨ The optional HM-151 microphone cannot be used as a MIC Up/Down Keyer.

4 RECEIVE AND TRANSMIT

Operating RTTY (FSK)

When using your RTTY terminal or TNC, consult the manual that comes with the equipment.

- ① Select the desired frequency band. (p. 35)
- ② On the Mode selection screen, touch "RTTY" to select the RTTY mode.
 - After the RTTY mode is selected, touch "RTTY" again to toggle between the normal and reverse modes, if needed.
- ③ Enter the RTTY decoder screen.

- ① Push [MENU](C) one or more times to select the "M-2" screen (M-2 menu).
 - ② Touch [DEC](D) to display the RTTY decoder screen.
 - Touch [WIDE](D) to toggle the decode screen size between normal and wide.
- ④ Rotate the Dial to tune a desired signal.
 - The S-meter displays the received signal strength.
 - If the received signal cannot be demodulated, try to select the RTTY reverse mode in step ②.
 - The tuning step can be changed on the Tuning step selection screen by touching "kHz frequency." (p. 38)
- ⑤ Switch ON the external TX switch to set the transceiver to the transmit mode, or transmit a SEND signal from your TNC.
 - The TX/RX indicator lights red.
 - The Po meter displays the transmitted RTTY signal strength.
- ⑥ Use your connected PC or TNC (TU) to transmit RTTY (FSK) signals.
- ⑦ Switch OFF the external TX switch to receive.

Convenient Receive functions

- Preamp and attenuator (p. 71)
- Twin PBT (passband tuning) (p. 75)
- AGC (auto gain control) (p. 72)
- Noise blanker (p. 76)
- Noise reduction (p. 77)
- Notch filter (p. 77)
- ¼ function (p. 39)
- Twin Peak Filter (p. 58)

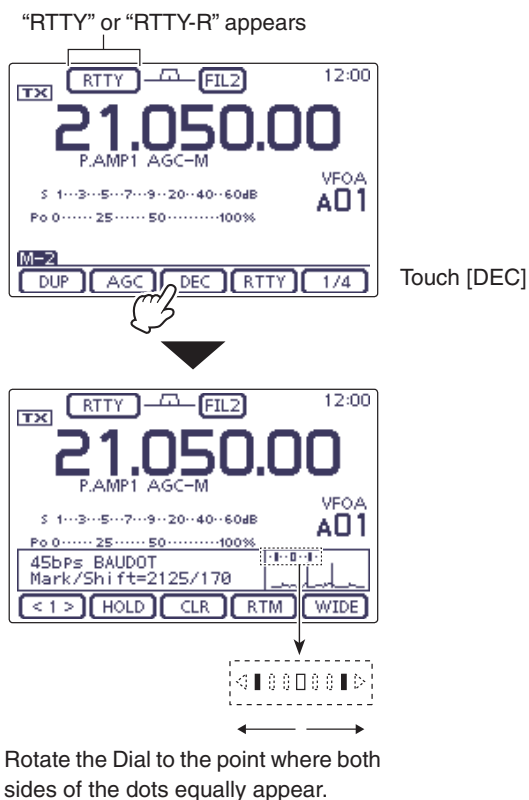
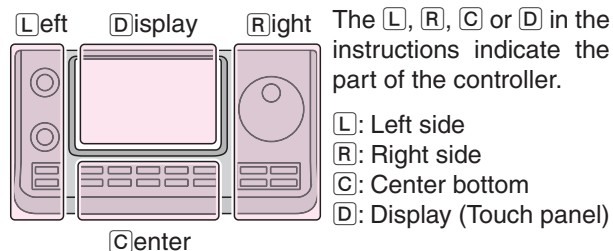

4 RECEIVE AND TRANSMIT

The functions for RTTY operation

◆ About RTTY reverse mode

Received characters are occasionally garbled when the Mark and Space signals are reversed. This reversal can be caused by incorrect TNC connections, setting or commands.

To correctly receive reversed RTTY signals, select the RTTY reverse mode.

- ① On the Mode selection screen, touch “RTTY” to select the RTTY mode.
- ② After the RTTY mode is selected, touch “RTTY” again on the Mode selection screen, toggles between the normal and reverse modes.
 - “RTTY-R” appears when the RTTY reverse mode is selected.

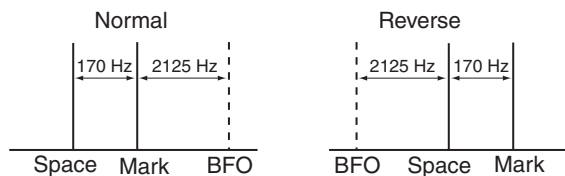
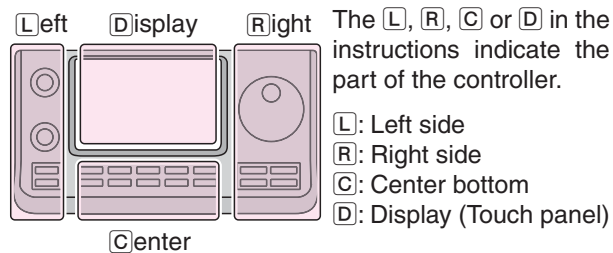

◆ Twin Peak Filter

The Twin Peak Filter changes the receive frequency response by boosting 2125 and 2295 Hz for better copying of RTTY signals.

- ① In the RTTY mode, push **MENU**(C) one or more times to select the “M-2” screen (Menu M-2).
- ② Touch **[RTTY]**(D) to display the “RTTY SET” screen.
- ③ Touch the “Twin Peak Filter” item to select.
- ④ Touch “ON” to turn ON the Twin Peak Filter.
- ⑤ Touch **[↶]**(D) or push **MENU**(C) to return to the “M-2” screen (Menu M-2).

NOTE: When the Twin Peak Filter is in use, the received audio output may increase. This is normal; not a malfunction.

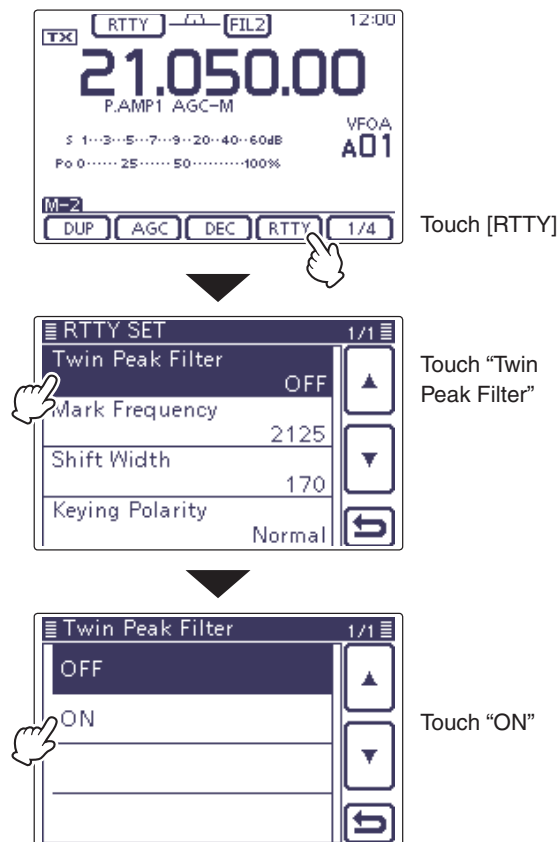

4 RECEIVE AND TRANSMIT

The functions for RTTY operation (Continued)

◇ RTTY Set mode

The RTTY Set mode is used to set the Twin peak filter function, mark and shift frequencies and the keying polarity.

• Setting contents

- ① In the RTTY mode, push **MENU**(C) one or more times to select the "M-2" screen (Menu M-2).
- ② Touch **[RTTY]**(D) to display the "RTTY SET" screen.
- ③ Touch the desired item to select.
 - See below for details of the set items and options.
- ④ Touch the desired option or rotate the Dial to change the setting.
 - If desired, touch the item for 1 second to open the Default set window, then select the "Default" to reset to the default setting.
- ⑤ Touch **[↶]**(D) or push **MENU**(C) to return to the "M-2" screen (Menu M-2).

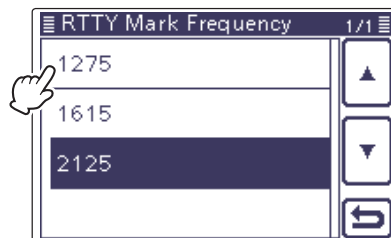
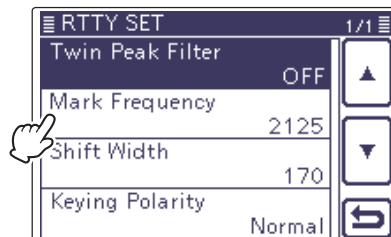
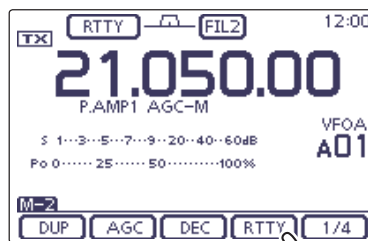
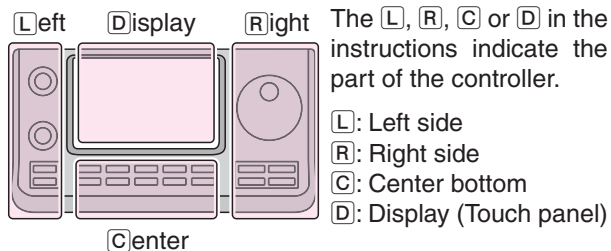

Twin Peak Filter (Default: OFF)

Turn the Twin Peak Filter ON or OFF.

Mark Frequency (Default: 2125)

Select the RTTY mark frequency.

- 1275, 1615 and 2125 Hz are selectable.

Shift Width (Default: 170)

Select the RTTY frequency shift.

- 170, 200 and 425 Hz are selectable.

Keying Polarity (Default: NORMAL)

Select normal or reverse keying polarity.

- NORMAL: Key open/close = Mark/Space
- REVERSE: Key open/close = Space/Mark

4 RECEIVE AND TRANSMIT

The functions for RTTY operation (Continued)

◇ RTTY decoder

The transceiver has an RTTY decoder for Baudot (mark frequency: 2125 Hz, shift frequency: 170 Hz, 45 bps).

An external terminal unit (TU) or terminal node connector (TNC) is not necessary for receiving a Baudot signal.

- ① In the RTTY mode, push **[MENU]**(C) one or more times to select the “M-2” screen (Menu M-2).
- ② Touch **[DEC]**(D) to display the RTTY decoder screen.
 - Touch **[WIDE]**(D) to toggle the decode screen size between normal and wide.
- ③ Touch **[HOLD]**(D) to turn ON the Hold function to hold the current screen.
 - “H” appears when this function is turned ON.
 - Touch **[HOLD]**(D) again to turn OFF the Hold function.
- ④ Touch **[CLR]**(D) for 1 second to clear the displayed characters.
- ⑤ Push **[MENU]**(C) to return to the “M-2” screen (Menu M-2).

• Setting the decoder threshold level

If some characters are displayed when no signal is received, adjust the RTTY decoder threshold level.

- ① In the RTTY mode, push **[MENU]**(C) one or more times to select the “M-2” screen (Menu M-2).
- ② Touch **[DEC]**(D) to display the RTTY decoder screen.
 - Touch **[WIDE]**(D) to toggle the decode screen size between normal and wide.
- ③ Touch **[<1>]**(D) to display the RTTY decoder (2) screen.
 - Touch **[<1>]** or **[<2>]**(D) to toggle between the RTTY decoder and the RTTY decode (2) screens.
- ④ Touch **[ADJ]**(D) to select the threshold level adjustment mode.
- ⑤ Rotate the Dial to adjust the RTTY decoder threshold level.
 - Touch **[DEF]**(D) for 1 second to reset to the default setting, if desired.
- ⑥ Push **[MENU]**(C) to exit the adjustment mode.

▨ The number of the decoder display lines, the UnShift On Space (USOS) function and new line code can be set in the RTTY Set mode. (p. 60)

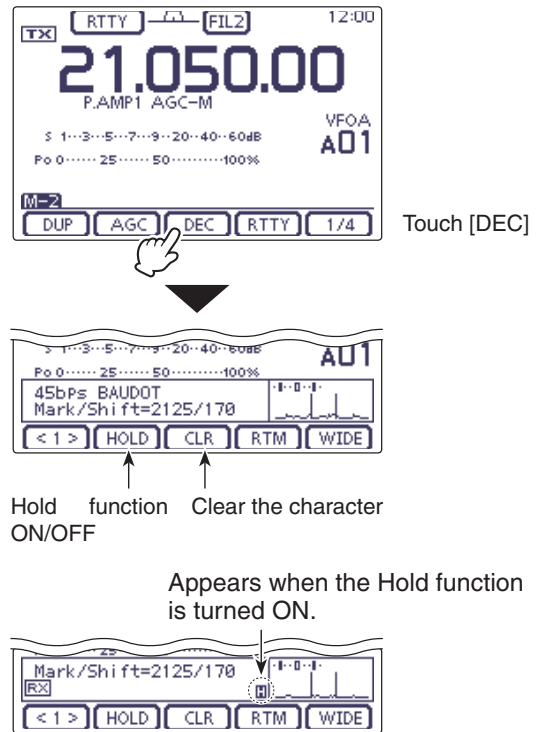

The **L**, **R**, **C** or **D** in the instructions indicate the part of the controller.
L: Left side, **R**: Right side, **C**: Center bottom
D: Display (Touch panel)

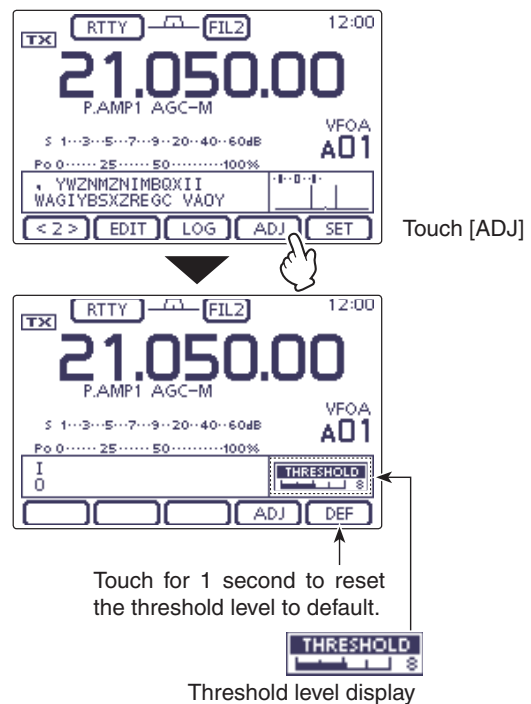

4 RECEIVE AND TRANSMIT

The functions for RTTY operation (Continued)

◆ RTTY decode Set mode

The RTTY decode Set mode is used to set the decode USOS function, RTTY decoder new line code and the TX USOS function.

• Setting contents

- ① In the RTTY mode, push **MENU**(**C**) one or more times to select the “M-2” screen (Menu M-2).
- ② Touch **[DEC]**(**D**) to display the RTTY decoder screen.
 - Touch **[WIDE]**(**D**) to toggle the decode screen size between normal and wide.
- ③ Touch **[<1>]**(**D**) to display the RTTY decoder (2) screen.
 - Touch **[<1>]** or **[<2>]**(**D**) to toggle between the RTTY decoder and the RTTY decode (2) screens.
- ④ Touch **[SET]**(**D**) to enter the “RTTY DECODE SET” screen.
- ⑤ Touch the desired item to select.
 - See below for details of the set items and options.
- ⑥ Touch the desired option or rotate the Dial to change the setting.
 - If desired, touch the item for 1 second to open the Default set window, then select the “Default” to reset to the default setting.
- ⑦ Touch **[↵]**(**D**) or push **MENU**(**C**) to return to the “KEYER” (Root) screen.
- ⑧ Push **MENU**(**C**) to return to the “M-2” screen (Menu 2).

The **L**, **R**, **C** or **D** in the instructions indicate the part of the controller.

- L**: Left side, **R**: Right side, **C**: Center bottom
- D**: Display (Touch panel)

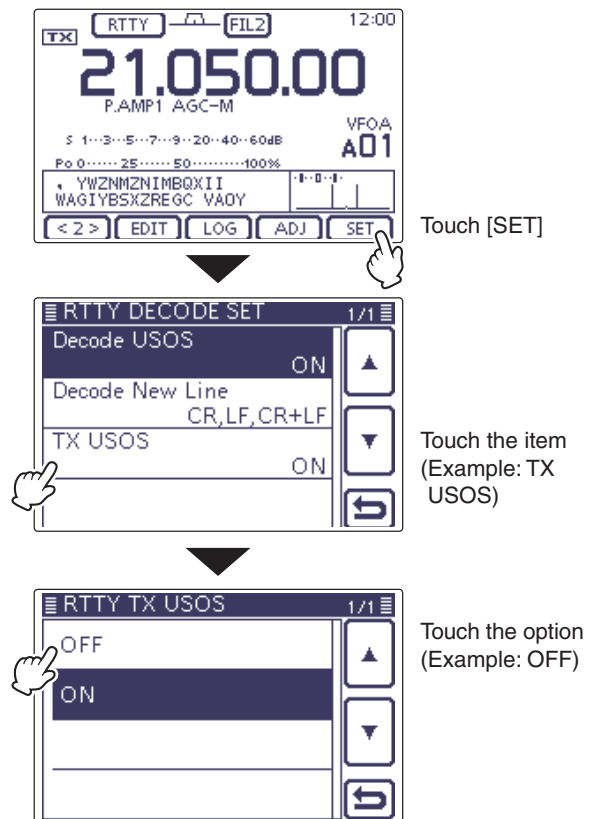

Decode USOS (Default: ON)

Turn the USOS (UnShift On Space) function ON or OFF. This function decodes a letter code after receiving a “space.”

- OFF: Decodes as a character code
- ON: Decodes as a letter code

TX USOS (Default: ON)

Explicitly inserts the FIGS character, even though it is not required by the receiving station.

- OFF: Inserts FIGS
- ON: Does not insert FIGS

Decode New Line (Default: CR,LF,CR+LF)

Select the internal RTTY decoder new line code.
CR: Carriage Return, LF: Line Feed

- CR,LF,CR+LF: Makes a new line with any code.
- CR+LF: Makes a new line with only the CR+LF code.

4 RECEIVE AND TRANSMIT

The functions for RTTY operation (Continued)

◆ Transmitting an RTTY memory

Previously entered characters can be sent using the RTTY memory. Contents of the memory are entered in the RTTY Memory (Edit) screen.

- ① In the RTTY mode, push **MENU**(C) one or more times to select the “M-2” screen (Menu M-2).
- ② Touch **[DEC]**(D) to display the RTTY decoder screen.
 - Touch **[WIDE]**(D) to toggle the decode screen size between normal and wide.
- ③ Touch **[RTM]**(D) to display the RTTY memory screen.
- ④ Touch **[▶]**(D) to select the memory group to transmit.
 - Touch **[▶]**(D) to toggle the memory group between RT1–RT4 and RT5–RT8.
- ⑤ Touch one of the memory keys, **[RT1]** to **[RT4]**, or **[RT5]** to **[RT8]**(D).
 - The TX/RX indicator lights red.
 - The TX contents are displayed beside the “**TX**” icon.
- ⑥ Push **MENU**(C) to return to the “M-2” screen (Menu M-2).

For your information

When an external keypad is connected to [MIC] connector on the Controller, one of RT1 to RT4 RTTY memory contents can be transmitted while the RTTY decode screen is selected in the RTTY mode. (pgs. 18, 133)

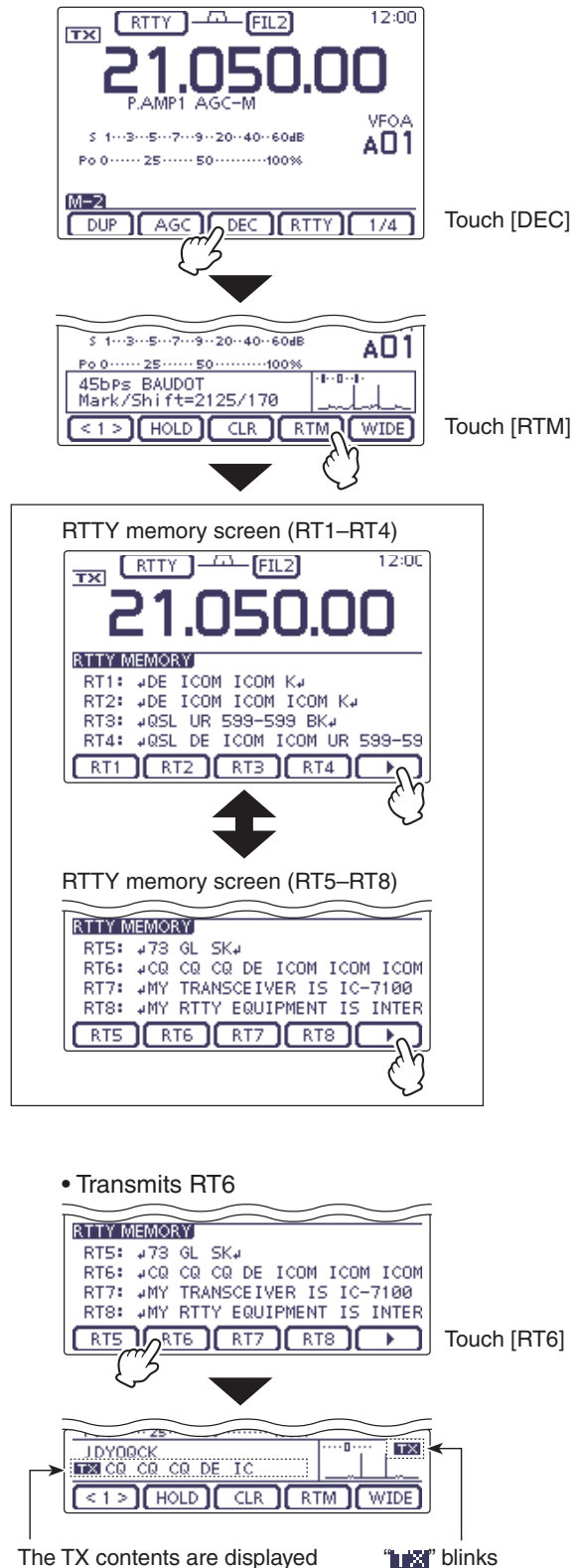
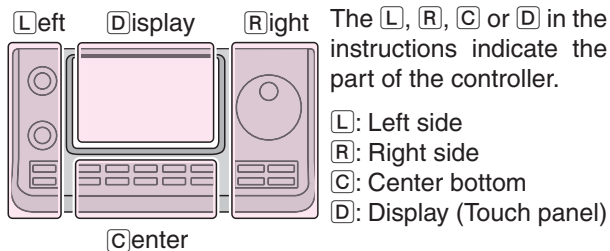

4 RECEIVE AND TRANSMIT

The functions for RTTY operation (Continued)

◇ Editing an RTTY memory

The contents of the RTTY memories can be set on the RTTY Memory (Edit) screen. The RTTY memory can memorize and retransmit 8 RTTY message for often-used RTTY information. The total capacity of the RTTY memory is 70 characters per memory channel.

• Programming contents

- ① In the RTTY mode, push **[MENU]**(C) one or more times to select the “M-2” screen (M-2 menu).
- ② Touch **[DEC]**(D) to display the RTTY decoder screen.
 - Touch **[WIDE]**(D) to toggle the decode screen size between normal and wide.
- ③ Touch **[<1>]**(D) to display the RTTY decoder (2) screen.
 - Touch **[<1>]** or **[<2>]**(D) to toggle between the RTTY decoder and the RTTY decode (2) screens.
- ④ Touch **[EDIT]**(D) to display the “RTTY MEMORY” (Edit) screen.
 - The memory contents are displayed.
- ⑤ Touch for 1 second on a desired memory channel to be edited, and then touch “Edit.”
 - Touch **[▲]** or **[▼]**(D) to select the displayed page.
 - The memory programming screen appears.
- ⑥ Touch the desired block one or more times to select the desired character or symbol.

Selectable characters and symbols
ABCDEFGHIJKLMNOPQRSTUVWXYZ
1234567890
! \$ % ? " ' - / . , ; () _

- Touch “AB↔12” to toggle between the Alphabet input and Number input mode.
 - Touch **[CLR]**(D) to delete the selected character, symbol or number.
 - Touch **[SYMB]**(D) to open the Symbol character selection window.
 - Touch “_” to input a space.
- ⑦ Touch **[←]**(D) or **[→]**(D) to move the cursor backwards or forwards.
 - ⑧ Repeat steps ⑥ and ⑦ to program up to 70 characters of memory contents, and then push **[ENT]**(D).
 - ⑨ Touch **[↵]**(D) or push **[MENU]**(C) to return to the RTTY Decode (2) screen.

L Left

D Display

R Right

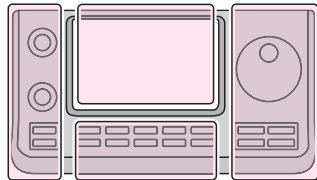

The **L**, **R**, **C** or **D** in the instructions indicate the part of the controller.

L: Left side

R: Right side

C: Center bottom

D: Display (Touch panel)

• RTTY memory programming mode

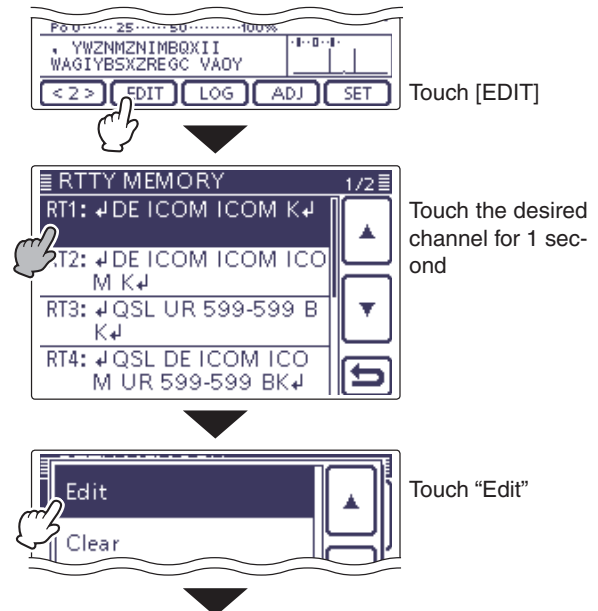

RT1 default indication

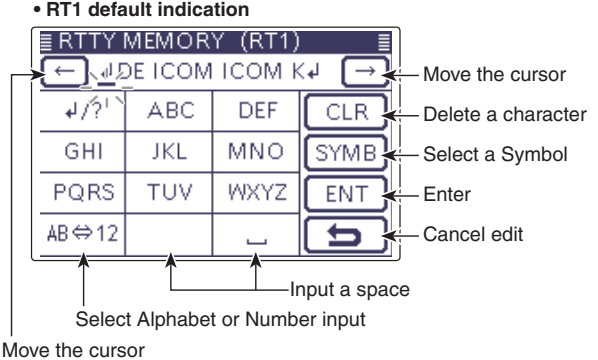

- Move the cursor
- Delete a character
- Select a Symbol
- Enter
- Cancel edit
- Input a space
- Select Alphabet or Number input

• Preprogrammed contents

CH	Contents
RT1	└DE ICOM ICOM K└
RT2	└DE ICOM ICOM ICOM K└
RT3	└QSL UR 599-599 BK└
RT4	└QSL DE ICOM ICOM UR 599-599 BK└
RT5	└73 GL SK└
RT6	└CQ CQ CQ DE ICOM ICOM ICOM K└
RT7	└MY TRANSCEIVER IS IC-7100 & ANTENNA IS A 3-ELEMENT TRIBAND YAGI.└
RT8	└MY RTTY EQUIPMENT IS INTERNAL FSK UNIT & DEMODULATOR OF THE IC-7100.└

4 RECEIVE AND TRANSMIT

The functions for RTTY operation (Continued)

◇ Turning ON the RTTY decode log

Turn ON the RTTY decode log to store your RTTY operating record, both TX and RX, into an SD card.

Be sure to insert the SD card, otherwise this function does not work properly. The SD card is not supplied by Icom.

- ① In the RTTY mode, push **MENU**(C) one or more times to select the “M-2” screen (M-2 menu).
- ② Touch **[DEC]**(D) to display the RTTY decoder screen.
 - Touch **[WIDE]**(D) to toggle the decode screen size between normal and wide.
- ③ Touch **[<1>]**(D) to display the RTTY decoder (2) screen.
 - Touch **[<1>]** or **[<2>]**(D) to toggle between the RTTY decoder and the RTTY decode (2) screens.
- ④ Touch **[LOG]**(D) to display the “RTTY DECODE LOG” screen.
- ⑤ Touch “Decode Log,” and then select the RTTY decode log function ON or OFF.
 - If desired, touch the item for 1 second to open the Default set window, then select “Default” to reset to the default setting.
 - When “ON” is selected, the RTTY decode log starts.
- ⑥ Touch **[↵]**(D) or push **MENU**(C) to return to the RTTY Decoder screen.

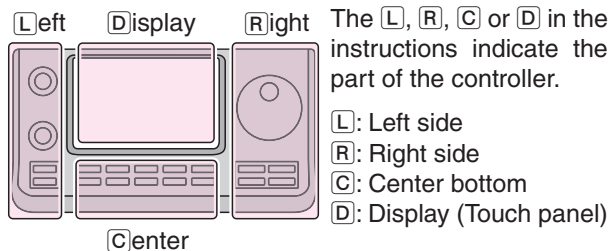

• RTTY decode log

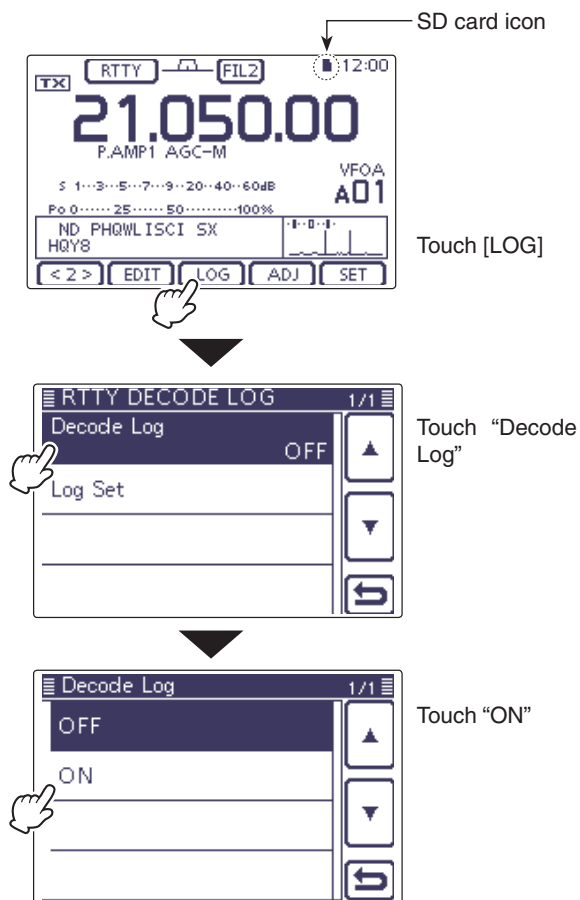

4 RECEIVE AND TRANSMIT

The functions for RTTY operation (Continued)

◇ RTTY decode log Set mode

The RTTY decode log Set mode is used to set the File Type and the Time stamps.

- ① In the RTTY mode, push **[MENU]**(C) one or more times to select the “M-2” screen (M-2 menu).
- ② Touch **[DEC]**(D) to display the RTTY decoder screen.
 - Touch **[WIDE]**(D) to toggle the decode screen size between normal and wide.
- ③ Touch **[<1>]**(D) to display the RTTY decoder (2) screen.
 - Touch **[<1>]** or **[<2>]**(D) to toggle between the RTTY decoder and the RTTY decode (2) screens.
- ④ Touch **[LOG]**(D) to display the “RTTY DECODE LOG” screen.
- ⑤ Touch “Log Set” to enter the “RTTY DECODE LOG SET” screen.
- ⑥ Touch the desired item to select.
 - See below for details of the set items and options.
- ⑦ Touch the desired option to change the setting.
 - If desired, touch the item for 1 second to open the Default set window, then select the “Default” to reset to the default setting.
- ⑧ Touch **[↵]**(D) or push **[MENU]**(C) to return to the “RTTY DECODE LOG” screen.
- ⑨ Touch **[↵]**(D) or push **[MENU]**(C) to return to the RTTY Decoder screen.

RTTY decode log Set mode

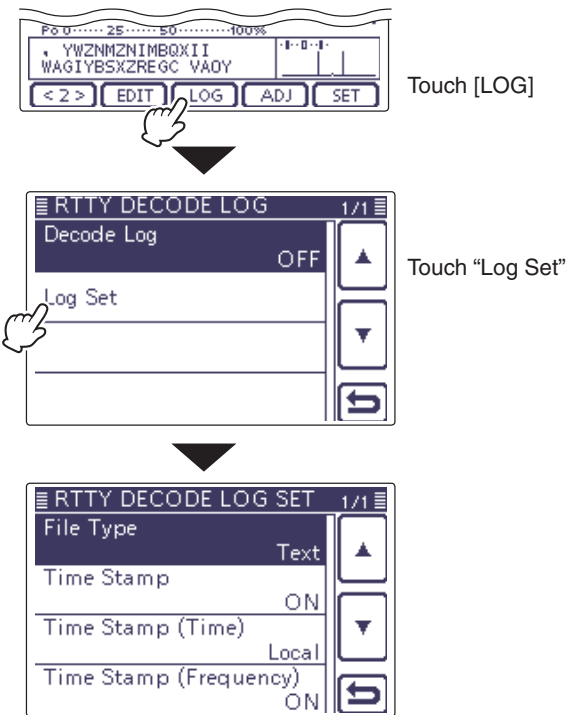

File type (Default: Text)

Select file type for saving a Log into an SD card, as the Text or HTML format.

- Text: Save as a Text format
- HTML: Save as an HTML format

Time stamp (Default: ON)

Adds the time stamp (date, transmission or reception time) to the LOG file.

- OFF: Does not save the time stamp.
- ON: Saves the date and time data.

Time stamp (time) (Default: Local)

Select the time of the time stamp whether it is in local or UTC.

NOTE: The time won't be saved when “OFF” is selected in “Time Stamp” to the left.

- Local: The time is used in Local time
- UTC: The time is used in UTC time

Time stamp (frequency) (Default: ON)

Selects the time stamp data whether adding the frequency or not.

NOTE: The frequency won't be saved when “OFF” is selected in “Time Stamp” to the left.

- OFF: Does not save the frequency
- ON: Saves the frequency data

4 RECEIVE AND TRANSMIT

Operating AM/FM

- ① Select the desired frequency band. (p. 35)
- ② On the Mode selection screen, touch “AM” or “FM” to select the AM or FM mode.
 - To select the data mode, after selecting AM or FM, touch “DATA” to select the data mode, if needed.
- ③ Rotate the Dial to tune a desired signal.
 - The S-meter displays the received signal strength.
 - The tuning step can be changed on the Tuning step selection screen by touching “kHz frequency.” (p. 38)
- ④ Rotate [AF] (L) to adjust the audio to a comfortable listening level.
- ⑤ Push [PTT] on the microphone to transmit.
 - The TX/RX indicator lights red.
- ⑥ Speak into the microphone at your normal voice level.
- ⑦ If necessary, adjust the microphone gain or RF power on the Mic gain/RF power adjustment display.

- ① Push [MIC/RF PWR] (C) to open the MIC gain/RF power adjustment display.

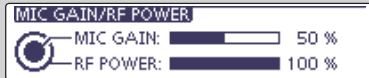

- ② Rotate [M-CH] (L) to adjust the MIC gain, or [BANK] (L) to adjust the RF power.
 - To adjust the MIC gain, adjust it with another station listening to your voice for clarity.
 - ▨ When the MIC gain is adjusted too high, your transmitted voice may be distorted.
- ③ Push [MENU] (C) to close the display.

- ⑧ Release [PTT] to receive.

▨ **NOTE:** On the 144/440 MHz frequency band, you can transmit in the AM mode.

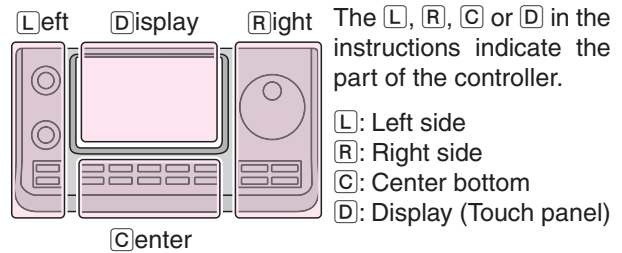

“AM” or “FM” appears

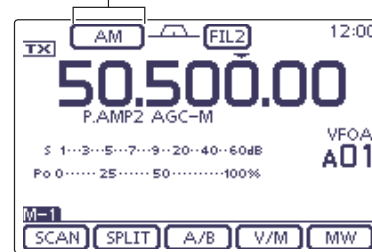

Convenient Receive functions

- Preamp and attenuator (p. 71)
- Twin PBT (passband tuning) (p. 75)
 - This function is not usable in the FM mode.
- AGC (auto gain control) (p. 72)
- Noise blanker (p. 76)
- Noise reduction (p. 77)
- Notch filter (p. 77)

Convenient Transmit functions

- VOX (voice operated transmit) (p. 80)
- Transmit quality monitor (p. 81)
- Tone control (p. 169)

4 RECEIVE AND TRANSMIT

Tone squelch operation

The tone squelch opens only when you receive a signal containing a matching subaudible tone. You can silently wait for calls from others using the same tone.

- ① Select the desired frequency band. (p. 35)
- ② On the Mode selection screen, touch "FM" to select the FM mode.
- ③ Push **MENU**(C) one or more times to select the "M-2" screen (M-2 menu).
- ④ Touch **[TONE]**(D) one or more times to turn ON the Tone squelch function.
 - "TSQL" appears.
 - Touch **[TONE]**(D) to toggle between "TONE," "TSQL," "DTCS" and OFF (icon disappears).
- ⑤ Touch **[TONE]**(D) for 1 second to display the "TONE" screen.
 - "TSQL Tone" appears.
- ⑥ Rotate the Dial to select the desired tone squelch frequency. See the table shown below.
 - If desired, touch **[DEF]** for 1 second to reset to the default setting.
- ⑦ Push **MENU**(C) to exit the "TONE" screen.
- ⑧ Communicate in the usual manner.
 - The tone squelch opens only when you receive a signal containing a matching subaudible tone.
 - Subaudible tones are superimposed on your transmit signal.

• Available tone squelch frequencies (Unit: Hz)

67.0	88.5	114.8	151.4	177.3	203.5	250.3
69.3	91.5	118.8	156.7	179.9	206.5	254.1
71.9	94.8	123.0	159.8	183.5	210.7	
74.4	97.4	127.3	162.2	186.2	218.1	
77.0	100.0	131.8	165.5	189.9	225.7	
79.7	103.5	136.5	167.9	192.8	229.1	
82.5	107.2	141.3	171.3	196.6	233.6	
85.4	110.9	146.2	173.8	199.5	241.8	

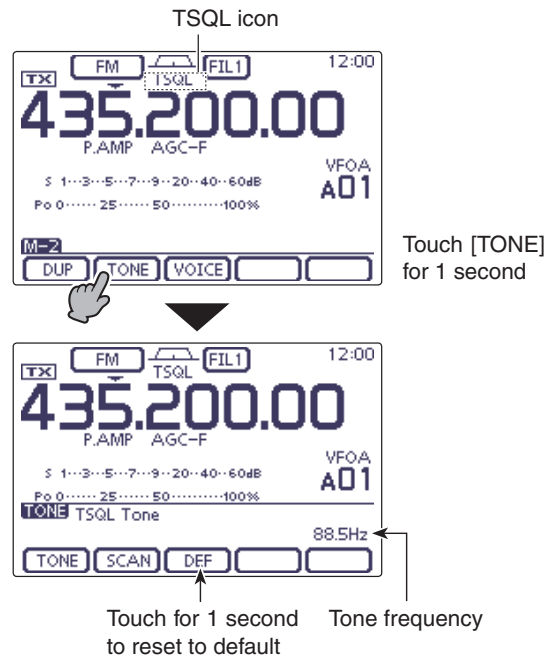
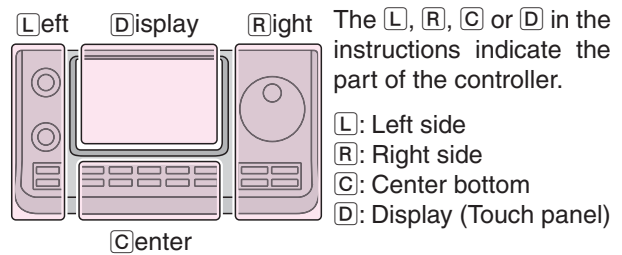

4 RECEIVE AND TRANSMIT

DTCS operation

The DTCS function is another method of communications using selective calling. Only received signals having a matching 3-digit code will open the squelch.

- ① Select the desired frequency band. (p. 35)
- ② On the Mode selection screen, touch “FM” to select the FM mode.
- ③ Push **MENU**(C) one or more times to select the “M-2” screen (M-2 menu).
- ④ Touch **[TONE]**(D) one or more times to turn ON the DTCS function.
 - “DTCS” appears.
 - Touch **[TONE]**(D) to toggle between “TONE,” “TSQL,” “DTCS” and OFF (icon disappears).
- ⑤ Touch **[TONE]**(D) for 1 second to display the “TONE” screen.
 - “DTCS Code” appears.
- ⑥ Rotate the Dial to select the desired DTCS code number. And touch **[POL]**(D) to select the desired code polarity.
 - NN: Normal polarity is used for both transmit and receive. (Default)
 - NR: Normal polarity is used for transmit, reversed polarity is used for receive.
 - RN: Reversed polarity is used for transmit, normal polarity is used for receive.
 - RR: Reversed polarity is used for both transmit and receive.
 - If desired, touch **[DEF]** for 1 second to reset to the default setting.
- ⑦ Push **MENU**(C) to exit the “TONE” screen.
- ⑧ Communicate in the usual manner.
 - The tone squelch opens only when you receive a signal containing a matching subaudible tone.
 - Subaudible tones are superimposed on your transmit signal.

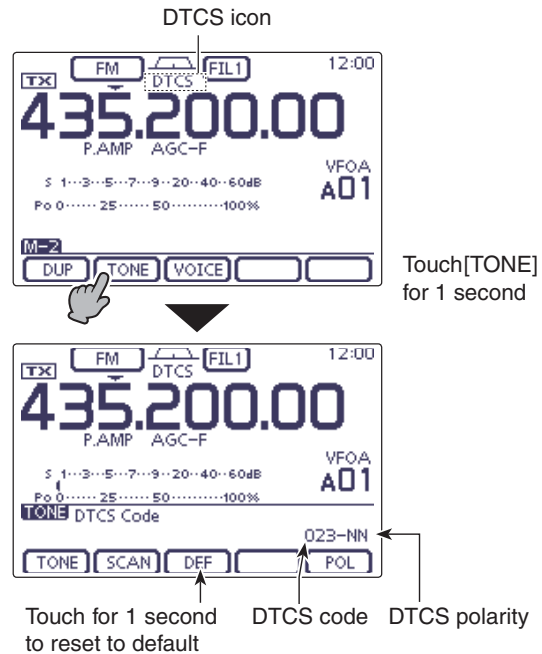

• Available DTCS codes

023	054	125	165	245	274	356	445	506	627	732
025	065	131	172	246	306	364	446	516	631	734
026	071	132	174	251	311	365	452	523	632	743
031	072	134	205	252	315	371	454	526	654	754
032	073	143	212	255	325	411	455	532	662	
036	074	145	223	261	331	412	462	546	664	
043	114	152	225	263	332	413	464	565	703	
047	115	155	226	265	343	423	465	606	712	
051	116	156	243	266	346	431	466	612	723	
053	122	162	244	271	351	432	503	624	731	

4 RECEIVE AND TRANSMIT

Tone scan/DTCS code scan operation

To search for a repeater's sub-audible tone frequency, a tone scan is available.

By monitoring a repeater signal with a tone squelch or DTCS, you can determine the tone frequency necessary to open the repeater or the squelch.

- ① Select the desired frequency band. (p. 35)
- ② On the Mode selection screen, touch "FM" to select the FM mode.
- ③ Push **MENU**(C) one or more times to select the "M-2" screen (M-2 menu).
- ④ Touch **[TONE]**(D) for 1 second to display the "TONE" screen.
- ⑤ Touch **[TONE]**(D) one or more times to select the tone type to be scanned.
 - "Repeater Tone" for a repeater tone, "TSQL Tone" for tone squelch or "DTCS Code" for a DTCS code, appears.
 - When selecting a DTCS code to be scanned, the DTCS code and its polarity is displayed. You can select the desired polarity by pushing **[POL]**(D).
 - "NN": Normal polarity for both transmit and receive.
 - "NR": Normal polarity for transmit and reverse polarity for receive.
 - "RN": Reverse polarity for transmit and normal polarity for receive.
 - "RR": Reverse polarity for both transmit and receive.
- ⑥ Touch **[SCAN]**(D) to start the Tone or DTCS scan.
 - "Repeater Tone SCAN," "TSQL Tone SCAN" or "DTCS Code SCAN" blinks, depending on the type you selected.
 - If the squelch is open while scanning, the scan speed decreases.
 - If "Up/Down" is selected as the "MAIN DIAL (SCAN)" option in the Scan Set mode, rotating the Dial changes the scanning direction. (p. 147)
- ⑦ When a matched tone or code is found, the scan pauses, and the detected subaudible tone frequency or DTCS code is set.
 - If desired, touch **[DEF]** for 1 second to reset to the default setting.
- ⑧ Touch **[SCAN]**(D) to cancel the scan.

When the tone scan or DTCS code scan is used in the Memory or Call channel mode, the detected tone frequency or code can be temporarily used. To save the detected tone frequency or code setting, you must overwrite the Memory or Call channel data. (pp. 140, 141)

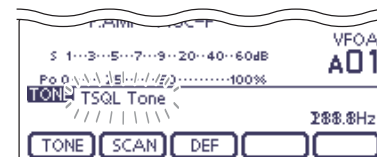
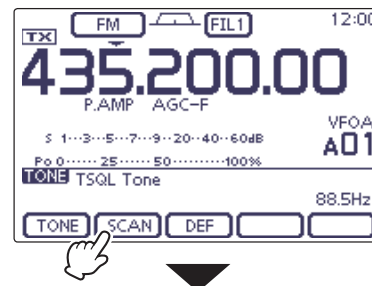
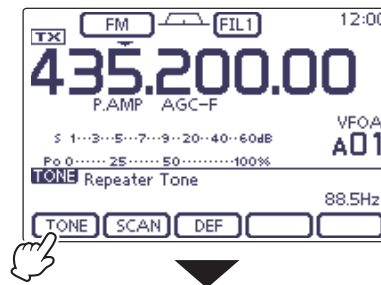
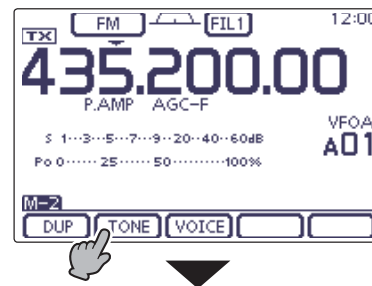
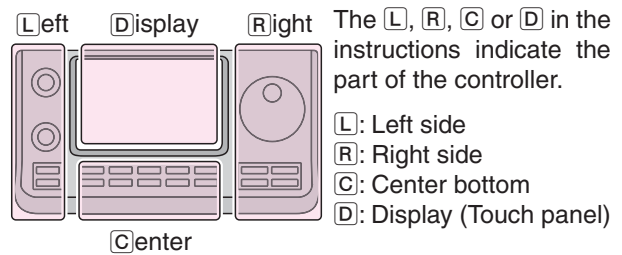

4 RECEIVE AND TRANSMIT

Repeater operation

A repeater receives transmitted signals and retransmits them on a different frequency. When using a repeater, the transmit frequency is shifted from the receive frequency by a frequency offset.

A repeater can be accessed using the duplex function—by setting the frequency shift to the same value as the repeater’s frequency offset.

See page 94 for details on accessing a D-STAR® repeater.

- ① Touch the Memory channel indication once or twice to select the VFO mode.
- ② Select the desired frequency band. (p. 35)
- ③ On the Mode selection screen, touch “FM” to select the FM mode.
- ④ Rotate the Dial to set the receive frequency (Repeater output frequency).

When the Auto Repeater function is turned ON (available in only the U.S.A. and Korea versions), steps ⑤ and ⑥ are not necessary. (p. 67)

- ⑤ Push **MENU**(C) one or more times to display the “M-2” screen (M-2 menu), then touch **[DUP]**(D) one or more times to set the offset direction.
 - “DUP-” or “DUP+” appears.
 - The transmit frequency (repeater input frequency) appears above the function menu.
 - The frequency offset (amount of shift) can be set in the “DUP Offset” item of the Function Set. (p. 163)
- ⑥ Touch **[TONE]**(D) to turn ON the repeater tone.
 - “TONE” appears.
 - The tone frequency can be set in the “TONE” screen. 88.5 Hz is set by default. (p. 4-25)
- ⑦ Communicate in the normal way.
 - Subaudible tones are superimposed on your transmit signal.

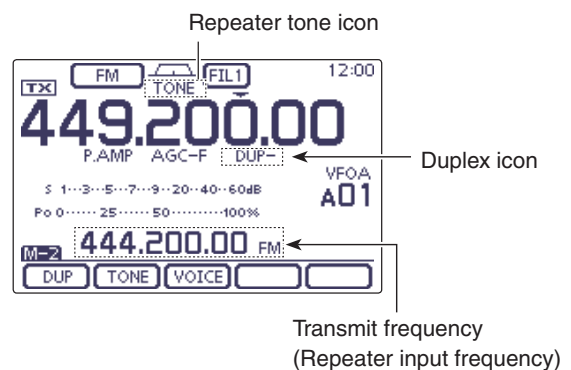
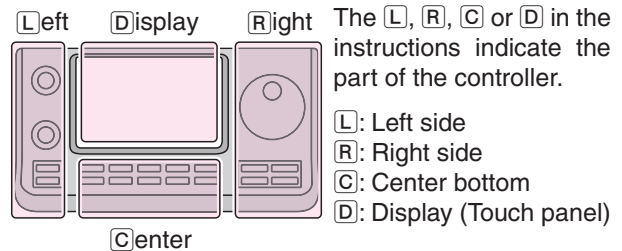

Frequency Offset setting

The frequency offset (amount of shift) can be set in the “DUP Offset” item of the Function Set. (p. 163)

SET(C) > Function > SPLIT/DUP > **DUP Offset**

Frequency offset
5.0000 MHz

If the Repeater tone frequency or the frequency offset is changed, the tone frequency or frequency offset for auto repeater function is also changed.

4 RECEIVE AND TRANSMIT

Repeater operation (Continued)

◇ Repeater access tone frequency setting

Some repeaters require a subaudible tone to be accessed. Subaudible tones are superimposed on your normal signal and must be set first. You can select 50 tones from 67.0 Hz to 254.1 Hz.

- ① In the FM mode, push **MENU**(C) one or more times to select the “M-2” screen (M-2 menu).
- ② Touch **[TONE]**(D) one or more times to turn ON the Tone encoder function.
 - “TONE” appears.
 - Touch **[TONE]**(D) to toggle between “TONE,” “TSQL,” “DTCS” and OFF (icon disappears).
- ③ Touch **[TONE]**(D) for 1 second to display the “TONE” screen.
 - “Repeater Tone” appears.
- ④ Rotate the Dial to select the desired tone squelch frequency. See the table below.
 - If desired, touch **[DEF]** for 1 second to reset to the default setting.
- ⑤ Push **MENU**(C) to exit the “TONE” screen.
- ⑥ Communicate in the normal way.
 - Subaudible tones are superimposed on your transmit signal.

• Selectable tone frequencies (Unit: Hz)

67.0	88.5	114.8	151.4	177.3	203.5	250.3
69.3	91.5	118.8	156.7	179.9	206.5	254.1
71.9	94.8	123.0	159.8	183.5	210.7	
74.4	97.4	127.3	162.2	186.2	218.1	
77.0	100.0	131.8	165.5	189.9	225.7	
79.7	103.5	136.5	167.9	192.8	229.1	
82.5	107.2	141.3	171.3	196.6	233.6	
85.4	110.9	146.2	173.8	199.5	241.8	

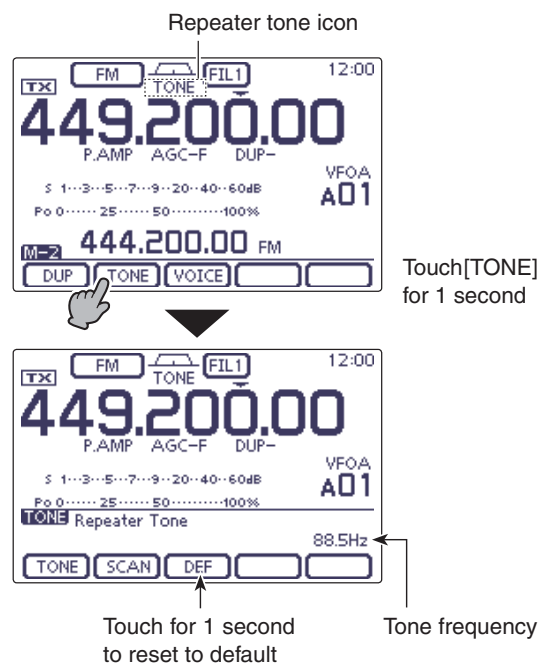
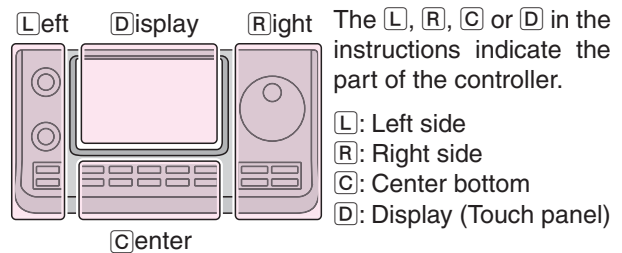

4 RECEIVE AND TRANSMIT

Repeater operation (Continued)

◆ One-touch repeater function

This function allows you to set the repeater operation by holding down one switch.

First, set the frequency offset as well as the repeater access tone frequency (p. 163).

- ① Touch the Memory channel indication once or twice to select the VFO mode.
- ② Select the desired frequency band. (p. 35)
- ③ On the Mode selection screen, touch “FM” to select the FM mode.
- ④ Rotate the Dial to set the receive frequency (Repeater output frequency).
- ⑤ Push **[MENU]**(C) one or more times to display the “M-2” screen (M-2 menu), then touch **[DUP]**(D) for 1 second to turn ON the one touch repeater function.
 - “TONE” and “DUP-” appear.
 - The repeater receive frequency appears above the function menu.
 - The Split Frequency mode is automatically turned OFF, if it is ON.
- ⑥ Touch **[DUP]**(D) one or more times to switch the offset direction.
 - “DUP-” or “DUP+” appears.
- ⑦ Communicate in the normal way.
 - Subaudible tones are superimposed on your transmit signal.

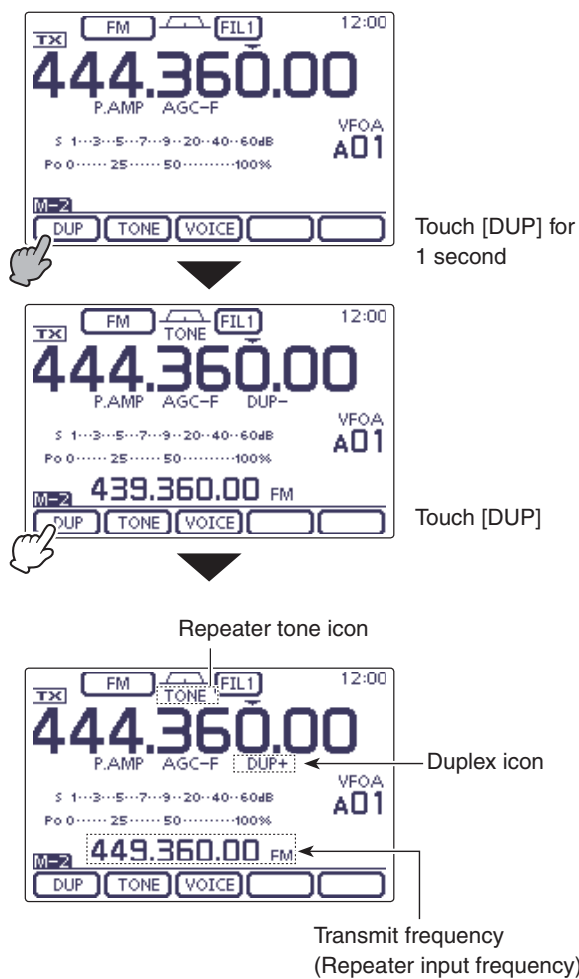
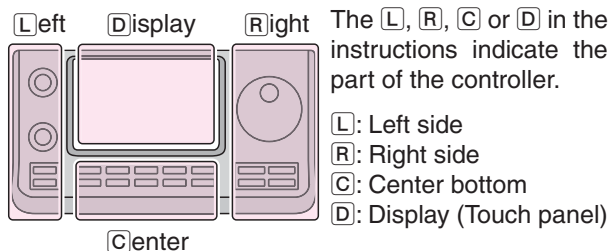

4 RECEIVE AND TRANSMIT

Repeater operation (Continued)

◆ Transmit frequency monitor check

You may be able to directly receive the other party's transmitted signal without having to go through a repeater. This function helps you to check whether direct communication can be made, or not.

- ➔ While receiving, hold down **XFC**(R) to see if you can directly receive the other party's transmitted signal.
 - While holding down **XFC**(R), the duplex direction and frequency offset are displayed above the function menu.

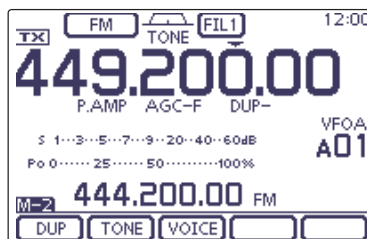
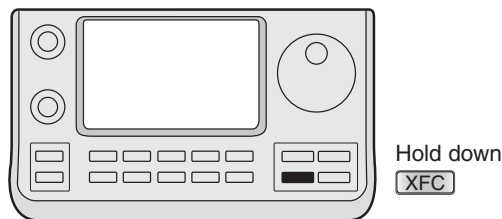

- While hold down **XFC**

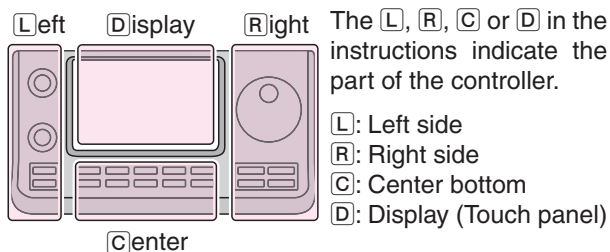
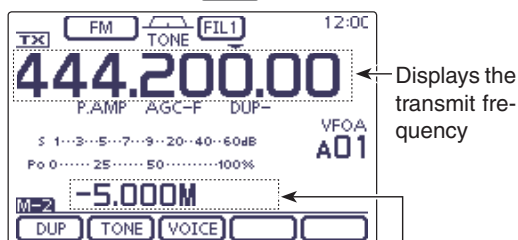

◆ 1750 Hz tone burst

A 1750 Hz tone is required to access most European repeaters.

- ① In the FM mode, push **MENU**(C) one or more times to select the "M-2" screen (M-2 menu).
- ② Push **[PTT]** on the microphone to transmit, and then touch **[TONE]**(D) during repeater access.
 - "1750Hz TONE" appears.
- ③ Communicate in the normal way.

- While hold down **[PTT]**

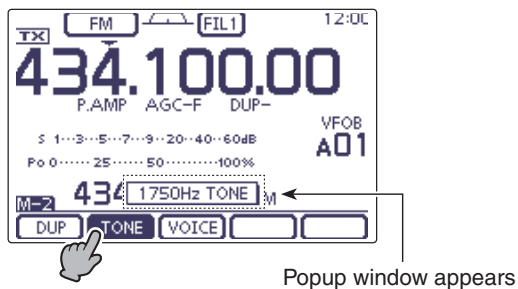

4 RECEIVE AND TRANSMIT

Repeater operation (Continued)

◇ Turning ON the Auto Repeater function (U.S.A. and Korea versions only)

When the operating frequency falls within the repeater output frequency range, the Auto Repeater function automatically sets the repeater settings (duplex ON/OFF, duplex direction, tone encoder ON/OFF).

- ① Push **SET**(C) to enter the Set mode.
- ② Touch the “Auto Repeater” item of the “Function” Set mode.

Function > SPLIT/DUP > **Auto Repeater**

- If the specified item is not displayed, touch **[▲]** or **[▼]**(D) one or more times to select the page.

- ③ Touch the desired option to turn ON the Auto Repeater function.

U.S.A. version:

- “ON-1” Activates duplex only.
- “ON-2” Activates duplex and tone.
- “OFF” Auto repeater function is turned OFF.

Korea version:

- “ON” Activates duplex and tone.
- “OFF” Auto repeater function is turned OFF.

- ④ Push **SET**(C) to exit the Set mode.

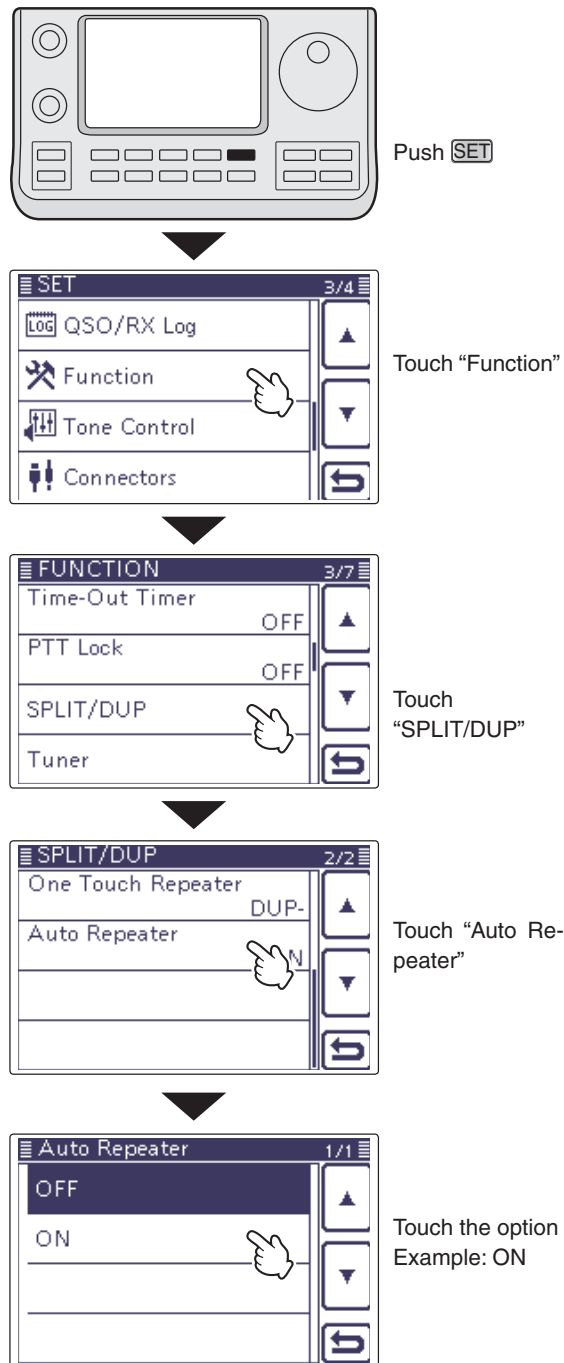
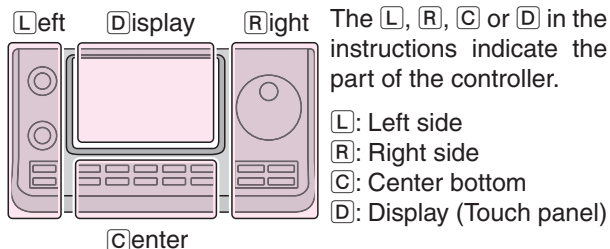

4 RECEIVE AND TRANSMIT

Repeater operation (Continued)

◆ Storing a non standard repeater

- ① Turn OFF the Auto Repeater function in the “Function” Set mode. (p. 4-28)
 [SET](C) > Function > SPLIT/DUP > **Auto Repeater**
- ② While the “M-1” menu is selected, touch [A/B](D) to select VFO A.
- ③ Rotate the Dial to set the repeater output frequency.
- ④ Touch [A/B](D) to select VFO B.
- ⑤ Rotate the Dial to set the repeater input frequency.
- ⑥ Push [MENU](C) to display the “M-2” screen (M-2 menu), then touch [TONE](D) to turn ON the previously set tone encoder.
- ⑦ Push [MENU](C) to display the “M-1” screen (M-1 menu), then touch [A/B](D) to select VFO A.
- ⑧ Touch [SPLIT](D) to turn ON the Split function.
- ⑨ Rotate [M-CH](L) to select the desired memory channel.
 - “BLANK” appears when a blank channel is selected.
 - Rotate [BANK](L) to select the desired bank, if needed.
- ⑩ Touch [MW](D) for 1 second to store the set contents into the selected memory channel.

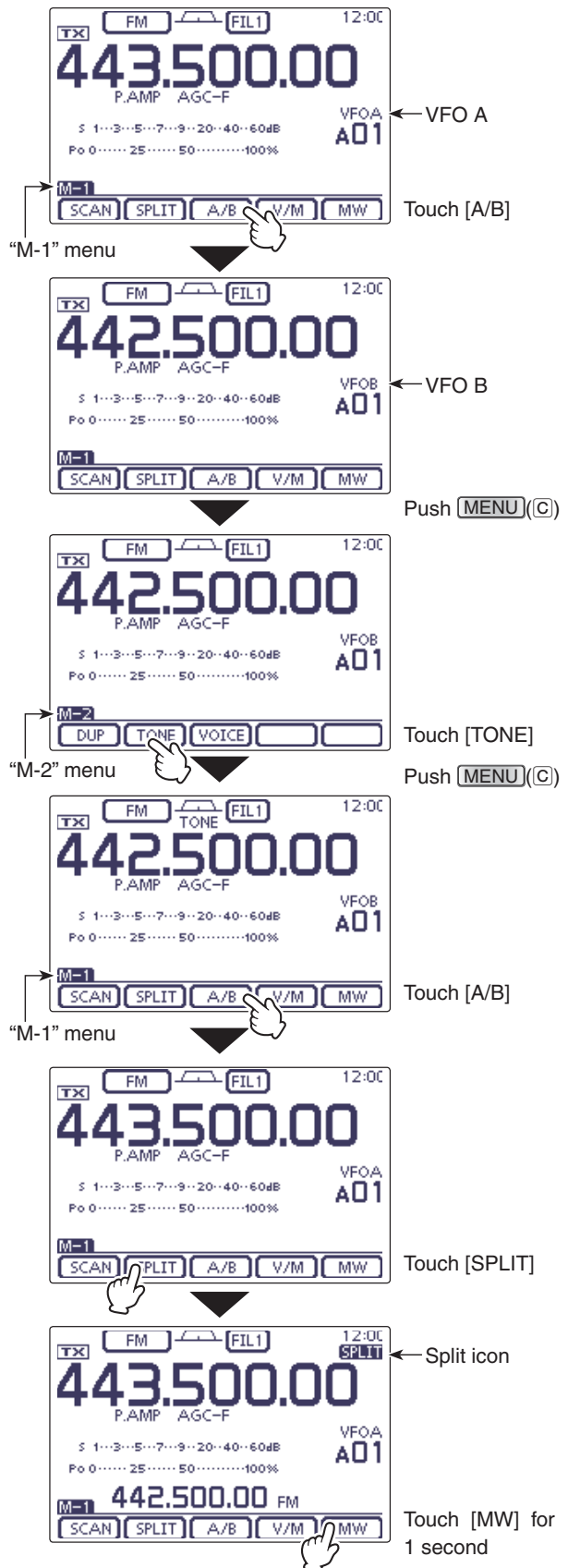
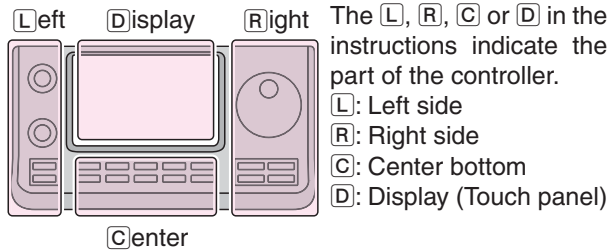

4 RECEIVE AND TRANSMIT

◇ About the 5 MHz frequency band operation (USA version only)

Operation on the 5 MHz frequency band is allowed on 5 discrete frequencies and must adhere to the following:

- The USB, USB Data, CW and PSK modes
- Maximum of 100 watts ERP (Effective Radiated Power)
- 2.8 kHz bandwidth (maximum)

It is your responsibility to set all controls so that transmission in this frequency band meets the stringent conditions under which amateur operations may use these frequencies.

NOTE: We recommend that you store these frequencies, modes and filter settings into memory channels, for easy recall.

To assist you in operating within the rules specified by the FCC, transmission is illegal on any frequencies other than the five shown in the tables at the right.

• For the USB mode

The FCC specifies center frequencies on the 5 MHz frequency band. However, the transceiver displays carrier frequency. Therefore, tune the transceiver to 1.5 kHz below the specified FCC channel center frequency.

Transceiver Displayed Frequency	FCC Channel Center Frequency
5.33050 MHz	5.33200 MHz
5.34650 MHz	5.34800 MHz
5.35700 MHz	5.35850 MHz
5.37150 MHz	5.37300 MHz
5.40350 MHz	5.40500 MHz

• For the CW mode

The transceiver displays the center frequency. Therefore, tune the transceiver to the specified FCC channel frequency when you operate in the CW mode.

Transceiver Displayed Frequency	FCC Channel Center Frequency
5.33200 MHz	5.33200 MHz
5.34800 MHz	5.34800 MHz
5.35850 MHz	5.35850 MHz
5.37300 MHz	5.37300 MHz
5.40500 MHz	5.40500 MHz

Section 5

FUNCTIONS FOR RECEIVE

- Preamp and attenuator 5-2**
 - ◇ Preamplifier 5-2
 - ◇ Attenuator 5-2
- AGC function 5-3**
 - ◇ AGC speed selection 5-3
 - ◇ Setting the AGC time constant 5-3
- RIT function 5-4**
- Twin PBT operation 5-5**
- IF filter selection 5-6**
 - ◇ IF filter selection 5-6
 - ◇ Filter passband width setting 5-6
- IF (DSP) filter shape 5-7**
- Noise Blanker 5-8**
 - ◇ NB Set mode 5-8
- Noise Reduction 5-9**
- Notch function 5-10**
 - ◇ Auto Notch function 5-10
 - ◇ Manual Notch function 5-11
- Lock function 5-12**
 - ◇ Selecting the Lock type 5-12
- Meter peak hold function 5-13**
- Simple Band Scope 5-14**

5 FUNCTIONS FOR RECEIVE

Preamp and attenuator

◇ Preamplifier

The preamplifier amplifies weak signals in the receiver front end, to improve the S/N ratio and sensitivity. Turn ON this function when receiving weak signals.

(Frequency band: HF/50 MHz)

- ➔ Push **P.AMP(ATT)**(C) one or more times to set the preamp OFF, preamp 1 ON or preamp 2 ON.
 - Either “P.AMP1” or “P.AMP2” is displayed when the preamp 1 or preamp 2 is ON.
 - No icon is displayed when the preamplifier is OFF.

P.AMP1	Wide dynamic range preamplifier. It is most effective for the 1.8 to 21 MHz bands.
P.AMP2	High-gain preamplifier. It is most effective for the 24 to 50 MHz bands.

(Frequency band: 144/430 MHz)

- ➔ Push **P.AMP(ATT)**(C) turn the Preamplifier ON or OFF.
 - “P.AMP” appears when the preamplifier is ON.
 - No icon is displayed when it's OFF.

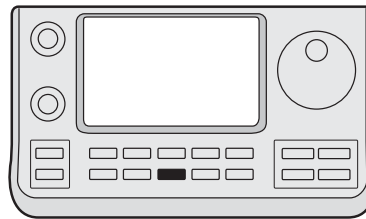

P.AMP(ATT)

✓ About the “P.AMP2” preamplifier

Preamp 2 is a high gain receive amplifier. When it is used in the presence of strong electromagnetic fields, distortion sometimes results. In such cases, use either the “P.AMP1” or “P.AMP OFF” setting.

Preamp 2 is most effective when:

- Used on bands above 24 MHz and when signals are weak.
- Receive sensitivity is insufficient when using low-gain antennas, or while using a narrow band antenna (such as small loop, a Beverage antenna or a short Yagi antenna).

◇ Attenuator

The attenuator prevents a desired signal from being distorted when very strong signals are near the signal's frequency, or when very strong electromagnetic fields, such as from broadcast stations are near your location. These can both be independently set for each band.

- ➔ Hold down **P.AMP(ATT)**(C) for 1 second to turn ON the Attenuator.
 - “ATT” appears on the display when the Attenuator is ON.
- ➔ Push **P.AMP(ATT)**(C) to turn it OFF.

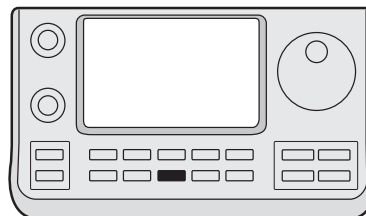

P.AMP(ATT)

About the Preamplifier and Attenuator switching procedure

Push or hold down **P.AMP(ATT)**(C) to switch the Preamplifier and Attenuator, as shown below.

• HF/50 MHz frequency bands

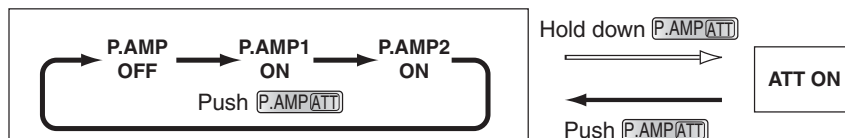

• 144/430 MHz frequency bands

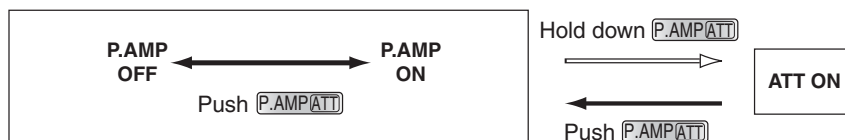

5 FUNCTIONS FOR RECEIVE

AGC function

The AGC (Auto Gain Control) controls receiver gain to produce a constant audio output level, even when the received signal strength greatly varies.

The transceiver has 3 pre-set AGC time constants: fast, mid and slow for SSB, CW, RTTY and AM modes.

In the FM, WFM and DV modes, the AGC time constant is fixed as "FAST" (0.1 second).

AGC speed selection

- ① On the Mode selection screen, select either the SSB, CW, RTTY or AM mode. (p.3-??)
- ② Push **MENU**(C) one or more times to select the "M-2" screen (M-2 menu).
- ③ Touch **[AGC]**(D) to select AGC-F (FAST), AGC-M (MID) or AGC-S (SLOW).

"AGC OFF" appears when the selected AGC speed's time constant is set to OFF.

Setting the AGC time constant

- ① On the Mode selection screen, select either the SSB, CW, RTTY or AM mode. (p.3-??)
- ② Push **MENU**(C) one or more times to select the "M-2" screen (M-2 menu).
- ③ Touch **[AGC]**(D) for 1 second to display the "AGC" screen.
- ④ Touch either **[FAST]**, **[MID]** or **[SLOW]**(D) to select the desired AGC speed to be set.
 - The selected AGC speed's time constant is highlighted.
- ⑤ Rotate the Dial to set the selected time constant.
 - AGC time constant can be set to between 0.1 to 8.0 seconds, (depending on the mode) or turned OFF.
 - If desired, touch **[DEF]**(D) for 1 second to reset to the default setting for the selected time constant.
- ⑥ If desired, select another mode (any other than FM, WFM or DV), then repeat steps ③ and ④.
- ⑦ Push **MENU**(C) to exit the "AGC" screen.

Selectable AGC time constant (unit: seconds)

Mode	Default	Selectable AGC time constant
SSB	0.3 (FAST)	OFF, 0.1, 0.2, 0.3, 0.5, 0.8, 1.2, 1.6, 2.0, 2.5, 3.0, 4.0, 5.0, 6.0
	2.0 (MID)	
	6.0 (SLOW)	
CW/RTTY	0.1 (FAST)	OFF, 0.1, 0.2, 0.3, 0.5, 0.8, 1.2, 1.6, 2.0, 2.5, 3.0, 4.0, 5.0, 6.0
	0.5 (MID)	
	1.2 (SLOW)	
AM	3.0 (FAST)	OFF, 0.3, 0.5, 0.8, 1.2, 1.6, 2.0, 2.5, 3.0, 4.0, 5.0, 6.0, 7.0, 8.0
	5.0 (MID)	
	7.0 (SLOW)	
FM/WFM/DV	0.1 (FAST)	Fixed

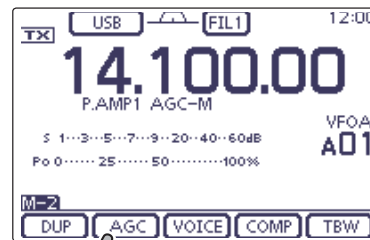
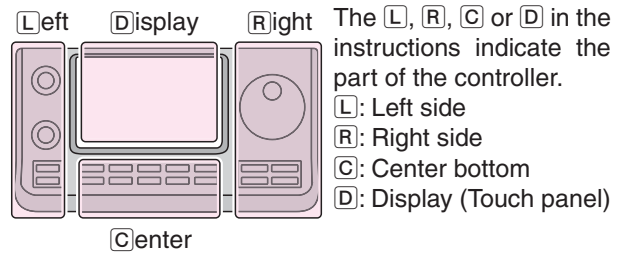

Touch **[AGC]** for 1 second

When AGC-M (MID) is selected



Selected mode

Selected AGC speed's time constant display

When AGC-F (FAST) is selected



When AGC-S (SLOW) is selected

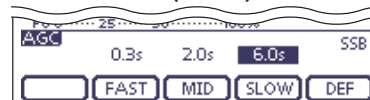

For your information

When you are receiving a weak signal, and a strong signal is momentarily received, the AGC function quickly reduces the receiver gain. When that signal disappears, the transceiver may not receive the weak signal because of the AGC action. In that case, hold down **[AGC]**(D) for 1 second, and rotate the Dial to set the time constant to OFF.

5 FUNCTIONS FOR RECEIVE

RIT function

The RIT (Receive Increment Tuning) function compensates for slight frequency differences between the two stations.

The function shifts the receive frequency up to ± 9.99 kHz in 10 Hz steps*, without changing the transmit frequency.

*The [M-CH] (L) control tunes in 1 Hz steps when the operating frequency readout is set to the 1 Hz step readout.

- ① Push **RIT** (L) to turn ON the RIT function.
 - “RIT” and the frequency shift appear when this function is ON.
- ② Rotate the [M-CH] (L) control.
 - When the [M-CH] (L) control acts as the RIT control, the RIT LED lights orange.
 - If the RIT LED is OFF, push the [M-CH] (L) switch one or more times to turn it ON.
 - Pushing the [M-CH] (L) switch to select the action of the [M-CH/BANK] (L) controls as the Memory/Bank selection, PBT control or RIT control.
 - When the [M-CH/BANK] (L) controls act as the PBT control, the PBT LED lights green.
 - When the [M-CH/BANK] (L) controls act as the RIT control, the RIT LED lights orange. (The RIT control is the inner control. The outer control is disabled.)
 - When the [M-CH/BANK] (L) controls act as the Memory/Bank selection, both LEDs are OFF.
 - Hold down [CLR] (L) for 1 second to reset the RIT frequency.
 - Hold down **RIT** (L) for 1 second to add the frequency shift to the operating frequency.
- ③ To cancel the RIT function, push **RIT** (L) again.
 - “RIT” and the frequency shift disappear.

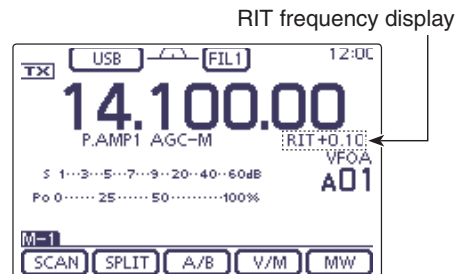
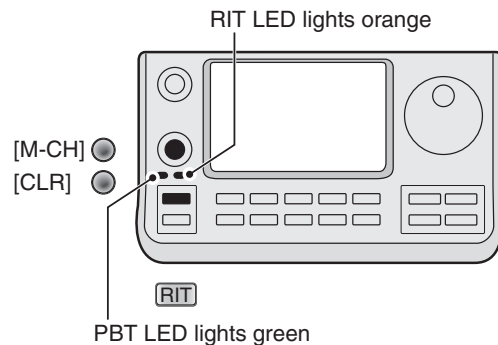
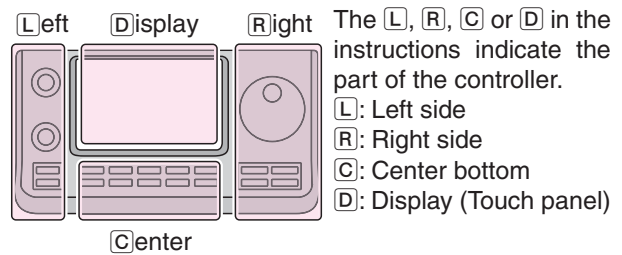

5 FUNCTIONS FOR RECEIVE

Twin PBT operation

(Mode: SSB/CW/RTTY/AM)

To reject interference, PBT (Passband Tuning) electronically narrows the IF passband width by shifting the IF frequency slightly outside of the IF filter passband. The IC-7100 uses DSP for the PBT function. Moving both TWIN-PBT ([M-CH/BANK]Ⓞ(L)) controls shifts the IF passband center frequency both above and below the received frequency.

- ➔ The LCD graphically shows the passband width and frequency shift.
- ➔ Touch the Filter icon for 1 second to display the “FILTER” screen. The current passband width and frequency shift are displayed.
- ➔ Hold down [CLR]Ⓞ(L) for 1 second to set the IF frequency to the center position.
 - The “dots” disappear.

The PBT is adjustable in 50 Hz steps in the SSB/CW/RTTY modes, and 200 Hz in the AM mode.

When adjusting, the shift value changes in 25 Hz steps in the SSB/CW/RTTY modes, and 100 Hz in the AM mode.

- The TWIN-PBT controls should normally be set to the center positions when there is no interference. The PBT setting should be cleared.
- When the PBT is used, the audio tone may change.
- The controls do not function in the FM, WFM and DV modes.
- While rotating the TWIN-PBT ([M-CH/BANK]Ⓞ(L)) controls, noise may occur. This comes from the DSP unit and does not indicate an equipment malfunction.
- Pushing [M-CH]Ⓞ(L) displays the filter passband width and shift value for 1 second.

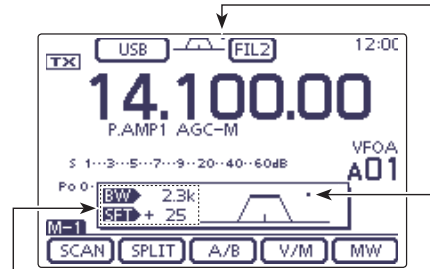

Passband width and shift value are displayed while the TWIN PBT is used. Appear when passband is shifted.

• “FILTER” screen display

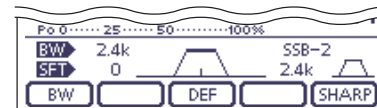

Shows the selected filter and passband width.

• While adjusting the PBT setting

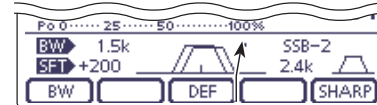

A dot appears when the passband is shifted.

• About Passband width and Shift value on the screen

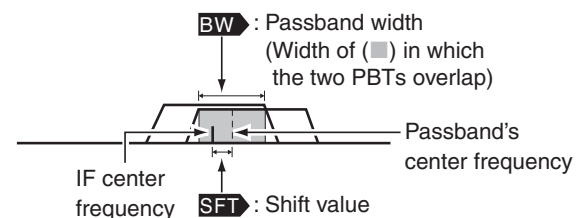

PBT OPERATION EXAMPLE

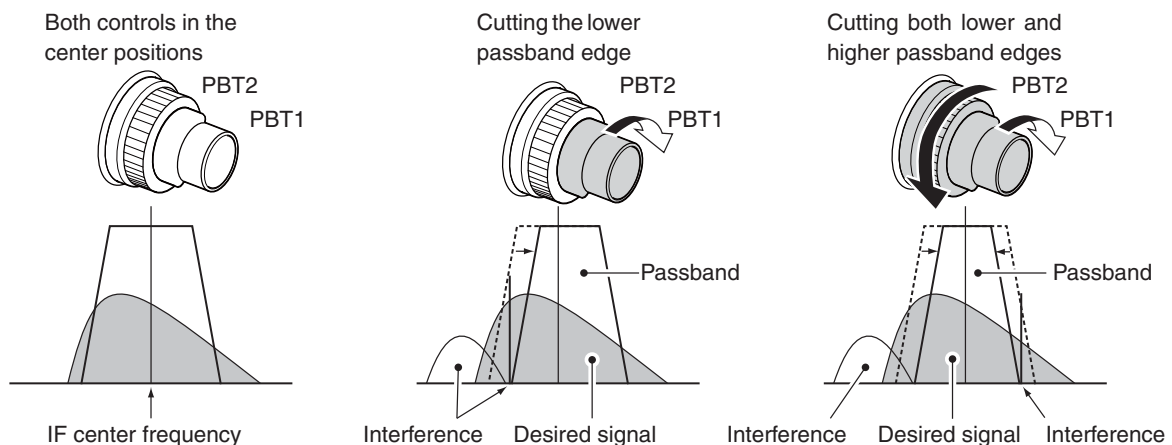

5 FUNCTIONS FOR RECEIVE

IF filter selection

The transceiver has 3 passband width IF filters for each mode.

- ▨ The filter selection is automatically memorized in each mode.
- ▨ The PBT shift frequencies are automatically memorized in each filter.

◆ IF filter selection

- ① On the Mode selection screen, select the desired mode. (p. 3-??)
- ② Touch the Filter icon one or more times to select IF filter 1, 2 or 3.
 - The selected passband width and filter number is displayed as the Filter icon.

◆ Filter passband width setting (Mode: SSB/CW/RTTY/AM)

- ① On the Mode selection screen, select the desired mode. (p.3-??)
 - Passband widths for FM, WFM and DV modes are fixed, and cannot be adjusted.
- ② Touch the Filter icon for 1 second to display the “FILTER” screen to adjust the filter passband width.
- ③ Touch the Filter icon one or more times to select IF filter 1, 2 or 3.
- ④ Touch [BW](D), then rotate the Dial to adjust the desired passband width. Then touch [BW](D) to set it.
 - If desired, touch [DEF](D) for 1 second to reset to the default setting.
- ⑤ If desired, select another mode (any other than the FM, WFM or DV), then repeat steps ② and ④.
- ⑥ Push [MENU](C) to exit the “FILTER” screen.

Mode	IF filter	Adjustable range (steps)
SSB	FILTER1 (3.0 kHz)	50 to 500 Hz (50 Hz) 600 Hz to 3.6 kHz (100 Hz)
	FILTER2 (2.4 kHz)	
	FILTER3 (1.8 kHz)	
SSB-D CW	FILTER1 (1.2 kHz)	50 to 500 Hz (50 Hz) 600 to 3600 Hz (100 Hz)
	FILTER2 (500 Hz)	
	FILTER3 (250 Hz)	
RTTY	FILTER1 (2.4 kHz)	50 to 500 Hz (50 Hz) 600 to 2700 Hz (100 Hz)
	FILTER2 (500 Hz)	
	FILTER3 (250 Hz)	
AM AM-D	FILTER1 (9.0 kHz)	200 Hz to 10 kHz (200 Hz)
	FILTER2 (6.0 kHz)	
	FILTER3 (3.0 kHz)	
FM FM-D DV	FILTER1 (15 kHz)	Fixed
	FILTER2 (10 kHz)	
	FILTER3 (7.0 kHz)	
WFM	FILTER (280 kHz)	Fixed

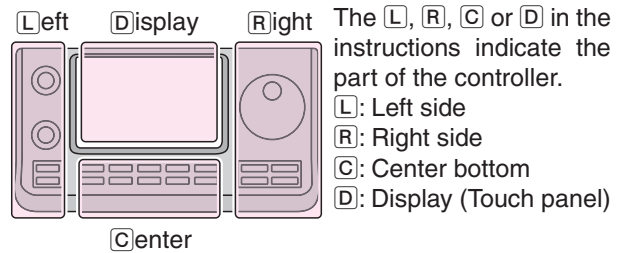

When FILTER2 or FILTER3 is selected in the FM mode, the TX modulation changes to the narrow FM mode (2.5 kHz).

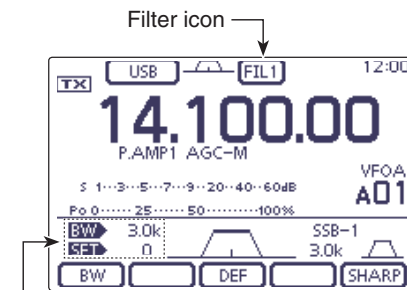

Passband width and shift value

• “FILTER” screen display

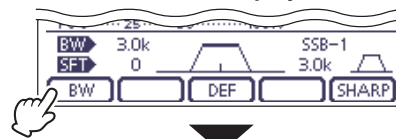

• While adjusting the passband width

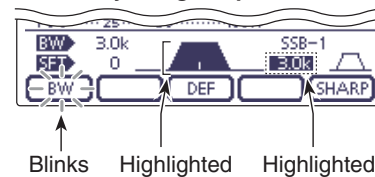

Rotate the Dial to adjust the passband width, and then touch [BW]

▨ The PBT shift frequencies are cleared when the passband width is changed.

▨ This “FIL” screen (Filter) graphically displays the PBT shift frequencies and passband width.

5 FUNCTIONS FOR RECEIVE

IF (DSP) filter shape

(Mode: SSB/CW)

A soft or sharp type of DSP filter shape for both SSB and CW can be independently selected.

- ① On the Mode selection screen, select the SSB or CW mode. (p. 3-??)
- ② Touch the Filter icon for 1 second to display the “FILTER” screen.
- ③ Touch [SHARP] or [SOFT](D) to select either the soft or sharp filter shape.
- ④ Push **MENU**(C) to exit the “FILTER” screen.

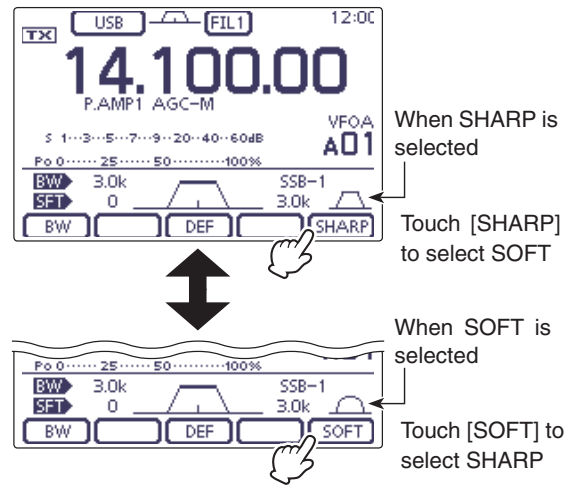
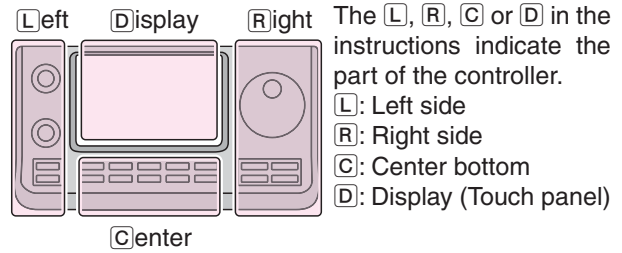

5 FUNCTIONS FOR RECEIVE

Noise Blanker

(Mode: SSB/CW/RTTY/AM)

The Noise Blanker eliminates pulse-type noise such as noise from car ignitions.

- ➔ Push **[NB]**(**D**) to turn the Noise Blanker function ON or OFF.
 - “NB” is displayed when the Noise Blanker is ON.

When using the Noise Blanker function, received signals may be distorted if they are excessively strong or when the function is used for noise other than pulses. In this case, set the Noise Blanker threshold level to a shallow position, or turn OFF the function. (See below.)

The **[L]**, **[R]**, **[C]** or **[D]** in the instructions indicate the part of the controller.

- [L]**: Left side, **[R]**: Right side, **[C]**: Center bottom
- [D]**: Display (Touch panel)

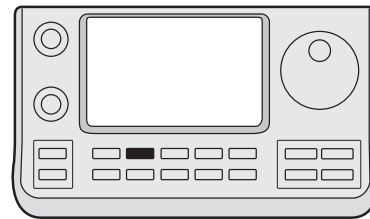

[NB]

NB icon

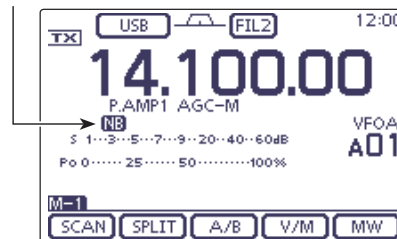

◇ NB Set mode

To deal with various types of noise, the attenuation level and noise blanking duration can be set in the NB set mode.

- ① Hold down **[NB]**(**C**) for 1 second to display the “NB” screen (Noise blanker).
- ② Touch **[▲]** or **[▼]**(**D**) to select the desired item.
- ③ Rotate the Dial to select the desired option.
 - If desired, touch **[DEF]**(**D**) for 1 second to reset to the default setting.
- ④ Push **[NB]**(**C**) to return to the previous screen.

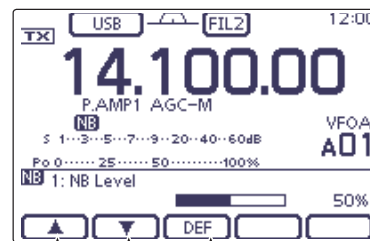

Select the item

Touch for 1 second to reset to default

1. NB Level (Default: 50%)

Set the noise blanker threshold level to between 0% and 100%.

2. NB Depth (Default: 8)

Set the noise attenuation level to between 1 and 10.

3. NB Width (Default: 50)

Set the blanking duration to between 1 and 100.

5 FUNCTIONS FOR RECEIVE

Noise Reduction

The Noise Reduction function reduces random noise components and enhances audio signals which are buried in noise. The received signals are converted to digital signals and then the audio signals are separated from the noise.

- ① Push **NR**(**C**) to turn ON the Noise Reduction.
 - “NR” appears.
- ② Hold down **NR**(**C**) for 1 second to display the “NR” screen (Noise Reduction).
- ③ Rotate the Dial to adjust the Noise Reduction level; rotate it clockwise to increase reduction level or counterclockwise to decrease reduction level.
 - If desired, touch [DEF](**D**) for 1 second to reset to the default setting.
 - The adjustable reduction level is between 1 and 15.
- ④ Push **NR**(**C**) to exit the “NR” screen (Noise Reduction).
 - If desired, push **NR**(**C**) to turn OFF the Noise Reduction.

/// A large rotation of the “NR control” results in audio signal masking or distortion. Set the “NR control” for maximum readability.

Noise reduction OFF

Noise components

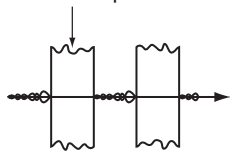

Noise reduction ON

Desired signal (CW)

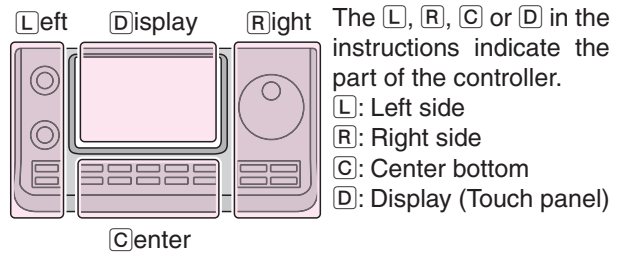
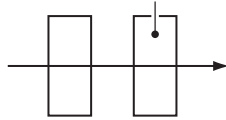

The **L**, **R**, **C** or **D** in the instructions indicate the part of the controller.

- L**: Left side
- R**: Right side
- C**: Center bottom
- D**: Display (Touch panel)

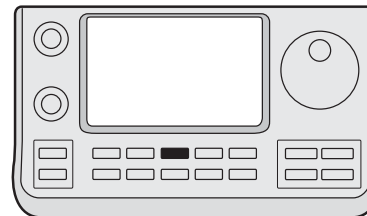

NR

NR icon

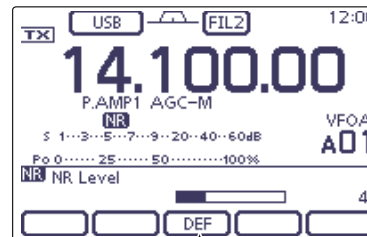
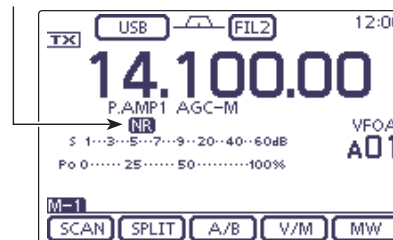

Touch for 1 second to reset to default

5 FUNCTIONS FOR RECEIVE

Notch function

**(Mode = Auto notch: SSB/AM/FM
Manual notch:SSB/CW/RTTY/AM)**

This transceiver has Auto and Manual Notch functions.

- ➔ In the SSB or AM mode, push **[NOTCH]**(C) to toggle the Notch function between auto, manual and OFF.
 - Either the Auto or Manual notch function can be turned OFF in the “[NOTCH] switch (SSB)” or “[NOTCH] switch (AM)” item of the “Function” Set mode. (p. 165)
 - [SET]**(C) > Function > **[NOTCH] switch (SSB)**
 - [SET]**(C) > Function > **[NOTCH] switch (AM)**
- ➔ In the CW or RTTY mode, push **[NOTCH]**(C) to turn the Manual Notch function ON or OFF.
- ➔ In the FM mode, push **[NOTCH]**(C) to turn the Auto Notch function ON or OFF.
 - “AN” appears when the Auto Notch function is ON.
 - “MN” appears when the Manual Notch function is ON.
 - No indicator appears when the notch filter is OFF.

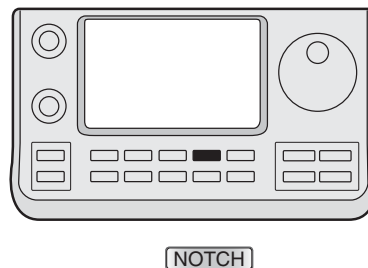
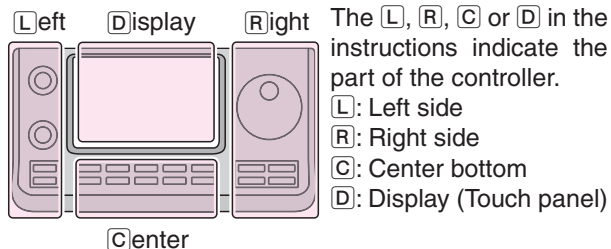

◇ Auto Notch function

The Auto Notch function uses DSP to automatically attenuate beat tones, tuning signals, and so on, even if their frequencies are changing.

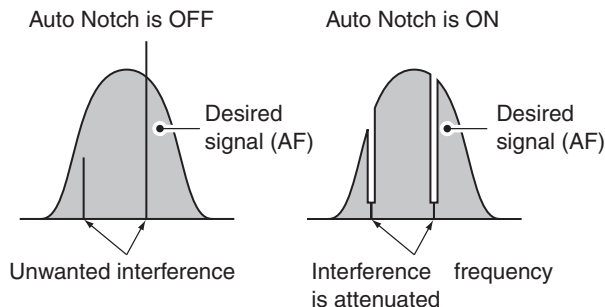

Auto Notch icon

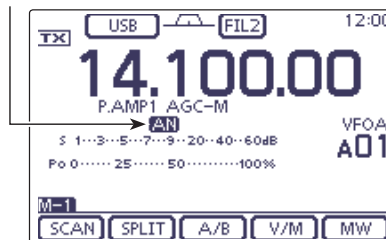

5 FUNCTIONS FOR RECEIVE

Notch function (Continued)

Manual Notch function

(Mode = Manual notch: SSB/CW/RTTY/AM)

The Manual Notch function allows you to manually attenuate a frequency using the 'NOTCH control.'

- ① Push **[NOTCH]**(C) once or twice to turn ON the Manual Notch function.
 - "MN" appears.
- ② Hold down **[NOTCH]**(C) for 1 second to display the "NOTCH" screen.
 - Touch **[WIDTH]**(D) to select the Manual Notch filter width, "WIDE," "MID" or "NAR."
- ③ Rotate the Dial to adjust the Notch filter frequency.
 - Since the Notch filter has the very sharp characteristic, slowly rotate the Dial when adjusting a filter.
 - If desired, push **[NOTCH]**(C) to exit the "NOTCH" screen.

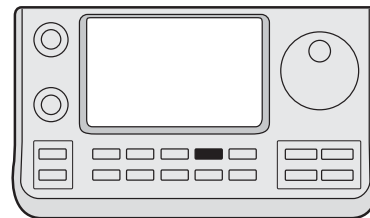
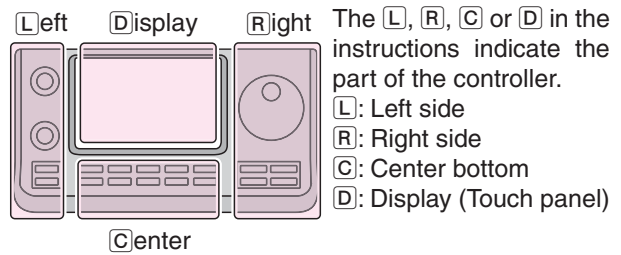

NOTCH

Mode	Center frequency
SSB RTTY	-1040 Hz to +4040 Hz
CW	CW pitch frequency -2540Hz to CW pitch frequency +2540Hz
AM	-5060 Hz to +5100 Hz

Manual Notch icon

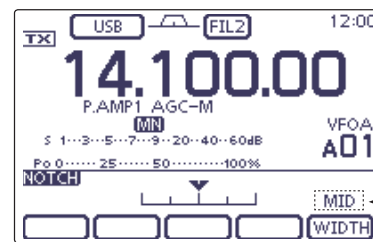
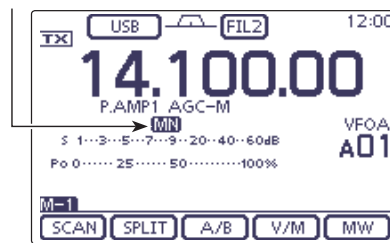

Manual Notch filter width

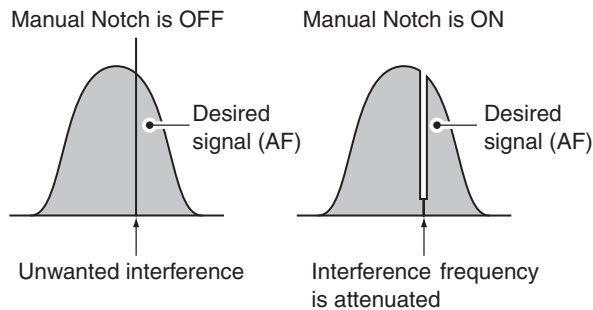

While tuning the manual notch filter, noise may be heard. This comes from the DSP unit and does not indicate an equipment malfunction.

5 FUNCTIONS FOR RECEIVE

Lock function

The IC-7100 has two kinds of lock functions; Dial Lock and Panel Lock. The Dial Lock function locks only the Dial, and Panel Lock function locks controller operation.

The Dial Lock function prevents frequency changes by accidental movement of the Dial by electronically locking it. To prevent accidental frequency changes and unnecessary function access, use the Panel Lock function.

- ➔ Hold down **[SPEECH/LOCK]**(R) to turn the Lock function ON or OFF.
 - “**[LOCK]**” appears when the function is ON.

NOTE: When the “[SPEECH/LOCK] Switch” item of the “Function” Set mode is set to “LOCK/SPEECH,” pushing **[SPEECH/LOCK]** turns ON the Dial Lock function. (p. 164)

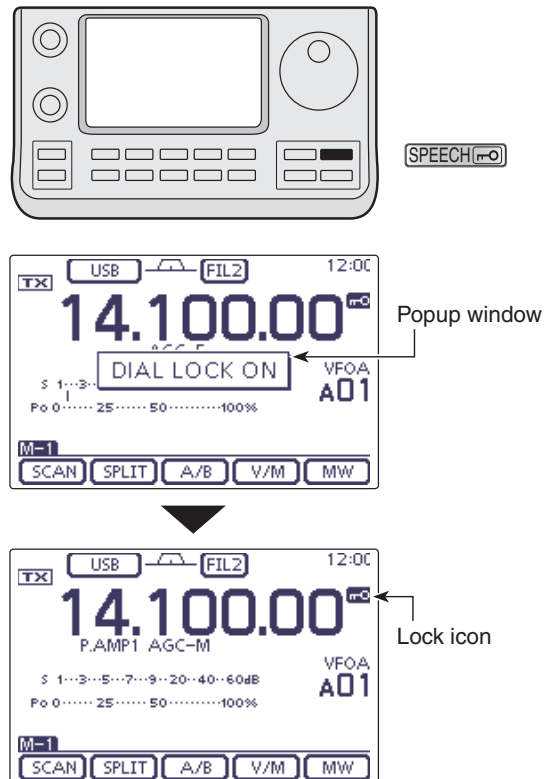
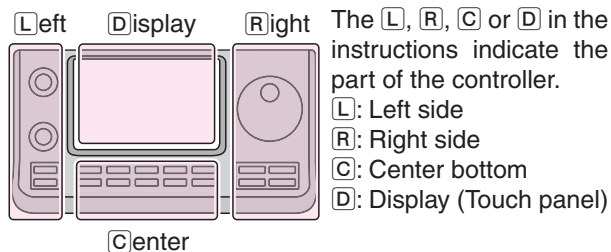

◆ Selecting the Lock type

The Lock function is set to MAIN DIAL by default. The setting can be changed to PANEL in the “Lock Function” item of the “Function” Set mode. (p. 165)

- ① Push **[SET]**(C) to enter the Set mode.
- ② Touch the “Lock Function” item of the “Function” Set mode.
 - Function > **Lock Function**
 - If the specified item is not displayed, touch **[▲]** or **[▼]**(D) one or more times to select the page.
- ③ Touch the desired option to set the Lock type.
 - MAIN DIAL: Locks only the Dial operation.
 - PANEL: Locks the Dial, controls and keys.
[SPEECH/LOCK](R), **[PWR/AF]**(L) and **[RF/SQL]**(L) can be used while in the Panel Lock function is ON.
- ④ Push **[SET]**(C) to exit the Set mode.

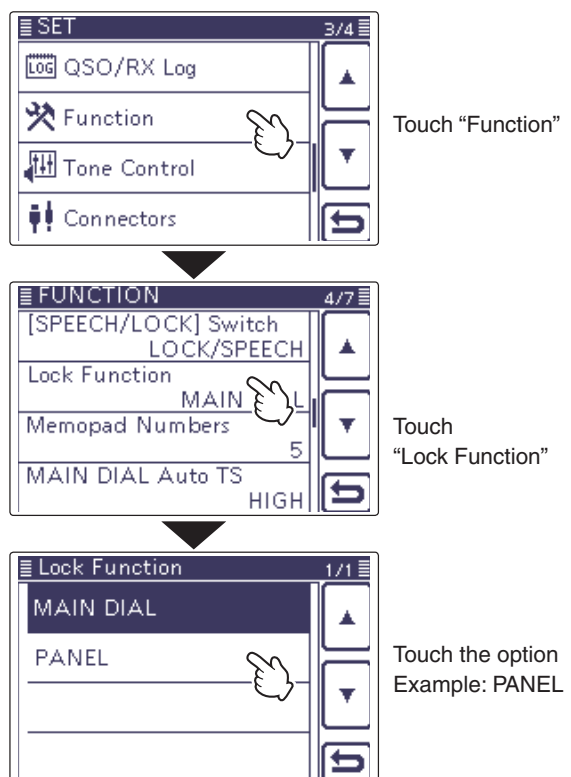

5 FUNCTIONS FOR RECEIVE

Meter peak hold function

The Meter Peak hold function is set to ON by default, the peak level of a received signal strength or the output power is displayed for approximately 0.5 seconds. The function can be turned OFF in the “Meter Peak Hold” item of the “Display” Set mode. (p. 165)

- ① Push **SET**(**C**) to enter the Set mode.
- ② Touch the “Meter Peak Hold” item of the “Display” Set mode.
Set mode.
- Display > **Meter Peak Hold**
 - If the specified item is not displayed, touch **[▲]** or **[▼]**(**D**) one or more times to select the page.
- ③ Touch the desired option to turn ON or OFF the Meter Peak Hold function.
- ④ Push **SET**(**C**) to exit the Set mode.

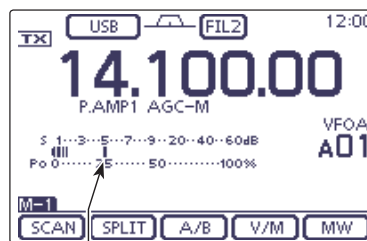
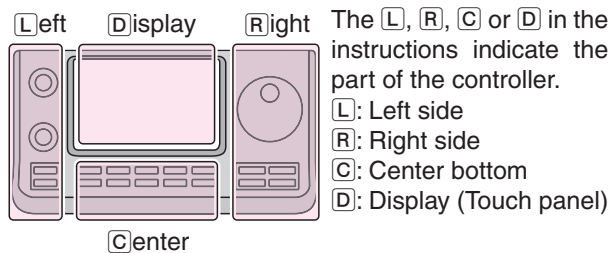

Appears for 0.5 seconds.

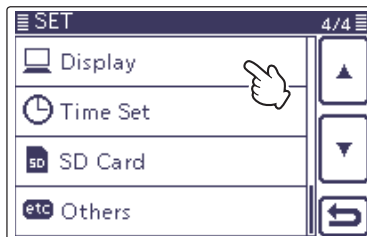
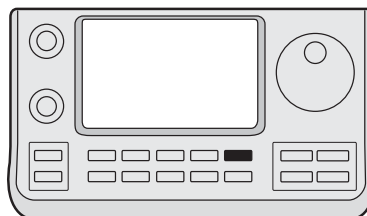

Touch “Display”

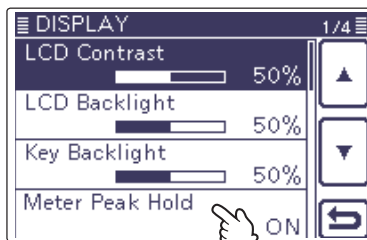

Touch “Meter Peak Hold”

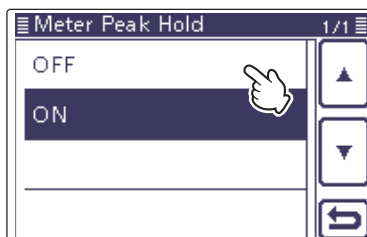

Touch the option
 Example: OFF

5 FUNCTIONS FOR RECEIVE

Simple Band Scope

The Band Scope function allows you to visually check the location and strength of signals around a specified frequency.

The IC-7100's Band Scope function can be used in any operating mode and any frequency band.

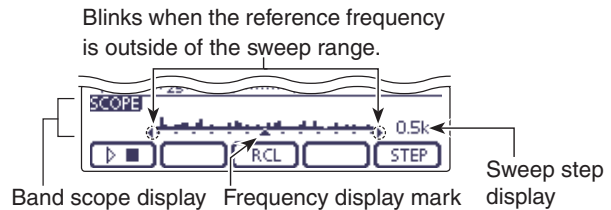

INDICATOR	DESCRIPTION
Sweep icon	While the band scope is sweeping, "▶□" is displayed; while stopped, "▶■" is displayed. Received audio is not heard from the speaker while the band scope is sweeping.
Band scope display	Displays the signal location and strength in relation to the center (displayed) frequency. Signal strength is relative to the S-meter level, S1 to S9+30 dB, with each vertical dot in the band scope indicators 1 to 15 dots. Between +30 dB to +60 dB are also displayed by 15 dots. Signal activity is measured ±30 steps from the center frequency, with each step equal to the selected sweep step.
Frequency display mark	After a sweep, displays the relative position of the reference frequency. When the reference frequency is outside of the sweep range, "⦿" or "⦿" blinks. After changing the frequency, touch [RCL](D) for 1 second to automatically return to the center frequency.
Sweep step display	Displays the selected sweep step. Steps of 0.5, 1, 2, 5, 10, 20 and 25 kHz are selectable. Each dot of the band scope display is equal to the selected sweep step.

The band scope displays the receive signal location and strength over a specified range on either side of a selected frequency, in either the VFO or memory modes.

- ① Rotate the Dial to select a frequency.
- ② Push [MENU](C) one or more times to select the "M-3" screen (M-3 menu).
- ③ Touch [SCOPE](D) for 1 second to display the "SCOPE" screen (Band Scope).
 - Automatically starts sweeping with the previously selected sweeping step.
 - During a sweep, received signals cannot be heard.
- ④ Touch [STEP](D) one or more times to select the desired sweep step.
 - 0.5, 1, 2, 5, 10, 20 and 25 kHz are selectable.
- ⑤ Touch [▶■](D) to start sweeping, then automatically stop after sweeping.
 - Touch [▶■](D) for 1 second to start continuous sweeping. In this case, touch [▶□](D) to stop the sweeping.
 - During a sweep, "▶□" is displayed but received signals cannot be heard.
 - If there is a lot of signal noise, turn OFF the Preamp to reduce the signal input level, and, if necessary, turn ON the Attenuator to improve the readability of the band scope.
- ⑥ Rotate the Dial to find a signal that you wish to communicate with. If you find the signal, communicate in the normal way.
 - If you want to return to the frequency you were using before rotating the Dial, touch [RCL](D) for 1 second.
 - If the selected frequency is set outside of the sweep range, "⦿" or "⦿" blinks.
- ⑦ If you want to update the band conditions while receiving, repeat steps ④ and ⑤.

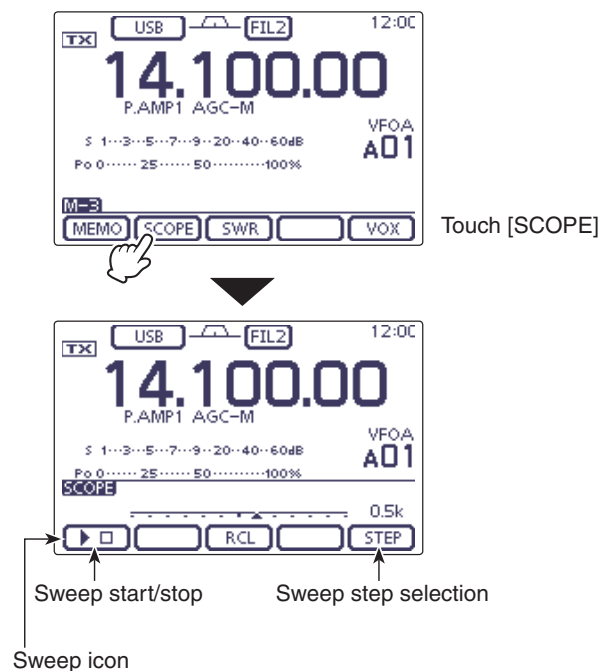

NOTE:
If you select a large sweep step, a wide frequency range can be displayed on the band scope, but some signals may be skipped and not displayed.

Section 6

FUNCTIONS FOR TRANSMIT

- VOX function 6-2**
 - ◇ Using the VOX function 6-2
 - ◇ Adjusting the VOX function 6-2
- Break-in function 6-3**
 - ◇ Semi Break-in operation 6-3
 - ◇ Full Break-in operation 6-4
- Speech compressor function 6-5**
- Transmit filter width selection 6-6**
- Monitor function 6-7**
- Split frequency operation 6-8**
 - ◇ Direct frequency shift input 6-9
 - ◇ Split Lock function 6-10
- Quick Split function 6-11**
 - ◇ Split frequency offset setting 6-12
- Measuring SWR 6-13**
 - ◇ Spot measurement 6-13
 - ◇ Plot measurement 6-14
 - ◇ SWR Graph Set mode 6-16
- DTMF Memory encoder 6-17**
 - ◇ Programming a DTMF code 6-17
 - ◇ Transmitting DTMF code 6-18
 - ◇ Transmitting DTMF code (Direct Input) 6-19
 - ◇ Setting DTMF transfer speed 6-20

6 FUNCTIONS FOR TRANSMIT

VOX function

(Mode: SSB/AM/FM/DV)

The VOX (Voice-Operated Transmission) function switches the transceiver between transmit and receive with your voice. This function provides hands-free operation.

◇ Using the VOX function

- ① Select the desired frequency band. (p. 35)
- ② On the Mode selection screen, select either the SSB, AM, FM or DV mode. (p.3-??)
- ③ Push **[MENU]**(C) one or more times to select the “M-3” screen (M-3 menu).
- ④ Touch **[VOX]**(D) to turn ON the VOX function.
 - “VOX” appears.

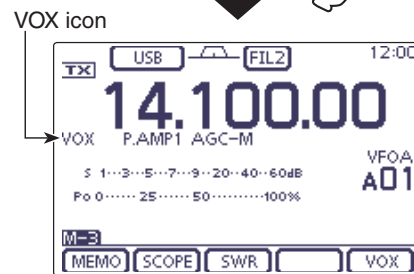
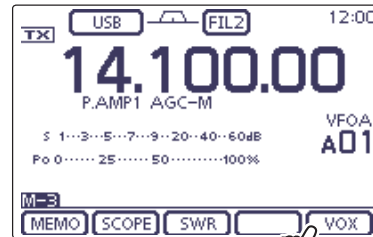
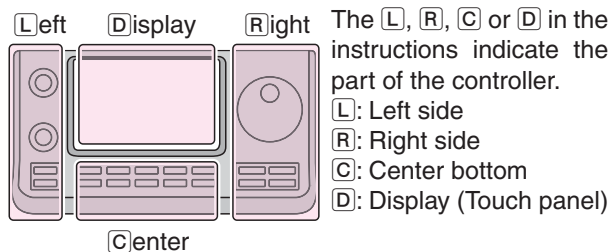

◇ Adjusting the VOX function

- ① On the Mode selection screen, select either the SSB, AM, FM or DV mode. (p.3-??)
- ② Push **[MENU]**(C) one or more times to select the “M-3” screen (M-3 menu).
- ③ Touch **[VOX]**(D) for 1 second to display the “VOX” screen.
- ④ Touch **[▲]** or **[▼]**(D) to select the desired item.
- ⑤ Rotate the Dial to select the desired option.
 - If desired, touch **[DEF]**(D) for 1 second to reset to the default setting.
- ⑥ Push **[MENU]**(C) to exit the “VOX” screen.

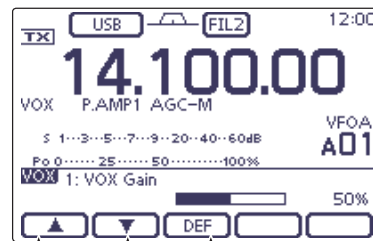

1. VOX Gain (Default: 50%)

Adjust the VOX gain to between 0% and 100%, in 1% steps.
 Higher values make the VOX function more sensitive to your voice.

2. Anti-VOX (Default: 50%)

Adjust the ANTI-VOX gain to between 0% and 100%, in 1% steps.
 Higher values make the VOX function less sensitive to the received audio from a speaker or headphones.

3. VOX Delay (Default: 0.2sec)

Set the VOX delay to between 0.0 and 2.0 seconds, for normal pauses in speech before returning to receive.

6 FUNCTIONS FOR TRANSMIT

Break-in function

(Mode: CW)

The Break-in function is used in the CW mode to automatically toggle the transceiver between transmit and receive when keying. The IC-7100 is capable of Full Break-in or Semi Break-in.

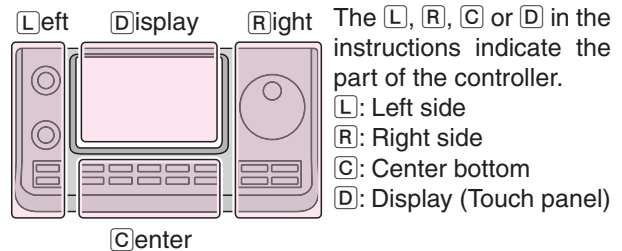

◆ **Semi Break-in operation**

During Semi Break-in operation, the transceiver immediately transmits when you key down, then returns to receive after a preset delay time has passed after you stop keying.

- ① Select the desired frequency band. (p. 3-5)
- ② On the Mode selection screen, select the CW or CW-R mode. (p.3-??)
- ③ Push **MENU**(C) one or more times to select the “M-3” screen (M-3 menu).
- ④ Touch **[BK-IN]**(D) one or more times to turn ON the Semi Break-in function.
 - “BKIN” appears.
- ⑤ When the “M-3” screen (M-3 menu) is selected, touch **[BK-IN]**(D) for 1 second to display the “BK-IN” screen.
- ⑥ Touch **[▲]** or **[▼]**(D) to select the desired item.
- ⑦ Rotate the Dial to select the desired option.
 - If desired, touch **[DEF]**(D) for 1 second to reset to the default setting.
- ⑧ Push **MENU**(C) to exit the “BK-IN” screen.

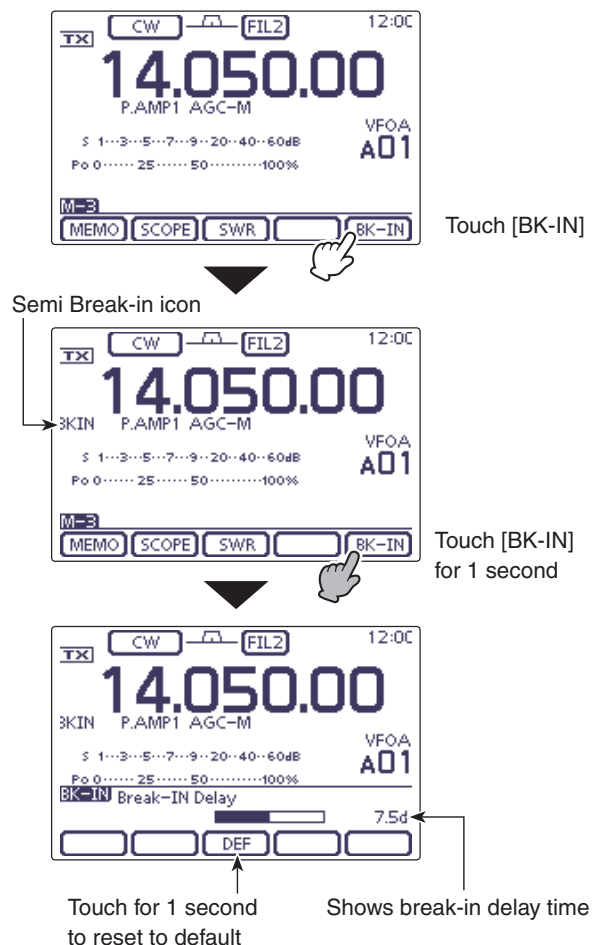

6 FUNCTIONS FOR TRANSMIT

Break-in function (Continued)

◇ Full Break-in operation

During Full Break-in operation, the transceiver transmits when you key down, then immediately returns to receive when you release.

- ① On the Mode selection screen, select the CW or CW-R mode. (p.3-??)
- ② Push **[MENU]**(C) one or more times to select the "M-3" screen (M-3 menu).
- ③ Touch **[BK-IN]**(D) one or more times to turn ON the Full Break-in function.
 - "F-BKIN" appears.

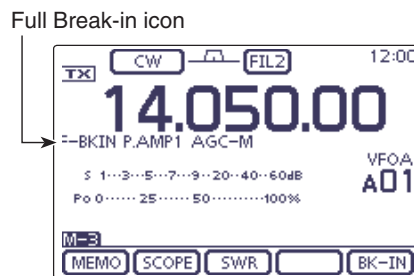
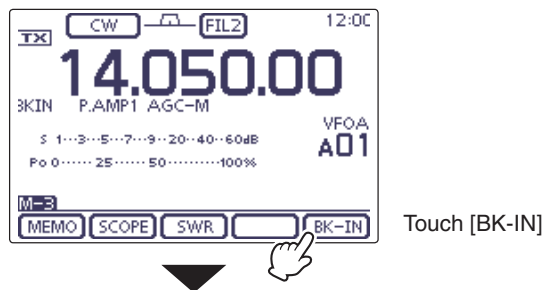
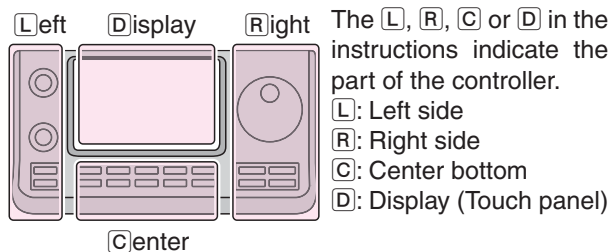

When using a paddle:

Adjust the keying speed while operating a paddle.

- ① Push **[SPEED/PITCH]**(C) to open the Key speed/CW pitch adjustment window.



- ② Rotate **[M-CH]**(L) to adjust the Key speed.
 - The adjustable key speed is between 6 and 48 wpm (words per minute).
- ③ Push **[MENU]**(C) to close the window.

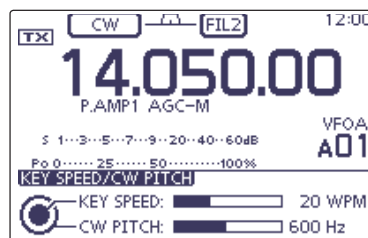
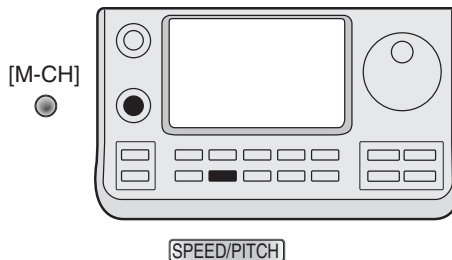

6 FUNCTIONS FOR TRANSMIT

Speech compressor function

(Mode: SSB)

The Speech Compressor function increases average RF output power, improving signal strength and readability.

- ① Select the desired frequency band. (p. 3-5)
- ② On the Mode selection screen, select the USB or LSB mode. (p.3-??)
- ③ Before first tuning ON the Speech compressor, adjust the microphone gain so that the ALC meter reading stays within the ALC zone.

- ① Push **[MIC/RF PWR]**(C) to open the MIC gain/RF power adjustment display.

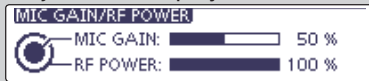

- ② Rotate **[M-CH]** (L) to adjust the MIC gain.
 - To adjust the MIC gain, touch the TX meter to select the ALC meter.
- ③ Push **[MENU]**(C) to close the display.

- ④ Push **[MENU]**(C) one or more times to select the "M-2" screen (M-2 menu).
- ⑤ Touch **[COMP]**(D) to turn ON the Speech Compressor.
 - "COMP" appears.
- ⑥ Touch **[COMP]**(D) for 1 second to display the "COMP" (Compressor) screen.
 - "COMP" appears.
- ⑦ While speaking into the microphone at your normal voice level, rotate the Dial so that the COMP meter reading stays within the COMP level zone (10 dB to 20 dB zone).
 - To adjust the COMP level, touch the TX meter to select the COMP meter.
 - If desired, touch **[DEF]** for 1 second to reset to the default setting.
- ⑧ Push **[MENU]**(C) to exit the "COMP" screen.

When the COMP meter peaks above the COMP level zone, your transmitted voice may be distorted.

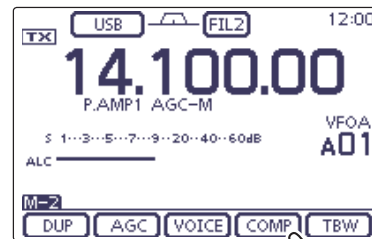
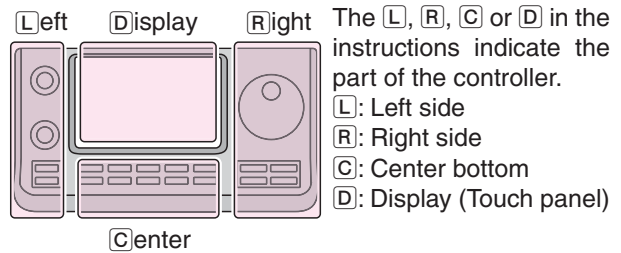

Speech Compressor icon

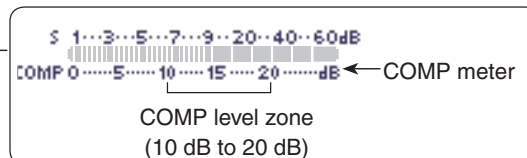
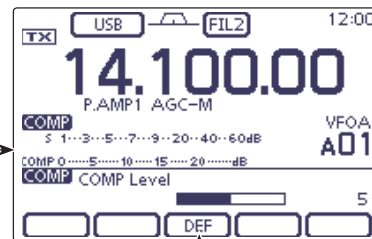
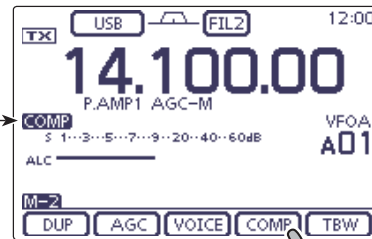

6 FUNCTIONS FOR TRANSMIT

Transmit filter width selection

(Mode: SSB)

The transmit filter width for the SSB mode can be selected from Wide, Mid or Narrow. This setting can be memorized each for the Speech Compressor ON and OFF.

- ① Select the desired frequency band. (p. 3-5)
- ② On the Mode selection screen, select the USB or LSB mode. (p.3-??)
- ③ Push **MENU**(C) one or more times to select the "M-2" screen (M-2 menu).
- ④ Touch **[COMP]**(D) to turn ON the Speech Compressor.
 - "COMP" appears.
- ⑤ Touch **[TBW]**(D) for 1 second one or more times a Wide, Mid or Narrow transmission passband width.
 - Touch **[TBW]**(D) to display the selected TX filter width for approximately 1 second.
 - The following filters are specified as the defaults. Each of the filter widths can be set in the "TBW" items of the "Tone Control" Set mode. (p. 165)

SET(C) > Tone Control > TX > SSB
 > **TBW (WIDE), TBW (MID), TBW (NAR)**

- WIDE: 100 Hz to 2900 Hz
- MID: 300 Hz to 2700 Hz
- NAR: 500 Hz to 2500 Hz

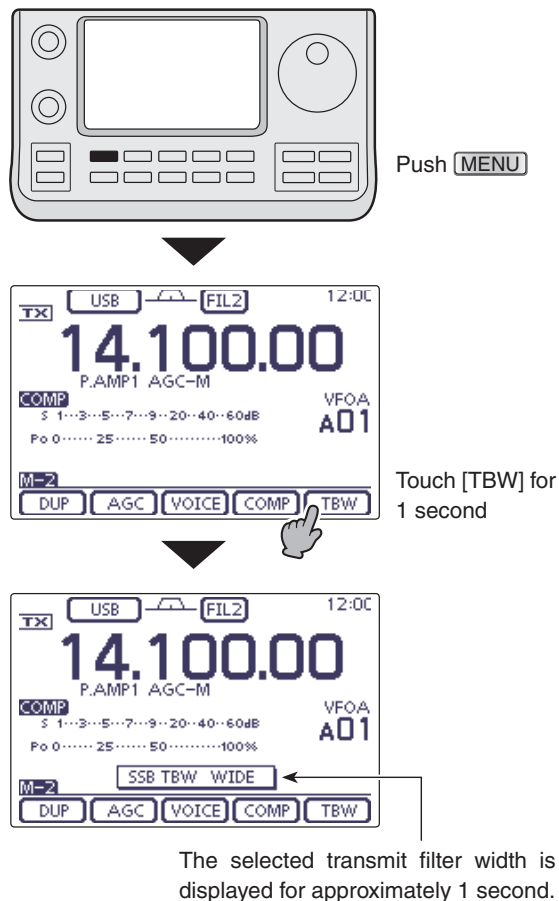
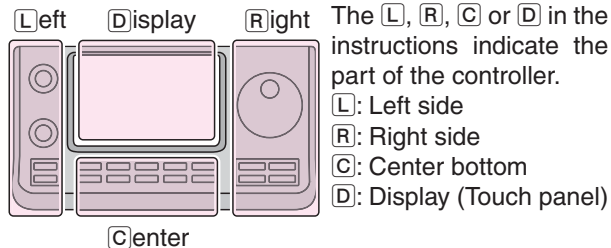

6 FUNCTIONS FOR TRANSMIT

Monitor function

The Monitor function allows you to monitor your transmit IF signals in any mode. Use this to check voice characteristics while adjusting transmit parameters. The CW sidetone functions regardless of the “Monitor” setting.

- ① Push **SET**(**C**) to enter the Set mode.
- ② Touch the “Monitor” item of the “Function” Set mode.
 - Function > **Monitor**
 - If the specified item is not displayed, touch **▲** or **▼**(**D**) one or more times to select the page.
- ③ Touch the option to turn ON the function.
- ④ Touch the “Monitor Level” item of the “Function” Set mode.
 - Function > **Monitor Level**
 - ⑤ Rotate the Dial to adjust the monitor level.
 - For the clearest audio output, adjust while holding down [PTT] and speaking into the microphone.
 - The adjustable monitor level is between 0% (minimum audio level) and 100% (maximum audio level).
 - If desired, touch the level bar for 1 second to open the Default set window, then select “Default” to reset to the default setting.
- ⑥ Push **SET**(**C**) to exit the Set mode.

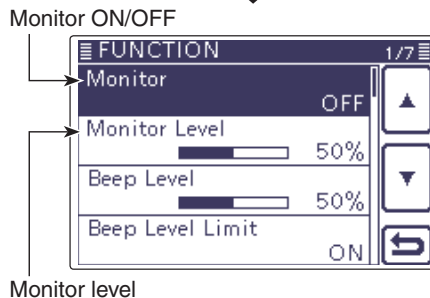
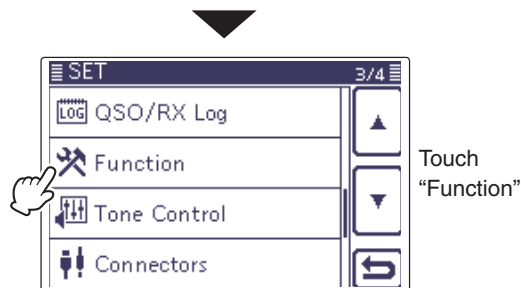
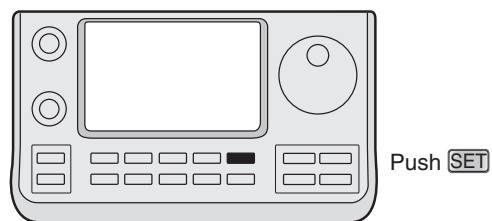

6 FUNCTIONS FOR TRANSMIT

Split frequency operation

Split frequency operation allows you to transmit and receive on two different frequencies. Split frequency operation is performed using frequencies in VFO A and VFO B.

- The Split frequency operation is automatically turned OFF when turning ON the One-touch repeater function.

The following is an example of setting 21.290 MHz/USB mode for receiving and 21.310 MHz/USB mode for transmitting.

- ① Set 21.290 MHz in VFO A and select the USB mode.
- ② Push **MENU**(C) one or more times to select the “M-1” screen (M-1 menu).
- ③ Touch **[SPLIT]**(D) to turn ON the Split function.
 - The transmit frequency (VFO B) and “SPLIT” appear.
 - If desired, tap **[SPLIT]**(D) again to turn OFF the function.
- ④ Set 21.310 MHz in VFO B and select the USB mode. The setting method has the three following ways.
 - (1) While holding down **[XFC]**(R) in VFO A, rotate the Dial to set the transmit frequency to 21.310 MHz in VFO B, and then select the operating mode to USB.
 - While holding down **[XFC]**(R), you can change the frequency band and operating mode in VFO B.
 - While holding down **[XFC]**(R), the transceiver receives the transmit frequency in VFO B.
 - (2) Touch **[A/B]**(D) to select VFO B, rotate the Dial to set the transmit frequency to 21.310 MHz, and then select the operating mode to USB.
 - (3) Use the Quick Split function.
 - The Quick Split function is much more convenient for selecting the transmit frequency. See the next content for details.
- ⑤ Now you can receive on 21.290 MHz and transmit on 21.310 MHz.

To change the transmit and receive frequencies, push **[A/B]** to exchange VFO A and VFO B.

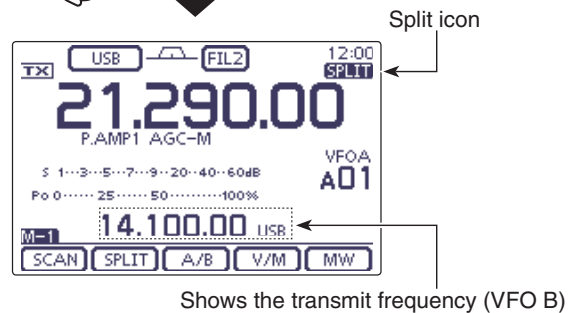
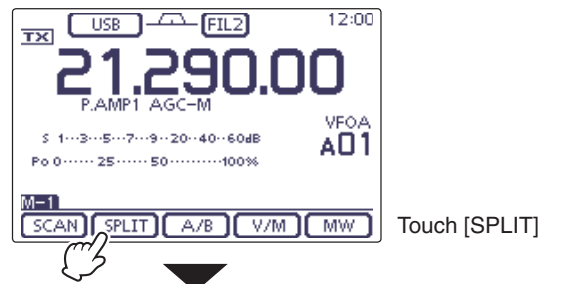
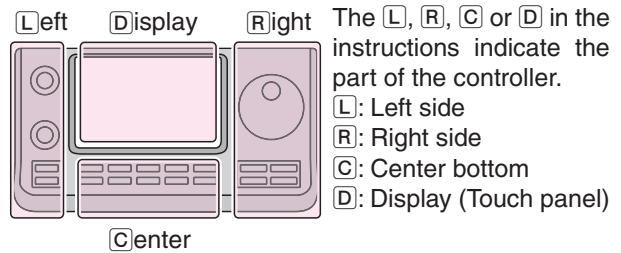

- While holding down **[XFC]**
Shows the transmit frequency (VFO B)

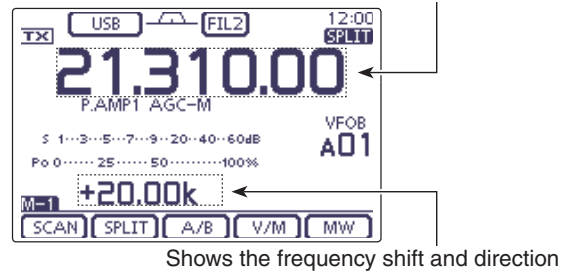

- After setting up

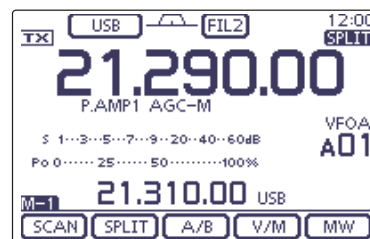

6 FUNCTIONS FOR TRANSMIT

Split frequency operation (Continued)

◆ Direct frequency shift input

The frequency shift can directly be entered.

- ① Touch the MHz digits to enter the Band selection display.
- ② Touch [F-INP](D) to enter the Direct input screen.
- ③ If the Shift direction is minus, touch “• (-).”
 - [SPLIT] changes to [-SPLIT], and displays the Minus setting mode.
- ④ Touch the desired number to enter the desired frequency shift.
- -9.999 to +9.999 MHz can be set in 1 kHz steps.
- ⑤ Touch [SPLIT] or [-SPLIT](D) to input the frequency shift to the transmit frequency, and the Split function is turned ON.

[Example]

To transmit on a 10 kHz higher frequency:

➔ Touch [1], [0] then [SPLIT].

To transmit on 1.025 MHz lower frequency:

➔ Touch [• (-)], [1], [0], [2], [5] then [-SPLIT].

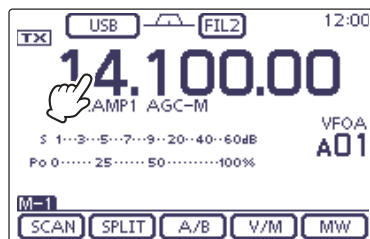
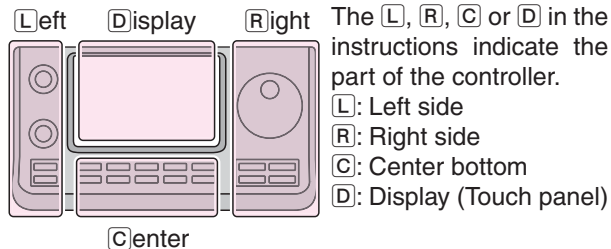

Touch the MHz digits.

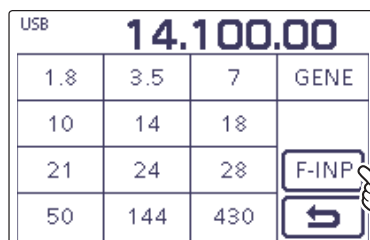

Touch [F-INP]

• Direct input screen

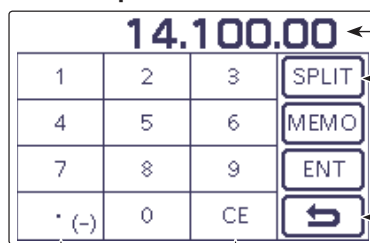

Shows the input digits

Enter the Split off-set

Cancel edit

Minus (-) input

Delete entering

6 FUNCTIONS FOR TRANSMIT

Split frequency operation (Continued)

◇ Split Lock function

The Split Lock function is convenient for changing only the transmit frequency. When the Split Lock function is not used, accidentally releasing **XFC**(R) while rotating the Dial, changes the receive frequency. The Split Lock function is OFF by default, but can be turned ON in the “SPLIT LOCK” item of the “Function” Set mode. (p. 165)

• Setting

- ① Push **SET**(C) to enter the Set mode.
- ② Touch the “SPLIT LOCK” item of the “Function” Set mode.
 - Function > SPLIT/DUP > **SPLIT LOCK**
 - If the specified item is not displayed, touch **▲** or **▼**(D) one or more times to select the page.
- ③ Touch the option to turn ON the function.
- ④ Push **SET**(C) to exit the Set mode.

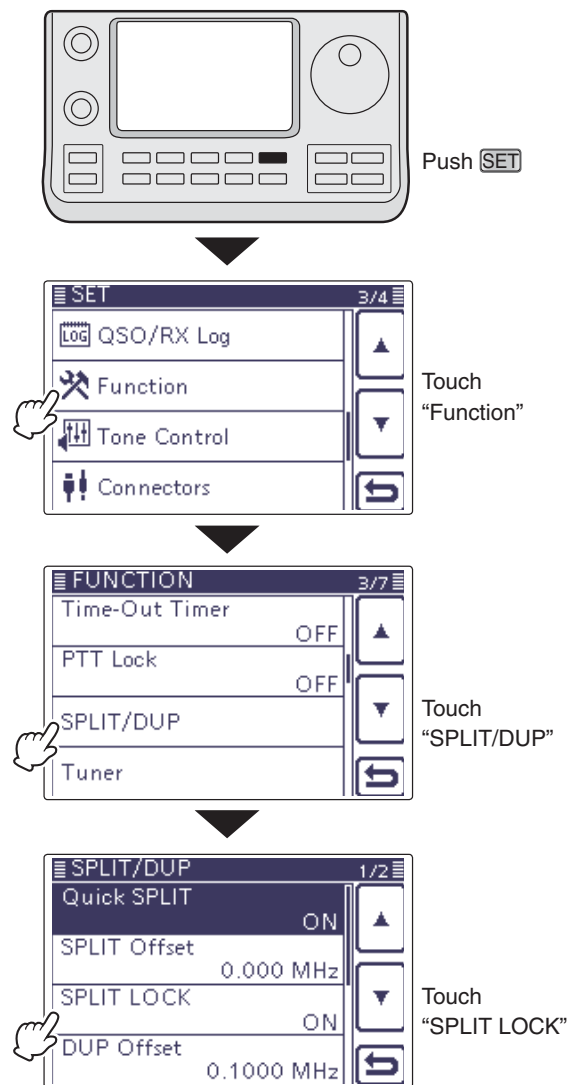
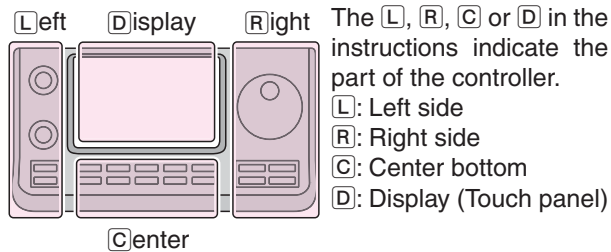

• Operation

- ① While Split frequency operation is ON, hold down **SPEECH**(R) for 1 second to activate the split lock function.
 - “**SPEECH**” appears.
- ② While holding down **XFC**(R), rotate the Dial to change the transmit frequency.
 - If you accidentally release **XFC**(R) while rotating the Dial, the receive frequency does NOT change.

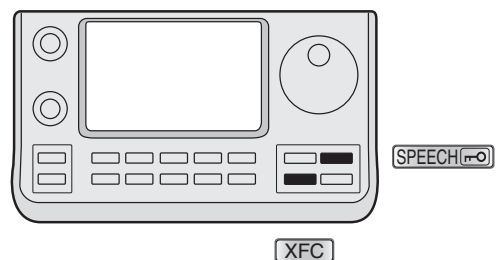

6 FUNCTIONS FOR TRANSMIT

Quick Split function

When you touch [SPLIT](D) for 1 second, the Split frequency operation is turned ON. The undisplayed VFO is automatically changed according to the plus/minus frequency shift programmed in the “SPLIT Offset” item of the “Function” Set mode (p. 165). Or the VFOs are equalized when 0.000 MHz (default setting) is programmed as the Split Offset (p. 165).

SET(C) > Function > SPLIT/DUP > **SPLIT Offset**

The Quick Split function is ON by default. For your convenience, it can be turned OFF in the “Quick SPLIT” item of the “Function” Set mode (p. 165). In this case, touch [SPLIT](D) for 1 second does not equalize the VFO A and VFO B frequencies.

SET(C) > Function > SPLIT/DUP > **Quick SPLIT**

- ① Suppose you are operating at 21.290 MHz (USB) in VFO A.
- ② Push **MENU**(C) one or more times to select the “M-1” screen (M-1 menu).
- ③ Touch [SPLIT](D) for 1 second.
 - Split frequency operation is turned ON.
 - The transmit (VFO B) frequency is equalized to the receive (VFO A) frequency.
- ④ While holding down **XFC**(R), rotate the Dial to set the frequency offset between transmit and receive.
 - When **XFC**(R) is released, the receive frequency is displayed.

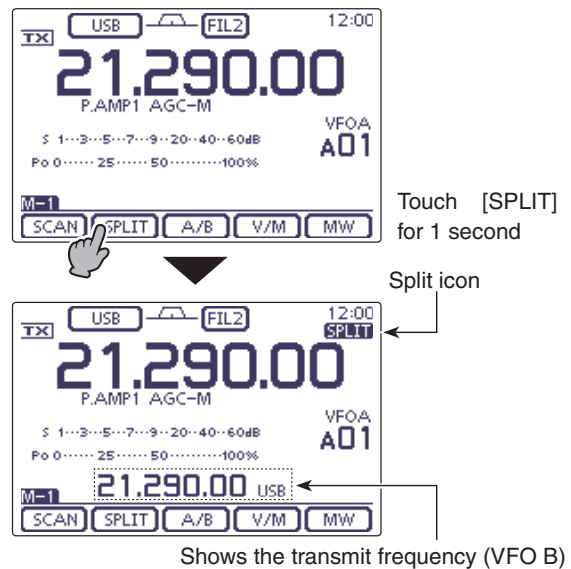
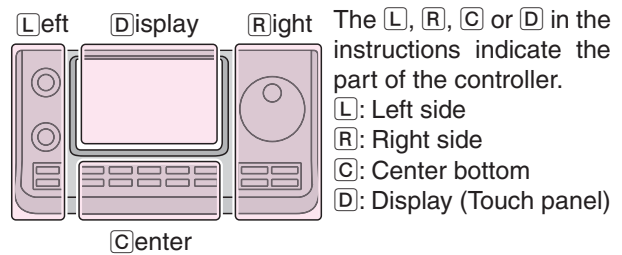

- While holding down **XFC** Shows the transmit frequency (VFO B)

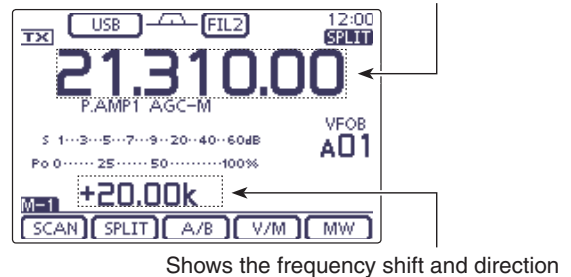

The example shows the split offset is set to +20 kHz (+0.020 MHz).

6 FUNCTIONS FOR TRANSMIT

Quick Split function (Continued)

◇ Split frequency offset setting

By setting an often-used split frequency offset in advance, you can use the Quick Split function to select split operation at the touch of one key.

- ① Push **SET**(C) to enter the Set mode.
- ② Touch the "SPLIT Offset" item of the "Function" Set mode.
 - Function > SPLIT/DUP > **SPLIT Offset**
 - If the specified item is not displayed, touch [▲] or [▼](D) one or more times to select the page.
- ③ Touch the number to enter the desired frequency shift, and then touch **ENT**(D).
- -9.999 to +9.999 MHz can be set in 1 kHz steps.
- ④ Push **SET**(C) to exit the Set mode.

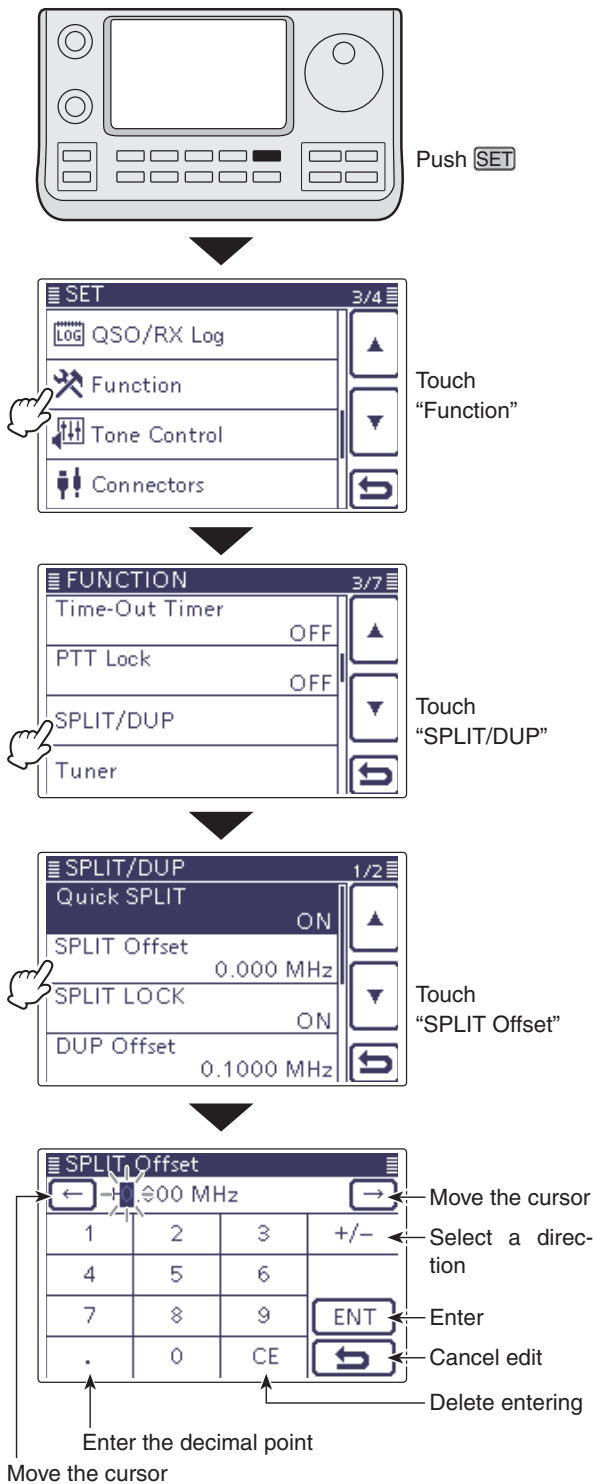
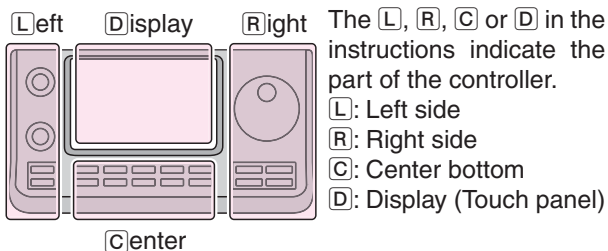

6 FUNCTIONS FOR TRANSMIT

Measuring SWR

The IC-7100 has a built-in circuit for measuring antenna SWR— no external equipment or special adjustments are necessary.

The IC-7100 can measure SWR two ways— spot measurement and plot measurement.

◆ Spot measurement

This function is convenient to use when measuring SWR of the antenna to install or periodic check.

- ① If desired, push **TUNER/CALL**(L) once or twice to turn OFF the antenna tuner.
 - If the antenna tuner is connected, and you want to measure SWR of the antenna itself, perform this step.
- ② Select the desired frequency band. (p. 3-5)
- ③ On the Mode selection screen, select the RTTY or RTTY-R mode. (p.3-??)
- ④ If necessary, adjust the RF power to more than 30 W on the Mic gain/RF power adjustment display.
 - If you are operating in the 144 MHz band, adjust the RF power to more than 20 W.
 - If you are operating in the 430 MHz band, adjust the RF power to more than 15 W.

- ① Push **MIC/RF PWR**(C) to open the MIC gain/RF power adjustment display.

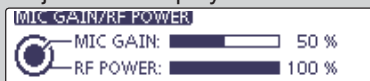

- ② Rotate **[BANK]**(L) to adjust the RF power.
- ③ Push **[MENU]**(C) to close the display.

Before transmitting, monitor the operating frequency to make sure transmitting won't cause interference to other stations on the same frequency.

- ⑤ Touch the TX meter one or more times to select the SWR meter.
- ⑥ Hold down **[PTT]** on the microphone or switch ON the external TX switch to transmit.
- ⑦ Read the SWR on the SWR meter.
 - If the SWR meter points 1.5 or less, the antenna is matched.
- ⑧ Release **[PTT]** or Switch OFF the external TX switch to receive.
 - When the measured SWR is more than 1.5:1, adjust the antenna to match with the transceiver.

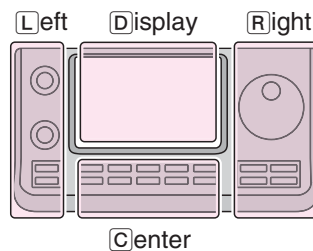

The L, R, C or D in the instructions indicate the part of the controller.

- L: Left side
- R: Right side
- C: Center bottom
- D: Display (Touch panel)

NOTE

This transceiver can measure SWR in the 144 MHz or 430 MHz bands.

Depending on the length of the connected coaxial cable, or installation condition, the measurement may be different from the actual SWR of the antenna in these band.

RTTY mode icon

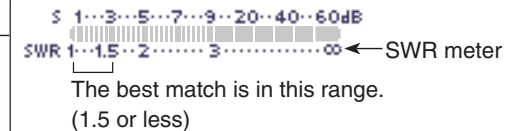
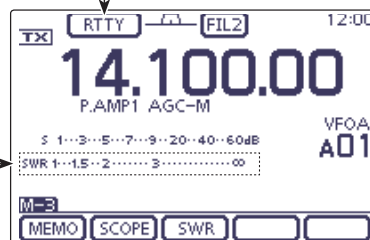

6 FUNCTIONS FOR TRANSMIT

Measuring SWR (Continued)

◇ Plot measurement

Plot measurement allows you to measure the SWR over an entire band.

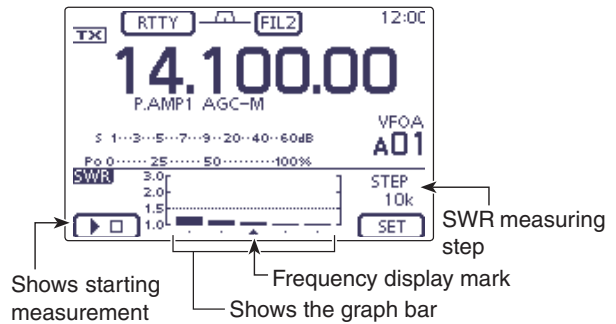

INDICATOR	DESCRIPTION
Measurement start icon	Touch [▶■](D) to start the measuring. While measuring, “▶□” is displayed. The measured frequency is displayed by the frequency display mark, “▲,” below the graph bar. While measuring SWR, the frequency cannot be changed. When quieting the SWR measurement, the frequency returns to the previous frequency before starting the SWR measurement.
Graph bar display	Each vertical dot indicates the SWR value, and horizontal bar indicates the number of measurement steps. The measurement steps can be selected the “Number of Graph Bar” item of the “SWR GRAPH SET” screen. SWR graph displays SWR 1 to 3 vertically, and many dots indicates the worse SWR. (SWR is displayed 1.0=1 dot, 1.5=10 dots, 2.0=19 dots and 3.0=28 dots.)
Frequency display mark	Displays the relative position of the measurement frequency.
SWR measuring step	Displays the selected SWR measuring step. Set the “Measuring Step” item of the “SWR GRAPH SET” screen.

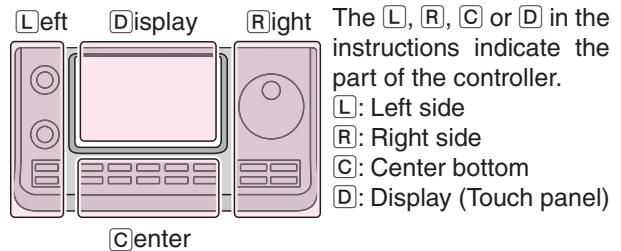

6 FUNCTIONS FOR TRANSMIT

Measuring SWR

◇ Plot measurement (Continued)

- ① Select the desired frequency band. (p. 3-5)
- ② On the Mode selection screen, select the RTTY or RTTY-R mode. (p.3-??)
- ③ If necessary, adjust the RF power to more than 30 W on the Mic gain/RF power adjustment display.
 - If your are operating in the 144 MHz band, adjust the RF power to more than 20 W.
 - If your are operating in the 430 MHz band, adjust the RF power to more than 15 W.

① Push **[MIC/RF PWR]**(C) to open the MIC gain/RF power adjustment display.

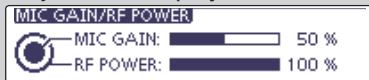

② Rotate **[BANK]**(L) to adjust the RF power.

Before transmitting, monitor the operating frequency to make sure transmitting won't cause interference to other stations on the same frequency.

- ④ Push **[MENU]**(C) one or more times to select the "M-3" screen (M-3 menu).
- ⑤ Touch **[SWR]**(D) to display the "SWR" (SWR Graph) screen.
- ⑥ Set the center frequency for the SWR to be measured.
 - The selectable number of graph bar are 3, 5, 7, 9, 11 and 13.
 - The selectable measuring steps are 10k, 50k, 100k and 500 kHz.
 - Touch **[↵]**(D) or push **[MENU]**(C) to return to the previous screen.
- ⑧ Touch **[▶□]**(D) to start the measuring.
 - A frequency marker, "▲," appears below the left edge of the graph bars and displays the frequency.
- ⑨ Hold down **[PTT]** on the microphone or switch ON the external TX switch to transmit.
 - The bar graph displays the SWR.
- ⑩ Release **[PTT]** or Switch OFF the external TX switch to receive.
 - The frequency marker moves to, and frequency display changes to the next frequency to be measured.
- ⑪ Repeat steps ⑨ and ⑩ to measure SWR over the entire frequency range.

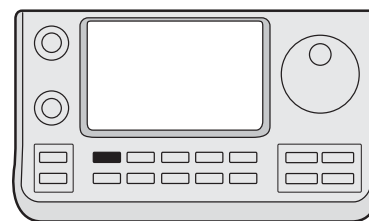
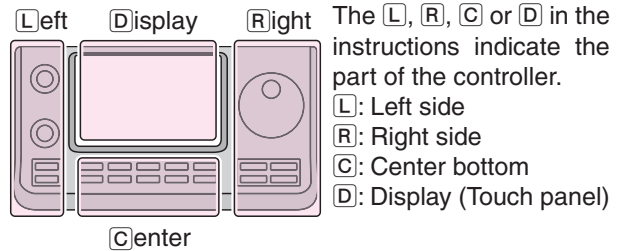

Push **[MENU]**

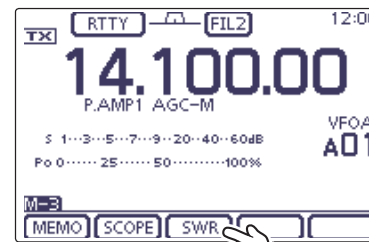

Touch **[SWR]**

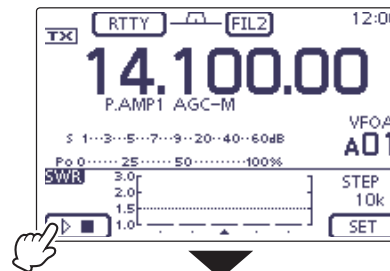

Touch **[▶□]**

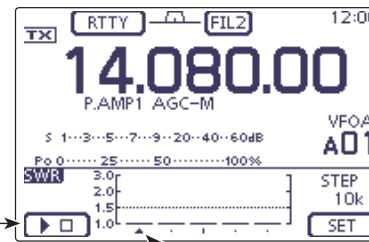

Measuring SWR
 While measuring SWR, the frequency cannot be changed

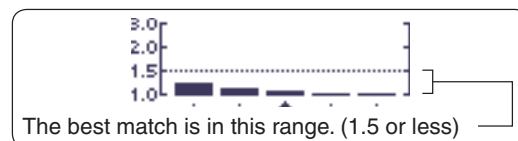

6 FUNCTIONS FOR TRANSMIT

Measuring SWR (Continued)

◇ SWR Graph Set mode

- ① Push **MENU**(C) one or more times to select the “M-3” screen (M-3 menu).
- ② Touch **[SWR]**(D) to display the “SWR” (SWR Graph) screen.
- ③ Touch **[SET]**(D) to enter the “SWR GRAPH SET” screen.
- ④ Touch the desired item to select.
 - See below for details of the set items and options.
- ⑤ Touch the desired option to change the setting.
 - If desired, touch the item for 1 second to open the Default set window, then select the “Default” to reset to the default setting.
- ⑥ Touch **[↶]**(D) or push **MENU**(C) to return to the “SWR” (SWR Graph) screen.
- ⑦ Push **MENU**(C) to return to the “M-3” screen (Menu 3).

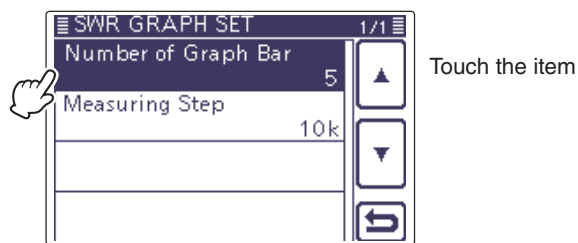
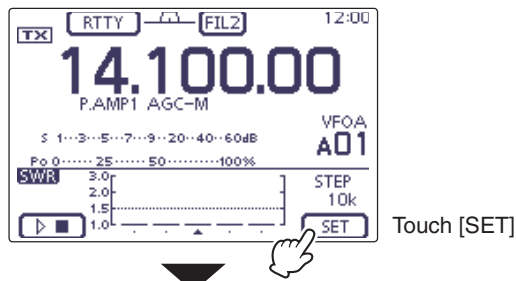
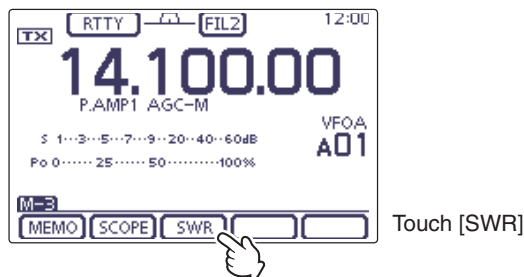
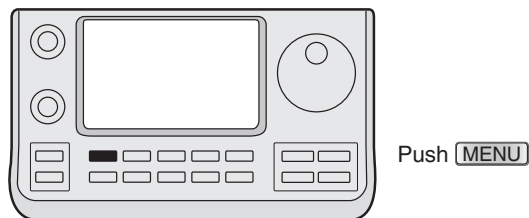
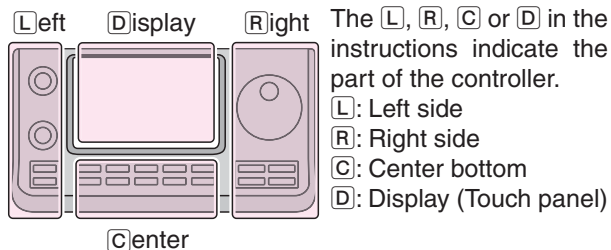

Number of Graph Bar (Default: 5)

Select the number of the graph bar for the displayed SWR Graph.

- The selectable number are 3, 5, 7, 9, 11 and 13.

Measuring Step (Default: 10k)

Select the SWR measuring step for the center frequency.

- The selectable steps are 10k, 50k, 100k and 500 kHz.

6 FUNCTIONS FOR TRANSMIT

DTMF Memory encoder

DTMF tones are used for autopatching, controlling other equipment, and so on. The transceiver has 16 DTMF memory channels for storage of often-used DTMF codes sequence of up to 24 digits.

◆ Programming a DTMF code

- ① Select the desired frequency band. (p. 3-5)
- ② On the Mode selection screen, select the FM or DV mode. (p.3-??)
 - The DTMF encoder can be used in the FM or DV mode.
- ③ Push **MENU**(C) one or more times to select the "M-3" screen (M-3 menu).
 - If you are operating in the DR mode, push **MENU**(C) once or twice to select the "D-2" screen (D-2 menu).
- ④ Touch **[DTMF]**(D) to display the DTMF mode.
 - The "DTMF" screen is displayed.
- ⑤ Touch **[EDIT]**(D) to display the "DTMF MEMORY" screen.
- ⑥ Touch the desired channel to select.
 - "d0" to "d9," "dA" to "dD," "d*" and "d#" are selectable.
- ⑦ Touch the number or character to enter the desired DTMF code.
- ⑧ After entering the DTMF codes, touch **[ENT]**(D) to save the channel, and return to the "DTMF MEMORY" screen.
- ⑨ Touch **[↶]**(D) or push **MENU**(C) to return to the "DTMF" screen.

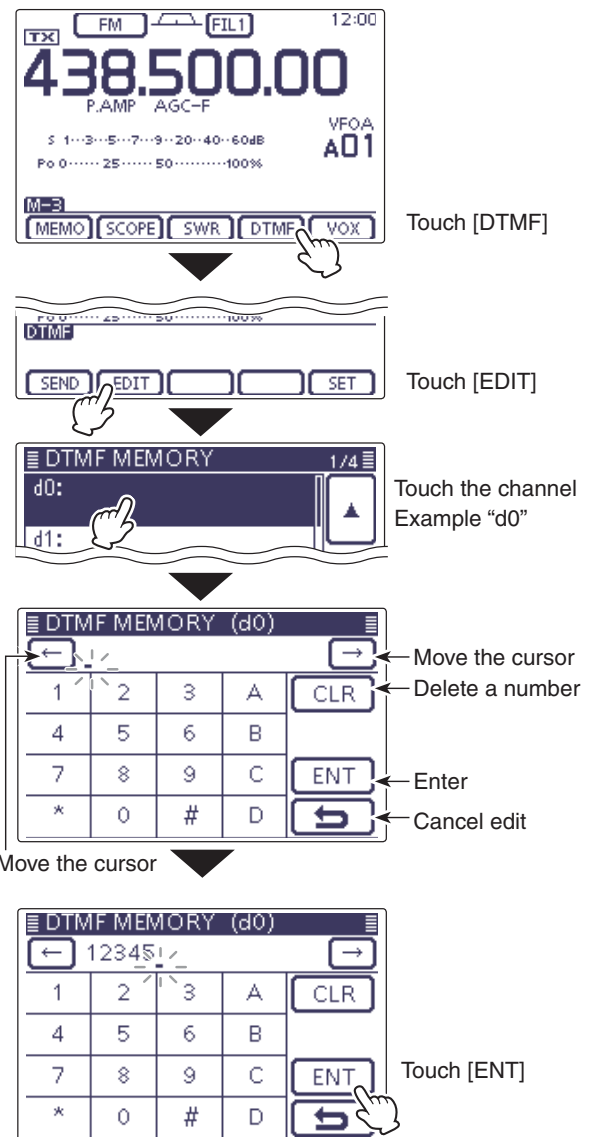
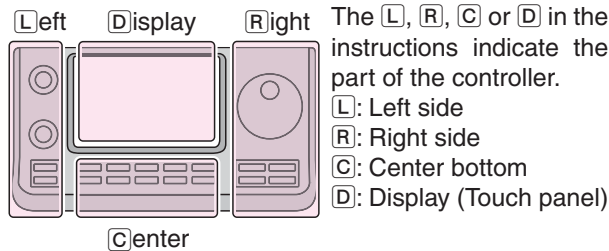

6 FUNCTIONS FOR TRANSMIT

DTMF memory encoder (Continued)

◆ Transmitting DTMF code

To transmit DTMF code using a DTMF send window, program the desired code in advance.

- ① Select the desired frequency band. (p. 3-5)
- ② On the Mode selection screen, select the FM or DV mode. (p.3-??)
 - The DTMF encoder can be used in the FM or DV mode.
- ③ Push **MENU**(C) one or more times to select the “M-3” screen (M-3 menu).
 - If your are operating in the DR mode, push **MENU**(C) once or twice to select the “D-2” screen (D-2 menu).
- ④ Touch **[DTMF]**(D) to display the DTMF mode.
 - The “DTMF” screen is displayed.
- ⑤ Touch **[SEND]**(D) to open the DTMF send window.
- ⑥ Touch the desired channel to transmit the DTMF code.
 - The transceiver automatically transmits the selected DTMF code.
 - While transmitting, touch **[SEND]**, **[EDIT]** or **[SET]**(D) or push **MENU**(C), **SET**(C) or **XFC**(R), cancels the transmission.
 - After transmitting, transceiver returns to the “DTMF” screen.

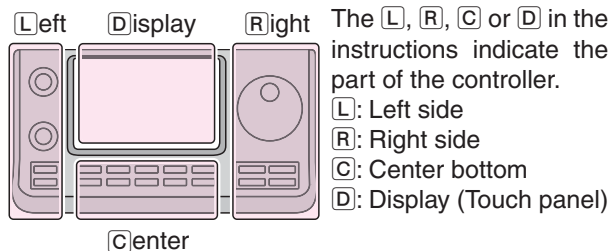
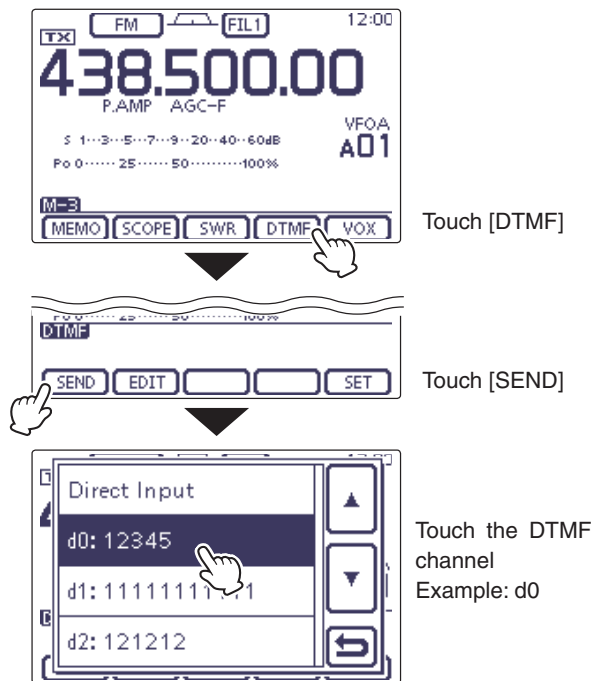

• While transmitting

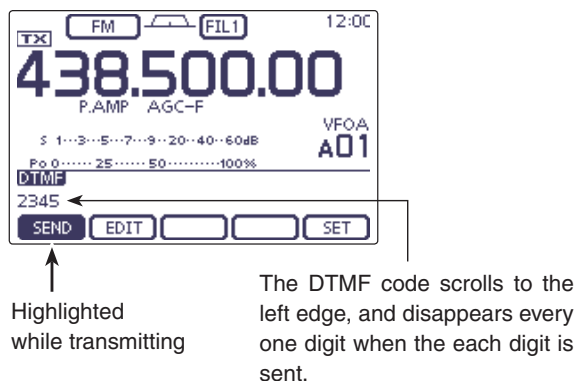

6 FUNCTIONS FOR TRANSMIT

DTMF memory encoder (Continued)

◇ Transmitting DTMF code (Direct Input)

- ① Select the desired frequency band. (p. 3-5)
- ② On the Mode selection screen, select the FM or DV mode. (p.3-??)
 - The DTMF encoder can be used in the FM or DV mode.
- ③ Push **MENU**(C) one or more times to select the “M-3” screen (M-3 menu).
 - If your are operating in the DR mode, push **MENU**(C) once or twice to select the “D-2” screen (D-2 menu).
- ④ Touch **[DTMF]**(D) to display the DTMF mode.
- ⑤ Touch **[SEND]**(D) to open the DTMF send window.
- ⑥ Touch “Direct Input” to display the “DTMF DIRECT INPUT” screen.
- ⑦ Touch the number or character to enter the desired DTMF code.
- ⑧ When all digit are set, touch **[TX]**(D) to transmit the code.
 - The transceiver automatically transmits the DTMF code.
 - While transmitting, touch **[SEND]**, **[EDIT]** or **[SET]**(D) or push **MENU**(C), **SET**(C) or **XFC**(R), cancels the transmission.
 - After transmitting, transceiver returns to the “DTMF” screen.

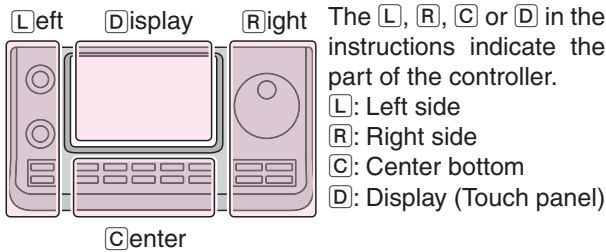
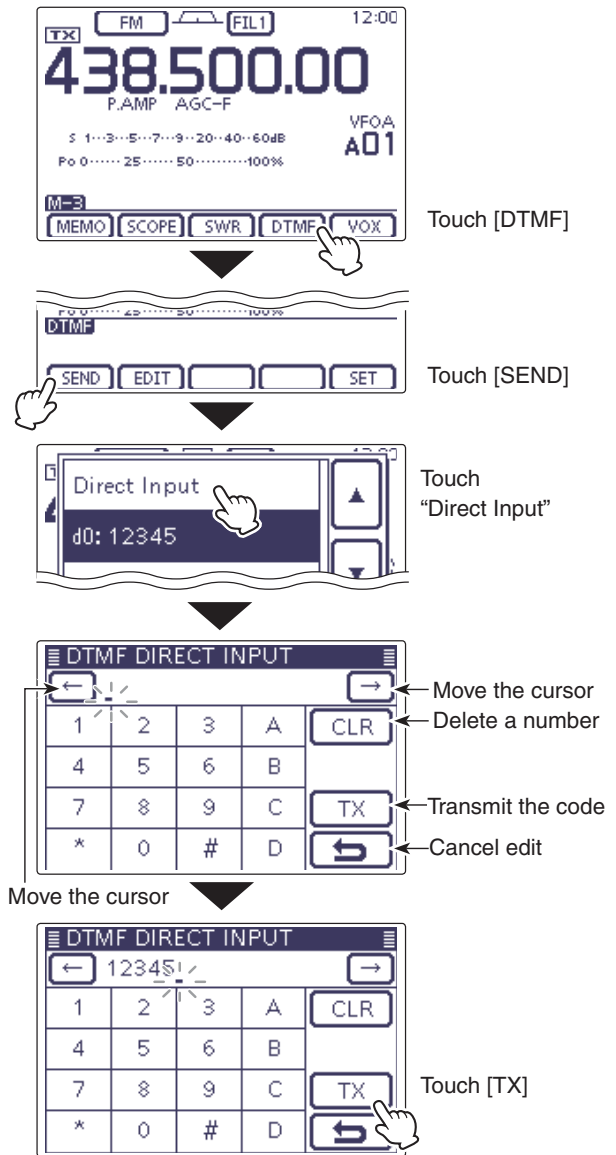

• While transmitting

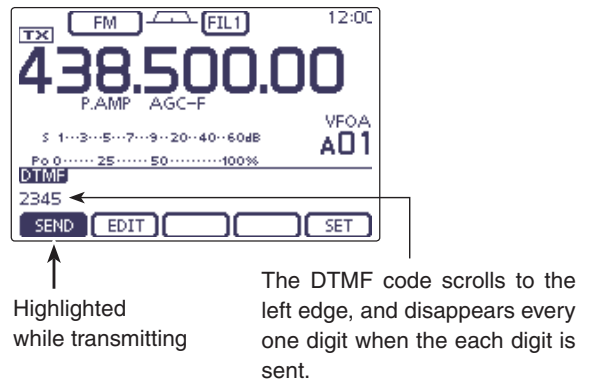

6 FUNCTIONS FOR TRANSMIT

DTMF memory encoder (Continued)

◇ Setting DTMF transfer speed

The DTMF transfer speed can be selected.

- ① On the Mode selection screen, select the FM or DV mode. (p.3-??)
 - The DTMF encoder can be used in the FM or DV mode.
- ② Push **MENU**(C) one or more times to select the “M-3” screen (M-3 menu).
 - If you are operating in the DR mode, push **MENU**(C) once or twice to select the “D-2” screen (D-2 menu).
- ③ Touch **[DTMF]**(D) to display the DTMF mode.
 - The “DTMF” screen is displayed.
- ④ Touch **[SET]**(D) to enter the “DTMF SET” mode.
- ⑤ Touch “DTMF Speed” to enter the “DTMF Speed” set screen.
- ⑥ Touch the desired option to change the setting.
 - 100ms: Transfer the DTMF tones at about 100 milliseconds per code.
5 characters per second.
 - 200ms: Transfer the DTMF tones at about 200 milliseconds per code.
2.5 characters per second.
 - 300ms: Transfer the DTMF tones at about 300 milliseconds per code.
1.6 characters per second.
 - 500ms: Transfer the DTMF tones at about 500 milliseconds per code.
1 character per second.
 - If desired, touch the item for 1 second to open the Default set window, then select the “Default” to reset to the default setting.
- ⑦ Touch **[↵]**(D) or push **MENU**(C) to return to the “DTMF” screen.

Example: Set the DTMF transfer speed to 300 milliseconds.

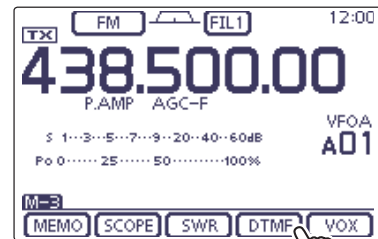

Touch [DTMF]

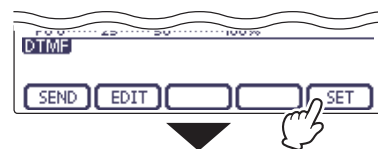

Touch [SET]

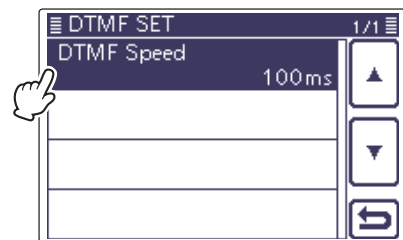

Touch the item

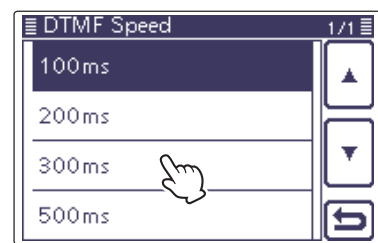

Touch the option
Example: 300 ms

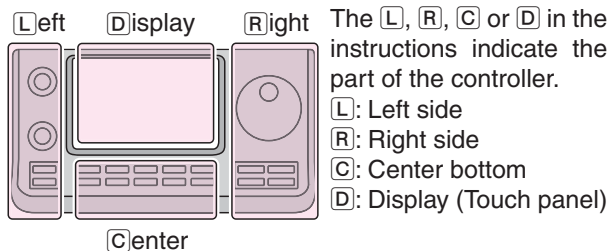

Section 7

D-STAR INTRODUCTION

- “MY” (Your own call sign) programming 7-2
- D-STAR Introduction 7-5
- About the DR (D-STAR Repeater) mode 7-6
- Communication Form in the DR mode 7-7

IMPORTANT!

- The repeater list, described in this manual, may differ from your transceiver’s preloaded contents.
- Although Japanese repeaters are used in the setting examples, the Japanese repeater node (port) letters are different from other country’s.

Be sure to add a repeater node letter as the 8th digit in the call sign field after a repeater call sign, according to the repeater frequency band, as shown below.

1200 MHz: A (B in Japan)

430 MHz: B (A in Japan)

144 MHz: C (no D-STAR repeaters in Japan)

7 D-STAR INTRODUCTION

“MY” (Your own call sign) programming

Before starting D-STAR, the following steps are needed.

IMPORTANT! **STEP 1** Entering your call sign (MY) into the transceiver. → **STEP 2** Registering your call sign (MY) to a gateway repeater. → You have completed the steps!!

You can store up to 6 “MY” call signs.

Example: Enter “JA3YUA” as your own call sign into the MY call sign memory [MY1].

1. Display the My Call Sign Edit screen

- ① Push **SET**(**C**) to enter the Set mode.
- ② Touch the “MY Call Sign” item of the “My Station” Set mode.
(My Station > **MY Call Sign**)
 - If the specified item is not displayed, touch **[▲]** or **[▼]**(**D**) one or more times to select the page.
- ③ Touch the desired call sign memory for 1 second.
(Example: 1:)
- ④ Touch the “Edit” item.
• “MY CALL SIGN (MY*)” screen appears.
The memory number, selected in the step ③, is displayed.
(Example: MY1)

The **L**, **R**, **C** or **D** in the instructions indicate the part of the controller.

- L**: Left side, **R**: Right side, **C**: Center bottom
- D**: Display (Touch panel)

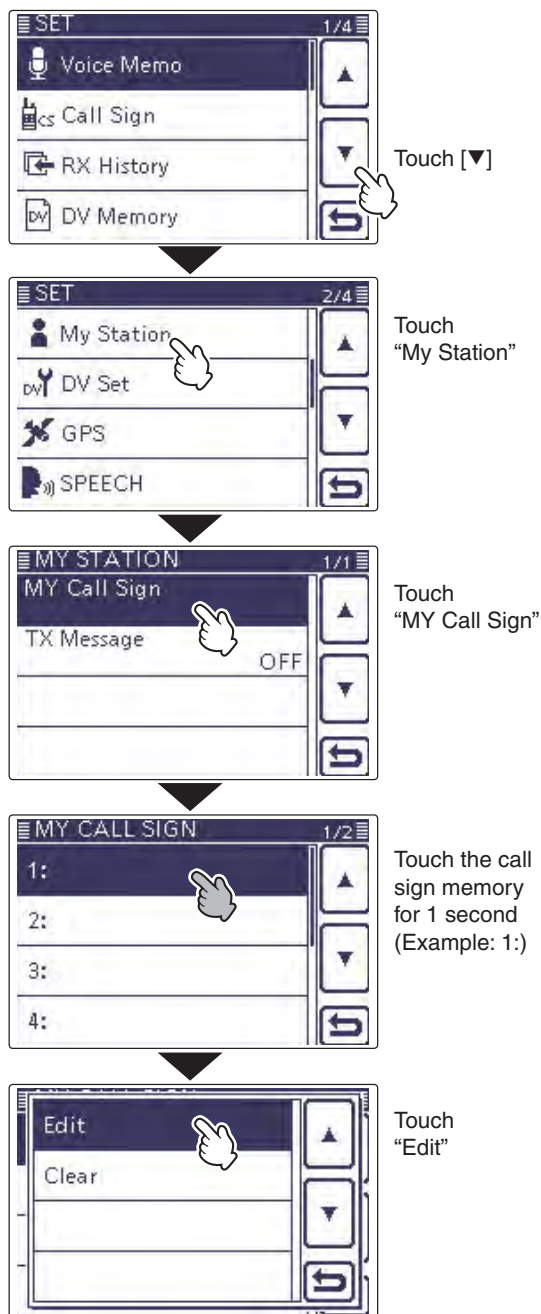

Continued on the next page

7 D-STAR INTRODUCTION

“MY” (Your own call sign) programming (Continued)

2. Enter the Call Sign

- ⑤ Touch the desired block one or more times to select the desired character or symbol.
(Example: J)
 - A to Z, 0 to 9 and / are selectable.
 - Touch “AB↔12” to toggle between the Alphabet input and Number input mode.
 - Touch [CLR](D) to delete the selected character, symbol or number.
 - Touch “_” to input a space.
- ⑥ Touch [←](D) to move the cursor backwards, or touch [→](D) to move the cursor forwards.
- ⑦ Repeat steps ⑤ and ⑥ to enter your own call sign of up to 8 characters, including spaces.
(Example: First J, then A, then 3, then Y, then U, then A)
- ⑧ Touch [ENT](D) to return to the “MY CALL SIGN” screen.

Call sign edit screen

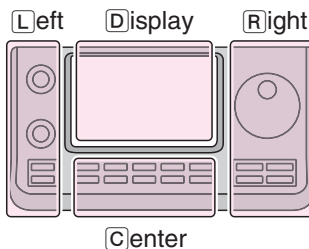
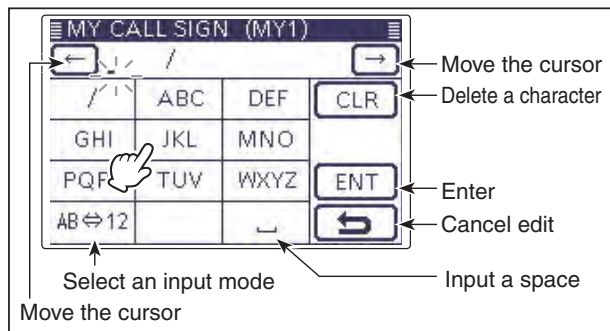

The L, R, C or D in the instructions indicate the part of the controller.

- L: Left side
- R: Right side
- C: Center bottom
- D: Display (Touch panel)

Enter “JA3YUA” into [MY1].

- ① Touch [JKL] to enter 'J.'
- ② Touch [ABC] to enter 'A.'
- ③ Touch [AB↔12].
Number input mode is selected.
- ④ Touch [3] to enter '3.'
- ⑤ Touch [AB↔12].
Alphabet input mode is selected.
- ⑥ Touch [WXYZ] three times to enter 'Y.'
- ⑦ Touch [TUV] two times to enter 'U.'
- ⑧ Touch [ABC] to enter 'A.'
- ⑨ Touch [ENT]

Continued on the next page

7 D-STAR INTRODUCTION

“MY” (Your own call sign) programming

2. Enter the Call Sign (Continued)

- ⑨ Touch the entered call sign to set the call sign to be used.
- ⑩ Push **SET**(**C**) to exit the Set mode.

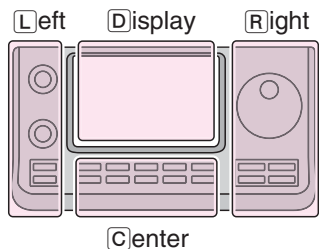

The **L**, **R**, **C** or **D** in the instructions indicate the part of the controller.

- L**: Left side
- R**: Right side
- C**: Center bottom
- D**: Display (Touch panel)

✓ Convenient!

If necessary, enter a note of up to 4 characters, such as the model of the transceiver, name, area name, and so on, after your call sign.

- ① Touch **[→]**(**D**) one or more times until the cursor moves to the right of the “?”.



- ② Repeat steps ⑤ and ⑥ on the page 7-3 to enter a desired 4 character note. (Example: 7100)

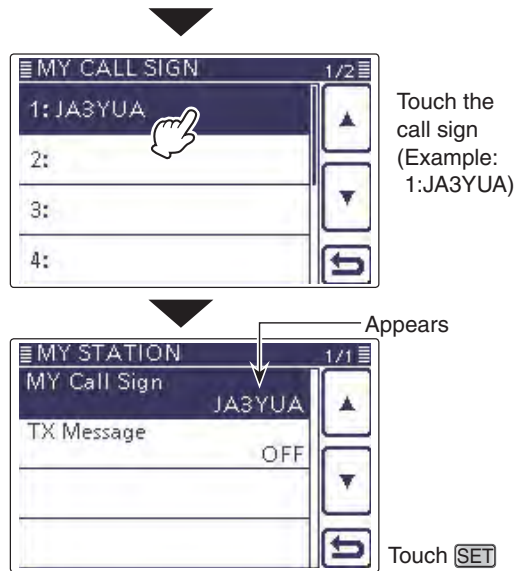

✓ Important!

To use a repeater gateway, you must register your call sign with a gateway repeater, usually one near your home location.

If needed, ask the gateway repeater administrator for call sign registration instructions.

7 D-STAR INTRODUCTION

D-STAR Introduction

- In the original D-STAR (Digital Smart Technologies for Amateur Radio) plan, JARL envisioned a system of repeaters grouped together into Zones.
- The D-STAR repeater enables you to call a HAM station in another area through the internet.
- The transceiver can be operated in the digital voice mode, including low-speed data operation, for both transmit and receive. It has a built-in GPS receiver to transmit and receive position data.

7 D-STAR INTRODUCTION

About the DR (D-STAR Repeater) mode

The DR (D-STAR Repeater) mode is one mode you can use for D-STAR repeater operation. In this mode, you can select the preprogrammed repeater or frequency in "FROM" (the access repeater or simplex), and UR call sign in "TO" (destination), as shown to the right.

NOTE: If the repeater, set to "FROM" (Access Repeater) has no Gateway call sign, you cannot make a gateway call.

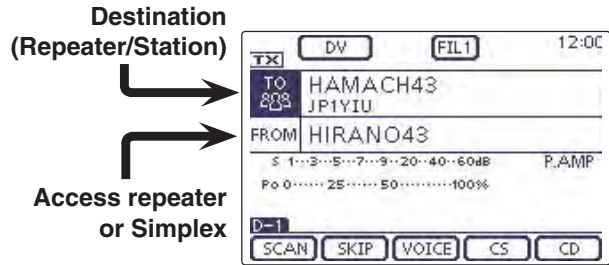

In the DR mode

7 D-STAR INTRODUCTION

Communication Form in the DR mode

In the DR mode, the transceiver has three communication forms, as shown below.

- Local area call: To call through your local area (access) repeater.
- Gateway call: To call through your local area (access) repeater, repeater gateway and the internet to your destination repeater or individual station's last used repeater, using call sign routing.
- Simplex call: To call another station not using a repeater.

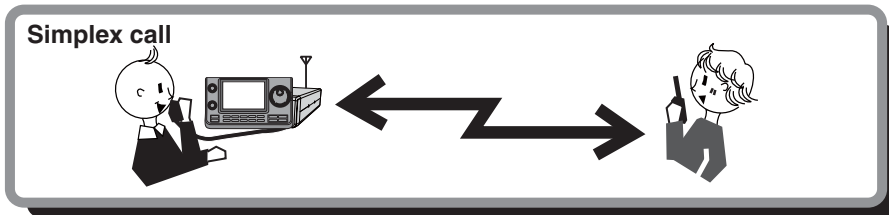
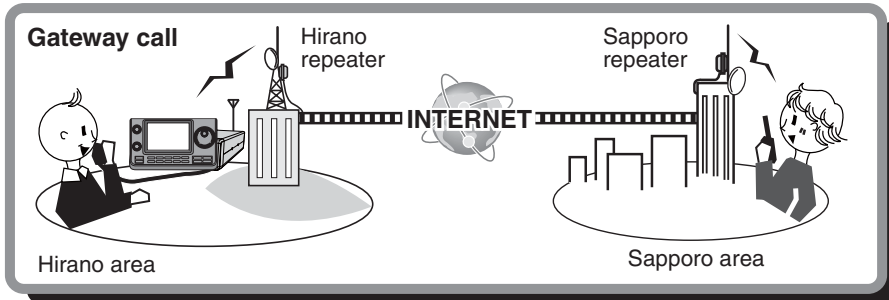
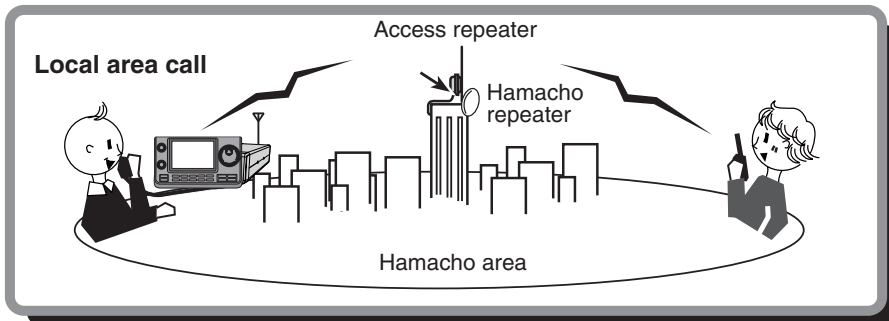

NOTE:

- Programming the repeater list is required for DR mode operation. (pp. ??-?? to ??-??)
- Before operating in the DV mode, be sure to check whether the repeater is busy, or not. If the repeater is busy, wait until it is clear, or ask for a “break” using a method acceptable to your local procedures.
- The transceiver has a Time-Out Timer function for digital repeater operation. The timer limits a continuous transmission to approximately 10 minutes. Warning beeps will sound approximately 30 seconds before time-out and then again immediately before time-out.

Section 11 MEMORY OPERATION

- General description..... 11-2**
 - ◇ Memory channel contents 11-2
- Selecting a Memory channel 11-3**
 - ◇ Selecting in the VFO mode 11-3
 - ◇ Selecting in the Memory mode..... 11-3
- Selecting a Call channel 11-4**
- Programming a Memory channel 11-5**
 - ◇ Programming in the VFO mode..... 11-5
 - ◇ Programming in the Memory mode 11-5
 - ◇ Programming the Call channels 11-5
- Clearing a Memory channel..... 11-7**
- Copying Memory contents 11-8**
 - ◇ Copying in the Memory mode 11-8
 - ◇ Copying in the VFO mode 11-8
- Programming a Memory name 11-9**
- Selecting a Memory display type 11-11**
- Memo pad function..... 11-12**
 - ◇ Writing the displayed contents into the Memo pads 11-12
 - ◇ Calling up the Memo pads..... 11-13

11 MEMORY OPERATION

General description

The transceiver has a total of 495 Memory channels (99 channels in each of 5 memory banks, A to E), 6 Scan Edge channels (3 pairs) and two Call channels (C1/C2) each for the 144 and 430 MHz frequency bands.

The Memory mode is useful to quickly select often-used frequencies.

While in the memory mode, all 503 Memory channels are tunable, which means the programmed frequency can be temporarily tuned with the Dial.

When you tune a Memory channel without storing, and then go back to the channel again, the original stored frequency is displayed.

In the Memory mode, touch just above MHz area on the display, and then select the desired band. Then rotate the Dial to select the frequency to be stored.

Memory Channels	Descriptions
1–99 (Total of 495)	Regular Memory channels with split frequency capability.
1A/1B–3A/3B	Program Scan Edge Memory channels with only simplex capability. Stores the Scan Edge frequencies for programmed scans.
C1/C2	Two Call channels (C1/C2) each for the 144 and 430 MHz frequency bands. Call channel with split frequency capability. Instantly recalls a specified frequency.

◇ Memory channel contents

The following information can be programmed into Memory channels:

- Operating frequency (p. ??-??)
- Operating mode (p. ??-??)
- IF filter number (p. ??-??)
- Split data (p. ??-??)
(Usable only on the regular Memory channels and Call channels.)
- Memory name (p. ??-??)
- Duplex direction (DUP+ or DUP–) and frequency offset (pp. ??-??)
- Subaudible tone encoder (p. ??-??), tone squelch or DTCS squelch ON/OFF (pp. ??-??, ??-??)
- Subaudible tone frequency (p. ??-??), tone squelch frequency or DTCS code with polarity (p. ??-??)
- Destination call sign (p. ??-??)
- R1/R2 call signs (p. ??-??)
- Call sign squelch or Digital code squelch ON/OFF (p. ??-??)
- Digital code (p. ??-??)

NOTE:

Memory content can be erased by static electricity, electric transients, and other causes. In addition, they can be erased by a malfunction or during repairs. Therefore, we recommend that you backup the memory content or save it to a SD card or to a PC.

- The SD card is not available from Icom. Purchase a SD card to meet your needs.
- The optional CS-7100 CLONING SOFTWARE can also be used to backup your memory data.

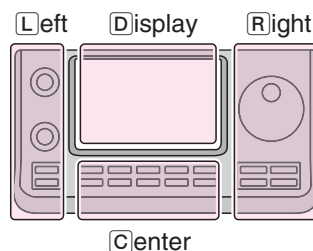

The L, R, C or D in the instructions indicate the part of the controller.

- L: Left side
- R: Right side
- C: Center bottom
- D: Display (Touch panel)

11 MEMORY OPERATION

Selecting a Memory channel

◇ Selecting in the VFO mode

- ① Touch the Memory channel number indication once or twice to select the VFO mode. (p. ??-??)
- ② Rotate [BANK](L) to select a Memory bank that contains the channel you want to select.
- ③ Rotate [M-CH](L) to select a Memory channel number.
 - Rotate clockwise to select a higher Memory channel number; rotate counterclockwise to select a lower Memory channel number.
 - All Memory channels, including blank channels, can be selected.
 - “BLANK” appears when no information has been programmed into the Memory channel. (Blank channel)
 - You can do either step ④ or ⑤ first.
- ④ Touch the Memory channel number indication to select the Memory mode.
 - “MEMO” and the Memory channel contents appear.

NOTE: When the PBT indicator lights green, or the RIT indicator lights orange, push [M-CH](L) to turn OFF the indicator first, and then rotate it.

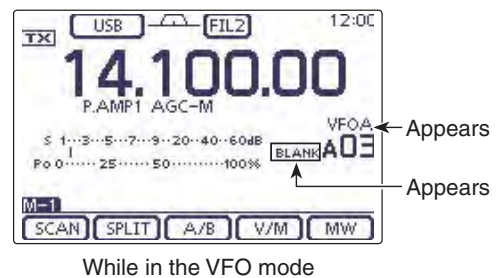
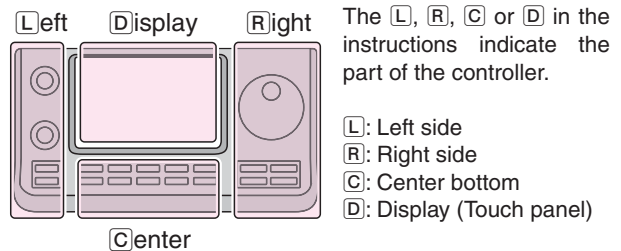

◇ Selecting in the Memory mode

- ① Touch the Memory channel number indication once or twice to select the Memory mode. (p. ??-??)
- ② Rotate [BANK](L) to select a Memory bank that contains the channel you want to select.
- ③ Rotate [M-CH](L) to select a Memory channel number.
 - Rotate clockwise to select a higher Memory channel number; rotate counterclockwise to select a lower Memory channel number.
 - All Memory channels, including blank channels, can be selected.
 - “BLANK” appears when no content has been programmed into the Memory channel. (Blank channel)
 - Memory channels can also be selected using the microphone [UP]/[DN] keys. In such case, the blank channels are skipped.

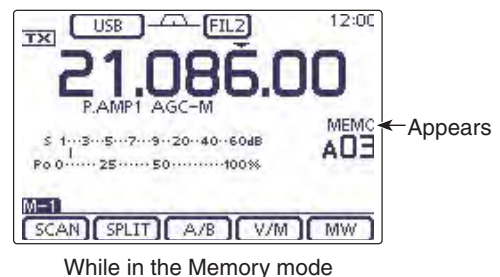

11 MEMORY OPERATION

Selecting a Call channel

Two Call channels (C1/C2) are selectable in each of the 144 and 430 MHz frequency bands.

Factory default frequencies and operating modes are programmed into the Call channels. Change these to suit your operating needs. (see page ??)

- ① Select the 144 or 430 MHz frequency band. (p. ??-??)
- ② Push **TUNER/CALL**(L) to select the Call channel of the selected frequency band.
 - “CALL1” appears.
 - Rotate [M-CH] to select “CALL2.”
- ③ Push **TUNER/CALL**(L) again to return to the previous screen display.

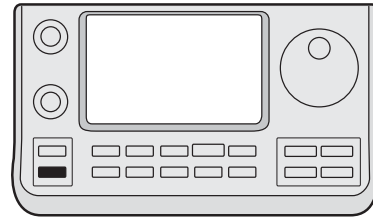

TUNER/CALL



←Appears

While in the Call channel mode

11 MEMORY OPERATION

Programming a Memory channel

Memory channels can be programmed in either the VFO mode or the Memory mode.

NOTE: If you perform the operations as described below in a pre-programmed channel, the previous channel content will be overwritten.

◇ Programming in the VFO mode

- ① Touch the Memory channel number indication once or twice to select the VFO mode. (p. ??-??)
- ② Set the desired contents into VFO A or VFO B.
- ③ Rotate [BANK](L) or [M-CH](L) to select the Memory channel to be programmed.
 - “BLANK” appears when no content has been programmed into the Memory channel. (Blank channel)
- ④ Touch [MW](D) for 1 second to program the contents into the Memory channel.

◇ Programming in the Memory mode

- ① Touch the Memory channel number indication once or twice to select the Memory mode. (p. ??-??)
- ② Rotate [M-CH](L) to select the Memory channel to be programmed.
 - The contents of the Memory channel appear in the display.
 - “BLANK” appears if the selected Memory channel is a blank channel.
- ③ Set the desired contents into the Memory channel.
 - When a blank channel is selected, touch just above MHz area on the display, and then select the desired band. Rotate the Dial to select the frequency. (p. ??)
- ④ Touch [MW](D) for 1 second to program the contents into the Memory channel.

◇ Programming the Call channels

It is convenient to program often-used frequencies into the Call channels for quick recall.

- ① Rotate [M-CH](L) to select a Call channel.
 - A capital “C” appears.
- ② Set the desired contents into the channel.
- ③ Touch [MW](D) for 1 second to program the contents into the Call channel.

IMPORTANT!

When a Call channel is selected by pushing **TUNER/CALL** (L), you cannot change the memory contents. However, when a Call channel is selected using [M-CH] in the VFO or Memory mode, the memory contents can be changed.

The 144 MHz frequency band can be programmed into the 144 “C1” or C2,” and the 430 MHz frequency band can be programmed into the 430 “C1” or C2.”

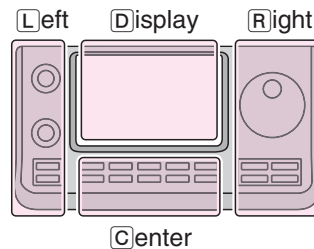

The L, R, C or D in the instructions indicate the part of the controller.

- L: Left side
- R: Right side
- C: Center bottom
- D: Display (Touch panel)

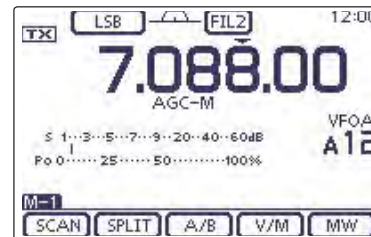

[Example]:
Programming 7.088 MHz/LSB into Memory channel 12 while in the VFO mode.



[Example]:
Programming 21.280 MHz/USB into Memory channel 18 while in the Memory mode.

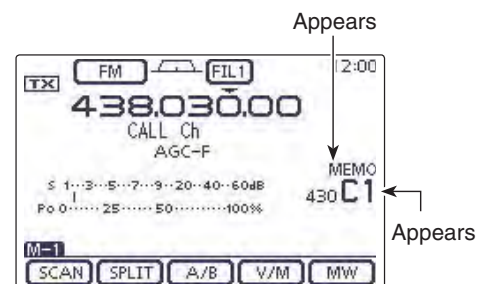

While in the Memory mode

11 MEMORY OPERATION

Programming a Memory channel (Continued)

◇ Programming in the DR mode

- ① Push **[DR]** to select the DR mode. (p. ??-??)
- ② Set the desired contents. (p. ??-??)
- ③ Push **[MENU]**(**C**) one or more times to select the “D-2” screen.
- ④ Touch **[MW]**(**D**).
 - The “MW” screen appears.
- ⑤ Rotate **[BANK]**(**L**) or **[M-CH]**(**L**) to select the Memory channel to be programmed.
 - “- - - - -” appears when no content has been programmed into the Memory channel. (Blank channel)
- ⑥ Touch **[MW]**(**D**) for 1 second to program the contents into the Memory channel.
- ⑦ Check the programmed contents on the Memory mode. (p. ??-??)

✓ For your reference

The Memory channel contents, programmed in the DR mode, can also be copied to the VFO. (p. ??-??)

The **L**, **R**, **C** or **D** in the instructions indicate the part of the controller.

L: Left side, **R**: Right side, **C**: Center bottom
D: Display (Touch panel)

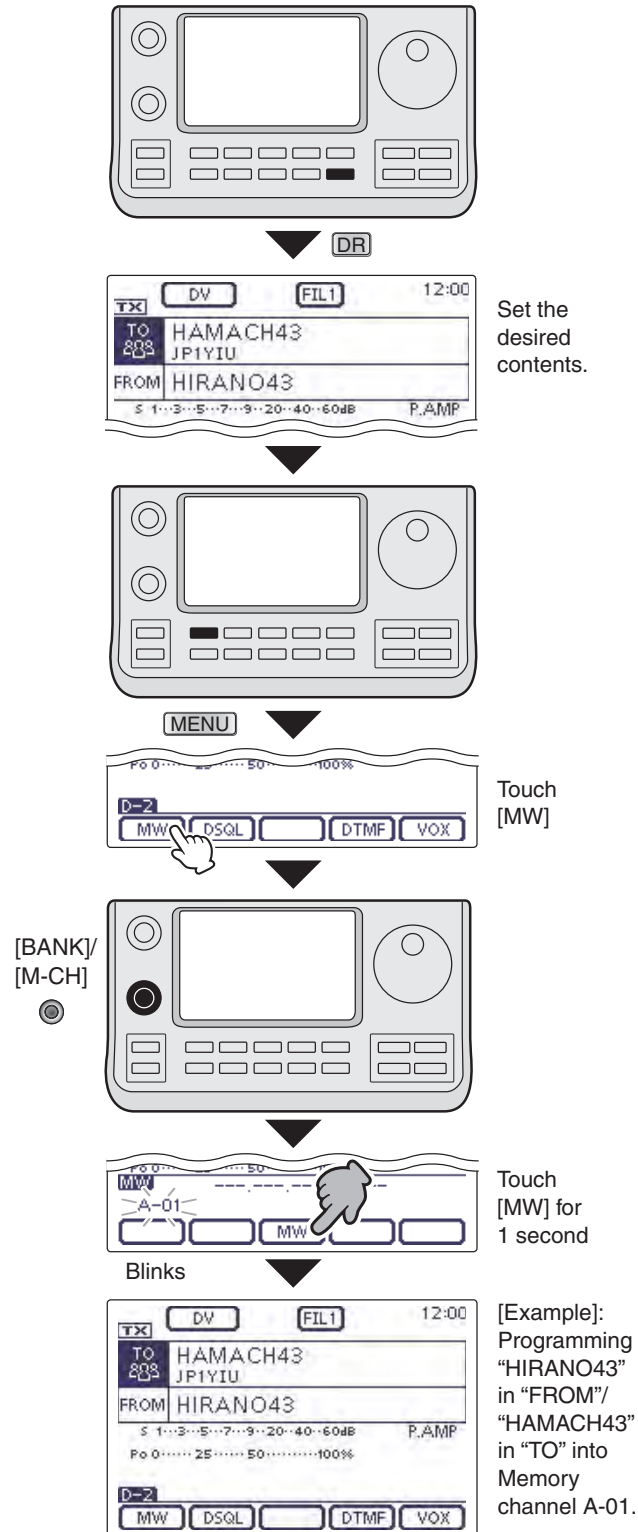

11 MEMORY OPERATION

Programming a Memory channel (Continued)

◇ Checking the programmed Memory contents

The programmed Memory channels can be checked on the “MEMORY LIST” screen.

- ① When the “M-3” (Menu 3) screen is selected, touch [MEMO](D) to display the “MEMO” (Memory) screen.
- ② Rotate [BANK](L) to select the Memory bank (A to E) to be checked.
- ③ Touch [LIST](D) to display the “MEMORY LIST” screen.
 - Touch [▲] or [▼](D) to select the displayed page.
 - The Program Scan Edge Memory channels can be checked on any band screen.

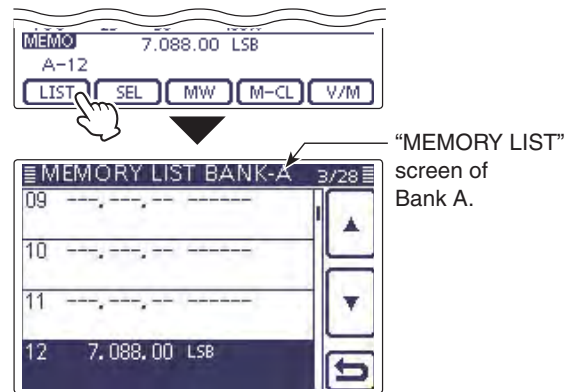
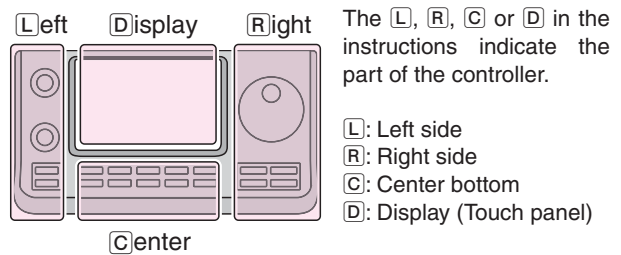

◇ Checking the Memory contents programmed in the DR mode

- ① Push [DR] one or more times to cancel the DR mode.
- ② Touch the Memory channel number indication once or twice to select the Memory mode. (p. ??-??)
 - The access repeater call sign and the destination call sign appear.

When the “M-2” (Menu 2) screen is selected, touch [CS](D) to display the call sign programmed in the selected channel.

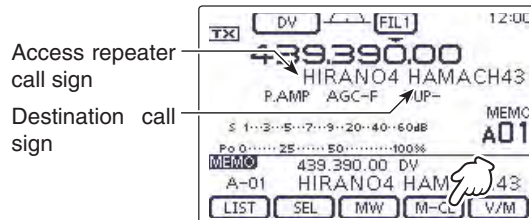

✓ For your reference

“FROM” and “TO” names are automatically programmed as the Memory name.

- The Memory name is not overwritten when the memory contents are programmed into the preprogrammed channel.

11 MEMORY OPERATION

Clearing a Memory channel

Any no longer used regular Memory channels can be cleared, and then become blank channels.

- ① Touch the Memory channel number indication once or twice to select the Memory mode. (p. ??-??)
- ② Rotate [BANK](L) or [M-CH](L) to select the Memory channel to be cleared.
- ③ Push [MENU](C) one or more times to select the “M-3” screen (Menu 3).
- ④ Touch [MEMO](D).
- ⑤ Touch [M-CL](D) for 1 second.
 - The programmed contents disappear.
 - “BLANK” appears.

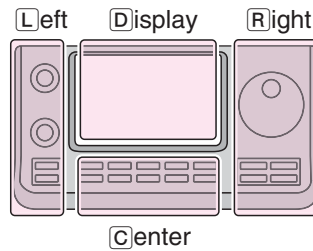

The L, R, C or D in the instructions indicate the part of the controller.

- L: Left side
- R: Right side
- C: Center bottom
- D: Display (Touch panel)

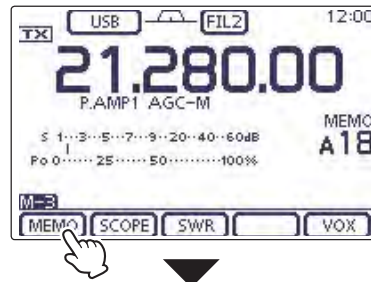

Touch [MEMO].

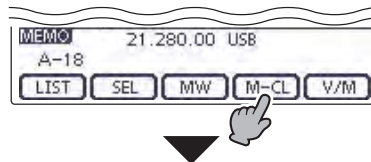

Touch [M-CL] for 1 second.

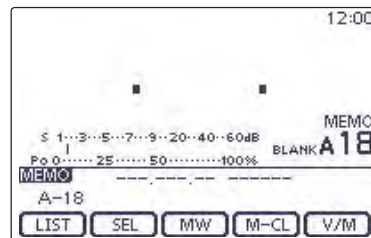

11 MEMORY OPERATION

Copying Memory contents

The Memory channel contents (frequency, operating mode, and so on.) can be copied to the VFO.

◇ Copying in the Memory mode

- ① Touch the Memory channel number indication once or twice to select the Memory mode. (p. ??-??)
- ② Rotate [BANK](L) or [M-CH](L) to select the Memory channel to be copied.
 - “BLANK” appears if the selected Memory channel is a blank channel. In this case nothing can be copied.
- ③ Touch [V/M](D) for 1 second to copy the Memory channel contents into the VFO.
- ④ Touch the Memory channel number indication to select the VFO mode. (p. ??-??)

◇ Copying in the VFO mode

- In the VFO mode, select the Memory channel number to be copied. And then, touch [V/M] for 1 second to copy the Memory channel contents into the selected VFO.
 - “BLANK” appears if the selected Memory channel is a blank channel. In this case nothing can be copied.

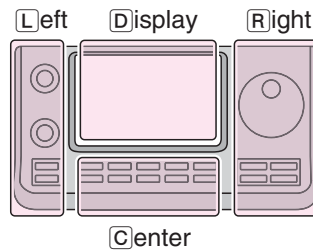

The L, R, C or D in the instructions indicate the part of the controller.

- L: Left side
- R: Right side
- C: Center bottom
- D: Display (Touch panel)

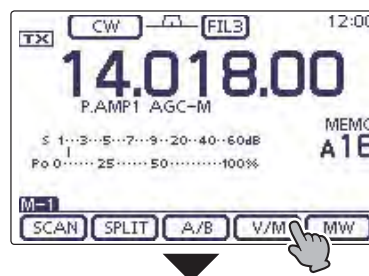

Touch [V/M] for 1 second.

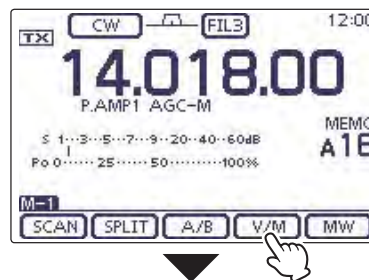

The Memory channel contents are transferred into the selected VFO. (The display does not change.)

Touch [V/M].



11 MEMORY OPERATION

Programming a Memory name

All Memory channels, including Scan Edges and Call channels, can be tagged with alphanumeric names of up to 16 characters each.

[EXAMPLE]: Programming a memory name into Memory channel 99 of Bank A.

- ① Touch the Memory channel number indication once or twice to select the Memory mode. (p. ??-??)
- ② Rotate [BANK] to select Bank A.
- ③ Rotate [M-CH] to select the Memory channel 99.
- ④ Push [MENU](C) one or more times to select the “M-3” screen (Menu 3).
- ⑤ Touch [MEMO](D) to display the “MEMO” screen (Memory Menu).
- ⑥ Touch [LIST](D) to display the “MEMORY LIST” screen.
- ⑦ Push [QUICK](D), and then touch [Edit Name] to enter the “MEMORY NAME” screen (Memory name edit screen).
 - A cursor appears and blinks.
 - If the channel you selected is a blank channel, [Edit Name] does not appear.
- ⑧ Touch the desired block one or more times to select the desired character or symbol.

Selectable characters and symbols
A to Z, a to z, 0 to 9, ! # \$ % & \ ? ' ` ^ + - * / . , ; = < > () [] { } _ ` @ (space)

- Touch “AB↔12” to toggle between the Alphabet input and Number input mode.
- Touch [CLR](D) to delete the selected character, symbol or number.
- Touch [SYMB](D) to open the Symbol character selection window.
- Touch “_” to input a space.

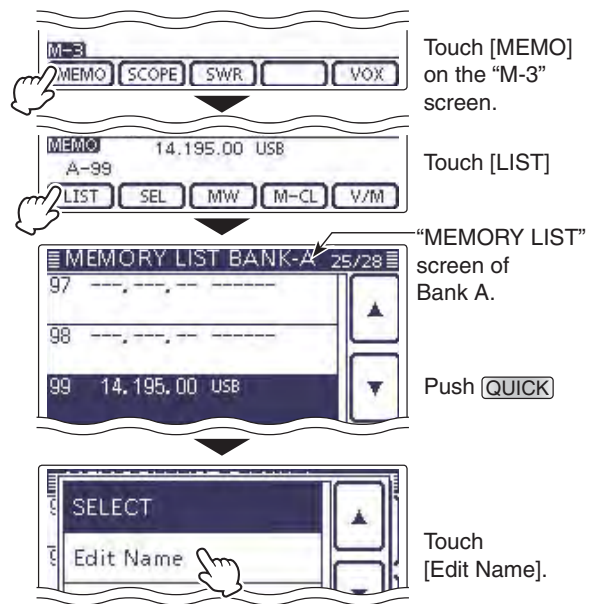
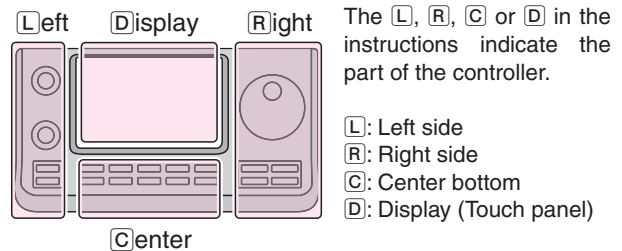

Memory name edit screen

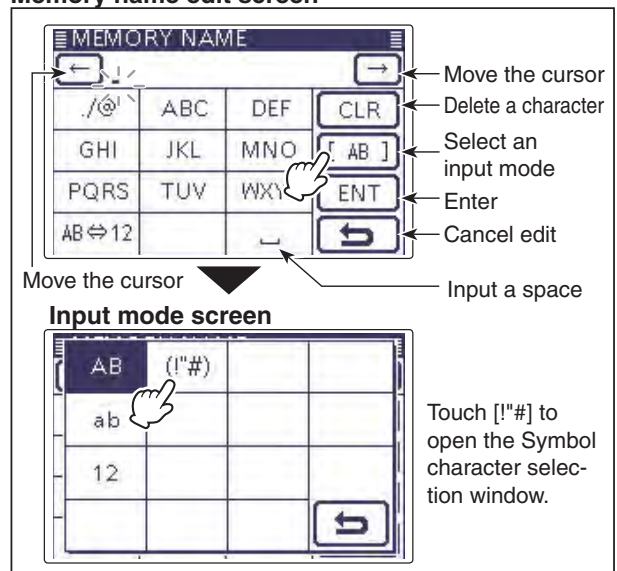

Continued on the next page.

11 MEMORY OPERATION

Memory name programming (Continued)

- ⑨ Touch [←](D) to move the cursor backwards, or touch [→](D) to move the cursor forwards.
- ⑩ Repeat steps ⑧ and ⑨ to program up to 16 characters memory name, and then touch [ENT](D) to save the name, and return to the “MEMORY LIST” screen.
- ⑪ Touch [↵](D) to return to the “MEMO” (Memory) screen.
 - Push [MENU](C) to return to the “M-3” screen (Menu 3).

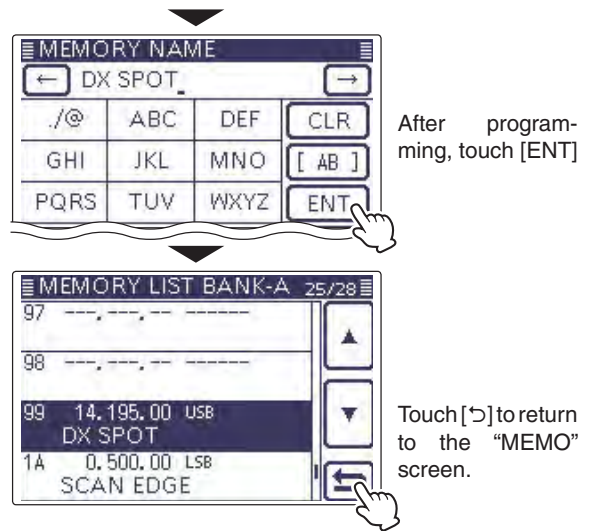

11 MEMORY OPERATION

Selecting a Memory display type

While in the memory mode, the programmed memory name can be displayed.

- ① Touch the Memory channel number indication once or twice to select the Memory mode. (p. ??-??)
- ② Push **QUICK**(D) to open the Quick Menu window.
- ③ Touch [Name Display].
- ④ Touch the desired Display type option.
 - OFF: Displays only the frequency.
 - ON: Displays the memory name under the frequency. (Default)

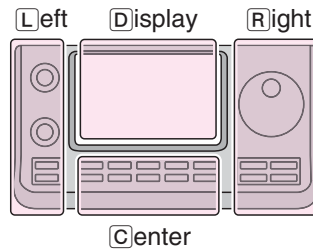

The L, R, C or D in the instructions indicate the part of the controller.

- L: Left side
- R: Right side
- C: Center bottom
- D: Display (Touch panel)

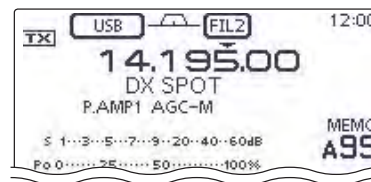

Push **QUICK**.

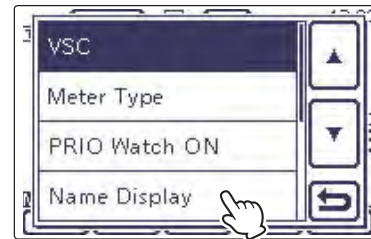

Touch [Name Display].



Touch "ON."

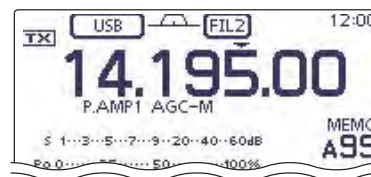

The memory name disappears.

11 MEMORY OPERATION

Memo pad function

The transceiver has a Memo pad function to store the displayed content for easy writing and recalling. The Memo pads are separate from the Memory channels. The default number of Memo pads is 5. However, you can increase the number to 10 in the “Memopad Numbers” item of the Set mode, if desired. (p. ??-??)

Memo pads are convenient when you want to memorize the displayed content temporarily, such as when you find a DX station in a pile-up, or when a desired station is busy for a long time and you want to temporarily search for other stations. Use the transceiver’s Memo pads instead of relying on hastily scribbled notes that are easily misplaced.

◇ Writing the displayed contents into the Memo pads

You can store the displayed content by pushing **[MPAD]** **(R)**.

When you store content of the 6th Memo pad, the oldest stored content is automatically erased, to make room for the new content.

NOTE: Each Memo pad must have its own unique content; Memo pads having identical content cannot be written.

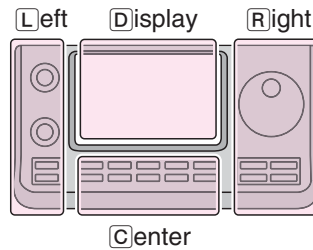

The **L**, **R**, **C** or **D** in the instructions indicate the part of the controller.

- L**: Left side
- R**: Right side
- C**: Center bottom
- D**: Display (Touch panel)

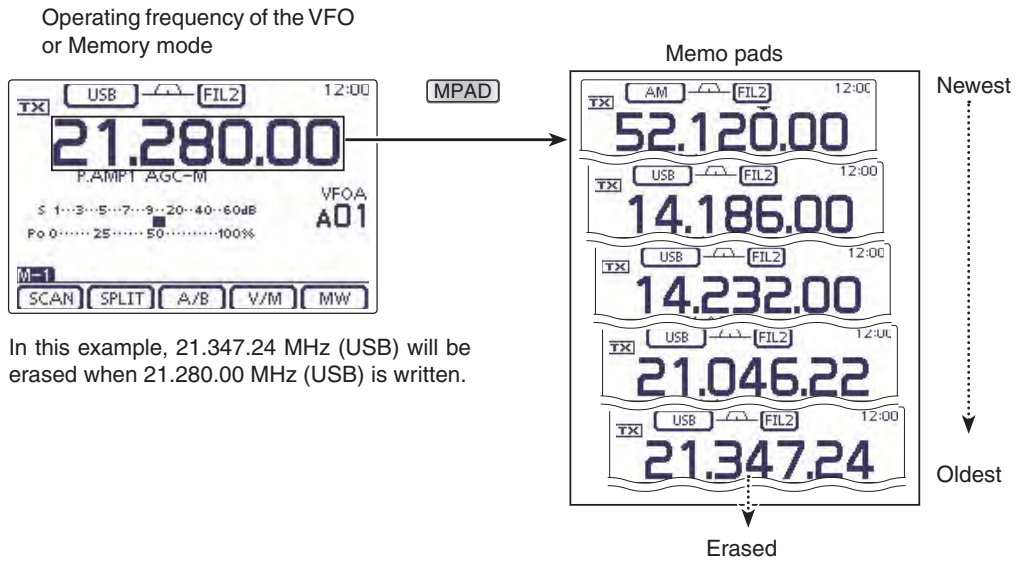

11 MEMORY OPERATION

Memo pad function (Continued)

◇ Calling up the Memo pads

You can call up a Memo pad by pushing **[MPAD](R)** one or more times while in either the VFO or Memory mode.

- The Memo pad content is called up, starting from the most recently written.

When you call up a Memo pad, the previously displayed content is automatically stored in a temporary pad. The temporary pad can be recalled by pushing **[MPAD](R)** one or more times.

- You may think there are 6 Memo pads because 6 different frequencies (5 are in Memo pads and 1 is in the temporary pad) are called up by **[MPAD](R)**.

▨ If you change the contents called up from a Memo pad, the stored temporary pad content is replaced with the changed content.

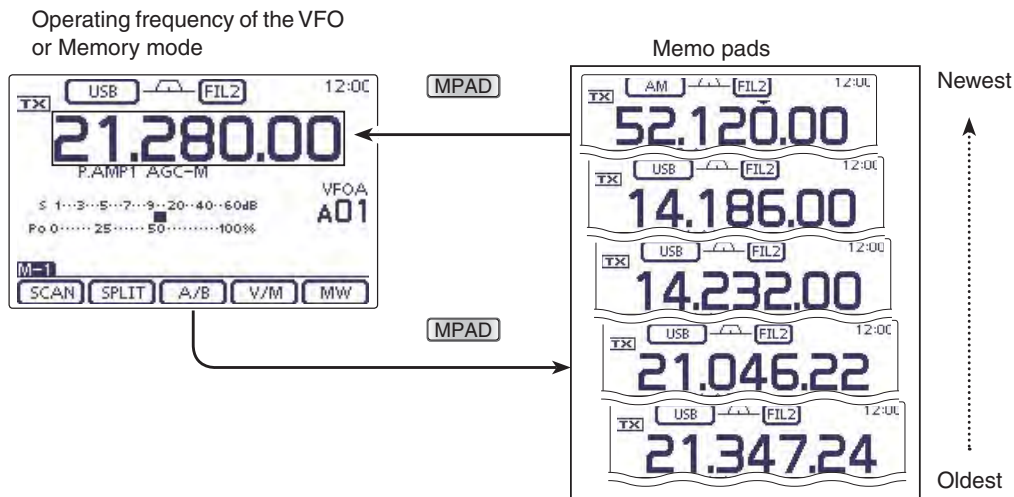

Section 12 SCAN OPERATION

- Scan types..... 12-2**
- Preparation..... 12-3**
- Scan Set mode..... 12-4**
- Voice Squelch Control function 12-6**
- Scan edge programming 12-7**
- Programmed scan (VFO mode)..... 12-8**
- Fine programmed scan (VFO mode)..... 12-9**
- Memory scan (Memory mode)..... 12-10**
 - ◇ Memory scan.....12-10
 - ◇ Mode Select scan.....12-11
 - ◇ Select Memory scan.....12-12
 - ◇ Setting/Cancelling Select Memory channels.....12-13
- ΔF scan and Fine ΔF scan (VFO mode/Memory mode)..... 12-14**
 - ◇ About the ΔF scan12-14
 - ◇ About the Fine ΔF scan12-15
- VFO frequency and a priority channel..... 12-16**
- DR mode and a priority channel 12-17**

12 SCAN OPERATION

Scan types

Scanning automatically searches for signals and makes it easier to locate new stations for contact or listening purposes. The IC-7100 has several scan types; Programmed scan, Memory scan, Select Memory scan, Mode Select scan and ΔF (Delta Frequency) scan.

Rotating the Dial changes the scanning direction as the default. The Dial functions during a scan can be set in the Scan Set mode. (p. ??-??)

PROGRAMMED SCAN (p. ??-??)
 Repeatedly scans between scan edges. P1 scans between 1A and 1B, P2 scans between 2A and 2B, and P3 scans between 3A and 3B frequencies. This scan operates in the VFO mode.

MEMORY SCAN (p. ??-??)
 Repeatedly scans all programmed Memory channels. This scan operates in the Memory mode.

MODE SELECT SCAN (p. ??-??)
 Repeatedly scans all selected Memory mode channels. This scan operates in the Memory mode.

SELECT MEMORY SCAN (p. ??-??)
 Repeatedly scans all Select Memory channels. This scan operates in the Memory mode.

ΔF SCAN (p. ??-??)
 Repeatedly scans within the ΔF span area. This scan operates in both VFO and Memory modes.

PRIORITY SCAN (p. ??-??)
 Checks the selected priority channel every 5 seconds:

- While receiving on a VFO frequency
- During a VFO mode scan for the VFO mode
- While receiving on a repeater in the DR mode
- During a DR mode scan for the DR mode

This scan operates in the VFO or DR mode.

A Memory channel, Call channel or Program Scan Edge channel can be selected as the priority channel.

A VFO frequency, Memory channel, Call channel or Program Scan Edge channel can be selected as the priority channel.

12 SCAN OPERATION

Preparation

For a Programmed scan:

Program scan edge frequencies into Program Scan Edge channels “1A–3A” and “1B–3B.” (p. ??-??)

For a Memory scan:

Program two or more Memory channels. (Program Scan Edge channels will not be scanned.) (p. ??-??)

For a Mode Select scan:

Program two or more Memory channels, all with the same operating mode. (p. ??-??)

For a Select Memory scan:

Program two or more Memory channels as Select Memory channels. (p. ??-??)

For a ΔF scan:

Set the ΔF span (ΔF scan range) in the “SCAN” screen. (p. ??-??)

• Scan Resume function

You can set the scan to resume or cancel when detecting a signal in the Scan Set mode. The Scan Resume function must be set before starting a scan. (p. ??-??)

• Scan speed

The scan speed can be set to fast or slow in the Scan Set mode. (p. ??-??)

• Dial function

How the Dial functions during a scan, can be set in the Scan Set mode. (p. ??-??)

• Squelch status

○ The scan starts with the squelch open

For a programmed scan:

When the tuning step is 1 kHz or less:

The scan continues until it is manually stopped— it does not pause*, even if signals are detected.

* The scan is paused when the squelch is closed and then opened. The scan resumes, or is cancelled, depending on the Scan Resume setting.

When the tuning step is 5 kHz or more:

If Scan Resume is ON, the scan pauses on each step when a signal is detected, then resumes.

If the Scan Resume is OFF, the scan does not start.

For memory scan:

If Scan Resume is ON, the scan pauses on each channel when a signal is detected, then resumes.

If Scan Resume is OFF, the scan does not start.

○ The scan starts with the squelch closed

The scan pauses when a signal is detected. The scan resumes, or is cancelled, depending on the Scan Resume setting.

12 SCAN OPERATION

Scan Set mode

The Scan speed, Scan Resume function, Pause Timer, Resume Timer and the Dial function can be set in the Scan Set mode.

- ① Push **MENU**(C) one or more times to select the “M-1” (Menu 1) screen.
- ② Touch **[SCAN]**(D) to display the “SCAN” screen.
- ③ Touch **[SET]**(D) to display the “SCAN SET” screen.
- ④ Touch the desired item.
 - To go back the previous tree level, touch **[>]**(D), or **MENU**(C).
- ⑤ Touch a desired option shown on the display.
 - When you touch an option, it is automatically saved and goes back the previous tree level.
 - Push **QUICK**(C), and then touch “Default” to reset to the default setting, if desired.
- ⑥ Push **MENU**(C) to return to the “SCAN” screen.

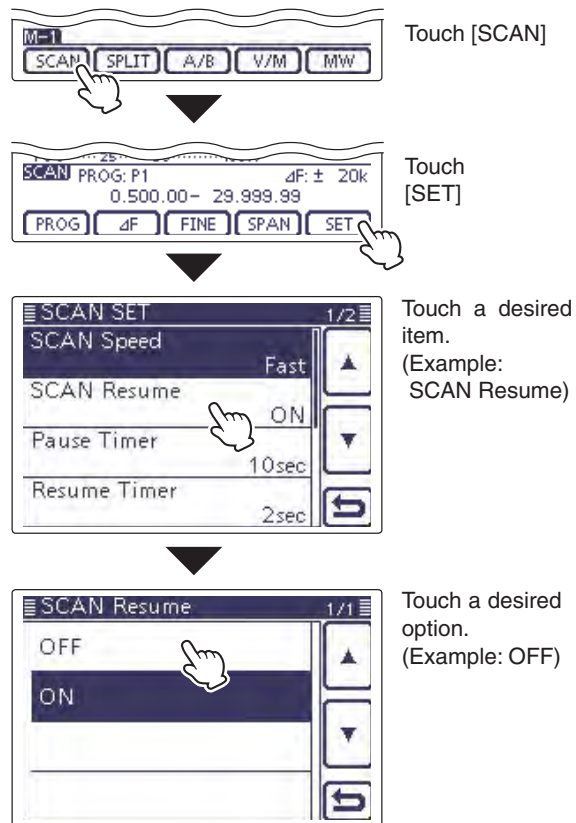
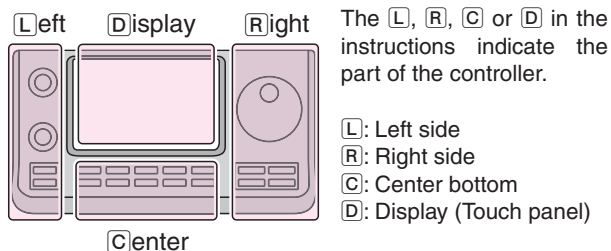

12 SCAN OPERATION

Scan Set mode (Continued)

SCAN Speed (Default: Fast)

Select the desired scan speed between slow and fast.

- Slow: The scan is slower.
- Fast: The scan is faster.

SCAN Resume (Default: ON)

Set the Scan Resume function ON or OFF.

- OFF: When a signal is detected, the scan is cancelled.
- ON: When a signal is received during a scan, the scan pauses for the set period of time in the "Pause Timer" setting, and then resumes. When the signal disappears, the scan resumes after the set period of time in the "Resume Timer" setting.

Pause Timer (Default: 10 sec)

Select the scan Pause Timer.

When a signal is received, the scan pauses according to this setting.

When the "Resume Timer" is set to "0 sec," this setting is invalid.

- 2 to 20 sec: When a signal disappears while pausing the scan for 2 to 20 seconds (in 2 seconds steps), the scan resumes according to the setting in the Resume Timer.
- Hold: When receiving a signal, the scan pauses and resumes when it disappears, according to the setting in Resume Timer.

Resume Timer (Default: ON)

Select the scan Resume Timer.

When a received signal disappears, the scan resumes according to this setting.

- 0 sec: The scan resumes immediately after the signal disappears.
- 1 to 5 sec: The scan resumes 1 to 5 seconds after the signal disappears.
- Hold: The scan remains paused according to the Pause Timer, even if the signal disappears.
 - Rotate the Dial to resume the scan.
 - When "Pause Timer" is set to 2 to 20 seconds, the scan resumes, according to the "Pause Timer" setting.

MAIN DIAL (SCAN) (Default: Up/Down)

Select the function of the Dial while scanning.

- OFF : Rotating the Dial cancels the scan.
- Up/Down : Rotating the Dial changes the scanning direction.

12 SCAN OPERATION

Voice Squelch Control function

(Mode: SSB/AM/FM)

This function is useful when you do not want unmodulated signals pausing or cancelling a scan. When the Voice Squelch Control (VSC) function is ON, the receiver checks received signals for voice components.

The scan pauses, or is cancelled, if a received signal includes voice components, and the tone of the voice components changes within 1 second. See “Squelch status” as described on page ??-??.

The scan resumes if the received signal includes no voice components, or the tone of the voice components does not change within 1 second.

- ① Select SSB, AM or FM as the operating mode.
- ② Push **QUICK**(D) to open the Quick Menu window.
- ③ Touch **[VSC]**.
- ④ Touch the desired option.
 - “**VSC**” appears when the VSC function is ON.
 - When you touch an option, it is automatically saved and goes back the previous tree level.

- ▨ The VSC function is usable in the phone modes (SSB, AM and FM).
- ▨ The VSC function resumes the scan on unmodulated signals, regardless of whether the Scan Resume function is set to ON or OFF.

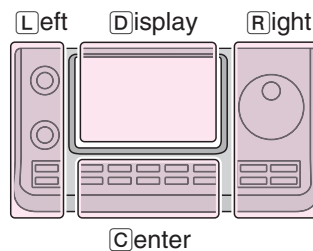
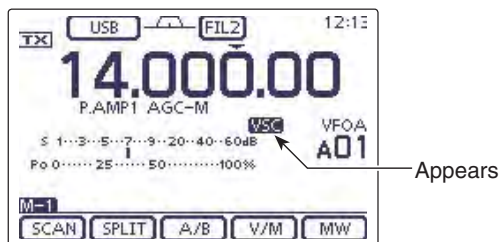

The **L**, **R**, **C** or **D** in the instructions indicate the part of the controller.

- L**: Left side
- R**: Right side
- C**: Center bottom
- D**: Display (Touch panel)

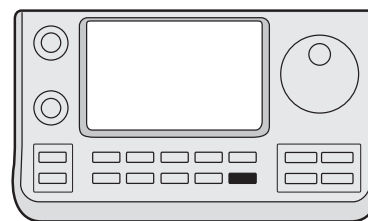

Touch **[VSC]**.

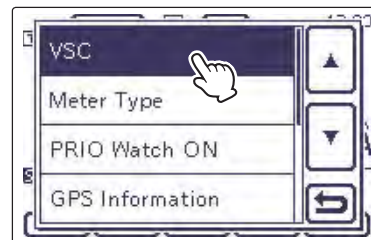

Touch a desired option.
(Example: ON)



▨ **NOTE:** While listening to the radio with the VSC function ON, the audio may be interrupted. The music or a commercial, including narration or BGM, is not detected as an audio component. In this case, turn OFF the VSC function.

12 SCAN OPERATION

Scan edge programming

Memory channels 1A–3A and 1B–3B are the Program Scan Edge channels. They are used to program the upper and lower frequency edges for programmed scans. (p. ??-??)

Factory default frequency and operating modes are programmed into the Scan Edge channels: 1A/1B are for HF, 2A/2B are for the 144 MHz, and 3A/3B are for the 430 MHz frequency bands, and you can reprogram it as desired.

▨ If both upper and lower band edges are programmed with the same frequency, a programmed scan cannot start.

EXAMPLE: Programming 14.000.00 MHz into 2A and 14.360.00 MHz into 2B.

- ① Touch the Memory channel number indication once or twice to select the VFO mode. (p. ??-??)
- ② Rotate [M-CH] ● (L) to select scan edge 2A.
- ③ Set 14.000.00 MHz as the lower frequency.
- ④ Push [MENU] (C) one or more times to select the “M-1” (Menu 1) screen.
- ⑤ Touch [MW] (D) for 1 second to program 14.000.00 MHz into scan edge 2A.
 - Three beeps sound when the programming is complete.
- ⑥ Rotate [M-CH] ● (L) to select scan edge 2B.
- ⑦ Set 14.360.00 MHz as the upper frequency.
- ⑧ Touch [MW] for 1 second to program 14.360.00 MHz into scan edge 2B.
 - Three beeps sound when the programming is complete.
- ⑨ If 2A/2B is selected as the scanning range when a programmed scan is started, it will search for signals between 14.000.00 MHz and 14.360.00 MHz. (p. ??-??)

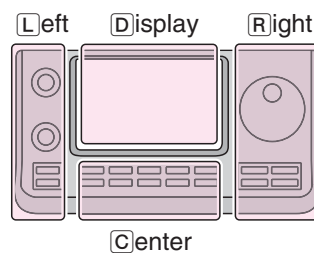

The L, R, C or D in the instructions indicate the part of the controller.

- L: Left side
- R: Right side
- C: Center bottom
- D: Display (Touch panel)

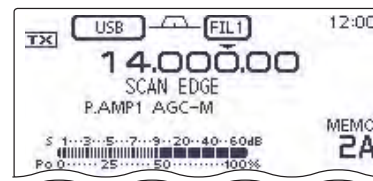
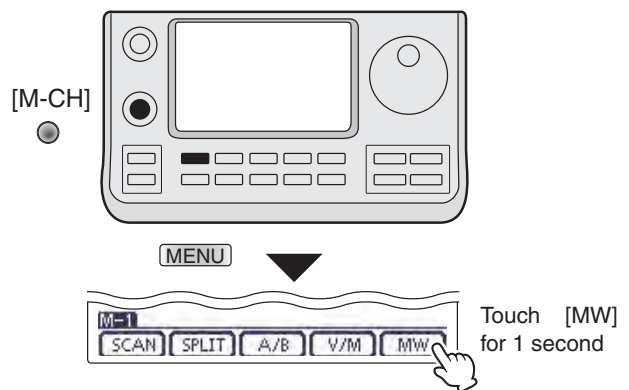

Programming 14.000.00 MHz/USB into 2A.

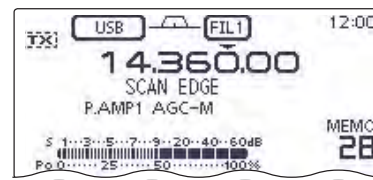

Programming 14.360.00 MHz/USB into 2B.

12 SCAN OPERATION

Programmed scan (VFO mode)

A programmed scan searches for signals between Program Scan Edge channels “1A–3A” and “1B–3B.” Before starting the programmed scan, scan edges must be programmed into these channels. See the previous page for scan edge programming.

▨ If the same frequencies are programmed into the Program Scan Edge channels, the programmed scan will not start.

- ① Touch the Memory channel number indication once or twice to select the VFO mode. (p. ??-??)
- ② Touch the mode icon to display the Mode selection screen, and then touch the desired operating mode.
 - The operating mode can also be changed while scanning.
- ③ Touch the frequency ‘kHz’ area on the display for 1 second to display the Tuning step selection screen, and then touch the desired tuning step. (p. ??-??)
 - The tuning step can also be changed while scanning.
- ④ Push **MENU**(C) one or more times to select the “M-1” (Menu 1) screen.
- ⑤ Touch **[SCAN]**(D) to display the “SCAN” screen.
- ⑥ Set **[RF/SQ]** open or closed.
 - The scan performance differs, depending on the squelch setting when the scan was started. See page ??-?? for details.
 - If the **[RF/SQ]** control function is set to “AUTO,” the squelch is always open in the SSB, CW and RTTY modes. (pp. ??-??, ??-??)
- ⑦ Touch **[PROG]**(D) for 1 second, and then touch the desired scan range between “P1,” “P2” and “P3.”
 - The scan searches between programmed scan channels 1A–1B (P1), 2A–2B (P2) or 3A–3B (P3).
 - Example: P2: 14.000.00–14.360.00
- ⑧ Touch **[PROG]**(D) to start the programmed scan.
 - The MHz and kHz decimal points, and the selected scan range display blink while scanning.
 - If “Up/Down” is selected as the “MAIN DIAL (SCAN)” option in the Scan Set mode, rotating the Dial changes the scanning direction. (p. ??-??)
- ⑨ When the scan detects a signal, the scan stops, pauses or ignores it, depending on the Scan Resume function, the VSC function or the squelch status.
- ⑩ Push **[PROG]**(D) to cancel the scan.

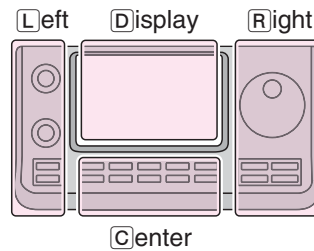

The L, R, C or D in the instructions indicate the part of the controller.

- L: Left side
- R: Right side
- C: Center bottom
- D: Display (Touch panel)

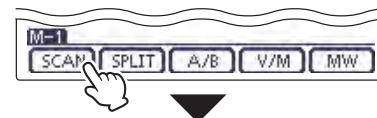

Touch **[SCAN]**

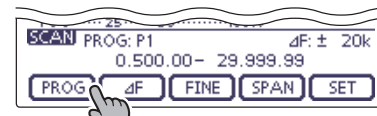

Touch **[PROG]** for 1 second.

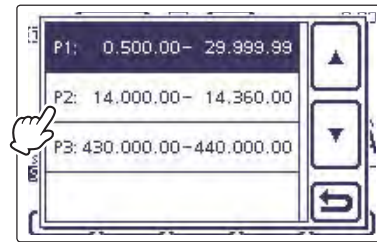

Touch the desired scan range (Example: P2)

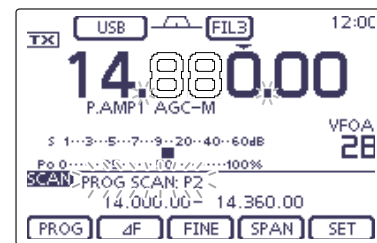

While Programmed scanning

12 SCAN OPERATION

Fine programmed scan (VFO mode)

When a signal is received during a Fine programmed scan, the scanning tuning step is temporarily set to 10 Hz and the scan speed decreases.

- ① Start the programmed scan.
 - Follow steps ① through ⑧ as described on page ??-??.
- ② While scanning, touch [FINE](D) to switch the scan function between a programmed scan and a Fine programmed scan.
- ③ Touch [PROG](D) to cancel the scan.

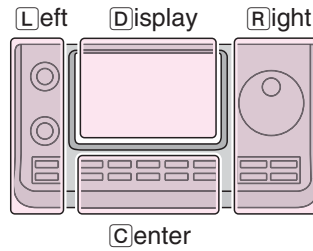

The L, R, C or D in the instructions indicate the part of the controller.

- L: Left side
- R: Right side
- C: Center bottom
- D: Display (Touch panel)

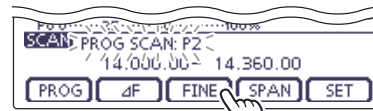

Touch [FINE].

While Programmed scanning

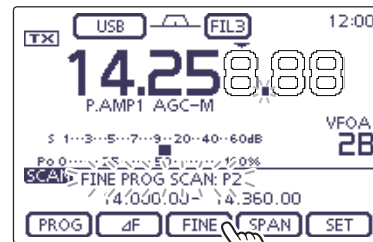

Touch [FINE].

While Fine programmed scanning

12 SCAN OPERATION

Memory scan (Memory mode)

◇ Memory scan

A Memory scan searches for signals through Memory channels 1 to 99.

Blank (unprogrammed) Memory channels are skipped.

NOTE: For a Memory scan to start, two or more Memory channels must be programmed. (p. ??-??)

- ① Touch the Memory channel number indication once or twice to select the Memory mode. (p. ??-??)
- ② Push **MENU**(C) one or more times to select the “M-1” (Menu 1) screen.
- ③ Touch **[SCAN]**(D) to display the “SCAN” screen.
- ④ Set **[RF/SQL]** open or closed.
 - The scan performance differs, depending on the squelch setting when the scan was started. See page 146 for details.
 - If the **[RF/SQL]** control function is set to “AUTO,” the squelch is always open in the SSB, CW and RTTY modes. (pp. ??-??, ??-??)
- ⑤ Touch **[MEMO]**(D) to start the Memory scan.
 - The MHz and kHz decimal points, and “MEMO SCAN” blink while scanning.
 - If “Up/Down” is selected as the “MAIN DIAL (SCAN)” option in the Scan Set mode, rotating the Dial changes the scanning direction. (p. ??)
- ⑥ Touch **[MEMO]**(D) to cancel the scan.

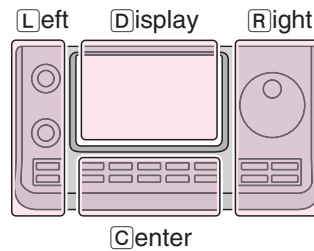

The L, R, C or D in the instructions indicate the part of the controller.

- L: Left side
- R: Right side
- C: Center bottom
- D: Display (Touch panel)

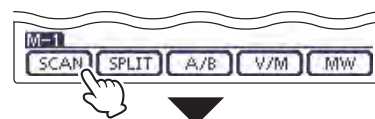

Touch [SCAN]

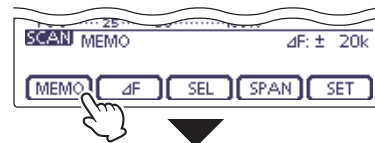

Touch [MEMO]

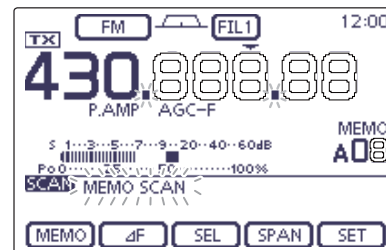

While Memory scanning

12 SCAN OPERATION

Memory scan (Memory mode) (Continued)

◇ Mode Select scan

Repeatedly scans all Memory channels with the same operating mode as the displayed mode.

NOTE: For a Mode Select scan to start, two or more Memory channels must be programmed, and their operating mode must be the same as the displayed mode.

- ① Follow steps ① through ③ as described above to display the "SCAN" screen.
- ② Touch [MEMO] (D) for 1 second, and then touch "MODE-SEL" to start the Mode Select scan.
 - The MHz and kHz decimal points, and "MODE-SEL SCAN" blink while scanning.
 - If "Up/Down" is selected as the "MAIN DIAL (SCAN)" option in the Scan Set mode, rotating the Dial changes the scanning direction. (p. ??-??)
- ③ To change the operating mode while scanning, touch the mode icon to display the Mode selection screen, and then touch the desired operating mode.
- ④ Push [MEMO] (D) to cancel the scan.

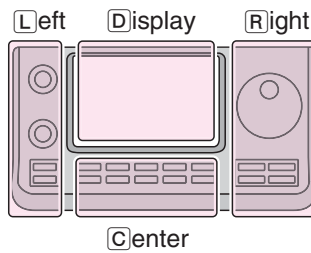

The L, R, C or D in the instructions indicate the part of the controller.

- L: Left side
- R: Right side
- C: Center bottom
- D: Display (Touch panel)

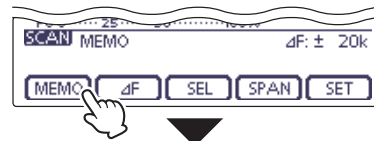

Touch [MEMO] for 1 second

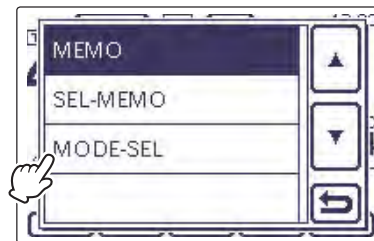

Touch "MODE-SEL."



Touch the mode icon, and then touch the desired operating mode

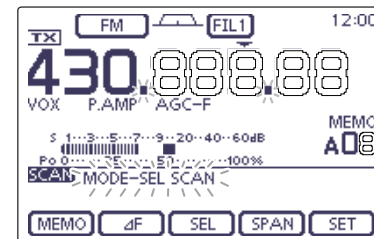

While Mode Select scanning

12 SCAN OPERATION

Memory scan (Memory mode) (Continued)

◆ Select Memory scan

The Select Memory scan searches for signals through Memory channels specified as “★” (Select).

NOTE: For a Select Memory scan to start, two or more Memory channels must be designated as Select Memory channels. (See below)

- ① Follow steps ① through ③ as described on the page ??-?? to display the “SCAN” screen.
- ② Touch [MEMO](D) for 1 second, and then touch “SEL-MEMO” to start the Select Memory scan.
 - The MHz and kHz decimal points, and “SEL-MEMO SCAN” blink while scanning.
 - If “Up/Down” is selected as the “MAIN DIAL (SCAN)” option in the Scan Set mode, rotating the Dial changes the scanning direction. (p. ??-??)
- ③ Push [MEMO](D) to cancel the scan.

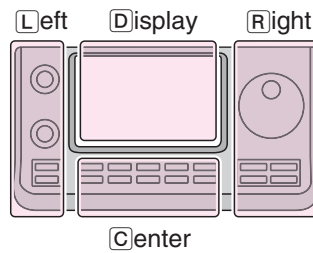

The L, R, C or D in the instructions indicate the part of the controller.

- L: Left side
- R: Right side
- C: Center bottom
- D: Display (Touch panel)

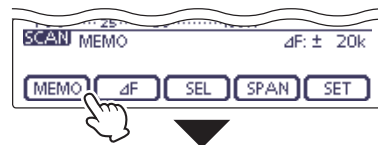

Touch [MEMO] for 1 second.

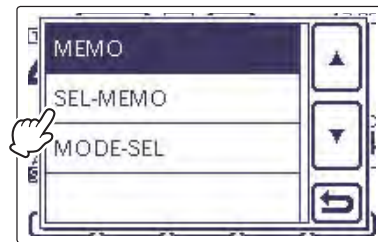

Touch “SEL-MEMO.”

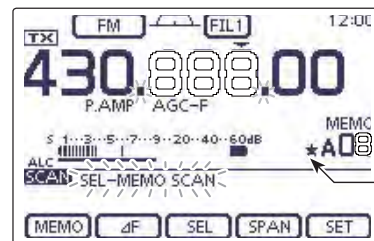

Appears

While Select Memory scanning

12 SCAN OPERATION

Memory scan (Memory mode) (Continued)

◇ Setting/Cancelling Select Memory channels

All Memory channels can be set as Select Memory channels, except for the Scan Edge and Call channels.

- When the “SCAN” screen or the “MEMO” screen (Memory Menu) is displayed, touch [SEL] to set or cancel the displayed Memory channel as a Select Memory channel.
 - “★” appears when the channel is set as a Select Memory channel.
 - An error beep sounds when the displayed Memory channel is a blank channel.
 - Touching [SEL] for 1 second displays “SELECT ALL Clear?” Touch [YES](F-4) to clear all Select Memory channel settings.

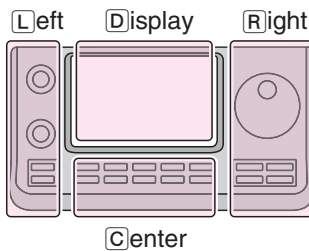

The L, R, C or D in the instructions indicate the part of the controller.

- L: Left side
- R: Right side
- C: Center bottom
- D: Display (Touch panel)

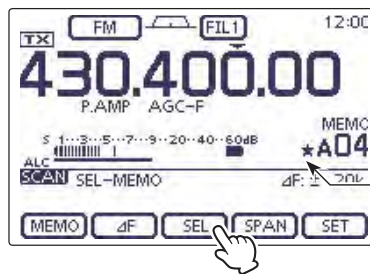

Appears

“SCAN” screen
When the channel is set as a Select Memory channel.

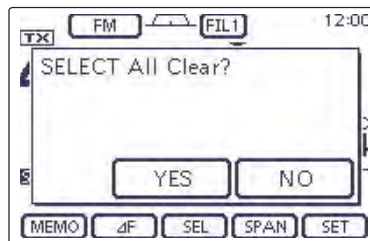

“SELECT ALL Clear?” screen
After touching [SEL] for 1 second to clear all Select Memory channel settings.

12 SCAN OPERATION

ΔF scan and Fine ΔF scan (VFO mode/Memory mode)

◆ About the ΔF scan

ΔF (Delta Frequency) scan searches for signals within the specified range with the displayed VFO frequency or Memory channel frequency as the center frequency. The frequency range is specified by the width of the selected span.

- ① Touch the Memory channel number indication once or twice to select the VFO mode or Memory mode. (p. ??-??)
- ② Push **MENU**(C) one or more times to select the “M-1” (Menu 1) screen.
- ③ Touch **[SCAN]**(D) to display the “SCAN” screen.
- ④ Set **[RF/SQL]** open or closed.
 - The scan performance differs, depending on the squelch setting when the scan was started. See page 146 for details.
 - If the **[RF/SQL]** control function is set to “AUTO,” the squelch is always open in the SSB, CW and RTTY modes. (pp. ??-??, ??-??)
- ⑤ Touch **[SPAN]**(D) one or more times to select the desired ΔF span width.
 - ± 5 kHz, ± 10 kHz, ± 20 kHz, ± 50 kHz, ± 100 kHz, ± 500 kHz and ± 1 MHz are selectable.
- ⑥ Set the center frequency of the ΔF scan.
 - In the VFO mode, rotate the Dial to set the center frequency.
 - In the memory mode, rotate **[M-CH]**(L) to select the desired Memory channel whose frequency will be the center frequency.
- ⑦ Touch **[ΔF]**(D) to start the ΔF scan.
 - “ ΔF SCAN,” the MHz and kHz decimal points blink while scanning.
 - If “Up/Down” is selected as the “MAIN DIAL (SCAN)” option in the Scan Set mode, rotating the Dial changes the scanning direction. (p. ??-??)
- ⑧ When the scan detects a signal, the scan stops, pauses or ignores it, depending on the Scan Resume function, VSC function or the squelch status.
- ⑨ Touch **[ΔF]**(D) again to cancel the ΔF scan.

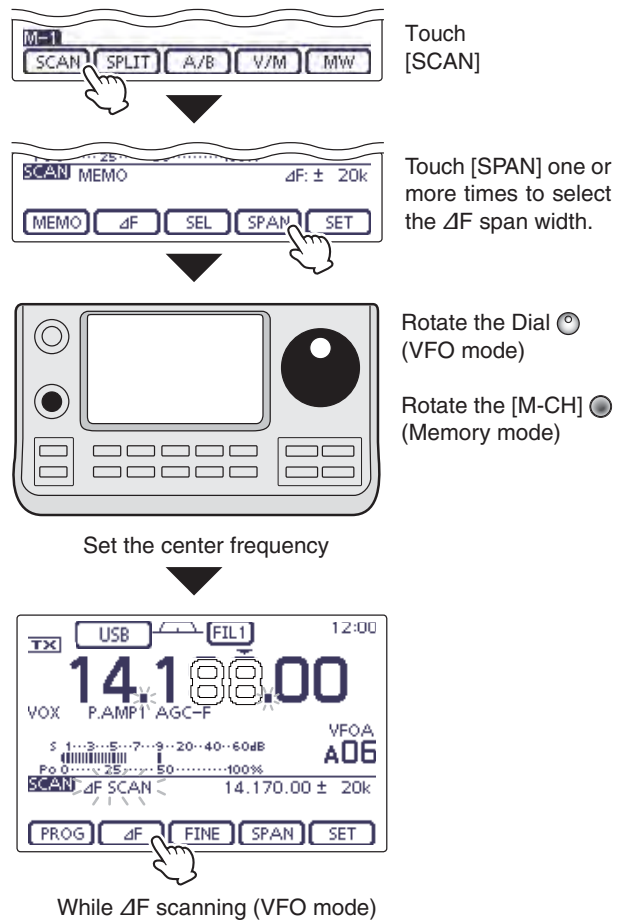
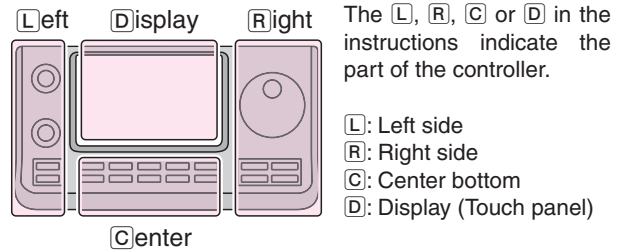

12 SCAN OPERATION

ΔF scan and Fine ΔF scan (VFO mode/Memory mode) (Continued)

◆ About the Fine ΔF scan

When a signal is received during a Fine ΔF scan, the scanning tuning step is temporarily set to 10 Hz and the scan speed decreases.

- ① Start ΔF scan.
 - Follow steps ① through ⑦ as described on page ??-??.
- ② While scanning, touch [FINE](D) to switch the scan function between ΔF scan and Fine ΔF scan.
- ③ Touch [ΔF](D) to cancel the scan.

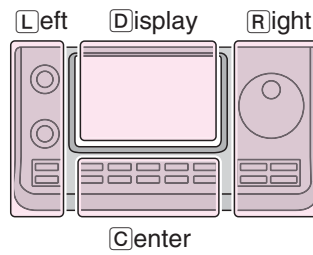

The L, R, C or D in the instructions indicate the part of the controller.

- L: Left side
- R: Right side
- C: Center bottom
- D: Display (Touch panel)

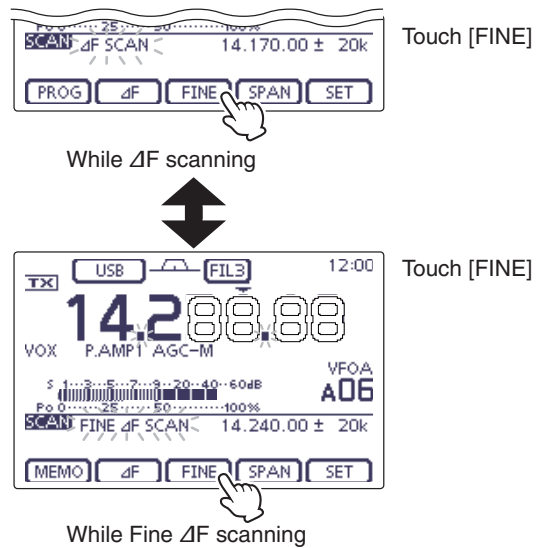

12 SCAN OPERATION

VFO frequency and a priority channel

Checks the selected priority channel every 5 seconds, while receiving on a VFO frequency.

- ① Touch the Memory channel number indication once or twice to select the VFO mode. (p. ??-??)
- ② Set the receive frequency and the operating mode. (p. ??-??)
- ③ Touch the Memory channel number indication to select the Memory mode. (p. ??-??)
- ④ Rotate [BANK] or [M-CH] (L) to set the priority channel.
 - Memory channel, Call channel or Program Scan Edge channel can be selected as the priority channel.
- ⑤ Push QUICK (D) to open the Quick Menu window.
- ⑥ Touch "PRIO Watch ON" to start the Priority scan.
 - The VFO mode is automatically selected, and PRIO appears.
 - To cancel the Priority scan, touch "PRIO Watch OFF" in the Quick Menu window.

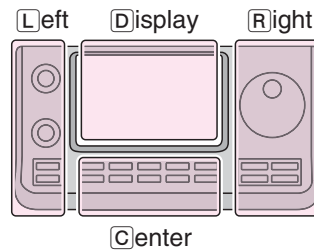

The L, R, C or D in the instructions indicate the part of the controller.

- L: Left side
- R: Right side
- C: Center bottom
- D: Display (Touch panel)

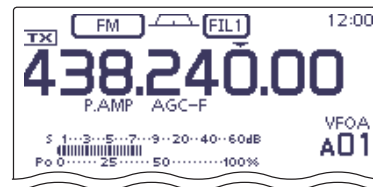

Select the VFO mode

The receive frequency and the operating mode setting

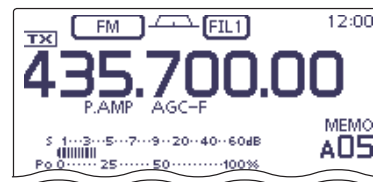

Select the Memory mode

Set the priority channel (Example: A05)

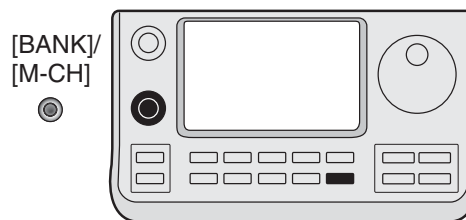

QUICK

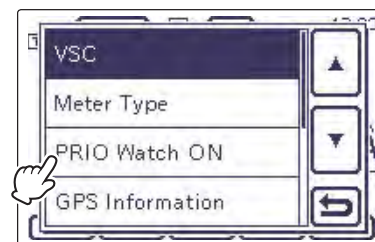

Touch "PRIO Watch ON"

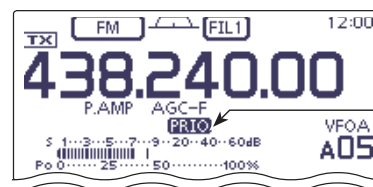

While Priority scanning

NOTE:

When the VFO mode is selected, you can normally operate the transceiver; the operating frequency setting, the scanning operation and so on.

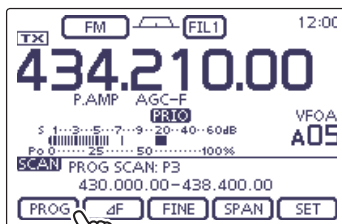

To start the Programmed scan during the Priority scan, touch [SCAN] in the "M-1" (Menu 1) screen, and then touch [PROG].

When a signal is received on the priority channel

The Priority channel is automatically selected, and PRIO blinks on the screen.

- The scan pause timer and resume settings are the same as for a normal scan.

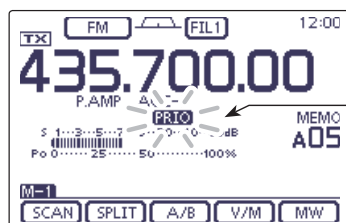

Priority scan automatically pauses.

12 SCAN OPERATION

DR mode and a priority channel

Checks the selected priority channel every 5 seconds, while receiving a repeater in the DR mode.

1. Set the priority channel

• Using the VFO frequency

- 1 Touch the Memory channel number indication once or twice to select the VFO mode. (p. ??-??)
- 2 Set the receive frequency and the operating mode. (p. ??-??)

• Using the Memory/Call/Program Scan Edge channel

- 1 Touch the Memory channel number indication once or twice to select the Memory mode. (p. ??-??)
- 2 Rotate [BANK] or [M-CH] (L) to set the priority channel.
 - Memory channel, Call channel or Program Scan Edge channel can be selected as the priority channel.

2. Select the repeater in the DR mode

- 1 Push **DR** (C) to select the DR mode. (p. ??-??)
- 2 Touch "FROM" (Access repeater), if "FROM" is not selected.
- 3 Rotate the Dial to select the desired repeater.
 - You can select a repeater in the "FROM SELECT" screen that is displayed after touching the repeater name on "FROM."

3. Start the Priority scan

- 1 Push **QUICK** (D) to open the Quick Menu window.
- 2 Touch "PRIO Watch ON" to start the Priority scan.
 - The DR mode screen is automatically selected, and **PRIO** appears.
 - To cancel the Priority scan, touch "PRIO Watch OFF" in the Quick Menu window.

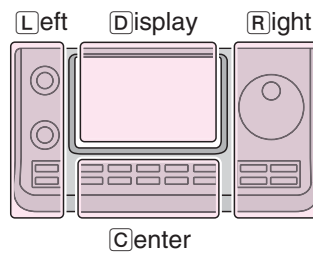

The L, R, C or D in the instructions indicate the part of the controller.

- L: Left side
- R: Right side
- C: Center bottom
- D: Display (Touch panel)

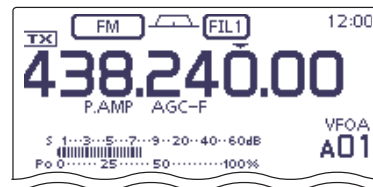

When the VFO frequency is set as the priority channel

The receive frequency and the operating mode setting

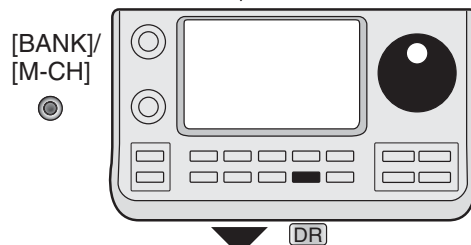

Set the receive frequency in the VFO mode.



Select the DR mode

Select the repeater to receive (Example: Hirano43)



Touch "PRIO Watch ON"

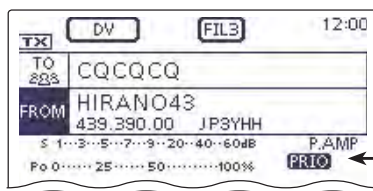

Appears while the priority scanning

12 SCAN OPERATION

DR mode and a priority channel (Continued)

NOTE:
 When the DR mode screen is displayed, you can normally use the DR mode; “FROM” (Access repeater)/“TO” (Destination) selection, the DR mode scanning and so on.

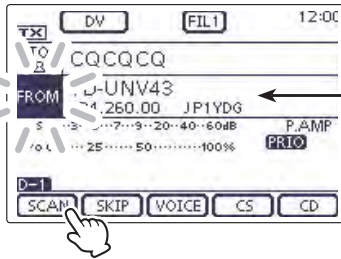

To start the DR mode scan, touch [SCAN] in the “D-1” screen.

When a signal is received on the priority channel
 The Priority channel is automatically selected, and **PRIO** blinks on the screen.

- The scan pause timer and resume settings are the same as for a normal scan.

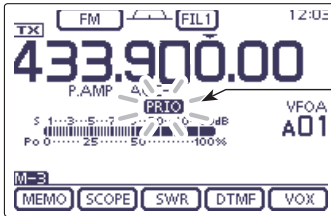

Priority scan automatically pauses.

Section 13 USING AN SD CARD

- About the SD card 13-2**
- Saving data onto the SD card..... 13-3**
- Inserting the SD card 13-4**
 - ◇ Formatting the SD card 13-4
- Removing the SD card 13-5**
 - ◇ Removing the SD card while the transceiver's power is ON . 13-5
- Saving the setting data onto an SD card..... 13-6**
- Saving with a different file name..... 13-7**
- Loading the saved data files that are on the SD card 13-8**
- Backing up the data stored on the SD card onto a PC 13-10**
 - ◇ About the SD card's folder contents 13-10
 - ◇ Making a backup file on your PC..... 13-11
- Updating the repeater list 13-12**
- Cloning Transceiver-to-Transceiver using an SD card..... 13-15**

13 USING AN SD CARD

About the SD card

The SD and SDHC cards are not available from Icom. Purchase locally.

An SD card of up to 2 GB or an SDHC of up to 32 GB, can be used with the IC-7100. Icom has checked the compatibility with the following SD and SDHC cards.

(As of March 2013)

Brand	Type	Memory size
SanDisk®	SD	2 GB
	SDHC	4 GB
		8 GB
		16 GB
		32 GB

- The above list does not guarantee the card's performance.
- Through the rest of this document, the SD card and an SDHC card are simply called SD cards.
- Icom recommends that you format all SD cards to be used with the IC-7100, even preformatted SD cards for PCs or other uses.

NOTE:

- Read the instructions of the SD card thoroughly before use.
- **NEVER** remove the SD card, detach the battery pack/case, or power OFF the transceiver, while reading or writing data to or from the SD card, or during cloning. It will cause the data to be corrupted or damage the card.
- **NEVER** drop, impact or apply vibration to the SD card. This will cause the data to be corrupted or damage the card.
- The SD card will get warm if used continuously for a long period of time.
- An SD card has a certain lifetime, so data reading or writing may not be possible when using it over a long time period.
- When reading or writing data is impossible, the SD card's lifetime has ended. In this case, purchase a new one. We recommend you make a backup file of the important data onto your PC.
- Icom will not be responsible for any damage caused by data corruption of an SD card.

- ▨ Saving the factory default data is recommended.
 - ➔ Insert the card into the transceiver's slot, and then push **SET**(**C**) to enter the Set mode.
 - Touch "SD Card," then "Save Setting" to save.

13 USING AN SD CARD

Saving data onto the SD card

The following data can be stored onto the card:

- **Data settings of the transceiver**

Memory channel contents, and repeater lists stored in the transceiver.

- **Communication contents**

The transmitted and received audio.

- **Communication log**

The communication and receive history log.

- **Automatic answering voice audio for the DV mode**

Voice audio to use with the Auto Reply function in the DV Mode.

- **Voice audio for the Voice TX function**



Voice audio to use with the Voice TX function.

- **RTTY decode log**

The transmitted or received RTTY decode history log.

13 USING AN SD CARD

Inserting the SD card

- ① Turn OFF the transceiver.
- ② Insert the card into the slot until it locks in place, and makes a 'click' sound.
 - “” appears when the SD card is inserted.
 - “” and “” alternately blink while accessing the SD card.

NOTE: Before inserting, be sure to check the card direction.
 If the card is forcibly or inversely inserted, it will damage the card and/or the slot.

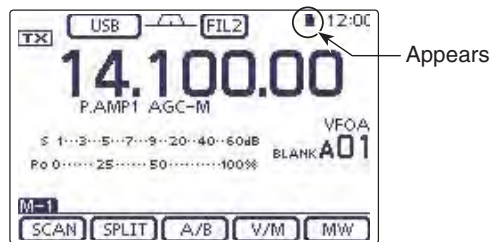
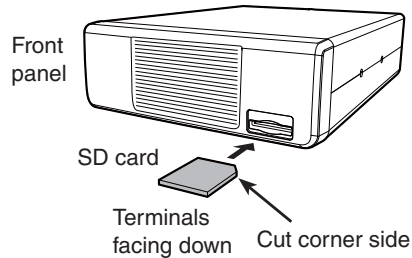

◆ Formatting the SD card

- If you use a brand new SD card, format it, by doing the following steps.
- **Formatting a card erases all its data.** Before formatting any programmed card, make a backup file onto your PC.

- ① Turn OFF the transceiver, and then insert the card into the slot.
- ② Turn ON the transceiver.
 - “” appears when the SD card is inserted.
- ③ Push **SET**(**C**) to enter the Set mode.
- ④ Touch the “SD Card” Set mode.
 - If the specified item is not displayed, touch [**▲**] or [**▼**](**D**) one or more times to select the page.
- ⑤ Touch the “Format” item.
 - The confirmation screen “Format OK?” appears.
- ⑥ Touch [**YES**](**D**).
 - The formatting starts and the display shows the formatting progress.
 - After formatting ends, the display automatically returns to the screen displayed before touching [**YES**](**D**).

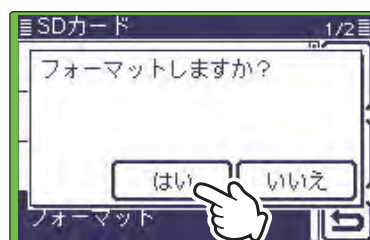
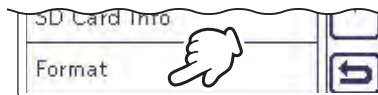
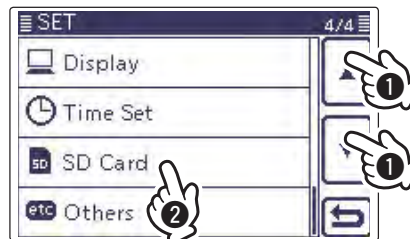
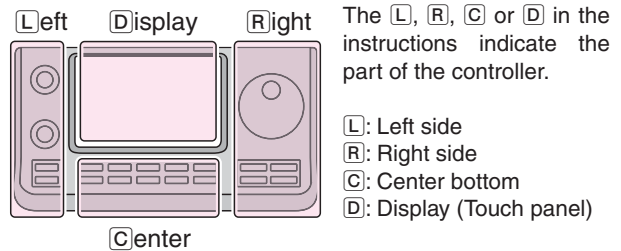

13 USING AN SD CARD

Removing the SD card

- ① Turn OFF the power.
- ② Push in the SD card until a click sounds, and then carefully pull it out.

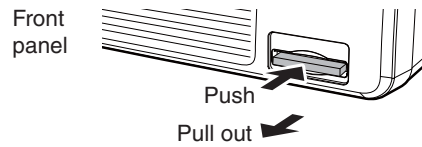

◇ Removing the SD card while the transceiver's power is ON

- ① Push **SET**(**C**) to enter the Set mode.
- ② Touch the "SD Card" Set mode.
 - If the specified item is not displayed, touch **[▲]** or **[▼]**(**D**) one or more times to select the page.
- ③ Touch the "Unmount" item.
 - The confirmation screen "Unmount OK?" appears.
- ④ Touch **[YES]**(**D**).
- ⑤ Push in the SD card until a click sounds, and then carefully pull it out.

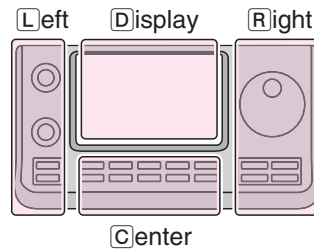

The **L**, **R**, **C** or **D** in the instructions indicate the part of the controller.

- L**: Left side
- R**: Right side
- C**: Center bottom
- D**: Display (Touch panel)

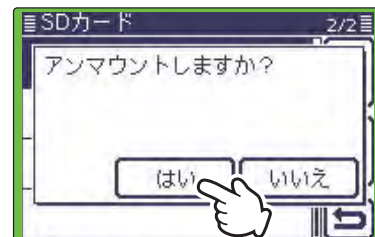
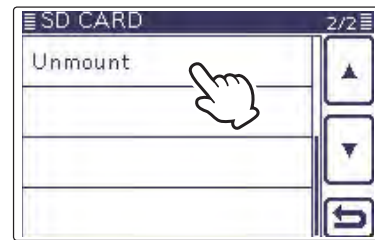
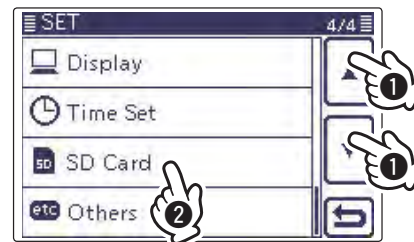

13 USING AN SD CARD

Saving the setting data onto an SD card

Memory channels, Set mode item settings, and repeater lists can be saved on the SD card.

Saving data settings on the SD card allows you to easily restore the transceiver to its previous settings, even if an All reset is performed.

✓ For your information

Data settings are saved in the “icf” file format that is used in the CS-7100 cloning software.

The saved data on the SD card can be copied onto a PC and edited by the cloning software.

Data settings can be saved as a new file or to overwrite an older file.

Saved as a new file

- ① Push **SET**(**C**) to enter the Set mode.
- ② Touch the “Save Setting” item of the “SD Card” Set mode.
(SD Card > **Save Setting**)
 - If the specified item is not displayed, touch **[▲]** or **[▼]**(**D**) one or more times to select the page.
- ③ Touch “<<New File>>.”
 - The “FILE NAME” screen appears.
 - The file name is automatically named in the following manner; Setyyyyymmdd_xx (yyyy: Year, mm: month, dd: day, xx: serial number)
Example: If a second file is saved on March 1, 2013, the file is named “Set20130301_02.”
 - If you want to change the file name, see “Save with a different file name” (p. ??-??).
- ④ Touch **[ENT]**(**D**) to save the file name.
• The confirmation screen “Save file?” appears.
- ⑤ Touch **[YES]**(**D**) to save.
• While saving, a progress bar is displayed, then the “SD CARD” screen is displayed after the save is completed.
- ⑥ Push **SET**(**C**) to exit the Set mode.

Overwriting a file

(**Example:** Overwriting the “Set20121210_01”)

➔ Select the desired file to be overwritten in step ③ as described on page ??-??.

(**Example:** Selecting “Set20121210_01”)

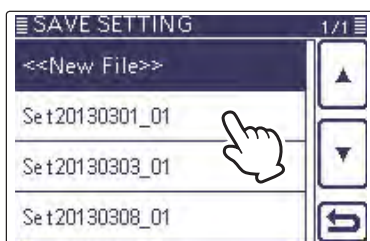
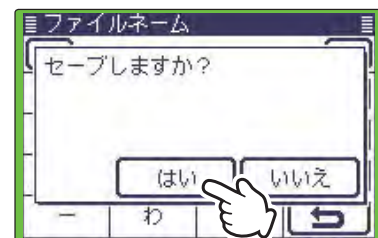
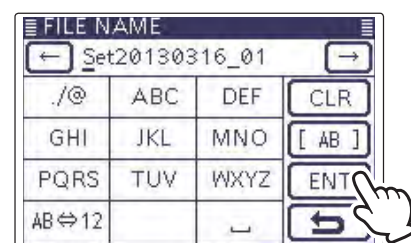
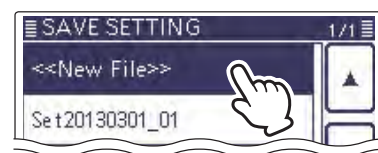
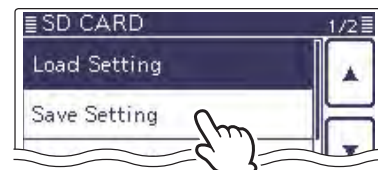
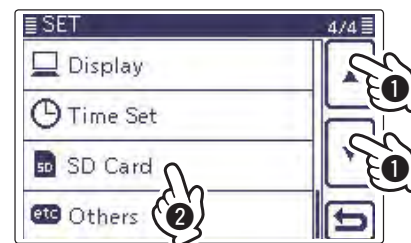
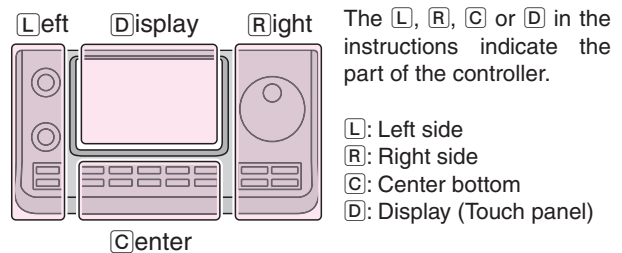

13 USING AN SD CARD

Saving with a different file name

- 1 Push **SET**(**C**) to enter the Set mode.
- 2 Touch the "Save Setting" item of the "SD Card" Set mode.

(SD Card > Save Setting)

- If the specified item is not displayed, touch **[▲]** or **[▼]**(**D**) one or more times to select the page.

- 3 Touch "<<New File>>."
 - The "FILE NAME" screen appears.
- 4 Touch **[CLR]**(**D**) to delete the previously programmed character.
 - Touch **[CLR]**(**D**) to delete the selected character, symbol or number.
 - When the cursor does not select a character, the previous character is deleted.
 - If **[CLR]**(**D**) is continuously touched, all the characters are deleted.

- 5 Touch the desired block one or more times to select the desired character or symbol.

Selectable characters and symbols
A to Z, a to z, 0 to 9, ! # \$ % & \ ? " ' ` ^
+ - * / . , ; = < > () [] { } _ ` @ (space)

- Touch "AB⇔12" to toggle between the Alphabet input and Number input mode.
 - Touch **[CLR]**(**D**) to delete the selected character, symbol or number.
 - Touch **[SYMB]**(**D**) to open the Symbol character selection window.
 - Touch " " to input a space.
- 6 Touch **[←]**(**D**) to move the cursor backwards, or touch **[→]**(**D**) to move the cursor forwards.
 - 7 Repeat steps 5 and 6 to program up to 14 characters name.
 - Example: MY DATA
 - 8 Touch **[ENT]**(**D**) to save the name.
 - The confirmation screen "Save file?" appears.
 - 9 Touch **[YES]**(**D**) to save.
 - While saving, a progress bar is displayed, then the "SD CARD" screen is displayed after the save is completed.
 - 7 Push **SET**(**C**) to exit the Set mode.

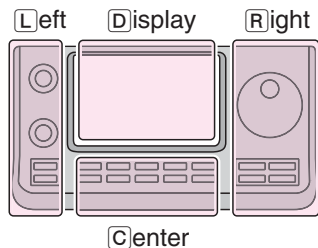

The **L**, **R**, **C** or **D** in the instructions indicate the part of the controller.

- L**: Left side
- R**: Right side
- C**: Center bottom
- D**: Display (Touch panel)

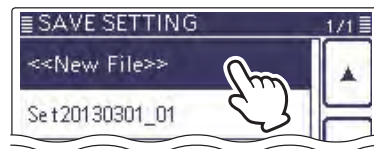

In the "Save Setting" screen, touch "<<New File>>."

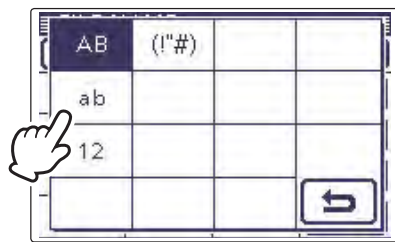
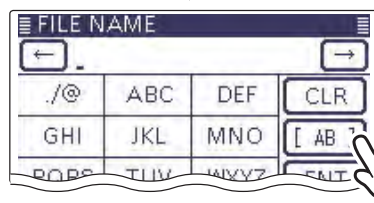
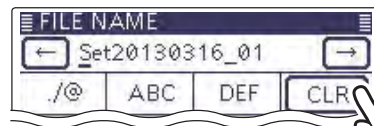

Touch "(!"#) to open the Symbol character selection window.

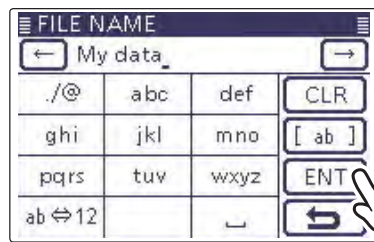

After programming, touch **[ENT]**

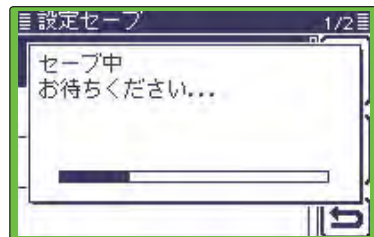
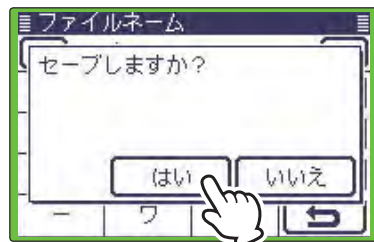

13 USING AN SD CARD

Loading the saved data files that are on the SD card

The saved memory channels, Set mode item settings and repeater lists can be copied to the transceiver. This function is convenient when copying the saved data, such as memory channels, or repeater lists, to another IC-7100 and then operating with the same data.

Saving the current data is recommended before loading other data in the transceiver.

(Example: Loading all the data in the "Set20130301_01" file)

- ① Push **SET**(**C**) to enter the Set mode.
- ② Touch the "Load Setting" item of the "SD Card" Set mode.
(SD Card > **Load Setting**)
 - If the specified item is not displayed, touch [**▲**] or [**▼**](**D**) one or more times to select the page.
- ③ Touch the desired file to be loaded.
(Example: Selecting "Set20130301_01")
 - The LOAD FILE screen appears.
- ④ Touch the desired loading option, as shown below.
 - **ALL:**
Loads all memory channels, item settings in the menu list and the repeater list into the transceiver.
 - **Select:**
Loads all memory channels, Set mode item settings and the repeater list into the transceiver. "MY call signs" and "REF Adjust" settings can be selected to be loaded.
 - **Repeater List Only:**
Loads only the repeater list into the transceiver.
- ⑤ The "Keep 'SKIP' settings in Repeater List?" appears. Touch [**YES**], [**NO**] or [**Cancel**](**D**).
 - When [**YES**](**D**) is touched, the skip settings of the repeater list are retained. (p. ??-??)
 - When [**NO**](**D**) is touched, the skip settings of the repeater list are not retained. (p. ??-??)
 - When [**Cancel**](**D**) is touched, returns to the LOAD FILE screen.
 - When [**YES**] or [**NO**](**D**) is touched, "Load file?" appears.

To update the repeater list, click here!

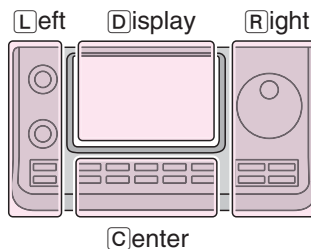
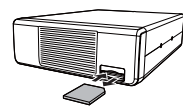

The **L**, **R**, **C** or **D** in the instructions indicate the part of the controller.

- L**: Left side
- R**: Right side
- C**: Center bottom
- D**: Display (Touch panel)

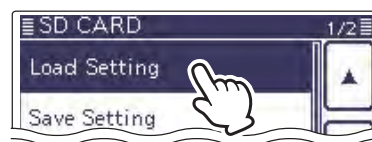

In the "SD Card" screen, touch "Load Setting."

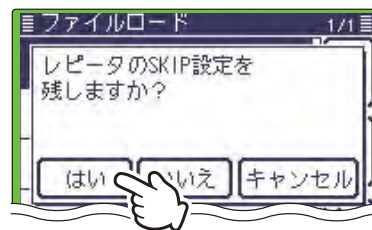

☞ Continued on the next page

13 USING AN SD CARD

Loading the saved settings file that are on the SD card (Continued)

- ⑥ Touch [YES](D) to start the file check.
 - While checking the file, "CHECKING FILE" and a progress bar are displayed.
- ⑦ After checking, settings data loading begins.
 - While loading, "LOADING" and a progress bar are displayed.
- ⑧ After loading ends, "COMPLETED!" appears. To complete the loading, reboot the transceiver.

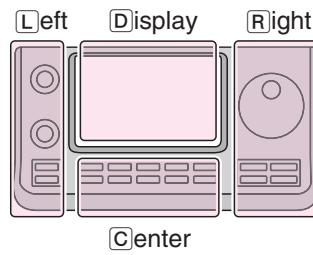

The L, R, C or D in the instructions indicate the part of the controller.

- L: Left side
- R: Right side
- C: Center bottom
- D: Display (Touch panel)

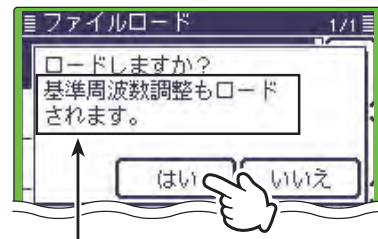

Appears only when "ALL" or "Select"* is selected in the LOAD FILE screen,
*If "Select" is selected, only when the "REF Adjust" check box is checked.

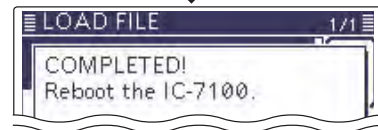
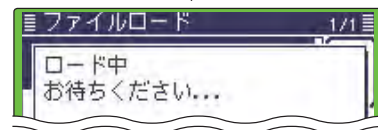
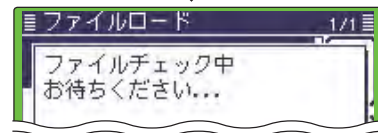

13 USING AN SD CARD

Backing up the data stored on the SD card onto a PC

A backup file allows easy restoring even if the setting data in the SD card is accidentally deleted.

Depending on your PC, a memory card reader (purchase locally) may be additionally required to read the SD card.

◆ About the SD card's folder contents

The folder in the SD card contains the following:

- ① IC-7100 folder
The folders created in the IC-7100 are contained in this IC-7100 folder.
- ② Decode folder
The RTTY decode folder is created.
- ③ RTTY folder
The transmitted or received RTTY decode data is stored in the "txt" format.
The file format can be changed to "html" in the RTTY DECODE LOG SET screen.
- ④ QSO Log
QSO log data is stored in the "csv" format.
- ⑤ Reply folder
Automatic reply data is stored in the "wav" format.
- ⑥ RxLog
RX record log data is stored in the "csv" format.
- ⑦ Setting folder
The transceiver's setting data is stored in the "icf" format.
- ⑧ Voice folder
The recorded QSO audio data folders are created in the Voice folder.
- ⑨ yyyyymmdd folder
Recorded audio file is stored in the "wav" format.
The folder name is automatically created in the following format:
yyyyymmdd (yyyy:Year, mm:month, dd:day)
- ⑩ VoiceTx
Recorded voice audio data for the Voice TX function is stored in the "wav" format.

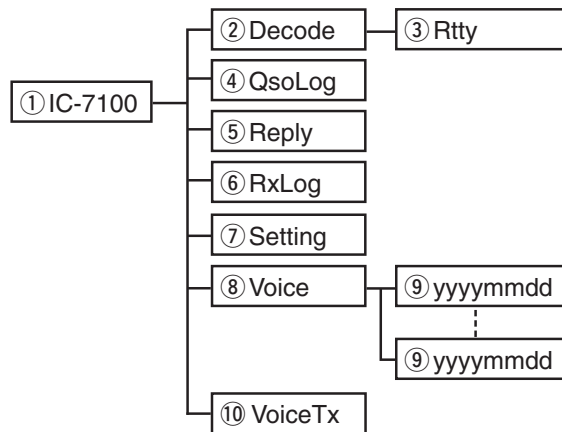

(Example: Selecting the setting data)

When the SD card is inserted into the SD card drive of your PC or the SD card reader (purchase locally), the screen appears as shown below.

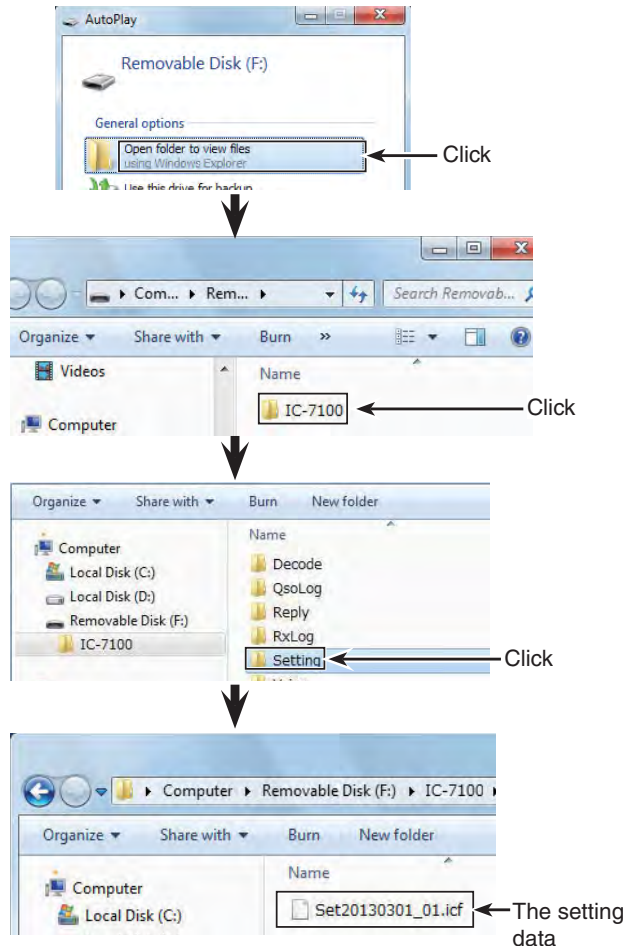

13 USING AN SD CARD

Backing up the data stored on the SD card onto a PC (Continued)

◆ Making a backup file on your PC

Windows 7 is used for these instructions.

- ① Insert the SD card into the SD card drive on your PC.
 - If no SD card drive is built-in, connect a memory card reader (purchase locally) and then insert the SD card into it.
- ② Click the “Open folder to view files” option to access the card.

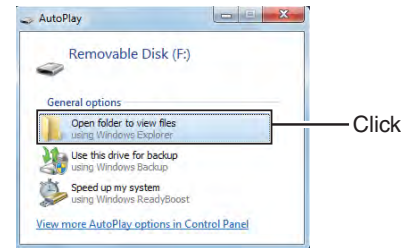

- ③ Select “Removal disk” and right click.
- ④ Click “Copy.”

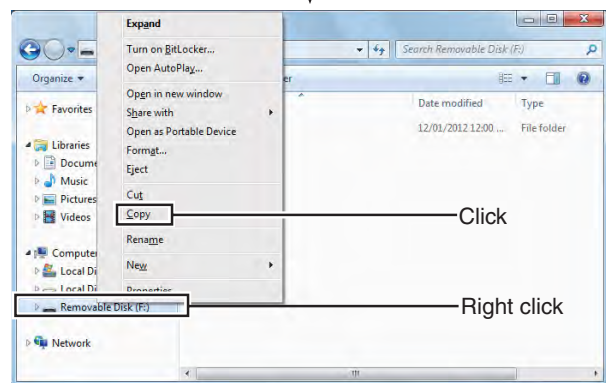

- ⑤ Open the desired folder to copy to, then right click, then click “Paste” to copy the data that is in the SD card onto the hard disk. (Example: Copying into the “Backup” folder in C drive)

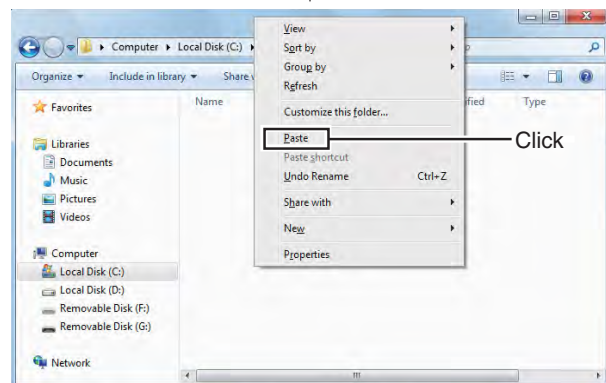

- ⑥ When removing the SD card from your PC, click the SD card icon in the task bar. (Icon in the screen shot as shown to the right.)
 - The screen shot shows when a memory card reader is connected.

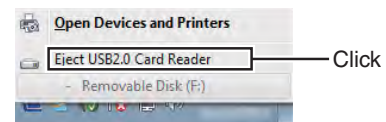

- ⑦ Remove the SD card from your PC when “Safe To Remove Hardware” appears.
 - The screen shot shows when a memory card reader is connected.



13 USING AN SD CARD

Updating the repeater list

For easy operation, the repeater list is preloaded into your transceiver.

This section describes how to manually update the repeater list using an SD card.

The latest setting file, which includes the repeater list, can be downloaded from the Icom website.

1. Downloading the latest setting file (ICF file)

1 Access the following URL to download the latest data.

<http://www.icom.co.jp/world/support/download/firm/index.html>

- The latest settings file (ICF file) and repeater list (CSV; Comma Separated Values file) are contained in the downloaded ZIP file.

File Name: 7100_U_130301.zip

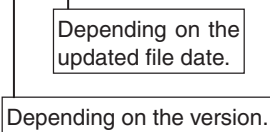

▨ This instruction manual describes when the file name is “7100_U_130301.zip,” for example.

2 Decompress the compressed file that is downloaded from the Icom website.

“7100_U_130301” folder will be created in the same place where the downloaded file is saved.

2. Inserting the SD card into a PC

3 Insert the SD card into the SD card drive on your PC.

- Icom recommends that you format all SD cards to be used with the IC-7100, even preformatted SD cards for PCs or other uses.

See page ?? for details of inserting and removing the SD card.

3. Copying the latest ICF file to the SD card

4 Double-click the “7100_U_130301” folder created in the same place where the downloaded file is saved.

5 Copy the ICF file (Example: “7100_USA_130301.icf”) in the folder to the “Setting” folder in the “IC-7100” folder of the SD card.

☞ Continued on the next page

IC-7100’s latest setting file is uploaded to “Cloning software(Rev. **) and manuals” in the Icom website screen.

- The displayed contents may differ.

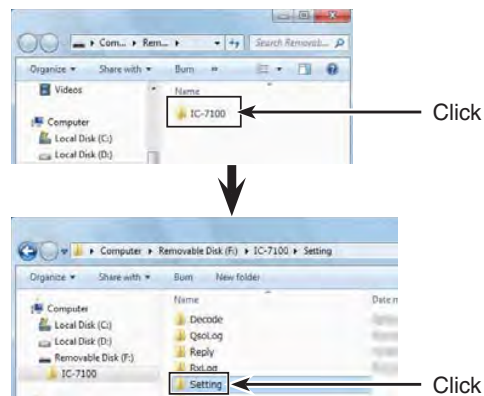
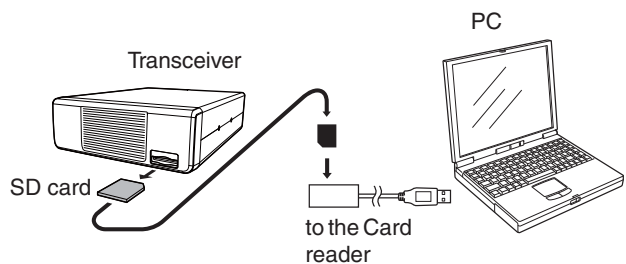
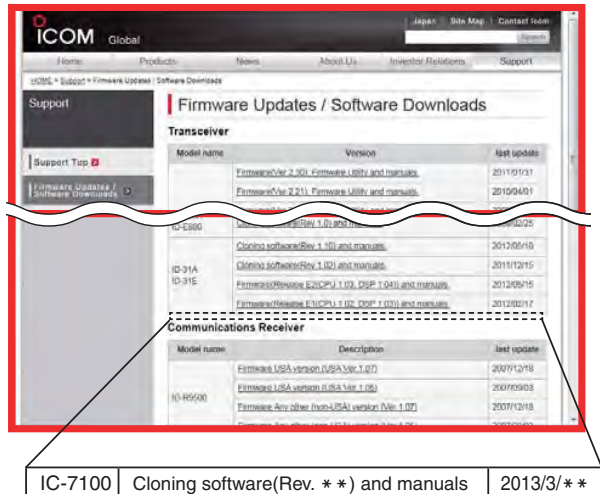

13 USING AN SD CARD

Updating the repeater list (Continued)

4. Inserting the SD card

- Remove the SD card from your PC, and insert the card into the transceiver's slot.

See page ??-?? for details of inserting the SD card into the transceiver.

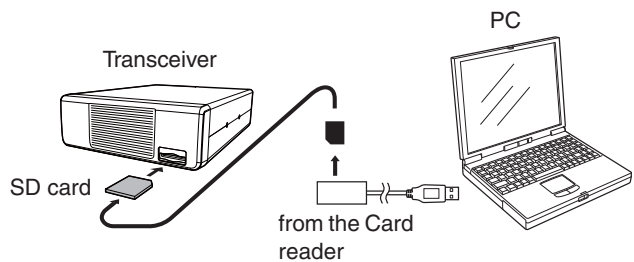

Saving the current data is recommended before loading other data into the transceiver.

5. Updating the repeater list

- Push **SET**(C) to enter the Set mode.
- Touch the "Load Setting" item of the "SD Card" Set mode. (SD Card > Load Setting)
 - If the specified item is not displayed, touch **▲** or **▼**(D) one or more times to select the page.
- Touch the ICF file to be loaded. (Example: Selecting "7100_USA_130301.icf")
 - The LOAD FILE screen appears.
- Touch "Repeater List Only."
 - The "Keep 'SKIP' settings in Repeater List?" appears.
 - Loads only the repeater list into the transceiver.

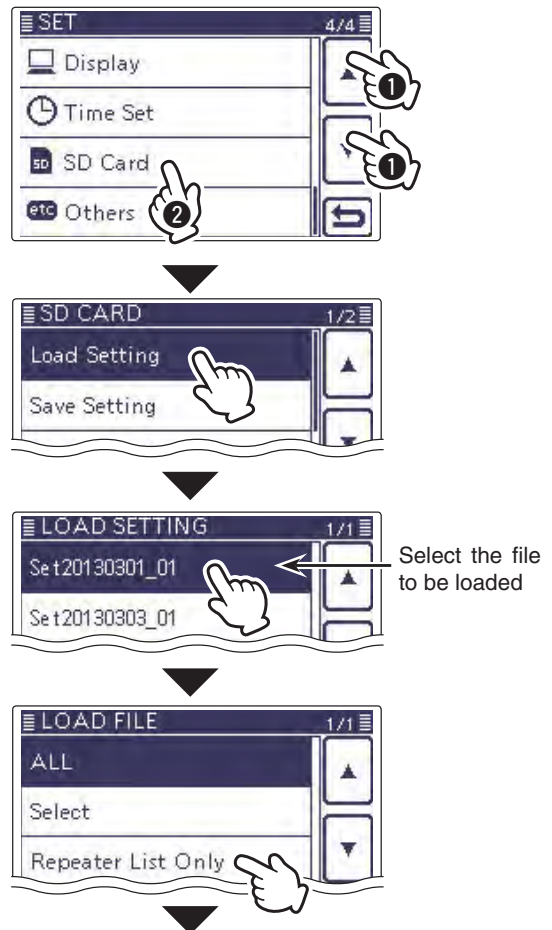
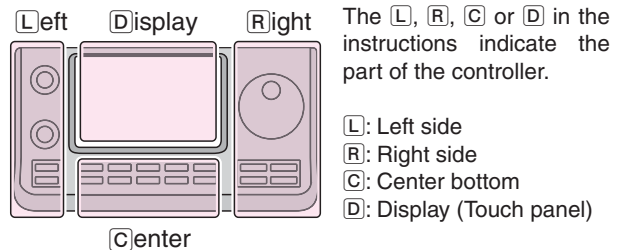

Continued on the next page

13 USING AN SD CARD

Updating the repeater list (Continued)

- 11 Touch [YES], [NO] or [Cancel](D).
 - When [YES](D) is touched, the skip settings of the repeater list are retained. (p. ??-??)
 - When [NO](D) is touched, the skip settings of the repeater list are not retained. (p. ??-??)
 - When [Cancel](D) is touched, returns to the LOAD FILE screen.
 - When [YES] or [NO](D) is touched, “Load file?” appears.
- 12 Touch [YES](D) to start the file check.
 - While checking the file, “CHECKING FILE” and a progress bar are displayed.
- 13 After checking, settings data loading begins.
 - While loading, “LOADING” and a progress bar are displayed.
- 14 After loading ends, “COMPLETED!” appears.
 - To complete the loading, reboot the transceiver.

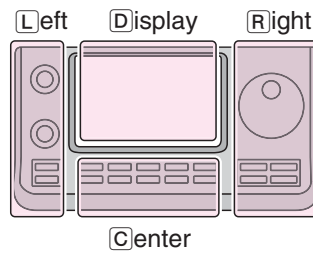

The L, R, C or D in the instructions indicate the part of the controller.

- L: Left side
- R: Right side
- C: Center bottom
- D: Display (Touch panel)

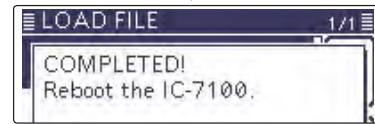
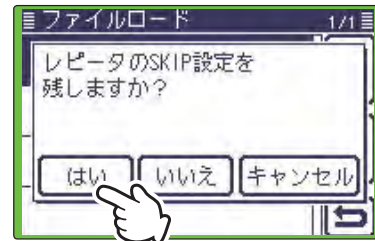

Repeater list updating is complete!

13 USING AN SD CARD

Cloning Transceiver-to-Transceiver using an SD card

This topic describes the cloning method using the SD card.

Memory channel contents, Set mode item settings and repeater list can be saved onto a SD card.

Recorded voice memories are not included in the cloning data. To play back the master transceiver's voice memory, insert the SD card into sub transceiver, or make a copy onto the sub transceiver's SD card using a PC.

⚡ Description is with the SD card is already inserted.

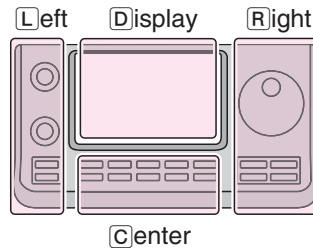
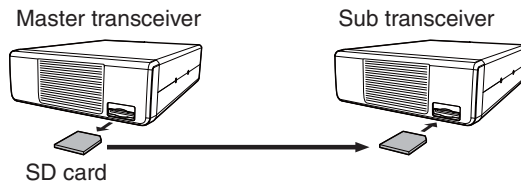

The L, R, C or D in the instructions indicate the part of the controller.

- L: Left side
- R: Right side
- C: Center bottom
- D: Display (Touch panel)

1. Saving the master transceiver's setting data onto the SD card.

- 1 Save the master transceiver's setting data onto the SD card, as described on page ??.

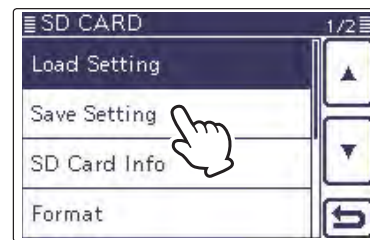

2. Remove the SD card from the master transceiver, and then insert it to the sub transceiver.

- 2 Turn OFF the master transceiver's power.
- 3 Remove the SD card from the master transceiver as shown at right.
- 4 Insert the removed SD card into the sub transceiver, then turn ON the sub transceiver's power.

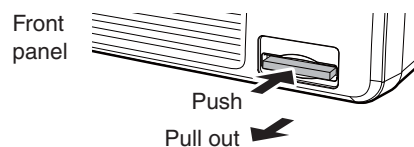

3. Loads the setting data into the sub transceiver.

- 5 The master transceiver's setting data loads into the sub transceiver, as described on page ??.

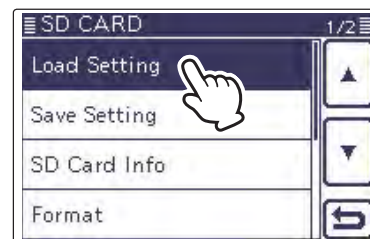

When you load the data, be sure to set the loading content as "Repeater List Only" or "Select" in the LOAD FILE screen, and if "Select" is selected, the "REF Adjust" check box must be cleared.

Otherwise, it may result in a frequency deviation.

LOAD OPTION screen (Appears when "Select" is touched in the LOAD FILE screen)

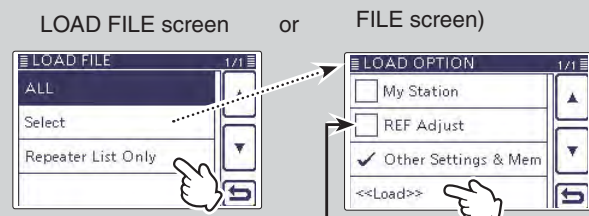

Touch "Repeater List Only"

Touch "Load" without checking the "REF Adjust" box.

Section 14 VOICE MEMORY FUNCTION

- Recording a QSO audio 14-2**
 - ◇ To start recording 14-2
 - ◇ To stop recording..... 14-2
- Changing the recording mode 14-3**
- Playing back the recorded audio 14-4**
- Operation while playing back..... 14-5**
 - ◇ Fast forward while playing 14-5
 - ◇ Rewind while playing 14-5
 - ◇ Pause while playing..... 14-5
 - ◇ Playing the previous file..... 14-5
 - ◇ Playing the next file 14-5
 - ◇ Moving to the beginning of the previous file 14-5
 - ◇ Moving to the beginning of the next file 14-5
 - ◇ VOICE PLAYER screen’s descriptions..... 14-5
- Changing the skip time 14-6**
- Deleting the recorded contents (audio)..... 14-7**
- Deleting the folder 14-8**
- Continue to record even if no signals are received 14-9**
- Record the transmit and receive audio into the same file. 14-10**
- Start to record when the [PTT] switch is pushed 14-11**
- Viewing the folder information 14-12**
- Viewing the file information..... 14-13**
- Viewing the SD card’s free space and recordable time 14-15**
- Playing back the voice memory data on a PC 14-16**

14 VOICE MEMORY FUNCTION

Recording a QSO audio

The Voice Memory function records a QSO (communication) audio onto the SD card.

This function enables you to record both received and transmitted audio, a QSO with a DX'pedition, and playback the recorded audio after the QSO.

NOTE: Be sure to insert an SD card into the transceiver before recording a QSO audio.

◇ To start recording

- ① Push **QUICK**(**C**) to open the Quick Menu screen.
- ② Touch the “<<REC Start>>” item to start voice recording.
 - Touch **[▼]**(**D**) one or more times to select the desired page.
 - The transceiver displays “Recording started” and automatically exits the Quick Menu screen.
 - “||” appears while the recording is paused.
 - “■” appears and “■” and “□” alternately blink while recording.
 - Recording is continuous until you manually stop recording, or the card becomes full.
 - If the recording file's content reaches 2GB, the transceiver automatically creates a new file, and continues recording.

NOTE: Once recording has started, it will continue, even if the transceiver is rebooted.

✓ Convenient!

When the PTT Automatic Recording function is set to ON, the recording automatically starts when [PTT] is pushed. (p. ??-??)
 (Voice Memo > QSO Recorder > Recorder Set > **PTT Auto REC**)

◇ To stop recording

- ① Push **QUICK**(**C**) to open the Quick Menu screen.
- ② Touch “<<REC Stop>>” to stop voice recording.
 - Touch **[▼]**(**D**) one or more times to select the desired page.
 - The transceiver displays “Recording stopped,” and automatically exits the Quick Menu screen.

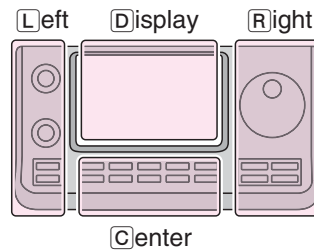

The **L**, **R**, **C** or **D** in the instructions indicate the part of the controller.

- L**: Left side
- R**: Right side
- C**: Center bottom
- D**: Display (Touch panel)

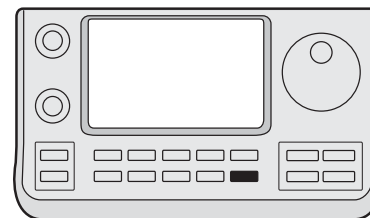

Touch “<<REC Start>>”

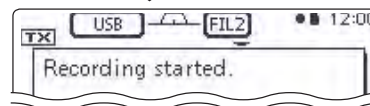

While recording



While pausing

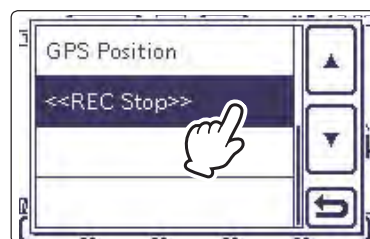

Touch “<<REC Stop>>”



14 VOICE MEMORY FUNCTION

Changing the recording mode

You can change the recording mode in the Set mode to record only the received audio.

▨ The default setting is “TX&RX” (Both transmit and receive signals are recorded).

- ① Push **SET**(**C**) to enter the Set mode.
- ② Touch the “REC Mode” item of the “Voice Memo” Set mode.
(Voice Memo > QSO Recorder > Recorder Set > **REC Mode**)
 - If the specified item is not displayed, touch **[▲]** or **[▼]**(**D**) one or more times to select the page.
- ③ Touch “RX Only” to save, and return to the previous screen.
- ④ Push **SET**(**C**) to exit the Set mode.

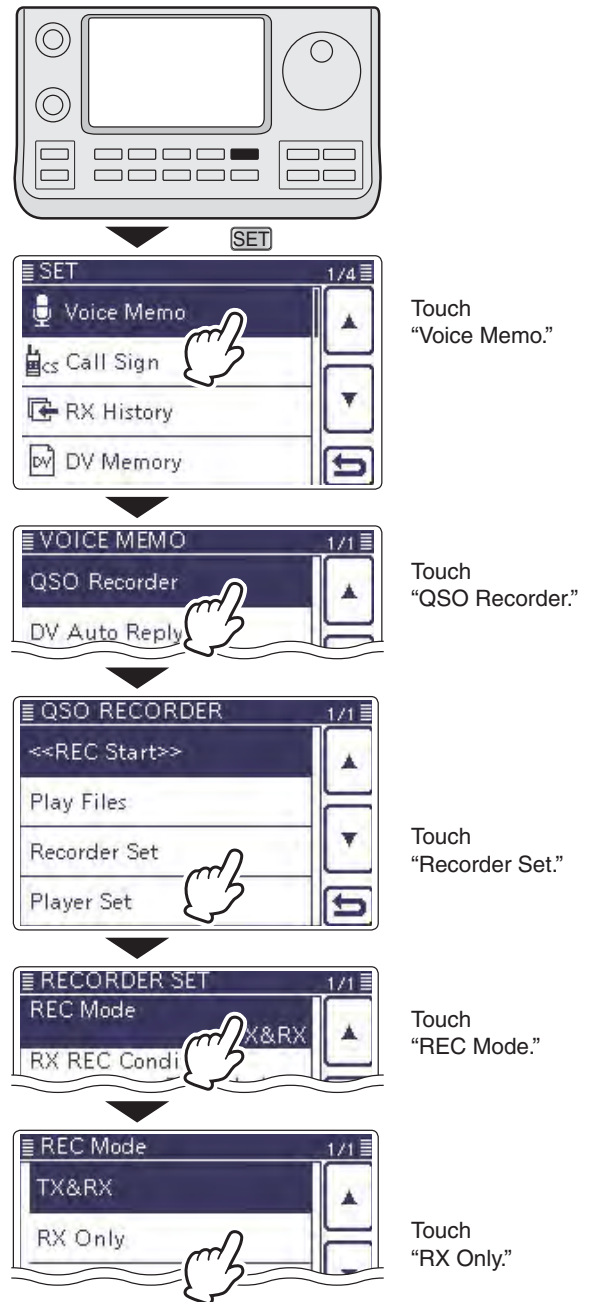

14 VOICE MEMORY FUNCTION

Playing back the recorded audio

- ① Push **SET**(C) to enter the Set mode.
- ② Touch the "Play Files" item of the "Voice Memo" Set mode.
 (Voice Memo > QSO Recorder > **Play Files**)
 - If the specified item is not displayed, touch **[▲]** or **[▼]**(D) one or more times to select the page.
 - The folder list is displayed. (The folders are automatically made when the recording starts.)
 - The folder name is formatted yyyyymmdd (y: year, m: month, d: day.)
- ③ Touch the folder that contains the file you want to play.
 - The file list is displayed.
 - The file name is formatted yyyy/mm/dd hh:mm:ss (y: year, m: month, d: day, hh: hour, mm: minute, ss: second.)
- ④ Touch the file that you want to play.
 - The VOICE PLAYER screen is displayed, and the file starts to playback.
- ⑤ Touch **[↶]**(D) or push **MENU**(C) to stop the playback, and return to the file list screen.



While playing back

14 VOICE MEMORY FUNCTION

Operation while playing back

You can fast forward or rewind while playing back.

◇ Fast forward while playing

Touch **[▶▶]** to fast forward to the skip time point.
(Default: 10 seconds)

If you want to change the skip time, see “Changing the skip time.” (p. ??-??)

◇ Rewind while playing

Touch **[◀◀]** to rewind to the skip time point.
(Default: 10 seconds)

If you want to change the skip time, see “Changing the skip time.” (p. ??-??)

- If you touch **[◀◀]** within the first second of the file, the skip time at the end of the previously recorded file will playback.

◇ Pause while playing

Touch **[⏸]** to pause.
• While pausing, **[▶▶]** appears.
Touch **[▶▶]** to resume.

◇ Playing the previous file

Touch **[◀◀]** to play the previous file.
• In case there are other files in the folder, while the oldest file is playing back, touch **[◀◀]** to start playing the beginning of the file.

◇ Playing the next file

Touch **[▶▶]** to play the next file.
• In case there are other files in the folder, while the most recent file is playing back, touch **[▶▶]** to stop the playback.

◇ Moving to the beginning of the previous file

When the playback is paused anywhere within the file, touch **[◀◀]** one or more times to return to the beginning of the file, and pause.
• Touch **[▶▶]** to play it back.

When the playback is paused at beginning of a file, touch **[◀◀]** to move to the beginning of the previous file, and pause.
• Touch **[▶▶]** to play it back.

◇ Moving to the beginning of the next file

When the playback is paused, touch **[▶▶]** to move to the beginning of the next file, and pause.
• Touch **[▶▶]** to play it back.

✓ Convenient!

You can fast forward or rewind the file that is playing by rotating the Dial.
The fast forward/rewind time is one twentieth of the total file time, regardless of the skip time setting.

◇ VOICE PLAYER screen’s descriptions

The VOICE PLAYER screen is shown below.

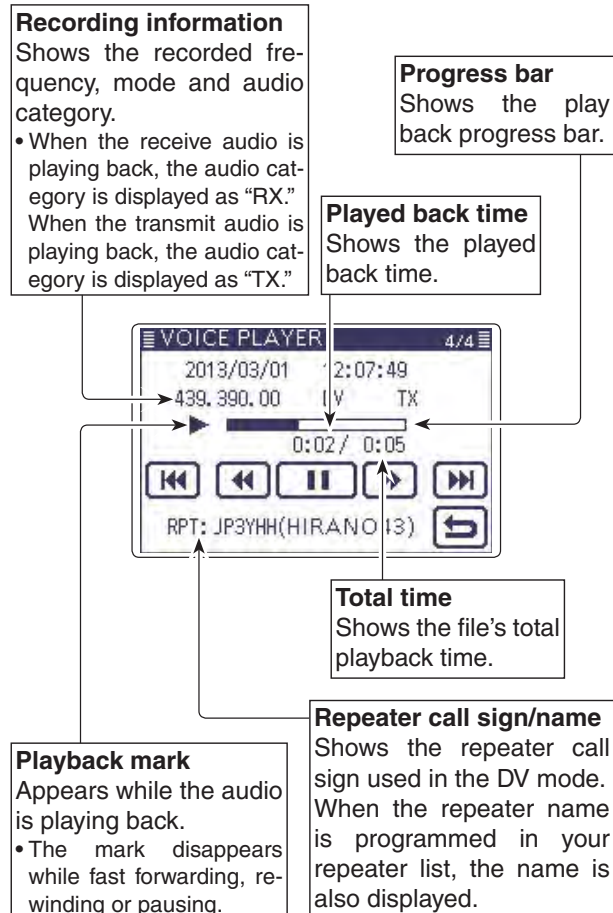
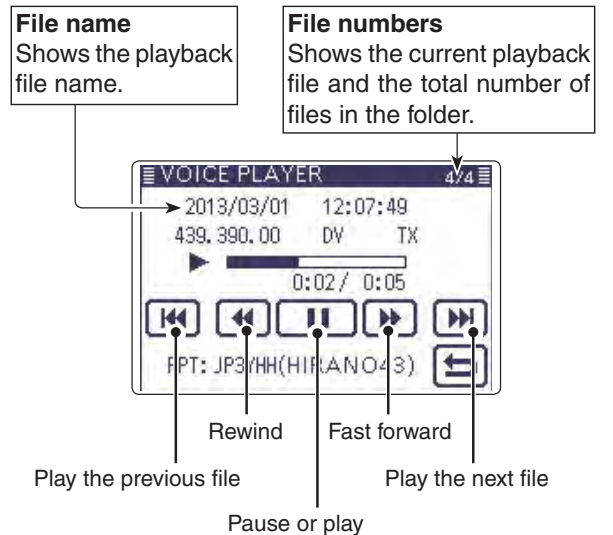

14 VOICE MEMORY FUNCTION

Changing the skip time

You can change the fast forward and rewind skip time while playing.

- ① Push **SET**(C) to enter the Set mode.
- ② Touch the "Skip Time" item of the "Voice Memo" Set mode.
 (Voice Memo > QSO Recorder > Player Set > **Skip Time**)
 - If the specified item is not displayed, touch **[▲]** or **[▼]**(D) one or more times to select the page.
- ③ Touch the desired skip time of 3, 5, 10 or 30 seconds to save, and return to the previous screen.
- ④ Push **SET**(C) to exit the Menu screen.

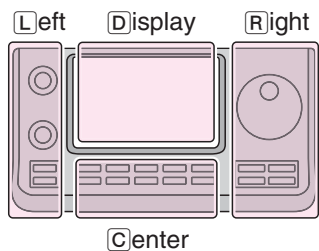

The **L**, **R**, **C** or **D** in the instructions indicate the part of the controller.

- L**: Left side
- R**: Right side
- C**: Center bottom
- D**: Display (Touch panel)

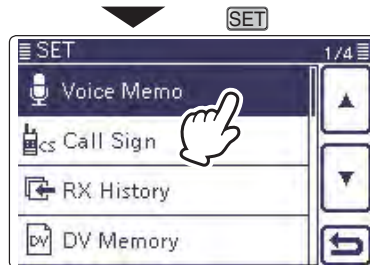
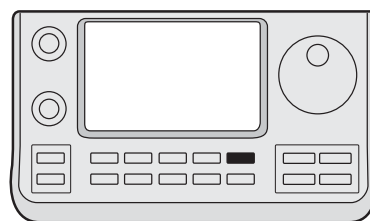

Touch "Voice Memo."

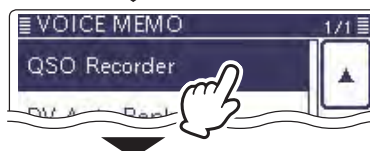

Touch "QSO Recorder."



Touch "Player Set."



Touch "Skip Time."

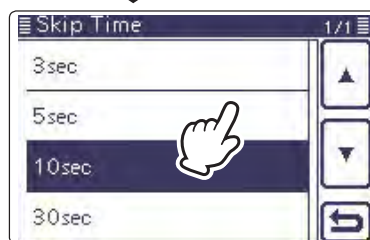

(Example) Touch "5sec."

14 VOICE MEMORY FUNCTION

Deleting the recorded contents (audio)

- ① Push **SET**(**C**) to enter the Set mode.
- ② Touch the "Play files" item of the "Voice Memo" Set mode.
 (Voice Memo > QSO Recorder > **Play files**)
 - If the specified item is not displayed, touch **[▲]** or **[▼]**(**D**) one or more times to select the page.
 - The folder list is displayed. (The folders are automatically made when recording starts.)
 - The folder name is formatted yyyyymmdd (y: year, m: month, d: day.)
- ③ Touch the folder including the file that you want to delete.
 - The file list is displayed.
 - The file name is formatted yyyy/mm/dd hh:mm:ss (y: year, m: month, d: day, hh: hour, mm: minute, ss: second.)
- ④ Touch the file that you want to delete for 1 second.
- ⑤ Touch "Delete."
 • The confirmation screen "Delete file?" appears.
- ⑥ Touch "YES."
 • The selected file is deleted.
- ⑦ Push **SET**(**C**) to exit the Set mode.

The **L**, **R**, **C** or **D** in the instructions indicate the part of the controller.

L: Left side, **R**: Right side, **C**: Center bottom
D: Display (Touch panel)

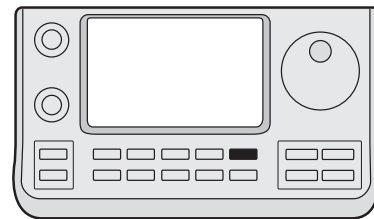

Touch "Voice Memo."

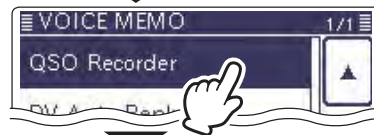

Touch "QSO Recorder."

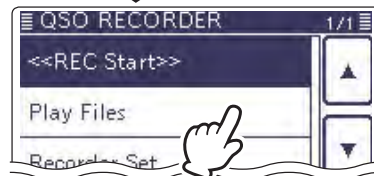

Touch "Play files."

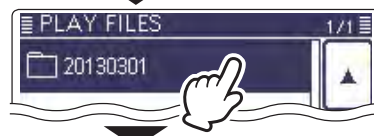

Touch the folder including the file that you want to delete.



Touch the file that you want to delete for 1 second

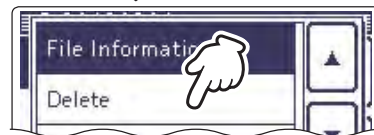

Touch "Delete."

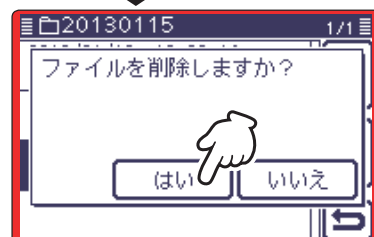

Touch "YES."

<To delete all files>

When you want to erase all audio files in the folder at one time, select "Delete All" in step ⑤ above.

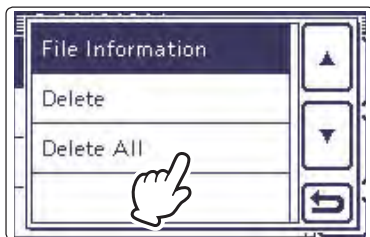

14 VOICE MEMORY FUNCTION

Deleting the folder

⚡ **NOTE:** All the files in the folder are also deleted.

- ① Push **SET**(C) to enter the Set mode.
- ② Touch the "Play files" item of the "Voice Memo" Set mode.
(Voice Memo > QSO Recorder > **Play files**)
 - If the specified item is not displayed, touch [▲] or [▼](D) one or more times to select the page.
 - The folder list is displayed. (The folders are automatically made when recording starts.)
 - The folder name is formatted yyyyymmdd (y: year, m: month, d: day.)
- ③ Touch the folder that you want to delete for 1 second.
- ④ Touch "Delete."
 • The confirmation screen "Delete folder?" appears.
- ⑤ Touch "YES."
 • The selected folder is deleted.
- ⑥ Push **SET**(C) to exit the Set mode.

<To delete all folders>

When you want to erase all folders at one time, select "Delete All Folders" in step ④.

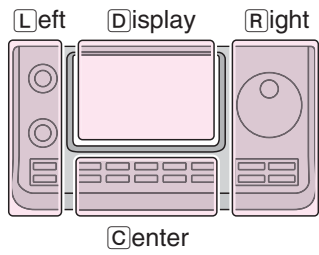
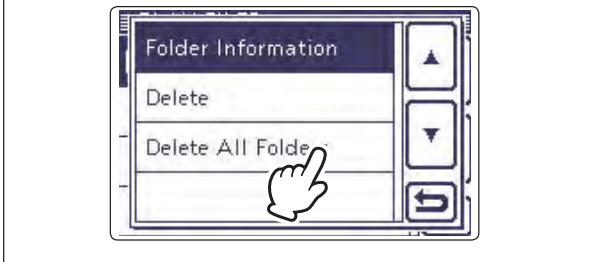

The **L**, **R**, **C** or **D** in the instructions indicate the part of the controller.

- L**: Left side
- R**: Right side
- C**: Center bottom
- D**: Display (Touch panel)

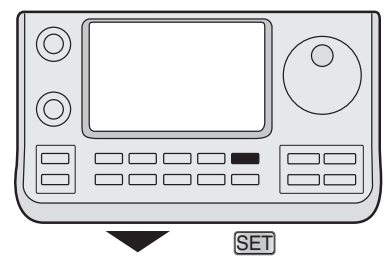

Touch "Voice Memo."



Touch "QSO Recorder."

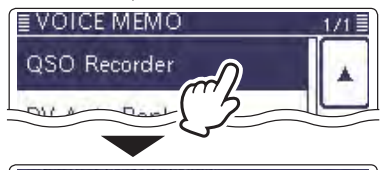

Touch "Play files."

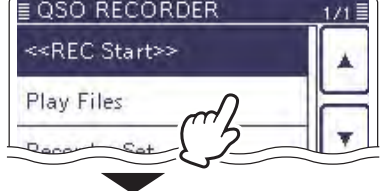

Touch the folder that you want to delete for 1 second

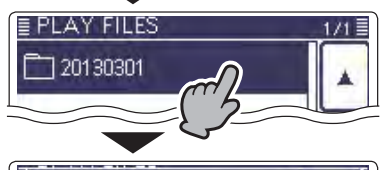

Touch "Delete."

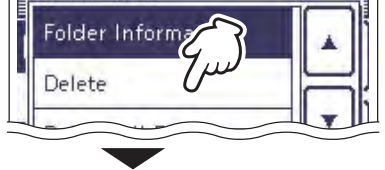

Touch "YES."

14 VOICE MEMORY FUNCTION

Continue to record even if no signals are received

In the default settings, the transceiver records audio only while receiving signals (the squelch is open). If you want to continue recording even if no signal is received, do the following steps.

- ① Push **SET**(**C**) to enter the Set mode.
- ② Touch the "RX REC Condition" item of the "Voice Memo" Set mode.
(Voice Memo > QSO Recorder > Recorder Set > **RX REC Condition**)
 - If the specified item is not displayed, touch **[▲]** or **[▼]**(**D**) one or more times to select the page.
- ③ Touch "Always" to continuously record even if no signal is received.
 - Always: Recording continues, even if no signals are received.
 - Squelch Auto: The transceiver records audio only while receiving signals (the squelch opens).
- ④ Push **SET**(**C**) to exit the Set mode.

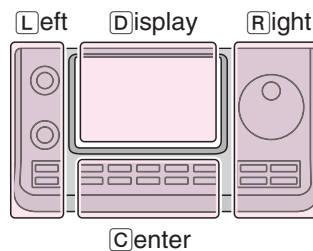

The **L**, **R**, **C** or **D** in the instructions indicate the part of the controller.

- L**: Left side
- R**: Right side
- C**: Center bottom
- D**: Display (Touch panel)

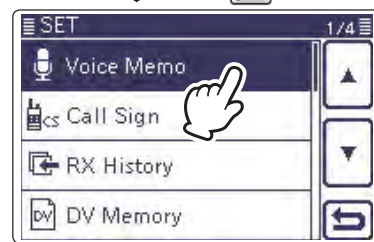
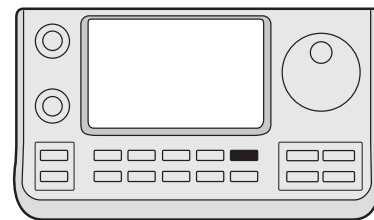

Touch "Voice Memo."



Touch "QSO Recorder."

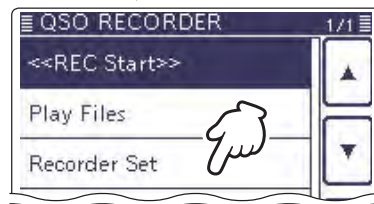

Touch "Recorder Set."

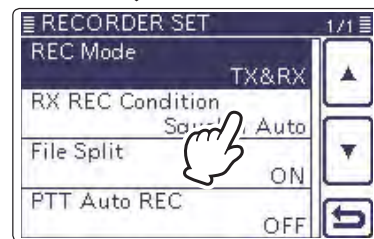

Touch "RX REC Condition."

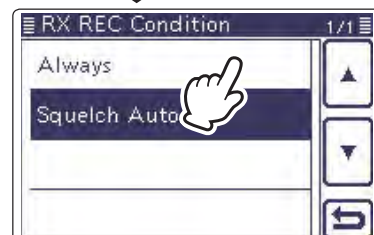

(Example)
Touch "Always."

14 VOICE MEMORY FUNCTION

Record the transmit and receive audio into the same file

The transceiver can record the transmit and receive audio into the same file.

- ① Push **SET**(**C**) to enter the Set mode.
- ② Touch the "File Split" item of the "Voice Memo" Set mode.
(Voice Memo > QSO Recorder > Recorder Set > **File Split**)
 - If the specified item is not displayed, touch **[▲]** or **[▼]**(**D**) one or more times to select the page.
- ③ Touch "OFF."
 - OFF : The transceiver records the transmit and receive audio into the same file.
 - ON : The transceiver records the transmit and receive audio into each file.
The transceiver makes separate new files for transmit and receive audio. (Default setting)
 - When you set the RX REC Condition item to "Squelch Auto," the transceiver records audio to the new file when the squelch either opens or closes.
(Voice Memo > QSO Recorder > Recorder set > **RX REC Condition**)
- ④ Push **SET**(**C**) to exit the Set mode.

NOTE: Even if you set the "File Split" item to OFF, when the recording file's content becomes 2 GB, the transceiver continues to record, but to a new file.

About the VOICE PLAYER screen when recording into the same file

The VOICE PLAYER screen shows information that is recorded first.

When the receive audio was recorded first, the transmit audio information is not displayed on the screen.

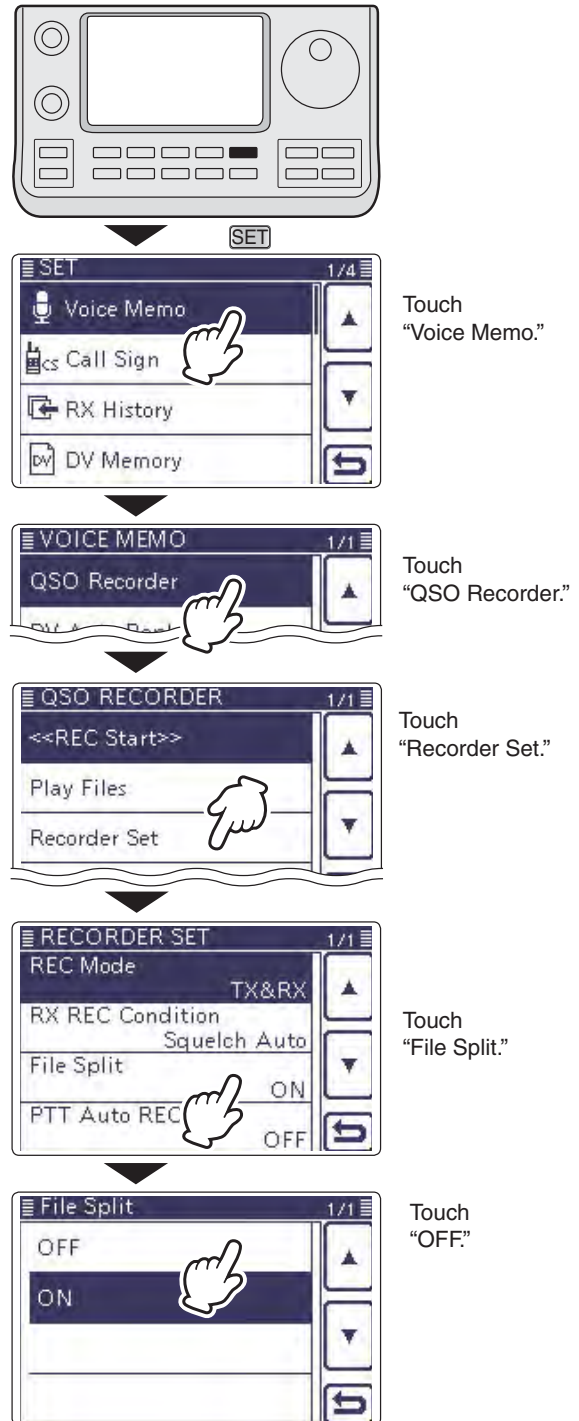

14 VOICE MEMORY FUNCTION

Start to record when the [PTT] switch is pushed

The transceiver starts to record the transmitted audio when the [PTT] switch is pushed.

After transmitting, when the transceiver receives a signal in a given amount of time, it also records the received audio. Therefore, you can record all communication audio using this function.

- ① Push **SET**(**C**) to enter the Set mode.
- ② Touch the "PTT Auto REC" item of the "Voice Memo" Set mode.
(Voice Memo > QSO Recorder > Recorder Set > **PTT Auto REC**)
 - If the specified item is not displayed, touch **[▲]** or **[▼]**(**D**) one or more times to select the page.
- ③ Touch "ON."
- ④ Push **SET**(**C**) to exit the Set mode.

- NOTE: When you set PTT AUTO REC to ON, see the notes below.**
- The transceiver also starts to record audio when the optional microphone's [PTT] switch is pushed, transmitting using the VOX function or the CI-V remote controller.
 - All transmit audio is recorded.
(When "RX Only" is set in the "REC Mode" item, transmit audio is not recorded)
 - When the transceiver receives a signal less than 10 seconds after transmitting, the transceiver also records the receive audio.
 - In addition, when the transceiver receives a signal, and then receives other signals less than 10 seconds later, it records all signals audio.

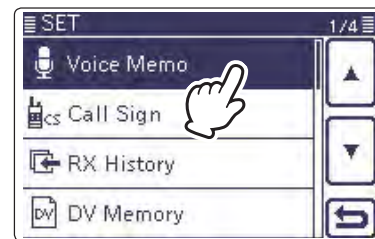
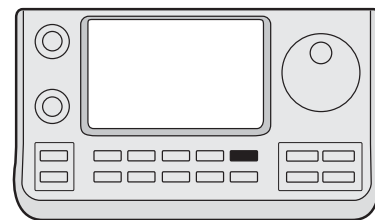
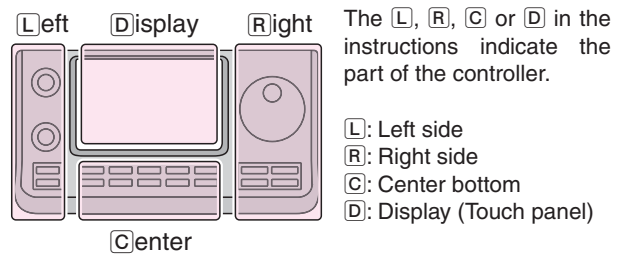

Touch "Voice Memo."

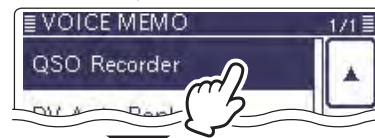

Touch "QSO Recorder."



Touch "Recorder Set."

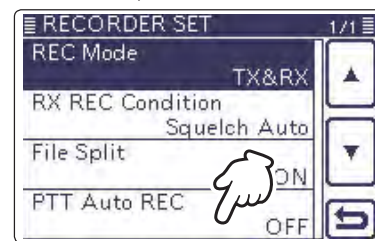

Touch "PTT Auto REC."

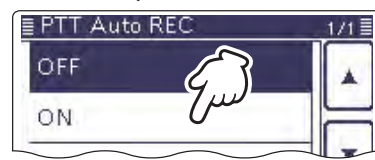

Touch "ON."

14 VOICE MEMORY FUNCTION

Viewing the folder information

The transceiver can display the folder's name, number of the files in the folder, total capacity of the files and date.

- ① Push **SET**(**C**) to enter the Set mode.
- ② Touch the "Play Files" item of the "Voice Memo" Set mode.
 (Voice Memo > QSO Recorder > **Play Files**)
 - If the specified item is not displayed, touch [**▲**] or [**▼**](**D**) one or more times to select the page.
 - The folder list is displayed. (The folders are automatically made when recording starts.)
 - The folder name is formatted yyyyymmdd (y: year, m: month, d: day.)
- ③ Touch the folder that contains the file you want to view for 1 second.
- ④ Touch the "Folder Information" item.
 • The information screen appears.
- ⑤ Touch [**↵**](**C**) to cancel the information screen.
 • Touching **SET**(**C**) or **QUICK**(**C**) also cancels.
- ⑥ Push **SET**(**C**) to exit the Set mode.

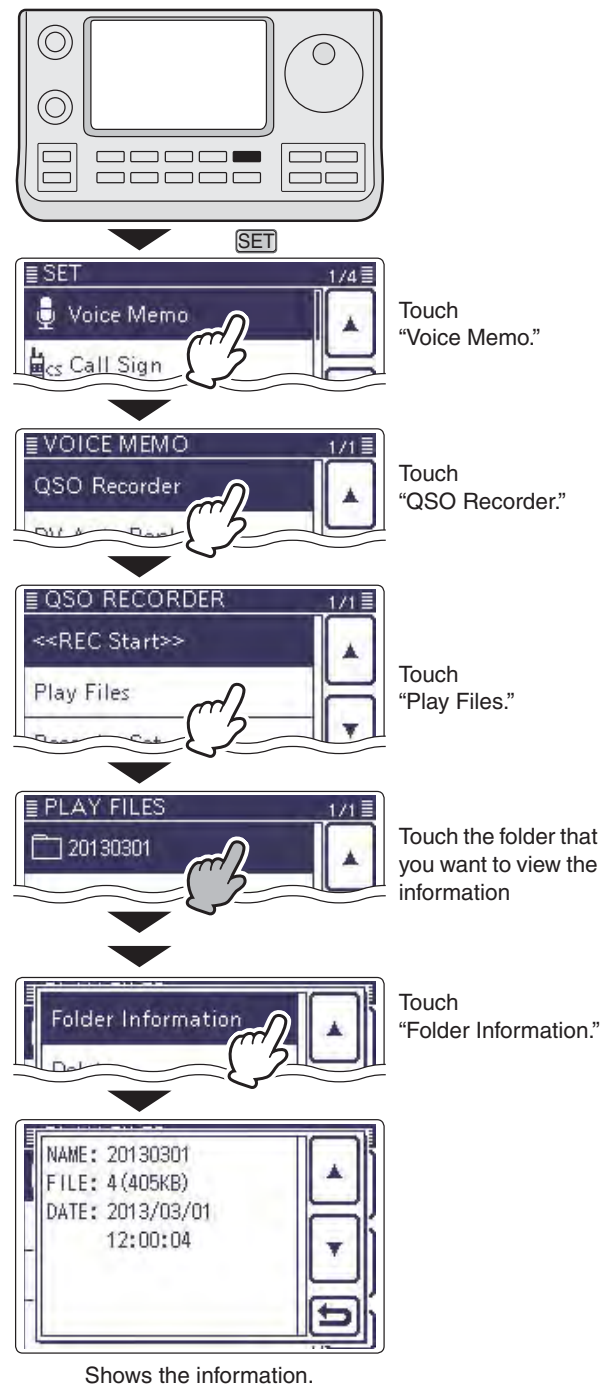
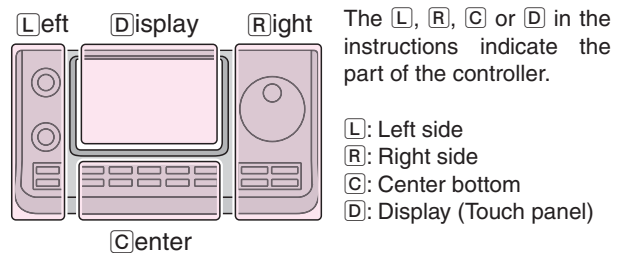

14 VOICE MEMORY FUNCTION

Viewing the file information

The transceiver can display the recorded file's frequency, mode, date, and so on.

- ① Push **SET**(**C**) to enter the Set mode.
- ② Touch the "Play Files" item of the "Voice Memo" Set mode.
(Voice Memo > QSO Recorder > **Play Files**)
 - If the specified item is not displayed, touch **[▲]** or **[▼]**(**D**) one or more times to select the page.
 - The folder list is displayed. (The folders are automatically made when recording starts.)
 - The folder name is formatted yyyyymmdd (y: year, m: month, d: day.)
- ③ Touch the folder that contains the file you want to view.
 - The file list is displayed.
 - The file name is formatted yyyy/mm/dd hh:mm:ss (y: year, m: month, d: day, hh: hour, mm: minute, ss: second.)
- ④ Touch the file that you want to view the information for 1 second.
- ⑤ Touch the "File Information" item.
 - The information screen appears.
- ⑥ Touch **[↵]**(**C**) to cancel the information screen.
 - Touching **SET**(**C**) or **QUICK**(**C**) also cancels.
- ⑦ Push **SET**(**C**) to exit the Set mode.

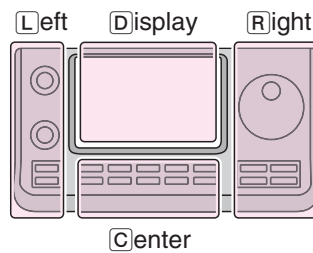

The **L**, **R**, **C** or **D** in the instructions indicate the part of the controller.

- L**: Left side
- R**: Right side
- C**: Center bottom
- D**: Display (Touch panel)

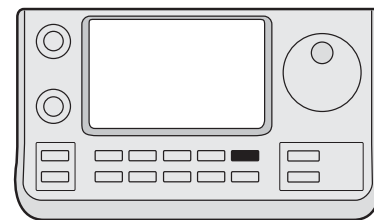

Touch "Voice Memo."

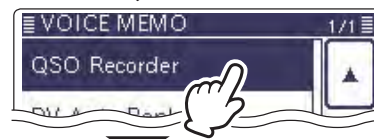

Touch "QSO Recorder."

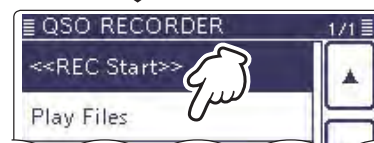

Touch "Play Files."

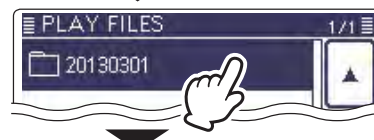

Touch the folder that contains the file you want to view.

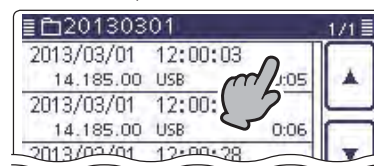

Touch the file that you want to view the information for 1 second.



Touch "File Information."

Continued on the next page.

14 VOICE MEMORY FUNCTION

Viewing the file information (Continued)

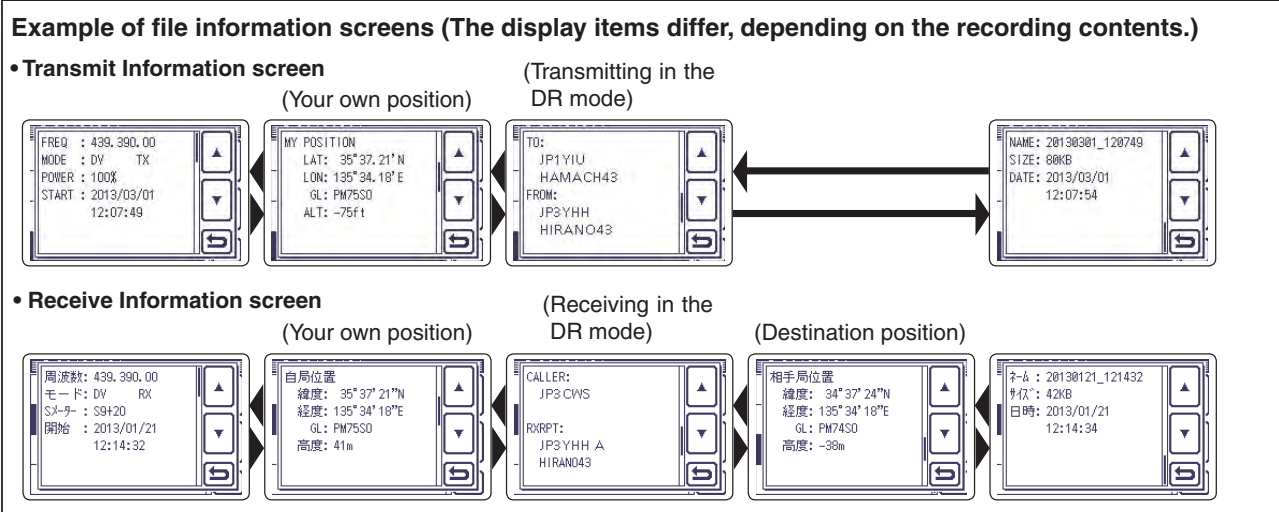

14 VOICE MEMORY FUNCTION

Viewing the SD card's free space and recordable time

- ① Push **SET**(C) to enter the Set mode.
- ② Touch the "SD Card" item.
 - If the specified item is not displayed, touch **[▲]** or **[▼]**(D) one or more times to select the page.
- ③ Touch the "SD Card Info" item.
 - The information screen appears.
- ④ Touch **[↶]**(C) to cancel the information screen.
 - Touching **SET**(C) or **QUICK**(C) also cancels.
- ⑤ Push **SET**(C) to exit the Set mode.

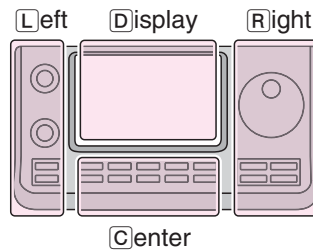

The **L**, **R**, **C** or **D** in the instructions indicate the part of the controller.

- L**: Left side
- R**: Right side
- C**: Center bottom
- D**: Display (Touch panel)

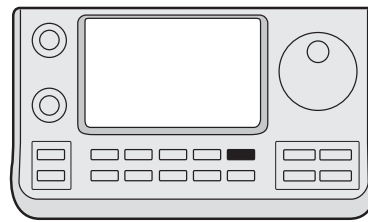

SET

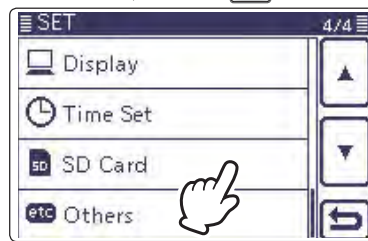

Touch "SD Card."

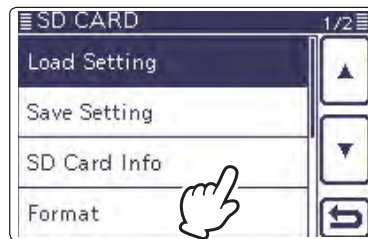

Touch "SD Card Info."



Shows the information screen.

14 VOICE MEMORY FUNCTION

Playing back the voice memory data on a PC

You can also playback the voice memory data on a PC.

However, the recorded information (frequency, date, and so on) are not displayed.

- Microsoft® Windows® 7 is used for the description.

Example: Connect a memory card reader (3rd party product) to the PC, and insert the SD card into the reader. Then playing back the voice memory data in the card.

- When you copy the voice memory data from the SD card to the PC's hard disk drive, you also operate the same as following steps for playing back data.

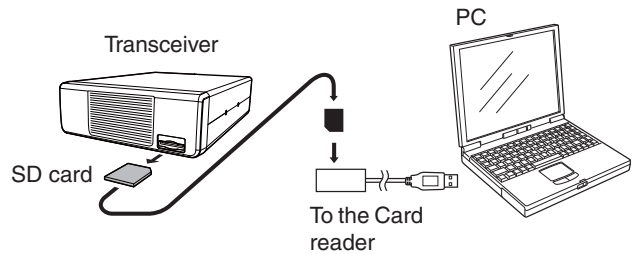

- ① Connect the memory card reader to the PC, and then insert the SD card into the reader.
 - If your PC has an SD card drive, insert the card into the drive.
- ② When the SD card is inserted in the SD card drive of the PC or the SD card reader, the screen appears, as shown to the right.
 - The [IC-7100] folder appears.
- ③ Double-click the [IC-7100] folder.

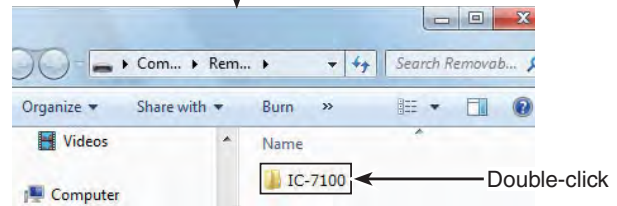
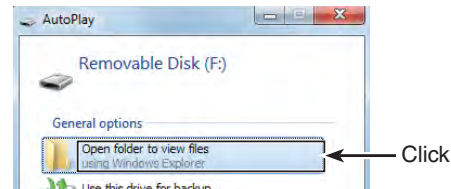

- ④ Double-click the [Voice] folder.

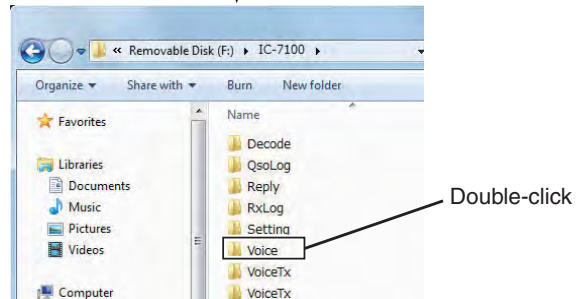

- ⑤ Double-click the folder in which the file you want to playback is stored. (Example: 20130301 folder)
- ⑥ To playback the file, double-click it. (Example: 20130301_184451.wav)

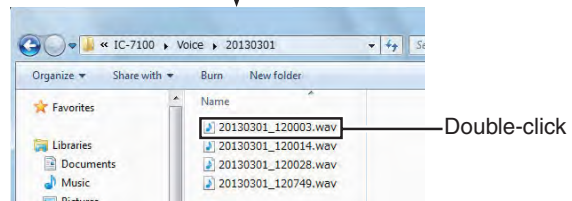
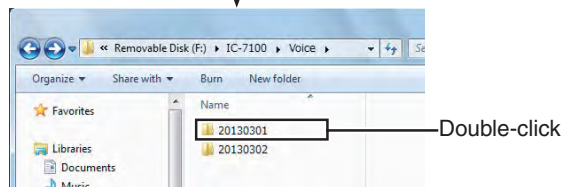

NOTE:

- The operations while playing back may differ, depending on the software. Therefore, refer to the software's instruction manual for details.
- When the file does not playback, even if you double-click the file, download appropriate software like Windows Media® Player.

Section 15 VOICE TX FUNCTION

Recording the voice audio	15-2
Playing back the recorded voice audio	15-3
Programming a memory name	15-4
Transmitting the recorded voice audio	15-6
◇ Adjusting the TX volume level	15-7
Voice TX Set mode	15-8

15 VOICE TX FUNCTION

Recording the voice audio

The Voice TX function transmits the recorded audio on an SD card once, or repeatedly, for up to 10 minutes at the specified interval.

Up to 4 memories are available for repeated CQ and exchange transmissions in contests, as well as when making repeated calls to DX'peditions.

The recorded audio can be transmitted in the SSB, AM (HF/50 MHz only), FM or DV mode.

The Voice TX function can be assigned to a key on the optional HM-151 REMOTE CONTROL MIC or an external keypad. (p. ??-??)

NOTE: Be sure to insert an SD card into the transceiver before recording a voice audio.

- ① Push **[MENU]**(C) one or more times to select the "M-2" (Menu 2) screen.
 - In the DR mode, select the "D1" screen.
- ② Touch **[VOICE]**(D) to select the Voice TX mode.
 - The "VOICE TX" screen is displayed.
- ③ Push **[MENU]**(C) to display the "VOICE" screen.
- ④ Touch **[REC]**(D) to display the "VOICE TX RECORD" screen.
- ⑤ Touch the desired memory, [T1] through [T4].
 - The "VOICE TX RECORD (T1)" screen is displayed, when [T1] memory is selected.
- ⑥ Touch **[●]**(D) to start recording.
 - Touch **[■]**(D) to cancel recording.
 - The maximum record time is 90 seconds.
 - Hold the microphone 5 to 10 cm (2 to 4 inches) from your mouth, then speak at a normal voice level.
 - Touch **[MIC GAIN]**(D) to display the "MIC GAIN" screen.
 - If you record again on the same channel, the current contents will be overwritten.
- ⑦ Touch **[>]**(C) to return to the "VOICE TX RECORD" screen.

Information

To delete the recorded audio, touch the center of the "VOICE TX RECORD (T1)" through "VOICE TX RECORD (T4)" screen for 1 second, or push **[QUICK]**(C), and then touch "Clear."

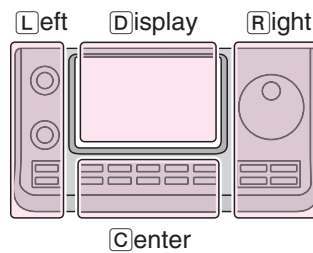
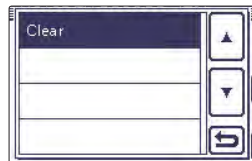

The L, R, C or D in the instructions indicate the part of the controller.

- L: Left side
- R: Right side
- C: Center bottom
- D: Display (Touch panel)

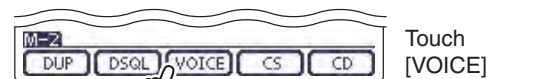

Touch [VOICE]

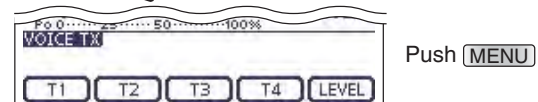

Push [MENU]

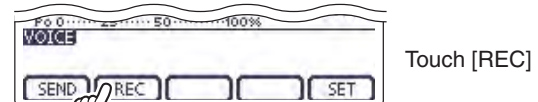

Touch [REC]



(Example) Touch [T1]



Touch [●]

While recording

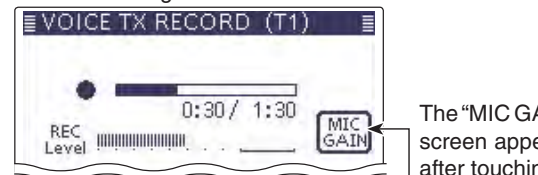

The "MIC GAIN" screen appears after touching

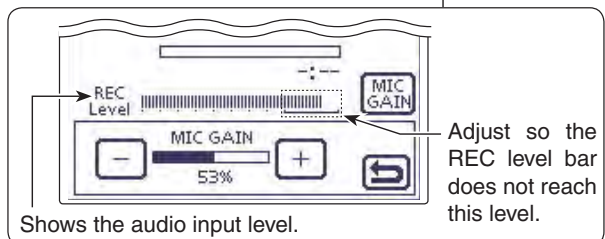

Shows the audio input level.

Adjust so the REC level bar does not reach this level.

15 VOICE TX FUNCTION

Playing back the recorded voice audio

The recorded voice audio for the Voice TX function can be played back.

- ① Push **MENU**(**C**) one or more times to select the “M-2” (Menu 2) screen.
 - In the DR mode, select the “D1” screen.
- ② Touch **[VOICE]**(**D**) to select the Voice TX mode.
 - The “VOICE TX” screen is displayed.
- ③ Push **MENU**(**C**) to display the “VOICE” screen.
- ④ Touch **[REC]**(**D**) to display the “VOICE TX RECORD” screen.
- ⑤ Touch the desired memory, [T1] through [T4].
 - The “VOICE TX RECORD (T1)” screen is displayed, when [T1] memory is selected.
- ⑥ Touch **[▶]**(**D**) to start the playback.
 - Touch **[■]**(**D**) to stop the playback.
- ⑦ Touch **[↶]**(**C**) to return to the “VOICE TX RECORD” screen.

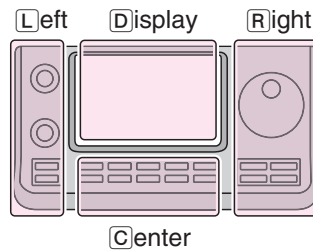

The **L**, **R**, **C** or **D** in the instructions indicate the part of the controller.

- L**: Left side
- R**: Right side
- C**: Center bottom
- D**: Display (Touch panel)

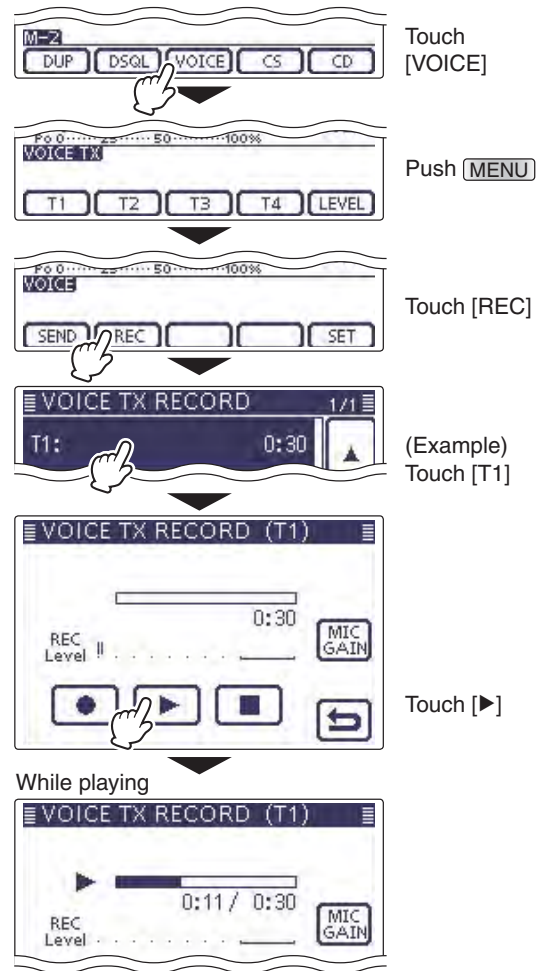

15 VOICE TX FUNCTION

Programming a memory name

Each Voice TX memory, [T1] through [T4], can be programmed with an alphanumeric name of up to 16 characters.

[EXAMPLE]: Programming the memory name “Contest” in [T1].

- ① Push **MENU**(**C**) one or more times to select the “M-2” (Menu 2) screen.
 - In the DR mode, select the “D1” screen.
- ② Touch **[VOICE]**(**D**) to select the Voice TX mode.
 - “VOICE TX” screen is displayed.
- ③ Push **MENU**(**C**) to display the “VOICE” screen.
- ④ Touch **[REC]**(**D**) to display the “VOICE TX RECORD” screen.
- ⑤ Touch the desired memory, [T1] through [T4], for 1 second to program.
- ⑥ Touch **[Edit Name]** to display the “VOICE TX RECORD (T1)” screen (Voice TX name edit screen).
 - A cursor appears and blinks.
- ⑦ Touch the desired block one or more times to select the desired character or symbol.

Selectable characters and symbols
A to Z, a to z, 0 to 9, ! # \$ % & \ ? " ' ` ^ + - * / . , ; = < > () [] { } _ @ (space)

- Touch “AB⇔12” to toggle between the Alphabet input and Number input mode.
- Touch **[CLR]**(**D**) to delete the selected character, symbol or number.
- Touch **[SYMB]**(**D**) to open the Symbol character selection window.
- Touch “_” to input a space.

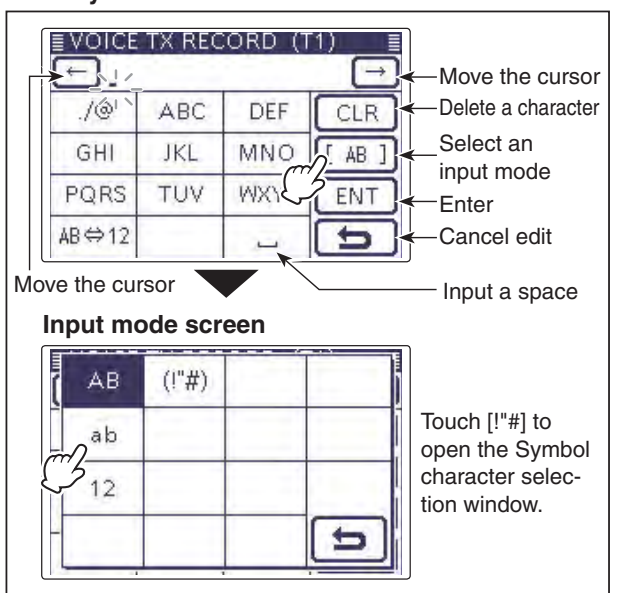
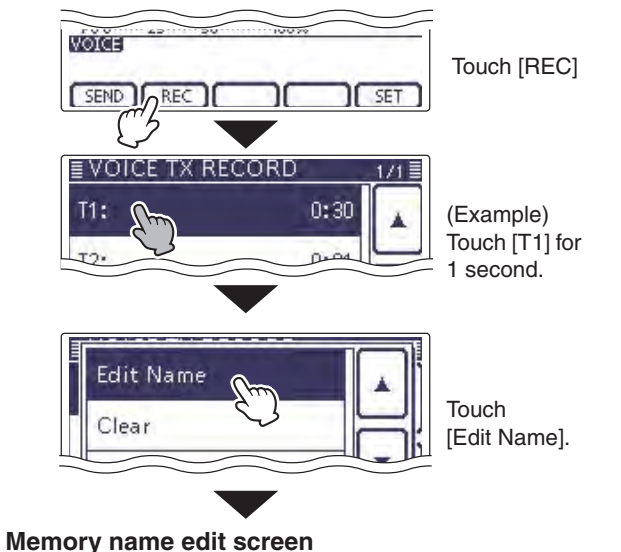
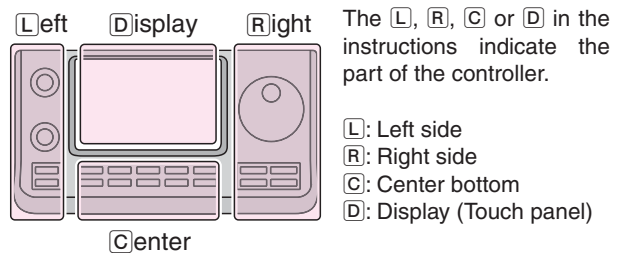

Continued on the next page.

15 VOICE TX FUNCTION

Programming a memory name (Continued)

- ⑧ Touch [←](D) to move the cursor backwards, or touch [→](D) to move the cursor forwards.
- ⑨ Repeat steps ⑦ and ⑧ to program up to 16 characters memory name, and then touch [ENT](D) to save the name, and return to the “VOICE TX RECORD” screen.
- ⑩ Touch [↵](D) to return to the “VOICE TX RECORD” screen.

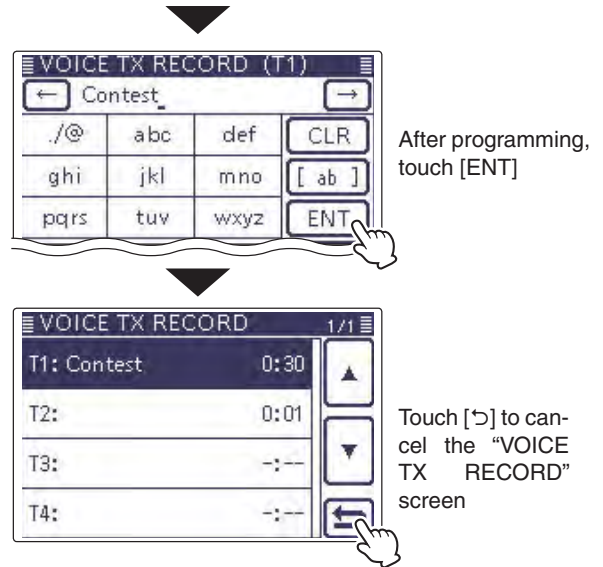

15 VOICE TX FUNCTION

Transmitting the recorded voice audio

- ① Push **MENU**(C) one or more times to select the “M-2” (Menu 2) screen.
 - In the DR mode, select the “D1” screen.
- ② Touch **[VOICE]**(D) to select the Voice TX mode.
 - “VOICE TX” screen is displayed.
- ③ Push **MENU**(C) to display the “VOICE” screen.
- ④ <<**Single TX**>>

Touch the desired memory, [T1] through [T4] to transmit the recorded voice audio once.

<<Repeat TX>>

Touch the desired memory, [T1] through [T4] for 1 second to repeatedly transmit the recorded voice audio for up to 10 minutes at the interval specified in “Repeat Time.”

- Even if 10 minutes pass while transmitting, the voice audio is completely transmitted.
- During the Voice TX waiting, the selected memory blinks.
- One of the following steps will cancel the transmission.
 - Touch the memory again.
 - Turn OFF the power, then turn it ON again.
 - Touch another memory (except for [LEVEL]).
 - Push **MENU**(C), **XFC**(R) or **SET**(C).
 - Push **QUICK**(C).

The repeat transmission is cancelled. But while transmitting, the voice audio is completely transmitted.

- Once the Repeat TX is made, the transceiver pauses until the end of the “Repeat Time,” then transmits again. After the second transmission, the Repeat TX continues pausing, if receiving a signal.

But if the squelch is manually opened, the voice audio is repeatedly transmitted, according to the repeat time setting.

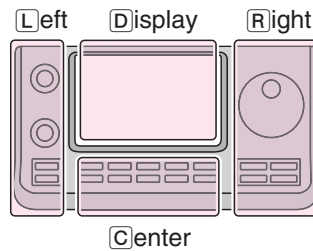

The L, R, C or D in the instructions indicate the part of the controller.

- L: Left side
- R: Right side
- C: Center bottom
- D: Display (Touch panel)

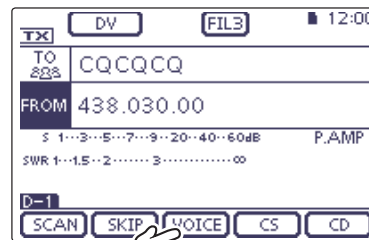

Touch **[VOICE]**

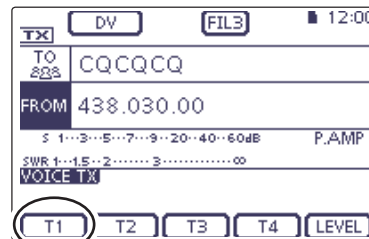

Touch the desired memory,

Single TX

Repeat TX

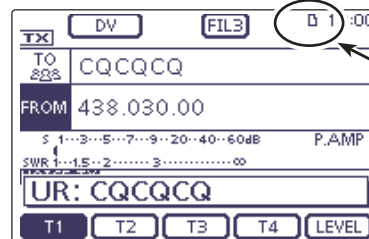

Blinks while transmitting

• Voice TX Waiting screen for <<Repeat TX>>

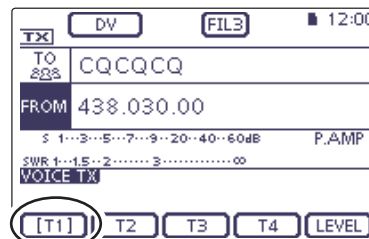

Blinks

15 VOICE TX FUNCTION

Transmitting the recorded voice audio (Continued)

◆ Adjusting the TX volume level

- ① Push **[MENU]**(C) one or more times to select the “M-2” (Menu 2) screen.
 - In the DR mode, select the “D1” screen.
- ② Touch **[VOICE]**(D) to select the Voice TX mode.
 - “VOICE TX” screen is displayed.
- ③ Touch **[LEVEL]**(D) to display the “TX LEVEL” screen.
- ④ Rotate the Dial to adjust the transmit voice level.
 - Too high of a voice level may cause interference.
 - Touch **[DEF]**(D) for 1 second to reset to the default setting (50 %), if desired.
- ⑤ Touch **[LEVEL]**(D) to save, and exit the “TX LEVEL” screen.

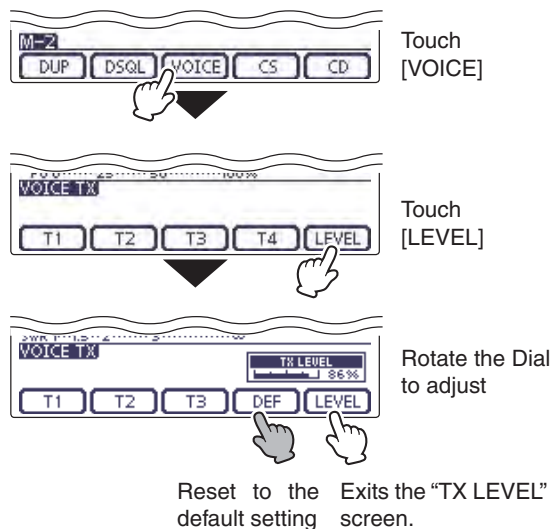

Hiding the Voice TX memory name

The voice TX memory name can be hidden on the “VOICE TX” screen.

- ① Push **[SET]**(C) to enter the Set mode.
- ② Touch the “VOICE TX Name Display” item of the “Display” Set mode.
 - (Display > **VOICE TX Name Display**)
 - If the specified item is not displayed, touch **[▲]** or **[▼]**(D) one or more times to select the page.
- ③ Touch “OFF.”
- ④ Push **[SET]**(C) to exit the Menu screen.

When “ON” is selected.

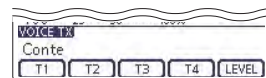

The voice TX memory name is displayed.

When “OFF” is selected.

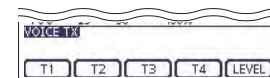

The voice TX memory name is not displayed.

Setting the VOICE first menu screen

Select the first appearance screen after touching **[VOICE]**(D).

- ① Push **[SET]**(C) to enter the Set mode.
- ② Touch the “VOICE 1st menu” item of the “Function” Set mode.
 - (Function > **VOICE 1st menu**)
 - If the specified item is not displayed, touch **[▲]** or **[▼]**(D) one or more times to select the page.
- ③ Touch the desired option.
 - VOICE-Root: Displays the “VOICE” screen first.
 - VOICE-TX: Displays the “VOICE TX” screen first.
- ④ Push **[SET]**(C) to exit the Menu screen.

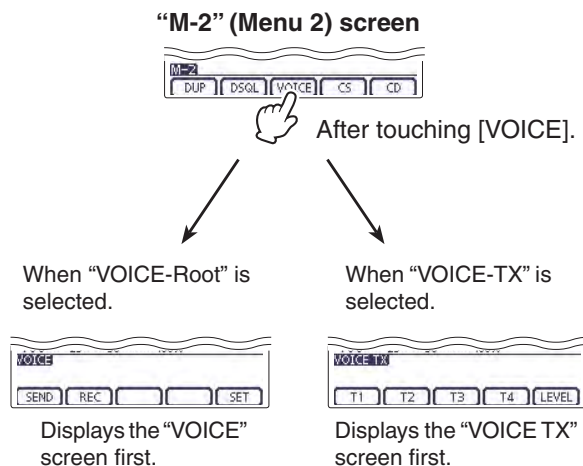

15 VOICE TX FUNCTION

Voice TX Set mode

- ① Push **MENU**(**C**) one or more times to select the “M-2” (Menu 2) screen.
 - In the DR mode, select the “D1” screen.
- ② Touch **[VOICE]**(**D**) to select the Voice TX mode.
 - “VOICE TX” screen is displayed.
- ③ Push **MENU**(**C**) to display the “VOICE” screen.
- ④ Touch **[SET]**(**D**) to display the “VOICE TX SET” screen.
- ⑤ Touch a desired item.
- ⑥ Touch a desired option.
 - See the descriptions below for details of items and options.
 - Push **QUICK**(**C**), and then touch “Default” to reset to the default setting, if desired.
- ⑦ Push **MENU**(**C**) to return to the “VOICE” screen.

Repeat Time (Default: 5sec)

Set the repeat interval to between 1 and 15 seconds (in 1 second steps) for the voice repeat transmission. The transceiver repeatedly transmits the recorded voice audio at this interval.

Auto Monitor (Default: ON)

Turn the TX Monitor function ON or OFF.

- OFF: The TX voice audio is not heard from the speaker.
- ON: The TX voice audio is heard from the speaker.

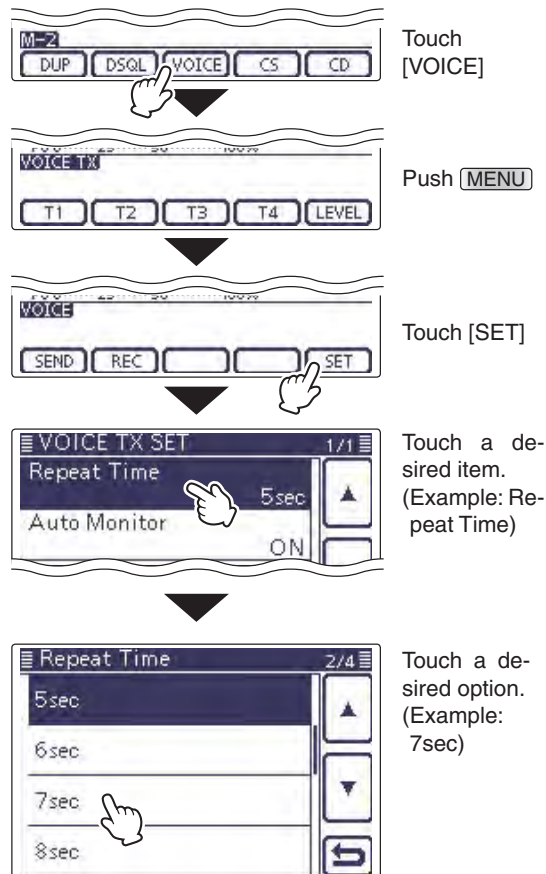

Section 16 ANTENNA TUNER OPERATION

Front panel	00
Front panel	00
Front panel	00
Front panel	00

16 ANTENNA TUNER OPERATION

Connecting the antenna tuner

The AH-4 and AT-180 AUTOMATIC ANTENNA TUNER matches the IC-7100 to the connected antenna automatically.

Once the tuner matches an antenna, the variable capacitor settings are memorized as a preset point for each frequency range (100 kHz steps). Therefore, when you change the frequency range, the variable capacitors are automatically preset to the memorized point.

NOTE: Before connecting, be sure to turn OFF the transceiver's power.

Connecting an AH-4

The optional AH-4 matches the IC-7100 to a long wire antenna more than 7 m/23 ft long (3.5 MHz and above).

- See page ??-?? for operation.
- See the AH-4 instruction manual installation and antenna connection details.

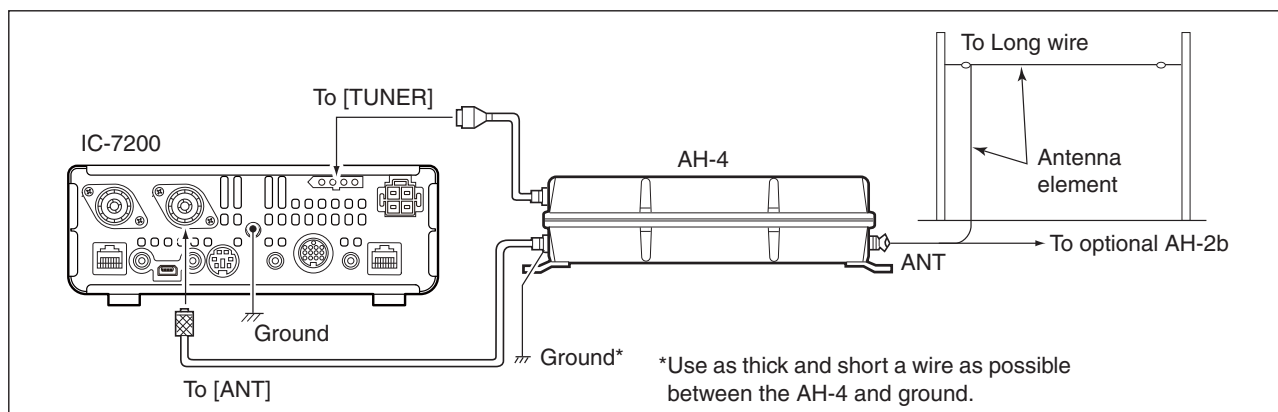

Connecting an AT-180

The optional AT-180 matches the IC-7100 to both HF and 50 MHz antenna, and automatically tunes the antenna (impedance range: 16.7 to 150 Ω) during transmission when the antenna SWR is less than 1.5:1.

- See page ??-?? for operation.

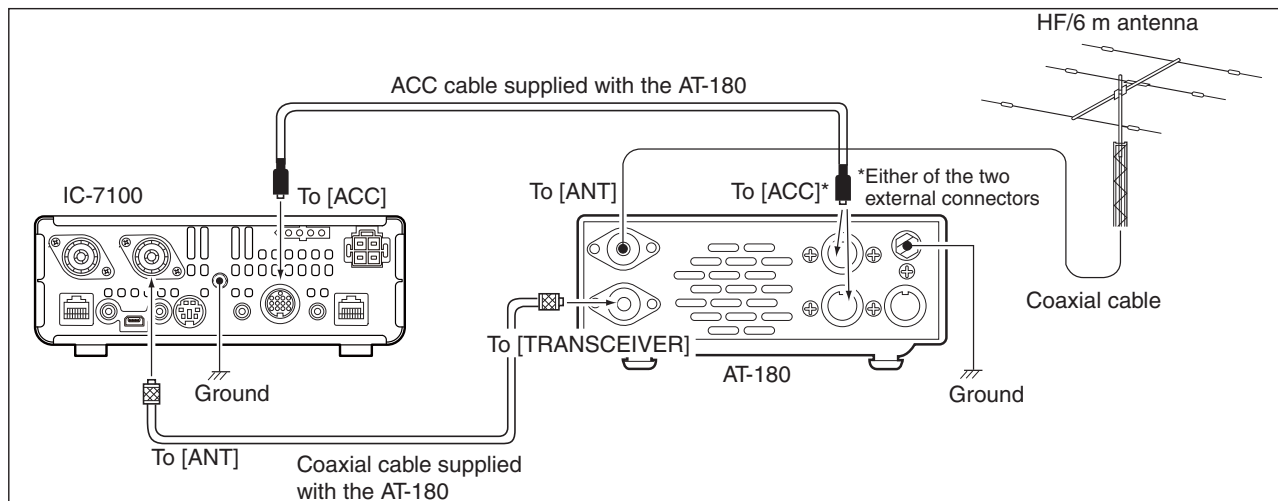

16 ANTENNA TUNER OPERATION

Connecting the antenna tuner (Continued)

◇ Connector information for the ACC(2) socket

PIN LAYOUT	PIN NO./ NAME	DESCRIPTION	SPECIFICATIONS
 <p>(Front panel view)</p>	① 8 V	Regulated 8 V output when the Band Voltage modification is performed. (p. ??-??)	Same as ACC pin ①.
	② GND	Connects to ground.	–
	③ HSEND	Input/output pin. Goes to ground when transmitting When grounded, transmits.	Same as ACC pin ③.
	④ NC	No connection.	–
	⑤ ALC	ALC output voltage	Same as ACC pin ⑥.
	⑥ NC	No connection.	–
	⑦ 13.8 V	13.8 V output when power is ON	Same as ACC pin ⑧.

◇ Specifications for the AH-4

- Frequency coverage : 7–54 MHz (with an AH-2b)
3.5–54 MHz (with more than 7 meters long wire)
- Input impedance : 50 Ω
- Maximum input power : 120 W
- Minimum tuning power : 10 W (5–15 W)
- Tuning accuracy : Less than SWR 2:1
- Power supply requirements : 13.8 V DC/1 A (supplied from the transceiver's ACC socket)
- Dimensions (mm/in) : 172(W) × 69.5(H) × 230(D)
6.7 (W) × 2.7(H) × 9.0(D)
- Weight (Approximately) : 1.2 kg; 2.6 lb
- Supplied accessories : See the AH-4 instruction manual

◇ Specifications for the AT-180

- Frequency coverage : 1.8–54 MHz
- Input impedance : 50 Ω
- Maximum input power : 120 W
- Minimum tuning power : 8 W
- Matching impedance range : 16.7–150 Ω (HF band)
20–125 Ω (50 MHz band)
- Tuning accuracy : Less than SWR 1.5:1
- Insertion loss : Less than 1.0 dB (after tuning)
- Power supply requirements : 13.8 V DC/1 A (supplied from the transceiver's ACC socket)
- Dimensions (mm/in) : 167(W) × 58.6(H) × 225(D)
6.6(W) × 2.3(H) × 8.9(D)
- Weight (Approximately) : 2.3 kg; 5.1 lb
- Supplied accessories : ACC cable (DIN 13 pins)
Coaxial cable (1 m),

16 ANTENNA TUNER OPERATION

Operating the AH-4

◇ Before operating

⚠ DANGER HIGH VOLTAGE!

NEVER touch the antenna element while tuning or transmitting.
Always place it in a secure place.

NEVER operate the AH-4 without an antenna connected. The tuner and transceiver will be damaged.

NEVER operate the AH-4 when it is ungrounded.

Transmitting before tuning may damage the transceiver. Note that the AH-4 cannot tune when using a $1/2\lambda$ long wire or on a multiple of that frequency.

◇ Operating

Tuning is required for each frequency. Be sure to retune the antenna before transmitting when you change the frequency—even slightly.

- 1 Push **TUNER/CALL**(L) or **[TUNER/CALL]** on the remote control microphone to turn ON the AH-4. The CW mode and 10 W output power are automatically selected, and the tuning starts.

- The TX indicator lights red.
- **TUNE** blinks while tuning.
- After changing the frequency, you should hold down **TUNER/CALL**(L) or **[TUNER/CALL]** on the remote control microphone for second to manually start tuning. In this case, the CW mode and 10 W output power are automatically selected, and the TX indicator lights red.

NOTE: DO NOT change the frequency and operating mode while **TUNE** is blinking. It may takes approximately 2 to 3 seconds (maximum of 15 seconds) to complete tuning.

- 2 **TUNE** is still ON after the tuning is completed, and the previously selected operating mode and the output power are automatically selected.
 - When the connected wire cannot be tuned, **TUNE** goes out, the AH-4 is bypassed and the antenna wire is directly connected.

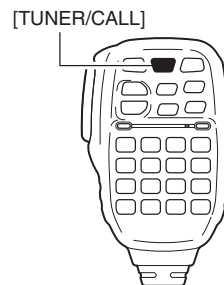
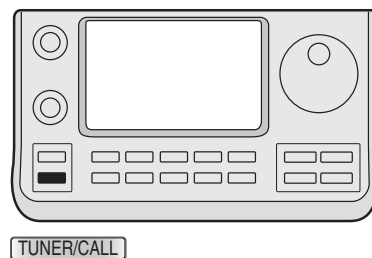
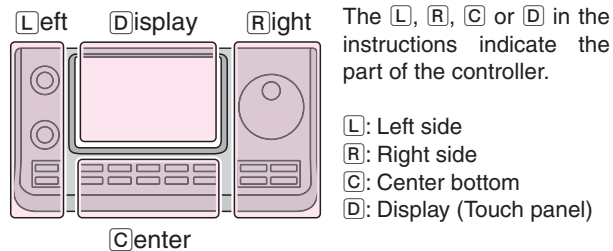

◇ PTT tune function

The AH-4 always tunes when **[PTT]** is pushed after the frequency is changed on an HF band (more than 1%). Turn ON this function in the Set mode.

(Function > Tuner > **PTT Start**)

16 ANTENNA TUNER OPERATION

Operating the AT-180

◇ Before operating

CAUTION:

- **NEVER** transmit with the tuner ON if no antenna is connected. This will damage both the transceiver and antenna tuner.
- **NEVER** transmit with the tuner ON if no antenna is connected. This will damage both the transceiver and antenna tuner.

NEVER operate the AH-4 without an antenna connected. The tuner and transceiver will be damaged.

NEVER operate the AH-4 when it is ungrounded.

Transmitting before tuning may damage the transceiver. Note that the AH-4 cannot tune when using a $1/2\lambda$ long wire or on a multiple of that frequency.

16 ANTENNA TUNER OPERATION

Operating the AT-180 (Continued)

◇ Operating

The AT-180 AUTOMATIC ANTENNA TUNER automatically matches to your antenna. Once the tuner matches the antenna, the variable capacitor settings are memorized as a preset point for each frequency range (100 kHz steps). Therefore, when you change the frequency range, the variable capacitors are automatically preset to the memorized point.

NOTE:

- The AT-180 can match both the HF and 50 MHz bands. However, operation is different for the bands.
- When connecting the AT-180, the transceiver's output power should be more than 8 W. Otherwise, the AT-180 may not tune correctly. The AT-180's minimum operating input power is 8 W.

- ① Check the transceiver's output power is set to 8 W/
- ② Push **TUNER/CALL**(L) or [TUNER/CALL] on the remote control microphone to turn ON the AT-180.
 - "TUNE" appears.

For the HF band:

The antenna is automatically tuned during transmit if the antenna SWR is higher than 1.5:1.

For the 50 MHz band:

"TUNE" blinks if the antenna SWR is higher than 1.5:1, regardless of the internal switch position described on the page ??-??. In this case, do the step ③ to manually tune the antenna.

- ③ Push **TUNER/CALL**(L) or [TUNER/CALL] on the remote control microphone for 1 second to start manual tuning.
 - When the CW mode is selected, a side tone is emitted, and "TUNE" blinks.

NOTE: DO NOT change the frequency and operating mode while "TUNE" is blinking.

- ④ "TUNE" is still ON after the tuning is completed, and the previously selected operating mode is automatically selected.
 - When the connected wire cannot be tuned, "TUNE" goes out, the AH-4 is bypassed and the antenna wire is directly connected.

Once the tuner matches the antenna, the variable capacitors are automatically preset to the memorized point when you change the frequency range in 100 kHz steps.

- While presetting, "TUNE" blinks.

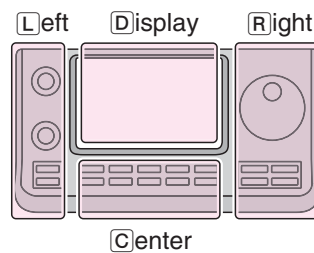

The L, R, C or D in the instructions indicate the part of the controller.

- L: Left side
- R: Right side
- C: Center bottom
- D: Display (Touch panel)

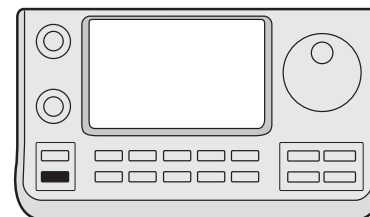

TUNER/CALL

[TUNER/CALL]



16 ANTENNA TUNER OPERATION

Setting the AT-180 internal switches

The optional AT-180 has 3 operating configurations for HF band operation. Select a suitable configurations for your antenna system.

- ① Remove the top cover of the AT-180.
- ② Set the tuner switches to the desired positions according to the table below.

SW	Position	Operation
S1	A (default)	The tuner operating mode is set by S2 described below.
	B	THROUGH INHIBIT The tuner tunes the antenna even when the antenna has poor SWR (up to VSWR 3:1 after tuning). In this case, manual tuning is necessary each time you change the frequency although the tuner automatically starts tuning when the VSWR is higher than 3:1. This setting is called "through inhibit," however, the tuner is set to "through" if the VSWR is higher than 3:1 after tuning.
S2	C	TUNER SENSITIVE SETTING The tuner tunes each time you transmit (except SSB mode). Therefore, the lowest SWR is obtained at any given time. For SSB mode, the same SETTING as the "D" position.
	D (default)	NORMAL The tuner tunes when the SWR is higher than 1.5:1. Therefore, the tuner activates only when tuning is necessary.

• AT-180 inside top cover

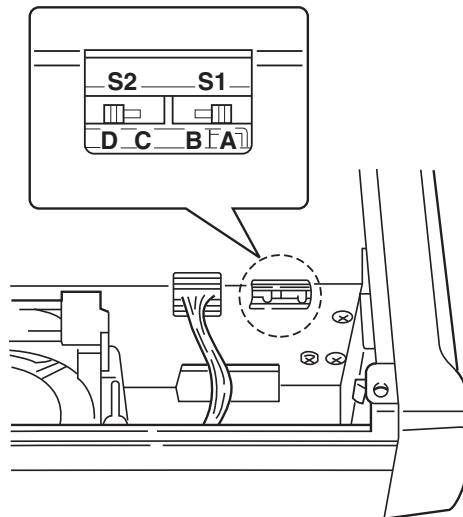

◇ Automatic tuner start (HF bands only)

If you want to turn OFF the tuner when the VSWR is 1.5:1 or less, use "automatic tuner on" and turn OFF the tuner. See page 10-11 for automatic tuner function.

◇ PTT tune function

The AT-180 tunes when [PTT] is pushed after the frequency is changed (more than 1%) if the AT-180 is turned ON. This function removes the "hold down **TUNER**" operation and activates with the first transmission on the new frequency. (p. 10-11)

Turn this function ON in the Set mode.

Section 17 SET MODE

- Set mode description 17-2**
 - ◇ The Set mode settings 17-2
- Set mode items and Default settings..... 17-3**
- Voice Memo Set mode..... 17-11**
- DV Set mode 17-13**
- SPEECH Set mode..... 17-15**
- QSO/RX Log Set mode..... 17-16**
- Function Set mode 17-18**
- Tone Control Set mode 17-23**
- Connectors Set mode 17-24**
- Display Set mode..... 17-27**
- Time Set Set mode 17-30**
- Others Set mode..... 17-31**

17 SET MODE

Set mode description

The Set mode is used to program infrequently changed values or function settings.

NOTE: The Set mode is constructed in a tree structure. You may go to the next tree level, or go back a level, depending on the selected item.

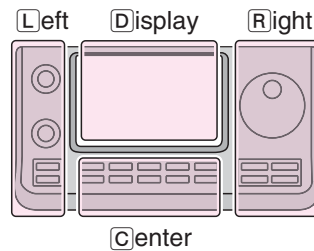

The **L**, **R**, **C** or **D** in the instructions indicate the part of the controller.

- L**: Left side
- R**: Right side
- C**: Center bottom
- D**: Display (Touch panel)

◆ The Set mode settings

- ① Push **SET**(**C**) to enter the Set mode.
- ② If the specified item is not displayed, touch **[▲]** or **[▼]** (**D**) one or more times to select the page.
 - If **[▲]**(**D**) or **[▼]**(**D**) is continuously held down, the pages are quickly scrolled.
 - Rotating the Dial also selects the pages.
- ③ Touch the desired item to go to the next level.
- ④ Repeat steps ② and ③ to show the desired item's setting screen.
 - To go back the previous tree level, touch **[↶]**(**D**), or **MENU**(**C**).
- ⑤ Touch a desired option shown on the display, or **[+]**/**[-]**(**D**) to adjust a level.
 - When you touch an option, it is automatically saved and the screen returns to the previous display.
 - Rotating the Dial also adjusts the level.
 - Push **QUICK**(**C**), and then touch "Default" to reset to the default setting, if desired.
 - To set other item, touch **[↶]**(**D**), or **MENU**(**C**) to go back a tree level.
- ⑥ Push **SET**(**C**) to exit the Set mode.

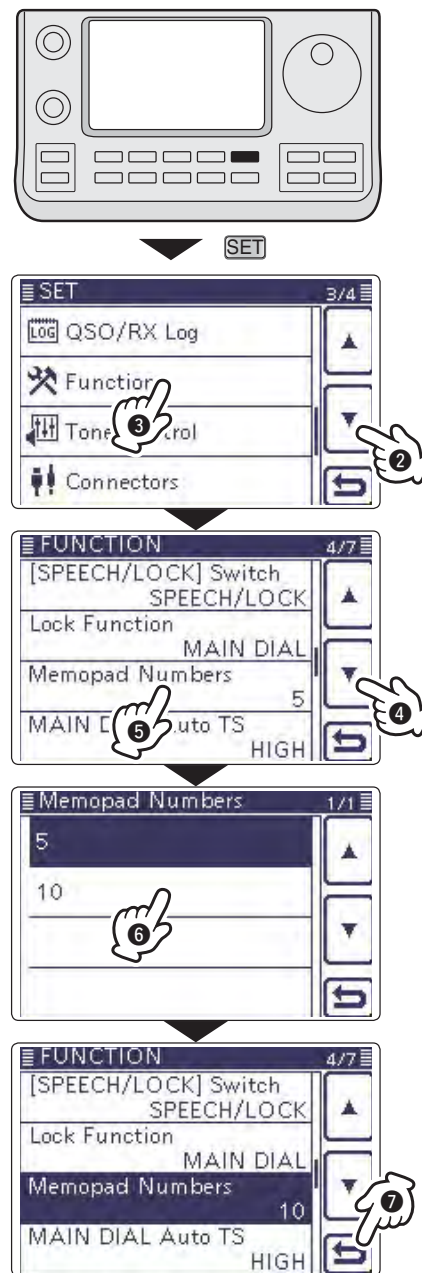

17 SET MODE

Set mode items and Default settings

- ➔ Call sign (Section 9)
- ➔ RX Record (Section 9)
- ➔ MY Station (Section 7)
- ➔ SD Card (Section 13)
- ➔ GPS (Section 10)

/// **NOTE:** The default settings shown below in bold are for the USA version.
 /// The default settings may differ, depending on your transceiver version.

Voice Memo		In this item, set the TX/RX voice recording options.
QSO Recorder		
<<REC Start>>*		Starts recording the received audio.
Play Files*		Selects to playback or delete the recorded audio.
Recorder Set		
REC Mode	TX&RX or RX Only	Selects to record the TX audio or not.
RX REC Condition	Always or Squelch Auto	Selects whether or not the squelch status affects the RX voice audio recording.
File Split	OFF or ON	Selects whether or not to automatically create a new file after each transmission, reception, or each time the squelch opens or closes.
PTT Auto REC	OFF or ON	Turns the PTT Automatic Recording function ON or OFF.
Player Set		
Skip Time	3sec, 5sec, 10sec or 30sec	Sets the Skip time to rewind or forward the recorded audio when you push the fast-rewind or fast-forward key during playback.
DV Auto Reply*		Records a voice audio to use for the Auto Reply function in the DV mode.

* Be sure to insert the SD card into the transceiver before selecting these items.

DV Set		In this item, set infrequently changed values or functions in the DV mode.
Standby Beep	OFF, ON or ON (to me: High Tone)	Selects whether or not to sound a beep after a received signal disappears.
Auto Reply	OFF , ON or Voice	Selects whether or not to automatically reply to a call addressed to your own call sign.
DV Data TX	PTT or Auto	Selects to manually or automatically transmit low speed data.
Digital Monitor	Auto , Digital or Analog	Selects the DV mode RX monitoring when [XFC] is held down.
Digital Repeater Set	OFF or ON	Turns the digital repeater setting function ON or OFF. This function is usable in any DV mode except the DR mode.
RX Call Sign Write	OFF or Auto	Turns the RX call sign automatic write function ON or OFF. This function is usable in any DV mode except the DR mode.
RX Repeater Write	OFF or Auto	Turns the repeater call sign automatic write function ON or OFF. This function is usable in any DV mode except the DR mode.
DV Auto Detect	OFF or ON	Turns the DV mode automatic detect function ON or OFF.
RX Record (RPT)	ALL or Latest Only	Selects whether to record all calls or only the latest call, when the received signal includes a status message ("UR?" or "RPT?") that is sent back from the access repeater.
BK	OFF or ON	Turns the BK (Break-in) function ON or OFF. The BK function allows you to break into a conversation between two stations with call sign squelch enabled.
EMR	OFF or ON	Turns the EMR (Enhanced Monitor Request) communication mode ON or OFF. After turning OFF the transceiver, the EMR mode will be cancelled.
EMR AF Level	0%~ 50% ~100%	Sets the audio output level when an EMR mode signal is received.

17 SET MODE

Set mode items and Default settings (Continued)

/// **NOTE:** The default settings shown below in bold are for the USA version.
 /// The default settings may differ, depending on your transceiver version.

SPEECH		
In this item, set the Speech options.		
RX Call Sign SPEECH	OFF, ON (Kerchunk) or ON (All)	Selects the RX call sign speech function option while ON, or turn it OFF.
RX>CS SPEECH	OFF or ON	Turns the RX>CS Speech function ON or OFF.
S-Level SPEECH	OFF or ON	Turns the Signal Strength Level Speech function ON or OFF.
MODE SPEECH	OFF or ON	Turns the Operating Mode Speech function ON or OFF.
SPEECH Language	English or Japanese	Selects either English or Japanese as the desired speech language.
Alphabet	Normal or Phonetic Code	Selects the alphabet character announcement type.
SPEECH Speed	Slow or Fast	Selects Slow or Fast speech speed.
SPEECH Level	0%~ 50% ~100%	Sets the volume level for the voice synthesizer.
QSO/RX Log		
In this item, set the QSO/RX History Log options.		
QSO Log*1	OFF or ON	Selects whether or not to make a communication log on the SD card.
RX History Log*1	OFF or ON	Selects whether or not to make a DV mode's receive history log on the SD card.
CSV Format		
Separator/Decimal	Sep [,] Dec [.] ^{*2} , Sep [;] Dec [.] or Sep [;] Dec [,]	Selects the separator and the decimal character for the CSV format.
Date	yyyy/mm/dd, mm/dd/yyyy ^{*2} or dd/mm/yyyy	Selects the date format.
*1 Be sure to insert the SD card into the transceiver before selecting these items.		
*2 The default value may differ, depending on the transceiver version.		

17 SET MODE

Set mode items and Default settings (Continued)



/// **NOTE:** The default settings shown below in bold are for the USA version.
 /// The default settings may differ, depending on your transceiver version.

Function	In this item, set the function options.	
Monitor	OFF or ON	Selects whether or not to monitor your transmit signal in any mode other than CW.
Monitor Level	0%~ 50% ~100%	Sets the monitor level.
Beep Level	0%~ 50% ~100%	Sets the beep output level.
Beep Level Limit	OFF or ON	Selects whether or not to limit the volume to the specified level, and further rotation of the [AF] control will not increase the level.
Beep (Confirmation)	OFF or ON	Turns the confirmation beep tones ON or OFF.
Band Edge Beep	OFF, ON (Default) , ON (User) or ON (User) & TX Limit	Selects whether or not to sound a beep when you tune outside of, or back into the amateur band's frequency range.
User Band Edge	1: 1.800.000–1.999.999 2: 3.500.000–3.999.999 3: 7.000.000–7.300.000 4: 10.100.000–10.150.000 5: 14.000.000–14.350.000 6: 18.068.000–18.168.000 7: 21.000.000–21.450.000 8: 24.890.000–24.990.000 9: 28.000.000–29.700.000 10: 50.000.000–54.000.000 11: 144.000.000–146.000.000 12: 430.000.000–440.000.000 13~30: (blank)	Selects the user band frequency range to sound a beep when the Band Edge Beep function is set to "ON (User)" or "ON (User) & TX Limit," and you tune outside of, or back into a programmed range.
RF/SQL Control	Auto, SQL or RF+SQL	Select the function of the [RF/SQL] control.
TX Delay		
HF	OFF , 10ms, 15ms, 20ms, 25ms or 30ms	Sets the transmission's timing of the IC-7100 to prevent any external equipment that is connected from damage by the reflected wave.
50M	OFF , 10ms, 15ms, 20ms, 25ms or 30ms	Sets the transmission's timing of the IC-7100 to prevent any external equipment that is connected from damage by the reflected wave.
144M	OFF , 10ms, 15ms, 20ms, 25ms or 30ms	Sets the transmission's timing of the IC-7100 to prevent any external equipment that is connected from damage by the reflected wave.
430M	OFF , 10ms, 15ms, 20ms, 25ms or 30ms	Sets the transmission's timing of the IC-7100 to prevent any external equipment that is connected from damage by the reflected wave.
Time-Out Timer	OFF , 3min, 5min, 10min, 20min or 30min	Selects the Time-Out Timer time options to prevent an accidental prolonged transmission.
PTT Lock	OFF or ON	Selects whether or not to inhibit transmission.
SPLIT/DUP		
Quick SPLIT	OFF or ON	Turns the Quick SPLIT function ON or OFF.
SPLIT Offset	-9.999 MHz~ 0.000 MHz ~+9.999 MHz	Sets the frequency offset for the Split function.
SPLIT LOCK	OFF or ON	Turns the SPLIT LOCK function ON or OFF.
DUP Offset	0.0000 MHz~9.9999 MHz (The default value may differ, depending on the frequency band and the transceiver version.)	Sets the frequency offset for repeater operation.
One Touch Repeater	DUP- or DUP+	Selects the duplex direction for the One Touch Repeater function.
Auto Repeater	OFF, ON (DUP) or ON (DUP,TONE)	Turns the Auto Repeater function ON or OFF.

17 SET MODE

Set mode items and Default settings (Continued)

/// **NOTE:** The default settings shown below in bold are for the USA version.
 /// The default settings may differ, depending on your transceiver version.

Tuner		
Auto Start	OFF or ON	Turns the automatic antenna tuner function ON or OFF.
PTT Start	OFF or ON	Turns the PTT Tuner Start function ON or OFF.
[TUNER] Switch	Manual or Auto	Selects whether or not to store the AT-180's status by each band.
[SPEECH/LOCK] Switch	SPEECH/LOCK , LOCK/SPEECH	Selects the function for  when pushed or held down.
Lock Function	MAIN DIAL or PANEL	Selects the dial lock function to prevent frequency changes by accidental movement of the tuning dial.
Memopad Numbers	5 or 10	Sets the number of usable memopad channels.
MAIN DIAL Auto TS	OFF, LOW or HIGH	Selects an option for the automatic tuning step function. When rapidly rotating the main dial, the tuning step automatically changes according to the setting.
MIC Up/Down Speed	Slow or Fast	Selects the steps per second when changing an operating frequency by holding down the microphone's  key.
[NOTCH] Switch (SSB)	Auto, Manual or Auto/Manual	Selects the notch function for the SSB mode.
[NOTCH] Switch (AM)	Auto, Manual or Auto/Manual	Selects the notch function for the AM mode.
SSB/CW Sync Tuning	OFF or ON	Turns the Synchronous Tuning function ON or OFF to shift the operating frequency by the offset amount to keep receiving a signal when the operating mode is changed between SSB and CW.
CW Normal Side	LSB or USB	Sets the carrier point for CW normal mode operation to the LSB side or the USB side.
VOICE 1st Menu	VOICE-Root or VOICE-TX	Select whether or not to directly select the voice send menu, skipping the voice menu.
KEYER 1st Menu	KEYER-Root or KEYER-SEND	Select whether or not to directly select the keyer send menu, skipping the memory keyer menu.
Speaker Out	OFF or ON	Selects to mute the speaker output.
MIC AF Out	OFF or ON	Selects to output the received audio from the [MIC] connector.
RC MIC		
[F-1]	---, P.AMP/ATT, AGC, NB, NR, NOTCH, RIT, AUTOTUNE/RX>CS, TS, MPAD, M-CLR, BANK, SPLIT , A/B, DUP, TONE/DSQL, COMP, TBW, METER, DR, FROM/TO(DR), SCAN, Voice TX (T1)	The functions listed to the left can be set to [F-1] of the optional HM-151 REMOTE CONTROL MIC.
[F-2]	---, P.AMP/ATT, AGC, NB, NR, NOTCH, RIT, AUTOTUNE/RX>CS, TS, MPAD, M-CLR, BANK, SPLIT , A/B, DUP, TONE/DSQL, COMP, TBW, METER, DR, FROM/TO(DR), SCAN, Voice TX (T1)	The functions listed to the left can be set to [F-2] of the optional HM-151 REMOTE CONTROL MIC.
Mode Select	<input type="checkbox"/> SSB, <input type="checkbox"/> CW, <input type="checkbox"/> RTTY, <input type="checkbox"/> AM, <input type="checkbox"/> FM, <input type="checkbox"/> WFM, <input type="checkbox"/> DV (All boxes are checked.)	Disables the mode selection of the optional HM-151 REMOTE CONTROL MIC, to simplify operation.
Power OFF (With No Controller)	OFF or ON	Selects whether or not to automatically turn OFF the transceiver when the controller is disconnected from the transceiver.
REF Adjust	0 %~100 %	Sets a number to adjust for a zero beat with a standard signal such as WWV or WWVH, for frequency calibration.

17 SET MODE

Set mode items and Default settings (Continued)

/// **NOTE:** The default settings shown below in bold are for the USA version.
 /// The default settings may differ, depending on your transceiver version.

Tone Control		In this item, set the RX/TX tone control options.	
RX			
SSB			
RX HPF/LPF	---- - ----, 100~2000 – 500~2400		Sets the high-pass filter or low-pass filter of the receive audio.
RX Bass	-5~ 0 ~+5		Sets the bass level of the receive audio.
RX Treble	-5~ 0 ~+5		Sets the treble level of the receive audio.
AM			
RX HPF/LPF	---- - ----, 100~2000 – 500~2400		Sets the high-pass filter or low-pass filter of the receive audio.
RX Bass	-5~ 0 ~+5		Sets the bass level of the receive audio.
RX Treble	-5~ 0 ~+5		Sets the treble level of the receive audio.
FM			
RX HPF/LPF	---- - ----, 100~2000 – 500~2400		Sets the high-pass filter or low-pass filter of the receive audio.
RX Bass	-5~ 0 ~+5		Sets the bass level of the receive audio.
RX Treble	-5~ 0 ~+5		Sets the treble level of the receive audio.
DV			
RX HPF/LPF	---- - ----, 100~2000 – 500~2400		Sets the high-pass filter or low-pass filter of the receive audio.
RX Bass	-5~ 0 ~+5		Sets the bass level of the receive audio.
RX Treble	-5~ 0 ~+5		Sets the treble level of the receive audio.
WFM			
RX Bass	-5~ 0 ~+5		Sets the bass level of the receive audio.
RX Treble	-5~ 0 ~+5		Sets the treble level of the receive audio.
CW			
RX HPF/LPF	---- - ----, 100~2000 – 500~2400		Sets the high-pass filter or low-pass filter of the receive audio.
RTTY			
RX HPF/LPF	---- - ----, 100~2000 – 500~2400		Sets the high-pass filter or low-pass filter of the receive audio.
TX			
SSB			
TX Bass	-5~ 0 ~+5		Sets the bass level of the transmit audio.
TX Treble	-5~ 0 ~+5		Sets the treble level of the transmit audio.
TBW (WIDE)	100 , 200, 300, 500 – 2500, 2700, 2800, 2900		Sets the lower and higher cut-off frequencies to change the transmission passband width for the wide setting.
TBW (MID)	100, 200, 300 , 500 – 2500, 2700 , 2800, 2900		Sets the lower and higher cut-off frequencies to change the transmission passband width for the mid setting.
TBW (NAR)	100, 200, 300, 500 – 2500 , 2700, 2800, 2900		Sets the lower and higher cut-off frequencies to change the transmission passband width for the narrow setting.
AM			
TX Bass	-5~ 0 ~+5		Sets the bass level of the transmit audio.
TX Treble	-5~ 0 ~+5		Sets the treble level of the transmit audio.
FM			
TX Bass	-5~ 0 ~+5		Sets the bass level of the transmit audio.
TX Treble	-5~ 0 ~+5		Sets the treble level of the transmit audio.
DV			
TX Bass	-5~ 0 ~+5		Sets the bass level of the transmit audio.
TX Treble	-5~ 0 ~+5		Sets the treble level of the transmit audio.

17 SET MODE

Set mode items and Default settings (Continued)

/// **NOTE:** The default settings shown below in bold are for the USA version.
 /// The default settings may differ, depending on your transceiver version.

Connectors	In this item, set the external connector's options.	
USB Audio SQL	OFF (OPEN) or ON	Selects whether or not to output the audio from the [USB] connector, according to the squelch state (open or closed).
ACC/USB Output Select	AF or IF	Sets the [USB] connector and the [ACC] socket usage to received audio output or the IF output for DRM (Digital Radio Mondiale).
ACC/USB AF Level	0 %~ 50 %~100 %	Sets the audio output level at the [ACC] socket and the [USB] connector.
ACC/USB IF Level	0 %~ 50 %~100 %	Sets the IF output level at the [ACC] socket and the [USB] connector.
ACC MOD Level	0 %~ 50 %~100 %	Sets the input modulation level at the [ACC] socket.
DATA MOD Level	0 %~ 50 %~100 %	Sets the input modulation level at the [DATA] jack.
USB MOD Level	0 %~ 50 %~100 %	Sets the input modulation level at the [USB] connector.
DATA OFF MOD	MIC, ACC, MIC,ACC or USB	Selects the connector(s) for the desired modulation to input when the data mode is not used.
DATA MOD	MIC, ACC , MIC,ACC or USB	Selects the connector(s) for the desired modulation to input when the data mode is used.
External Keypad		
VOICE	OFF or ON	Selects whether or not to transmit voice memory contents using the external keypad.
KEYER	OFF or ON	Selects whether or not to transmit keyer memory contents using the external keypad.
RTTY	OFF or ON	Selects whether or not to transmit RTTY memory contents using the external keypad.
CI-V		
CI-V Baud Rate	300, 1200, 4800, 9600, 19200 or Auto	Sets the CI-V code transfer speed.
CI-V Address	01h~ 88h ~DFh	Sets the transceiver's unique CI-V hexadecimal address code.
CI-V Transceive	OFF or ON	Turns the CI-V Transceive function ON or OFF.
USB2/DATA1 Function		
USB2 Function	OFF , RTTY Decode or DV Data	Selects the use of the COM port (USB2).
DATA1 Function	OFF, RTTY Decode, DV Data or GPS	Select the use of the [DATA1] jack.
GPS Out	OFF or DATA1 → USB2	Selects whether or not to output the data to the COM port (USB2) when data is input from a GPS receiver through the [DATA1] jack.
DV Data/GPS Out Baud	4800 or 9600	Sets the DV or GPS data transfer speed
RTTY Decode Baud	300, 1200, 4800, 9600 or 19200	Sets the RTTY decode monitor speed.
VSEND Select	OFF, UHF or VHF/UHF	Selects the band to use for the [ACC] socket's pin 7 (VSEND usage).
9600bps Mode	OFF or ON	Selects whether or not to allow data transmission at 9600 bps.

17 SET MODE

Set mode items and Default settings (Continued)

/// **NOTE:** The default settings shown below in bold are for the USA version.
 /// The default settings may differ, depending on your transceiver version.

Display		
In this item, set the transceiver's display options.		
LCD Contrast	0%~ 25% ~100%	Sets the contrast level of the LCD.
LCD Backlight	0%~ 50% ~100%	Sets the backlight level of the LCD.
Key Backlight	0%~ 50% ~100%	Sets the backlight level of the key.
Meter Peak Hold	OFF or ON	Turns the Meter Peak Hold function ON or OFF.
BW Popup (PBT)	OFF or ON	Selects whether or not to display the PBT shifting value while rotating the TWIN-PBT control.
BW Popup (FIL)	OFF or ON	Selects whether or not to display the IF filter width and shifting value when the IF filter is switched.
RX Call Sign Display	OFF, Auto or Auto (RX Hold)	Selects whether or not to display the call sign of the caller station when a call is received.
RX Message Display	OFF or Auto	Selects whether or not to display and scroll a received message.
Reply Position Display	OFF or ON	Selects whether or not to display the caller's position data when the data is included in the Auto Replay signal.
TX Call Sign Display	OFF, Your Call Sign or My Call Sign	Selects whether or not to display My or Your call sign while transmitting.
Scroll Speed	Slow or Fast	Sets the scrolling speed of the message, call sign, or other text, that are displayed on the transceiver's LCD.
VOICE TX Name Display	OFF or ON	Selects whether or not to display the voice TX memory name on the voice TX memory selection display.
KEYER Memory Display	OFF or ON	Selects whether or not to display the keyer memory contents on the keyer send selection display.
Opening Message	OFF or ON	Selects whether or not to display the opening message at power ON.
Power ON Check	OFF or ON	Selects whether or not to display the RF Power, RIT, Auto Power OFF condition at power ON.
Display Language	English or Japanese	Sets the screen display language type in the DR mode or Menu mode. When the System Language is "English," this item disappears.
System Language	English or Japanese	Sets the system language of the transceiver.
Time Set		
In this item, set the time options.		
Date/Time		
DATE	2000/01/01 ~2099/12/31	Sets the date.
TIME	0:00 ~23:59	Sets the time.
GPS Time Correct	OFF or Auto	Selects whether or not to automatically correct the time data by a received GPS sentence.
UTC Offset	-14:00~ +9:00 ~+14:00	Sets the time difference between UTC (Universal Time Coordinated) and the local time.
Clock Display	Local or UTC	Sets the clock display mode.
Auto Power OFF	OFF , 30min, 60min, 90min or 120min	Sets to automatically turn OFF the transceiver power after no operation is made during this set period.

17 SET MODE

Set mode items and Default settings (Continued)

/// **NOTE:** The default settings shown below in bold are for the USA version.
 /// The default settings may differ, depending on your transceiver version.

Others	In this item, set other options.
Information	
Version	Shows the transceiver's firmware version number.
Clone	
Clone Mode	Reads or writes the CS-7100 data to or from the PC, and/or receives data from a Master transceiver.
Clone Master Mode	Writes your IC-7100 (Master) data to another IC-7100 (Sub).
Touch Screen Calibration	Adjusts the touch screen.
Reset	
Partial Reset	Returns all settings to their default values, without clearing the memory contents, call sign memories or repeater lists.
All Reset	Clears all programming and memories, and return all settings to their default values.

17 SET MODE

Voice Memo Set mode

<<REC Start>>

Voice Memo > QSO Recorder > <<REC Start>>

Insert an SD card into the transceiver before selecting this item.

Touch [<<REC Start>>] to start voice recording.

- “Recording started.” appears.
- [<<REC Stop>>] is displayed while recording.

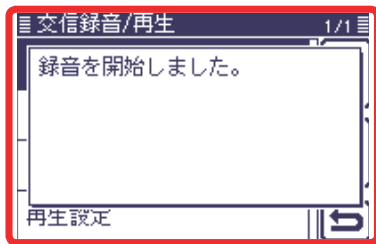

Once recording has started, the recording will continue, even the transceiver is rebooted.
To stop the recording, touch [<<REC Stop>>].

Play Files

Voice Memo > QSO Recorder > Play Files (PLAY FILES)

Insert an SD card into the transceiver before selecting this item.

Do the following steps to play back the recorded audio on the SD card.

Touch [Play Files], and folders on the SD card are displayed.

- These folders contain the stored files.

Playing back

- ① Touch [▲] or [▼], or rotate [DIAL] to select the folder that includes the desired file to play back, and then touch the folder.
- ② Touch [▲] or [▼], or rotate [DIAL] to select the file to play back, and then touch the file.
 - The VOICE PLAYER screen is displayed and the selected file is played back.
 - See “Operation while playing back” for forwarding or rewinding. (p. ??-??)
- ③ Push [MENU] or touch [↵] on the display to stop the playback.
 - Returns to the file list screen.

NOTE:

- The folder name is automatically created, as shown in the example below:
(Example) Recording date: 2013/3/1
Folder name: 20130301
- The file name is automatically created, as shown in the example below:
(Example) Recording date: 2013/3/1 15:30:00
File name: 20130301_153000
- The voice audio is recorded onto an SD card, and saved in the “wav” format.
The recorded voice audio can also be played back on a PC.
The extension, “wav,” is not displayed on the transceiver’s screen.

REC Mode

(Default: TX&RX)

Voice Memo > QSO Recorder > Recorder Set > REC Mode (REC Mode)

Records both the transmitted and received audio as the default setting.

- TX&RX: Records both the transmitted and received audio.
- RX Only: Records only the received audio.

When transmitting while recording

When “OFF” is selected in File Split, the recording is paused. After you stop transmitting, the recording resumes.

When “ON” is selected in File Split, a new file is automatically created, and the transmitted audio is recorded into the new one.

RX REC Condition

(Default: Squelch Auto)

Voice Memo > QSO Recorder > Recorder Set > RX REC Condition (RX REC Condition)

Select whether or not the squelch status affects the RX voice audio recording.

- Always: The transceiver always records the RX audio regardless of the squelch status.
- Squelch Auto: The transceiver records the RX audio only when a signal is received (the squelch is opened).
When the squelch closes while recording, the recording will continue for 2 seconds, and then pause.

When “ON” is selected in File Split, and if the squelch either opens or closes while recording, a new file is automatically created.

17 SET MODE

Voice Memo Set mode (Continued)

File Split (Default: ON)

Voice Memo > QSO Recorder > Recorder Set > File Split (File Split)

Turn the File Split function ON or OFF.

- OFF: When the recording starts, a new file is automatically created in the folder of the SD card. The audio is continuously recorded into the file, even if transmission and reception, or the squelch status (open and close) is switched. If the file size exceeds 2 GB, a new file is automatically created in the same folder, and the audio is recorded there.
- ON: When the recording starts, a new file is automatically created in the folder of the SD card. During recording, and if transmission and reception, or squelch status (open and close) is switched, a new file is automatically created in the same folder, and the audio is saved into the new one.

PTT Auto REC (Default: OFF)

Voice Memo > QSO Recorder > Recorder Set > PTT Auto REC (PTT Auto REC)

Turn the PTT Automatic Recording function ON or OFF.

Recording starts when a signal is transmitted from an external speaker microphone, the VOX functions or a CI-V command is sent.

- OFF: The recording does not start even if a signal is transmitted.
- ON: The recording automatically starts when a signal is transmitted.

The recording will stop when:

 - No signal is transmitted for 10 seconds after the last transmission.
 - No signal is received for 10 seconds after the last transmission.
 - 10 minutes after the last transmission while the squelch is open (SSB/CW/RTTY/AM modes.)
 - A signal is received within 10 seconds after the last transmission, the received signal is also recorded. A signal is received within 10 seconds after the last reception, the received signal is also recorded.
 - The frequency or operating mode is changed while transmitting.
 - The operating method (V/M, CALL, DR, M-CH, Band Stacking Register, and so on) has been changed.

Skip Time (Default: 10sec)

Voice Memo > QSO Recorder > Player Set > Skip Time (Skip Time)

Set the SkipTimer to 3, 5, 10 or 30 seconds to rewind or skip forward for this set period when you push the fast-rewind or fast-forward key.

- See "Operation while playing back" for forwarding or rewinding operation. (p. ??-??)

DV Auto Reply

Voice Memo > DV Auto Reply (DV AUTO REPLY)

Up to 10 seconds of audio can be recorded for the automatic reply function.

See page ??-?? for details of recording audio.

⚡ Be sure to insert an SD card into the transceiver before selecting this item.



17 SET MODE

DV Set mode**Standby Beep** (Default: ON)

DV Set > Standby Beep (Standby Beep)

Turn the standby beep function ON or OFF.

This function sounds a beep after a received signal disappears.

- OFF: Turns the function OFF.
- ON: Turns the function ON to sound a beep.
- ON (to me: High Tone):
Turns the function ON to sound a beep. If the signal is addressed to your call sign, a high pitch beep sounds.

NOTE:

- Even if “Beep (Confirmation)” of the Function screen is OFF, the standby beep sounds.
- The standby beep output level can be set in “Beep Level” of the Function screen.

Auto Reply (Default: OFF)

DV Set > Auto Reply (Auto Reply)

Set the automatic reply function to ON, OFF or Voice.

This function automatically replies to a call addressed to your own call sign, even if you are away from the transceiver.

When “ON” or “Voice” is selected, the automatic reply function is automatically turned OFF when you push [PTT].

- OFF: The automatic reply function is OFF.
- ON: Replies with your own call sign. (No audio reply is sent)
- Voice: Replies with your call sign and any Auto Reply message recorded on the microSD (up to 10 seconds).
If no SD card is inserted or no message is recorded, only your call sign is transmitted. The transmitted audio will be heard from the speaker.

DV Data TX (Default: Auto)

DV Set > DV Data TX (DV Data TX)

Select whether to manually or automatically transmit slow-speed data.

- PTT: Push [PTT] to manually transmit the input data.
- Auto: When data is input from a PC through either the [USB2] port or [DATA1] jack*, the transceiver automatically transmits it.
*“USB2 Function” or “USB2 Function” item must be set to “DV Data.” (p. ??)

Digital Monitor (Default: Auto)

DV Set > Digital Monitor (Digital Monitor)

Select the receive mode when [XFC] is held down in the DV mode.

- Auto: Receives in the DV mode or the FM mode, depending on the received signal.
- Digital: Monitors in the DV mode.
- Analog: Monitors in the FM mode.

Digital Repeater Set (Default: ON)

DV Set > Digital Repeater Set (Digital Repeater Set)

Turn the digital repeater setting function ON or OFF.

In any DV mode except for the DR mode, and when accessing a repeater that has a call sign that is different than the transceiver’s setting, this function reads the repeater’s transmit signal and automatically sets the repeater call sign.

- OFF: Turns the function OFF.
- ON: Automatically sets the repeater call sign.

RX Call Sign Write (Default: OFF)

DV Set > RX Call Sign Write (RX Call Sign Write)

Set the RX call sign automatic write function to Auto or OFF.

When receiving a call addressed to your own call sign in any DV mode except for the DR mode, this function automatically sets the caller station call sign into “UR.”

- OFF: Turns the function OFF.
- Auto: Automatically sets the call sign of the caller station into “UR.”

RX Repeater Write (Default: OFF)

DV Set > RX Repeater Write (RX Repeater Write)

Set the repeater call sign automatic write function to Auto or OFF.

When receiving a call addressed to your own call sign through a repeater in any DV mode except for the DR mode, this function automatically sets the call sign of the repeater into “R1” or “R2.”

- OFF: Turns the function OFF.
- Auto: Automatically sets the call sign of the repeater into “R1” and/or “R2.”

17 SET MODE

DV Set mode (Continued)

DV Auto Detect (Default: OFF)

DV Set > DV Auto Detect (DV Auto Detect)

Turn the DV mode automatic detect function ON or OFF.

If you receive a non-digital signal during DV mode operation, this function automatically switches to the FM mode.

- OFF: Turns the function OFF. The operating mode is fixed to the DV mode.
- ON: Automatically selects the FM mode for temporary operation.

RX Record (RPT) (Default: ALL)

DV Set > RX Record (RPT) (RX Record (RPT))

The transceiver can record the data of up to 50 individual calls.

When the received signal includes a status message (“UR?” or “RPT?”) that is sent back from the access repeater, you can record up to 50 messages or only the latest one, in the Received Call Record.

- ALL: Records up to 50 calls.
- Latest Only: Records only the latest call.

BK (Default: OFF)

DV Set > BK (BK)

The BK (Break-in) function allows you to break into a conversation, where the two other stations are communicating with call sign squelch enabled.

- OFF: Turns the function OFF.
- ON: Turns the function ON.
“BK” appears on the display.

NOTE: The BK function is automatically turned OFF when transceiver is turned OFF.

EMR (Default: OFF)

DV Set > EMR (EMR)

The EMR (Enhanced Monitor Request) communication mode can be used in the digital mode. In the EMR mode, no call sign setting is necessary.

When an EMR mode signal is received, the audio (voice) will be heard at the specified level even if the volume setting level is set to minimum level, or digital call sign/digital code squelch is in use.

- OFF: Turns the function OFF.
- ON: Turns the function ON.
“EMR” appears on the display.

NOTE: The EMR function is automatically turned OFF when transceiver is turned OFF.

EMR AF Level (Default: 50%)

DV Set > EMR AF Level (EMR AF Level)

Set the audio output level to between 0% (no audio), 1% (minimum) and 100% (maximum) for when an EMR communication mode signal is received.

When an EMR signal is received, the audio will be heard at the set level, or the [AF] control level, whichever is higher.

To disable the setting, set it to “0%.”

NOTE: After an EMR signal disappears, the audio level will remain at the EMR level. In this case, rotate [AF] to adjust the audio level.

SPEECH Set mode

RX Call Sign SPEECH (Default: ON (Kerchunk))

SPEECH > RX Call Sign SPEECH (RX Call Sign SPEECH)

Turn the RX call sign speech function ON or OFF for calls received in the DV mode.

- OFF: No announcement is made even when a call is received.
- ON (Kerchunk): The caller station's call sign is announced only when it makes a short transmission.
- ON (All): The caller station's call sign is always announced.

NOTE:

- When the digital squelch function is used, the calling station's call sign is not announced if the received signal is not addressed to your call sign, or does not include an unmatched digital code.
- When the repeater returns "UR?" or "RPT?," the calling station's call sign is not announced.
- When a call is received during scanning, the scan resumes even while the transceiver announcing.
- A "/" or a note after a call sign are not announced.
- When a call is received during an announcement, the received audio is heard after cancelling the announcement.

RX>CS SPEECH (Default: ON)

SPEECH > RX>CS SPEECH (RX>CS SPEECH)

Turn the RX>CS Speech function ON or OFF.

The RX>CS Speech function announces the station call sign that is selected from a Received Call Record by holding down **AUTO TUNE** (p. ??-??)

- OFF: The station call sign is not announced.
- ON: The station call sign is announced.

S-Level SPEECH (Default: ON)

SPEECH > MODE SPEECH (MODE SPEECH)

Turn the Signal strength level Speech function ON or OFF.

- OFF: Only the operating frequency is announced.
- ON: The operating frequency and the signal strength level are announced.

MODE SPEECH (Default: OFF)

SPEECH > MODE SPEECH (MODE SPEECH)

Turn the Operating Mode Speech function ON or OFF. When this function is ON, the selected operating mode is announced when the mode switch is pushed.

- OFF: The selected operating mode is not announced.
- ON: The selected operating mode is announced.

SPEECH Language (Default: English)

SPEECH > SPEECH Language (SPEECH Language)

Set the desired announcement language to English or Japanese.

Alphabet (Default: Normal)

SPEECH > Alphabet (Alphabet)

Select either "Normal" or "Phonetic Code" to announce the alphabet character.

- Normal: Normal code is used. (for example: A as eh, B as bee)
- Phonetic Code: Phonetic code is used. (for example: A as Alfa, B as Bravo)

SPEECH Speed (Default: Fast)

SPEECH > SPEECH Speed (SPEECH Speed)

Set the speech speed to Low (slow) or High (fast).

SPEECH Level (Default: 50%)

SPEECH > SPEECH Level (SPEECH Level)

Enter a volume level number between 0% (no voice), 1% (minimum) and 100% (maximum) for the voice synthesizer.

The voice synthesizer audio output level from the speaker is linked with [AF] setting from the minimum audio volume up to the set level.

17 SET MODE

QSO/RX Log Set mode

QSO Log (Default: OFF)

QSO/RX Log > QSO Log (QSO Log)

Select whether or not to make a communication log on the SD card.

The communication log is saved in the “csv” format.

Be sure to insert the SD card into the transceiver before making a communication log.

- OFF: The QSO Log function is OFF.
- ON: The QSO Log is made on the SD card.
The transceiver starts making a log with your send contents.

NOTE:

- The folder name is automatically created as [IC-7100\QsoLog].
- The file name is automatically created, as shown in the example below:
Log start date and time: 2013/3/1 15:30:00
File name: 20130301_153000.csv
- The log contents cannot be displayed on the transceiver.
- You can see the log contents on an SD card in a PC. (p. ??-??)

RX History Log (Default: OFF)

QSO/RX Log > RX History Log (RX History Log)

Select whether or not to make a DV mode’s receive history log on the SD card.

The receive history log can be made on the card, and saved in the “csv” format. Be sure to insert the card into the transceiver before making a communication log.

- OFF: The RX History Log function is OFF.
- ON : The transceiver makes a DV mode’s receive history log on the SD card.
The transceiver starts making a receive history log when you finish to talk.

NOTE:

- The folder name is automatically created as [IC-7100\RxLog].
- The file name is automatically created, as shown in the example below:
Log start date and time: 2013/3/1 15:30:00
File name: 20130301_153000.csv
- The log contents cannot be displayed on the transceiver.
- You can see the log contents on an SD card in a PC. (p. ??-??)

Separator/Decimal (Default: Sep [,] Dec [.]*)

QSO/RX Log > CSV Format > Separator/Decimal (Separator/Decimal)

Select the separator and the decimal character for the CSV format.

- Sep [,] Dec [.]: Separator is “,” and Decimal is “.” for the CSV format.
- Sep [;] Dec [.] : Separator is “;” and Decimal is “.” for the CSV format.
- Sep [;] Dec [;]: Separator is “;” and Decimal is “;” for the CSV format.

*The default value may differ, depending on the transceiver version.

Date (Default: mm/dd/yyyy*)

QSO/RX Log > CSV Format > Date (Date)

Select the date format between “yyyy/mm/dd,” “mm/dd/yyyy” and “dd/mm/yyyy.” (y: year, m: month, d: day)

*The default value may differ, depending on the transceiver version.

17 SET MODE

QSO/RX Log Set mode (Continued)

The QSO log contents are shown below:

Content	Example		Description
TX/RX	TX	RX	Transmission and reception
Date	12/23/2012 13:51:48	12/23/2012 13:51:48	Date and time the call was started.
Frequency	438.010000	438.010000	Operating frequencies (When Duplex is set, the frequencies of the called are displayed.)
Mode	DV	DV	Operating mode (All mode)
My Latitude	34.764667	34.764667	Your latitude (unit: degree) +: North latitude, -: South latitude
My Longitude	135.375333	135.375333	Your longitude (unit: degree) +: East longitude, -: West longitude
My Altitude	50.5	50.5	Your altitude (unit: ft) Records to one decimal place.
RF Power	100%	(Blank)	TX output power level
S Meter	(Blank)	S0	The relative signal strength of the receive signal (in sixteen levels)
RPT Call Sign	JP3YHJ A	JP3YHJ A	Repeater call sign (DV mode only)
TX Call Sign	CQCQCQ	(Blank)	TX Call sign (DV mode only)
RX Call Sign	(Blank)	JA3YUA A	RX Call sign (DV mode only)
RX Latitude	(Blank)	34.764667	Caller's latitude, if sent. (unit: degree) +: North latitude, -: South latitude Records only when you receive in the DV mode.
RX Longitude	(Blank)	135.375333	Caller's longitude, if sent. (unit: degree) +: East longitude, -: West longitude Records only when you receive in the DV mode.
RX Altitude	(Blank)	30.5	Caller's altitude, if sent. (unit: ft) Records only when you receive in the DV mode.

The RX History log contents are shown below:

Content	Example	Description
Frequency	438.010000	RX Frequency
Mode	DV	Operating mode (DV is fixed)
Caller	JA3YUA A	Call sign of the caller station
/	7100	Note after the call sign
Called	CQCQCQ	Call sign of the called station
Rx RPT1	JP3YHH G	Access repeater call sign of the caller station or the gateway repeater call sign of your local area repeater.
Rx RPT2	JP3YHJ A	Access repeater call sign of the called station
Message	Hello CQ D-STAR!	Message included in the received call (up to 20 characters)
Status	(Blank)	Normal: blank, Uplink: UPLINK, Access repeater reply: "UR?" or "RPT?"
Received date	12/23/2012 13:51:48	Date and time the call was received Depending on the setting, the format may differ.
BK	*	BK call: "**", Normal call: Blank
EMR	*	EMR call: "**", Normal call: Blank
Latitude	34.764667	Caller's latitude, if sent. (unit: degree) +: North latitude, -: South latitude
Longitude	135.375333	Caller's longitude, if sent. (unit: degree) +: East longitude, -: West longitude
Altitude	30.5	Caller's altitude, if sent. (unit: ft)
SSID	-A	Records one of 0, -1 to -15 and -A to -Z.
GPS-A Symbol	Car	Icon: Converts to text None: Code
Course	123	Caller's course (unit: degree)
GPS Time Stamp	12:00:00	Time data that the caller station acquires the position data
GPS Message	Osaka City/IC-7100	Caller is "DV-G": Records the GPS message Caller is "DV-A": Records the GPS-A comment

17 SET MODE

Function Set mode

Monitor (Default: OFF)

Function > Monitor (Monitor)

Turn the monitor function ON or OFF.

This function allows you to monitor your transmit signal in any mode other than CW.

- OFF: Turns the function OFF.
- ON: Monitors your transmit signal.

Monitor Level (Default: 50%)

Function > Monitor Level (Monitor Level)

Adjust a transmit signal monitor level number between 0% (no audio), 1% (minimum) and 100% (maximum) for the voice synthesizer.

Beep Level (Default: 50%)

Function > Beep Level (Beep Level)

Adjust the confirmation and band edge beep tones output level to between 0% (no beep), 1% (minimum) and 100% (maximum).

Beep Level Limit (Default: ON)

Function > Beep Level Limit (Beep Level Limit)

Turn the confirmation and band edge beep tones output level limiting ON or OFF.

When you set this item to ON, the beep tones are adjusted by the [AF] control until rotating the control reaches to the specified level. Further rotation will not increase the volume of the beep tones.

- OFF: Beep level adjustment is not limited.
- ON: Beep level adjustment is limited with the [AF] control.

Beep (Confirmation) (Default: ON)

Function > Beep (Confirmation) (Beep (Confirmation))

Turn the confirmation beep ON or OFF.

Set the beep output level in the "Beep Level" item as described above.

- OFF: The confirmation beep is OFF. (Silent operation)
- ON: The confirmation beep sounds each time a switch is pushed.

Band Edge Beep (Default: ON (Default))

Function > Band Edge Beep (Band Edge Beep)

When you tune into or out of an amateur band's frequency range, you can hear a beep tone.

If you select "ON (User)" or "ON (User) & TX Limit," you can program a total of 30 band edge frequencies in the "User band Edge" item.

You can set the beep output level in the "Beep Level" item as described to the left.

- OFF: Band edge beep is OFF
- ON (Default): When you tune into or out of the default amateur band's frequency range, a beep sounds.
- ON (User): When you tune into or out of a user programmed amateur band's frequency range, a beep sounds.
- ON (User) & TX Limit: When you tune into or out of a user programmed amateur band's frequency range, a beep sounds. In addition, transmission is inhibited outside the programmed range.

User Band Edge (Default: ??)

Function > User Band Edge (User Band Edge)

This "User Band Edge" item appears only when "ON (User)" or "User (ON) & TX Limit" is selected in the "Band Edge Beep" item.

When you select "ON (User)" or "ON (User) & TX Limit" in the "Band Edge Beep" item, you can program a total of 30 band edge frequencies in this item.

See page ??-?? for programming details.

RF/SQL Control (Default: RF+SQL)

Function > RF/SQL Control (RF/SQL Control)

Set the [RF/SQL] control operation.

- AUTO: [RF/SQL] functions as only an RF gain control in SSB, CW and RTTY; a squelch control in AM, FM, WFM and DV.
- SQL: [RF/SQL] functions as a squelch control.
- RF+SQL: [RF/SQL] functions not only as an RF gain control, but also as a squelch control in all modes.

17 SET MODE

Function Set mode (Continued)

TX Delay (Default: All bands; OFF)

Function > TX Delay (TX Delay)

Sets the transmission's timing for each operating band.

If the external equipment initiates its transmission later than the transceiver, reflected wave may occur. This may damage the external equipment.

Delaying the timing prevents the reflected waving.

- OFF: The transmission timing is normal.
- 10 to 30ms: The transmission delays within the set period of time (10, 15, 20, 25 or 30 milliseconds).

Time-Out Timer (Default: OFF)

Function > Time-Out Timer (Time-Out Timer)

To prevent accidental prolonged transmission, the transceiver has a time-out timer.

The function inhibits continuous transmissions longer than the set time period.

- OFF: Turns the function OFF.
- 3 to 30 min: The transmission is cut OFF after the set time period ends (3, 5, 10, 20 or 30 minutes).

PTT Lock (Default: OFF)

Function > PTT Lock (PTT Lock)

Turn the PTT lock function ON and OFF.

To prevent accidental transmissions, this function disables [PTT].

Quick SPLIT (Default: ON)

Function > SPLIT/DUP > Quick SPLIT (Quick SPLIT)

Turn the Quick Split function ON or OFF.

When this item is set to ON, hold down [SPLIT] for 1 second to shift the transmit frequency from the receive frequency, according to the "SPLIT Offset" option as described below. See page ??-?? for details.

- OFF: Turns the function OFF.
- ON: Holding down [SPLIT] for 1 second quickly selects split frequency operation.

SPLIT Offset (Default: 0.000 MHz)

Function > SPLIT/DUP > SPLIT Offset (SPLIT Offset)

Set the offset* for the quick split function.

*The difference between transmit and receive frequencies.

The frequency offset can be set to between -9.999 MHz and +9.999 MHz in 1 kHz steps.

SPLIT LOCK (Default: OFF)

Function > SPLIT/DUP > SPLIT LOCK (SPLIT LOCK)

Turn the Split Lock function ON or OFF.

When this item is set to ON, you can use [MAIN DIAL] to adjust the transmit frequency while holding down [XFC], even while the Dial Lock function is enabled.

To prevent accidentally changing the receive frequency by rotating the main dial, use both the SPLIT LOCK and Dial Lock functions.

See pages ??-?? and ??-?? for split frequency operation details.

DUP Offset (Default: 0.1000 MHz)

Function > SPLIT/DUP > DUP Offset (DUP Offset)

Set the offset* for duplex operation. You can set the repeater offset for each band.

*The difference between transmit and receive frequencies.

➔ Before selecting this item, select the desired frequency band. Then, set the offset.

- The frequency offset can be set to between 0.0000 MHz and 9.9999 MHz.

▨ The default value may differ, depending on the selected frequency band and transceiver version.

NOTE:

- The shift direction can be set with [DUP] on M1 (M1 Menu) screen.
- You can use this setting only when the Split function is OFF.
- If the DR mode is selected before selecting this item, editing is restricted.

One Touch Repeater (Default: DUP-)

Function > SPLIT/DUP > One Touch Repeater (One Touch Repeater)

Set the one touch repeater shift direction.

- DUP-: The transmit frequency shifts down from the receive frequency by the offset amount.
- DUP+: The transmit frequency shifts up from the receive frequency by the offset amount.

17 SET MODE

Function Set mode (Continued)

Auto Repeater

Function > SPLIT/DUP > Auto Repeater (Auto Repeater)

This item appears only in the Korean and U.S.A. version transceivers.

The auto repeater function automatically turns the duplex operation and tone encoder* ON or OFF.

The offset and repeater tone* are not changed by the auto repeater function. Reset these setting values, if necessary.

For Korean versions

- OFF: Turns the function OFF.
- ON: Turns ON the duplex operation and tone encoder*. (Default)

For U.S.A. version

- OFF: Turns the function OFF.
- ON (DUP): Turns ON the duplex operation only. (Default)
- ON (DUP, TONE): Turns ON the duplex operation and tone encoder*.

*The tone encoder will not be turned ON in the DV mode.

Auto Start (Default: OFF)

Function > Tuner > Auto Start (Tuner (Auto Start))

Turn the Automatic Antenna Tuner function ON or OFF for an external antenna tuner (like the optional AT-180). This function is for only the HF bands.

- OFF: Tuning starts only when **TUNER/CALL** is pushed.
- ON: The external antenna tuner automatically starts tuning when the SWR is high, even if the tuner is turned OFF.

PTT Start (Default: OFF)

Function > Tuner > PTT Start (Tuner (PTT Start))

When [PTT] is pushed after the operating frequency is changed more than 1% from the last tuned frequency, the external antenna tuner (optional AH-4 or AT-180) automatically starts tuning.

- OFF: Tuning starts only when **TUNER/CALL** is pushed.
- ON : (AH-4) Automatically starts tuning when [PTT] is pushed on a new frequency, whether the external antenna tuner is ON or OFF
(AT-180) Automatically starts tuning when [PTT] is pushed on a new frequency, only if the internal antenna tuner is ON

[TUNER] Switch (Default: Auto)

Function > Tuner > [TUNER] Switch ([TUNER] Switch)

Select whether or not to store the AT-180's status on each band.

When you change the operating frequency, this function will automatically select the correct AT-180's status, or you must do it manually.

- Manual: You must manually change the AT-180's status by pushing [TUNER].
- Auto: The AT-180's status memorized by the band memory is automatically selected. You can also manually change it by pushing [TUNER].

[SPEECH/LOCK] Switch (Default: SPEECH/LOCK)

Function > [SPEECH/LOCK] Switch ([SPEECH/LOCK] Switch)

Select the **[SPEECH/LOCK]** switch action.

- SPEECH/LOCK: Pushing **[SPEECH/LOCK]** turns ON the voice synthesizer function.
Holding down **[SPEECH/LOCK]** turns the dial lock function ON or OFF.
- LOCK/SPEECH: Pushing **[SPEECH/LOCK]** turns the dial lock function ON or OFF.
Holding down **[SPEECH/LOCK]** turns ON the voice synthesizer function.

Lock Function (Default: MAIN DIAL)

Function > Lock Function (Lock Function)

The dial lock function prevents frequency changes by accidental movement of the tuning dial. The lock function electronically locks the dial.

- MAIN DIAL: When Lock Function is activated, the Dial is disabled.
- PANEL: When Lock Function is activated, the panel is disabled.
Functions except for [AF], [RF/SQL], [PWR], [SPEECH/LOCK] are inhibited.

Memopad Numbers (Default: 5)

Function > Memopad Numbers (Memopad Numbers)

Set the number of usable memopad channels to either 5 or 10.

See page ??-?? for details.

17 SET MODE

Function Set mode (Continued)

MAIN DIAL Auto TS (Default: HIGH)

Function > MAIN DIAL Auto TS (MAIN DIAL Auto TS)

Set the Auto Tuning Step function for the Dial.

When rapidly rotating the Dial, the tuning step automatically changes as selected.

There are two types of auto tuning steps: LOW (Faster) and HIGH (Fastest).

- OFF: Auto tuning step is turned OFF.
- LOW: Approximately 2 times faster.
- HIGH: Approximately 5 times faster when the tuning step is set to 1 kHz or smaller steps; approximately 2 times faster when the tuning step is set to 5 kHz or larger steps.

MIC Up/Down Speed (Default: Fast)

Function > MIC Up/Down Speed (MIC Up/Down Speed)

Set the rate at which frequencies are tuned while holding down the microphone [▲]/[▼] switches.

- Slow: Low speed (25 tuning steps/second)
- Fast: High speed (50 tuning steps/second)

[NOTCH] Switch (SSB) (Default: Auto/Manual)

Function > [NOTCH] Switch (SSB) ([NOTCH] Switch (SSB))

Select the Auto, Manual or Auto/Manual notch filter to be used for SSB mode operation.

- Auto: Only the Auto notch filter can be used.
- Manual: Only the Manual notch filter can be used.
- Auto/Manual: Both the Auto and Manual notch filters can be used.

[NOTCH] Switch (AM) (Default: Auto/Manual)

Function > [NOTCH] Switch (AM) ([NOTCH] Switch (AM))

Select the Auto, Manual or Auto/Manual notch filter to be used for AM mode operation.

- Auto: Only the Auto notch filter can be used.
- Manual: Only the Manual notch filter can be used.
- Auto/Manual: Both the Auto and Manual notch filters can be used.

SSB/CW Sync Tuning (Default: OFF)

Function > SSB/CW Sync Tuning (SSB/CW Sync Tuning)

Turn the displayed frequency shift function ON or OFF. When this function is turned ON, the audio pitch or tones of the received signal will remain the same, even when the operating mode is changed between SSB and CW.

The amount of frequency shift may differ, depending on the CW pitch setting.

- OFF: The displayed frequency does not shift.
- ON: The displayed frequency shifts when the operating mode is changed between SSB and CW.

CW Normal Side (Default: LSB)

Function > CW Normal Side (CW Normal Side)

Select the sideband used to receive CW in the CW normal mode between LSB and USB.

VOICE 1st Menu (Default: VOICE-TX)

Function > VOICE 1st Menu (VOICE 1st Menu)

Select VOICE-Root or VOICE-TX as the menu that appears first after touching [VOICE] in the "M2" screen (Menu 2), when the SSV, AM, FM or DV mode is selected.

- VOICE-Root: The voice menu appears first.
- VOICE-TX: The voice SEND menu appears first.

KEYER 1st Menu (Default: KEYER-SEND)

Function > KEYER 1st Menu (KEYER 1st Menu)

Select KEYER-Root or KEYER-SEND as the menu that appears first after touching [KEYER] in the "M2" screen (Menu 2), when in the CW mode.

- KEYER-Root: The Memory keyer menu appears first.
- KEYER-SEND: The Keyer SEND menu appears first.

Speaker Out (Default: ON)

Function > Speaker Out (Speaker Out)

Select the speaker output function.

- OFF: The speaker does not output the received audio.
The [ACC] socket, [USB] port, and [MIC] connector output the received audio.
- ON: The speaker outputs the received audio.

17 SET MODE

Function Set mode (Continued)

MIC AF Out (Default: OFF)

Function > MIC AF Out (MIC AF Out)

Select the [MIC] connector output function.

- OFF: The [MIC] connector does not output the received audio.
When using the optional HM-151 REMOTE CONTROL MIC, select "OFF"
- ON: The [MIC] connector outputs the received audio.
When using a speaker microphone or headset, select "OFF"

[F-1] (Default: SPLIT)

Function > RC MIC > [F-1] ([F-1])

The function listed below can be assigned to [F-1] on the optional HM-151 REMOTE CONTROL MIC.

- --(No function), P.AMP/ATT, AGC, NB, NR, NOTCH, RIT, AUTOTUNE/RX>CS, TS, MPAD, M-CLR, BANK, SPLIT, A/B, DUP, TONE/DSQL, COMP, TBW, METER, DR, FROM/TO (DR), SCAN, Voice TX (T1)

[F-2] (Default: A/B)

Function > RC MIC > [F-2] ([F-2])

The function listed below can be assigned to [F-2] on the optional HM-151 REMOTE CONTROL MIC.

- --(No function), P.AMP/ATT, AGC, NB, NR, NOTCH, RIT, AUTOTUNE/RX>CS, TS, MPAD, M-CLR, BANK, SPLIT, A/B, DUP, TONE/DSQL, COMP, TBW, METER, DR, FROM/TO (DR), SCAN, Voice TX (T1)

Mode Select (Default: All mode)

Function > RC MIC > Mode Select (Mode Select)

Disables the mode selection with the optional HM-151 REMOTE CONTROL MIC, to simplify operation.

- SSB, CW, RTTY, AM, FM, WFM, DV

Power OFF (With No Controller) (Default: ON)

Function > Power OFF (With No Controller) (Power OFF (With No Controller))

Select to automatically turn OFF the transceiver when the controller is disconnected from the transceiver.

- OFF: The transceiver power is ON.
- ON: The transceiver is automatically turned OFF.

REF Adjust

Function > REF Adjust (REF Adjust)

During frequency calibration, set the internal reference frequency to between 0% and 100% range.

NOTE:

The default setting is different for each transceiver.

17 SET MODE

Tone Control Set mode

RX HPF/LPF (Default: [----] - ----)

Tone Control > RX > (Mode) > RX HPF/LPF (RX HPF/LPF)
(Mode: SSB/CW/RTTY/AM/FM/DV)

First select the operating mode, then set the receive audio high-pass filter to between 100 Hz and 2000 Hz in 100 Hz steps.

RX HPF/LPF (Default: ---- - [----])

Tone Control > RX > (Mode) > RX HPF/LPF (RX HPF/LPF)
(Mode: SSB/CW/RTTY/AM/FM/DV)

First select the operating mode, then set the receive audio low-pass filter to between 500 Hz and 2400 Hz in 100 Hz steps.

RX Bass (Default: 0)

Tone Control > RX > (Mode) > RX Bass (RX Bass)
(Mode: SSB/AM/FM/WFM/DV)

First select the operating mode, then set the receive audio bass level to between -5 and +5.

RX Treble (Default: 0)

Tone Control > RX > (Mode) > RX Treble (RX Treble)
(Mode: SSB/AM/FM/WFM/DV)

First select the operating mode, then set the receive audio treble level to between -5 and +5.

TX Bass (Default: 0)

Tone Control > TX > (Mode) > TX Bass (TX Bass)
(Mode: SSB/AM/FM/DV)

First select the operating mode, then set the transmit audio bass level to between -5 and +5.

TX Treble (Default: 0)

Tone Control > TX > (Mode) > TX Treble (TX Treble)
(Mode: SSB/AM/FM/DV)

First select the operating mode, then set the transmit audio treble level to between -5 and +5.

TBW (WIDE) (Default: 100 - 2900)

Tone Control > TX > SSB > TBW (WIDE) (TBW (WIDE))
(Mode: SSB)

Set the lower and higher cut-off frequencies of the transmission passband width for your wide setting.

- Lower: 100, 200, 300 or 500 Hz
- Higher: 2500, 2700, 2800 or 2900 Hz

TBW (MID) (Default: 300 - 2700)

Tone Control > TX > SSB > TBW (MID) (TBW (MID))
(Mode: SSB)

Set the lower and higher cut-off frequencies of the transmission passband width for your middle setting.

- Lower: 100, 200, 300 or 500 Hz
- Higher: 2500, 2700, 2800 or 2900 Hz

TBW (NAR) (Default: 500 - 2500)

Tone Control > TX > SSB > TBW (NAR) (TBW (NAR))
(Mode: SSB)

Set the lower and higher cut-off frequencies of the transmission passband width for your narrow setting.

- Lower: 100, 200, 300 or 500 Hz
- Higher: 2500, 2700, 2800 or 2900 Hz

Connectors Set mode

USB Audio SQL (Default: OFF (OPEN))

Connectors > USB Audio SQL (USB Audio SQL)

Select whether or not to output the audio from the [USB] connector on the rear panel, according to the squelch state.

The same audio signals are output from the [USB] connector and the [ACC] socket.

- OFF (OPEN): The received audio is output regardless of the squelch state.
- ON: The received audio is output depending on the squelch state (open or closed).

- The beep tones and the voice synthesizer announcements are not sent.
- The received audio output level cannot be adjusted with the [AF] control.

ACC/USB Output Select (Default: AF)

Connectors > ACC/USB Output Select (ACC/USB Output Select)

Select whether to use the [USB] connector and the [ACC] socket for a usual received audio, or to use the IF output for [DRM (Digital Radio Mondiale)].

- AF: The received audio is output from the [ACC] socket and the [USB] connector.
- IF: The received signal is converted to an IF signal, and then output.

ACC/USB AF Level (Default: 50%)

Connectors > ACC/USB AF Level (ACC/USB AF Level)

Enter the audio output level at the [ACC] socket and the [USB] connector to between 0% and 100%.

ACC/USB IF Level (Default: 50%)

Connectors > ACC/USB IF Level (ACC/USB IF Level)

Set the IF output level at the [ACC] socket and the [USB] connector to between 0% and 100%.

ACC MOD Level (Default: 50%)

Connectors > ACC MOD Level (ACC MOD Level)

Set the input modulation level at the [ACC] socket to between 0% and 100%.

DATA MOD Level (Default: 50%)

Connectors > DATA MOD Level (DATA MOD Level)

Set the input modulation level at the [DATA] jack to between 0% and 100%.

USB MOD Level (Default: 50%)

Connectors > USB MOD Level (USB MOD Level)

Set the input modulation level of the [USB] connector to between 0% and 100%.

DATA OFF MOD (Default: MIC, ACC)

Connectors > DATA OFF MOD (DATA OFF MOD)

Select the desired connector(s) for data modulation input in the data OFF mode.

- MIC: Use the signals from [MIC].
- ACC: Use the signals from [ACC] (pin 11).
- MIC, ACC: Use the signals from [MIC] and [ACC] (pin 11).
- USB: Use the signals from [USB].

DATA MOD (Default: ACC)

Connectors > DATA MOD (DATA MOD)

Select the desired connector(s) for data modulation input in the data mode.

- MIC: Use the signals from [MIC].
- ACC: Use the signals from [ACC] (pin 11).
- MIC, ACC: Use the signals from [MIC] and [ACC] (pin 11).
- USB: Use the signals from [USB].

VOICE (Default: OFF)

Connectors > External Keypad > VOICE (External Keypad (VOICE))

Select whether or not to enable transmitting voice memory contents using the external keypad.

- OFF: The external keypad is disabled.
- ON: Transmits the desired voice memory contents in T1 to T4 during SSB, AM, FM, DV operation.

17 SET MODE

Connectors Set mode (Continued)

KEYER (Default: OFF)

Connectors > External Keypad > KEYER (External Keypad (KEYER))

Select whether or not to enable transmitting keyer memory contents using the external keypad.

- OFF: The external keypad is disabled.
- ON: Transmits the desired keyer memory contents in M1 to M4 during CW mode operation.

RTTY (Default: OFF)

Connectors > External Keypad > RTTY (External Keypad (RTTY))

Select whether or not to enable transmitting RTTY memory contents using the external keypad.

- OFF: The external keypad is disabled.
- ON: Transmits the desired RTTY memory contents in RT1 to RT4 during RTTY mode operation.

CI-V Baud Rate (Default: Auto)

Connectors > CI-V > CI-V Baud Rate (CI-V Baud Rate)

Set the CI-V data transfer speed to 300, 1200, 4800, 9600, 19200 bps or Auto.

When "Auto" is selected, the baud rate is automatically set according to the data rate of the controller.

CI-V Address (Default: 88h)

Connectors > CI-V > CI-V Address (CI-V Address)

To distinguish equipment, each CI-V transceiver has its own Icom standard address in hexadecimal code.

The IC-7100's default address is 88h.

When 2 or more IC-7100s are controlled through a PC at the same time, set a different address for each device between 01h and DFh (hexadecimal).

CI-V Transceive (Default: ON)

Connectors > CI-V > CI-V Transceive (CI-V Transceive)

Turn the CI-V Transceive function ON or OFF.

- OFF: Turns the function OFF.
- ON: When you change a setting on the transceiver, the same change is automatically set on other connected transceivers or receivers, and vice versa.

USB2 Function (Default: OFF)

Connectors > USB2/DATA1 Function > USB2 Function (USB2 Function)

Two COM port numbers are assigned to the [USB] connector. One of them is used for cloning and CI-V operation (USB1).

Select the use of the other COM port (USB2).

- OFF: Does not use the COM port (USB2).
- RTTY: Decode used for RTTY decoded signal output.
- DV Data: Used for low-speed data input and output.
 - If DATA1 Function is set to "GPS," and GPS Out is set to "DATA1→USB2," the COM port (USB2) will be used for low-speed data input and GPS data output.

DATA1 Function (Default: GPS)

Connectors > USB2/DATA1 Function > DATA1 Function (DATA1 Function)

Select the use of the [DATA1] jack.

- OFF: Does not use the [DATA1] jack.
- RTTY: Decode used for RTTY decoded signal output.
- DV Data: Used for low-speed data input and output.
- GPS: Used for the GPS receiver connection for position data input.

NOTE:

You cannot set "DV Data" to both "USB2 Function" and "DATA1 Function."

If you select "DV Data" for one of them when "DV Data" is set to the other one, the previously set item will be to "OFF."

GPS Out (Default: OFF)

Connectors > USB2/DATA1 Function > GPS Out (GPS Out)

Select whether or not to output the data to the COM port (USB2) when data is input from a GPS receiver through the [DATA1] jack.

NOTE:

You can use this function only when "OFF" or "DV Data" is selected as the "USB2 Function" option, and "GPS" is selected as the "DATA1 Function" option.

- OFF: Turns OFF the function.
- DATA1→USB2: Outputs the GPS data to the COM port (USB2).

17 SET MODE

Connectors Set mode (Continued)

DV Data/GPS Out Baud (Default: 4800)

Connectors > USB2/DATA1 Function > DV Data/GPS Out Baud (DV Data/GPS Out Baud)

Set the DV or GPS data transfer speed to 4800 or 9600 bps.

RTTY Decode Baud (Default: 9600)

Connectors > USB2/DATA1 Function > RTTY Decode Baud (RTTY Decode Baud)

Set the RTTY decode monitor speed to 300, 1200, 4800, 9600 or 19200 bps.

VSEND Select (Default: VHF/UHF)

Connectors > VSEND Select (VSEND Select)

Select the band to use for the [ACC] socket's pin 7 (VSEND usage) and pin 3 (HSEND usage).

- OFF: VSEND is not used.
HSEND is used for all bands.
- UHF: VSEND is used for the 430 MHz band.
HSEND is used for the HF/50 MHz and 144 MHz bands.
- VHF/UHF: VSEND is used for the 144 MHz and 430 MHz bands.
HSEND is used for the HF/50 MHz bands.

9600bps Mode (Default: OFF)

Connectors > 9600bps Mode (9600bps Mode)

Select whether to allow data transmission at 9600 bps, or not on the [DATA2] socket.

- OFF: Disables data transmission at 9600 bps on the [DATA2] socket. This is used for regular audio or slower data transmission only.
- ON: Enables data transmission at 9600 bps on the [DATA2] socket.

17 SET MODE

Display Set mode

Display Contrast (Default: 25%)

Display > LCD Contrast (LCD Contrast)

Set the display contrast level to between 0% and 100%.

LCD Backlight (Default: 50%)

Display > LCD Backlight (LCD Backlight)

Set the LCD backlight brightness to between 0% and 100%.

Key Backlight (Default: 50%)

Display > Key Backlight (Key Backlight)

Set the key backlight brightness to between 0% and 100%.

Meter Peak Hold (Default: ON)

Display > Meter Peak Hold (Meter Peak Hold)

Turn the Meter Peak Hold function ON or OFF. This function displays the peak level of a received signal strength or the output power for approximately 0.5 seconds.

BW Popup (PBT) (Default: ON)

Display > BW Popup (PBT) (BW Popup (PBT))

Select whether or not to display the PBT shift value while rotating the TWIN-PBT control.

- OFF: Turns the function OFF.
- ON: Displays the PBT shift value.

BW Popup (FIL) (Default: ON)

Display > BW Popup (FIL) (BW Popup (FIL))

Select whether or not to display the IF filter width and shift value when the IF filter is switched by touching the filter icon.

- OFF: Turns the function OFF.
- ON: Displays the IF filter width and shift value.

RX Call Sign Display (Default: Auto)

Display > RX Call Sign Display (RX Call Sign Display)

Select whether or not to display the call sign of the caller station when a call is received.

- OFF: Does not display the caller station's call sign.
- Auto: The caller station's call sign automatically scrolls once, and then disappears.
- Auto (RX Hold): The caller station's call sign automatically scrolls once, and then remains on the display until the signal disappears.

NOTE:

When "Auto" or "Auto (RX Hold)" is selected, and if the call sign and name of the caller station is programmed in your memory, the programmed name is displayed after showing the call sign.

RX Message Display (Default: Auto)

Display > RX Message Display (RX Message Display)

Select whether or not to display and scroll a received message.

- OFF: Does not display the message.
To check the message, touch [CD] on the "D-1" screen (Menu D1) to display the call record.
- Auto: Automatically displays and scrolls the message.
The message is automatically displayed every 30 seconds until their signal disappears.

NOTE:

When "Auto" or "Auto (RX Hold)" is selected in RX Call Sign Display, the message is displayed after displaying the caller station's call sign.

Reply Position Display (Default: ON)

Display > Reply Position Display (Reply Position Display)

Select whether or not to display the caller's position data when the data is included in the Auto Replay signal.

- OFF: Does not display the caller's position data.
- ON: Automatically displays the caller's position data.

17 SET MODE

Display Set mode (Continued)

TX Call Sign Display (Default: Your Call Sign)

Display > TX Call Sign Display (TX Call Sign Display)

Select whether or not to display your own or the destination station's call sign while transmitting.

- OFF: Does not display the call sign.
- Your Call Sign: Displays and scrolls the destination's call sign.
When the called station's call sign and name are programmed into memory, the transceiver shows the name after the call sign in any DV mode except for the DR mode.
- My Call Sign: Displays and scrolls your own call sign.

Scroll Speed (Default: Fast)

Display > Scroll Speed (Scroll Speed)

This item sets the scrolling speed of the message, call sign, or other text, that is displayed on the transceiver's LCD.

- Slow: The speed is set to slow.
- Fast: The speed is set to fast.

VOICE TX Name Display (Default: ON)

Display > VOICE TX Name Display (VOICE TX Name Display)

Select whether or not to display the voice TX memory name on the "Voice TX" display.

- OFF: Does not display the voice TX memory name.
- ON: Displays voice TX memory name.

KEYER Memory Display (Default: ON)

Display > KEYER Memory Display (KEYER Memory Display)

Select whether or not to display the keyer memory contents on the "Keyer Send" display.

- OFF: Does not display the keyer memory contents.
- OFF: Displays keyer memory contents.

Opening Message (Default: ON)

Display > Opening Message (Opening Message)

Select the opening message that is displayed on the LCD at power ON.

- OFF: Opening message display is skipped.
- ON: Icom logo, MY call sign and the product model ("IC-7100")* are displayed at power ON.

*Depending on the version.

Power ON Check (Default: ON)

Display > Power ON Check (Power ON Check)

Select whether or not to display the RF Power, RIT, Auto Power OFF condition when the transceiver is activated.

When the RIT or Auto Power OFF is set to OFF, no display is shown.

- OFF: Does not display the RF Power, RIT, Auto Power OFF condition.
- ON: Displays the RF Power, RIT, Auto Power OFF condition.

Display Language (Default: English)

Display > Display Language (Display Language)

This item will appear only when "Japanese" is selected in System Language. See page ??-?? "Choose your language carefully" about setting cautions.

Set the screen display language type in the DR mode or Menu mode to English or Japanese.

System Language (Default: English)

Display > System Language (System Language)

Set the system language of the transceiver to English or Japanese.

- English: The system language of the transceiver is English.
 - Only alphabetical characters (A to Z, a to z, 0 to 9) and symbols (! " # \$ % & ' () * + , - . / : ; < = > ? @ [\] ^ _ ` { | } ~) can be displayed.
 - If Japanese characters (Kanji, Hiragana and Katakana) are included, the LCD shows "=" or "_" instead of that character. In this case, you can only delete "=" or "_" in the transceiver's edit mode.
 - The Display Language item will be hidden.
- Japanese: The system language of the transceiver is Japanese. Kanji, Hiragana and Katakana characters, and the 2-bytes symbols can be displayed on the LCD. To display such characters in the DR mode or Menu mode, Display Language must be set to "Japanese."

17 SET MODE

Display Set mode (Continued)

Choose your language carefully

When the system language of the transceiver is set to Japanese, the IC-7100 has the capability to display both English and Japanese characters. HOWEVER, if you select Japanese as the display language (p. ??-??), all menu items throughout the IC-7100 system will be displayed in only Japanese characters. There will be no English item names. Unless you are fluent in reading Japanese characters, use this feature with extreme caution.

If you change the IC-7100's language to Japanese, and can't understand the menu system in the new setting, you will have to change the language back to English in "Display Language" or "System Language" (this item), or by doing a partial reset of the IC-7100 CPU. A partial reset will not clear your call sign databases.

To do a partial reset of the CPU, do the following steps:

1. Push **SET**.
2. Touch **[▲]** or **[▼]** to select the bottom item, and then touch it.
3. Touch **[▲]** or **[▼]** to select the bottom item, and then touch it.
4. Touch **[▲]** or **[▼]** to select the upper item, and then touch it.
5. The dialog appears. Touch **[▲]** or **[▼]** to select the upper option, and then push touch it.
 - The transceiver displays "PARTIAL RESET," then the partial reset is completed.

17 SET MODE

Time Set Set mode

DATE

Time Set > Date/Time > DATE (DATE)

Manually set the date to between 2000/01/01 and 2099/12/31.

TIME

Time Set > Date/Time > TIME (TIME)

Manually set the time that is displayed on the right hand corner of the screen to between 0:00 and 23:59. The time is displayed in the 24 hour format.

GPS Time correct (Default: Auto)

Time Set > GPS Time Correct (GPS Time Correct)

Select whether or not the time data is automatically corrected by a received GPS sentence.

- OFF: The time data is not automatically corrected.
- Auto: The time data is automatically corrected.

UTC Offset (Default: ±9:00)

Time Set > UTC Offset (UTC Offset)

Set the time difference between UTC (Universal Time Coordinated) and the local time to between -14:00 and +14:00 in 00:05 steps.

Clock Display (Default: Local)

Time Set > Clock Display (Clock Display)

Set the clock display mode.

- Local: Displays the local time.
- UTC: Displays the UTC (Universal Time Coordinated).

Auto Power OFF (Default: OFF)

Time Set > Auto Power OFF (Auto Power OFF)

This function automatically turns OFF the power after no operation has not been performed for the preprogrammed time.

The "Auto Power OFF" pops up in 10 seconds before the transceiver automatically turns OFF, and a beep sounds. If an operation is made within the 10 seconds, the timer restarts.

- OFF: Turns the function OFF.
- 30 to 120 min: Select the desired Auto Power OFF time between 30, 60, 90 and 120 minutes. The power automatically turns OFF after no operation is made for the specified time period.

NOTE:

The auto power OFF timer activates each time the transceiver is turned ON. To deactivate the timer, select OFF.

Others Set mode

Version

Others > Information > Version (VERSION)

Shows the transceiver firmware's version number.

Clone Mode

Others > Clone > Clone Mode

Select to read or write the CS-7100 data from or to the PC, and/or to receive data from a Master transceiver. See page ??-?? for details.

Clone Master Mode

Others > Clone > Clone Master Mode

Select to write your IC-7100 (Master) data to another IC-7100 (Sub). See page ??-?? for details.

Touch Screen Calibration

Others > Touch Screen Calibration

Touch to adjust the touch screen. See page ??-?? for details.

Partial Reset

Others > Reset > Partial Reset

A Partial reset resets operating settings to their default values (VFO frequency, VFO settings, menu contents) without clearing the items below: See page ??-?? for details.

All Reset

Others > Reset > All Reset

Reset the CPU, if the internal CPU malfunctions due to static electricity, and so on. All reset clears all programming and returns all settings to their factory defaults (including the programmed data you purchased).

Therefore, after the All resetting, you cannot use the transceiver in the DR mode until reprogramming the repeater list.

See page ??-?? for details.

✓ *Recommend!*

Before the All resetting, we recommend you save the programmed data you purchased onto an SD card.

See page ??-?? for details.