



## INSTRUCTION MANUAL

---

VHF FM REPEATER  
**IC-FR5200H**  
UHF FM REPEATER  
**IC-FR6200H**

---

---

---

---

---

This device complies with Part 15 of the FCC Rules. Operation is subject to the condition that this device does not cause harmful interference.

---

## IMPORTANT

**READ THIS INSTRUCTION MANUAL CAREFULLY** before attempting to operate the repeater.

**SAVE THIS INSTRUCTION MANUAL**— This manual contains important safety and operating instructions for the IC-FR5200H/IC-FR6200H VHF/UHF FM REPEATERS.

## EXPLICIT DEFINITIONS

| WORD              | DEFINITION  |
|-------------------|---|
| <b>⚠ WARNING!</b> | Personal injury, fire hazard or electric shock may occur.                               |
| <b>CAUTION</b>    | Equipment damage may occur.   |
| <b>NOTE</b>       | If disregarded, inconvenience only. No risk of personal injury, fire or electric shock. |

## SUPPLIED ACCESSORIES

The following accessories are supplied.

Handles

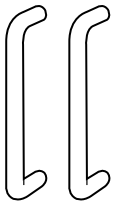

For handles attachment

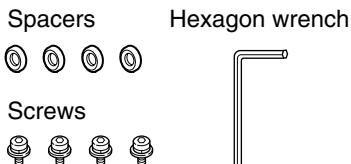

Connector

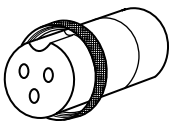

For the connector

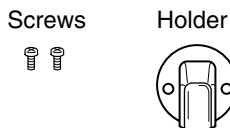

Function name stickers\*1

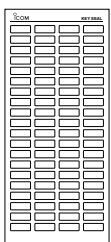

Rack

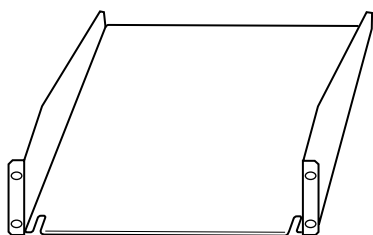

Square fuse (FGB01 30A)



\*1 Used for labelling the programmable function keys according to their assigned functions.

## PRECAUTIONS

**⚠ WARNING HIGH VOLTAGE! NEVER** attach an antenna or internal antenna connector during transmission. This may result in an electrical shock or burn.

**⚠ WARNING HIGH VOLTAGE! NEVER** install the antenna at any place that person touch the antenna easily during transmission. This may result in an electrical shock or burn.

**⚠ WARNING! NEVER** apply AC to the DC power connector on the repeater rear panel. This could cause a fire or damage the repeater.

**⚠ WARNING! NEVER** apply more than 16 V DC to the DC power connector on the repeater rear panel. This could cause a fire or damage the repeater.

**⚠ WARNING! NEVER** reverse the DC power cable polarity when connecting to a power source. This could cause a fire or damage the repeater.

**CAUTION: NEVER** let metal, wire or other objects touch any internal part or connectors on the rear panel of the repeater. This may result in an electric shock.

**CAUTION: NEVER** expose the repeater to rain, snow or any liquids.

**DO NOT** operate or place the repeater in areas with temperatures below  $-30^{\circ}\text{C}$  ( $-22^{\circ}\text{F}$ ) or above  $+60^{\circ}\text{C}$  ( $+140^{\circ}\text{F}$ ). Be aware that temperatures can exceed  $80^{\circ}\text{C}$  ( $+176^{\circ}\text{F}$ ), resulting in permanent damage to the repeater if left there for extended periods.

**DO NOT** place the repeater in excessively dusty environments or in direct sunlight.

**DO NOT** put anything on top of the repeater. This will obstruct heat dissipation.

**BE CAREFUL!** The heatsink will become hot when operating the repeater continuously for long periods.

**BE CAREFUL!** If a linear amplifier is connected, set the repeater's RF output power to less than the linear amplifier's maximum input level, otherwise, the linear amplifier will be damaged.

Use Icom microphones only (optional). Other manufacturer's microphones have different pin assignments, and may damage the repeater.

Place the repeater in a secure place to avoid inadvertent use by children.

**For U.S.A. only**

**CAUTION:** Changes or modifications to this repeater, not expressly approved by Icom Inc., could void your authority to operate this repeater under FCC regulations.

---

## FORWARD

---

Thank you for choosing this Icom repeater. The IC-FR5200H/IC-FR6200H VHF/UHF FM REPEATERS are designed and built with Icom's state of the art technology and craftsmanship. With proper care, this product should provide you with years of trouble-free operation.

We want to take a couple of moments of your time to thank you for making the IC-FR5200H/IC-FR6200H your repeater of choice, and hope you agree with Icom's philosophy of "technology first." Many hours of research and development went into the design of your IC-FR5200H/IC-FR6200H.

### ◇ **FEATURES**

- **Built-in 5-Tone, DTMF encoder & decoder**  
Multiple signaling systems are equipped as standard. These systems are fully compatible with Icom F-series radios.
- **DTMF remote control capability**  
You can control the repeater from a remote location over the air or over a phone line with DTMF.
- **D-Sub 25 pin ACC port equipped**  
You can use the optional equipment via the D-sub 25 pin ACC port equipped on the repeater's rear panel.
- **Other features**
  - Wide frequency coverage
    - <VHF>  
IC-FR5200H: 136 to 174 MHz
    - <UHF>  
IC-FR6200H: 350 to 400 MHz,  
400 to 470 MHz,  
450 to 512 MHz,  
450 to 520 MHz
  - PC programmable
  - 19 inch rack mount
  - Optional Voice Scrambler Unit (UT-109R/UT-110R) for base operating mode

Icom, Icom Inc. and the Icom logo are registered trademarks of Icom Incorporated (Japan) in Japan, the United States, the United Kingdom, Germany, France, Spain, Russia and/or other countries.

All other products or brands are registered trademarks or trademarks of their respective holders.

---

## TABLE OF CONTENTS

---

|  |            |
|--|------------|
| <b>IMPORTANT</b> .....                     | i          |
| <b>EXPLICIT DEFINITIONS</b> .....          | i          |
| <b>SUPPLIED ACCESSORIES</b> .....          | i          |
| <b>PRECAUTIONS</b> .....                   | i          |
| <b>FORWARD</b> .....                       | ii         |
| <b>TABLE OF CONTENTS</b> .....             | ii         |
| <b>SAFETY TRAINING INFORMATION</b> .....   | iii        |
| <b>1 PANEL DESCRIPTION</b> .....           | <b>1-3</b> |
| ■ Front panel .....                        | 1          |
| ◇ Function display .....                   | 2          |
| ■ Rear panel.....                          | 2          |
| ◇ Accessory connector .....                | 3          |
| <b>2 INSTALLATION AND CONNECTIONS</b> .... | <b>4-6</b> |
| ■ Unpacking .....                          | 4          |
| ■ Selecting a location .....               | 4          |
| ■ Antenna connection .....                 | 4          |
| ■ Front panel connection.....              | 5          |
| ■ Rear panel connection .....              | 5          |
| ■ Power supply connection .....            | 6          |
| ■ Mounting the repeater .....              | 6          |
| ◇ Using the supplied handle.....           | 6          |
| ■ Fuse replacement .....                   | 6          |
| ◇ Line fuse replacement.....               | 6          |
| <b>3 OPERATION</b> .....                   | <b>7</b>   |
| ■ Receiving and transmitting.....          | 7          |
| ◇ Repeater operation .....                 | 7          |
| ◇ Base station operation .....             | 7          |
| <b>4 MAINTENANCE</b> .....                 | <b>8</b>   |
| ■ Troubleshooting .....                    | 8          |
| <b>5 OPTIONS</b> .....                     | <b>9</b>   |
| <b>6 INFORMATION</b> .....                 | <b>10</b>  |

**1****2****3****4****5****6**

---

## SAFETY TRAINING INFORMATION

---



Your Icom radio generates RF electromagnetic energy during transmit mode. This radio is designed for and classified as “Occupational Use Only,” meaning it must be used only during the course of employment by individuals aware of the hazards, and the ways to minimize such hazards.

**This radio is NOT intended for use by the “General Population” in an uncontrolled environment.**

- For compliance with FCC and IC RF Exposure Requirements, the transmitter antenna installation shall comply with the following three conditions:
  1. The transmitter antenna gain shall not exceed 0 dBi.
  2. IC-FR5200H:  
Transmit only when people are at least the recommended minimum distance of 141 centimeters away from the properly installed antenna. This separation distance will ensure that there is sufficient distance from a properly installed externally-mounted antenna to satisfy the RF exposure requirements in the applicable RF exposure compliance standards.
  2. IC-FR6200H:  
Transmit only when people are at least the recommended minimum distance of 122 centimeters away from the properly installed antenna. This separation distance will ensure that there is sufficient distance from a properly installed externally-mounted antenna to satisfy the RF exposure requirements in the applicable RF exposure compliance standards.



To ensure that your exposure to RF electromagnetic energy is within the FCC and IC allowable limits for occupational use, always adhere to the following guidelines:

- **DO NOT** operate the radio without a proper antenna attached, as this may damage the radio and may also cause you to exceed FCC and IC RF exposure limits. A proper antenna is the antenna supplied with this radio by the manufacturer or an antenna specifically authorized by the manufacturer for use with this radio.

### **Electromagnetic Interference/Compatibility**

During transmissions, your Icom radio generates RF energy that can possibly cause interference with other devices or systems. To avoid such interference, turn off the radio in areas where signs are posted to do so. **DO NOT** operate the transmitter in areas that are sensitive to electromagnetic radiation such as hospitals, aircraft, and blasting sites.



Votre radio Icom produit une énergie électromagnétique de radiofréquences (RF), en mode de transmission. Cette radio est conçue pour un «usage professionnel seulement» et classée comme tel, ce qui signifie qu'elle doit être utilisée uniquement dans le cadre d'un travail par des personnes conscientes des dangers et des mesures visant à minimiser ces dangers. Elle **N'EST PAS** conçue pour une «utilisation grand public», dans un environnement non contrôlé.

- Afin de satisfaire aux exigences de la FCC et d'IC en matière d'exposition aux RF, il est nécessaire que l'antenne soit installée conformément aux trois conditions suivantes:

1. Le gain de l'antenne du radio émetteur ne doit pas dépasser 0 dBi.

2. IC-FR5200H:

Transmettre que lorsque les gens sont au moins la distance minimale recommandée de 141 centimètres de l'antenne est correctement installé. Cette distance de sécurité assurera que les personnes soient placées suffisamment loin d'une antenne correctement fixée à l'extérieur pour satisfaire aux exigences en matière d'exposition aux RF, en vertu des normes de conformité applicables.

2. IC-FR6200H:

Transmettre que lorsque les gens sont au moins la distance minimale recommandée de 122 centimètres de l'antenne est correctement installé. Cette distance de sécurité assurera que les personnes soient placées suffisamment loin d'une antenne correctement fixée à l'extérieur pour satisfaire aux exigences en matière d'exposition aux RF, en vertu des normes de conformité applicables.



Afin de vous assurer que votre exposition à une énergie électromagnétique de RF se situe dans les limites permises par la FCC et d'IC pour une utilisation grand public, veuillez en tout temps respecter les directives suivantes:

- **NE PAS** faire fonctionner la radio sans qu'une antenne appropriée y soit fixée, car ceci risque d'endommager la radio et causer une exposition supérieure aux limites établies par la FCC et d'IC. L'antenne appropriée est celle qui est fournie avec cette radio par le fabricant ou une antenne spécialement autorisée par le fabricant pour être utilisée avec cette radio.

#### **Interférence électromagnétique et compatibilité**

En mode de transmission, votre radio Icom produit de l'énergie de RF qui peut provoquer des interférences avec d'autres appareils ou systèmes. Pour éviter de telles interférences, mettez la radio hors tension dans les secteurs où une signalisation l'exige. **NE PAS** faire fonctionner l'émetteur dans des secteurs sensibles au rayonnement électromagnétique tels que les hôpitaux, les aéronefs et les sites de dynamitage.

## Front panel

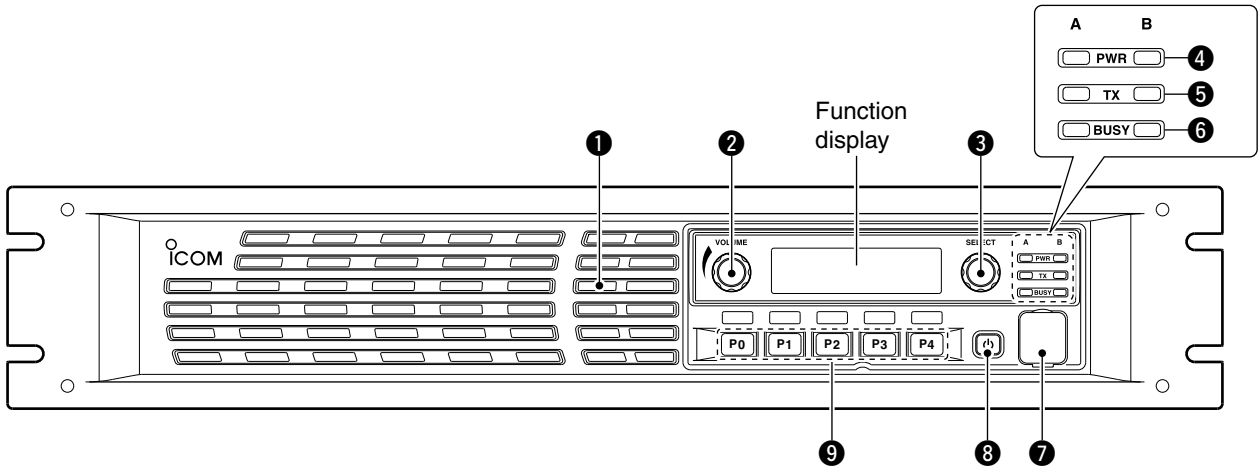

### 1 INTERNAL SPEAKER

Monitors received signals.

### 2 VOLUME CONTROL [VOLUME] (p. 7)

Adjusts the audio output level.

### 3 SELECTOR DIAL [SELECT]

Rotate to adjust the squelch threshold level, select the operating channel. (Depending on the pre-programmed condition.)

### 4 POWER INDICATOR [POWER]

➔ Lights green at 'A' module's indicator while the repeater power is turned ON.

#### **When a channel extension module is installed:**

➔ Lights green at the selected module indicator ('A' or 'B') while the repeater power is turned ON.

➔ Lights orange at the un-selected module indicator ('A' or 'B') while the repeater power is turned ON.

### 5 TRANSMIT INDICATOR [TX]

Lights red while transmitting.

### 6 BUSY INDICATOR [BUSY]

Lights green while receiving a signal or when the noise squelch is open.

#### **About [PWR], [TX] and [BUSY] indicators:**

'A' and 'B' modules indicators are available for these indications. 'A' module's indicator correspond to the original module, and 'B' module's indicator correspond to an extended module.

### 7 MICROPHONE CONNECTOR [MIC]

This 8-pin modular jack accepts the optional microphone.

KEEP the [MIC] connector cover attached to the repeater when the optional microphone is not used.

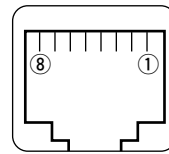

- ① +8 V DC output (Max. 15 mA)
- ② Output port for PC programming
- ③ NC
- ④ M PTT (Input port for TX control)
- ⑤ Microphone ground
- ⑥ Microphone input
- ⑦ Ground
- ⑧ Input port for PC programming

### 8 POWER SWITCH [POWER]

➔ Push to turn the repeater power ON.

➔ Push and hold for 3 sec. to turn the repeater power OFF.

#### **When a channel extension module is installed:**

➔ While the repeater power is turned ON, push to select the desired module to operate the repeater as the base station.

- The power indicator of the selected module unit lights green.

### 9 DEALER-PROGRAMMABLE KEYS

Desired functions can be programmed independently by your dealer.

Ask your dealer for details.

- Because these keys are programmable, the functions of these keys are unique to each unit.

◇ **Function display**

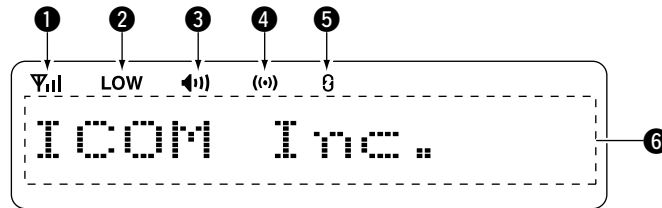

- 1 SIGNAL STRENGTH INDICATOR**  
Indicates relative signal strength level.

**2 LOW POWER INDICATOR**  
Appears when low output power is selected.

**3 AUDIBLE INDICATOR**  
Appears when the channel is in the 'audible' (unmute) condition.
- 4 COMPANDER INDICATOR**  
Appears when the compander function is activated.

**5 SCRAMBLER/ENCRYPTION INDICATOR**  
Appears when the voice scrambler/encryption function is activated.

**6 ALPHANUMERIC DISPLAY**  
Shows a variety of text or code information.

■ **Rear panel**

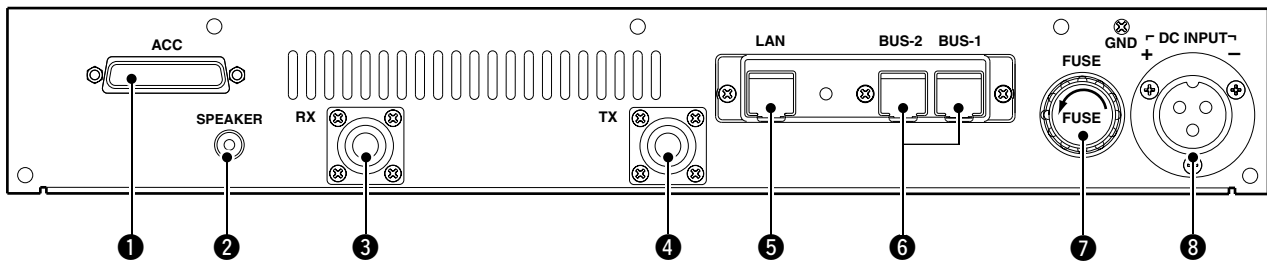

- 1 ACCESSORY CONNECTOR [ACC]**  
Connects to the accessory connector.  
• See page 3 for accessory connector information.

**2 EXTERNAL SPEAKER CONNECTOR [SPEAKER]**  
Connect the optional SP-22 or SP-35/SP-35L.

**3 RECEIVE ANTENNA CONNECTOR [RX]**  
Connects a receive antenna (impedance: 50 Ω) and inputs receiving signals.

**4 TRANSMIT ANTENNA CONNECTOR [TX]**  
Connects a transmit antenna (impedance: 50 Ω) and outputs transmit signals.

**5 LAN CONNECTOR [LAN]**  
For an Ethernet connection. Connect the controller to an Ethernet [LAN] port of a PC console through a Hub (or a router).  
In trunking mode operation, the controller at one end of the chain must be connected. You can control the controller and all others in the chain from the PC console.
- 6 BUS CONNECTORS [BUS-1]/[BUS-2]**  
For data communication between the controllers in trunking mode operation, either [BUS-1] or [BUS-2] can be used. They enable the controllers to be "daisy-chained" together, and form a network that allows trunking and other data to pass among them.

**7 FUSE**  
See page 6 to replace a damaged fuse.

**8 DC POWER CONNECTOR**  
Connects the supplied DC power cable from this connector to an external 13.6 V DC power supply. See page 5 for the connection details.

# 1 PANEL DESCRIPTION

## ◇ Accessory connector

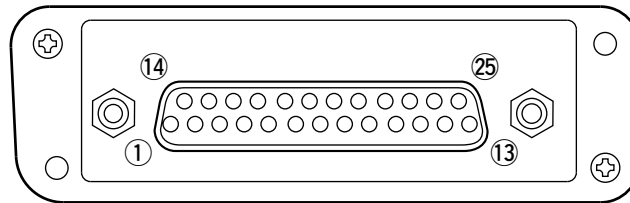

| Pin No. | Pin Name  | Description  | Specification                 |
|---------|-----------|--|-------------------------------|
| 1       | NC        | No connection  | —                             |
| 2       | TXD       | Output terminal for serial communication data.   | —                             |
| 3       | RXD       | Input terminal for serial communication data.  | —                             |
| 4       | RTS       | Output terminal for request-to-send data.  | —                             |
| 5       | CTS       | Input terminal for clear-to-send data.   | —                             |
| 6       | NC        | No connection  | —                             |
| 7       | GND       | Serial/digital signal ground   | —                             |
| 8       | MOD IN    | Modulator input from an external terminal unit.  | Input level: 300 mV rms       |
| 9       | DISC OUT  | Output terminal for AF signals from the AF detector circuit.<br>Output level is fixed, regardless of [AF] control. | Output level: 300 mV rms      |
| 10      | EXT. D/A  | The desired function can be assigned.*<br>(Default: Null)  | —                             |
| 11      | VCC       | 13.6 V DC output   | Output current: Less than 1 A |
| 12      | EXT. A/D  | Customize A/D input (Not used)   | —                             |
| 13      | NC        | No connection  | —                             |
| 14      | GND       | Ground   | —                             |
| 15      | EXT./O 15 | The desired function can be assigned.*<br>(Default: Null)  | +5 V pull up, Active=L        |
| 16      | EXT./O 16 | The desired function can be assigned.*<br>(Default: P0 Monitor Output)   | +5 V pull up, Active=L        |
| 17      | EXT./O 17 | The desired function can be assigned.*<br>(Default: Busy Output)   | +5 V pull up, Active=L        |
| 18      | EXT./O 18 | The desired function can be assigned.*<br>(Default: Null)  | +5 V pull up, Active=L        |
| 19      | EXT./O 19 | The desired function can be assigned.*<br>(Default: EPTT Input)  | +5 V pull up, Active=L        |
| 20      | DATA IN   | Input terminal for data.   | —                             |
| 21      | EXT./O 21 | The desired function can be assigned.*<br>(Default: Analog Audible Output)   | +5 V pull up, Active=L        |
| 22      | AF OUT    | The AF detector Output.  | —                             |
| 23      | EXT./O 23 | The desired function can be assigned.*<br>(Default: Mic Mute Output)   | +5 V pull up, Active=L        |
| 24      | EXT./O 24 | The desired function can be assigned.*<br>(Default: Null)  | +5 V pull up, Active=L        |
| 25      | EXT./O 25 | The desired function can be assigned.*<br>(Default: Mic Hanger Output)   | +5 V pull up, Active=L        |

\* The desired function can be assigned using the optional CS-FR5000 CLONING SOFTWARE. Ask your dealer for details.



## ■ Unpacking

After unpacking, immediately report any damage to the delivering carrier or dealer. Keep the shipping cartons.

For a description and a diagram of accessory equipment included with the repeater, see 'SUPPLIED ACCESSORIES' on page i of this manual.

## ■ Selecting a location

Select a location for the repeater that allows adequate air circulation, free from extreme heat, cold, or vibrations, and away from TV sets, TV antenna elements, radios and other electromagnetic sources.

## ■ Antenna connection

For radio communications, the antenna is a critical component, along with output power and sensitivity. Select antenna(s), such as a well-matched 50 Ω antenna, and feedline. 1.5:1 or better of Voltage Standing Wave Ratio (VSWR) is recommended for desired band. Of course, the transmission line should be a coaxial cable.

**CAUTION:** Protect repeater from lightning by using a lightning arrestor.

**NOTE:** There are many publications that describe proper antennas and their installation. Check with your local dealer for more information and recommendations.

## ■ Front panel connection

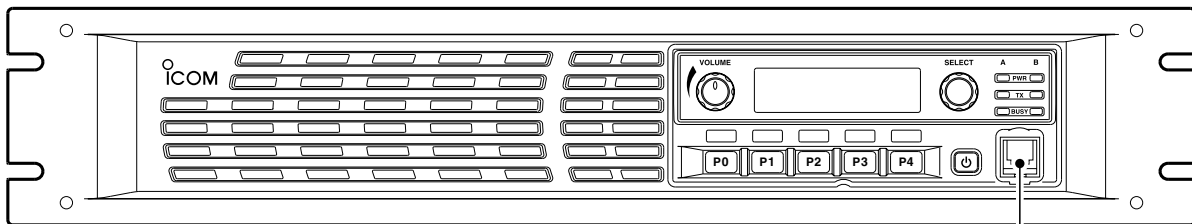

**HM-152 HAND MICROPHONE**  
(optional)



**SM-26 DESKTOP MICROPHONE**  
(optional)

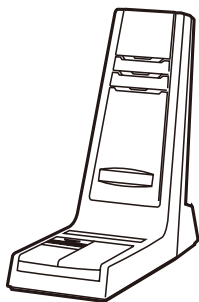

**MICROPHONE CONNECTOR** (Front panel view)

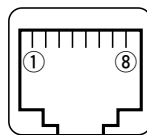

- ① +8 V DC output (Maximum 15 mA)
- ② Output port for PC programming
- ③ NC
- ④ M PTT (Input port for TX control)
- ⑤ Microphone ground
- ⑥ Microphone input
- ⑦ Ground
- ⑧ Input port for PC programming

**CAUTION: DO NOT** short pin 1 to ground as this can damage the internal 8 V regulator. DC voltage is applied to pin 1 for microphone operation. Only Icom microphones are recommended.

## ■ Rear panel connection

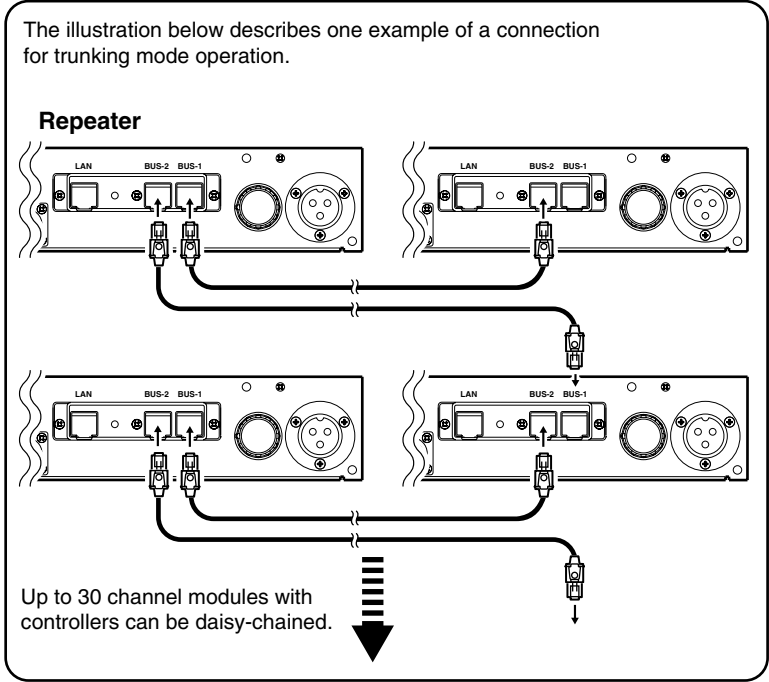
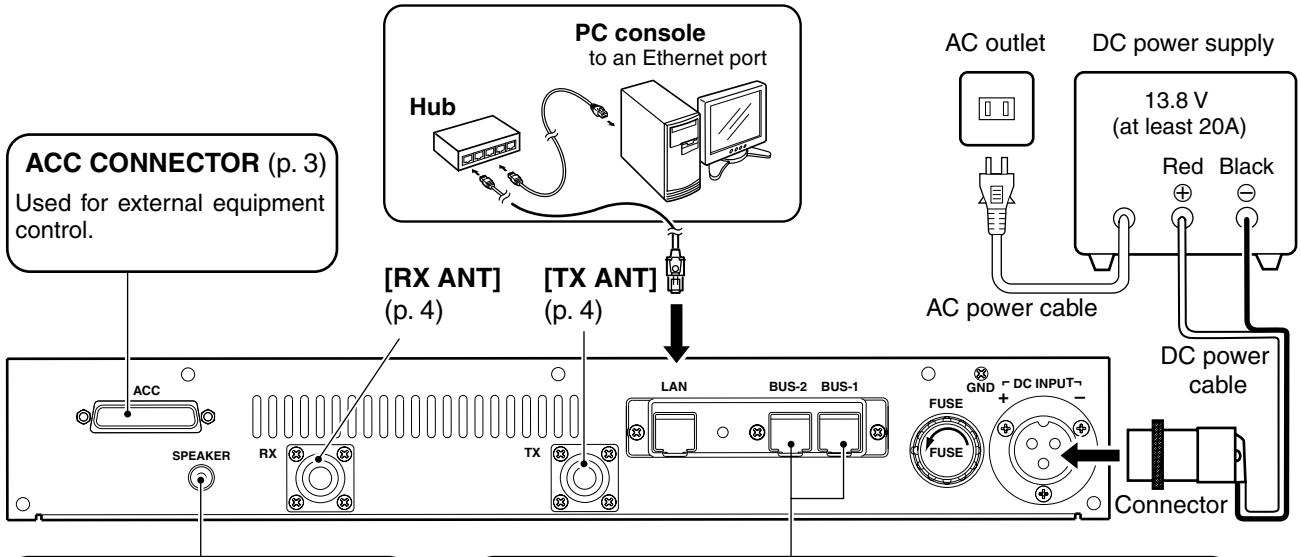

## ■ Power supply connection

Make sure the repeater's power is turned OFF when connecting a DC power cable.

**CAUTION:** Voltages greater than 16 V DC will damage the repeater. Check the source voltage before connecting the power cable.

## ■ Mounting the repeater

### ◇ Using the supplied handle

The supplied handles are available for mounting the repeater into a 19 inch rack. The handles can be installed to the repeater's front panel.

- ① Attach the supplied handles to both sides of the repeater's front panel with the spacers, then tighten the screws as described below.

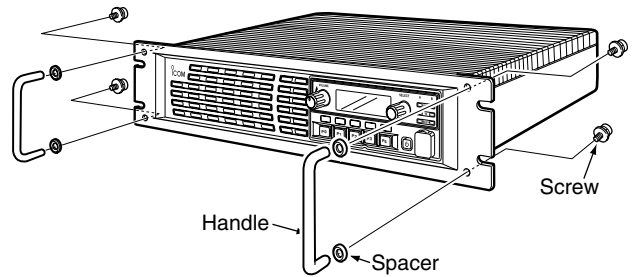

- ② The completed installation should look like as described below.

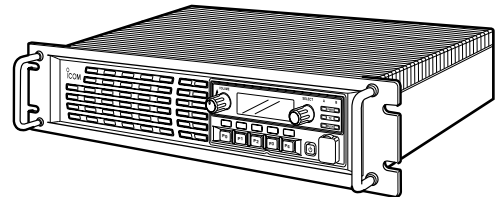

## ■ Fuse replacement

If a fuse blows or the repeater stops functioning, try to find the source of the problem, and then replace the damaged fuse with a new rated one.

**CAUTION: DISCONNECT** the DC power cable from the repeater. Otherwise, there is danger of electric shock and/or equipment damage.

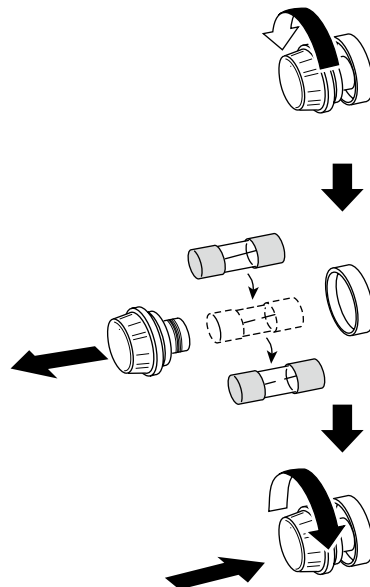

## ■ Receiving and transmitting

### ◇ Repeater operation

Ask your dealer for details of the repeater's programming.

- When the power is turned ON, the **[PWR]** indicator lights green. (p. 1)
- The **[TX]** and **[BUSY]** indicators light simultaneously while transmitting/receiving a signal.
  - The **[TX]** indicator lights red.
  - The **[BUSY]** indicator lights green.

**NOTE:** A power amplifier protector is built-in to the repeater. The protector is activated when the repeater temperature becomes extremely high due to the frequently access to the repeater to reduce the transmit output power level. The output power will return to the normal level when the repeater has cooled down.

### ◇ Base station operation

#### **Receiving**

- ① Push **[POWER]** to turn the power ON.
- ② Set the audio and squelch levels.
  - Rotate **[SELECT]**\*<sup>1</sup> fully counterclockwise in advance.
  - Rotate **[VOLUME]** to adjust the audio output level.
  - Rotate **[SELECT]**\*<sup>1</sup> clockwise until the noise disappears.
- ③ Push **[CH Up]**\*<sup>2</sup> or **[CH Down]**\*<sup>2</sup> to select the desired channel.
  - When receiving a signal, the **[BUSY]** indicator lights green and audio is emitted from the speaker.
  - Further adjustment of **[VOLUME]** to a comfortable listening level may be necessary at this point.

\*<sup>1</sup> When the [SQL Level Up/Down] key function is assigned to [SELECT].

\*<sup>2</sup> When the [CH Up]/[CH Down] key functions are assigned.

#### **Transmitting**

- ① Take the microphone off hook.
- ② Wait for the channel to become clear.
- ③ Push and hold **[PTT]** to transmit, then speak into the microphone at your normal voice level.
- ④ Release **[PTT]** to receive.

#### **IMPORTANT:**

To maximize the audio quality of the transmitted signal:

1. Pause briefly after pushing **[PTT]**.
2. Hold the microphone 5 to 10 cm (2 to 4 inch) from your mouth, then speak into the microphone at a normal voice level.

## ■ Troubleshooting

The following chart is designed to help you correct problems which are not equipment malfunctions.

If you are unable to locate the cause of a problem or solve it through the use of this chart, contact your nearest Icom Dealer or Service Center.

| PROBLEM   | POSSIBLE CAUSE  | SOLUTION  | REF.                        |
|---|---|---|-----------------------------|
| Power does not come on when <b>[POWER]</b> is pushed.   | <ul style="list-style-type: none"> <li>• DC power cable is improperly connected.</li> <li>• Fuse is blown.</li> </ul>   | <ul style="list-style-type: none"> <li>• Re-connect the DC power cable correctly.</li> <li>• Check for the cause, then replace the fuse with a spare one.</li> </ul>  | pp. 5, 6<br>p. 8            |
| No sound comes from the speaker.                        | <ul style="list-style-type: none"> <li>• Volume level is too low.</li> <li>• The squelch is closed.</li> <li>• The audio mute function is activated.</li> <li>• A selective call or squelch function is activated such as 5-tone call or tone squelch.</li> <li>• The front speaker is set to OFF.</li> </ul> | <ul style="list-style-type: none"> <li>• Rotate <b>[VOLUME]</b> clockwise to obtain a suitable listening level.</li> <li>• While in base operating mode, rotate <b>[SELECT]</b> to counterclockwise to open the squelch. (When the [SQL Level Up/Down] key function is assigned to <b>[SELECT]</b>.)</li> <li>• Push <b>[MONI]</b> (if assigned) to turn the audio mute function OFF.</li> <li>• Turn the appropriate function OFF.</li> <li>• Turn the front speaker ON using the optional CS-FR5000 CLONING SOFTWARE. Ask your dealer for details.</li> </ul> | p. 7<br>p. 7<br>–<br>–<br>– |
| Sensitivity is low and only strong signals are audible. | <ul style="list-style-type: none"> <li>• Antenna feedline or the antenna connector has a poor contact or is short-circuited.</li> </ul>   | <ul style="list-style-type: none"> <li>• Check and re-connect (or replace if necessary), the antenna feedline or antenna connector.</li> </ul>  | p. 5                        |
| Received audio is unclear or distorted.                 | <ul style="list-style-type: none"> <li>• Optional voice scrambler is turned OFF.</li> <li>• Scrambler code is not set correctly.</li> </ul>   | <ul style="list-style-type: none"> <li>• Turn the optional voice scrambler ON.</li> <li>• Reset the scrambler code.</li> </ul>  | –<br>–                      |
| Output power is too low.                                | <ul style="list-style-type: none"> <li>• Output power is set to Low.</li> <li>• Power amplifier protection circuit is activated.</li> </ul>   | <ul style="list-style-type: none"> <li>• Push <b>[HIGH/LOW]</b> (if assigned) to select the High power.</li> <li>• Cool down the repeater or stop accessing to the repeater until it has cooled down.</li> </ul>  | –<br>–                      |
| No contact possible with another station.               | <ul style="list-style-type: none"> <li>• The other station is using tone squelch.</li> <li>• While in base operating mode, the repeater is set to duplex.</li> </ul>  | <ul style="list-style-type: none"> <li>• Turn the tone squelch function ON.</li> <li>• Set the repeater to simplex, when other transceiver is set to simplex.</li> </ul>  | –<br>–                      |

- **SP-35/SP-35L** EXTERNAL SPEAKERS

Input impedance : 4  $\Omega$

Maximum input power : 7 W

- **HM-152** HAND MICROPHONE

- **SM-26** DESKTOP MICROPHONE

- **UT-109R** VOICE SCRAMBLER UNIT

Non-rolling type (maximum 32 codes).

- **UT-110R** VOICE SCRAMBLER UNIT

Rolling type (maximum 1020 codes).

\* The scrambler systems of the UT-109R and UT-110R are not compatible with each other.

Approved Icom optional equipment is designed for optimal performance when used with an Icom repeater. Icom is not responsible for the destruction or damage to an Icom repeater in the event the Icom repeater is used with equipment that is not manufactured or approved by Icom.

Some options may not be available in some countries. Please ask your dealer for details.

**• ABOUT VOICE CODING TECHNOLOGY**

The AMBE+2™ voice coding Technology embodied in this product is protected by intellectual property rights including patent rights, copyrights and trade secrets of Digital Voice Systems, Inc. This voice coding Technology is licensed solely for use within this Communications Equipment. The user of this Technology is explicitly prohibited from attempting to extract, remove, decompile, reverse engineer, or disassemble the Object Code, or in any other way convert the Object Code into a human-readable form. U.S. Patent Nos. #5,870,405, #5,826,222, #5,754,974, #5,701,390, #5,715,365, #5,649,050, #5,630,011, #5,581,656, #5,517,511, #5,491,772, #5,247,579, #5,226,084 and #5,195,166.

**• FOR CLASS A UNINTENTIONAL RADIATORS:**

This equipment has been tested and found to comply with the limits for a Class A digital device, pursuant to part 15 of the FCC Rules. These limits are designed to provide reasonable protection against harmful interference when the equipment is operated in a commercial environment. This equipment generates, uses, and can radiate radio frequency energy and, if not installed and used in accordance with the instruction manual, may cause harmful interference to radio communications. Operation of this equipment in a residential area is likely to cause harmful interference in which case the user will be required to correct the interference at his own expense.

**Count on us!**

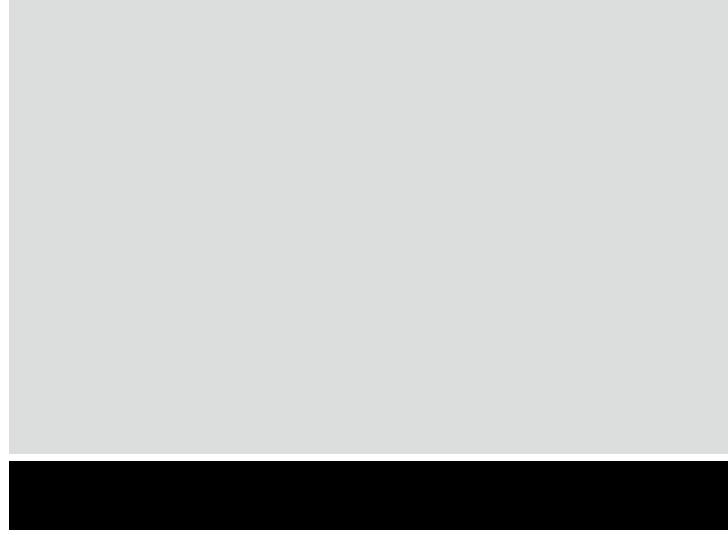

---

---

---

---

---

---

---

---