

The ICOM logo consists of a stylized lowercase 'i' with a circle above it, followed by the word 'COM' in a bold, sans-serif font.

INSTRUCTION MANUAL

DUAL BAND FM TRANSCEIVER

IC-Q7A
IC-Q7E

This device complies with Part 15 of the FCC rules. Operation is subject to the following two conditions: (1) This device may not cause harmful interference, and (2) this device must accept any interference received, including interference that may cause undesired operation.

Icom Inc.

FOREWORD

READ ALL INSTRUCTIONS carefully and completely before using the transceiver.

SAVE THIS INSTRUCTION MANUAL — This instruction manual contains important operating instructions for the IC-Q7^E.

EXPLICIT DEFINITIONS

The explicit definitions below apply to this instruction manual.

WORD	DEFINITION
⚠ WARNING	Personal injury, fire hazard or electric shock may occur.
CAUTION	Equipment damage may occur.
NOTE	If disregarded, inconvenience only. No risk of personal injury, fire or electric shock.

CE Versions of the IC-Q7^E which display "CE" on the serial number seal, comply with the essential requirements of the 89/336/EEC directive for Electromagnetic Compatibility.

CAUTIONS

⚠ WARNING! NEVER hold the transceiver so that the antenna is very close to, or touching exposed parts of the body, especially the face or eyes, while transmitting. The transceiver will perform best if the microphone is 5 to 10 cm away from the lips and the transceiver is vertical.

⚠ WARNING! NEVER operate the transceiver with a headset or other audio accessories at high volume levels. Hearing experts advise against continuous high volume operation. If you experience a ringing in your ears, reduce the volume level or discontinue use.

DO NOT push the PTT when not actually desiring to transmit.

DO NOT allow children to play with any radio equipment containing a transmitter.

DO NOT operate the transceiver near unshielded electrical blasting caps or in an explosive atmosphere.

AVOID using or placing the transceiver in direct sunlight or in areas with temperatures below -10°C ($+14^{\circ}\text{F}$) or above $+60^{\circ}\text{C}$ ($+140^{\circ}\text{F}$).

SUPPLIED ACCESSORIES

Even when the transceiver power is OFF, a slight current still flows in the circuits. Remove batteries from the transceiver when not using it for a long time. Otherwise, the installed batteries will become exhausted.

Accessories included with the transceiver:	Qty.
① Antenna (FA-S270C)	1
② Handstrap	1
③ Belt clip	1

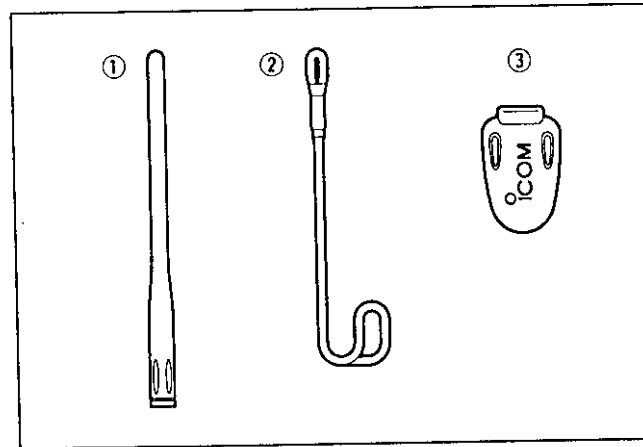

FCC U.S.A only
Caution:



TABLE OF CONTENTS

FOREWORD	i	■ Display backlighting	11	■ Offset frequency	24
EXPLICIT DEFINITIONS	i	5 MEMORY/CALL CHANNELS ..	12–14	■ Auto repeater function	25
CAUTIONS	i	■ General	12	9 SUBAUDIBLE TONE	
SUPPLIED ACCESSORIES	ii	■ Programming during selection ..	12	OPERATION	26–27
TABLE OF CONTENTS	iii	■ Programming after selection ...	13	■ Tone squelch operation	26
1 ACCESSORY ATTACHMENT	1	■ Transferring memory contents		■ Pocket beep operation	27
2 PANEL DESCRIPTION	2–5	to another	13	■ Tone scan	27
■ Panel description	2	■ Memory clear	14	10 OTHER FUNCTIONS	28–32
■ Function display	4	■ Call channel	14	■ Set mode	28
3 FREQUENCY AND CHANNEL		6 SCAN OPERATION	15–19	■ Dial select step	29
SETTING	6–8	■ Scan types	15	■ Beep tones	29
■ VFO and memory/call channel ...	6	■ Full/band/programmed scan ...	16	■ Power saver	29
■ Operating band selection	6	■ Memory (bank) scan	16	■ Auto power-off function	30
■ Setting a frequency	7	■ Selecting scan edges	17	■ Monitor switch function	30
■ Setting a tuning step	7	■ Skip channel setting	18	■ Dial speed acceleration	31
■ Selecting a memory channel	8	■ Scan resume condition	18	■ <u>Lock function effect</u>	<u>31</u>
■ Lock function	8	■ Frequency skip function	19	■ Channel indication mode	32
■ RIT function	8	7 PRIORITY WATCH	20–21	■ Partial reset	32
4 BASIC OPERATION	9–11	■ Priority watch types	20	■ All reset	32
■ Receiving and transmitting	9	■ Priority watch operation	21	11 TROUBLESHOOTING	33
■ Setting volume level	10	8 REPEATER OPERATION ..	22–25	12 OPERATION FLOW CHART ...	34–35
■ Setting squelch level	10	■ General	22	13 SPECIFICATIONS	36–37
■ Monitor function	10	■ Subaudible (repeater) tones ...	23	14 OPTIONS	38
■ Receive mode selection	11	■ 1750 Hz tone	24		

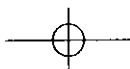

ACCESSORY ATTACHMENT

1

◇ Antenna

CAUTION: Transmitting without an antenna may damage the transceiver.

Insert the supplied antenna into the antenna connector and screw down the antenna as shown at right.

Keep the jack cover attached when jack is not in use to avoid bad contacts from dust and moisture.

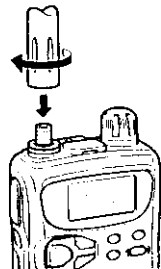

◇ Battery installation

① Remove the battery cover from the transceiver.

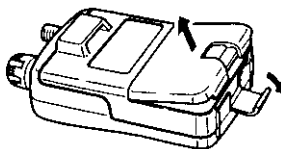

② Install 2 R6 (AA) size alkaline or dry cell batteries.

- Be sure to observe the correct polarity.

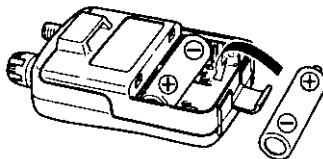

Keep battery contacts clean. It's a good idea to clean battery terminals once a week.

◇ Belt clip

Conveniently attaches to your belt.

Slide the belt clip into the plastic loop on the back of the transceiver.

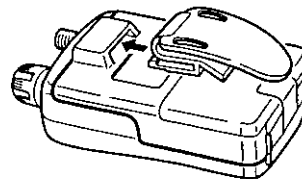

◇ Handstrap

Slide the handstrap through the loop on the side of the belt clip as illustrated at right. Facilitates carrying.

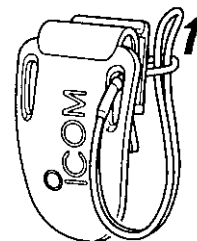

2

PANEL DESCRIPTION

■ Panel description

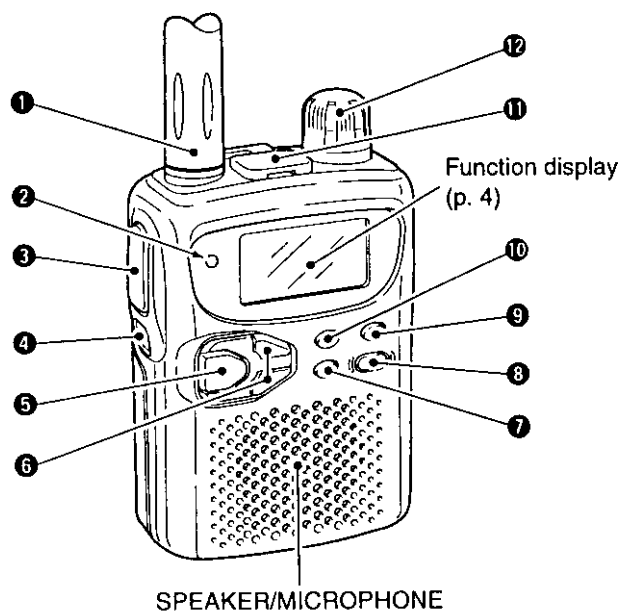

- 1 ANTENNA CONNECTOR** (p. 1)
Connects the supplied antenna.

2 TRANSMIT/RECEIVE INDICATOR [TX/RX] (p. 9)

Lights green while receiving a signal or when the squelch is open; lights red while transmitting.

3 PTT SWITCH [PTT]

- Push and hold to transmit in amateur bands; release to receive. (p. 9)
- Push briefly, then push and hold to transmit a 1750 Hz tone. (Eur., France and Italy versions only; p. 24)

4 FUNCTION SWITCH [FUNC]

- While pushing this switch, other switches and tuning dial perform secondary functions.
- "Push [FUNC] + a switch" means "while pushing the [FUNC] switch, push the switch."

5 BAND SWITCH [BAND]

- Push to select the operating band (VHF, UHF, etc.). (p. 6)
 - 50 MHz band,* VHF avionics band,* 144 MHz band, 300 MHz band,* 400 MHz band, 800 MHz band* and 1200 MHz band* can be selected.
- Transfers the displayed frequency to the VFO in memory mode. (p. 6)
- Push [FUNC] + [BAND] to toggle the RIT function at 800 MHz* and above. (p. 8)
- Push for 2 sec. to set the tuning step for the operating band or the selected memory channel. (p. 7)

PANEL DESCRIPTION 2

6 VOLUME CONTROL SWITCHES [VOL▲]/[VOL▼]

- Push to adjust the audio level. (p. 10)
- Push [FUNC] + either switch to start a scan. (p. 16)
- Push [FUNC] + either switch for 2 sec. to start a tone scan. (p. 27)

7 VFO/MEMORY SWITCH [V/M]

- Toggles between VFO and memory modes. (p. 6)
- Enters set mode when pushed for 2 sec. (p. 28)
- Push [FUNC] + [V/M] enters memory write mode. (p. 12)
- Push [FUNC] + [V/M] for 2 sec. writes the operating frequency into the selected memory channel in VFO mode. (p. 13)
- Push [FUNC] + [V/M] for 2 sec. writes the displayed frequency into the VFO in memory mode. (p. 13)

8 POWER SWITCH [POWER]

Push for 2 sec. to toggle the transceiver power ON and OFF.

9 MONITOR SWITCH [SQL] (p. 10)

- Push and hold to temporarily open the squelch and monitors the operating frequency. (by default)
- While pushing, rotate the tuning dial to set the squelch threshold level.
- Push [FUNC] + [SQL] to exchange the receive/transmit frequency and duplex direction when the duplex function is in use.

10 CALL/LOCK SWITCH [CALL (LOCK)]

- Selects the call channel. (p. 14)
- Push [FUNC] + [CALL] to toggle the lock function ON and OFF. (p. 8)
- While in the memory channel programming condition, push [FUNC] + [CALL] for 2 sec. to clear the contents. (p. 14)
- Generates a 1750 Hz tone for repeater access while transmitting. (Eur., France and Italy versions only; p. 24)

11 EXTERNAL SPEAKER AND MICROPHONE JACK [SP/MIC]

Connects an optional speaker-microphone or headset via an optional OPC-782 PLUG ADAPTER CABLE, if desired. The internal microphone and speaker will not function when the OPC-782 is connected. (See p. 38 for a list of available options.)

12 TUNING DIAL [DIAL]

- Rotate [DIAL] to set operating frequencies, memory channels, set mode contents, etc. (p. 7)
- While pushing [SQL], this dial sets the squelch level. (p. 10)
- While pushing [FUNC], this dial sets the operating frequency in 100 kHz, 1 MHz or 10 MHz steps in VFO mode. (pgs. 7, 29)
- While pushing [FUNC], this dial sets the operating channel in 10 channel steps in memory mode. (pgs. 7, 8)

2 PANEL DESCRIPTION

■ Function display

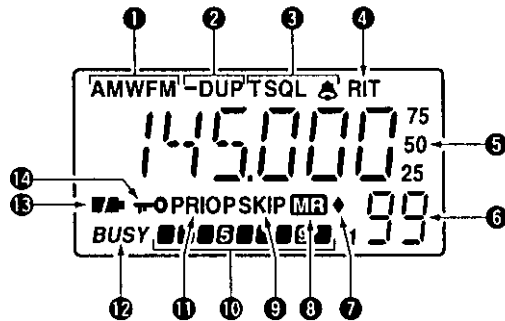

1 RECEIVE MODE INDICATORS (p. 11)

Show the receive mode.

- Receive mode is physical property of radio signals.

2 DUPLEX INDICATORS (p. 22)

Appear when semi-duplex operation (repeater operation) is in use.

- “-DUP” appears when minus duplex is selected; “DUP” only, appears when plus duplex is selected.

3 TONE INDICATORS (pgs. 23, 26, 27)

- ↳ “T” appears when the subaudible tone encoder is in use; “T SQL” appears during pocket beep operation and “T SQL” appears when the tone squelch function is activated.
- ↳ Only “” appears when the pocket beep function is in use.

4 RIT INDICATOR

Appears when the RIT (Receive Incremental Tuning) function for 800 MHz and above is in use. (p. 8)

- Except for the Australia, Taiwan and Korea versions.

5 FREQUENCY READOUT

Shows the operating frequency, set mode contents, etc.

- The smaller “75,” “50” and “25” to the right of readout indicate 7.5, 5.0 and 2.5 kHz, respectively.
- The decimal point of the frequency flashes during scan.

6 MEMORY CHANNEL READOUT

Shows the memory or call channel number, etc.

7 MEMORY BANK INDICATOR

Flashes when the bank memory scan is activated.

8 MEMORY MODE INDICATOR

Appears when a memory channel is selected.

PANEL DESCRIPTION 2

9 SKIP SCAN INDICATOR (p. 18)

- "SKIP" appears when a selected memory channel is set as a skip channel.
- "PSKIP" appears when the memory channel frequency is set as a skip frequency during scanning.

10 SIGNAL INDICATORS

Shows the relative signal strength while receiving.

11 PRIORITY WATCH INDICATOR (p. 20)

Appears when the priority watch is in use.

12 BUSY INDICATOR

"BUSY" appears when receiving a signal or when the squelch is open.

13 LOCK INDICATOR (p. 8)

Indicates that the lock function is in use.

14 BATTERY INDICATORS

- All dots appear when the batteries have enough capacity.
- One dot appears when the batteries are nearing exhaustion.
- Flash when the battery replacement is necessary.

3

FREQUENCY AND CHANNEL SETTING

■ VFO and memory/call channels

This transceiver has 2 normal operating modes: VFO mode and memory (call) mode.

VFO mode is used for setting a desired frequency within the band range.

- ➔ Push [V/M] once or twice to select VFO mode.



Memory (call) mode is used for operation of memory (call) channels which have programmed frequencies.

- ➔ Push [V/M] once or twice to select memory mode.
 - To program a memory, refer to p. 12.

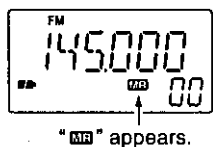

- ➔ Push [CALL(LOCK)] to select a call channel.

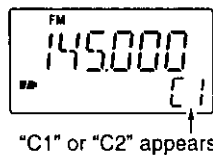

What is VFO?

VFO is an abbreviation of Variable Frequency Oscillator. Frequencies for transmitting and receiving are generated and controlled by the VFO.

■ Operating band selection

The transceiver can receive 50 MHz band, VHF avionics band, 144 MHz band, 300 MHz band, 400 MHz band, 800 MHz band* and 1200 MHz band can be selected.

- ➔ Push [BAND] several times to select the desired band.

- When a memory or call channel is selected, the first push of [BAND] selects VFO mode (and transfers the memory or call channel contents).

NOTE: When pushing [PTT], "OFF" appears indicating the frequency are outside the 144/400 MHz amateur bands.

*Some frequencies cannot be received for the U.S.A. version.

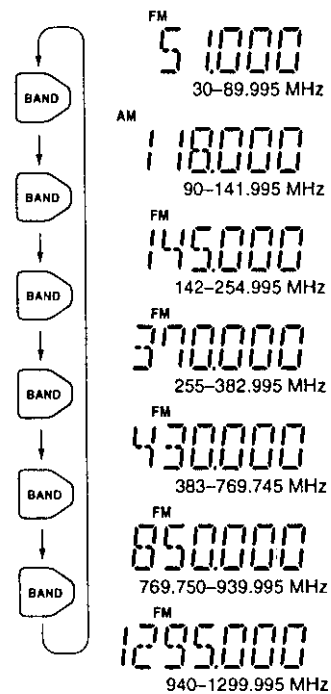

FREQUENCY AND CHANNEL SETTING 3

■ Setting a frequency

- ① Select VFO mode with [V/M].
- ② Select the desired band with [BAND].
- ③ Rotate [DIAL] to change the frequency.
 - The frequency changes according to the preset tuning steps. See the right section for selecting the tuning step.
 - Rotating [DIAL] while pushing [FUNC] to change the frequency in 1 MHz steps (default).



[DIAL] changes the frequency according to the selected tuning step.



While pushing [FUNC], [DIAL] changes the frequency in 1 MHz steps (default).

/// The 1 MHz tuning step (dial select step) can be selected from 100 kHz, 1 MHz and 10 MHz tuning steps in set mode. See p. 29 for details.

■ Setting a tuning step

Tuning steps can be selected for each band. This transceiver has 10 tuning steps as follows:

- 5 kHz • 6.25 kHz • 10 kHz • 12.5 kHz • 15 kHz
- 20 kHz • 25 kHz • 30 kHz • 50 kHz • 100 kHz

◇ Using band switch

- ① Select VFO mode with [V/M].
- ② Push [BAND] for 2 sec. to enter tuning step setting condition.
- ③ Rotate [DIAL] to select the desired tuning step.
- ④ Push [BAND] to set the selected tuning step.

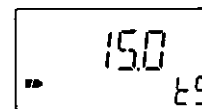

15 kHz tuning step

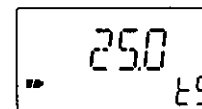

25 kHz tuning step

◇ Using set mode

- ① Select VFO mode with [V/M].
- ② Select the desired band with [BAND].
- ③ Push [V/M] for 2 sec. to enter set mode.
- ④ Rotate [DIAL] until "STEP" appears.
 - "STEP" disappears after 1 sec. and the previously selected tuning step and "TS" appear.
- ⑤ While pushing [FUNC], rotate [DIAL] to select the desired tuning step.
- ⑥ Push [V/M] to exit set mode.

3 FREQUENCY AND CHANNEL SETTING

■ Selecting a memory channel

- ① Push [V/M] once or twice to select memory mode.
 - "MR" appears when a memory channel is selected.
- ② Rotate [DIAL] to change the indicated memory channel.
 - Only programmed memory channels can be selected.
 - Rotating [DIAL] while pushing [FUNC] to change the channel in 10 channel steps.



[DIAL] changes the memory channel.



While pushing [FUNC], [DIAL] changes the memory channel in 10 channel steps.

■ Lock function

The lock function prevents accidental frequency changes and accidental function access.

- ➔ Push [FUNC] + [(CALL)LOCK] to toggle the lock function ON and OFF.
 - [POWER], [VOL], [SQL] and [PTT] can still be accessed while the lock function is ON (default).
 - Accessible switches can be set from 4 types in expanded set mode. See p. 31 for details.



"🔒" appears when the lock function is in use.

■ RIT function

To compensate for the off frequency of a transmitting station, the transceiver has receive incremental tuning for receiving frequencies above 835 MHz.

The receive incremental tuning (RIT) shifts only the receive frequency within approx. ±5 kHz.

- ① Set an operating frequency above 835 MHz.
- ② Push [FUNC] + [BAND] to turn the RIT function ON.
 - "RIT" appears.
- ③ While pushing [FUNC], rotate [DIAL] to adjust the shift frequency.
 - -5 to 5 appear at the memory channel readout while setting the shift frequency.



Plus shift



Minus shift

- ④ To cancel the function, push [FUNC] + [BAND] to turn the RIT function ON.
 - "RIT" disappears.

⚡ While the RIT function is in use, the dial select step cannot be used. (pgs. 7, 29)

BASIC OPERATION

4

■ Receiving and transmitting

CAUTION: Transmitting without an antenna may damage the transceiver.

- ① Install alkaline or dry cell batteries. (p. 1)
- ② Push [POWER] for 2 sec. to turn power ON.
- ③ Push [VOL ▲] or [VOL ▼] to set the desired audio level.
 - The frequency display shows the volume level while setting. See the next page for details.
- ④ Set an operating frequency. (pgs. 6, 7)
- ⑤ Set the squelch level.
 - While pushing [SQL], rotate the [DIAL].
 - The first click of [DIAL] indicates the current squelch level.
 - “LEVEL1” is loose squelch and “LEVEL9” is tight squelch.
 - “AUTO” is automatic level adjustment with a noise pulse count system.
- ⑥ When a signal is received:
 - The TX/RX indicator lights green.
 - Squelch opens and audio is emitted from the speaker.
 - The S/RF indicator shows the relative signal strength.
- ⑦ Push and hold [PTT] to transmit, then speak into the microphone.
 - TX/RX indicator lights red.
- ⑧ Release [PTT] to receive.

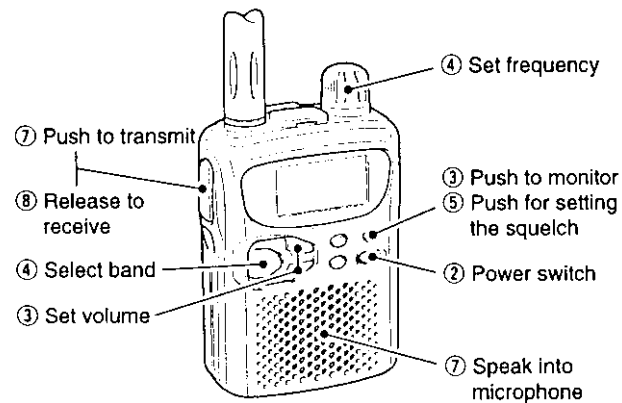

IMPORTANT: To maximize the readability of your transmitted signal, pause a few sec. after pushing [PTT], hold the microphone 10 to 15 cm from your mouth and speak at a normal voice level.

4 BASIC OPERATION

■ Setting volume level

The audio level can be adjusted from 32 volume levels.

- ➔ Push [VOL▲] or [VOL▼] to set the desired audio level.
 - Beep tone sounds while setting. This indicates the sound level approximately.
 - Pushing and holding these keys change the audio level continuously.
 - The frequency display shows the volume level while setting.

INDICATION	AUDIO LEVEL
-----	Min. setting (no audio)
0-----	:
00-----	Initial setting
000-----	:
0000-----	:
00000-----	:
0000000	Max. setting

■ Setting squelch level

The squelch circuit mutes the received audio signal depending on the signal strength. The transceiver has 9 levels of squelch setting, continuously open setting and automatic squelch setting.

- While pushing [SQL], rotate the [DIAL].
- The first click of [DIAL] indicates the current squelch level.
- "LEVEL1" is loose squelch and "LEVEL9" is tight squelch.
- "AUTO" is automatic level adjustment with a noise pulse count system.



Automatic squelch

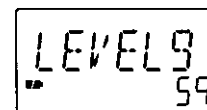

Maximum level

■ Monitor function

This function is used to listen to weak signals or to open the tone squelch manually.

- ➔ Push and hold [SQL] to monitor the operating frequency.

▨ The [SQL] switch can be set as monitor ON/OFF switch in expanded set mode. (p. 30)

■ Receive mode selection

Receive mode is physical property of radio signals. The transceiver has 3 receiving modes: FM, AM and WFM modes. The mode selection is stored separately in each band and memory channels.

Typically, AM mode is used for air band (118–135.995 MHz) and WFM is used for FM broadcast station (76–107.9 MHz).

NOTE: When pushing [PTT], a beep tone sounds indicating the mode is not FM mode. The transceiver cannot transmit in AM or WFM mode.

◇ Setting the receive mode

- ① Push [V/M] for 2 sec. to enter set mode.
- ② Rotate [DIAL] until "MOD" appears.
 - "MOD" disappears after 1 sec. and the previously selected receive mode and "md" appear.
- ③ While pushing [FUNC], rotate [DIAL] to select the desired receive mode.
- ④ Push [V/M] to exit set mode.

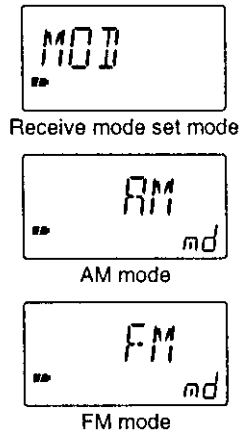

■ Display backlighting

The transceiver has display backlighting with a 5 sec. timer for nighttime operation. The display backlighting can be turned ON continuously or turned OFF, if desired.

- ➔ Push any switch except [PTT] and [FUNC]; or, rotate [DIAL] to turn the backlighting ON.
 - When the auto backlighting is set, the backlighting will automatically turn OFF when switches and [DIAL] have not been operated for 5 sec.

◇ Setting the backlighting setting

- ① Push [V/M] for 2 sec. to enter set mode.
- ② Rotate [DIAL] until "LIGHT" appears.
 - "LIGHT" disappears after 1 sec. and the previously selected backlighting timer and "LI" appear.
- ③ While pushing [FUNC], rotate [DIAL] to select the desired backlighting setting.
- ④ Push [V/M] to exit set mode.

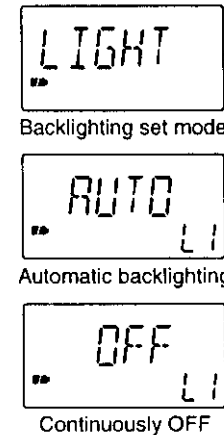

5

MEMORY/CALL CHANNELS

■ General

The transceiver has 200 memory channels and 2 call channels for storage of often-used frequencies.

◇ Memory/call channel contents

The following information can be programmed into memory or call channels:

- Operating frequency (p. 7)
- Receive mode (p. 11)
- Tuning step (p. 7)
- Duplex direction (DUP or -DUP) with an offset frequency (pgs. 22, 24)
- Subaudible tone encoder or tone squelch ON/OFF (pgs. 23, 26)
- Subaudible tone and tone squelch frequencies (pgs. 23, 26)
- Scan skip setting (p. 18)

■ Programming during selection

- ① Select VFO mode with [V/M].
- ② Set the desired frequency:
 - Select the desired band with [BAND].
 - Set the frequency using [DIAL].
 - Set other data (e.g. offset frequency, duplex direction, subaudible tone frequency, etc.), if required.
- ③ Push [FUNC] + [V/M] momentarily to indicate memory channels.
 - Do not hold [FUNC] + [V/M] for more than 0.5 sec., otherwise the memory channel will overwrite the selected memory channel.
- ④ Rotate [DIAL] to select the desired channel.
 - Call channels (C1, C2) and VFO (VF), as well as regular memory channels, can be programmed in this way.
 - Rotate [DIAL] while pushing [FUNC] to select the memory channel in 10 channel step.
- ⑤ Push [FUNC] + [V/M] for 2 sec. to program.

[EXAMPLE]: Memory programming of ch 40 during selection.

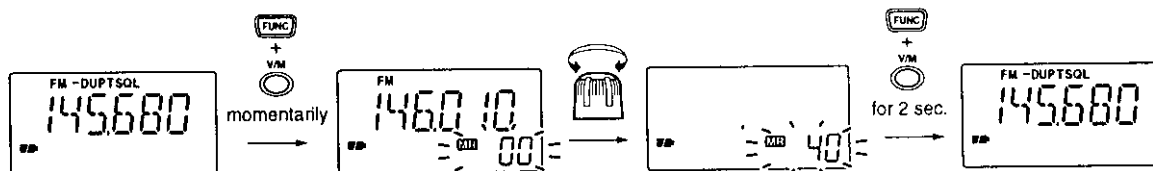

MEMORY/CALL CHANNELS 5

■ Programming after selection

- ① Select memory mode with [V/M].
- ② Set the memory channel to be programmed with [DIAL].
 - Rotate [DIAL] while pushing [FUNC] to select the memory channel in 10 channel step.
- ③ Push [V/M] to select VFO mode.
- ④ Set the desired frequency:
 - ➔ Select the desired band with [BAND].
 - ➔ Set the frequency using [DIAL].
 - ➔ Set other data (e.g. offset frequency, duplex direction, subaudible tone frequency, etc.), if required.
- ⑤ Push [FUNC] + [V/M] for 2 sec. to program into the selected channel.

■ Transferring memory contents to another

- ① Select memory mode with [V/M].
- ② Set the desired memory channel with [DIAL].
 - Rotate [DIAL] while pushing [FUNC] to select the memory channel in 10 channel step.
 - Call channel contents can be transferred in the same manor. Select a call channel in this case.
- ③ Push [FUNC] + [V/M] momentarily to indicate memory channels.
 - Do not hold [FUNC] + [V/M] for more than 0.5 sec., otherwise the memory channel contents will be transferred to VFO.
- ④ Rotate [DIAL] to select the desired channel.
 - Call channels (C1, C2) and VFO (VF), as well as regular memory channels, can be transferred in this way.
- ⑤ Push [FUNC] + [V/M] for 2 sec. to transfer.

[EXAMPLE]: Transferring memory channel 3 to 20.

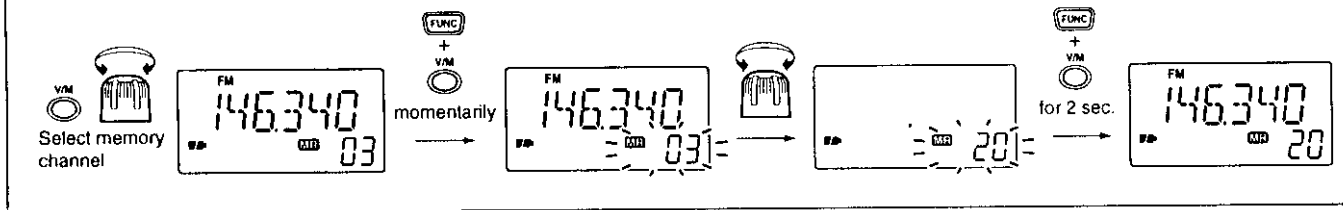

5 MEMORY/CALL CHANNELS

■ Memory clear

Unwanted memory channels can be cleared (erased). Before clearing a memory channel make sure it is no longer needed as cleared memories cannot be recalled.

- ① Select memory mode with [V/M].
- ② Set the memory channel to be cleared with [DIAL].
 - Rotate [DIAL] while pushing [FUNC] to select the memory channel in 10 channel step.
 - Call channels C1 and C2 and VFO (VF) cannot be cleared.
- ③ Select VFO mode with [V/M] and push [FUNC] + [V/M] momentarily to indicate the selected memory channels.
 - Do not hold [FUNC] + [V/M] for more than 0.5 sec., otherwise the memory channel contents will be transferred to VFO.
- ④ Push [FUNC] + [CALL] for 2 sec. to clear the selected memory channel.
 - 3 beeps sound, then the frequency is cleared.
- ⑤ Push [V/M] to return to VFO mode.

■ Call channel

2 call channels are available to store most-often-used frequency for quick recall.

◇ Selecting a call channel

- ① Push [CALL] to select a call channel.
- ② Rotate [DIAL] counterclockwise or clockwise to select call channel 1 or 2, respectively.
- ③ Push [V/M] to return to VFO mode.

◇ Programming a call channel

The call channels can be programmed with similar manor of memory channel programming.

- ➔ Select C1 or C2 for programming channel 1 or 2 at step ④ in "Programming during selection." (p. 12)

[EXAMPLE]: Clearing memory channel 3.

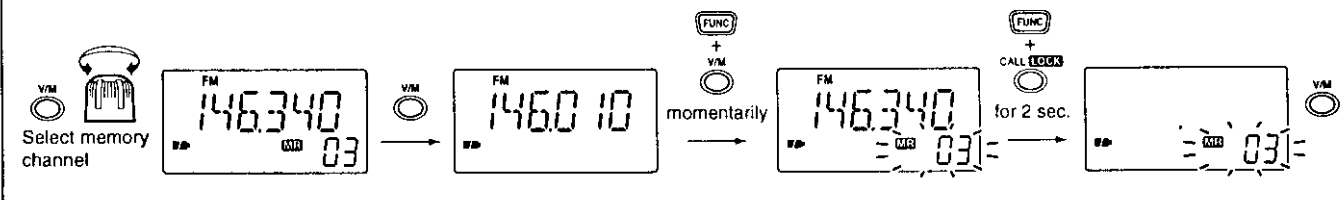

SCAN OPERATION

6

Scan types

Up to 20 range programmed scan, full scan, band scan and memory bank scan provide scanning versatility. Each scan has skip functions.

FULL SCAN (p. 16) Repeatedly scans all frequencies over the entire band.

U.S.A. version cannot receive some frequencies.

SELECTED BAND SCAN (p. 16) Repeatedly scans all frequencies over the entire selected band.

PROGRAMMED SCAN (p. 16) Repeatedly scans between two user-programmed frequencies. Used for checking for frequencies within a specified range such as repeater output frequencies, etc.

MEMORY SKIP SCAN (p. 16) Repeatedly scans all memory channels except skip channels.

MEMORY BANK SCAN (p. 16) Repeatedly scans memory channels except skip channels within memory bank 0 (memory channels 0-99) or memory bank 1 (memory channels 100-199).

FREQUENCY SKIP FUNCTION (p. 19) Skips unwanted frequencies that inconveniently stop scanning. This function can be turned ON and OFF in expanded set mode.

6 SCAN OPERATION

■ Full/band/programmed scan

- ① Select VFO mode with [V/M].
- ② Make sure the squelch is set to the threshold point.
 - Select automatic squelch (AUTO) or a level (1–9) where the noise is muted. (p. 10)
- ③ Select the desired scan range, if desired.
 - Select scan edges in set mode:
 - “ALL” for full scan, “BAND” for band scan or “0P”–“19P” for programmed scan. (see the next page)
- ④ Push [FUNC] + [▲] or [▼] momentarily to start the scan.
 - Decimal point flashes while scanning.
 - “P SKIP” flashes when the frequency skip function is turned ON. (p. 19)
 - “0P” – “19P” flash to indicate which pair of scan edges is being scanned.
 - To change the scanning direction, rotate [DIAL].
 - If the pocket beep function is activated, the transceiver automatically selects the tone squelch function when a scan starts.
- ⑤ To stop the scan, push [FUNC] + [▲] or [▼] again.

/// If the same frequencies are programmed into a pair of scan edges, the programmed scan does not start.

/// For programmed scan, scan edges must be programmed in advance. Program scan edges into regular memory channels and set the channels as a scan edge.

■ Memory (bank) scan

- ① Select memory mode with [V/M].
- ② Make sure the squelch is set to the threshold point.
 - Select automatic squelch (AUTO) or a level (1–9) where the noise is muted. (p. 10)
- ③ Select the desired memory bank in set mode, if desired.
 - See below for details.
- ④ Push [FUNC] + [▲] or [▼] momentarily to start the memory scan or memory bank scan.
 - Decimal point flashes while scanning.
 - “♦” flashes while memory bank scan.
 - To change the scanning direction, rotate [DIAL].
 - If the pocket beep function is activated, the transceiver automatically selects the tone squelch function when a scan starts.
- ⑤ To stop the scan, push [FUNC] + [▲] or [▼] again.

◇ Memory bank selection

- ① Push [V/M] for 2 sec. to enter set mode.
- ② Rotate [DIAL] until “BNK SC” appears.
- ③ While pushing [FUNC], rotate [DIAL] to select the desired memory bank.
 - “OFF” for all memory scan, “BANK0” for memory scan within memory channel 0 to 99 or “BANK1” for memory scan within memory channel 100 to 199.
- ④ Push [V/M] to exit set mode.



Memory bank 0
(Memory ch 0 to 99)

SCAN OPERATION 6

■ Selecting scan edges

The scanning range can be set from all frequency (full scan), selected band or two user-programmed frequencies (programmed scan).

▨ The programmed scan edges use regular memory channels. Program the desired scan edge frequencies in memory channels in advance. (pgs. 12, 13)

- ① Select VFO mode with [V/M].
- ② Push [V/M] for 2 sec. to enter set mode.
- ③ Rotate [DIAL] until "EDGE" appears.
 - "EDGE" disappears after 1 sec. and the previously selected scan edge appears.
- ④ While pushing [FUNC], rotate [DIAL] to select the desired scan edge.
 - Select "ALL" for full scan, "BAND" for band scan or "0P"-"19P" for programmed scan.
- ⑤ When full or band scan is selected, push [V/M] to exit set mode.

When a programmed scan is selected, proceed the following steps to select the band edge frequency.

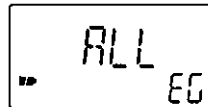

Full scan

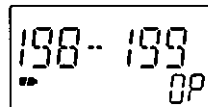
Programmed scan 0
(Scan edge channel
198 and 199)

- ⑥ Push [FUNC] + [▲] to select left-hand scan edge channel.
- ⑦ While pushing [FUNC], rotate [DIAL] to select the desired memory channel which stores a scan edge frequency.
 - The frequency in the memory channel is displayed for 1 sec.
- ⑧ Push [FUNC] + [▲] to select right-hand scan edge channel.
- ⑨ While pushing [FUNC], rotate [DIAL] to select the desired memory channel which stores another scan edge frequency.
- ⑩ Push [V/M] to exit set mode.
 - Push [FUNC] + [▲] to indicate programmed scan edge for programming other scan edges. Repeat ④, ⑥ - ⑨.

Memory channel
frequency is displayed
while selection.

6 SCAN OPERATION

■ Skip channel setting

Memory channels can be set to be skipped for memory skip scan. In addition, memory channels can be set to be skipped for both memory skip scan and frequency skip scan. These are useful to speedup the scan interval.

- ① Select memory mode with [V/M].
- ② Rotate [DIAL] to select memory channel be programmed as a skip channel.
- ③ Push [V/M] for 2 sec. to enter expanded set mode.
- ④ Rotate [DIAL] until "SKIP" appears.
 - Turn the expanded set mode ON for selection. (p. 28)
 - "SKIP" disappears after 1 sec. and "Sk" appears.
- ⑤ While pushing [FUNC], rotate [DIAL] to select condition.
 - "OFF" for non-skip channel, "SKIP" for memory skip scan or "P SKIP" for frequency skip scan and memory skip scan.
- ⑥ Push [V/M] to exit set mode.

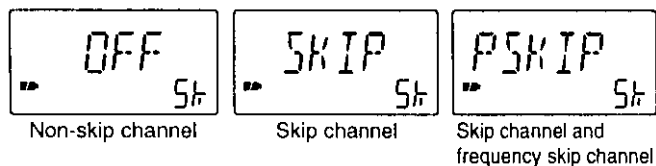

▨ This setting is effective when the frequency skip function (P SCAN) is turned ON. See the next page for details.

■ Scan resume condition

◇ Setting the scan pause time

The scan stops according to the scan pause time. It can be selected as a pause or timer scan (2–20 sec.).

- ① Push [V/M] for 2 sec. to enter expanded set mode.
- ② Rotate [DIAL] until "PAUSE" appears.
 - Turn the expanded set mode ON for selection. (p. 28)
- ③ While pushing [FUNC], rotate [DIAL] to select condition.
 - "2SEC"–"20SEC": scan pauses for 2–20 sec. on a received signal.
 - "HOLD": scan pauses on a received signal until it disappears.
- ④ Push [V/M] to exit set mode.

◇ Setting the scan resume time

The scan restarts according to the resume time. It can be selected to 0–5 sec.

- ① Push [V/M] for 2 sec. to enter expanded set mode.
- ② Rotate [DIAL] until "RESUME" appears.
 - Turn the expanded set mode ON for selection. (p. 28)
- ③ While pushing [FUNC], rotate [DIAL] to select condition.
 - "1SEC"–"5SEC": scan restarts 1–5 sec. after the signal disappears.
 - "0SEC": scan restarts immediately when the signal disappears.
- ④ Push [V/M] to exit set mode.

Frequency skip function

Programming a skip frequency

Unwanted frequencies can be skipped and programmed as skip channels when full scan, band scan or programmed scan is pausing.

- ① Turn ON the frequency skip function as described at right.
- ② Start full scan, band scan or programmed scan. (p. 16)
- ③ While receiving an unwanted signal and scan pauses, push [FUNC] + [V/M] for 2 sec. to program the received frequency as a skip frequency.

- The transceiver emits 3 beeps and the scan resumes.
- Non-programmed memory channels (blank channels) are used for skip frequency programming in reverse sequence.
- Do not release [V/M] before 2 sec., otherwise, scan stops and the transceiver enters memory programming condition.
- To scan the skip frequency after programming, cancel the skip information (p. 18) or clear the memory channel (p. 14).

When the frequency skip function is turned OFF ("P SKIP" does not flash), the paused frequency is overwritten on the previously selected memory channel.

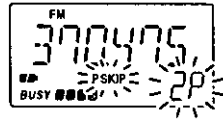

Indication while pausing



Indication while programming

Frequency skip function ON/OFF

The frequency skip function can be turned OFF in expanded set mode. In this case, the frequencies will not be skipped even if skip information is programmed and "P SKIP" will not blink during full scan, band scan or programmed scan.

- ① Select VFO mode with [V/M].
- ② Push [V/M] for 2 sec. to enter expanded set mode.
- ③ Rotate [DIAL] until "P SCAN" appears.
 - Turn the expanded set mode ON for selection. (p. 28)
 - "P SCAN" disappears after 1 sec. and "SC" appears.
- ④ While pushing [FUNC], rotate [DIAL] to turn the frequency skip function ON or OFF.
- ⑤ Push [V/M] to exit set mode.

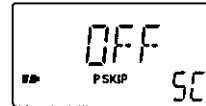

The frequency skip function is OFF.



The frequency skip function is ON.

7

PRIORITY WATCH

■ Priority watch types

Priority watch checks for signals on a frequency every 5 sec. while operating on a VFO frequency or scanning. The transceiver has 3 priority watch types to suit your needs.

In addition, you can have an alert with a beep and "▲" flashing.

The watch resumes according to the selected scan resume condition. See p. 18 for details.

/// If the pocket beep function is activated, the transceiver automatically selects the tone squelch function when priority watch starts.

MEMORY or CALL CHANNEL WATCH

5 sec. 125 msec.

VFO frequency Memory or call channel

While operating on a VFO frequency, priority watch checks for a signal on the selected memory or call channel every 5 sec.

- A memory channel with skip information can be watched.

MEMORY SCAN WATCH

5 sec. 125 msec.

VFO frequency SKIP Mch 0 Mch 1 Mch 2 Mch 199

While operating on a VFO frequency, priority watch checks for signals on each memory channel in sequence.

- The memory skip function is useful to speed up the scan.

VFO SCAN WATCH

5 sec. 125 msec.

VFO scanning Memory channel

While scanning in VFO mode, priority watch checks for signals on the selected memory or call channel every 5 sec.

■ Priority watch operation

◇ Memory/call channel watch and memory scan watch

- ① Select VFO mode; then, set an operating frequency.
- ② Set the watching channel(s).

For memory channel watch:

Select the desired memory channel.

For memory scan watch:

Select memory mode; then, push [FUNC] + [▲] or [▼] momentarily to start memory scan.

For call channel watch:

Select the call channel by pushing [CALL].

- ③ Push [V/M] for 2 sec. to enter set mode.
- ④ Rotate [DIAL] until "PRIO" appears.
 - "PRIO" disappears after 1 sec. and "OFF" and "PR" appear.
- ⑤ While pushing [FUNC], rotate [DIAL] to select the priority watch ON or priority watch ON with alert.
- ⑥ Push [V/M] to exit set mode and start the watch.
 - The transceiver checks the memory or call channel frequency every 5 sec.
 - The watch resumes according to the selected scan resume condition. (p. 18)
- ⑦ Push [V/M] while the display shows the VFO frequency to stop the watch.



While pausing on the memory or call channel "PRIO" flashes.

◇ VFO scan watch

- ① Select the desired memory channel to be watched.
- ② Push [V/M] to select VFO mode.
- ③ Push [FUNC] + [▲] or [▼] momentarily to start full scan, band scan or programmed scan. (p. 16)
- ④ Push [V/M] for 2 sec. to enter set mode.
- ⑤ Rotate [DIAL] until "PRIO" appears.
 - "PRIO" disappears after 1 sec. and "OFF" and "PR" appear.
- ⑥ While pushing [FUNC], rotate [DIAL] to select the priority watch ON or priority watch ON with alert.
- ⑦ Push [V/M] to exit set mode and start the watch.
 - The transceiver checks the memory channel frequency every 5 sec.
 - The watch resumes according to the selected scan resume condition. (p. 18)
- ⑧ Push [V/M] while the display shows the VFO frequency to stop the watch.

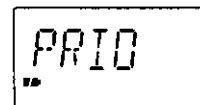

Priority watch set mode



Priority watch is ON.

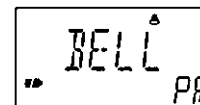

Priority watch with alert is ON.

8

REPEATER OPERATION

■ General

When using a repeater, the transmit frequency is shifted from the receive frequency by the offset frequency. (p. 24) It is convenient to program repeater information into memory channels. (p. 12)

- ① Set the receive frequency (repeater output frequency).
- ② Set the shift direction of the transmit frequency. (-DUP or DUP; see the next section for details.)
 - When the auto repeater function is in use (U.S.A. version only), this selection and step ③ are not necessary. (p. 25)
- ③ Activate the subaudible tone encoder, according to repeater requirements.
 - Refer to the next page for tone frequency settings.
- ④ Push and hold [PTT] to transmit.
 - The displayed frequency automatically changes to the transmit frequency (repeater input frequency).
 - If "OFF" appears, check the offset frequency (p. 24) or shift direction (right section).
- ⑤ Release [PTT] to receive.
- ⑥ Push and hold [SQL] to check whether the other station's transmit signal can be directly received or not.

◇ Setting duplex and duplex direction

- ① Push [V/M] for 2 sec. to enter expanded set mode.
- ② Rotate [DIAL] until "DUP" appears.
 - Turn the expanded set mode ON for selection. (p. 28)
 - "DUP" disappears after 1 sec. and "dP" appears.
- ③ While pushing [FUNC], rotate [DIAL] to select "-DUP" or "+DUP":
 - "-DUP" or "+DUP" indicates the transmit frequency for minus shift or plus shift, respectively.
 - When the auto repeater function is in use (U.S.A. version only), this selection and step ③ are not necessary. (p. 25)
- ④ Push [V/M] to exit set mode.

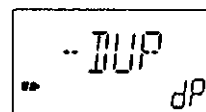

Minus shift

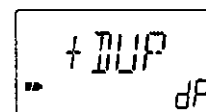

Plus shift

▷ CONVENIENT

Tone scan function: When you don't know the subaudible tone used for a repeater, the tone scan is convenient for detecting the tone frequency.

➔ Push [FUNC] + [▲] or [▼] for 2 sec. to activate. See p. 27 for more information.

■ Subaudible (repeater) tones

Some repeaters require subaudible tones to be accessed. Subaudible tones are superimposed over your normal signal and must be set in advance.

Each operating band and each memory channel have independent settings.

◇ Turning the subaudible tone encoder on/off

- ① Push [V/M] for 2 sec. to enter set mode.
- ② Rotate [DIAL] until "T/TSQ" appears.
 - "T/SQL" disappears after 1 sec. and "TO" appear.
- ③ While pushing [FUNC], rotate [DIAL] to select "TONE."
- ④ Push [V/M] to exit set mode.
 - "T" appears above the frequency readout when the subaudible tone encoder is turned ON.

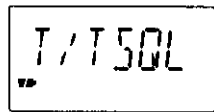

Tone function set mode

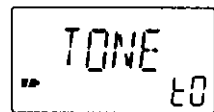

Tone encoder is ON.

◇ Setting the subaudible tone frequency

- ① Select VFO mode or desired memory channel to be programmed.
- ② Push [V/M] for 2 sec. to enter set mode.
- ③ Rotate [DIAL] until "R TONE" (repeater tone) appears.
 - "R TONE" disappears after 1 sec. and "Rt" appears.
- ④ While pushing [FUNC], rotate [DIAL] to select the desired subaudible tone.
 - Each operating band and each memory channel have independent settings.
- ⑤ Push [V/M] to exit set mode.

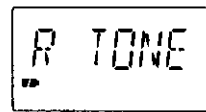

Repeater tone set mode

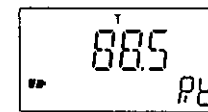

88.5 Hz tone

• Available subaudible tone frequencies (unit: Hz)

67.0	82.5	100.0	123.0	151.4	171.3	189.9	210.7	250.3
69.3	85.4	103.5	127.3	156.7	173.8	192.8	218.1	254.1
71.9	88.5	107.2	131.8	159.8	177.3	196.6	225.7	
74.4	91.5	110.9	136.5	162.2	179.9	199.5	229.1	
77.0	94.8	114.8	141.3	165.5	183.5	203.5	233.6	
79.7	97.4	118.8	146.2	167.9	186.2	206.5	241.8	

8 REPEATER OPERATION

■ 1750 Hz tone

(Europe and Italy versions only)

Some European repeaters require a 1750 Hz tone to be accessed. For such European repeaters, perform the following.

- ① Set the receive frequency (repeater output frequency).
- ② Set the shift direction of the transmit frequency. (-DUP or DUP; see p. 22 for details.)
- ③ While pushing [PTT], push and hold [CALL] for 1 to 2 sec. to transmit a 1750 Hz tone burst signal.
 - Pushing [PTT] 2 times quickly also transmits a 1750 Hz tone. Release [PTT] briefly, then push [PTT] again to talk in this case.
 - If "OFF" appears, check the offset frequency (right section) or shift direction (p. 22).
 - The displayed frequency automatically changes to the transmit frequency (repeater input frequency).
- ④ Push and hold [PTT] to transmit.
- ⑤ Release [PTT] to receive.
- ⑥ Push and hold [SQL] to check whether the other station's transmit signal can be directly received or not.

■ Offset frequency

When communicating through a repeater, the transmit frequency is shifted from the receive frequency by an amount determined by the offset frequency.

- ① Select VFO mode or desired memory channel to be programmed.
- ② Push [V/M] for 2 sec. to enter expanded set mode.
- ③ Rotate [DIAL] until "OFFSET" appears.
 - Turn the expanded set mode ON for selection. (p. 28)
 - "OFFSET" disappears after 1 sec. and "OW" appears.
- ④ While pushing [FUNC], rotate [DIAL] to set the desired offset.
- ⑤ Push [V/M] to exit set mode.

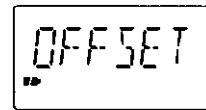

Offset frequency set mode



0.6 MHz (600 kHz) offset

■ Auto repeater function

(U.S.A. version only)

The U.S.A. version automatically activates the repeater settings (duplex ON/OFF, duplex direction, tone encoder ON/OFF) when the operating frequency falls within or outside of the general repeater output frequency range. The offset and repeater tone frequencies are not changed by the auto repeater function, reset these frequencies, if necessary.

- ① Select VFO mode with [V/M].
- ② Push [V/M] for 2 sec. to enter expanded set mode.
- ③ Rotate [DIAL] until "AUTORP" appears.
 - Turn the expanded set mode ON for selection. (p. 28)
 - "AUTORP" disappears after 1 sec. and "AR" appears.
- ④ While pushing [FUNC], rotate [DIAL] to turn the auto repeater function ON (DUP ONLY or DUP TONE) or OFF.
- ⑤ Push [V/M] to exit set mode.

◇ Frequency range and offset direction

FREQUENCY RANGE	DUPLEX DIRECTION
145.200–145.495 MHz 146.610–146.995 MHz	"-DUP" appears
147.000–147.395 MHz	"DUP" appears
442.000–444.995 MHz	"DUP" appears
447.000–449.995 MHz	"-DUP" appears

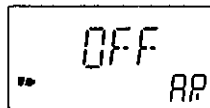

Auto repeater function is turned OFF.

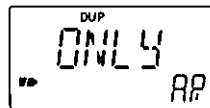

Activates for duplex only.

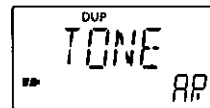

Activates for duplex and tone.

9

SUBAUDIBLE TONE OPERATION

■ Tone squelch operation

◇ Operation

The tone squelch opens only when receiving a signal containing a matching subaudible tone. You can silently wait for calls from group members using the same tone.

- ① Set the operating frequency.
- ② Set the desired CTCSS tone in set mode.
 - See right for programming.
- ③ Push [V/M] for 2 sec. to enter set mode.
- ④ Rotate [DIAL] until "T/TSQL" appears.
 - "T/SQL" disappears after 1 sec. and "tO" appear.
- ⑤ While pushing [FUNC], rotate [DIAL] to select "TSQL."
- ⑥ Push [V/M] to exit set mode and start the tone squelch.
- ⑦ When the received signal includes a matching tone, squelch opens and the signal can be heard.
 - When the received signal's tone does not match, tone squelch does not open, however, the S-indicator shows signal strength.
 - To open the squelch manually, push and hold [SQL].
- ⑧ Operate the transceiver in the normal way.
- ⑨ To cancel the tone squelch, repeat step ③–⑥ as described above and select "OFF" in step ⑤.

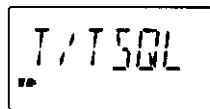

Tone function set mode

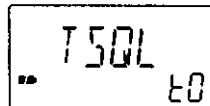

Tone squelch is ON.

▷ CONVENIENT

Store subaudible tone frequencies and tone squelch ON/OFF settings in memories (call) for easy recall.

◇ Setting subaudible tones for tone squelch operation (CTCSS tones)

Separate tone frequencies can be set for tone squelch operation than for repeater operation (the same range of tones is available—see p. 23). Like repeater tones, these are set in set mode.

- ① Select VFO mode or desired memory channel to be programmed.
- ② Push [V/M] for 2 sec. to enter set mode.
- ③ Rotate [DIAL] until "C TONE" (CTCSS tone) appears.
 - "C TONE" disappears after 1 sec. and "Ct" appears.
- ④ While pushing [FUNC], rotate [DIAL] to select the desired CTCSS tone.
 - Each operating band and each memory channel have independent settings.
- ⑤ Push [V/M] to exit set mode.

/// The transceiver has 50 tone frequencies and consequently their spacing is narrow compared with units having 38 tones. Therefore, some tone frequencies may receive interference from adjacent tone frequencies.

SUBAUDIBLE TONE OPERATION 9

■ Pocket beep operation

This function uses subaudible tones for calling and can be used as a “common pager” to inform you that someone has called while you were away from the transceiver.

◇ Waiting for a call from a specific station

- ① Set the operating frequency.
- ② Set the desired CTCSS tone in set mode.
 - See the previous page for programming information.
- ③ Push [V/M] for 2 sec. to enter set mode.
- ④ Rotate [DIAL] until “T/TSQL” appears.
 - “T/SQL” disappears after 1 sec. and “tO” appear.
- ⑤ While pushing [FUNC], rotate [DIAL] to select “P BEEP.”
- ⑥ Push [V/M] to exit set mode and start the pocket beep.
 - “TSQL 📞” appears in the function display.
- ⑦ When a signal with the correct tone is received, the transceiver emits beep tones for 30 sec. and flashes “📞.”
- ⑧ Push [PTT] to answer or push [V/M] to stop the beeps and flashing.
 - Tone squelch is automatically selected.

◇ Calling a waiting station using pocket beep

A subaudible tone matched with the station’s tone frequency is necessary. Use the tone squelch on the previous page or a subaudible tone encoder.

■ Tone scan

The transceiver can detect the subaudible tone frequency in a received signal. By monitoring a signal that is being transmitted on a repeater input frequency, you can determine the tone frequency required to access the repeater.

- ① Set the desired frequency or memory channel to be checked for a tone frequency.
- ② Push [FUNC] + [▲] or [▼] for 2 sec. to start the tone scan.
 - To change the scanning direction, rotate [DIAL].
- ③ When the tone frequency is decoded, the set mode contents are programmed with the tone frequency.
 - The tone scan pauses when a tone frequency is detected.
 - The decoded tone frequency is used for the repeater tone frequency or tone squelch frequency, depending on the the tone squelch ON/OFF setting.
 - “Ct” or “Rt” appears during tone scan when the tone squelch is in use or not.
- ④ Push [FUNC] + [▲] or [▼] to stop the scan.

Subaudible tone frequencies flash as they are scanned.

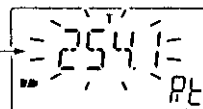

“Rt” or “Ct” appears during tone scan.

10 OTHER FUNCTIONS

■ Set mode

Set mode is used for programming infrequently changed values or conditions of functions.

In addition, this transceiver has an expanded set mode which is used for programming more infrequently changed values or conditions of functions. When turning OFF the expanded set mode, half of set mode contents are not displayed and you can use set mode simpler.

◇ Expanded set mode ON/OFF

- ① Push [V/M] for 2 sec. to enter set mode.
- ② Rotate [DIAL] until "EXPAND" appears.
• "EXPAND" disappears after 1 sec. and "EX" appears.
- ③ While pushing [FUNC], rotate [DIAL] to turn the expanded set mode ON or OFF.
- ④ Rotate [DIAL] to select the desired set mode contents.
- ⑤ While pushing [FUNC], rotate [DIAL] to select the set mode contents.
- ⑥ Push [V/M] to exit set mode.



Expanded set mode setting

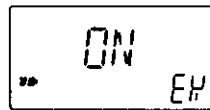

Expanded set mode ON

◇ Set mode contents

STEP	Tuning step (p. 7)	SKIP	Skip channel (p. 18)
D SEL	Dial select step (p. 29)	BNK SC	Memory bank (p. 16)
T/TSQL	Tone function (pgs. 23, 26)	PRIO	Priority watch (p. 21)
R TONE	Repeater tone (p. 23)	BEEP	Confirmation beep (p. 29)
C TONE	CTCSS tone (p. 26)	LIGHT	Backlighting (p. 11)
AUTORP	Auto repeater* (p. 25)	AP OFF	Auto power OFF (p. 30)
DUP	Duplex direction (p. 22)	P SAVE	Power save (p. 29)
OFFSET	Offset frequency (p. 24)	MONI	Monitor switch function (p. 30)
MOD	Receive mode (p. 11)	SPEED	Dial speed (p. 31)
RESUME	Scan resume time (p. 18)	LOCK	Lock function effect (p. 31)
PAUSE	Scan pause time (p. 18)	CH	Channel indication mode (p. 32)
EDGE	Scan edge (p. 17)	EXPAND	Expanded set mode (p. 28)
P SCAN	Frequency skip function (p. 19)		

* U.S.A. version only

: Appears when expanded set mode is ON.

: Appears VFO mode only.

: Appears memory mode only.

■ Dial select step

This transceiver has a 1 MHz tuning step for quick frequency setting. This dial select step can be set to 100 kHz, 1 MHz or 10 MHz steps, if desired.

◇ Setting dial select step

- ① Select VFO mode with [V/M].
- ② Push [V/M] for 2 sec. to enter set mode.
- ③ Rotate [DIAL] until "D SEL" appears.
 - "D SEL" disappears after 1 sec. and "dS" appears.
- ④ While pushing [FUNC], rotate [DIAL] to select the desired dial select step.
 - 100 kHz, 1 MHz and 10 MHz steps can be selected.
- ⑤ Push [V/M] to exit set mode.

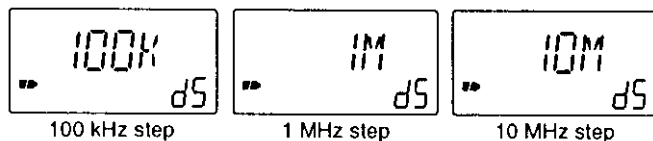

■ Beep tones

The confirmation beep tones, which sound each time a switch is pushed, can be turned ON or OFF, as desired.

- ① Push [V/M] for 2 sec. to enter set mode.
- ② Rotate [DIAL] until "BEEP" appears.
 - "BEEP" disappears after 1 sec. and "bE" appears.
- ③ While pushing [FUNC], rotate [DIAL] to turn the confirmation beep ON or OFF.
- ④ Push [V/M] to exit set mode.

■ Power saver

The power saver function reduces the current drain to conserve battery power.

- ① Push [V/M] for 2 sec. to enter expanded set mode.
- ② Rotate [DIAL] until "P SAVE" appears.
 - Turn the expanded set mode ON for selection. (p. 28)
 - "P SAVE" disappears after 1 sec. and "PS" appears.
- ③ While pushing [FUNC], rotate [DIAL] to turn the power saver ON (AUTO) or OFF.
- ④ Push [V/M] to exit set mode.

▨ For packet operation, the power saver should be turned OFF to receive reliable packet data.

10 OTHER FUNCTIONS

■ Auto power-off function

The transceiver can be set to automatically turn OFF after a specified period in which no switch is pushed.

120 min., 90 min., 60 min., 30 min. and OFF can be specified. The specified period is retained even when the transceiver is turned OFF by the auto power-off function. To cancel the function, select "OFF" in step ③ below.

- ① Push [V/M] for 2 sec. to enter expanded set mode.
- ② Rotate [DIAL] until "AP OFF" appears.
 - Turn the expanded set mode ON for selection. (p. 28)
 - "AP OFF" disappears after 1 sec. and "AO" appears.
- ③ While pushing [FUNC], rotate [DIAL] to select the desired time or to turn the function OFF.
- ④ Push [V/M] to exit set mode.

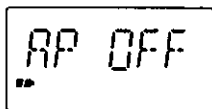

Auto power off set mode

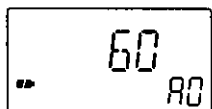

60 min. auto power-off

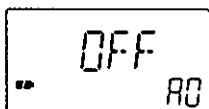

Auto power-off is turned OFF.

■ Monitor switch function

The monitor switch can be set as condition holding type switch. When the condition holding type switch is selected, each push of the [SQL] switch toggles the monitor function on and off.

- ① Push [V/M] for 2 sec. to enter expanded set mode.
- ② Rotate [DIAL] until "MONI" appears.
 - Turn the expanded set mode ON for selection. (p. 28)
 - "MONI" disappears after 1 sec. and "mO" appears.
- ③ While pushing [FUNC], rotate [DIAL] to set the monitor switch as condition holding type switch (HOLD) or not (PUSH).
- ④ Push [V/M] to exit set mode.



Monitor switch function set mode

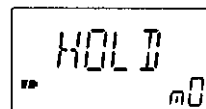

Holding type monitor switch

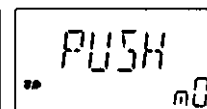

Push type monitor switch

■ Dial speed acceleration

The dial speed acceleration automatically speeds up the tuning dial speed when rotating the [DIAL] rapidly.

- ① Push [V/M] for 2 sec. to enter expanded set mode.
- ② Rotate [DIAL] until "SPEED" appears.
 - Turn the expanded set mode ON for selection. (p. 28)
 - "SPEED" disappears after 1 sec. and "SP" appears.
- ③ While pushing [FUNC], rotate [DIAL] to set the dial speed acceleration ON or OFF.
- ④ Push [V/M] to exit set mode.

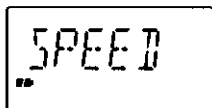

Dial speed acceleration set mode



Dial speed acceleration ON

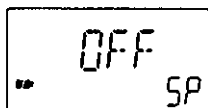

Dial speed acceleration OFF

■ Lock function effect

The lock function prevents accidental frequency changes and accidental function access.

While the lock function is ON, [POWER], [VOL], [SQL] and [PTT] can still be accessed. These accessible switches can be set from 4 types in expanded set mode.

- ① Push [V/M] for 2 sec. to enter expanded set mode.
- ② Rotate [DIAL] until "LOCK" appears.
 - Turn the expanded set mode ON for selection. (p. 28)
 - "LOCK" disappears after 1 sec. and "Lk" appears.
- ③ While pushing [FUNC], rotate [DIAL] to select the accessible switches.
 - "NORMAL" : [POWER], [VOL], [SQL] and [PTT] are accessible.
 - "NO SQL" : [POWER], [SQL] and [PTT] are accessible.
 - "NO VOL" : [POWER], [VOL] and [PTT] are accessible.
 - "ALL" : [POWER] and [PTT] are accessible.
- ④ Push [V/M] to exit set mode.



Lock function effect set mode



[POWER], [VOL], [SQL] and [PTT] are accessible.

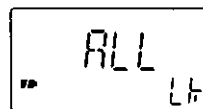

[POWER] and [PTT] are accessible.

10 OTHER FUNCTIONS

■ Channel indication mode

Channel indication mode is used to simplify operation. In this mode only pre-programmed memory channel numbers are displayed and functions are limited ([POWER], [PTT], [SQL], [VOL], [LOCK], scanning and the tuning dial are functional).

- ① Select memory mode with [V/M].
- ② Push [V/M] for 2 sec. to enter expanded set mode.
- ③ Rotate [DIAL] until "CH" appears.
 - Turn the expanded set mode ON for selection. (p. 28)
- ④ While pushing [FUNC], rotate [DIAL] to turn the channel indication ON or OFF.
- ⑤ Push [V/M] to exit set mode.

- To return to normal indication, turn this function OFF in step ④ above.
- Frequencies must be programmed into memory channels in advance.

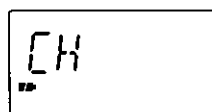

Channel indication mode set mode

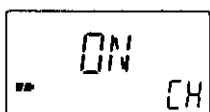

Channel indication mode ON

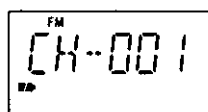

Channel indication mode example

■ Partial reset

If you want to initialize the operating conditions (VFO frequency, VFO settings, set mode contents) without clearing the memory contents, a partial resetting function is available for the transceiver.

- While pushing [FUNC] and [V/M], turn power ON to partially reset the transceiver.

■ All reset

Reset the CPU before operating the transceiver for the first time, or when the internal CPU malfunctions.

- While pushing [FUNC], [BAND] and [V/M], turn power ON to reset the CPU.
 - "CLEAR" appears when resetting the CPU.

/// **CAUTION:** Resetting the CPU returns all programmed contents to their default settings.

TROUBLESHOOTING 11

If your transceiver seems to be malfunctioning, please check the following points before sending it to a service center.

PROBLEM	POSSIBLE CAUSE	SOLUTION	REF.
No power comes ON.	<ul style="list-style-type: none"> • The batteries are exhausted. • The battery polarity is reversed. 	<ul style="list-style-type: none"> • Replace the batteries. • Check the battery polarity. 	<p>p. 1</p> <p>p. 1</p>
No sound comes from the speaker.	<ul style="list-style-type: none"> • Volume level is too low. • Different tone is selected with tone squelch. 	<ul style="list-style-type: none"> • Push [VOL ▲] to a suitable level. • Check the tone using tone scan. 	<p>p. 10</p> <p>p. 27</p>
Transmitting is impossible.	<ul style="list-style-type: none"> • The batteries are exhausted. • The frequency outside 144/400 MHz amateur band is set. 	<ul style="list-style-type: none"> • Replace the batteries. • Reset the frequency inside 144/400 MHz amateur band. 	<p>p. 1</p> <p>pgs. 6, 36</p>
No contact possible with another station.	<ul style="list-style-type: none"> • Different tone is selected with tone squelch. 	<ul style="list-style-type: none"> • Check the tone using tone scan. 	<p>p. 27</p>
Frequency cannot be set.	<ul style="list-style-type: none"> • The lock function is activated. • Channel indication mode is selected. 	<ul style="list-style-type: none"> • Push [FUNC] + [(CALL)LOCK] for 2 sec. to cancel the function. • Turn the channel indication mode OFF in set mode. 	<p>p. 8</p> <p>p. 32</p>
No beeps sound.	<ul style="list-style-type: none"> • Beep tones are turned OFF. 	<ul style="list-style-type: none"> • Turn beep tones ON in set mode. 	<p>p. 29</p>
Dial select step cannot be used.	<ul style="list-style-type: none"> • RIT function is activated. 	<ul style="list-style-type: none"> • Push [FUNC] + [BAND] to cancel the function. 	<p>p. 8</p>
Receive audio is distorted.	<ul style="list-style-type: none"> • The operating mode is not selected correctly. 	<ul style="list-style-type: none"> • Select a suitable operating mode in set mode. 	<p>p. 11</p>
Desired set mode cannot be selected.	<ul style="list-style-type: none"> • The desired set mode is in expanded set mode. • Some set mode can be selected from VFO or memory mode only. 	<ul style="list-style-type: none"> • Turn the expanded set mode ON. • Enter set mode from appropriate mode. 	<p>p. 28</p> <p>p. 28</p>

12 OPERATION FLOW CHART

Displays for set and expanded set modes show the default settings except the expanded set mode setting.

Rotate [DIAL] while pushing [FUNC] to change the set mode condition.

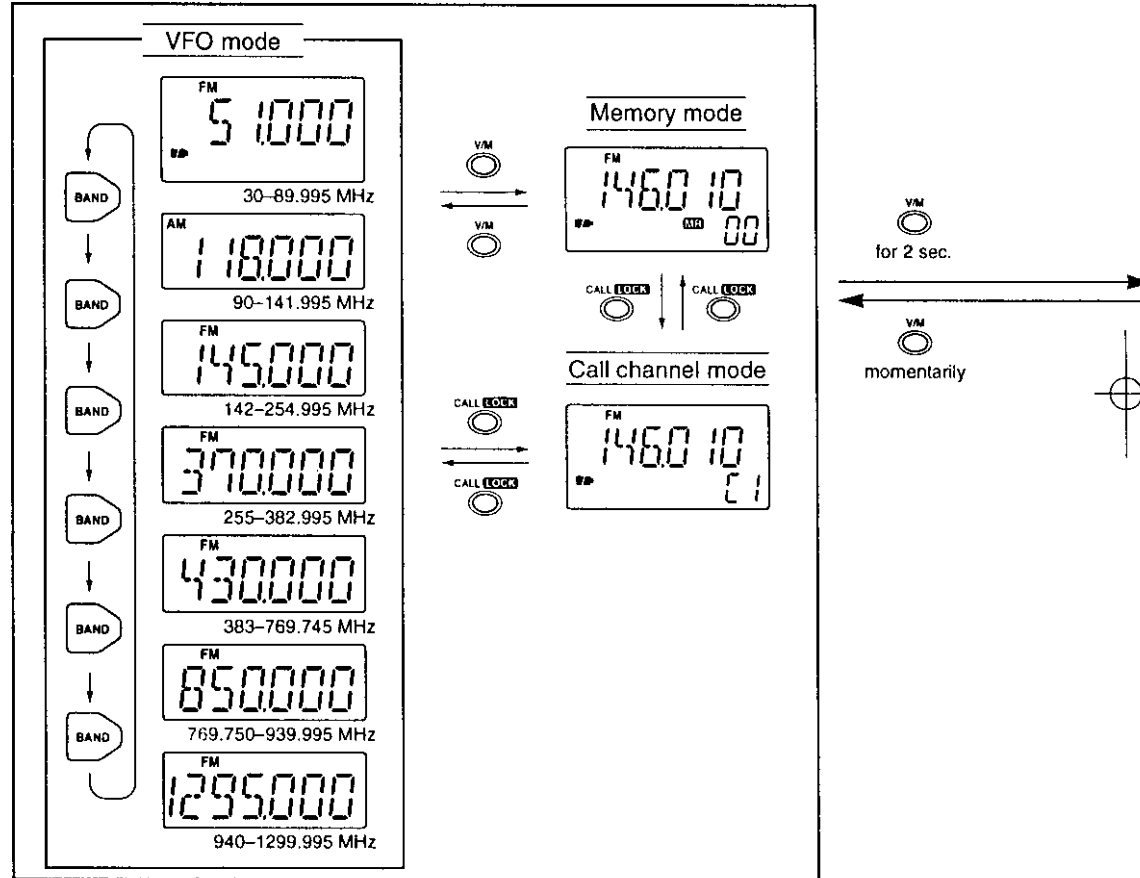

OPERATION FLOW CHART 12

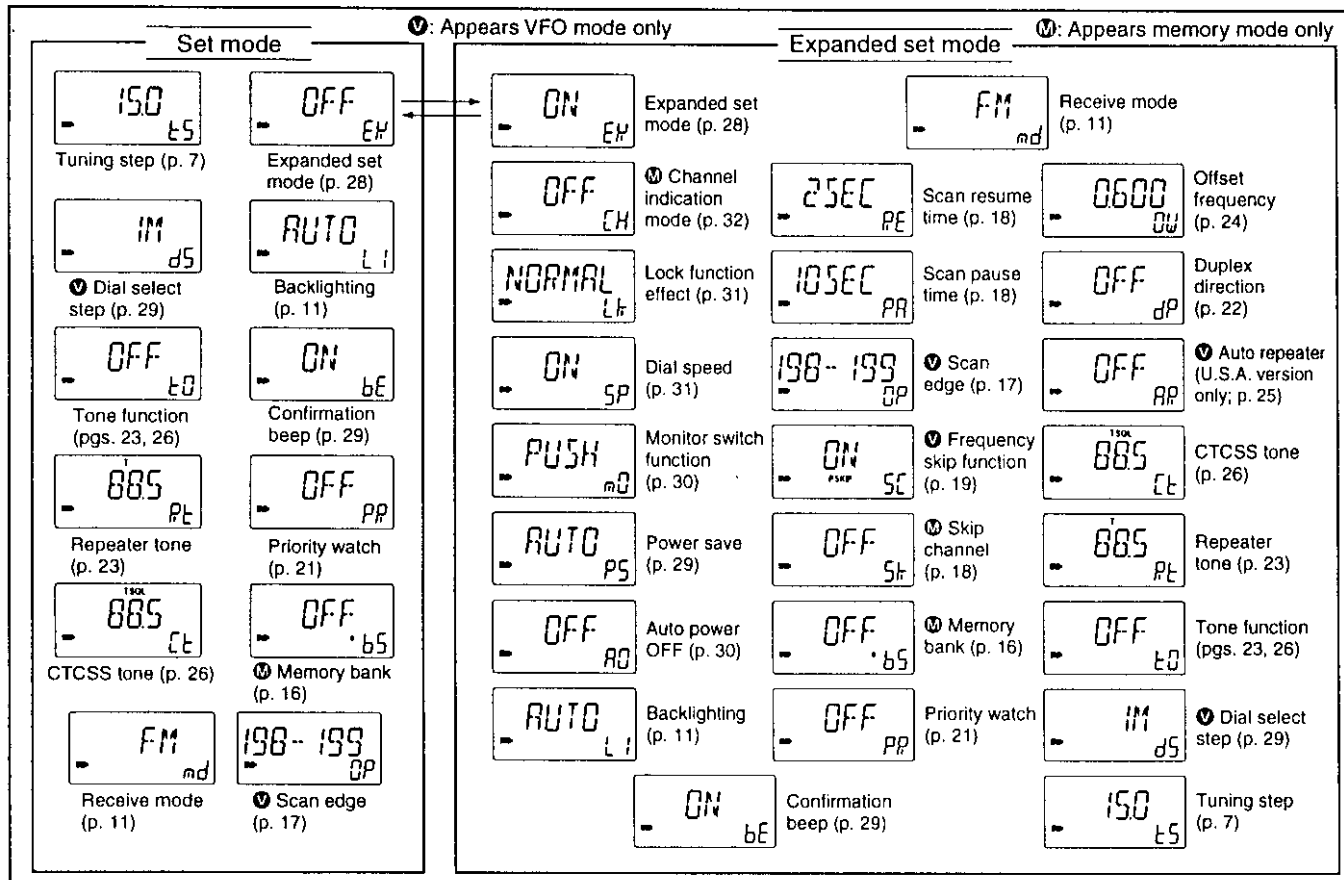

13 SPECIFICATIONS

◇ General

• Frequency coverage :		(unit: MHz)	
U.S.A.	Transmit	144-148, 440-450	
	Receive	30-823.995, 849-868.995, ^{ok} 894-1309.995*	
Europe	Transmit	144-146, 430-440	
	Receive	30-1309.995* ^{ok}	
Italy	Transmit	144-148, 430-440	
	Receive	30-1309.995* ^{ok}	
Asia	Transmit	144-148, 430-440 ^{ok}	
	Receive	30-1309.995*	
U.S.A.-1	Transmit	144-148, 440-450 ^{ok}	
	Receive	30-1309.995*	

*Specifications guaranteed 30-1300 MHz.

- Mode : FM, AM*, WFM*
*Receive only
- No. of memory channel : 200
- Usable temp. range : -10°C to +60°C;
+14°F to +140°F
- Tuning steps : 5, 6.25, 10, 12.5, 15, 20, 25,
30, 50 and 100 kHz
- Frequency stability : ±6 ppm (-10°C to +60°C)
- Power supply requirement : 2 AA(R6) Ni-Cd or alkaline
cells (negative ground)

- Current drain (VHF/UHF; at 3.0 V DC):
 - Tx max. power : 440 mA/380 mA (typical)
 - Rx rated audio : 170 mA (typical)
 - standby : 95 mA (typical)
 - power saved : 38 mA (typical)
- Antenna connector : SMA (50 Ω)
- Dimensions : 58(W)×86(H)×27(D) mm;
(projections not included) 2⁹/₃₂(W)×3³/₈(H)×1¹/₁₆(D) in
- Weight : 170 g; 6 oz
(w/antenna and battery)
- MIC/SP connector : 4-conductor 3.5 (d) mm (1/8");
2 kΩ/8 Ω

◇ Transmitter

- Modulation system : Variable reactance
- Output power : 350 mW typical (VHF)
(at 3.0 V DC) 300 mW typical (UHF)
- Spurious emissions : Less than -40 dB
- Max. frequency deviation : ±5 kHz

SPECIFICATIONS 13

◇ Receiver

• Receiver system	: Triple conversion superheterodyne	• Squelch sensitivity	: 0.18 μ V (144–148 MHz) 0.22 μ V (430–450 MHz)
• Intermediate frequency	: 1st 266.7 MHz 2nd 19.65 MHz 3rd 450 kHz	• Selectivity	: FM, AM More than 15 kHz/–6 dB Less than 30 kHz/–60 dB More than 150 kHz/–6 dB
• Sensitivity (except spurious points; typical values):		• Spurious and image rejection ratio:	More than 60 dB (amateur bands only)
FM	30–117.995 MHz 0.32 μ V	• Audio output power	: 100 mW typical at 10% distortion with an 8 Ω load
(at 12 dB SINAD)	118–174.995 MHz 0.16 μ V		
	175–246.995 MHz 0.22 μ V		
	247–329.995 MHz 0.4 μ V		
	330–379.995 MHz 0.32 μ V		
	380–469.995 MHz 0.18 μ V		
	470–749.995 MHz 1.0 μ V		
	750–999.995 MHz 0.32 μ V		
	1000–1199.995 MHz 0.79 μ V		
	1200–1300 MHz 0.5 μ V		
WFM	76–108.0 MHz 1.0 μ V		
(at 12 dB SINAD)	175–221.995 MHz 1.0 μ V		
	470–770 MHz 5.6 μ V		
AM	118–136.0 MHz 0.56 μ V		
(at 10 dB S/N)	222–246.995 MHz 0.79 μ V		
	247–329.995 MHz 1.4 μ V		

イキ-ジのサマデ可。

All stated specifications are subject to change without notice or obligation.

14 OPTIONS

◇ Ni-Cd batteries and charger

BC-127 Ni-Cd CHARGER

Regularly charges 2 AA (R6) Ni-Cd batteries.

2 or 4

海外品 BC-127
ニカド2本に
同時充電
可能
最大4本に
充電可

◇ Speaker-microphone

HM-46 SPEAKER-MICROPHONE

Slim dimensions. Equipped with an earphone jack and a transmit indicator.

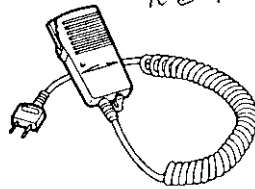

HS-85 HEADSET

For hands-free operation. Includes VOX, PTT and "one-touch" PTT with a time-out timer.

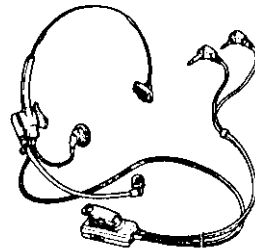

SP-13 EARPHONE

Provides clear receive audio in noisy environments.

OPC-782 PLUG ADAPTER CABLE

Used for connection with an Icom speaker-microphone, or EARPHONE.

◇ Carrying case

LC-146 CARRYING CASE

Helps protect the transceiver from scratches, etc.

Count on us!

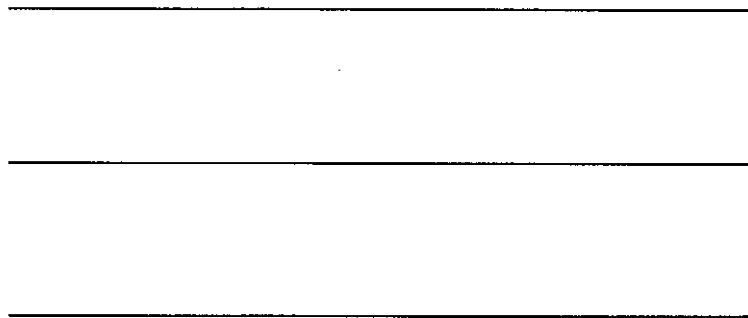
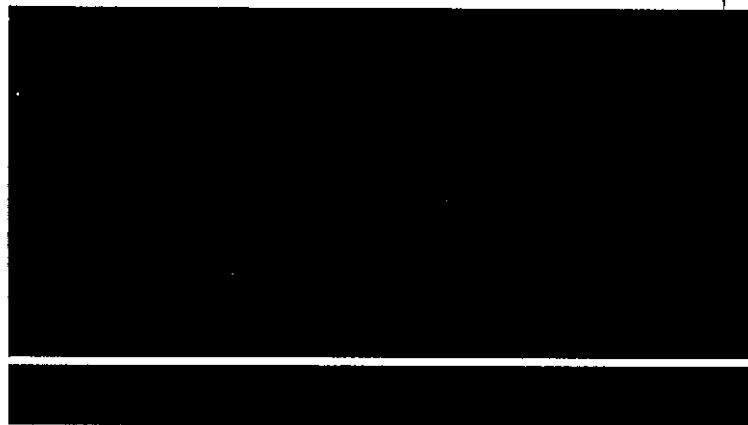

A-5491-1EX
Printed in Japan
© 1998 Icom Inc.

Icom Inc.
6-9-16 Kamihigashi, Hirano-ku, Osaka 547-0002 Japan