



# INSTRUCTION MANUAL

## COMMUNICATIONS RECEIVER **IC-R75**



---

## IMPORTANT

---

**READ THIS INSTRUCTION MANUAL CAREFULLY** before attempting to operate the receiver.

**SAVE THIS INSTRUCTION MANUAL.** This manual contains important safety and operating instructions for the IC-R75.

---

## EXPLICIT DEFINITIONS

---

WORD	DEFINITION
<b>⚠ WARNING</b>	Personal injury, fire hazard or electric shock may occur.
<b>CAUTION</b>	Equipment damage may occur.
<b>NOTE</b>	If disregarded, inconvenience only. No risk of personal injury, fire or electric shock.

---

## TRADEMARKS

---

Icom, Icom Inc. and the Icom logo are registered trademarks of Icom Incorporated (Japan) in Japan, the United States, the United Kingdom, Germany, France, Spain, Russia and/or other countries.

Microsoft and Windows are registered trademarks of Microsoft Corporation in the United States and other countries.

Pentium is a registered trademark of Intel Corporation.

All other products or brands are registered trademarks or trademarks of their respective holders.

---

## PRECAUTIONS

---

⚠ **WARNING NEVER** apply AC to the [DC13.8V] jack on the receiver rear panel. This could cause a fire or ruin the receiver.

⚠ **WARNING NEVER** apply more than 16 V DC, such as a 24 V battery, to the [DC13.8V] jack on the receiver rear panel. This could cause a fire or ruin the receiver.

⚠ **WARNING NEVER** let metal, wire or other objects touch any internal part or connectors on the rear panel of the receiver. This may result in an electric shock.

**NEVER** expose the receiver to rain, snow or any liquids.

**DO NOT** use or place the receiver in areas with temperatures below  $-10^{\circ}\text{C}$  ( $+14^{\circ}\text{F}$ ) or above  $+60^{\circ}\text{C}$  ( $+140^{\circ}\text{F}$ ). Be aware that temperatures on a vehicle's dashboard can exceed  $80^{\circ}\text{C}$  ( $+176^{\circ}\text{F}$ ), resulting in permanent damage to the receiver if left there for extended periods.

**DO NOT** place the receiver in excessively dusty environments or in direct sunlight.

**DO NOT** place the receiver against walls or putting anything on top of the receiver. This will obstruct heat dissipation.

Place unit in a secure place to avoid inadvertent use by children.

During mobile operation, **DO NOT** operate the receiver without running the vehicle's engine. When receiver power is ON and your vehicle's engine is OFF, the vehicle's battery will soon become exhausted.

Make sure the receiver power is OFF before starting the vehicle. This will avoid possible damage to the receiver by ignition voltage spikes.

***For U.S.A only***

**CAUTION:** Changes or modifications not expressly approved by the party responsible for compliance could void the user's authority to operate the equipment.

### FOR CLASS B UNINTENTIONAL RADIATORS

This equipment has been tested and found to comply with the limits for a Class B digital device, pursuant to part 15 of the FCC Rules. These limits are designed to provide reasonable protection against harmful interference in a residential installation. This equipment generates, uses and can radiate radio frequency energy and, if not installed and used in accordance with the instructions, may cause harmful interference to radio communications. However, there is no guarantee that interference will not occur in a particular installation. If this equipment does cause harmful interference to radio or television reception, which can be determined by turning the equipment off and on, the user is encouraged to try to correct the interference by one or more of the following measures:

- Reorient or relocate the receiving antenna.
- Increase the separation between the equipment and receiver.
- Connect the equipment into an outlet on a circuit different from that to which the receiver is connected.
- Consult the dealer or an experienced radio/TV technician for help.

 Versions of the IC-R75 which display the "CE" symbol on the serial number label comply with the European harmonised standard ETS300 684 (EMC product standard for Commercially Available Amateur Radio Equipment).

## SUPPLIED ACCESSORIES

The receiver comes with the following accessories.

	<b>Qty.</b>
① AC adapter (AD-55/A/S/V†)* .....	1
② DC power cable (OPC-869)* .....	1
③ Fuse (FGB 3 A; internal use) .....	1
④ Fuse (FGB 3 A; for DC cable)* .....	2

\* Either AC adapter + 1 fuse (①, ③) or DC power cable + 3 fuses (②, ③, ④) are supplied depending on versions.

† The AD-55, AD-55A, AD-55S and AD-55V have different shapes.

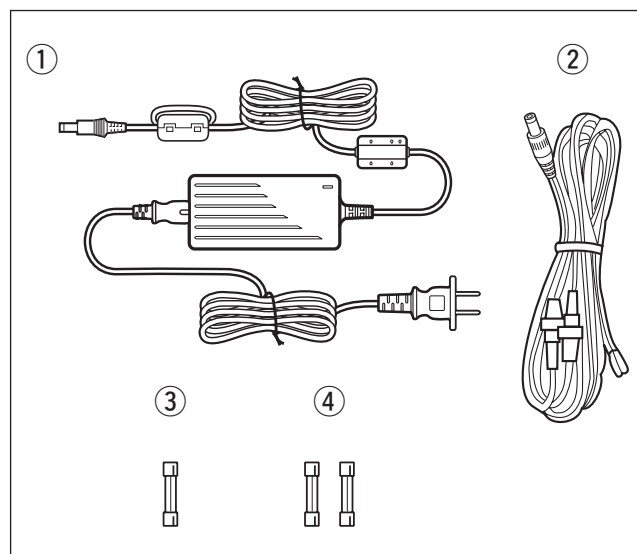

### INFORMATION

A switching type AC adapter includes a switching regulator. The receiver could receive switching noise from the adapter's switching regulator circuit. Depending on the usage environment, it tends to happen in AM reception, especially around 7 to 10 MHz. If it causes interference, please try some of the following to reduce the noise.

- Ground the receiver.
- When another AC powered equipment is connected to the receiver, plug the AC adapter into a different AC outlet than the equipment.
- Keep the AC adapter as far away from the receiver's antenna and any metal objects as possible.
- Attach an AC line filter to the AC adapter.

# TABLE OF CONTENTS 1

IMPORTANT .....	i	6 MEMORY OPERATION .....	21 – 24
EXPLICIT DEFINITIONS .....	i	■ Memory channels .....	21
TRADEMARKS .....	i	■ Memory channel selection .....	21
PRECAUTIONS .....	ii	■ Memory channel programming .....	22
SUPPLIED ACCESSORIES .....	iii	■ Frequency transferring .....	23
<b>1 TABLE OF CONTENTS .....</b>	<b>1</b>	■ Memory names .....	24
<b>2 PANEL DESCRIPTION .....</b>	<b>2 – 6</b>	■ Memory clearing .....	24
■ Front panel .....	2	<b>7 SCANS .....</b>	<b>25 – 27</b>
■ Function display .....	5	■ Scan types .....	25
■ Rear panel .....	6	■ Preparation .....	25
<b>3 INSTALLATION AND CONNECTIONS .....</b>	<b>7 – 10</b>	■ Programmed scan operation .....	26
■ Grounding .....	7	■ Memory/select memory scan operation .....	26
■ Receiver stand .....	7	■ Setting select memory channels .....	26
■ Optional bracket and carrying handle .....	7	■ Priority watch operation .....	27
■ Connections .....	8	■ Auto memory write scan operation .....	27
■ Antenna connection .....	9	<b>8 CLOCK AND TIMERS .....</b>	<b>28 – 29</b>
■ Tape recorder connections .....	9	■ Setting the current time .....	28
■ Transceive function .....	9	■ Setting power-on time .....	28
■ FSK and AFSK (SSTV) connections .....	10	■ Setting power-off time .....	29
■ Connecting to a PC .....	10	■ Setting sleep timer period .....	29
<b>4 FREQUENCY SETTING .....</b>	<b>11 – 13</b>	<b>9 SET MODE .....</b>	<b>30 – 33</b>
■ Read me first .....	11	■ Set mode description .....	30
■ Using the keypad .....	11	<b>10 OPTION INSTALLATIONS .....</b>	<b>34 – 35</b>
■ Frequency setting .....	12	■ Opening the receiver's case .....	34
■ Dial lock function .....	13	■ CR-282 HIGH STABILITY CRYSTAL UNIT .....	34
<b>5 RECEIVE FUNCTIONS .....</b>	<b>14 – 20</b>	■ UT-102 VOICE SYNTHESIZER UNIT .....	34
■ Mode selection .....	14	■ UT-106 DSP UNIT .....	35
■ Squelch and RF gain .....	14	■ Optional IF filters .....	35
■ Twin PBT operation .....	15	<b>11 MAINTENANCE .....</b>	<b>36 – 37</b>
■ Noise blanker .....	15	■ Troubleshooting .....	36
■ Preamp .....	16	■ Resetting the CPU .....	36
■ Attenuator .....	16	■ Fuse replacement .....	37
■ AGC time constant .....	16	■ Clock backup battery replacement .....	37
■ Antenna selection .....	16	<b>12 SPECIFICATIONS .....</b>	<b>38</b>
■ CW reverse mode .....	17	<b>13 OPTIONS .....</b>	<b>39</b>
■ CW pitch control .....	17	<b>14 CONTROL COMMAND .....</b>	<b>40 – 43</b>
■ RTTY reverse mode .....	17	■ Remote jack (CI-V) information .....	40
■ Filter selection .....	18		
■ Filter set mode .....	19		
■ Optional noise reduction function .....	20		
■ Optional auto notch function .....	20		

## ■ Front panel

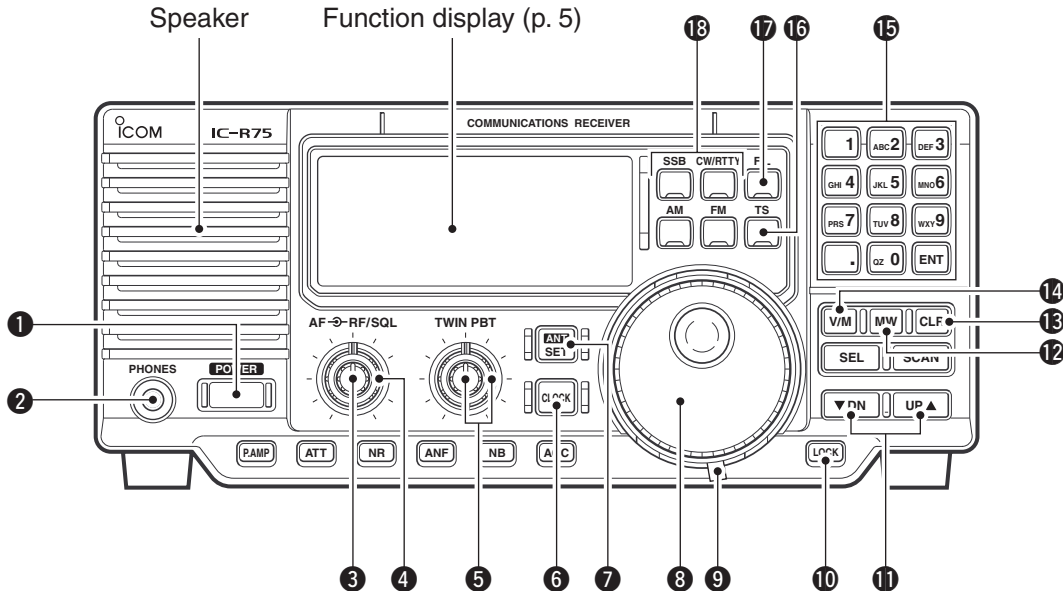

### 1 POWER SWITCH [POWER]

- ➔ Push momentarily to turn power ON.
  - Turn the optional DC power supply ON in advance.
- ➔ Push for 2 sec. to turn power OFF.

### 2 HEADPHONE JACK [PHONES] (p. 8)

- Accepts headphones.
- When headphones are connected, the internal speaker or connected external speaker does not function.

### 3 AF CONTROL [AF] (inner control)

- Varies the audio output level from the speaker.

### 4 RF GAIN/SQUELCH CONTROL [RF/SQL]

- (outer control; pgs. 14, 30)
- Adjusts the squelch threshold level. The squelch removes noise output from the speaker (closed condition) when no signal is received.
- The squelch is particularly effective for FM. It is also available for other modes.
- The control can be set as the squelch plus RF gain controls or squelch control only (RF gain is fixed at maximum) in set mode.

### 5 PASSBAND TUNING CONTROLS [TWIN PBT]

- (p. 15)
- Adjust the receiver's "passband width" of the 455 kHz and 9 kHz IF filters for the inner and outer controls, respectively.
- Set to the center positions when not in use.

### 6 CLOCK MODE SWITCH [CLOCK] (p. 28)

- Toggles between frequency indication and clock indication when pushed.

### 7 ANTENNA SELECTOR/SET MODE SWITCH [ANT/SET] (pgs. 16, 30)

- ➔ While in a frequency indication, enters set mode when pushed.
- ➔ While in a frequency indication, toggles between the antenna 1 and 2 connectors when pushed for 2 sec.
- ➔ While in the clock indication, enters time setting condition when pushed for 2 sec.
- ➔ While in a timer indication, toggles the timer ON or OFF when pushed.

### 8 TUNING DIAL

- Changes the displayed frequency, selects set mode items, etc.

### 9 TUNING DIAL TENSION LATCH

- Adjusts the tension of the tuning dial.

### 10 LOCK/SPEECH SWITCH [LOCK] (pgs. 13, 34)

- ➔ Toggles the frequency lock function ON and OFF.
- ➔ Announces the selected readout frequency when an optional UT-102 is installed and when pushed for 2 sec.

**11 MEMORY CHANNEL UP/DOWN SWITCHES**

[▼ DN]/[UP ▲] (p. 21)

- ➔ Select a memory channel.
- ➔ Select a set mode contents while in set mode.
- ➔ Select a timer or time indication while in clock indication.
- ➔ Select a filter set mode contents while in filter set mode.

**12 MEMORY WRITE SWITCH [MW] (pgs. 22, 27)**

- ➔ Stores the displayed frequency and operating mode into the selected memory channel when pushed for 2 sec.
- ➔ Toggles the programmed scan and auto memory write scan when pushed.

**13 CLEAR SWITCH [CLR] (p. 24)**

- ➔ Clears the input digits while inputting a frequency or memory channel number.
- ➔ Clears the selected memory channel contents when pushed for 2 sec. in memory mode.
  - This switch does not function in VFO mode.

**14 VFO/MEMORY SWITCH [V/M] (pgs. 21, 23)**

- ➔ Toggles the operating mode between VFO mode and memory mode when pushed.
- ➔ Selects a memory channel for inputting a memory channel number when pushed.
- ➔ Transfers the memory contents to VFO when pushed for 2 sec.

**15 KEYPAD (pgs. 11, 21)**

The keypad can be used for several functions as below:

- Keypad then [ENT]
  - Direct frequency input.
- Keypad then [V/M]
  - Memory channel selection.
- [ENT] then keypad in memory name indication mode
  - Alphanumeric input for memory name, etc.

**16 QUICK TUNING STEP SWITCH [TS] (pgs. 12, 13)**

- ➔ Selects a quick tuning step or turns the quick tuning step OFF.
  - While the quick tuning indicator (▼) is displayed, the frequency can be changed in kHz or MHz steps.
- ➔ While the quick tuning step is OFF, turns the 1 Hz step ON and OFF when pushed for 2 sec.
  - 1 Hz indication appears and the frequency can be changed in 1 Hz steps.
- ➔ While the kHz quick tuning step is selected, enters tuning step set mode when pushed for 2 sec.
- ➔ While the memory name indication is selected in memory mode, pushing this switch shows the operating frequency; and rotating the tuning dial while pushing this switch changes the frequency temporarily.

**17 FILTER SWITCH [FIL] (pgs. 18, 19)**

- ➔ Push momentarily to toggle between the pre-programmed normal, wide and narrow IF filters for the selected operating mode.
- ➔ Push for 2 sec. to enter filter set mode.

**18 MODE SWITCHES [SSB]/[CW/RTTY]/[AM]/[FM] (p. 14)**

Select an operating mode.

- Push [SSB] to toggle between LSB and USB.
- Push [CW/RTTY] to toggle between CW and RTTY.
- Push [CW/RTTY] for 2 sec. to toggle between CW and CW reverse or RTTY and RTTY reverse.
- Push [AM] to select AM.
- Push [FM] to select FM.

■ Front panel (continued)

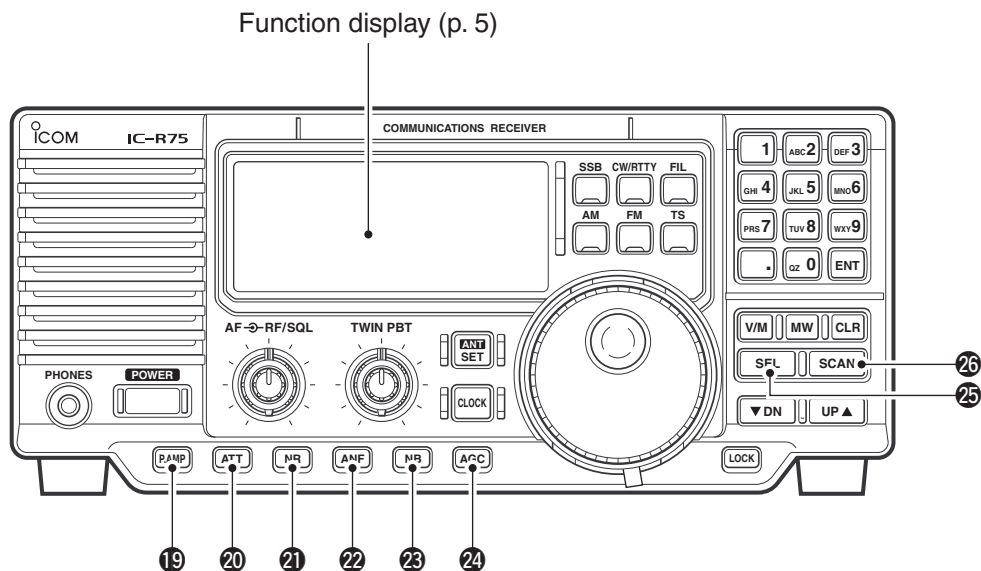

- 19 PREAMP SWITCH [P.A.M.P.]** (p. 16)  
 Push to toggle between preamp-1 and preamp-2 or turn the preamp OFF.
- 20 ATTENUATOR SWITCH [ATT]** (p. 16)  
 Push to toggle the 20 dB attenuator function ON and OFF.
- 21 NOISE REDUCTION SWITCH [NR]** (p. 20)  
 ➤ Toggles the optional noise reduction function ON and OFF when pushed. Functions in SSB, CW and RTTY modes. An optional UT-106 DSP UNIT is required.  
 ➤ Enters noise reduction level set mode when pushed for 2 sec. An optional UT-106 DSP UNIT is required.
- 22 AUTOMATIC NOTCH FILTER SWITCH [ANF]** (p. 20)  
 Push to turn the optional automatic notch filter for receiving AM signals ON and OFF. An optional UT-106 DSP UNIT is required.
- 23 NOISE BLANKER SWITCH [NB]** (p. 15)  
 Toggles the noise blanker ON and OFF. The noise blanker reduces pulse-type noise such as that generated by automobile ignition systems. This function is not effective for FM, or non pulse-type noise.
- 24 AGC SWITCH [AGC]** (p. 16)  
 ➤ Toggles the AGC (Automatic Gain Control) time constant fast and slow when pushed.  
 ➤ Toggles the AGC function ON and OFF when pushed for 2 sec.
- 25 SELECT SWITCH [SEL]** (pgs. 24, 26)  
 ➤ Toggles the select memory setting ON and OFF when pushed in memory mode.  
 ➤ Toggles the memory name indication ON and OFF when pushed for 2 sec. in memory mode.
- 26 SCAN SWITCH [SCAN]** (p. 25)  
 ➤ Push momentarily to start/stop the programmed scan in VFO mode.  
 ➤ Push momentarily to start/stop the memory scan in memory mode.  
 ➤ Push for 2 sec. to start the priority watch in VFO mode.  
 • Push [SCAN] again to cancel the priority watch.



## ■ Function display

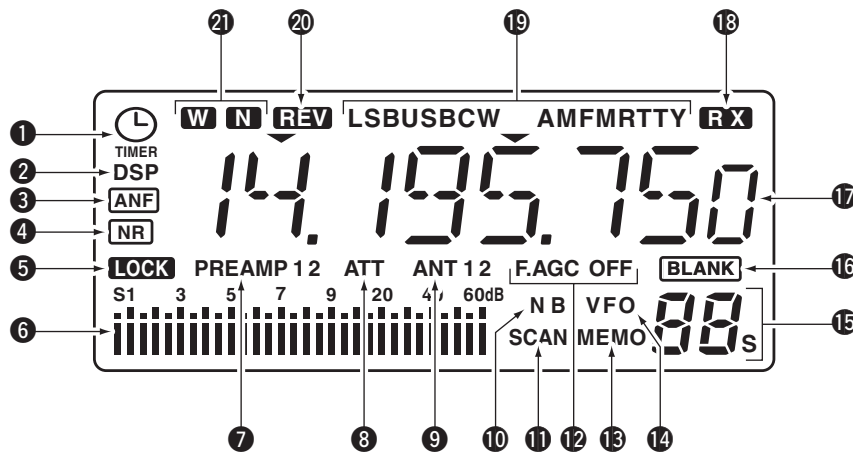

- 1 TIMER INDICATOR** (p. 28)  
Appears when power on/off timer or sleep timer is in use.
- 2 DSP UNIT INDICATOR** (p. 35)  
Appears when an optional UT-106 DSP UNIT is installed.
- 3 AUTOMATIC NOTCH FILTER INDICATOR** (p. 20)  
Appears when the optional automatic notch filter is in use.
- 4 NOISE REDUCTION INDICATOR** (p. 20)  
Appears when the optional noise reduction function is in use.
- 5 LOCK INDICATOR** (p. 13)  
Appears when the dial lock function is in use.
- 6 SIGNAL METER**  
  - Shows the relative receive signal strength.
  - Shows the S-meter squelch level when used.
- 7 PREAMP INDICATOR** (p. 16)  
Appears when antenna preamp-1 or preamp-2 is in use.
- 8 ATTENUATOR INDICATOR** (p. 16)  
Appears when the attenuator function is in use.
- 9 ANTENNA INDICATORS** (p. 16)  
Indicate which antenna connector is in use.
- 10 NOISE BLANKER INDICATOR** (p. 15)  
Appears when the noise blanker function is in use.
- 11 SCAN INDICATOR** (p. 25)  
  - Appears when scan or priority watch is activated.
  - Flashes when scan or priority watch is paused.
- 12 AGC INDICATORS** (p. 16)  
  - “AGC” appears when slow AGC time constant is selected.
  - “F.AGC” appears when fast AGC time constant is selected.
  - “AGC OFF” appears when the AGC function is turned OFF.
  - “F.AGC” blinks while scanning or while using band scope via an optional RS-R75.
- 13 MEMORY MODE INDICATOR** (p. 21)  
Indicates memory mode is selected.
- 14 VFO MODE INDICATOR**  
Indicates VFO mode is selected.
- 15 MEMORY CHANNEL NUMBER READOUT** (p. 21)  
  - Shows the selected memory channel number.
  - “S” appears when the displayed memory channel is designated as a select memory channel.
- 16 BLANK MEMORY INDICATOR**  
Shows that the displayed memory channel is not programmed.  
  - This indicator appears both in VFO and memory modes.
- 17 FREQUENCY READOUT**  
Shows the operating frequency.
- 18 RECEIVE INDICATOR**  
Appears while receiving a signal or when the squelch is open.
- 19 MODE INDICATORS** (p. 14)  
Indicate the selected operating mode.
- 20 REVERSE MODE INDICATOR** (p. 17)  
Indicates a reverse operating mode is selected.
- 21 WIDE/NARROW FILTER INDICATORS** (p. 18)  
  - “W” appears when the wide IF filter is selected.
  - “N” appears when the narrow IF filter is selected.

### ■ Rear panel

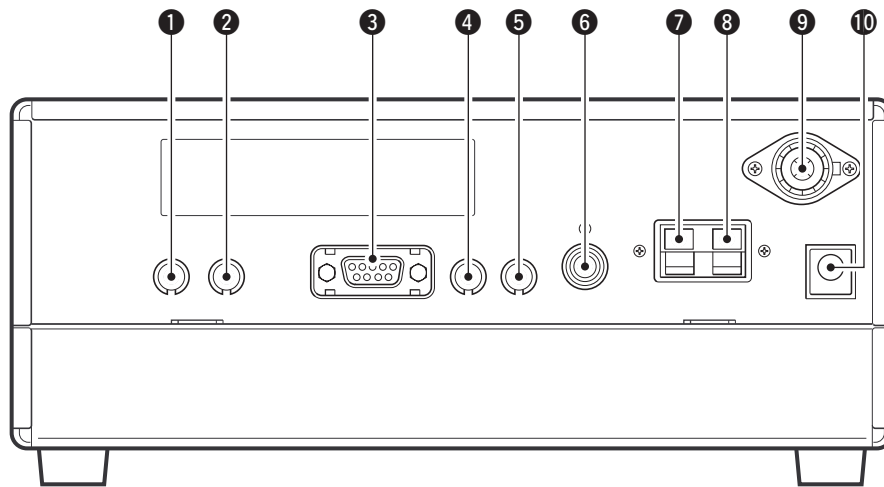

#### ❶ RECORDER REMOTE JACK [REC REMOTE]

Controls the running of a tape recorder for recording. Connects to the REMOTE jack on a tape recorder.

- This function can be turned OFF in set mode. (p. 32)

#### ❷ RECORDER JACK [REC]

Outputs receive audio signals. Connects to the AUX or LINE IN jack on a tape recorder.

#### ❸ RS-232C CONNECTOR [RS-232C]

Connects an RS-232C cable. An RS-232C cable can be used to connect the receiver to a PC. In this way commands can be sent to the receiver via the PC.

#### ❹ CI-V REMOTE CONTROL JACK [REMOTE]

Allows connection to an Icom CI-V system transceiver or another receiver for the transceive function. Also connects to a PC with several receivers for command control via an optional CT-17 CI-V LEVEL CONVERTER.

#### ❺ EXTERNAL SPEAKER JACK [EXT SP]

Connects an 8  $\Omega$  external speaker, if desired.

- When an external speaker is connected, the internal speaker does not function.

#### ❻ MUTE CONTROL JACK [MUTE]

Mutes audio outputs and attenuates the receive signal input when grounded. Used for CI-V transceive operation with a transceiver.

#### ❼ GROUND TERMINAL [GND] (p. 7)

Connects the black terminal to ground.

#### ❽ ANTENNA 2 TERMINAL [ANT 2] (p. 9)

Connects the red terminal to a 500  $\Omega$  long wire antenna.

#### ❾ ANTENNA 1 CONNECTOR [ANT 1] (p. 9)

Connects a 50  $\Omega$  antenna with a PL-259 connector and a 50  $\Omega$  coaxial cable.

#### ❿ DC POWER JACK [DC 13.8V] (p. 8)

➔ Connects the supplied AC adapter for versions with an AC adapter.

➔ Connects to a 13.8 V DC power source using the supplied DC cable for versions without an AC adapter.

- Current of 1.5 A or greater is required.

⚠ **DO NOT** use a cigarette lighter socket as a power source when operating in a vehicle. The plug may cause voltage drops and ignition noise may be superimposed onto received audio.

## ■ Grounding

To prevent accidents involving electricity and interference from transceivers, ground the receiver through the [GND] terminal on the rear panel.

For best results, connect a heavy gauge wire or strap to a long earth-sunk copper rod. Make the distance between the [GND] terminal and ground as short as possible.

**⚠ WARNING: NEVER** connect the [GND] terminal to a gas or electric pipe, since the connection could cause an explosion or electric shock.

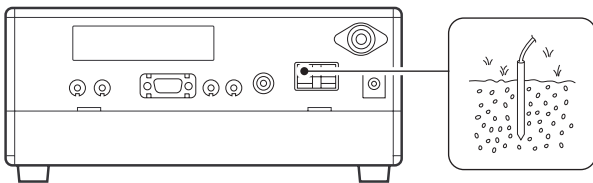

## ■ Receiver stand

The base of the receiver has an adjustable stand for desktop use. Set the stand to one of two angles depending on your operating conditions.

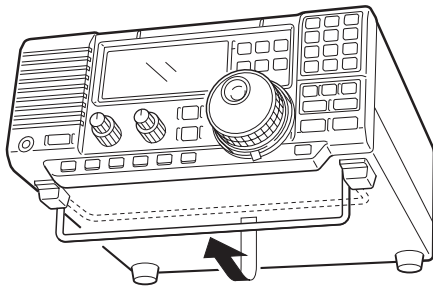

## ■ Optional bracket and carrying handle

### ◇ Mounting bracket

An optional IC-MB5 MOBILE MOUNTING BRACKET is available to install the radio under a table, on a wall, in a vehicle, etc.

Select an area to mount the receiver keeping in mind that the weight of the receiver is approx. 3 kg.

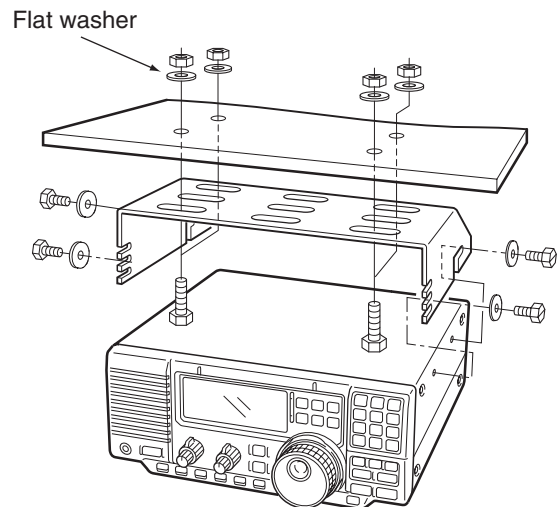

### ◇ Carrying handle

An optional handle allows you to easily carry and transport the receiver.

Attach the MB-23 CARRYING HANDLE with the supplied rubber feet as shown.

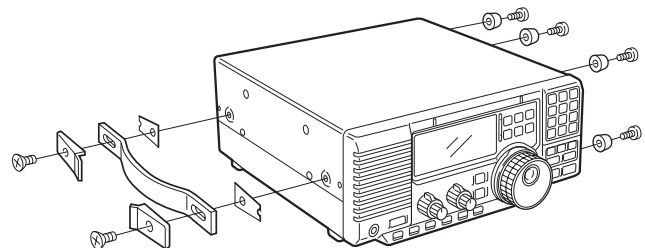

## ■ Connections

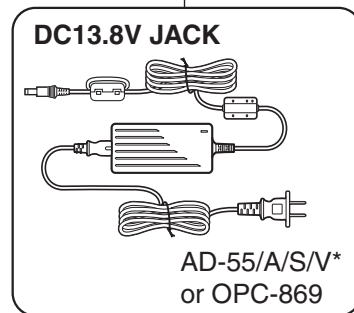
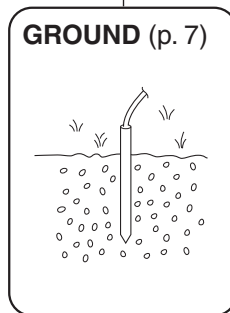
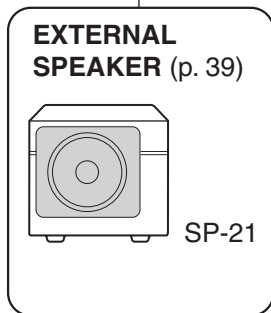
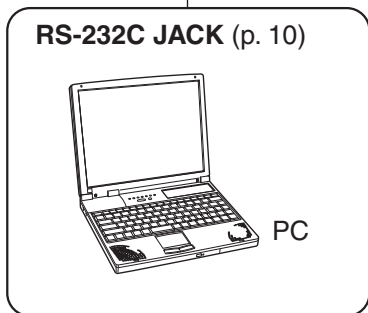
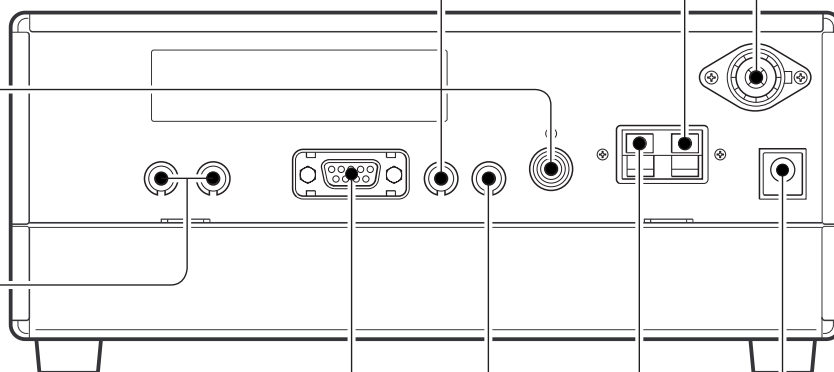
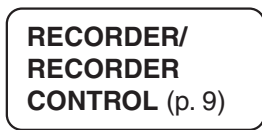
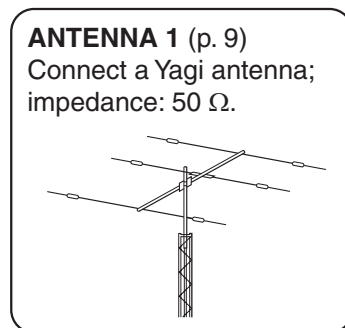
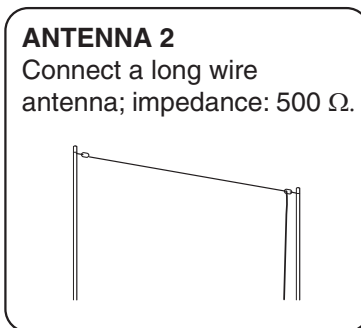
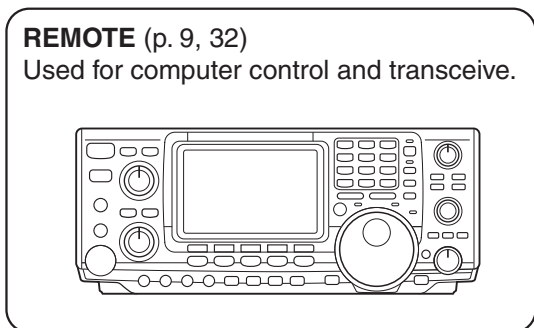
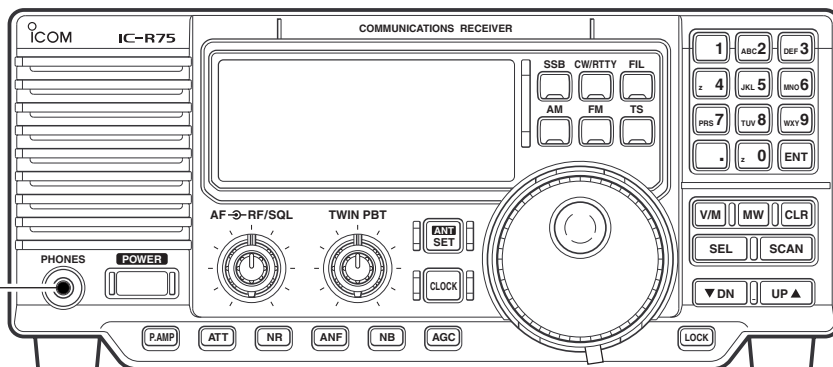

\* The AD-55, AD-55A, AD-55S and AD-55V have different shapes.

## ■ Antenna connection

Antennas play a very important role in receiver operation. Connecting a poor quality antenna to the receiver will result in less than optimum performance.

When using a 50 Ω antenna, use [ANT 1] connector for connection. When using a 500 Ω long wire antenna, use [ANT 2] terminal for connection.

### PL-259 CONNECTOR INSTALLATION EXAMPLE

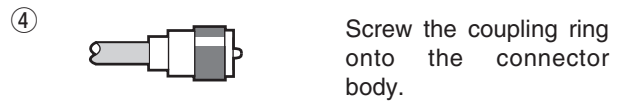
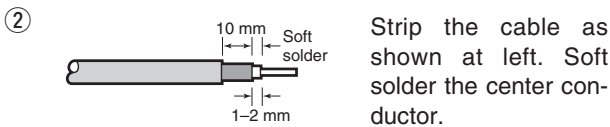
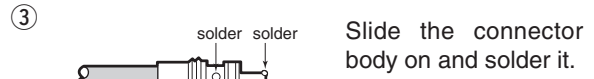
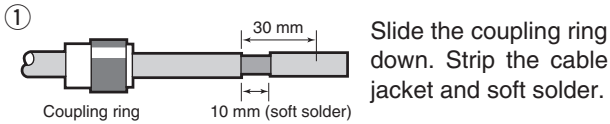

(10 mm ≈ 3/8 in)

## ■ Tape recorder connections

The [REC OUT] jack has 350 mV rms/4.7 kΩ output for connection to other audio equipment.

[REC REMOTE] jack: Grounds when a signal is received and squelch opens. If a tape recorder has a control terminal, this jack can be used for recording control. (1 A/DC max.)

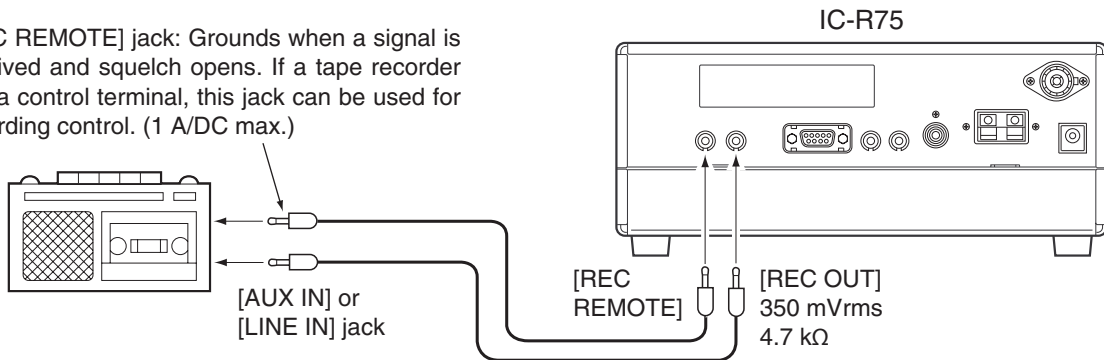

## ■ Transceive function

Icom CI-V transceivers or receivers can be connected via the [REMOTE] jack. The frequency and mode become the same\* when either radio is changed.

\* When a set frequency is out-of-range for one of the connected transceivers or receivers, the connected radio's frequency/mode does not change.

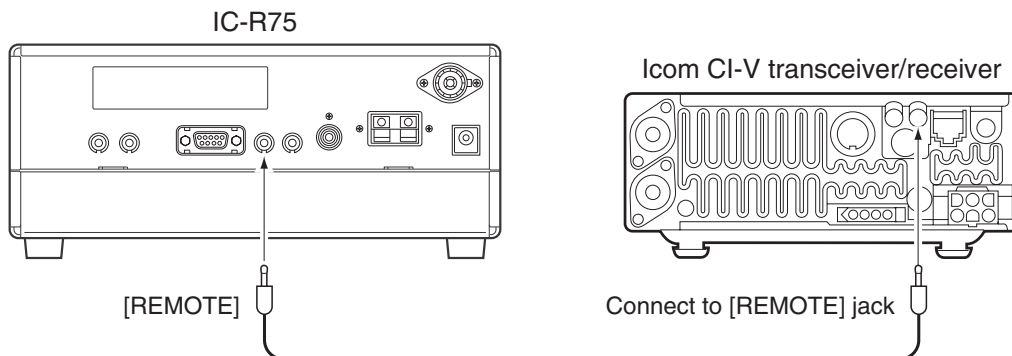

Be sure the "CIV TRn" item is turned ON in set mode (p. 32).

### 3 INSTALLATION AND CONNECTIONS

## ■ FSK and AFSK (SSTV) connections

To connect a terminal unit, TNC or scan converter, refer to the diagram below.

- ① Connect a terminal unit as below.
- ② Select RTTY mode (or USB, CW modes for HF band data communications).
- ③ Set the receiver to the desired frequency as at right.
- ④ Set the connected terminal unit to the appropriate settings.
  - Refer to the terminal unit's instructions.

/// The optional 250 Hz CW narrow filters may not pass RTTY signals. Be sure to select the appropriate IF filters corresponding to the signal width. (pgs. 18, 19)

**Frequency settings depend on the mode used.**

- /// FM mode:  
[Setting frequency (displayed freq.)] = [Desired freq.]
- /// USB mode:  
[Setting frequency (displayed freq.)] = [Desired freq.] – [Center of Mark and Space freq.]
- /// CW narrow mode:  
[Setting frequency (displayed freq.)] = [Desired freq.] – [Center of Mark and Space freq.] + [600 Hz]
- /// LSB mode (for amateur RTTY):  
[Setting frequency (displayed freq.)] = [Desired freq.] + [Mark freq.]

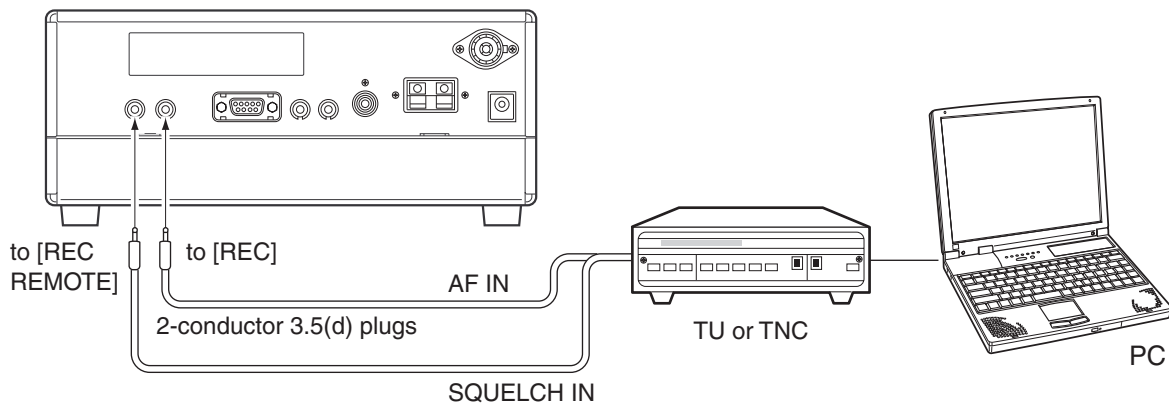

## ■ Connecting to a PC

The RS-R75 remote control software is available to perform data setting and remote control of the receiver.

Refer to the diagram below for connection.

### ◇ System requirements

To use this program, the following hardware and software are required:

- IBM PC compatible computer
- An RS-232C serial port
- Microsoft® Windows® 95 or Microsoft® Windows® 98
- Intel i486DX4 processor or faster (Pentium® 100 MHz or faster recommended)
- At least 16 MB RAM
- At least 10 MB of hard disk space
- At least 640 × 480 pixel, high color (16 bit) display

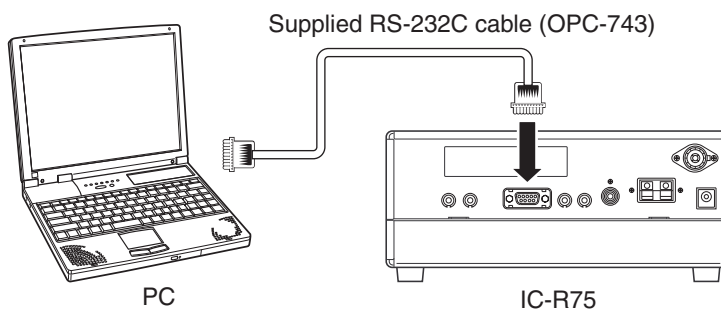

## ■ Read me first

The receiver uses memory channels for storage of frequencies (as well as mode, tuning steps, etc.). When turning power OFF or changing memory channels, the previously displayed frequency cannot be recalled unless it has been stored into a memory channel.

Therefore, when you want to keep a displayed frequency for later recall, you must program it into a memory channel by pushing [MW] for 2 sec.

See p. 22 for details.

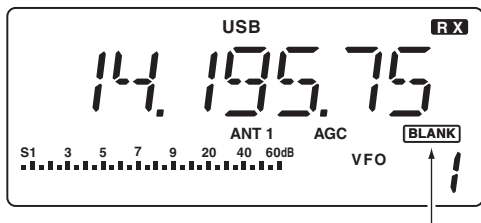

“BLANK” appears above the memory channel readout until [MW] is pushed for 2 sec.

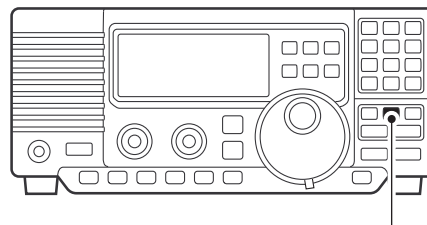

Push [MW] for 2 sec. after tuning.

## ■ Using the keypad

- ① Push the numeral keys on the keypad to enter the MHz digits for the desired frequency.
  - If a key is mistakenly pushed, push [CLR] and start again from the beginning.
  - When entering the same MHz digits as the displayed frequency, this step can be skipped.
- ② Push [•] on the keypad.
- ③ Push the numeral keys to enter the frequency digits below 1 MHz.
  - If a key is mistakenly pushed, push [CLR] and start again from the beginning.
- ④ Push [ENT] to set the input frequency.
  - When pushing [ENT] after entering the MHz digits, zeros are automatically entered for the kHz digits.

### [EXAMPLE]: Setting the frequency using the keypad.

•To set to 28.00 MHz

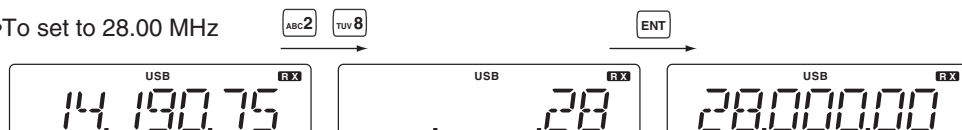

•To set to 21.050 MHz

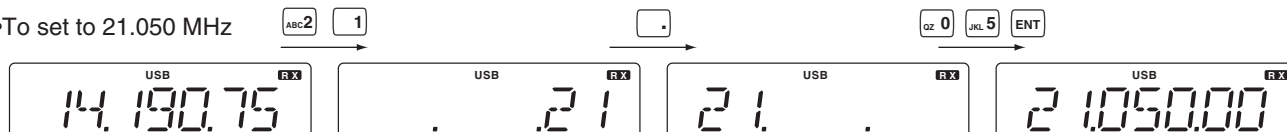

•To set to 850 kHz (0.850 MHz)

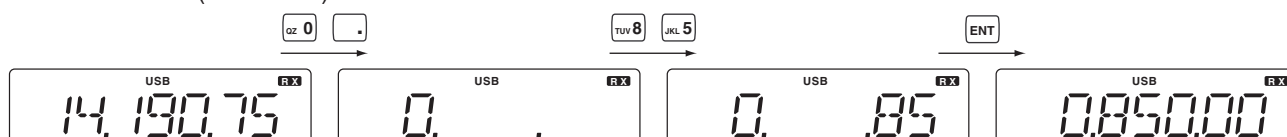

•To change 14.19075 to 14.850 MHz

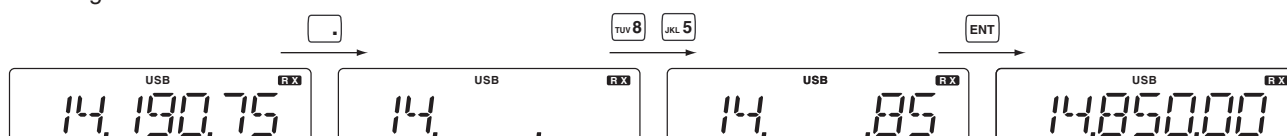

## 4 FREQUENCY SETTING

### ■ Frequency setting

Rotate the tuning dial to change the frequency.

- The frequency changes in increments determined by the selected tuning step (see below).
- When the lock function is activated (“LOCK” appears), the frequency cannot be changed via tuning dial.

Push [TS] one or more times to select a quick tuning step.

#### ◇ Programmable tuning steps

Programmable tuning steps are available to suit your operating requirements.

These tuning steps are:

- Independently selectable for each mode
- Selectable from 0.1, 1, 5, 6.25, 9, 10, 12.5, 20, 25, 100 kHz

- ① Select the desired operating mode with [SSB], [CW/RTTY], [AM] or [FM]. (p. 14)
- ② Push [TS] one or more times until the programmable tuning step indicator, “▼,” appears above the 1 kHz.
  - Rotating the tuning dial changes the frequency according to the set tuning step.
- ③ Push [TS] for 2 sec. while the programmable tuning step indicator appears to enter the tuning step set mode.
- ④ Rotate the tuning dial to set the desired tuning step for the selected mode.
- ⑤ Push [TS] to exit the tuning step set mode.
- ⑥ Rotate the tuning dial to change the frequency according to the set tuning step.

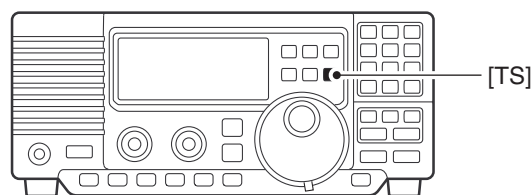

#### ◇ 1 Hz and 10 Hz tuning steps

When both the 1 MHz tuning step and programmable tuning step, “▼,” disappear, rotating the tuning dial changes the frequency in increments of 1 or 10 Hz.

- ① Push [TS] one or more times until the programmable tuning step indicator or 1 MHz tuning step indicator, “▼,” disappears.
- ② Push [TS] for 2 sec. to toggle between the 1 and 10 Hz step settings.
  - When the 1 Hz step is selected, the 1 Hz digit appears in the frequency indication; when the 10 Hz step is selected, the 1 Hz digit disappears from the frequency indication.

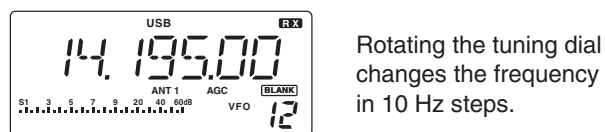

Push  for 2 sec.

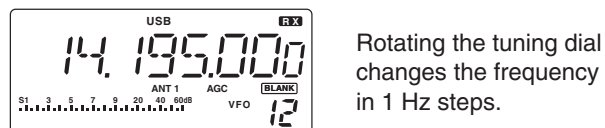



### ◇ 1 MHz quick tuning step

The quick tuning step function allows you to change the frequency in 1 MHz steps when rotating the tuning dial.

Push [TS] one or more times until the 1 MHz tuning step indicator, “▼,” appears above the 1 MHz indicator.

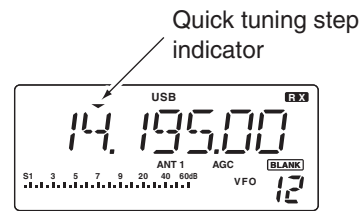

### [TS] SWITCH FLOW CHART

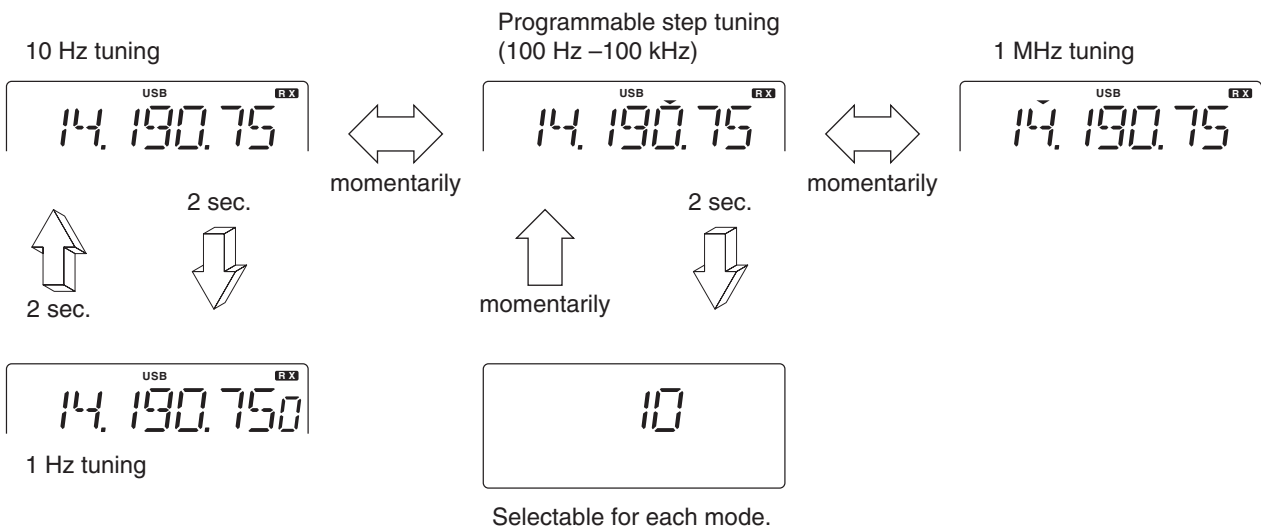

## ■ Dial lock function

The dial lock function prevents accidental changes caused by the tuning dial. The lock function electronically locks the dial.

Push [LOCK] momentarily to toggle the lock function ON and OFF.

- “LOCK” appears in the function display while the lock function is activated.

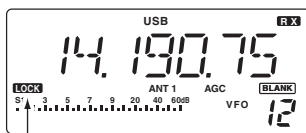
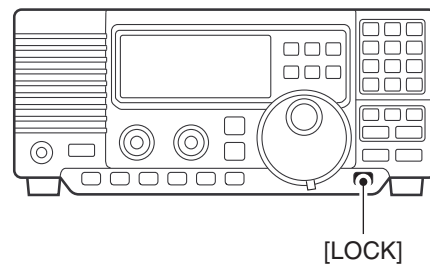

“LOCK” appears while the lock function is activated.

## Mode selection

The following modes are available in the IC-R75: SSB (LSB/USB), CW, CW REV (CW reverse), FM, AM, RTTY and RTTY REV (RTTY reverse).

- ➔ Push [SSB] to toggle between LSB and USB.
- ➔ Push [CW/RTTY] momentarily to toggle between CW and RTTY.
- ➔ Push [CW/RTTY] for 2 sec. to toggle between CW and CW reverse or RTTY and RTTY reverse.
- ➔ Push [AM] to select AM.
- ➔ Push [FM] to select FM.

▨ The selected mode is indicated in the function display.

### OPERATING MODE SELECTION

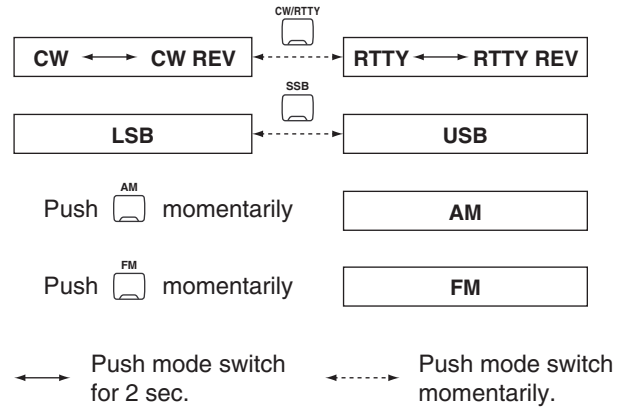

## Squelch and RF gain

The receiver uses the same control, [RF/SQL], to adjust one of either the RF gain or the squelch. [RF/SQL] adjusts either the RF gain or the squelch depending on the operating mode selected and the condition of the RF/SQL item in set mode (p. 30).

### • [RF/SQL] control priority

Set mode setting	USB, LSB, CW, RTTY	AM, FM
Sq (SQL)	SQL*	SQL*
At (AUTO)	RF GAIN	SQL*
rS (RF/SQL)	RF/SQL	RF/SQL

\* The RF gain is set to maximum level when the [RF/SQL] is set as [SQL] control.

The RF (Radio Frequency) gain is used to adjust the receiver gain.

- Shallow rotation moves the S-meter to the right indicating the signal strength which can be received.

▨ The recommended position for RF gain is the 12 o'clock position since this sets RF gain to the max.

The SQUELCH removes noise output from the speaker (closed condition) when no signal is received. The squelch is particularly effective for FM. It is also available for the other modes.

- When operating in FM, first rotate the control fully counterclockwise. Then, rotate the control clockwise to the point where the noise just disappears. This is the best position. The squelch does not open for weak signals

when it is set too deep.

- A segment appears in the S-meter to indicate the S-meter squelch level.

### • When set as the [RF/SQL] control

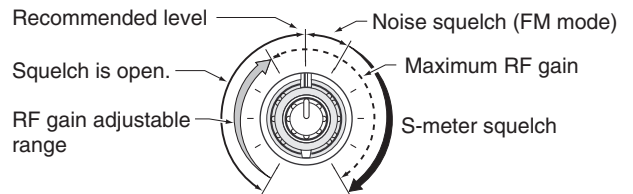

### • When set as the [SQL] control

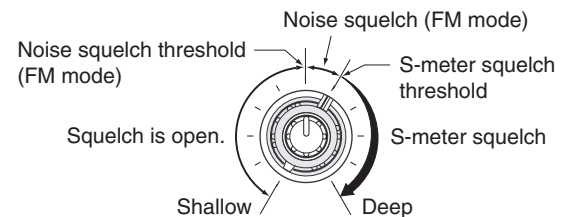

### • When set as the [RF] control

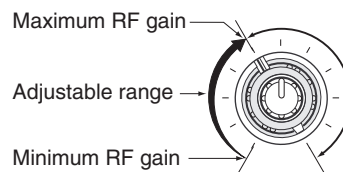

## ■ Twin PBT operation

The twin PBT (Passband Tuning) function electronically narrows the IF passband widths to reduce interference. Moving both [TWIN PBT] controls to the same position shifts the IF.

Variable range depends on the filter selection.  $\pm 1.29$  kHz in 15 Hz steps and  $\pm 258$  kHz in 3 Hz steps are available.

- [TWIN PBT] should normally be set to the center positions when there is no interference.
- When PBT is used, the audio tone may be changed.
- PBT may not function with some IF filter combinations.
- Not available for FM mode.

### PBT OPERATION EXAMPLE

Both controls at center position

TWIN PBT

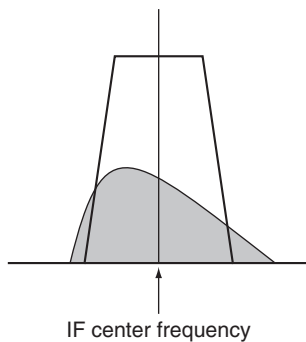
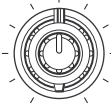

Cutting a lower passband

TWIN PBT

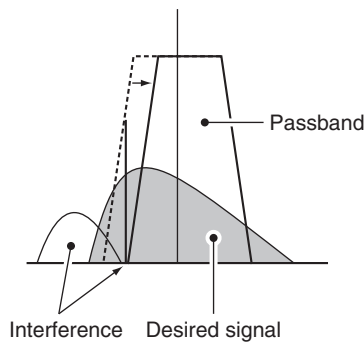
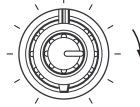

Cutting both higher and lower passbands

TWIN PBT

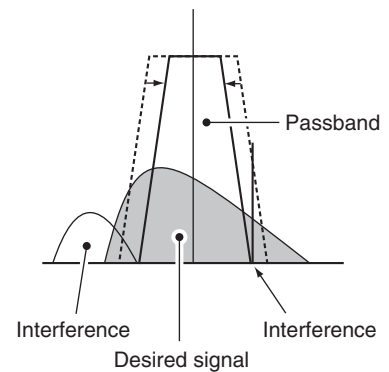
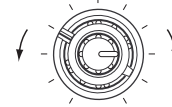

## ■ Noise blanker

The noise blanker eliminates pulse-type noise such as from car ignitions. The noise blanker is not available for FM mode.

➡ Push the [NB] switch to turn the noise blanker ON or OFF.

- When using the noise blanker, received signals may be distorted if they are excessively strong.
- The noise blanker function in AM mode can be deactivated depending on set mode setting. (p. 31)

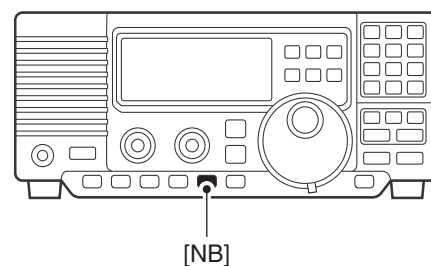

## 5 RECEIVE FUNCTIONS

### ■ Preamp

The preamp amplifies received signals in the front end circuit to improve the S/N ratio and sensitivity. Turn this function ON when receiving weak signals.

- ➔ Push [P.AMP] to toggle between preamp-1 and preamp-2 or turn the preamp OFF.

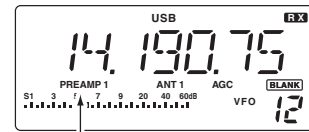

“PREAMP” appears while the preamp is activated.

### ■ Attenuator

The attenuator prevents desired signals from distorting when very strong signals are near the desired frequency or when very strong electric fields, such as from broadcasting stations, are near your location.

- ➔ Push [ATT] toggle the 20 dB attenuator function ON and OFF.
  - “ATT” appears when the attenuator is turned ON.

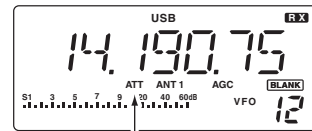

“ATT” appears while the attenuator is activated.

### ■ AGC time constant

The AGC (Automatic Gain Control) controls receiver gain to produce a constant audio output level even when the received signal strength is varied by fading, etc. Use AGC slow for normal phone operation; AGC fast for receiving data and searching for signals.

- ➔ Push [AGC] momentary to toggle the AGC time constant between fast and slow.
  - “F.AGC” appears when the fast time constant is selected.
  - “AGC” appears when the slow time constant is selected.
- ➔ Push [AGC] for 2 sec. to turn the AGC circuit OFF.
  - “AGC OFF” appears when the AGC circuit is turned OFF.
  - Push [AGC] to turn the AGC circuit ON.
  - S-meter is deactivated when the AGC circuit is turned OFF.

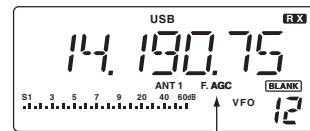

“F.AGC” appears when the fast time constant is selected.

### ■ Antenna selection

2 types of antenna can be connected to this receiver. When 2 antennas are connected, select an antenna depending on the operating condition.

- ➔ Push [ANT(SET)] for 2 sec. to toggle between the antenna 1 and 2 connectors.
  - If a blank memory channel has been selected, push [V/M] to select VFO mode in advance.

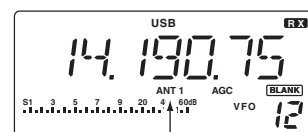

“ANT1” appears when the [ANT1] connector is in use.

## ■ CW reverse mode

CW-R (CW Reverse) mode receives CW signals with a reverse side CW carrier point like that of LSB and USB modes.

Use when interfering signals are near a desired signal and you want to change the interference tone.

- ① Push [CW/RTTY] once or twice to select CW mode.
- ② Push [CW/RTTY] for 2 sec. to toggle between CW and CW reverse (CW REV).
  - Check the interfering tone.

### • Receive audio tone response

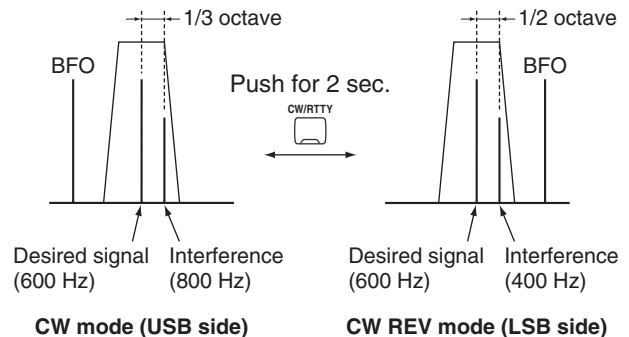

## ■ CW pitch control

The received CW audio pitch and monitored CW audio can be adjusted to suit your preferences (300 to 900 Hz) without changing the operating frequency. The received CW audio pitch can be adjusted in 10 Hz steps.

- ① Push [(ANT) SET] momentarily to enter set mode.
- ② Push [UP ▲] or [▼ DN] to select the 'CW PITCH' item.
- ③ Rotate the tuning dial to set the desired CW audio pitch.
  - CW audio pitch is displayed in 10 Hz steps. '60' indicates 600 Hz CW audio pitch.
- ④ Push [(ANT) SET] again to exit set mode.

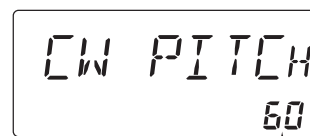

Shows a 600 Hz CW audio pitch

## ■ RTTY reverse mode

Received characters are occasionally garbled when the receive signal is reversed between MARK and SPACE. This reversal can be caused by incorrect TNC connections, settings, commands, etc.

To receive a reversed RTTY signal correctly, select RTTY reverse mode.

- ① Push [CW/RTTY] once or twice to select RTTY mode.
- ② Push [CW/RTTY] for 2 sec. to toggle between RTTY and RTTY reverse (RTTY REV).
  - Check the receive signal.

## Filter selection

The filter selection switches the IF passband width as shown in the table at right.

The filter selection is automatically memorized in each mode.

- ① Select the desired mode with the mode switches.
- ② Push [FIL] one or more times to select the desired filter combination.
  - **N** or **W** does not appear while in normal IF filter.
  - **W** appears when wide IF filters are selected.
  - **N** appears when narrow IF filters are selected.

When an optional filter is installed, set the optional filter in filter set mode. Optional filters are not selected by default.

IF	Filter	Passband width	Recommended selectivity
9 MHz	FL-100	500 Hz/-6 dB	CW-N, RTTY-N
	FL-101	250 Hz/-6 dB	CW-N
	FL-103	2.8 kHz/-6 dB	SSB-W
	FL-223	1.9 kHz/-6 dB	SSB-N
	FL-232	350 Hz/-6 dB	CW-N, RTTY-N
455 kHz	FL-52A	500 Hz/-6 dB	CW-N, RTTY-N
	FL-53A	250 Hz/-6 dB	CW-N
	FL-96	2.8 kHz/-6 dB	SSB-W
	FL-222	1.8 kHz/-6 dB	SSB-N
	FL-257	3.3 kHz/-6 dB	SSB-W

### Filter construction

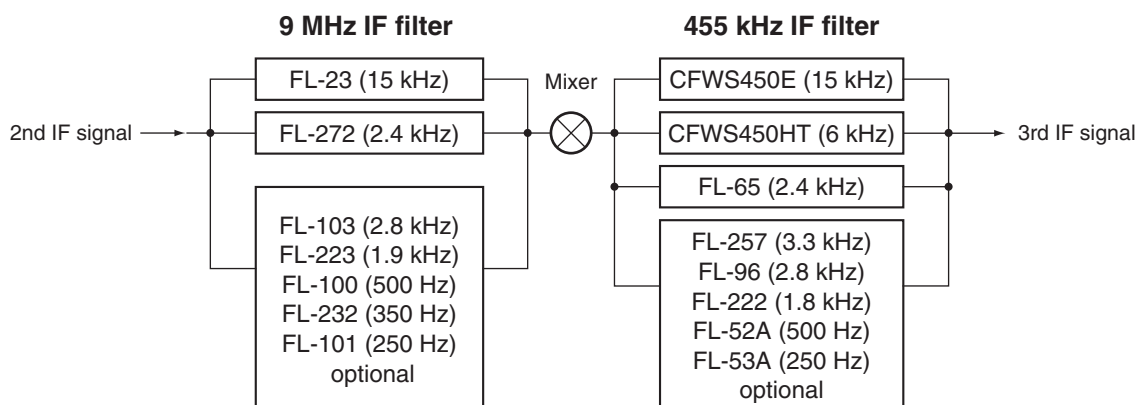

## Filter set mode

When an optional filter is installed, set the optional filters in filter set mode. Optional filters are not selected by default.

### Optional filter setting

- ① Push [FIL] for 2 sec. to enter filter set mode.
  - If a blank memory channel has been selected, push [V/M] to select VFO mode in advance.
- ② Push [UP ▲] or [▼ DN] one or more times until “oP1” appears for 9 MHz IF filter setting or “oP2” appears for 455 kHz IF filter setting.
- ③ Rotate the tuning dial to select the installed filter.
  - “No,” “100,” “101,” “103,” “223” and “232” indicate no optional filter, FL-100, FL-101, FL-103, FL-223 and FL-232, respectively for 9 MHz IF filter selection.
  - “No,” “52A,” “53A,” “96,” “222” and “257” indicate no optional filter, FL-52A, FL-53A, FL-96, FL-222 and FL-257, respectively for 455 kHz IF filter selection.
- ④ Push [FIL] to exit filter set mode.

### Wide/narrow filter setting

- ① Push [FIL] for 2 sec. to enter filter set mode.
  - If a blank memory channel has been selected, push [V/M] to select VFO mode in advance.
- ② Select the desired mode with the mode switches.
- ③ Push [UP ▲] or [▼ DN] one or more times to select the desired width 9 MHz or 455 kHz IF filter.
  - Wide or narrow mode can be deactivated when 9 MHz wide or narrow filter is set to ‘OFF.’
  - 455 kHz wide or narrow filter selection does appear when 9 MHz wide or narrow filter is set to ‘OFF.’
- ④ Rotate the tuning dial to select a filter.
- ⑤ Repeat steps ② and ④ to select IF filters for other modes, if desired.
  - The filter combinations are stored depending on operating modes.
- ⑥ Push [FIL] to exit filter set mode.

### Expanded filter selection ON/OFF

The selectable filter combinations can be expanded by setting the expanded filter selection to ON.

- ① Push [FIL] for 2 sec. to enter filter set mode.
  - If a blank memory channel has been selected, push [V/M] to select VFO mode in advance.
- ② Push [UP ▲] or [▼ DN] one or more times until “EXP” appears.
- ③ Rotate the tuning dial to turn the expanded filter selection ON/OFF.
  - If ‘ON’ is selected, the expanded filter selection can be used.
- ④ Push [FIL] to exit filter set mode.

#### •9 MHz normal filter selection



#### •455 kHz normal filter selection



#### •9 MHz narrow filter selection



#### •455 kHz narrow filter selection\*



#### •9 MHz wide filter selection

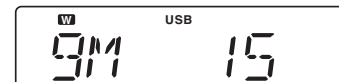

#### •455 kHz wide filter selection\*



#### •Expanded filter selection ON/OFF

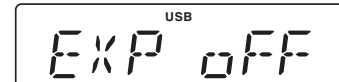

#### •9 MHz normal filter selection



#### •455 kHz normal filter selection



/// \* 455 kHz wide or narrow filter selection does appear when 9 MHz wide or narrow filter is set to ‘OFF.’

## Optional noise reduction function

optional UT-106

When an optional UT-106 is installed (DSP appears in the function display), noise reduction function can be used.

The noise reduction function reduces noise components and picks out desired signals which are buried in noise. The received AF signals are converted to digital signals and then the desired signals are separated from the noise.

- ① Push [NR] to turn the noise reduction ON.
  - [NR] indicator appears.
- ② Push [NR] for 2 sec. to enter the noise reduction level setting condition.

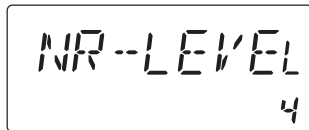

- ③ Rotate the tuning dial to adjust the noise reduction level.
- ④ Push [NR] to exit the setting condition.
- ⑤ Push [NR] again to turn the noise reduction OFF.
  - [NR] indicator disappears.

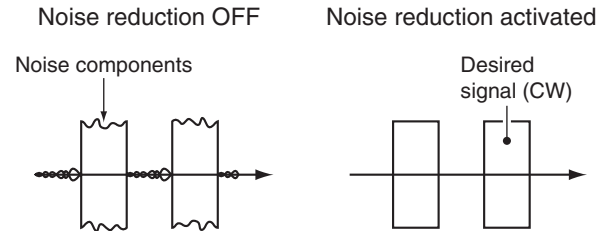

### • Noise reduction example

Higher setting of the [NR] level results in audio signal masking or distortion. Set the [NR] level for maximum clarity. The noise reduction function is available in all modes, including AM and FM modes.

## Optional auto notch function

optional UT-106

When an optional UT-106 is installed (DSP appears in the function display), an auto notch function can be used.

The function automatically attenuates more than 3 beat tones, tuning signals, etc., even if they are moving.

/// The auto notch functions in SSB mode only.

- ① Select SSB mode.
- ② Push [ANF] to turn the auto notch function ON.
  - [ANF] indicator appears.
- ③ Push [ANF] again to cancel the function.
  - [ANF] indicator disappears.

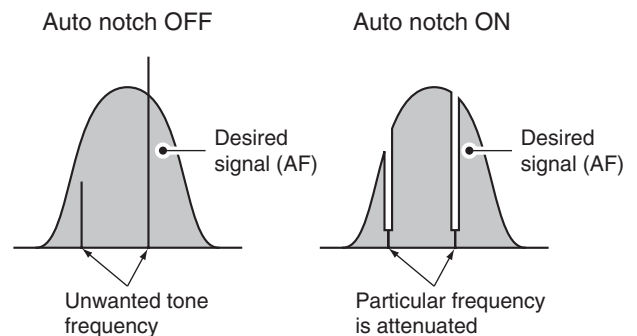



## Memory channels

The receiver has 101 memory channels. The memory mode is very useful for quickly changing to often-used frequencies.

All 101 memory channels are tuneable which means the programmed frequency can be tuned temporarily with the tuning dial, etc. in memory mode.

MEMORY CHANNEL	MEMORY CHANNEL NUMBER	CAPABILITY	TRANSFER TO VFO	OVER-WRITING	CLEAR
Regular memory channels	1–99	One frequency and one mode in each memory channel.	Yes	Yes	Yes
Scan edge memory channels	P1, P2	One frequency and one mode in each memory channel as scan edges for programmed scan.	Yes	Yes	No

## Memory channel selection

### Using the [UP ▲] or [▼ DN] keys

- Push [V/M] to select memory mode.
  - “MEMO” appears.
- Push [UP ▲] or [▼ DN] several times to select the desired memory channel.
  - Push and hold [UP ▲] or [▼ DN] for continuous selection.
- To return to VFO mode, push [V/M] again.

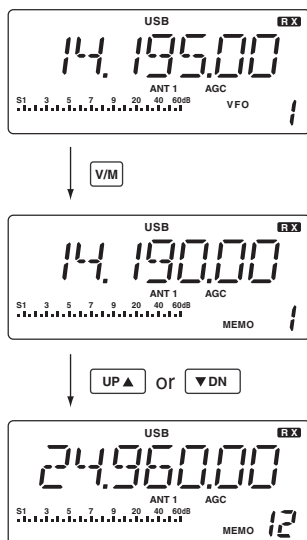

### Using the keypad

- Push [V/M] to select memory mode.
  - “MEMO” appears.
- Push the desired memory channel number using the keypad.
  - Enter 100 or 101 to select scan edge channel P1 or P2, respectively.
- Push [V/M] to select the desired memory channel.
- To return to VFO mode, push [V/M] again.

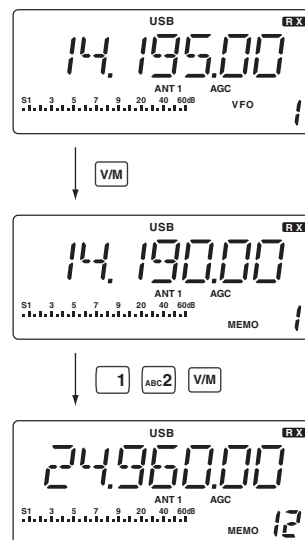

## Memory channel programming

Memory channel programming can be preformed either in VFO mode or in memory mode.

### ◇ Programming in VFO mode

- ① Set the desired frequency and operating mode in VFO mode.
- ② Push [UP ▲] or [▼ DN] several times to select the desired memory channel.
  - “BLANK” appears if the selected memory channel is a blank channel (and does not have contents).
- ③ Push [MW] for 2 sec. to program the displayed frequency and operating mode into the memory channel.
  - Preamp setting, attenuator on/off, antenna selection, and AGC setting can also be programmed into a memory channel.

[EXAMPLE]: Programming 7.088 MHz/LSB into memory channel 12.

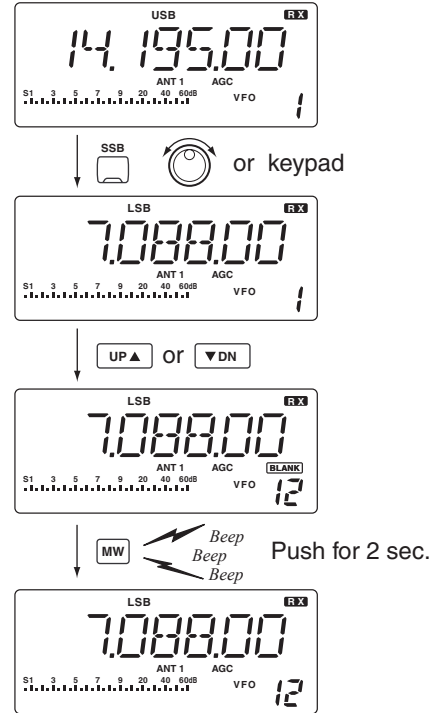

### ◇ Programming in memory mode

- ① Select the desired memory channel with [UP ▲] or [▼ DN] in memory mode.
  - “BLANK” appears if the selected memory channel is a blank channel (and does not have contents).
- ② Set the desired frequency and operating mode in memory mode.
  - To program a blank channel, use direct frequency entry with the keypad in advance.
- ③ Push [MW] for 2 sec. to program the displayed frequency and operating mode into the memory channel.
  - Preamp setting, attenuator on/off, antenna selection, and AGC setting can also be programmed into a memory channel.

[EXAMPLE]: Programming 21.280 MHz/CW into memory channel 18.

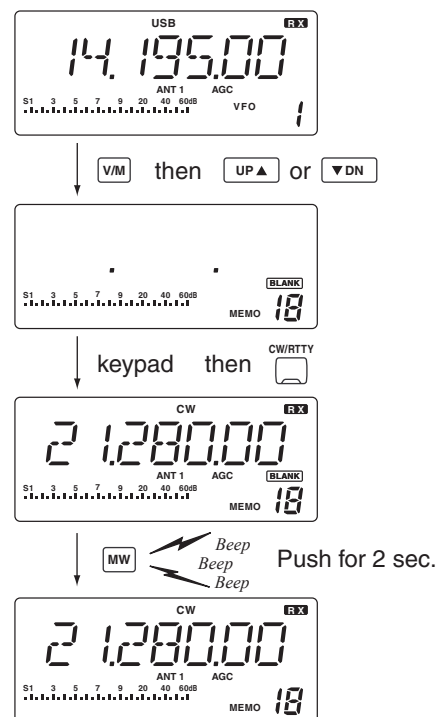

## Frequency transferring

The frequency and operating mode in a memory channel can be transferred to the VFO.

Frequency transferring can be performed in either VFO mode or memory mode.

### ◇ Transferring in VFO mode

This is useful for transferring programmed contents to VFO.

- ① Select VFO mode with [V/M].
- ② Select the memory channel to be transferred with [UP ▲] or [▼ DN].
  - “BLANK” appears if the selected memory channel is a blank channel (and does not have contents).
- ③ Push [V/M] for 2 sec. to transfer the frequency and operating mode.
  - Transferred frequency and operating mode appear on the frequency readout.

### TRANSFERRING EXAMPLE IN VFO MODE

Operating frequency : 21.320 MHz/USB (VFO)  
 Contents of M-ch 16 : 14.018 MHz/CW

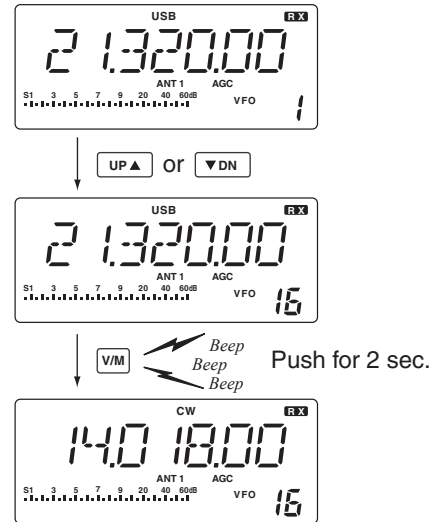

### ◇ Transferring in memory mode

This is useful for transferring frequency and operating mode while operating in memory mode.

When you have changed the frequency or operating mode in the selected memory channel:

- **Displayed** frequency and mode are transferred.
- **Programmed** frequency and mode in the memory channel are not transferred, and they remain in the memory channel.

- ① Select the memory channel to be transferred with [UP ▲] or [▼ DN] in memory mode.
  - And, set the frequency or operating mode if required.
- ② Push [V/M] for 2 sec. to transfer the frequency and operating mode.
  - Displayed frequency and operating mode are transferred to the VFO.
- ③ To return to VFO mode, push [V/M] momentarily.

### TRANSFERRING EXAMPLE IN MEMORY MODE

Operating frequency : 14.020 MHz/CW (M-ch 16)  
 Contents of M-ch 16 : 14.018 MHz/CW

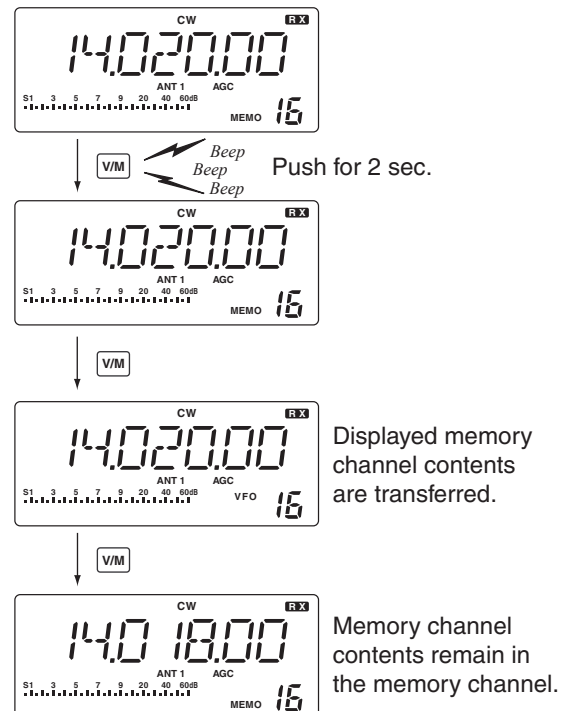

## 6 MEMORY OPERATION

### Memory names

All memory channels (including scan edges) can be tagged with alphanumeric names of up to 8 characters each.

Letters (capitals except 'o'), numerals and spaces can be used. Numerals can only be used for the 7th and 8th digits.

#### Turning memory name indication ON/OFF

- ① Select memory mode with [V/M].
- ② Push [SEL] for 2 sec. to turn memory name indication ON.
  - Frequency disappears and a memory name appears if programmed.

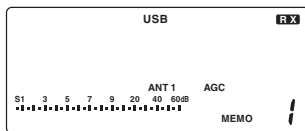

Non-named channel

- ③ Push [SEL] for 2 sec. to turn memory name indication OFF.

While the memory name indication is selected, pushing [TS] shows the operating frequency; and rotating the tuning dial while pushing [TS] changes the frequency temporarily.

#### Editing (programming) memory names

- ① Select memory mode with [V/M].
- ② Push [SEL] for 2 sec. to turn memory name indication ON.
- ③ Select the memory channel to program with [UP ▲] or [▼ DN].
  - "BLANK" appears if the selected memory channel is a blank channel (and does not have contents).

- ④ Push [ENT] to edit memory channel name.
  - A cursor appears and blinks.
  - Memory channel names of blank channels cannot be edited.

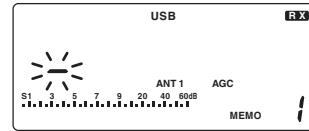

- ⑤ Input the desired character by pushing a key on the keypad one or more times.
  - [1] inputs numeral 1.
  - [2] inputs numeral 2 and letters A to C.
  - [3] inputs numeral 3 and letters D to F.
  - [4] inputs numeral 4 and letters G to I.
  - [5] inputs numeral 5 and letters J to L.
  - [6] inputs numeral 6 and letters M to O.
  - [7] inputs numeral 7 and letters P, R and S.
  - [8] inputs numeral 8 and letters T to V.
  - [9] inputs numeral 9 and letters W to Y.
  - [0] inputs numeral 0 and letters Q and Z.
  - Rotate tuning dial for cursor movement.
  - Numerals can only be used for the 7th and 8th digits.
  - Push [•] to delete the selected character and input a space.
- ⑥ Push [ENT] to input the set the name.
  - The cursor disappears.
  - Push [CLR] to abandon the settings and return to

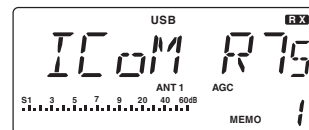

previous memory name.

- ⑦ Repeat steps ③ to ⑥ to program another memory channel's name, if desired.
- ⑧ Push [SEL] for 2 sec. to turn memory name indication OFF.

### Memory clearing

Any unnecessary memory channels can be cleared. The cleared memory channels become blank channels.

- ① Select memory mode with [V/M].
- ② Select the memory channel to be cleared with [UP ▲] or [▼ DN].
- ③ Push [CLR] for 2 sec. to clear the contents.
  - The programmed frequency and operating mode disappear.
  - "BLANK" appears.
- ④ To clear other memory channels, repeat steps ② and ③.



CLR



Push for 2 sec.

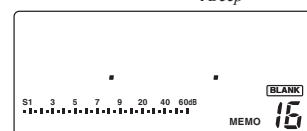

## Scan types

### PROGRAMMED SCAN/AUTO MEMORY WRITE SCAN

Repeatedly scans between two scan edge frequencies (scan edge memory channels P1 and P2). Auto memory write scan automatically memorizes paused frequencies into memory channels 80 to 99.

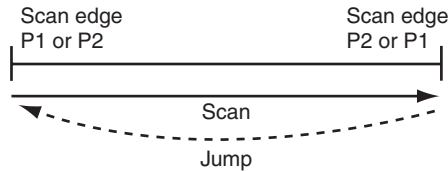

This scan operates in VFO mode.

### MEMORY SCAN

Repeatedly scans all programmed memory channels.

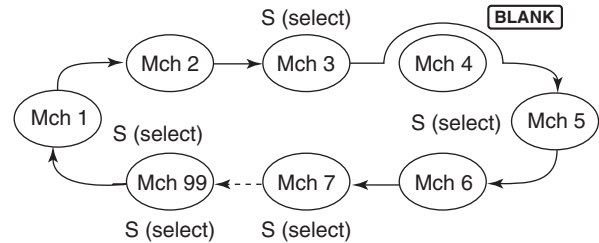

This scan operates in memory mode.

### SELECT MEMORY SCAN

Repeatedly scans all select memory channels.

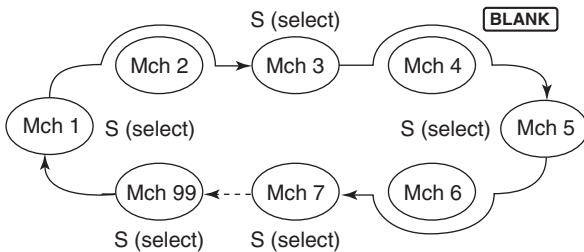

This scan operates in memory mode.

### PRIORITY WATCH

Repeatedly watches a memory channel.

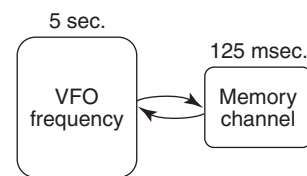

This scan operates in VFO mode.

## Preparation

### • Channels

**For programmed scan/auto memory write scan:**

Program scan edge frequencies into scan edge memory channels P1 and P2.

**For memory scan:**

Program 2 or more memory channels except scan edge memory channels.

**For select memory scan:**

Designate 2 or more memory channels as select memory channels. To designate the channel as a select memory channel, select a memory channel, then push [SEL] in the scan screen (memory mode) or in the memory channel screen.

**For priority watch:**

Program 1 or more memory channels.

### • Scan resume ON/OFF

You can select the scan to resume or cancel when detecting a signal, in set mode. Scan resume ON/OFF must be set before operating a scan. See p. 31 for ON/OFF setting and scan resume condition details.

### • Scan speed

Scan speed can be selected from 2 levels, high or low, in set mode. See p. 31 for details.

### • Squelch condition

#### ○ Scan starts with squelch open

**For programmed scan:**

*When tuning step is 1 kHz or less:*

The scan continues until it is stopped manually—it does not pause\* even if signals are detected.

\* The scan is paused when the squelch is closed and then opened (scan resumes after 10 sec. has passed when the scan resume is ON; scan is cancelled when the scan resume is OFF).

*When tuning step is more than 5 kHz:*

The scan pauses on each step when the scan resume is ON; not applicable when the scan resume is OFF.

**For memory scan:**

Scan pauses on each channel when the scan resume is ON; not applicable when the scan resume is OFF.

#### ○ Scan starts with squelch closed

Scan stops when a signal is detected.

- If the scan resume is set to ON in scan set mode, the scan pauses for 10 sec. when detecting a signal, then resumes. When a signal disappears while scan is paused, scan resumes 2 sec. later.

## Programmed scan operation

- ① Select VFO mode with [V/M].
  - ② Select the desired operating mode.
    - The operating mode can also be changed while scanning.
  - ③ Set [RF/SQL] open or closed.
    - See previous page for scan condition.
    - If the [RF/SQL] control function is set as RF control, the squelch always opens. See pgs. 14, 30 for details.
  - ④ Push [SCAN] to start the programmed scan.
    - “SCAN” appears while scanning.
  - ⑤ When the scan detects a signal, the scan stops, pauses or ignores it depending on the resume setting and the squelch condition.
  - ⑥ To cancel the scan, push [SCAN].
- ▨ If the same frequencies are programmed into the scan edge memory channel P1 and P2, programmed scan does not start.

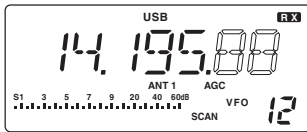

## Memory/select memory scan operation

- ① Select memory mode with [V/M].
  - ② Select the desired operating mode.
    - The operating mode can also be changed while scanning.
  - ③ Set [RF/SQL] open or closed.
    - See previous page for scan condition.
    - If the [RF/SQL] control function is set as RF control, the squelch always opens. See pgs. 14, 30 for details.
  - ④ Push [SCAN] to start the memory/select memory scan.
    - “SCAN” appears while scanning.
  - ⑤ Push [SEL] to toggle between memory scan and select memory scan.
  - ⑥ When the scan detects a signal, the scan stops, pauses or ignores it depending on the resume setting and the squelch condition.
  - ⑦ To cancel the scan, push [SCAN].
- ▨ 2 or more memory channels must be programmed for memory scan to start.

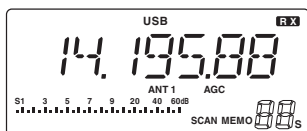

## Setting select memory channels

- ① Select memory mode with [V/M].
- ② Select the desired memory channel to set as select memory channel.
- ③ Push [SEL] to set the memory channel as a select memory or not.
  - “S” appears for select memory channels.
- ④ Repeat steps ② to ③ to program another memory channel as a select memory channel, if desired.

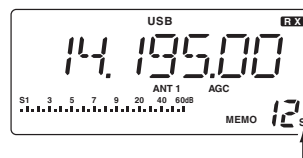

“S” appears for the select channel.

## Priority watch operation

Priority watch checks for signals on a frequency every 5 sec. while operating on a VFO frequency.

- ① Select memory mode with [V/M].
- ② Select the desired memory channel to be watched with [UP ▲] or [▼ DN].
- ③ Select VFO mode.
- ④ Set [RF/SQL] closed.
  - If the [RF/SQL] control function is set as RF control, the squelch always opens. See pgs. 14, 30 for details.
- ⑤ Push [SCAN] for 2 sec. to start priority watch.
  - “SCAN” appears.

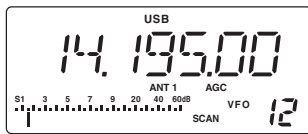

- ⑥ When a signal is received on a watch channel, the function display shows the watch channel and “SCAN” blinks.

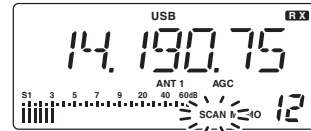

- ⑦ To cancel the watch, push [SCAN].

## Auto memory write scan

Auto memory write scan operates in the same way as programmed scan. However, when a signal is received, the received frequency is automatically written into memory channels (80 to 99).

When the auto memory write scan starts, the previously written memory channels (80 to 99) are cleared.

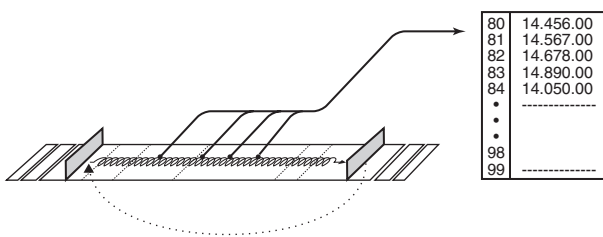

- ① Select VFO mode with [V/M].
- ② Select the desired operating mode.
  - The operating mode can also be changed while scanning.
- ③ Set [RF/SQL] closed.
  - If the [RF/SQL] control function is set as RF control, the squelch always opens. See pgs. 14, 30 for details.

- ④ Push [SCAN] to start the programmed scan.
  - “SCAN” appears while scanning.
  - If the same frequencies are programmed into the scan edge memory channel P1 and P2, programmed scan does not start.
- ⑤ Push [MW] to start the auto memory write scan.
  - “80” blinks when auto memory write scan starts.

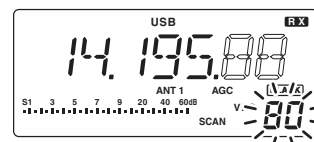

- ⑥ When the scan detects a signal, the frequency is programmed into a memory channel (80 to 99), starting from channel 80.
- ⑦ To cancel the scan, push [SCAN].

## ■ Setting the current time

The receiver has a built-in 24-hour clock with power-off and power-on timer functions. This is useful when logging SWL's, BCL's and so on.

- ① Push [CLOCK] to select clock indication mode.
  - Current time and "CL" appear.

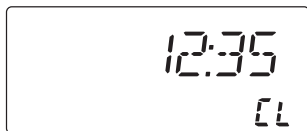

- ② Push [(ANT) SET] for 2 sec. to enter time setting condition.
  - Current time flashes.

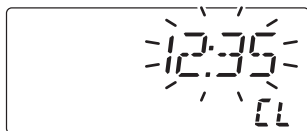

- ③ Set the current time using the tuning dial; or push keypad using 4-digit 24 hour system.

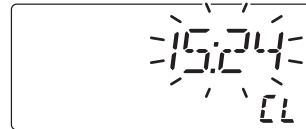

- ④ Push [ENT] to set the time.
  - Push [CLR] to cancel the setting.
- ⑤ Push [CLOCK] to exit clock indication mode.

## ■ Setting power-on time

The receiver can be set to turn ON automatically at a specified time.

- ① Push [CLOCK] to select clock indication mode.
- ② Push [UP ▲] to select power-on timer screen.
  - Power-on time and "on" appear.

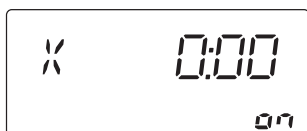

- ③ Push [(ANT) SET] for 2 sec. to enter time setting condition.
  - Power-on time flashes.
  - Push [(ANT) SET] momentarily when the power-on timer is already turned ON.

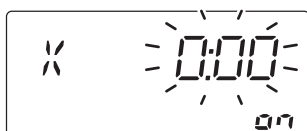

- ④ Set the desired time using the tuning dial; or push keypad using 4-digit 24 hour system.
- ⑤ Push [ENT] to set the time.
  - Power-on timer is automatically turned ON.
  - Push [CLR] to cancel the setting.

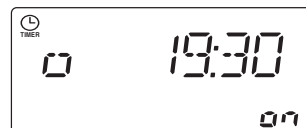

- ⑥ Push [(ANT) SET] momentarily to toggle the power-on timer ON and OFF, if necessary.
  - "o" and "X" indicates the power-on timer is turned ON and OFF, respectively.
- ⑦ Push [ENT] to exit clock indication mode.
- ⑧ Push [POWER] for 2 sec. to turn the power OFF.
  - When the set time arrives, the power is automatically turned ON.



## ■ Setting power-off time

The receiver can be set to turn OFF automatically at a specified time.

- ① Push [CLOCK] to select clock indication mode.
- ② Push [UP ▲] or [▼ DN] twice to select power-off timer screen.
  - Power-off time and “oF” appear.

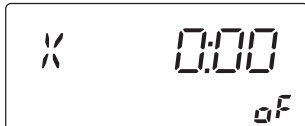

- ③ Push [(ANT) SET] for 2 sec. to enter time setting condition.
  - Power-off time flashes.
  - Push [(ANT) SET] momentarily when the power-off timer is already turned ON.

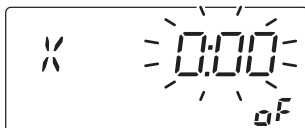

- ④ Set the desired time using the tuning dial; or push keypad using 4-digit 24 hour system.
- ⑤ Push [ENT] to set the time.
  - Power-off timer is automatically turned ON.
  - Push [CLR] to cancel the setting.

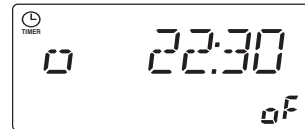

- ⑥ Push [(ANT) SET] momentarily to toggle the power-off timer ON and OFF, if necessary.
  - “o” and “X” indicates the power-off timer is turned ON and OFF, respectively.
- ⑦ Push [ENT] to exit clock indication mode.
  - When the set time arrives, the power is automatically turned OFF with 5 beeps.

## ■ Setting sleep timer period

The receiver can be set to turn OFF automatically. The power-off period can be set from 1 min. to 23 hours 59 min.

- ① Push [CLOCK] to select clock indication mode.
- ② Push [▼ DN] to select sleep timer screen.
  - Sleep timer period and “SL” appear.

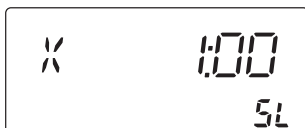

- ③ Push [(ANT) SET] for 2 sec. to enter time setting condition.
  - Sleep timer period flashes.

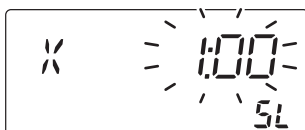

- ④ Set the desired periods using the tuning dial; or push keypad using 4-digit 24 hour system.
- ⑤ Push [ENT] to set the periods.
  - Sleep timer is automatically turned ON.
  - Push [CLR] to cancel the setting.

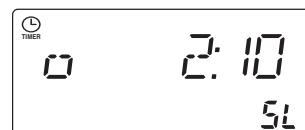

- ⑥ Push [(ANT) SET] momentarily to toggle the sleep timer ON or OFF, if necessary.
  - “o” and “X” indicates the sleep timer is turned ON and OFF, respectively.
- ⑦ Push [ENT] to exit clock indication mode.
- ⑧ The receiver emits 5 beeps and turns OFF after the sleep timer period elapses.

## ■ Set mode description

Set mode is used for programming infrequently changed values or conditions of functions.

### ◇ Set mode operation

- ① Push [(ANT) SET] to enter the set mode.
- ② Push [UP ▲] or [▼ DN] to select the desired item.
- ③ Set the desired condition using the tuning dial.
- ④ Push [(ANT) SET] to exit the set mode.

#### • RF/squelch control

The [RF/SQ] control can be set as the squelch control (default; RF gain is fixed at maximum), the RF gain control only (squelch is fixed as open) or RF/squelch control.

See p. 14 for details.

RF / SQL  
59

#### • Confirmation beep

A beep sounds each time a switch is pushed to confirm it. This function can be turned OFF for silent operation.

The volume level can be set in the next item.

BEEP  
07

#### • Beep level

This item adjusts the volume level for confirmation beep tones from 0% to 100% in 1% steps.

- The volume level is displayed in 10% steps. '5' indicates 50% volume level.

BP LVL  
5

#### • Beep level limit

This item limits the maximum volume level for confirmation beep tones.

BP LIM  
07

#### • S-meter peak hold

The peak level of the S-meter can be displayed for 0.5 sec. to confirm it easily.

P HOLD  
07

### • Scan resume

This item sets the scan resume function ON or OFF.

- “on” scan resumes 10 sec. after stopping on a signal (or 2 sec. after a signal disappears)
- “oF” scan does not resume after stopping on a signal.

See p. 25 for scanning details.

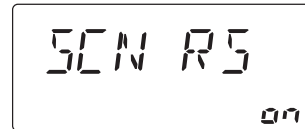

### • Scan speed

The receiver has 2 speeds for scanning, high and low.

See p. 25 for scanning details.

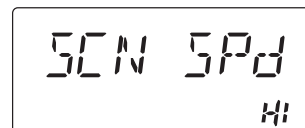

### • AM mode noise blanker

The noise blanker for AM mode can be turned ON and OFF.

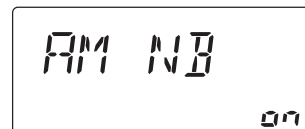

### • CW pitch control

The received CW audio pitch and monitored CW audio can be adjusted to suit your preferences (300 to 900 Hz) without changing the operating frequency.

- The CW audio pitch can be adjusted in 10 Hz steps.
- The CW audio pitch is displayed in 10 Hz steps. '60' indicates 600 Hz CW audio pitch.

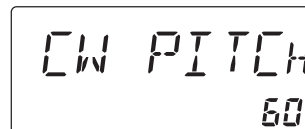

### • Blank channel indication

This item sets the blank channel indication ON or OFF.

- “on” blank memory channels are skipped and can not be selected.
- “oF” all memory channels can be selected.

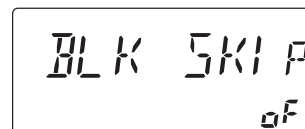

## 9 SET MODE

### • Recorder remote

This item sets the [REC REMOTE] jack function ON or OFF.



REC RM  
ON

### • CI-V address

To distinguish equipment, each CI-V transceiver or receiver has its own Icom standard address in hexadecimal code. The IC-R75's address is 5Ah.

When 2 or more IC-R75's are connected to an optional CT-17 CI-V LEVEL CONVERTER, rotate the tuning dial to select a different address for each IC-R75 in the range 01h to 7Fh.



CIV Adr  
5A

### • CI-V baud rate

This item sets the data transfer rate. "3" (300 bps), "12" (1200 bps), "48" (4800 bps), "96" (9600 bps), "HI" (19200 bps) and "At" (automatic) are available.

When "At" is selected, the baud rate is automatically set according to the connected controller or remote controller.

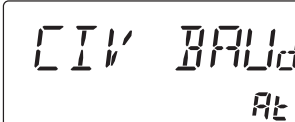

CIV BAUD  
At

### • CI-V transceive

Transceive operation is possible with the IC-R75 connected to other Icom HF transceivers or receivers.

When "on" is selected, changing the frequency, operating mode, etc. on the IC-R75 automatically changes those of connected transceivers (or receivers) and vice versa.



CIV TRn  
on

### • CI-V with IC-735

When connecting the IC-R75 to the IC-735 for transceive operation, you must change the operating frequency data length to 4 bytes.

- This item must be set to "ON" only when operating receiver with the IC-735.

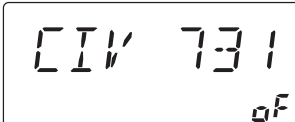

CIV 731  
on

### • Speech language

When the optional UT-102 VOICE SYNTHESIZER UNIT is installed, you can select between English and Japanese as the language.

- "En" English announcement
- "JP" Japanese announcement

See p. 34 for unit installation.

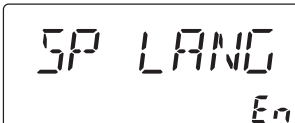

SP LANG  
En

### • Speech speed

When the optional UT-102 VOICE SYNTHESIZER UNIT is installed, you can select between faster or slower synthesizer output.

See p. 34 for unit installation.

SP SPD  
HI

### • Speech S-level

When the optional UT-102 VOICE SYNTHESIZER UNIT is installed, you can have signal level, frequency, mode and current time announcement. Signal level announcement can be deactivated if desired.

See p. 34 for unit installation.

SP MET  
ON

### • Speech current time

When the optional UT-102 VOICE SYNTHESIZER UNIT is installed, you can have signal level, frequency, mode and current time announcement. Current time announcement can be deactivated if desired.

See p. 34 for unit installation.

SP CLK  
ON

### • RTTY mark frequency

This item selects the RTTY mark frequency. RTTY mark frequency is toggled between 1275, 1615 and 2125 Hz.

TON 2 125

### • RTTY shift width

This item adjusts the RTTY shift width. There are 3 selectable values: 170, 200 and 425 Hz.

SFT 170

### • LCD backlight

This item adjusts the brightness of the LCD from 0 % to 100 % in 1 % steps.

• The brightness is displayed in 10% steps. '5' indicates 50% brightness.

BK LIGHT  
10

### • Auto tuning step

This item sets the auto tuning speed. The tuning dial normally changes the frequency 2.5 kHz/revolution in 10 Hz tuning step. When auto tuning speed is turned on this increases to 50 kHz/revolution in 50 Hz tuning step during quick rotation of the dial.

AUTO TS  
ON

# 10 OPTION INSTALLATIONS

## ■ Opening the receiver's case

Follow the case and cover opening procedures shown here when you want to install an optional unit or adjust an internal unit, etc.

**CAUTION: DISCONNECT** the DC power cable from the receiver before performing any work on the receiver. Otherwise, there is danger of electric shock and/or equipment damage.

- ① Remove the 2 screws from the left side of the receiver to remove an optional carrying handle, if necessary.
- ② Remove the 4 screws from the top of the receiver and 4 screws from the sides, then lift up the top cover.

- ③ Remove the 2 screws from the bottom of the receiver, slide the cover backward, then remove the bottom cover.

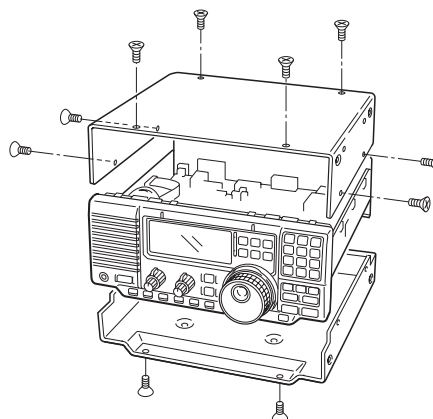

## ■ CR-282 HIGH STABILITY CRYSTAL UNIT

By installing the CR-282, the total frequency stability of the receiver will be improved.

- ① Remove the top cover as shown in the diagram above.
- ② Remove 5 screws from the PLL unit, disconnect P1 from J491 (MAIN unit), then remove the PLL unit.

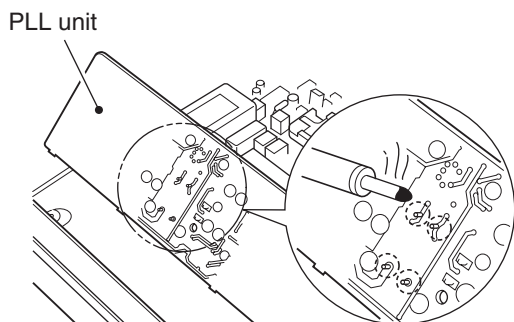

- ③ Remove the supplied internal crystal and replace with the CR-282.
- ④ Adjust the reference frequency at L2 using a frequency counter.
- ⑤ Return the PLL unit and top cover to their original positions.

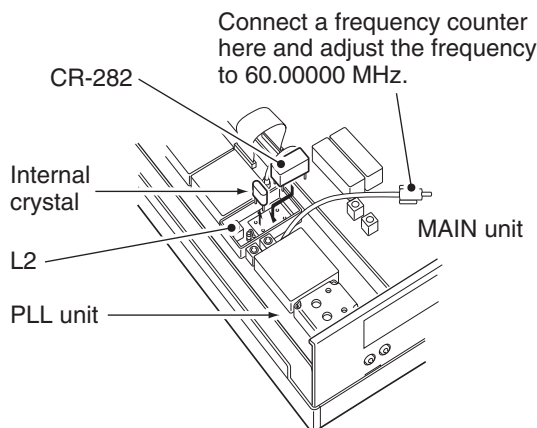

## ■ UT-102 VOICE SYNTHESIZER UNIT

The UT-102 announces the received frequency, mode, S-meter level and current time in a clear, electronically-generated voice, in English (or Japanese).

➔ Push [LOCK] for 2 sec. to announce the frequency, etc.

- ① Remove the top cover as shown above.
- ② Remove the protective paper attached to the bottom of the UT-102 to expose the adhesive strip.
- ③ Plug UT-102 into J1271 on the MAIN unit as shown at right.
- ④ Return the top cover to its original position.

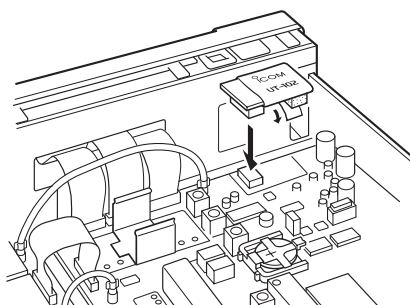

## ■ UT-106 DSP UNIT

The UT-106 provides AF DSP functions such as noise reduction and auto notch.

- ① Remove the top and bottom covers.
- ② Remove the shielding plate.
- ③ Remove the connection cable (P1241) from J1221 on the MAIN unit. Connect the cable into J1 on the UT-106.
- ④ Plug the connection cable (P1) from the UT-106 to J1221 on the MAIN unit.
- ⑤ Plug the flat cable into J3 on the UT-106 and to J1231 on the MAIN unit.
  - Take care of the conductor direction.
- ⑥ Attach the Velcro tape as shown at right. Attach the UT-106 to the reverse side of the MAIN unit.
- ⑦ Return the shielding plate, top cover and bottom cover to their original positions.

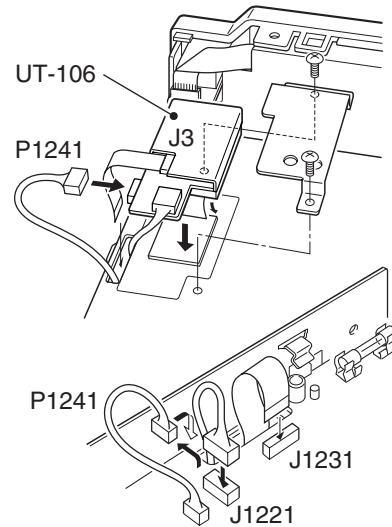

## ■ Optional IF filters

Several IF filters are available for the IC-R75. You can install 1 filter for both 9 MHz and 455 kHz IF. Choose appropriate filter for your operating needs.

### 9 MHz optional filters:

FL-101 CW NARROW FILTER	250 Hz/−6 dB
FL-232 RTTY/CW NARROW FILTER	350 Hz/−6 dB
FL-100 CW NARROW FILTER	500 Hz/−6 dB
FL-223 SSB NARROW FILTER	1.9 kHz/−6 dB
FL-103 SSB WIDE FILTER	2.8 kHz/−6 dB

### 455 kHz optional filters:

FL-53A CW NARROW FILTER	250 Hz/−6 dB
FL-52A CW/RTTY NARROW FILTER	500 Hz/−6 dB
FL-222 SSB NARROW FILTER	1.8 kHz/−6 dB
FL-96 SSB WIDE FILTER	2.8 kHz/−6 dB
FL-257 SSB WIDE FILTER	3.3 kHz/−6 dB

### ◇ Installation

- ① Remove the top cover as shown on the opposite page.
- ② Install the desired 9 MHz filter as shown in the diagram below.
  - The filters can be installed in either direction.
- ③ Install the desired 455 kHz filter as shown in the diagram below.
- ④ Replace the top cover.

▨ After filter installation, specify the installed filter using filter set mode. (p. 19) Otherwise, the installed filter will not function properly.

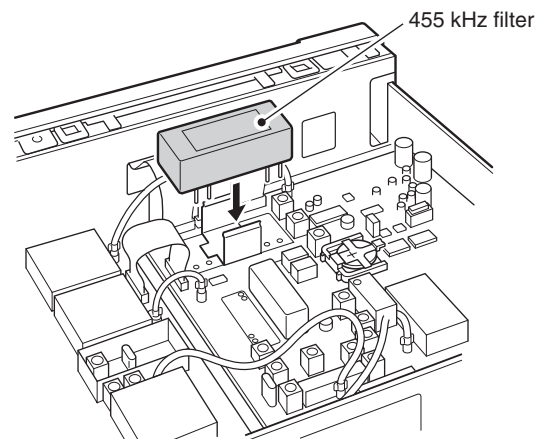
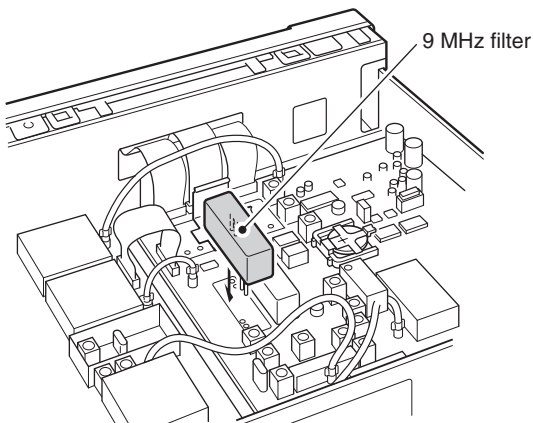

# 11 MAINTENANCE

## ■ Troubleshooting

The following chart is designed to help you correct problems which are equipment malfunctions.

If you are not able to locate the cause of a problem or solve it through the use of this chart, contact your nearest Icom Dealer or Service Center.

	PROBLEM	POSSIBLE CAUSE	SOLUTION	REF.
POWER	Power does not come on when the [POWER] switch is pushed.	<ul style="list-style-type: none"> <li>• DC power cable is improperly connected.</li> <li>• Fuse is blown.</li> </ul>	<ul style="list-style-type: none"> <li>• Reconnect the DC power cable correctly.</li> <li>• Check for the cause, then replace the fuse with a spare one. (Fuses are installed in the DC power cable and the internal MAIN unit.)</li> </ul>	— p. 37
	No sound comes from the speaker.	<ul style="list-style-type: none"> <li>• Volume level is too low.</li> <li>• The squelch is closed.</li> </ul>	<ul style="list-style-type: none"> <li>• Rotate [AF] clockwise to obtain a suitable listening level.</li> <li>• Rotate [RF/SQL] to 12 o'clock position to open the squelch.</li> </ul>	p. 2 p. 14
RECEIVE	Sensitivity is low.	<ul style="list-style-type: none"> <li>• The antenna is not connected properly.</li> <li>• The antenna for another band is selected.</li> <li>• The attenuator is activated.</li> </ul>	<ul style="list-style-type: none"> <li>• Reconnect to the antenna connector.</li> <li>• Select an antenna suitable for the operating frequency.</li> <li>• Push [ATT] to turn the function OFF.</li> </ul>	— p. 16 p. 16
	Receive audio is distorted.	<ul style="list-style-type: none"> <li>• The operating mode is not selected correctly.</li> <li>• PBT function is activated.</li> <li>• Noise blanker function is activated.</li> <li>• Preamp is activated.</li> <li>• The optional noise reduction is activated and the [NR] level is set too high.</li> </ul>	<ul style="list-style-type: none"> <li>• Select a suitable operating mode.</li> <li>• Set [TWIN PBT] to the center position.</li> <li>• Push [NB] to turn the function OFF.</li> <li>• Push [P.AMP] once or twice to turn the function OFF.</li> <li>• Push [NR] to turn the function OFF.</li> </ul>	p. 14 p. 15 p. 15 p. 16 p. 20
SCAN	Programmed scan does not stop.	<ul style="list-style-type: none"> <li>• Squelch is open.</li> <li>• [RF/SQL] is assigned to RF gain control and squelch is open.</li> </ul>	<ul style="list-style-type: none"> <li>• Set [RF/SQL] to the threshold point.</li> <li>• Reset [RF/SQL] control assignment and set it to the threshold point.</li> </ul>	p. 14 pgs. 14, 30
	Programmed scan does not start.	<ul style="list-style-type: none"> <li>• The same frequencies have been programmed in scan edge memory channels P1 and P2.</li> </ul>	<ul style="list-style-type: none"> <li>• Program different frequencies in scan edge memory channels P1 and P2.</li> </ul>	p. 22
	Memory scan does not start.	<ul style="list-style-type: none"> <li>• 2 or more memory channels have not been programmed.</li> </ul>	<ul style="list-style-type: none"> <li>• Program 2 or more memory channels.</li> </ul>	p. 22
	Select memory scan does not start.	<ul style="list-style-type: none"> <li>• 2 or more memory channels have not been designated as select channels.</li> </ul>	<ul style="list-style-type: none"> <li>• Designate 2 or more memory channels as select channels for the scan.</li> </ul>	p. 26
DISPLAY	"F.AGC" flashes in the function display.	<ul style="list-style-type: none"> <li>• A scan or band scope function is activated via an optional RS-R75 remote control software.</li> </ul>	<ul style="list-style-type: none"> <li>• If these functions are not in use, push [AGC] to deactivate the function.</li> </ul>	—
	The displayed frequency does not change properly.	<ul style="list-style-type: none"> <li>• The dial lock function is activated.</li> <li>• The internal CPU has malfunctioned.</li> </ul>	<ul style="list-style-type: none"> <li>• Push [LOCK] to deactivate the function.</li> <li>• Reset the CPU.</li> </ul>	p. 13 See below.

## ■ Resetting the CPU

Resetting CLEARS all programmed contents in memory channels and returns programmed values in set mode to their defaults.

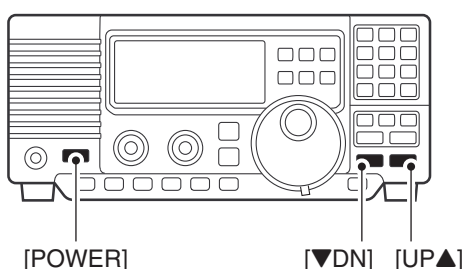

When first applying power or when the function seems to be displaying erroneous information, reset the CPU as follows:

- ① Make sure receiver power is OFF.
- ② While pushing [UP ▲] and [▼ DN], push [POWER] to turn power ON.
  - The internal CPU is reset.
  - The receiver displays its initial VFO frequencies when resetting is complete.



## ■ Fuse replacement

If a fuse blows or the receiver stops functioning, try to find the source of the problem, and replace the damaged fuse with a new, rated fuse.

**CAUTION:** DISCONNECT the DC power cable from the receiver when changing a fuse.

The IC-R75 has 2 types of fuses installed for receiver protection.

- DC power cable fuses FGB 3 A
- Circuitry fuse FGB 3 A

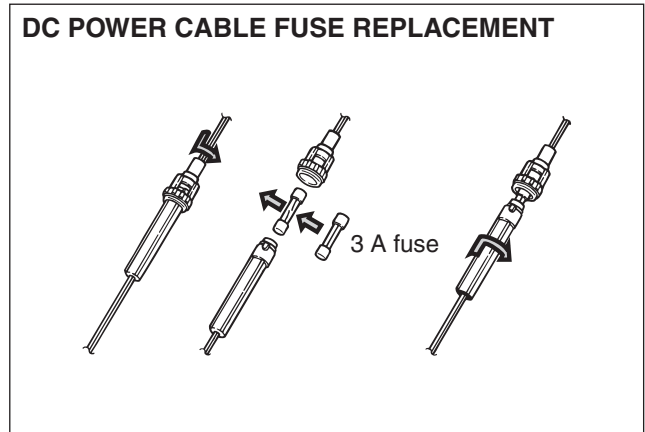

### CIRCUITRY FUSE REPLACEMENT

The 13.8 V DC from the DC power cable is applied to all units in the IC-R75 through the circuitry fuse. This fuse is installed in the MAIN unit.

- ① Remove the top cover as shown on p. 34
- ② Replace the circuitry fuse as shown in the diagram at right.
- ③ Replace the top cover.

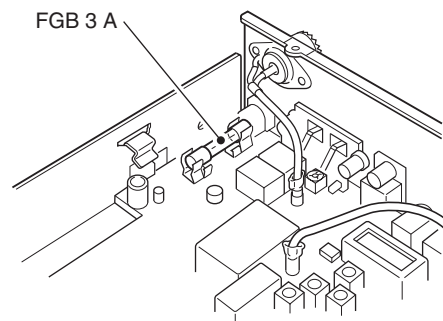

## ■ Clock backup battery replacement

The receiver has a lithium backup battery (CR2032) inside for clock and timer functions. The usual life of the backup battery is approximately 2 years.

When the backup battery is exhausted, the receiver receives normally but cannot retain the current time.

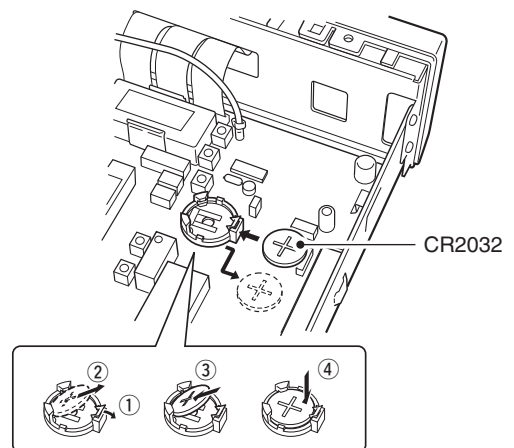

# 12 SPECIFICATIONS

## ◇ General

- Frequency coverage : 0.03–60.000000 MHz\*  
\* 0.03–29.999999 MHz only for Asia version; 0.03–29.999999 and 50.0–52.0 MHz for Denmark version; specifications guaranteed 0.1–29.99 MHz and 50–54 MHz only
- Mode : USB, LSB, CW, RTTY, AM, FM
- Number of memory channels : 101 (99 regular, 2 scan edges)
- Frequency stability : Less than  $\pm 7$  ppm from 1 min. to 60 min. after power on. After that rate of stability less than  $\pm 1$  ppm/hr. at +25 °C (+77°F). Temperature fluctuations 0°C to +50°C (+32°F to +122°F) less than  $\pm 5$  ppm.
- Power supply requirement : 13.8 V DC  $\pm 15\%$  (negative ground)
- Current drain : Standby 0.9 A  
Max. audio 1.1 A
- Antenna connector : SO-239 (50  $\Omega$ ), push connection terminal (500  $\Omega$ )
- Dimensions : 241(W) $\times$ 94(H) $\times$ 229(D) mm (projections not included) 9 $\frac{1}{2}$ (W) $\times$ 3 $\frac{1}{16}$ (H) $\times$ 9 $\frac{1}{32}$ (D) in
- Weight (approx.) : 3.0 kg; 6 lb 10 oz
- REMOTE connector : RS-232C D-sub 9-pin
- CI-V connector : 2-conductor 3.5 (d) mm ( $\frac{1}{8}$ "

## ◇ Receiver

- Receive system : Triple-conversion superheterodyne system
- Intermediate frequencies:

Mode	1st (MHz)	2nd (MHz)	3rd (kHz)
USB*/LSB*	69.0115	9.0115	455
CW*	69.0106	9.0106	455.9
RTTY*	69.0105	9.0105	456
AM*	69.0100	9.0100	450
FM	69.0115	9.0115	450

\* Frequencies differ according to the selected IF filter.

- Sensitivity :

Frequency range	SSB/CW/RTTY 10 dB S/N	AM 10 dB S/N	FM 12 dB SINAD
0.1–1.8 MHz* <sup>1</sup>	2.0 $\mu$ V	5.6 $\mu$ V	—
1.8–28 MHz* <sup>2</sup>	0.16 $\mu$ V	1.6 $\mu$ V	—
28–29.99 MHz* <sup>2</sup>	0.16 $\mu$ V	1.6 $\mu$ V	0.22 $\mu$ V
50–54 MHz* <sup>3</sup>	0.13 $\mu$ V	1.0 $\mu$ V	0.2 $\mu$ V

\*<sup>1</sup> Preamp: OFF; \*<sup>2</sup> Preamp 1: ON; \*<sup>3</sup> Preamp 2: ON

- Squelch sensitivity (threshold):  
SSB, CW, RTTY Less than 5.6  $\mu$ V\*<sup>1</sup>  
FM Less than 0.32  $\mu$ V\*<sup>2</sup>  
\*<sup>1</sup> Preamp 1: ON; \*<sup>2</sup> Preamp 2: ON
- Selectivity :  
SSB, CW, RTTY More than 2.1 kHz/–6 dB  
Less than 4.0 kHz/–60 dB  
AM More than 6 kHz/–6 dB  
Less than 20 kHz/–50 dB  
FM More than 12 kHz/–6 dB  
Less than 30 kHz/–40 dB
- Spurious and image rejection ratio:  
More than 70 dB  
(except IF through/50 MHz band)
- Audio output power : More than 2.0 W at 10% distortion with an 8  $\Omega$  load (at 13.8 V DC)
- PHONES connector : 3-conductor 6.35 (d) mm ( $\frac{1}{4}$ "
- External SP connector: 2-conductor 3.5 (d) mm ( $\frac{1}{8}$ "/8  $\Omega$

All stated specifications are typical and subject to change without notice or obligation.

## FL-100, FL-101, FL-103, FL-223 and FL-232 9 MHz FILTERS



- FL-100: 500 Hz/−6 dB (CW/RTTY nar.)
- FL-101: 250 Hz/−6 dB (CW nar.)
- FL-103: 2.8 kHz/−6 dB (SSB wide)
- FL-223: 1.9 kHz/−6 dB (SSB nar.)
- FL-232: 350 Hz/−6 dB (RTTY/CW nar.)

## FL-52A, FL-53A, FL-96, FL-222 and FL-257 455 kHz FILTERS



- FL-52A: 500 Hz/−6 dB (CW/RTTY nar.)
- FL-53A: 250 Hz/−6 dB (CW nar.)
- FL-96: 2.8 kHz/−6 dB (SSB wide)
- FL-222: 1.8 kHz/−6 dB (SSB nar.)
- FL-257: 3.3 kHz/−6 dB (SSB wide)

## MB-23 CARRYING HANDLE



Carrying handle, convenient for portable operation.

## IC-MB5 MOBILE MOUNTING BRACKET



Receiver mounting bracket for mobile operation.

## CT-17 CI-V LEVEL CONVERTER



For remote receiver control using a PC. You can change frequencies, operating mode, memory channels, etc.

## SP-21 EXTERNAL SPEAKER



Designed for base station operation.  
Input impedance: 8 Ω  
Max. input power: 5 W

## CR-282 HIGH-STABILITY CRYSTAL UNIT

Contains a temperature-compensating oven heater and crystal unit for improved frequency stability.

- Frequency stability: ±0.5 ppm

## RS-R75 REMOTE CONTROL SOFTWARE

Allows you to control the receiver from your PC (for Microsoft® Windows® 95 or Windows® 98).

\*S-AM (Synchronous AM) mode appears and can be selected on the control screen, however, the receiver will function in normal AM mode only.

## UT-102 VOICE SYNTHESIZER UNIT

Announces the receive frequency, mode, S-meter level and current time in a clear, electronically-generated voice, in English (or Japanese).

## UT-106 DSP UNIT

Provides AF DSP functions such as noise reduction and auto notch.

Approved Icom optional equipment is designed for optimal performance when used with an Icom receiver. Icom is not responsible for the destruction or damage to an Icom receiver in the event the Icom receiver is used with equipment that is not manufactured or approved by Icom.

# 14 CONTROL COMMAND

## Remote jack (CI-V) information

### CI-V connection example

The receiver can be connected through an optional CT-17 CI-V LEVEL CONVERTER to a PC equipped with an RS-232C port. The Icom Communications Interface-V (CI-V) controls the following functions of the receiver.

Up to 4 Icom CI-V transceivers or receivers can be connected to a PC equipped with an RS-232C port. See p. 32 for setting the CI-V condition using set mode.

### Data format

The CI-V system can be operated using the following data formats. Data formats differ according to command numbers. A data area or sub command is added for some commands.

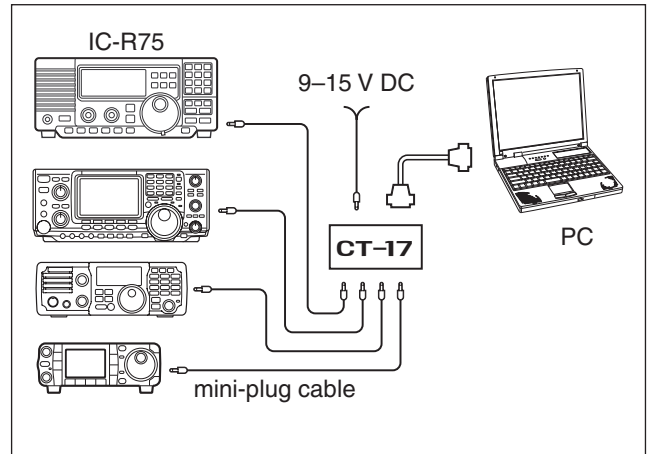

### CONTROLLER TO IC-R75

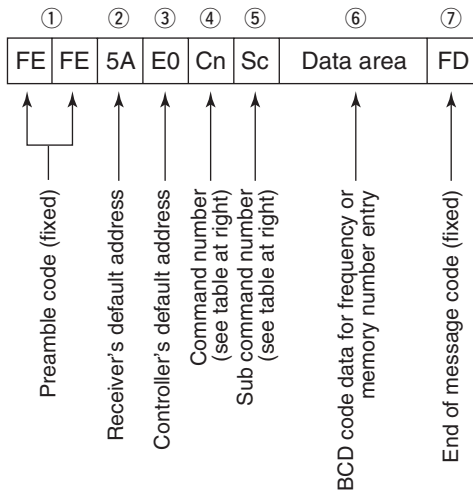

### OK MESSAGE TO CONTROLLER



### IC-R75 TO CONTROLLER

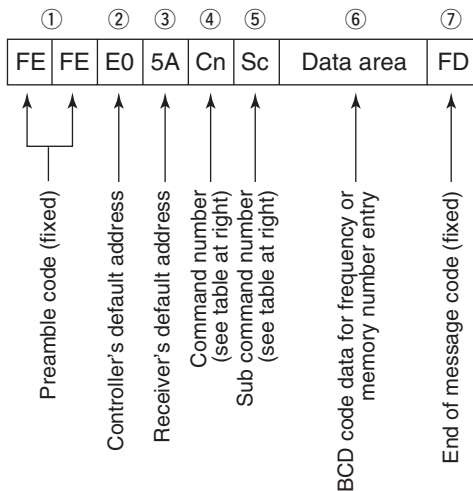

### NG MESSAGE TO CONTROLLER

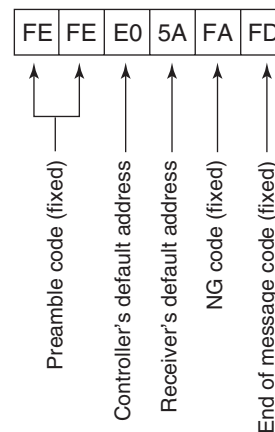

## • Command table

Command	Sub command	Description
00	—	Send frequency data
01	Same as command 06	Send mode data
02	—	Read band edge frequencies
03	—	Read operating frequency
04	Same as command 06	Read operating mode
05	—	Set frequency data
06	00* <sup>1</sup>	Set LSB
	01* <sup>1</sup>	Set USB
	02* <sup>1</sup>	Set AM
	03* <sup>1</sup>	Set CW
	04* <sup>1</sup>	Set RTTY
	05* <sup>1</sup>	Set FM
	07* <sup>1</sup>	Set CW-R
	08* <sup>1</sup>	Set RTTY-R
07	—	Select VFO mode
08	—	Select memory mode
	0001 – 0101* <sup>2</sup>	Select memory channel * <sup>2</sup> P1=0100, P2=0101
09	—	Memory write
0A	—	Memory to VFO
0B	—	Memory clear
0E	00	Scan stop
	01	Programmed/memory scan start
	02	Programmed scan start
	04	Auto memory write scan start
	22	Memory scan start
	23	Select memory scan start
	B0	Set as non-select channel
	B1	Set as select channel
10	D0	Set scan resume OFF
	D3	Set scan resume ON
	00	10 Hz (1 Hz) tuning step
	01	100 Hz tuning step
	02	1 kHz tuning step
03	5 kHz tuning step	
04	6.25 kHz tuning step	
05	9 kHz tuning step	
06	10 kHz tuning step	
07	12.5 kHz tuning step	
08	20 kHz tuning step	
09	25 kHz tuning step	
10	100 kHz tuning step	
11	1 MHz tuning step	

Command	Sub command	Description
11	00	Attenuator OFF
	20	Attenuator ON
12	00	Select [ANT1]
	01	Select [ANT2]
13	00	Announce with voice synthesizer (00=all data; 01=frequency and S-meter level; 02=receive mode)
	01	
	02	
14	01 + level data	[AF] level setting (0000=max. CCW to 0255=max. CW)
	02 + level data	[RF] level setting (0000=max. CCW to 0255=11 o'clock)
	03 + level data	[SQL] level setting (0000=11 o'clock to 0255=max. CW)
	06 + level data	[NR] level setting (0000=min. to 0255=max.)
	07 + level data	Inside [TWIN PBT] setting (0000=max. CCW, 0128=center, 0255=max. CW)
	08 + level data	Outside [TWIN PBT] setting (0000=max. CCW, 0128=center, 0255=max. CW)
	09 + level data	[CW PITCH] setting (0000=low pitch to 0255=high pitch)
15	01	Read squelch condition
	02	Read S-meter level
16	02	Set preamp (00=OFF; 01=preamp 1; 02=preamp 2)
	12	Set AGC time constant (00=OFF; 01=S-fast; 02=fast; 03=slow)
	22	Set noise blanker (00=OFF; 01=ON)
	40	Set optional noise reduction (00=OFF; 01=ON)
18	41	Set optional auto notch (00=OFF; 01=ON)
	00	Turn the receiver power ON
19	01	Turn the receiver power OFF
	00	Read the receiver ID
1A	00 + data	Send/read memory contents (See example 1 on p. 42)
	01 + data	Send/read IF filter setting (See example 2 on p. 42)
	02 + data	Send/read set mode contents (See example 3 on p. 43)

• CI-V data example 1

Reading/sending memory contents:

- ① Memory channel 39
  - ② Select memory ch select ch
  - ③ Receive frequency 12.345678 MHz
  - ④ Receive mode FM
  - ⑤ IF filter Narrow
  - ⑥ Attenuator OFF
  - ⑦ Preamp Preamp 1
  - ⑧ Antenna selection ANT1
  - ⑨ Memory name DXSPOT 1
- NOTE:** When reading data, ② – ⑨ are not required.

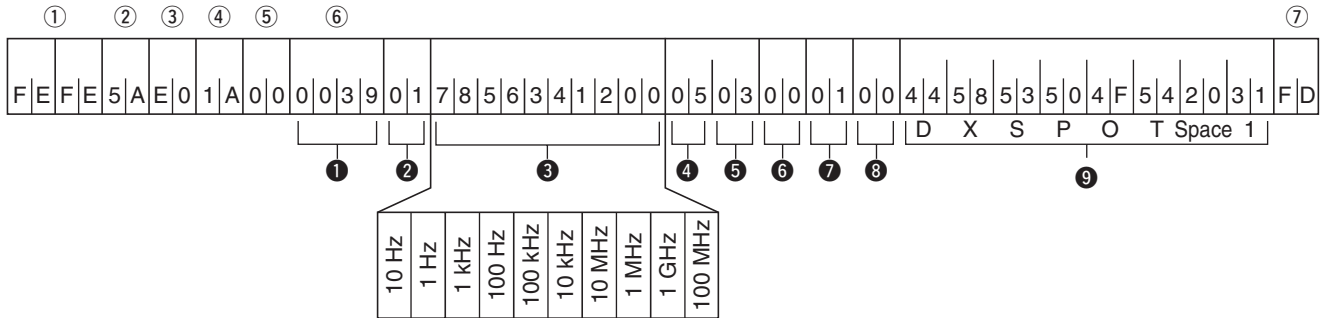

①

Data	Mch
0001	1 ch
...	...
0099	99 ch
0100	P1
0101	P2

②

Data	SEL
00	OFF
01	ON

④

Data	Mode
00	LSB
01	USB
02	AM
03	CW
04	RTTY

⑤

Data	Mode
05	FM
07	CW-R
08	RTTY-R

⑥

Data	IF filter
01	Wide
02	Normal
03	Narrow

⑦

Data	P.AMP
00	OFF
01	1
02	2

⑨ Memory name uses ASCII codes

- Space = 20h
- Numerals = 30h–39h,
- Alphabetical = 41h–5Ah (except 7th and 8th digits)
- Non-named channel = FFh

⑧

Data	ATT
00	OFF
20	ON

⑧

Data	ANT
00	1
01	2

• CI-V data example 2

Reading/sending IF filter setting:

- ① Receive mode LSB/USB
- ② 9 MHz filter Normal 2.4 kHz  
Narrow OFF  
Wide 15 kHz
- ③ 455 kHz filter Normal 6 kHz  
Narrow 2.4 kHz  
Wide 15 kHz

**NOTE:** When reading data, ② and ③ are not required.

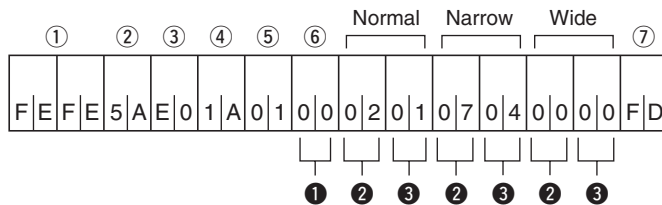

①

Data	Mode
00	LSB/USB
01	CW/CW-R
02	RTTY/RTTY-R
03	AM
05	FM

②

Data	9 MHz filter
00	15 kHz (built-in)
01	2.8 kHz (FL-103)
02	2.4 kHz (built-in)
03	1.9 kHz (FL-223)
04	500 Hz (FL-100)
05	350 Hz (FL-232)
06	250 Hz (FL-101)
07	OFF

③

Data	455 kHz filter
00	15 kHz (built-in)
01	6 kHz (built-in)
02	3.3 kHz (FL-257)
03	2.8 kHz (FL-96)
04	2.4 kHz (built-in)
05	1.8 kHz (FL-222)
06	500 Hz (FL-52A)
07	250 Hz (FL-53A)

• CI-V data example 3

Reading/sending set mode contents:

- ① Set mode number 21 (backlighting)
- ② Set data Set backlighting to a little on the brighter side (180)

NOTE: When reading data, ② is not required.

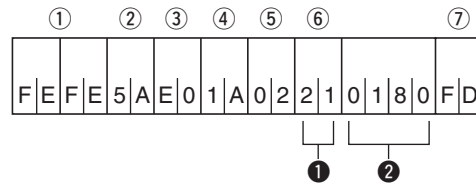

② changes depending on the set mode contents. Refer to the 'Type' in the table below.

Type 1	Type 2	Type 3	Type 4
0 1	0 1 8 0	hr. min. sec. 1 5 5 0 0 0	hr. min. 1 4 3 0

• Set mode data table

Set mode No (①)	Set mode item	Selectable value	Data range (②)	Data type (②)
01	RF/squelch control	Squech/Auto/RF gain + squelch	00/01/02	1
02	Confirmation beep	OFF/ON	00/01	1
03	Beep level	0 – 100%	0000 – 0255	2
04	Beep level limit	OFF/ON	00/01	1
05	S-meter peak hold	OFF/ON	00/01	1
06	Scan resume	OFF/ON	00/01	1
07	Scan speed	Low/high	00/01	1
08	AM mode noise blanker	OFF/ON	00/01	1
10	CW pitch control	300 Hz – 900 Hz	0300 – 0900	2
11	Blank channel indication	OFF/ON	00/01	1
12	Recorder remote	OFF/ON	00/01	1
13	CI-V transceive	OFF/ON	00/01	1
14	CI-V with IC-735	OFF/ON	00/01	1
15	Speech language	English/Japanese	00/01	1
16	Speech speed	Slower/Faster	00/01	1
17	Speech S-level	OFF/ON	00/01	1
18	Speech current time	OFF/ON	00/01	1
19	RTTY mark frequency	1275 Hz/1615 Hz/2125 Hz	00/01/02	1
20	RTTY shift width	170 Hz/200 Hz/425 Hz	00/01/02	1
21	LCD backlight	0 – 100%	0000 – 0255	2
22	Auto tuning step	OFF/ON	00/01	1
23	Expanded filter selection	OFF/ON	00/01	1
24	9 MHz optional IF filter	None/FL-100/FL-101/FL-103/FL-223/FL-232	00/01/02/03/04/05	1
25	455 kHz optional IF filter	None/FL-52A/FL-53A/FL-96/FL-222/FL-257	00/01/02/03/04/05	1
26	Memory name indication	Frequency indication/Memory name indication	00/01	1
27	Set current time	0:00:00 – 23:59:59	000000 – 235959	3
28	Power-on timer	OFF/ON	00/01	1
29	Set power-on time	0:00 – 23:59	0000 – 2359	4
30	Power-off timer	OFF/ON	00/01	1
31	Set power-off time	0:00 – 23:59	0000 – 2359	4
32	Sleep timer	OFF/ON	00/01	1
33	Set sleep time	0:01 – 23:59	0001 – 2359	4

**Count on us!**

