

144 MHz FM TRANSCEIVER
IC-T2H

This device complies with Part 15 of the FCC rules. Operation is subject to the following two conditions: (1) This device may not cause harmful interference, and (2) this device must accept any interference received, including interference that may cause undesired operation.

Icom Inc.

Photo: IC-T2H

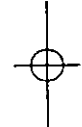

IMPORTANT

READ ALL INSTRUCTIONS carefully and completely before using the transceiver.

SAVE THIS INSTRUCTION MANUAL—This instruction manual contains important operating instructions for the IC-T2A/E/H.

EXPLICIT DEFINITIONS

The explicit definitions below apply to this instruction manual.

WORD	DEFINITION
Δ WARNING	Personal injury, fire hazard or electric shock may occur.
CAUTION	Equipment damage may occur.
NOTE	If disregarded, inconvenience only. No risk of personal injury, fire or electric shock.

CE Versions of the IC-T2E/H which display the "CE" symbol on the serial number seal, comply with the ETSI specification prEN300 684 (EMC product standard for Commercially Available Amateur Radio Equipment).

CAUTIONS

Δ WARNING! NEVER hold the transceiver so that the antenna is very close to, or touching exposed parts of the body, especially the face or eyes, while transmitting. The transceiver will perform best if the microphone is 5 to 10 cm (2 to 4 in) away from the lips and the transceiver is vertical.

Δ WARNING! NEVER operate the transceiver with a headset or other audio accessories at high volume levels. Hearing experts advise against continuous high volume operation. If you experience a ringing in your ears, reduce the volume or discontinue use.

NEVER connect the transceiver to an AC outlet or to a power source of more than 16 V DC. Such a connection will damage the transceiver.

NEVER connect the transceiver to a power source that is DC fused at more than 5 A. Accidental reverse connection will be protected by this fuse, higher fuse values will not give any protection against such accidents and the transceiver will be ruined.

NEVER attempt to charge alkaline or dry cell batteries. Be aware that external DC power connections will charge batteries inside the battery case. This will damage not only the battery case but also the transceiver.

SUPPLIED ACCESSORIES

Accessories included with the transceiver:

- ① Antenna 1
- ② Belt clip 1
- ③ Battery case (BP-194) attached to the transceiver with 8 Ni-Cd (AA) batteries* installed 1
- ④ Wall charger* 1

*Not supplied with some versions.

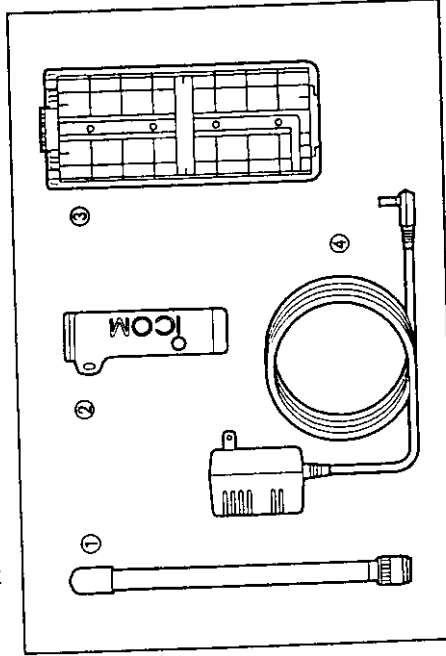

DO NOT push the PTT when not actually desiring to transmit.

Place unit in a secure place to avoid inadvertent use by children.

DO NOT operate the transceiver near unshielded electrical blasting caps or in an explosive atmosphere.

AVOID using or placing the transceiver in direct sunlight or in areas with temperatures below -10°C ($+14^{\circ}\text{F}$) or above $+60^{\circ}\text{C}$ ($+140^{\circ}\text{F}$).

The use of non-Icom battery packs/chargers may impair transceiver performance and invalidate the warranty.

Even when the transceiver power is OFF, a slight current still flows in the circuits. Remove the battery pack or case from the transceiver when not using it for a long time. Otherwise, the battery pack or installed dry cell batteries will become exhausted.

For USA only:

Caution: Changes or modifications to this transceiver, not expressly approved by Icom Inc., could void your authority to operate this transceiver under FCC regulations.

TABLE OF CONTENTS

IMPORTANT	1
EXPLICIT DEFINITIONS	1
CAUTIONS	1
SUPPLIED ACCESSORIES	ii
TABLE OF CONTENTS	iii
1 PANEL DESCRIPTION	1-5
■ Switches, controls, keys and connectors	1
■ Function display	4
2 BATTERY PACKS AND ACCESSORIES	6-9
■ Battery pack charging	6
■ Charging precautions	6
■ About battery packs	6
■ Charging connections	7
■ Installing batteries in the battery case	7
■ Accessory attachment	8
3 BASIC OPERATION	10-13
■ Power ON	10
■ Guide function	10
■ Notes for set mode	10
■ Setting a frequency	10
■ Setting tuning steps	11
■ Dial select function	11
■ Selecting a memory channel	12
■ Lock function	12
■ Receive and transmit	13
4 REPEATER OPERATION	14-16
■ General	14
■ Subaudible tones	15
■ Offset frequency	15
■ Auto repeater function	16
5 MEMORY/CALL PROGRAMMING	17-19
■ General	17
■ Programming a memory channel	17
■ Programming the call channel	18
■ Memory editing	19
6 DTMF MEMORY	20-21
■ Programming a DTMF code	20
■ Transmitting a DTMF code	20
■ DTMF transmission speed	21
7 SCAN OPERATION	22-23
■ Scan types	22
■ Programmed scan	22
■ Memory (skip) scan	23
8 SUBAUDIBLE TONE OPERATION	24-25
■ Tone squelch	24
■ Tone scan	24
■ Pocket beep operation	25
9 OTHER FUNCTIONS	26-30
■ Initial set mode	26
■ Key customize mode	26
■ Resetting the CPU	28
■ ANI mode ON	30
10 ANI OPERATION	31-33
■ General	31
■ Operation	31
11 CLOWING	34
12 TROUBLESHOOTING	35
13 SPECIFICATIONS	36
14 OPTIONS	36
15 MODE ARRANGEMENT	38-39

PANEL DESCRIPTION

■ Switches, controls, keys and connectors

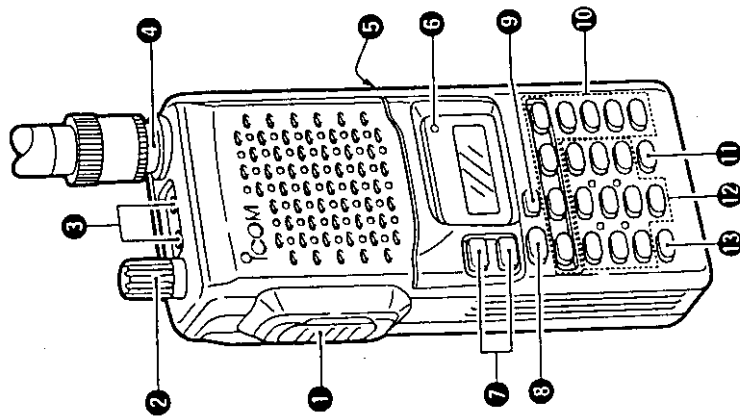

- 1 PTT SWITCH [PTT]
- 2 POWER VOLUME CONTROL [PWR/VOL]
- 3 EXTERNAL SPEAKER AND MICROPHONE JACKS [SP/MIC]
- 4 ANTENNA CONNECTOR
- 5 EXTERNAL DC POWER JACK [CHARGE]
- 6 TX INDICATOR [TX]
- 7 UP/DOWN SWITCHES [▲]/[▼]
- 8 MONITOR SWITCH [◀]
- 9 DIAL SELECT SWITCH [◀]
- 10 CUSTOMIZABLE KEYS
 IC-T2H: [SQL]/[SC]/[DUP]/[H/L]/[V]/[M]/[T]/[L]
 IC-T2A/E: [P₀]/[P₁]/[P₂]/[P₃]/[A]/[B]/[C]/[D]
- 11 GUIDE KEY [#]
- 12 DIGIT KEYS
- 13 MHz KEY [*]

1 PANEL DESCRIPTION

- **1 PTT SWITCH [PTT]** (p. 13)
Push and hold to transmit; release to receive.
- **2 POWER/VOLUME CONTROL [PWR/VOL]**
 - Rotate to turn power on and off.
 - Rotate clockwise to increase volume and counterclockwise to decrease volume.
- **3 EXTERNAL SPEAKER AND MICROPHONE JACKS [SP/MIC]**
Connect an optional speaker-microphone or headset, if desired. The internal microphone and speaker will not function when either is connected. (See p. 37 for options.)

External connection

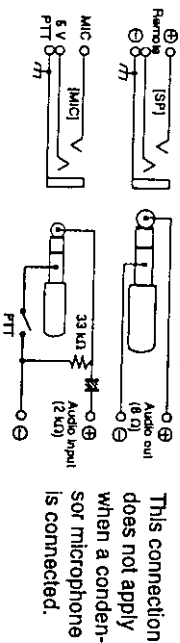

- **NOTE:** When connecting or disconnecting an external speaker-microphone, first turn off power to the transceiver.
- **4 ANTENNA CONNECTOR** (p. 9)
Connects the supplied antenna.
- **5 EXTERNAL DC POWER JACK [CHARGE]**
Connect a 13.5 to 16 V DC power source using optional cables, CP-12L or OPC-254L, to charge the transceiver, or

connect the BC-110A/DV wall charger for charging.

- ▼ **CAUTION:** This connection is for charging only. Power to the transceiver must be turned off during charging.
- **6 TX INDICATOR [TX]** (p. 13)
Lights red while transmitting.
- **7 UP/DOWN SWITCHES [▲/▼]**
 - In VFO mode, increment or decrement the displayed frequency according to the set tuning steps. (p. 11)
 - In memory mode, increment or decrement the selected memory channel. (p. 12)
 - In initial set mode, select item conditions. (p. 26)
- **8 MONITOR SWITCH [◀ (MON)]** (p. 13)
 - Push and hold this switch to force the squelch open; release to close it again.
 - Push twice to keep the squelch open; push again to close it.
 - While pushing [PTT], push this switch to transmit a 1750 Hz tone signal. (Europe version only)
- **9 DIAL SELECT SWITCH [◀] (p. 12)**
Push this switch one or more times to select the dial select step for frequency tuning.

PANEL DESCRIPTION 1

NOTE: In this manual, the customizable keys are represented by the "C" icon. Operations which require a customizable key observe the following style: Push [C] (FUNCTION) where "C" indicates the key is customizable and "FUNCTION" indicates the assigned function e.g. TONE, etc.

- ⑩ **CUSTOMIZABLE KEYS** (p. 28)
 - IC-T2A/E:** [P₀]/[P₁]/[P₂]/[P₃]/[A]/[B]/[C]/[D]
 - IC-T2H:** [SQL]/[SC]/[DUP]/[H/L]/[V]/[M]/[T]/[L]
- These keys can be assigned a variety of functions (see p. 29 for a list of available functions). Following are their default settings:
- [SQL(P₀)] Squelch level
 - [SC(P₁)] Scan start/stop
 - [DUP(P₂)] Duplex setting
 - [H/L(P₃)] Power output
 - [V(A)] VFO/memory toggle
 - [M(B)] Memory write
 - [T(C)] Tone setting
 - [L(D)] Lock function

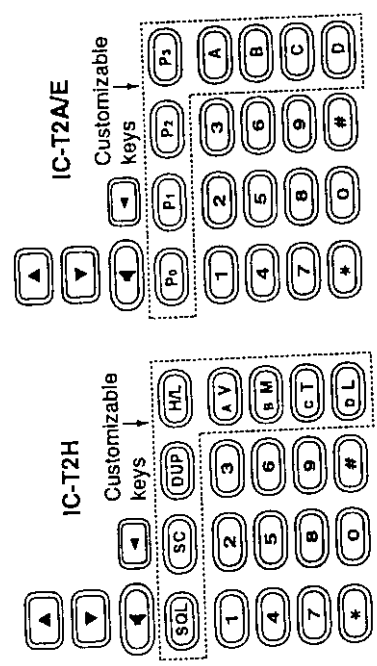

- ⑪ **GUIDE KEY [#]** (p. 10)
 - Activates the guide function.
 - Transmits an "F" for DTMF operation while pushing [PTT].
- ⑫ **DIGIT KEYS**
 - Input the specified digit during frequency input, memory channel selection, etc.
 - Transmit the DTMF code of the specified digit while pushing [PTT].
- ⑬ **MHz KEY [*]** (p. 11)
 - Used as a short cut for inputting frequencies.
 - Transmits an "E" for DTMF operation while pushing [PTT].

1 PANEL DESCRIPTION

Function display

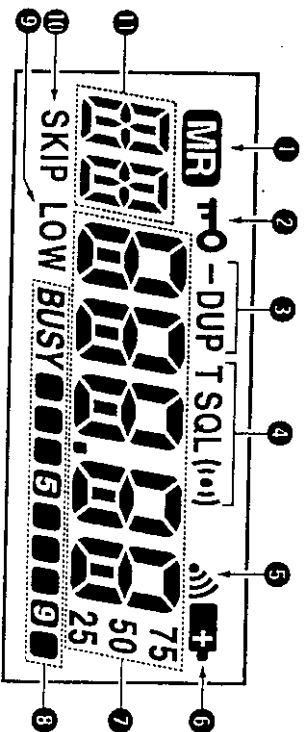

1 MEMORY MODE INDICATOR (p. 12)

Appears while in memory mode.

2 LOCK INDICATOR (p. 12)

Appears while the lock function is activated.

3 LOCK INDICATOR (p. 14)

Appears during semi-duplex operation.

*"-DUP" appears for minus duplex; "DUP" appears for plus duplex.

4 TONE INDICATORS

"T" appears when the subaudible tone encoder (p. 14) is in use; "T SQL (10)" appears during pocket beep operation (p. 25) and "T SQL" appears when the tone squelch function (p. 24) is activated.

5 ANI INDICATOR (p. 31)

Appears when the transceiver is set to ANI (Automatic Number Identification) operation mode.

6 LOW BATTERY INDICATOR

Appears when the battery is nearing exhaustion.

Appears and flashes when battery replacement is necessary.

7 FREQUENCY READOUT

In frequency indication mode, indicates the operating frequency. (p. 11)

*The smaller "75," "50" and "25" to the right of the readout indicates 7.5, 5.0 and 2.5 KHz, respectively.

In channel indication mode, indicates the selected channel. (p. 10)



PANEL DESCRIPTION 1

- In set mode or initial set mode, indicates the selected item, condition, etc.
- ⑧ **BUSY AND S/RF INDICATORS** (p. 13)
 - "BUSY" appears when receiving a signal or when the squelch is open.
 - The S/RF indicators show the relative signal strength while receiving and the output power when transmitting (2 segments appear for low power and all segments appear for high power).
- ⑨ **LOW POWER INDICATOR** (p. 13)
Appears when low output power is set.
- ⑩ **SKIP INDICATOR** (p. 23)
Appears when the selected channel is set as a "skip" channel.
- ⑪ **MEMORY CHANNEL INDICATOR** (p. 17)
Indicates the selected memory channel and other items such as the call channel.

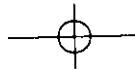



2

BATTERY PACKS AND ACCESSORIES

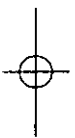

■ Battery pack charging

The supplied BP-194 BATTERY CASE includes rechargeable Ni-Cd batteries* and can be charge approx. 300 times. Charge the batteries before first operating the transceiver or when they become exhausted.

If you want to be able to charge the batteries more than 300 times, the following points should be observed:

1. Avoid overcharging. The charging period should be less than 48 hours.
2. Use the batteries until they become completely exhausted under normal conditions. We recommend battery charging just after transmitting becomes impossible.

*Not supplied with some versions.



■ Charging precautions

NEVER attempt to charge dry cell/alkaline batteries. This will cause internal liquid leakage and damage the battery case and transceiver.

NEVER connect two or more chargers at the same time.

Charging may not occur under temperatures of 10°C (50°F) or over temperatures of 40°C (104°F).



■ About battery packs

◇ Operating period

Depending on installed battery pack (batteries), the operating period of the transceiver varies. Refer to p. 37 for operating period details.

◇ Battery life

If your batteries seem to have no capacity even after being fully charged, completely discharge them by leaving the power ON overnight. Then fully charge them again.

If the batteries still do not retain a charge (or very little), new batteries must be purchased.

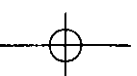

Recycling information (USA only)

The product that you purchased contains a rechargeable battery. The battery is recyclable. At the end of its useful life, under various state and local laws, it may be illegal to dispose of this battery into the municipal waste stream. Call 1-800-8-BATTERY for battery recycling options in your area or contact your dealer.

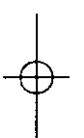

BATTERY PACKS AND ACCESSORIES 2

■ Charging connections

◇ **Regular charging**
When charging a battery case (pack) attached to the transceiver the power must be OFF.

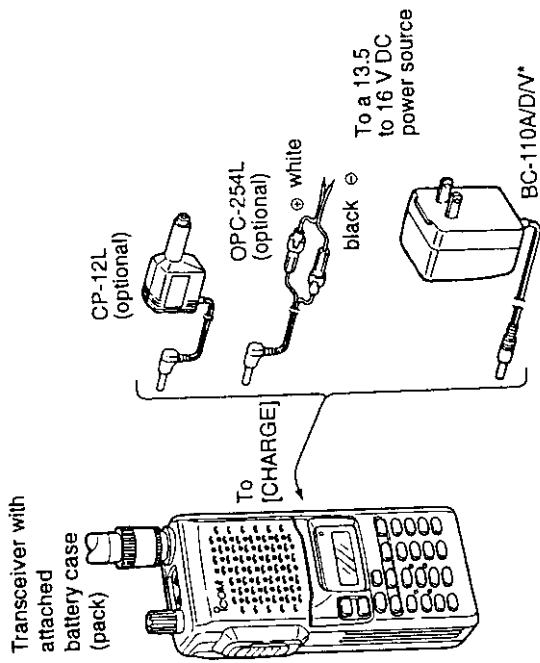

Charging periods:
15 hours (w/BP-195)
20 hours (w/BP-196)

*Not supplied with some versions.

◇ **Rapid charging with the BC-119**
The optional BC-119 provides rapid charging of optional Ni-Cd battery packs (power to the transceiver must be OFF during charging). The following are additionally required:

- AD-81
- An AC adapter (may be supplied with the BC-119 depending on version).

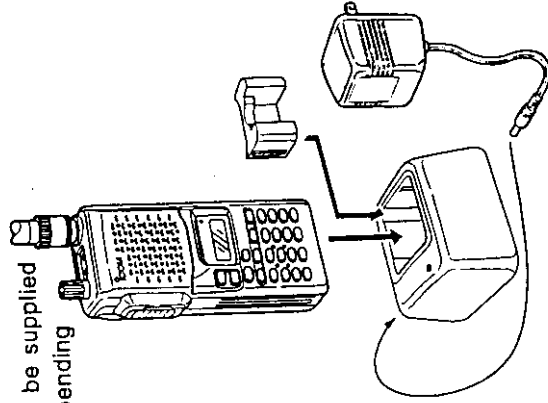

Charging periods:
1 hour (w/BP-195)
1.5 hours (w/BP-196)

2 PANEL DESCRIPTION

■ Installing batteries in the battery case

When using a battery case attached to the transceiver, install 8 AA(R6) size Ni-Cd or alkaline batteries as illustrated below.

① Remove the battery case from the transceiver.

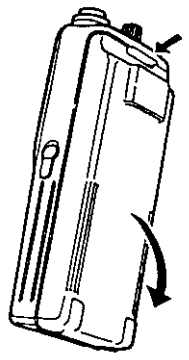

② Install 8 x R6(AA) size Ni-Cd or alkaline batteries. • Be sure to observe the correct polarity.

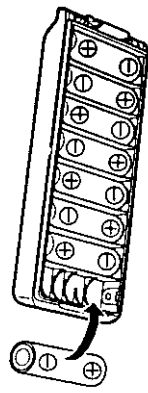

- **NEVER** connect DC power to the transceiver when installing dry cell or alkaline batteries. Such a connection will damage the transceiver.
- Be careful of battery overcharging. When operating via external DC power, installed batteries are simultaneously charged.
- Keep battery contacts clean. It's a good idea to clean battery terminals once a week.

CHAPTER CONTINUED 1

■ Accessory attachment

◇ Antenna

Connect the supplied flexible antenna to the antenna connector and rotate the antenna clockwise.

▼ CAUTION: Transmitting without an antenna may damage the transceiver.

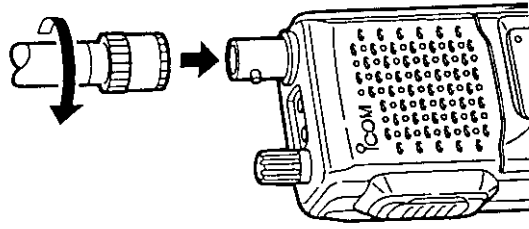

◇ Belt clip

To attach:

Slide the belt clip into the plastic loop on the back of the battery case/pack.

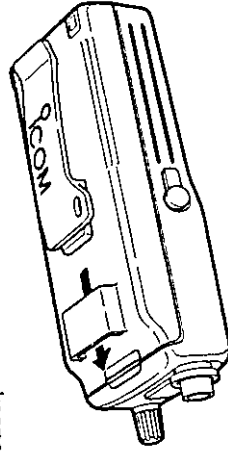

To remove:

Push the top of the belt clip towards the transceiver and at the same time, push it downwards and free of the plastic loop.

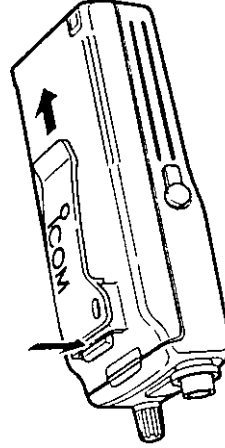



3

BASIC OPERATION

■ Power ON

Rotate [PWR/VOL] clockwise to turn power ON.

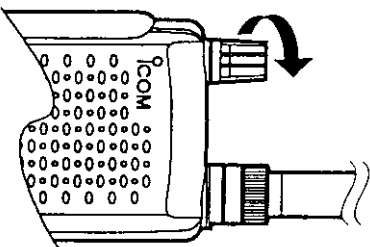

◇ Toggling frequency/channel indication mode

AT POWER ON

Channel indication mode is used to simplify operation. In this mode only pre-programmed memory channel numbers are displayed and functions are limited ([PWR/VOL], [▼ (LOCK)], [PTT], [▲], [▼ (H/L)] and [▼ (SCAN)] are functional.

To toggle between the indication modes:

While pushing [▼] + [0], rotate [PWR/VOL] to turn power ON.

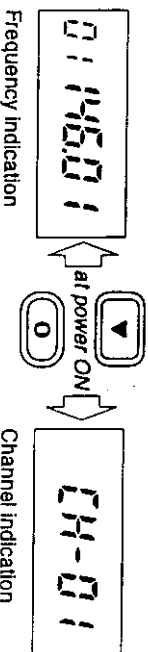

■ Guide function

The guide function displays the functions of keys and switches quickly and easily.

- ① Push [#] to activate the guide function.
 - "GUIDE" appears in the display.
- ② Push and hold the key or switch you want to know the function of.
 - The key/switch name appears and its assigned function scrolls across the display. (See p. 28 for key customize mode details.)
- ③ Release the key/switch pushed in the previous step to return to normal operation.

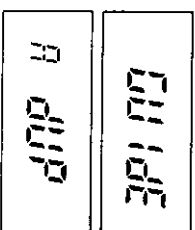

■ Notes for set mode

USING SET MODE

Set mode items: call channel (p. 18), tuning steps (p. 11), repeater tones (p. 15), offset frequency (p. 15), duplex setting (p. 15) and CTCSS tones (p. 24) can be set from VFO mode or memory mode. When setting items from memory mode, additional steps are required, otherwise input data will disappear when changing memories or turning power OFF. Please read the instructions for each set mode item carefully.

CHAPTER CONTINUED 1

Setting a frequency

- ◆ **Via the keypad**
 - ① Push [V/m] to select VFO mode, if necessary.
 - ② Push 6 digit keys, starting from the 100 MHz digit, to input a frequency.
 - Push the [*] key first to start input from the 100 kHz digit, if desired.
 - When a digit is mistakenly input, push [◀] and input from the beginning.
 - "2" and "7" are acceptable for the 1 kHz digits (depending on the 10 kHz digit).

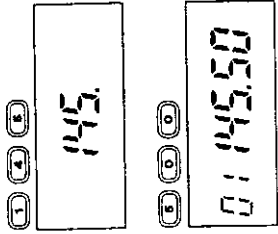

Using the [▲]/[▼] keys

Each push increments/decrements the frequency according to the selected tuning step (see right), except when the 100 kHz or 1 MHz dial select step is selected (see following page). When a dial select step is selected, each push increments/decrements the frequency either 100 kHz or 1 MHz.

Setting tuning steps

USING SET MODE

The transceiver has 8 tuning steps as follows:

5 kHz	10 kHz	12.5 kHz	15 kHz
20 kHz	25 kHz	30 kHz	50 kHz

- ① Push [V/m] or [CALL] for 1 sec. to enter set mode.
- ② Push [◀] one or more times to select the tuning step item.
- ③ Push the [▲/▼] keys to select the desired tuning step.
- ④ Push the same key used in step ③ above to enter the tuning step and exit set mode.

This display shows that a tuning step of 25 kHz is selected.

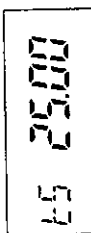

For convenience, select a tuning step that matches the frequency intervals of repeaters in your area.

NOTE:

Selecting a tuning step is possible using one of the programmable key/switches when this function is assigned using key customize mode (p. 28). In this case, pushing [TS] enters tuning step mode.

When pushing [◀] to exit set mode, any changes made while in set mode are cancelled.

3 BASIC OPERATION

■ Dial select function

Use the dial select function to adjust the tuning behaviour or the [▲]/[▼] keys—use 1 MHz tuning when you want to change the frequency in large increments; use the selected tuning step when you want to change the frequency in smaller increments.

- ① Push [▲] [▼] one or more times to select the desired [▲]/[▼] key tuning increment.
 - 1 MHz tuning, 100 kHz tuning or regular tuning steps can be selected (see diagram at right).

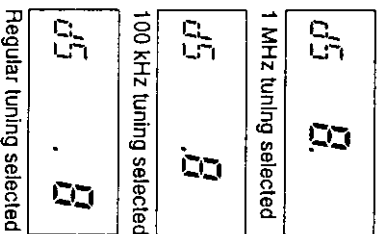

- ② Release [▲] [▼] to return to normal operation.

■ Selecting a memory channel

- ① Push [▼] (V/m) to select memory channel mode, if necessary.
 - "MEM" appears.
- ② Push 2 digit keys to select the desired memory channel (or push the [▲]/[▼] keys).
 - The first nine memory channels are preceded by a "0."
 - When you want to select scan edge channels PA or Pb, push [4], [1] or [4], [2], respectively.

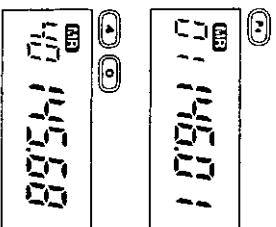

■ Lock function

The lock function prevents accidental frequency changes and accidental function activation. By default, [▼] (L) toggles this function on and off.

- Push [▼] (LOCK) for 1 sec. to toggle the function on and off.
- "LO" appears while the lock function is activated.
 - [PTT], [PWR/VOL] and [▲] can be used regardless of this setting.



BASIC OPERATION 3

Receive and transmit

- ① Rotate [PWR/VOL] clockwise to turn power ON.
- ② Adjust volume to the desired level.
 - While pushing [V], rotate [VOL].
 - ③ Set a frequency.
 - When a signal is receive:
 - ↳ Squelch opens and audio is emitted from the speaker.
 - ↳ "BUSY" appears and the S/RF indicator shows the relative signal strength.
 - ④ Push [M] (H/L) to toggle output power between high and low.
 - "LOW" appears when low output power is selected.
 - ⑤ Push and hold [PTT] to transmit; then speak into the microphone.
 - Do not hold the microphone too close to your mouth or speak too loudly. This may distort the signal.
 - The TX indicator lights red.
 - The S/RF indicator shows the output power selection.

Convenient

Monitor function: Push and hold [M] to listen to weak signals that do not open the squelch; or push [M] twice to monitor a signal without having to continuously hold [M].

Squelch control: The transceiver employs a *noise pulse count system* and therefore, squelch is adjusted automatically when "Auto" is selected for the squelch level.

Push [M] (SQL), then push [M]/[V] one or more times until "Auto" appears. Manual levels from "Sql 1" to "Sql 8" are also available to suit personal preferences and operating conditions.

4 REPEATER OPERATION

■ General

When using a repeater, the transmit frequency is shifted from the receive frequency by the offset frequency. It is convenient to program repeater information into memory channels (p. 17).

- ① Set the receive frequency (repeater output frequency).
- ② Push [▼] (DUP)] one or more times to select -DUP or DUP.
 - "-DUP" indicates the transmit frequency is shifted down; "DUP" indicates the transmit frequency is shifted up.
 - When the auto repeater function is in use (USA version only) this selection and step ③ are not necessary (p. 16).
- ③ Push [▼] (TONE)] to activate the subaudible tone encoder, according to repeater requirements.
 - "T" appears.
 - Refer to the table of subaudible tone frequencies on the following page.
- ④ Push and hold [PTT] to transmit.
 - The displayed frequency automatically changes to the transmit frequency (repeater input frequency).
 - If "OFF" appears, check the offset frequency (p. 14).
- ⑤ Release [PTT] to receive.
- ⑥ Push and hold [▲] to check whether the other station's transmit signal can be directly received or not.

◇ Tone information

Some repeaters require a tone to be accessed. In this case, precede step ④ at left with the required tone.

DTMF TONES

While pushing [PTT], push the desired digit key(s) to transmit DTMF tones.

• The transceiver has 5 DTMF memory channels. See p. 20 for details.

1750 Hz TONE

While pushing [PTT], push and hold [▲] for 1 to 2 sec. to transmit a 1750 Hz tone signal.

✓ Convenient

Tone scan function: When you don't know the subaudible tone used for a repeater, the tone scan is convenient for detecting the tone frequency.

Push and hold [▼] (T SCAN)] to activate the tone scan. See p. 25 for more details.

REPEATER OPERATION 4

■ Subaudible tones

USING SET MODE

Some repeaters require subaudible tones to be accessed. Subaudible tones are superimposed over your normal signal and must be set in advance.

- 1 Push [F] (V/m) for 1 sec. to enter set mode.

- 2 Push [L] one or more times until "RP" appears.

- 3 Push [R]/[V] to select the desired subaudible tone.

- 4 Push [F] (V/m) to enter the selected tone and exit set mode.

When set mode is selected from memory mode:

- 5 Push [F] (SmW)].

- 6 Push [F] (V/m)].

- 7 Push [F] (SmW)] for 1 sec.

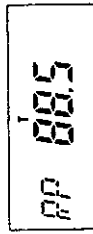

Subaudible tone of 88.5 Hz is selected.

■ Offset frequency

USING SET MODE

When communicating through a repeater, the transmit frequency is shifted from the receive frequency by an amount determined by the offset frequency.

- 1 Push [F] (V/m) for 1 sec. to enter set mode.

- 2 Push [L] one or more times until "oW" appears.

- 3 Push [R]/[V] to select the desired offset frequency.

- Selectable steps are the same as the pre-set tuning steps.

- 4 Push [F] (V/m) to enter the selected offset frequency and exit set mode.

When set mode is selected from memory mode:

- 5 Push [F] (SmW)].

- 6 Push [F] (V/m)].

- 7 Push [F] (SmW)] for 1 sec.

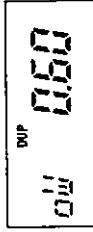

Offset frequency of 0.60 MHz is selected.

Available subaudible tone frequencies (unit: Hz)

67.0	79.7	94.8	110.9	131.8	156.7	171.3	186.2	203.5	229.1
69.3	82.5	97.4	114.8	136.5	159.8	173.8	189.9	206.5	233.6
71.9	85.4	100.0	118.8	141.3	162.2	177.3	192.8	210.7	241.8
74.4	88.5	103.5	123.0	146.2	165.5	179.9	196.6	218.1	250.3
77.0	91.5	107.2	127.3	151.4	167.9	183.5	199.5	225.7	254.1

4 REPEATER OPERATION

■ Auto repeater Using INITIAL SET MODE operation (USA version only)

The USA version automatically activates the repeater settings (duplex, ON/OFF, duplex direction, tone encoder ON/OFF) when the operating frequency falls within or outside of the general repeater output frequency range. The offset and repeater tone frequencies are not changed by the auto repeater function, reset these frequencies, if necessary.

Frequency range and offset direction

FREQUENCY RANGE	DUPLEX DIRECTION
145.200-145.495 MHz	"-DUP" appears
146.610-146.995 MHz	"DUP" appears
147.000-147.395 MHz	"DUP" appears

① While pushing [B] + [0], turn power on to enter initial set mode.

② Push [◀] one or more times until "AR" appears.

③ Push [▲/▼] to select the desired condition.

*"OFF"—the auto repeater function is turned off;

RR OFF

*"on1"—the auto repeater function activates for duplex only;

RR on1

*"on2"—the auto repeater function activates for duplex and tone.

RR on2

④ Turn power off, then on again to exit initial set mode.

MEMORY/CALL PROGRAMMING 5

■ General

The transceiver has 40 memory channels (plus 1 pair of scan edge channels and 1 call channel) for storage of often-used frequencies. In addition, the USA version has 10 marine weather channels (however, these are not programmable).

◇ Memory/call channel contents

The following information can be programmed into memory/call channels:

- Operating frequency
- Duplex direction (DUP or -DUP) with an offset frequency (pgs. 14, 15)
- Subaudible tone encoder or tone squelch on/off (pgs. 14, 24)
- Subaudible tone and tone squelch frequencies (pgs. 15, 24)
- Skip information* (p. 23)

*Except for scan edge memory channels.

■ Programming a memory channel

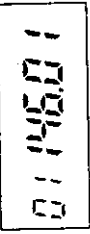
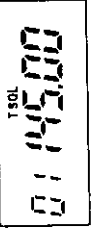
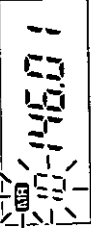
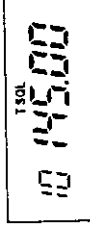
- ① Push [V/m] to select VFO mode, if necessary. 
- ② Push 6 digit keys to enter the desired frequency. 
- ③ Push [DUP], [TONE], etc. to set other information as desired. 
- ④ Push [SmW], then select a memory channel number with [▲/▼]. 
- ⑤ Push [SmW] for 1 sec. to program the information into the channel and return to VFO.

5 MEMORY/CALL PROGRAMMING

■ Programming the call channel

USING SET MODE

- ① Push [▼(CALL)] to select call channel mode.
 • "C" appears.
- ② Push [▼(CALL)] for 1 sec. to enter set mode.
- ③ Push [▲] one or more times until "FR" appears.
- ④ Push [6] digit keys to input the desired frequency.
- ⑤ If desired, push [▲] again, then push [▲/▼] to select another item (e.g. tone setting) and condition.
- ⑥ Repeat step ⑤ until all desired information is programmed into the call channel.
- ⑦ Push [▼(CALL)] to exit call channel set mode.
- ⑧ Push [▼(SwM)].
- ⑨ Push [▼(CALL)].
- ⑩ Push [▼(SwM)] for 1 sec.

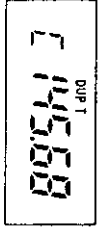

WEATHER CHANNELS (USA version only)

There are 10 weather channels for monitoring weather channels from the NOAA (National Oceanographic and Atmospheric Administration) broadcasts.



NOTE: The weather channel frequencies are out of the guaranteed frequency range (see p. 36). Intermittent reception and/or poor signal quality may occur depending on conditions.

- ① Enter key customize mode (p. 29) and assign the weather function to one of the keys, if necessary.
- ② Push [▼(WX)] to select weather channel mode.
 • "WX" and the weather channel number appear.
- ③ Push [▲/▼] to select the desired weather channel.



NOTE: Weather channels appear in frequency indication mode only.

MEMORY/CALL PROGRAMMING 5

Memory editing

Memory (call) channel contents can be moved to VFO or to another memory.

Memory/call ⇒ VFO

- ① Select the memory (call) channel to be transferred:
 - ↳ Push [▼] (V/m) ([▼] (CALL)) to select memory (call) mode.
 - ↳ Push [▲]/[▼] to select the memory (call) channel.
- ② Push [▼] (SmW) for 1 sec. to transfer the VFO contents to the selected memory.
 - VFO mode is selected.

Memory/call ⇒ memory/call

- ① Select the memory (call) channel to be transferred:
 - ↳ Push [▼] (V/m) ([▼] (CALL)) to select memory (call) mode.
 - ↳ Push [▲]/[▼] to select the memory (call) channel.
- ② Push [▼] (SmW) momentarily.
 - "VF" appears and flashes with "MEM".
- ③ Push [▲]/[▼] to select the target memory.
- ④ Push [▼] (SmW) for 1 sec.
 - VFO mode is selected and the contents are transferred to the target memory.

Clearing a memory

- ① Push [▼] (SmW) to enter memory transfer mode.
 - "MEM" and a memory channel number flash.
- ② Push [▲]/[▼] to select the memory channel to be cleared.
 - Memory channels PA, Pb and CH1 cannot be cleared.
- ③ Push [▼] (SmW) momentarily, then within 1 sec. push it again for 1 sec.
 - The contents of the selected memory are cleared.
- ④ Push [▼] to return to regular operation.



6 DTMF MEMORY

■ Programming a DTMF code

The transceiver has 5 DTMF memory channels (d1 to d5) for storage of often-used DTMF codes of up to 32 digits.

- 1 Push [▼] (DTMF) to enter DTMF memory.

- One of "d1" to "d5" appears.

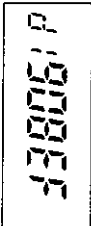

- 2 Push [▲]/[▼] to select the desired channel.

- 3 Push [▼] (DTMF) for 1 sec. to enter DTMF programming mode.

- "-----" appears.



- Programmed memories can be cleared in this way.

- 4 Push the digit keys to enter the desired DTMF code.

- A maximum of 32 digits can be input.

- If a digit is mistakenly input, push [←] then repeat from step ①.

- 5 Push [▼] (DTMF) to input the digits and exit DTMF programming mode.

- A beep sounds.

■ Transmitting a DTMF code4

◇ Using a DTMF memory channel

- 1 Push [▼] (DTMF) to enter DTMF memory mode.
- 2 Push [▲]/[▼] to select a DTMF memory channel to transmit.
- 3 Push [▼] (DTMF) to transmit the displayed DTMF memory.
 - After the DTMF code is transmitted, the transceiver automatically returns to normal operating mode.

◇ Manual DTMF code transmission

- 1 While pushing [PTT], push digit keys to transmit a DTMF code manually.
- 2 Release [PTT] to return to receive.

✓ CONVENIENT

DTMF re-dial function: This function automatically re-transmits the previously sent DTMF code. This is especially convenient when you want to re-transmit a manually transmitted DTMF code.

Push [▼] (RE-DIAL) to activate the function. See p. 29 to assign this function to a switch, if necessary.

NOTE: Once the transceiver is turned off, any temporarily memorized DTMF contents will be cleared.

DTMF MEMORY 6

■ DTMF USING INITIAL SET MODE transmission speed

When slow DTMF transmission speeds are required (as for some repeaters), the transceiver's rate of DTMF transmission can be adjusted.

① While pushing [8] + [0], turn power on to enter initial set mode.

② Push [◀] one or more times until "dt" appears.

③ Push [▲]/[▼] to select the desired DTMF transmission speed.

• Four speeds are available: "100" (100 msec. intervals) is the fastest; "500" (500 msec. intervals) is the slowest.

④ Turn power off, then on again to exit initial set mode.



Fastest

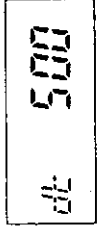

Slowest

7 SCAN OPERATION

Scan types

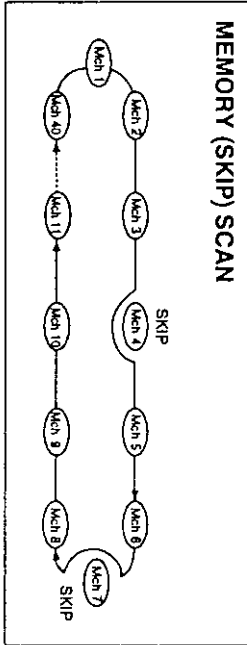
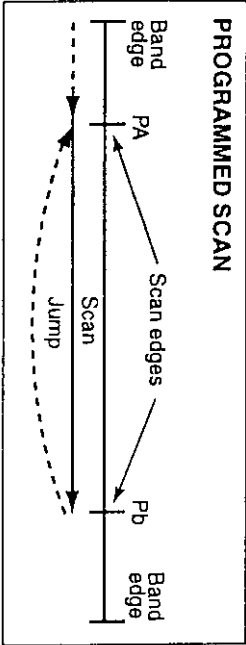

Scan resume condition USING INITIAL SET MODE

When a signal is received during scanning, the scan resume condition determines what action the transceiver takes. The IC-T2A/E/H has 2 scan resume conditions available as illustrated at right. Use initial set mode to select the one which best suits your needs.

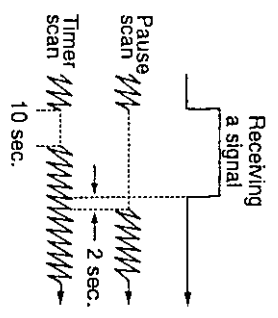

- ① While pushing [8] + [0], turn power on to enter initial set mode.
- ② Push [▲] one or more times until "SC" appears.
- ③ Push [▲]/[▼] to select the desired scan resume condition.
 - *Pause scan*: when receiving a signal, scan pauses on the signal until it disappears, then resumes.
 - *Timer scan*: when receiving a signal, scan pauses on the signal for 10 sec., then resumes.
- ④ Turn power off, then on again to exit initial set mode.

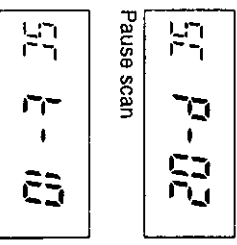

SCAN OPERATION 7

■ Programmed scan

Programmed scan repeatedly scans between two user-programmed frequencies (memory channels "PA" and "Pb"). This scan is useful for checking for signals within a specific frequency range such as repeater output frequencies, etc.

- ① Push [▼(V/m)] to select VFO mode, if necessary.
- ② Push [▼(SCAN)] to start the scan.
 - To change the scan direction, push [▲] or [▼].
- ③ Push [▼(SCAN)] again to stop the scan.

NOTE: Scan edges, PA/Pb, must be programmed in advance (program them in the same manner as regular memory channels—p. 17).

If the same frequencies are programmed into the scan edges, programmed scan will not proceed.

■ Memory (skip) scan

Memory scan repeatedly scans all programmed memory channels, except those set as skip channels.

- ① Push [▼(V/m)] to select memory mode, if necessary.
 - "MEM" appears.
- ② Push [▼(SCAN)] to start the scan.
 - To change the scan direction, push [▲] or [▼].
- ③ Push [▼(SCAN)] again to stop the scan.

◇ Setting skip channels

In order to speed up the scan interval, you can set memory channels you don't wish to scan as skip channels.

- ① Push [▼(V/m)] to select memory mode, if necessary.
 - "MEM" appears.
- ② Push [▲]/[▼] to select a memory channel to set as a skip channel.
 - "SKIP" appears.
- ③ Push [▼(SCAN)] for 1 sec. to toggle the skip setting on/off.
 - "SKIP" appears when the channels is set as a skip channel.
 - If memory scan is accidentally started, push [▼(SCAN)] to stop it.

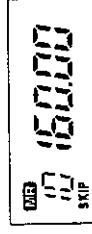

Memory channel 10 is set as a skip channel.



8

SUBAUDIBLE TONE OPERATION

■ Tone squelch

◇ Operation

The tone squelch opens only when receiving a signal containing a matching subaudible tone. You can silently wait for calls from group members using the same tone.

- ① Set the operating frequency.
- ② Set the desired subaudible tone in set mode.
 - See right for programming.
- ③ Push [▼] (TONE) one or more times until "TSQL" appears.
- ④ When the received signal includes a matching tone, squelch opens and the signal can be heard.
 - When the received signal's tone does not match, tone squelch does not open, however, the S-indicator shows signal strength.
 - To open the squelch manually, push and hold [▲].
- ⑤ Operate the transceiver in the normal way.
- ⑥ To cancel the tone squelch, push [▼] (TONE)].

NOTE: The transceiver has 50 tone frequencies and consequently their spacing is narrow compared to units having 38 tones. Therefore, some tone frequencies may receive interference from adjacent tone frequencies.

✓ CONVENIENT

Store subaudible tone frequencies and tone squelch on/off settings in memories (call) for easy recall.

◇ Setting subaudible tones for *USING SET MODE* tone squelch operation (CTCSS tones)

Separate tone frequencies can be set for tone squelch operation than for repeater operation (the same range of tones is available—see below). Like repeater tones, these are set in set mode.

- ① Select VFO or a memory channel.
- ② Push [▼] (V/m)] for 1 sec. to enter set mode.
- ③ Push [▲] one or more times until "Cr" appears.
- ④ Push [▲/▼] to select the desired subaudible tone.
- ⑤ Push [▼] (V/m)] to program the selected tone and exit set mode.

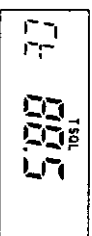

When set mode is selected from memory mode:

- ⑥ Push [▼] (SmW)].
- ⑦ Push [▼] (V/m)].
- ⑧ Push [▼] (SmW)] for 1 sec.

Available subaudible tone frequencies

67.0	79.7	94.8	110.9	131.8	156.7	171.3	186.2	203.5	229.1
69.3	82.5	97.4	114.8	136.5	159.8	173.8	189.9	206.5	233.6
71.9	85.4	100.0	118.8	141.3	162.2	177.3	192.8	210.7	241.8
74.4	88.5	103.5	123.0	146.2	165.5	179.9	196.6	218.1	250.3
77.0	91.5	107.2	127.3	151.4	167.9	183.5	199.5	225.7	254.1

(unit: Hz)

SUBAUDIBLE TONE OPERATION 8

■ Tone scan

The transceiver can detect the subaudible tone frequency in a received signal. By monitoring a signal, such as that being transmitted on a repeater input frequency, you can determine the tone frequency required to access the repeater.

- ① Set the desired frequency or memory channel to be checked for a tone frequency.
- ② Push [▼] (T SCAN) for 1 sec. to start the tone scan.
 - Push [▲]/[▼] to change the scan direction.
- ③ When the tone frequency is decoded, the set mode contents are programmed with the tone frequency.
 - The decoded tone frequency if used for the tone encoder or tone encoder/decoder, depending on the tone squelch on/off setting.
 - "Cr" (CTCSS—Continuous Tone Coded Squelch System) or "Rr" (Repeater Subaudible Tone) appears during tone scan whether the tone squelch is in use or not.
- ④ Push [▼] (T SCAN) again to stop the scan.

■ Pocket beep operation

This function uses subaudible tones for calling and can be used as a "common pager" to inform you that someone has called you while you were away from the transceiver.

- ① Set the operating frequency.
 - ② Set the desired subaudible tone (same as that used for tone squelch operation, "Cr") in set mode.
 - See previous page for programming.
 - ③ Push [▼] (TONE) two times until "TSQL (01)" appears.
 - ④ When a signal with a matched tone is received, the transceiver emits beep tones for 30 sec. and flashes "(01)".
 - ⑤ Push [PTT] to answer or push [▼] to stop the beeps and flashing.
 - Tone squelch is automatically selected.
- ◇ **Calling a waiting station using pocket beep**
 A subaudible tone matched with the station's tone frequency is necessary. Use the tone squelch on the previous page or subaudible tone encoder (p. 14).

9 OTHER FUNCTIONS

Initial set mode

AT POWER ON

Initial set mode is accessed at power on and allows you to set seldom-changed settings. In this way you can "customize" transceiver operations to suit your preferences and operating style.

Entering initial set mode

- ① While pushing [8] + [0], rotate [PWR] to turn power on.
 - The transceiver enters initial set mode and "mS Simp" or "mS noRm" (see right) is displayed.
- ② Push [◀] one or more times to select the desired display as described on the following pages.
- ③ Push [▲]/[▼] to select the desired condition.
- ④ Turn power off, then on again to exit initial set mode and select the previous operating mode.

Message

When no operation is performed for 5 sec. in initial set mode, a message scrolls across the function display prompting you for input.

Message example

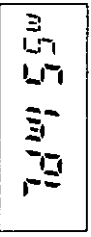

for microphone simple mode



Optional HM-75A functions

This item turns the microphone simple mode on or off. Microphone simple mode is used to change the function assignments for switches on the optional HM-75A REMOTE CONTROL MICROPHONE as below. This assignment is convenient for 3-channel use of simple operation.

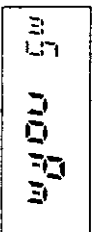

	NORMAL			SIMPLE			HM-75A SWITCH
	Freq. Indication	CH Indication	ANI	Freq. Indication	CH Indication	ANI	
[CALL]	NULL	NULL	NULL	[▲]	[▲]	[▲]*	Q A
[M]	NULL	NULL	NULL	[CALL]	NULL	NULL	B
[UP]	[UP]	[UP]	[UP]	MCH01	MCH01	MCH01	▽ A
[DOWN]	[DOWN]	[DOWN]	[DOWN]	MCH02	MCH02	MCH02	▽ B

NOTE:

Turn power off when connecting the HM-75A to the transceiver.

VFO mode cannot be selected via the microphone when SIMPLE mode is selected.

OTHER FUNCTIONS 9

◇ Auto power OFF

This item allows you to set a time at which the transceiver will automatically turn OFF. The power OFF time can be set to 20, 40, 60 min. or turned off.

PO off

PO 60

◇ Display backlighting

When set to AUTO, display backlighting automatically turns on when a key is pushed; when set to OFF display backlighting cannot be turned ON; when set to ON display backlighting remains ON continuously.

L1 off

L1 AUTO

L1 on

◇ Beep tones ON/OFF

Confirmation beep tones normally sound when you push a key or switch. These can be turned ON or OFF as you prefer.

bE on

bE off

• When [BEEP] is assigned to one of the keys (see p. 29), push this key to toggle beep tones on/off without using Initial set mode.

◇ Power saver

This item sets the power saver duty cycle—the ratio of receive circuit on to receive circuit off while standing by. The duty cycle can be set to automatic, 1:4 or OFF. Setting to automatic conserves the most battery power.

P5 AUTO

P5 1:4

AUTO	Selects "1:4" duty ratio when receiving no signal for 5 sec, then "1:8" 60 sec. after that.
1:4	Standby : 125 msec. Circuit idle : 500 msec.
OFF	No power saver function.

9 OTHER FUNCTIONS

◇ DTMF speed (see p. 21)

◇ Function display contrast

This item sets the function display contrast to one of two levels—"1" is low contrast and "2" is high contrast.

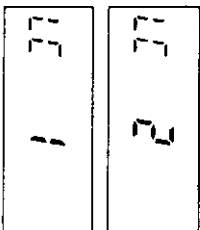

◇ Scan resume condition (see p. 22)

◇ Active memory channels

This item allows you to adjust the number of active memory channels. Selectable values are 10, 20, 30 or 40.

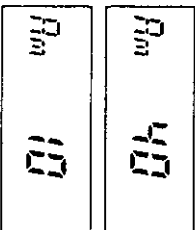

■ Key customize mode AT POWER ON

The functions of the P0, P1, P2, P3, A, B, C and D keys on the IC-T2H can be customized to suit your operating needs.

- ① While pushing [#] + [0], turn power on to enter key customize mode.
 - "CUSTOM" appears.
- ② Push the key you wish to program.
 - The key's currently programmed function appears and scrolls across the display.
- ③ Push the [▲/▼] keys to select the function you wish to assign to the key.
 - See the chart opposite for assignable functions.
- ④ Push the same key as in step ② for 1 sec. to assign the function to the key.
 - If this step is not performed, the key will retain its previous function.
- ⑤ Push another key to be programmed, if desired; or, turn power off, then on again to exit key customize mode.

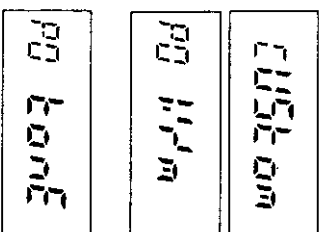

*1The DTMF memory function can only be assigned to [P0]–[P3].

*2Weather channels are only available in the USA version.

*3ANI code setting only appears when ANI operation is selected through cloning (p. 34).

OTHER FUNCTIONS 9

ASSIGNABLE FUNCTIONS	DISPLAY READOUT	DESCRIPTION
NULL	NULL	No function.
Backlight	LIGHT	Toggles display backlighting on/off.
Power output	HIGH/LO	Toggles high and low power output.
Scan start/stop	SCAN	Starts and stops the scan function.
DTMF memory*1	dtmf	Selects a DTMF memory.
DTMF re-dial	dtmf RE-dIAL	Redials the last-used DTMF code.
Lock function	KEYBOARD LOCK	Toggles the lock function on/off.
Beep tones	BEEP	Toggles confirmation beep tones on/off.
VFO/memory	VFO	Toggles between VFO and memory modes.
Tone setting	tone	Toggles tone squelch operation on/off.
Tone scan	tone dECode SCAN	Starts/stops tone scan.
Tuning step	ts	Selects a tuning step for frequency selection.
Squelch level	SQ LEVEL	Selects a squelch level.
WX channels*2	WX CH	Selects a weather channel.
ANI code*3	Ani Code	Selects an ANI code.
Duplex setting	dUP	Selects +duplex, -duplex or simplex operation.
Memory write	SMW	Writes the selected frequency into a memory.
Call channel	CALL CH	Selects the call channel.
Shift	SHIFT	Shifts the CPU's clock frequency.

9 OTHER FUNCTIONS

Resetting the CPU

AT POWER ON

Reset the CPU before operating the transceiver for the first time, or when the internal CPU malfunctions.

- While pushing [(V)A] + [(T)C], turn power on to reset the transceiver.
- "CLEAR" appears briefly to indicate the CPU has been reset.

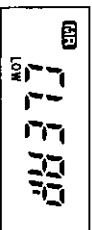

CAUTION: Resetting the CPU returns all programmed contents to their default settings.

ANI mode ON

ANI (Automatic Number Identification) mode can only be turned ON using the optional CS-T2 CLONING SOFTWARE. Consult the HELP file in the CS-T2 CLONING SOFTWARE for details. If ANI mode is already on, resetting the CPU (see above) effectively turns ANI mode off.

ANI OPERATION 10

■ General

The ANI (Automatic Number Identification) function is a method of selective calling which features an answer back function. This allows you to confirm whether or not a call has reached the receiving party even if the operator is temporarily away from the transceiver.

In order to use the IC-T2A/E/H's ANI function, cloning is necessary via a PC using the optional CS-T2 CLONING SOFTWARE. Using this software, the transceiver's individual ANI code, group codes, ANI time-out timer and other settings related to ANI operation can be set. Refer to the Read Me file that comes with the CS-T2 CLONING SOFTWARE for available settings.

Once ANI mode is programmed, the transceiver cannot use frequency or channel display mode unless it is reprogrammed from a PC using the CS-T2 CLONING SOFTWARE or the CPU is reset (see previous page).

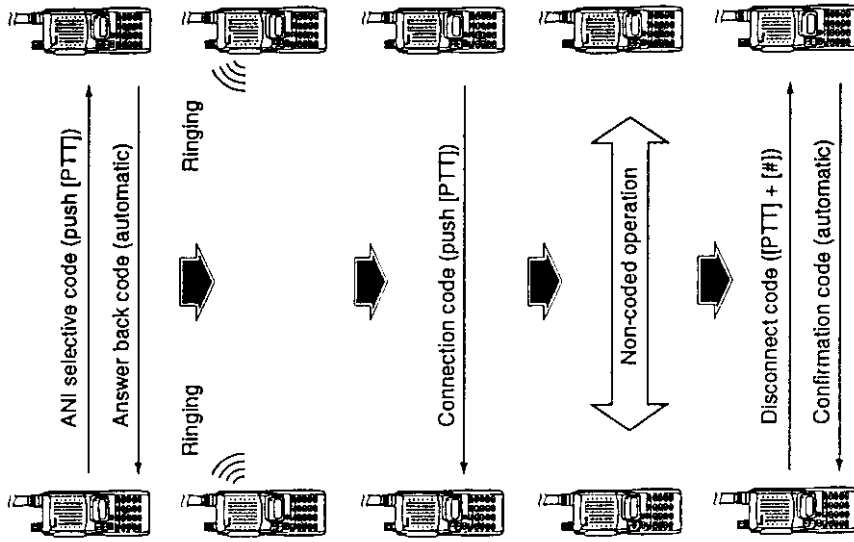

10 ANI OPERATION

■ Operation

◇ Calling a specific station

- ① Turn power on and set the [VOL] control to the 10 or 12 o'clock position.
- ② Push the [▲]/[▼] keys to set the desired channel.
 - " " appears when the ANI function has been programmed via cloning.
- ③ Push [PTT] once to connect to the selected station or enter a 3-digit ANI code, if required (in this case it is not necessary to push [PTT]—transmit is automatic after entry of the 3rd digit).
 - The transceiver transmit the pre-programmed selective code.
- ④ When the transceiver rings (an answer back is received), wait for a connection code from the connected station; when the transceiver doesn't ring, push [PTT] again to exit the standby condition, then try again from step ③ after waiting awhile.
- ⑤ When the connection code is received, a beep sounds, then " " flashes; when the connection code is not received within 10 sec., the transceiver transmits a disconnect code automatically (" " does not flash). Try again from step ③ after waiting awhile, in such a case.
- ⑥ When " " flashes, you can converse with the connected station.
 - Push to transmit; release to receive.
- ⑦ When your conversation is finished, transmit the disconnect code manually.

nect code.

- While pushing [PTT], push [#].
- Some transceivers cannot transmit a disconnect code depending on programming.

NOTE: When your conversation extends into the ANI timeout time, the transceiver transmits a disconnect code automatically.

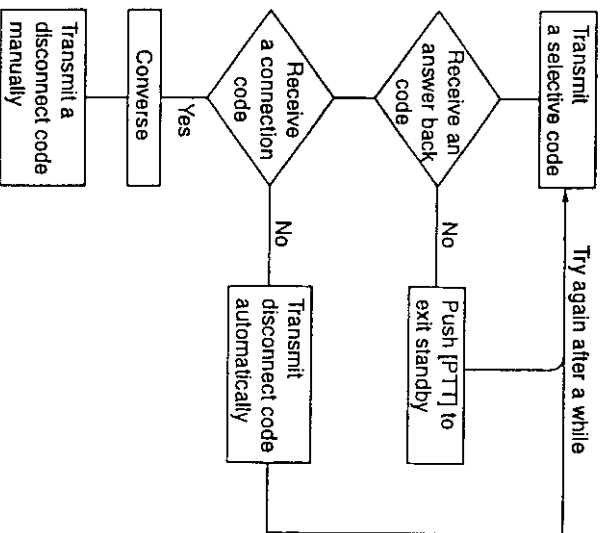

ANI OPERATION 10

◇ Calling group stations

- ① Turn power on, then select the desired group channel.
- ② Enter the 3-digit ANI code including the group code "D"—the transceiver calls the desired station automatically.
 - The transceiver transmits the pre-programmed selective code.
 - When entering a 3-digit code, the transceiver automatically transmits a group code after the 3rd digit is entered.
 - When making group calls the transceiver does not ring and no answer back connection code is received.
 - You can make an announcement to your group immediately without a connection procedure.
- ③ Push [PTT] in the regular way to communicate.
- ④ When your conversation is finished, while pushing [PTT], push [#] to transmit a disconnect code.

◇ Group call code examples

[Example 1]

If "11D" is transmitted, transceivers with receive codes "110" to "119" are called.

[Example 2]

If "1D3" is transmitted, transceivers with receive codes "103," "113," ... "183" and "193" are called.

/// **NOTE:** "DDD" transmits to all transceivers.

◇ Waiting for a call

- ① Turn power on, then select the desired channel.
 - The transceiver may be programmed to start a scan at power on.
- ② When you receive a selective call, the transceiver "rings."
 - Push [ANI CODE] to display the receive code.
- ③ Push [PTT] to send a connection code within 10 sec.
- ④ While "㊦" flashes, converse with the connected station.
- ⑤ When your conversation is finished, you may receive a disconnect code.
 - Transmitting a disconnect code from your side (push [PTT] + [#]) is also possible (except for group call receive).
 - "㊦" stops flashing.

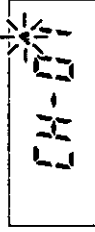
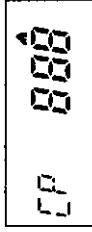
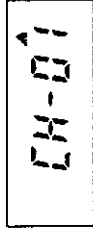



11 CLONING

Cloning allows you to quickly and easily transfer the programmed contents from one transceiver to another transceiver; or, data from a PC to a transceiver using the optional CS-T2 CLONING SOFTWARE.

◇ Transceiver-to-transceiver AT POWER ON cloning

- ① Connect the OPC-474 CLONING CABLE with adapter plugs to the [SP] jack of the master and slave transceivers.
- The master transceiver is used to send data to the slave transceiver.

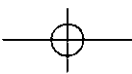

- ② While pushing [(H/L)Pa] + [▲], turn power on to enter cloning mode (master transceiver only—power on only for slave transceiver).

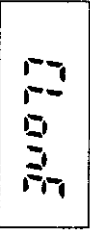

- "Clone" appears and the transceivers enter the clone standby condition.
- ③ Push [PTT] on the master transceiver.

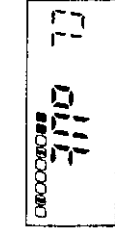

• "CLOUT" appears in the master transceiver's display and the S/RF indicator shows that data is being transferred to the slave transceiver.



• "CL In" appears automatically in the slave transceiver's display and the S/RF indicator shows that data is being received from the master transceiver.

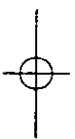

- ④ When cloning is finished, turn power off, then on again to exit cloning mode.

◇ Cloning using a PC

Data can be cloned to and from a PC (IBM compatible) using the optional CS-T2 CLONING SOFTWARE and the optional OPC-478 CLONING CABLE. The software is necessary to access the IC-T2A/E/H's ANI mode. Consult the CS-T2 CLONING SOFTWARE HELP message for details.

◇ Cloning error

NOTE: DO NOT push the [PTT] on the slave transceiver during cloning. This will cause a cloning error.

When the display at right appears, a cloning error has occurred.

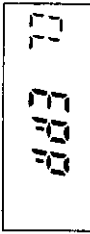

In such a case, both transceivers automatically return to clone standby condition and cloning must be repeated.

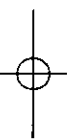
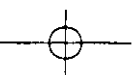

TROUBLESHOOTING 12

If your transceiver seems to be malfunctioning, please check the following points before sending it to a service center.

PROBLEM	POSSIBLE CAUSE	SOLUTION	REF.
No power comes on.	<ul style="list-style-type: none"> The battery is exhausted. (A slight current flows in the circuits even when the power is off.) 	<ul style="list-style-type: none"> Charge the battery pack or place new dry cell batteries in the battery case. (Remove the battery pack if you will not be using the transceiver for a long time.) 	pgs. 7, 8
Transmitting is impossible.	<ul style="list-style-type: none"> The battery is exhausted. 	<ul style="list-style-type: none"> Charge the batteries or place new dry cells in the battery case. 	pgs. 7, 8
Frequency cannot be set.	<ul style="list-style-type: none"> Memory mode, call channel or channel indication mode is selected. The lock function is activated. 	<ul style="list-style-type: none"> Push [▼] (V/m) to select VFO mode; or, turn power on while pushing [▲] + [0] to exit channel indication. Set [▼] (LOCK) down to deactivate the lock function. 	pgs. 11, 10 p. 12
Scan does not function.	<ul style="list-style-type: none"> The same frequencies are programmed into both scan edges. Only CH1 is programmed; or, all other memory channels are set as skip channels. 	<ul style="list-style-type: none"> Program different frequencies. 	p. 17
[▲] or [▼] keys do not function when using the optional HM-75A.	<ul style="list-style-type: none"> Memory channels 1 and/or 2 are not programmed and simple mode is selected. 	<ul style="list-style-type: none"> Program additional memories; or, cancel skip settings for one or more channels. 	p. 23
Squelch does not open for received signals.	<ul style="list-style-type: none"> Tone squelch is activated. 	<ul style="list-style-type: none"> Program the memory channels or set to microphone normal. 	pgs. 17, 26
Some memory channels cannot be selected.	<ul style="list-style-type: none"> Some memories have been cleared or the number of active memories has been reduced. 	<ul style="list-style-type: none"> Turn off the tone squelch. 	p. 24
ANI mode cannot be accessed.	<ul style="list-style-type: none"> ANI mode can only be accessed through cloning. 	<ul style="list-style-type: none"> Program the cleared memories or increase the number of active memory channels. 	pgs. 17, 28
Some functions are not available.	<ul style="list-style-type: none"> The desired function(s) has not been assigned to a key. 	<ul style="list-style-type: none"> Set ANI operation using the CS-T2 CLONING SOFTWARE. Set the desired function(s) using Key Customize mode. 	p. 34 p. 28

13 SPECIFICATIONS

GENERAL

• Frequency coverage

(Unit: MHz)

USA	TX	144-148
	RX	136-174
Asia		136-174*
Italy	TX	144-148
	RX	136-174*
Eur., Kor., UK		144-146
Taiwan		145-146

* Guaranteed range: 144-148 MHz

: F2/F3

: ± 10 ppm (0°C to 50°C; 32°F to 122°F)

: 50 Ω (nominal)

: 9.6 V DC (Ni-Cd x 8, negative ground)

: :

1.4 A (IC-T2A/E at 4.5 W; typ.)

1.6 A (IC-T2H at 6 W; typ.)

150 mA (IC-T2A/E; typ.)

210 mA (IC-T2H; typ.)

25 mA (typ.)

65 mA (IC-T2A/E; typ.)

80 mA (IC-T2H; typ.)

: :

16 ch/sec.

10 ch/sec.

: -10°C to +60°C; +14°F to +140°F

: 58(W) \times 140.5(H) \times 32.3(D) mm;

2 $\frac{3}{32}$ (W) \times 5 $\frac{17}{32}$ (H) \times 1 $\frac{9}{32}$ (D) in

• Weight
(incl. 8 Ni-Cd cells and antenna)

: 420 g; 14.8 oz

TRANSMITTER

• Modulation system

• Output power (at 9.6 V DC)

: Variable reactance modulation
: HI 6 W (IC-T2H typ.: 144-148 MHz)
4.5 W (IC-T2A/E typ.: 144-148 MHz)

Lo 1 W (typ.: 144-148 MHz)

• Max. frequency deviation

• Spurious emissions

• Ext. microphone connector

: ± 5 KHz
: Less than -60 dB
: 3-conductor 2.5(d) mm ($\frac{1}{8}$ " \approx); 2 k Ω

RECEIVER

• Receive system

• Intermediate frequencies

• Sensitivity

• Squelch sensitivity

• Spurious and image rejection

• Audio output power

(at 9.6 V DC)

• Ext. speaker connector

• Ext. speaker connector

• Ext. speaker connector

• Ext. speaker connector

• Ext. speaker connector

• Ext. speaker connector

• Ext. speaker connector

• Ext. speaker connector

• Ext. speaker connector

• Ext. speaker connector

• Ext. speaker connector

• Ext. speaker connector

• Ext. speaker connector

• Ext. speaker connector

• Ext. speaker connector

• Ext. speaker connector

OPTIONS 14

◇ Battery packs

BATTERY PACK	VOLTAGE	CAPACITY	OUTPUT POWER*1	OPERATING PERIOD*2
BP-194	Battery case for R6(AA)×8 alkaline or Ni-Cd cells	800 mAh	4.5/6.0 W	3.5 h/3.7 h*3
BP-195	9.6 V	700 mAh	4.5/6.0 W	3.5 h/3.7 h
BP-196	9.6 V	1050 mAh	4.5/6.0 W	3.5 h/5.5 h

*1IC-T2A/E: 4.5 W; IC-T2H: 6.0 W.

*2Operating ranges are calculated under the following conditions:
Tx : Rx : standby=1 : 1 : 8

*3When Ni-Cd batteries are installed.

◇ Chargers and cables

BC-110A/DV WALL CHARGER

Regularly charge battery packs attached to the transceiver in 15 to 20 hrs.

BC-119 DESKTOP CHARGER + AD-81 BATTERY PACK ADAPTER

Rapidly charge battery packs in 1 to 1.5 hrs. depending on the battery pack. An AC adapter is packed with the BC-119. The AD-81 must be used with the BC-119 for charging the battery pack. The CP-17L or OPC-515L can be used instead of the supplied AC adapter.

CP-12L CIGARETTE LIGHTER CABLE WITH NOISE FILTER

For charging via a 12 V cigarette lighter socket.

OPC-254L DC POWER CABLE

For charging via an external power supply.

◇ Speaker-microphones



HM-46

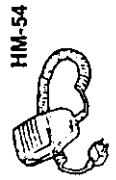

HM-54



HM-75A



HS-51 HEADSET

- PTT switch
- VOX
- One-touch PTT for hands-free operation

Remote control capability (see p. 00 for details)

◇ Others

CS-T2 CLONING SOFTWARE

Allows you to clone the memory contents of an IC-T2A/E/H transceiver between transceivers or to a PC for editing.

OPC-474 CLONING CABLE

For transceiver-to-transceiver cloning.

OPC-478 CLONING CABLE

For transceiver-to-PC cloning.

LC-145 CARRYING CASE

SP-13 EARPHONE

Provides clear receive audio in noisy environments.

15 MODE ARRANGEMENT

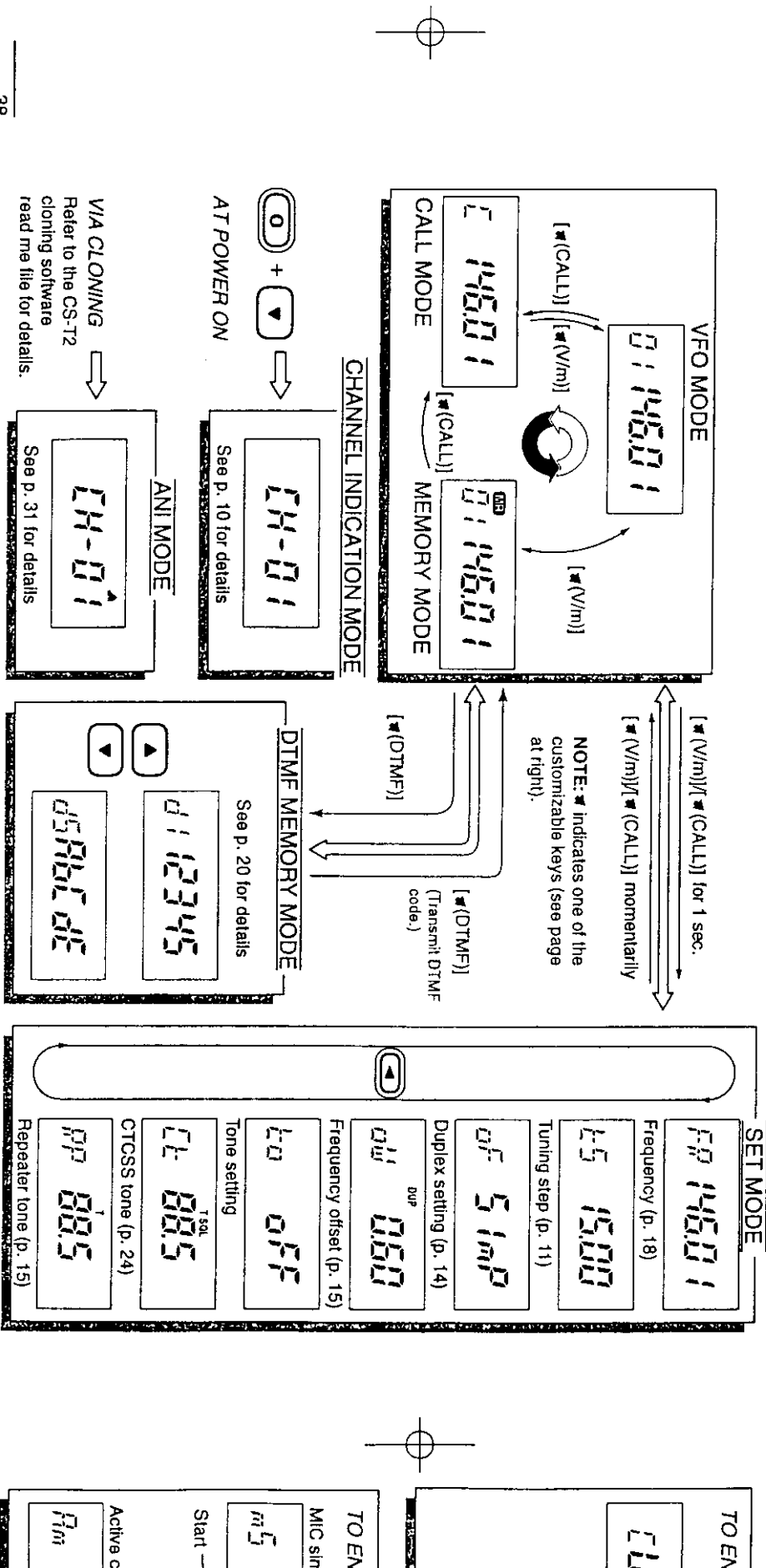

MODE ARRANGEMENT 15

KEY CUSTOMIZE MODE Power OFF then ON TO EXIT

TO ENTER **#** + **0** at power ON

cust on

① Push a key to program—currently assigned function is displayed.
 ② Push the **[▲/▼]** keys to select the desired function. (See p. 29 for a list of available functions.)
 ③ Push the selected key for 1 sec. to program the function.

KEY	DEFAULT SETTING	KEY	DEFAULT SETTING
P ₀ (SQL)	Squelch level [SQL]	A (V)	VFO/memory selection [V/m]
P ₁ (SC)	Scan start/stop [SCAN]	B (M)	Memory write [S.mW]
P ₂ (DUP)	Duplex setting [DUP]	C (T)	Tone setting [TONE]
P ₃ (HL)	Hi/low power output [HI/LO]	D (L)	Keypad lock [LOCK]

INITIAL SET MODE Power OFF then ON TO EXIT

TO ENTER **8** + **0** at power ON

MIC simple mode (p. 26) **mS norm**

Auto power OFF (p. 27) **PO off**

Beep tones (p. 27) **BE on**

Auto repeater (p. 16) **AP off**

U.S.A. version only

LCD backlight (p. 27) **L1 Auto**

DTMF speed (p. 21) **dt 100**

Power saver (p. 27) **PS 14**

Start **▶**

Active channels (p. 28) **Am 40**

Scan resume (p. 22) **SC P-02**

LCD contrast (p. 28) **LC 2**

Count on us!

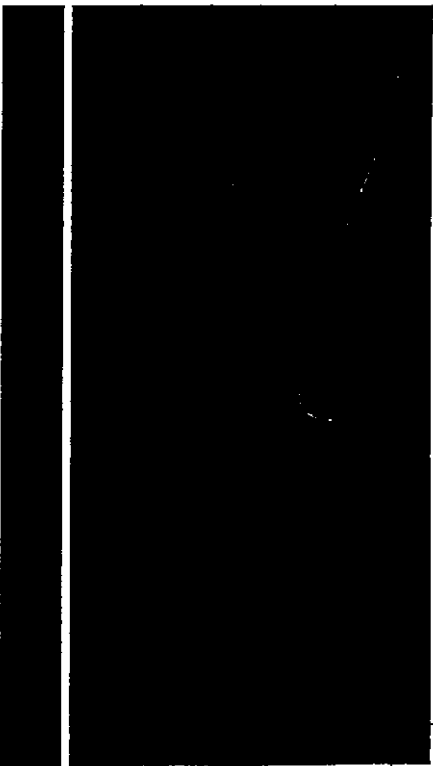

A-5427KA-1EX
Printed in Japan
© 1998 Icom Inc.

Icom Inc.
6-9-16 Kamihigashi, Hirano-ku, Osaka 547-0002 Japan