

MULTIBAND FM TRANSCEIVER
IC-T81A/E

This device complies with Part 15 of the FCC rules. Operation is subject to the following two conditions: (1) This device may not cause harmful interference, and (2) this device must accept any interference received, including interference that may cause undesired operation.

Icom Inc.

IMPORTANT

READ ALL INSTRUCTIONS carefully and completely before using the transceiver.

SAVE THIS INSTRUCTION MANUAL—This instruction manual contains important operating instructions for the IC-T81A/E.

EXPLICIT DEFINITIONS

The explicit definitions below apply to this instruction manual.

WORD	DEFINITION
⚠WARNING	Personal injury, fire hazard or electric shock may occur.
CAUTION	Equipment damage may occur.
NOTE	If disregarded, inconvenience only. No risk of personal injury, fire or electric shock.



Versions of the IC-T81A/E which display the “CE” symbol on the serial number seal, comply with the ETSI specification ETS300 684 (EMC product standard for Commercially Available Amateur Radio Equipment).

CAUTIONS

⚠WARNING! NEVER hold the transceiver so that the antenna is very close to, or touching exposed parts of the body, especially the face or eyes, while transmitting. The transceiver will perform best if the microphone is 5 to 10 cm (2 to 4 in) away from the lips and the transceiver is vertical.

⚠WARNING! NEVER operate the transceiver with a headset or other audio accessories at high volume levels. Hearing experts advise against continuous high volume operation. If you experience a ringing in your ears, reduce the volume or discontinue use.

NEVER connect the transceiver to an AC outlet or to a power source of more than 16 V DC. Such a connection will damage the transceiver.

NEVER connect the transceiver to a power source that is DC fused at more than 5 A. Accidental reverse connection will be protected by this fuse, higher fuse values will not give any protection against such accidents and the transceiver will be ruined.

NEVER attempt to charge alkaline or dry cell batteries. Beware that external DC power connections will charge batteries inside the battery case. This will damage not only the battery case but also the transceiver.

DO NOT push the PTT when not actually desiring to transmit.

Place unit in a secure place to avoid inadvertent use by children.

DO NOT operate the transceiver near unshielded electrical blasting caps or in an explosive atmosphere.

AVOID using or placing the transceiver in direct sunlight or in areas with temperatures below -10°C ($+14^{\circ}\text{F}$) or above $+60^{\circ}\text{C}$ ($+140^{\circ}\text{F}$).

The use of non-Icom battery packs/chargers may impair transceiver performance and invalidate the warranty.

Even when the transceiver power is OFF, a slight current still flows in the circuits. Remove the battery pack or case from the transceiver when not using it for a long time. Otherwise, the battery pack or installed Ni-Cd batteries will become exhausted.

For USAonly:

Caution: Changes or modifications to this transceiver, not expressly approved by Icom Inc., could void your authority to operate this transceiver under FCC regulations.

SUPPLIED ACCESSORIES

Accessories included with the transceiver:

- ① Battery pack (BP-199 or BP-200) 1
- ② Antenna 1
- ③ Handstrap 1
- ④ Belt clip 1

*Some versions are supplied with a wall charger.

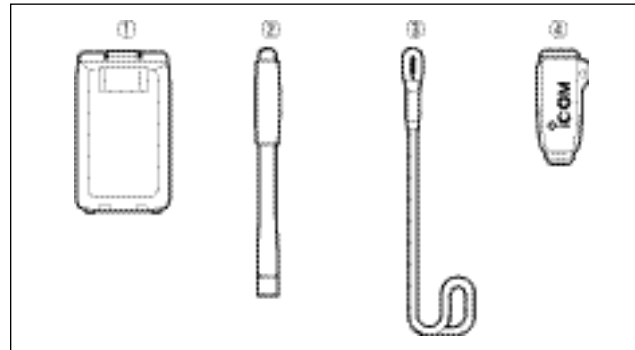

TABLE OF CONTENTS

IMPORTANT	ii	■ Setting an offset frequency	16
EXPLICITDEFINITIONS	ii	■ Auto repeater function	17
CAUTIONS	ii	6 MEMORY/CALLPROGRAMMING	18-20
SUPPLIED ACCESSORIES.....	iii	■ General	18
TABLE OF CONTENTS	iv	■ Programming a memory channel.....	18
1 ACCESSORYATTACHMENT.....	1	■ Memory editing	19
2 PANELDESCRIPTION	2-5	■ Memory names	20
■ Switches, controls, keys and connectors	2	7 DTMF MEMORY	21
■ Function display	4	■ Programming a DTMF code	21
3 BATTERYPACKS AND CHARGING	6-8	■ Transmitting a DTMF code	21
■ Battery pack charging	6	8 SCAN FUNCTIONS	22-24
■ Charging precautions.....	6	■ Scan types	22
■ About battery packs	6	■ Full/programmed scan	23
■ Charging connections	7	■ Memory (skip) scan	23
■ Battery case	8	■ Skip channel setting	24
4 BASIC OPERATION	9-14	■ Scan resume condition	24
■ Power ON	9	9 SUBAUDIBLE TONE OPERATION	25-26
■ Setting a frequency	9	■ Tone squelch.....	25
■ Setting tuning steps	10	■ Tone scan	26
■ Selecting a memory channel	11	■ Pocket beep operation	26
■ Lock function	11	10 OTHER FUNCTIONS	27-30
■ Receive and transmit	11	■ Help function	27
■ FM broadcast reception	12	■ Initial set mode.....	27
■ Air band reception.....	12	■ Resetting the CPU	29
■ Narrow FM operation	12	■ Cloning.....	30
■ RIT/VXOa function	13	11 TROUBLESHOOTING	31
■ Receive mode	14	12 SPECIFICATIONS.....	32
5 REPEATER OPERATION	15-17	13 OPTIONS	33
■ General	15	14 MODE ARRANGEMENT	34-35
■ Subaudible tones for repeater use	16		

ACCESSORY ATTACHMENT

1

◇ Antenna

Screw the supplied antenna onto the antenna connector as shown in the diagram below.

Keep the jack cover attached when jacks are not in use to avoid bad contacts.

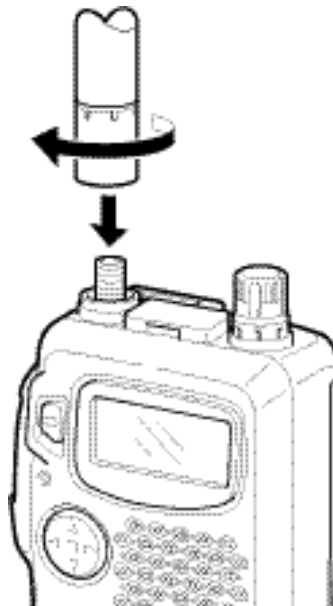

I:
n-
am-

◇ Handstrap

Attach the handstrap to the belt clip, before attaching the belt clip to the transceiver, as below.



◇ Belt clip

Attach the belt clip to the transceiver as illustrated below.

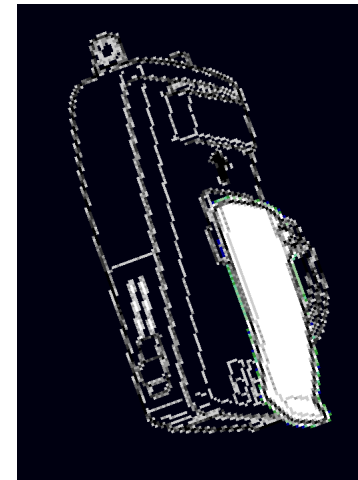

2 PANEL DESCRIPTION

■ Switches, controls, keys and connectors

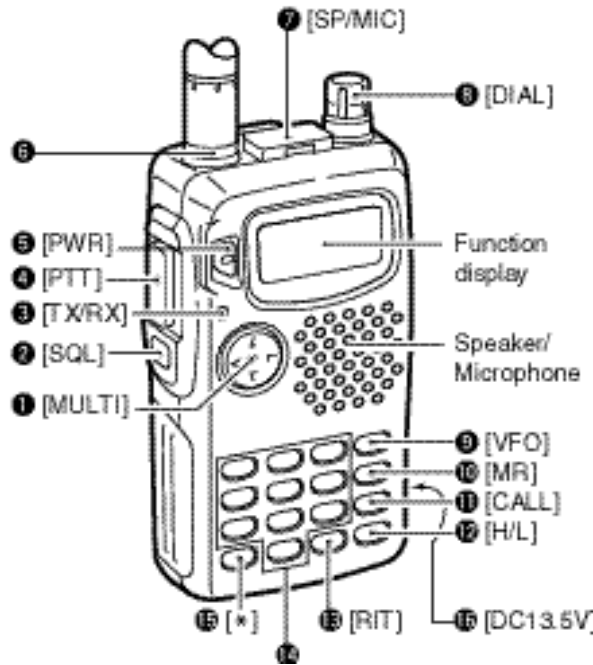

NOTE: In this manual—
 Push [MULTI] means push directly;
 Push [MULTI(↑)] means push up or down; and
 Push [MULTI(←→)] means push left or right. See 1 above.

- 1 MULTIFUNCTION SWITCH [MULTI]**
 - Push to select the tone or duplex menu. (pgs. 15–17); push for 1 sec. to enter set mode (pgs. 27–29).
 - Push ↑ to increase/decrease the volume (p. 11).
 - Push ←→ to change the operating band; push for 1 sec. to start a scan (p. 23).
- 2 SQUELCH SWITCH [SQL]** (p. 11)
 - Push and hold to open the squelch.
 - While pushing, rotate [DIAL] to adjust the squelch setting.
- 3 TX/RX INDICATOR** (p. 11)
 - Lights red while transmitting; green while receiving (or when the squelch is open).
- 4 PTT SWITCH [PTT]** (p. 11)
 - Push and hold to transmit; release to receive.
- 5 POWER SWITCH [PWR]** (p. 9)
 - Push for 1 sec. to turn power on and off.
- 6 ANTENNA CONNECTOR** (p. 1)
 - Connects the supplied antenna.
- 7 EXTERNAL SPEAKER AND MICROPHONE JACKS [SP/MIC]**
 - Connect an optional speaker-microphone or headset, if desired. The internal microphone and speaker will not function when either is connected. (See p. 33 for options.)

PANEL DESCRIPTION 2



NOTE: When connecting or disconnecting an external speaker-microphone, first turn off power to the transceiver.

8 TUNING CONTROL [DIAL]

Changes the operating frequency; memory channel in memory mode; set mode contents in set mode, etc.

9 VFO/CLEAR KEY [VFO(CLR/MHz)A]

- ➔ Push to select VFO mode. (p. 9)
- ➔ Cancels some functions such as digit input before entry, scans, etc.
- ➔ Push and hold for 1 sec., then rotate [DIAL] to change the MHz digit. (p. 10)
- ➔ While pushing [PTT], this key sends a DTMF "A." (p. 21)

10 MEMORY MODE KEY [MR(MW)E]

- ➔ Push to select memory mode. (p. 11)
 - "MR" appears while in memory mode.
- ➔ Push for 1 sec. to enter memory write mode. (p. 18)
- ➔ While pushing [PTT], this key sends a DTMF "B." (p. 21)

11 CALL KEY [CALLC]

- ➔ Push to select the call channel. (p. 19)
- ➔ While pushing [PTT], this key sends a DTMF "C." (p. 21)

12 OUTPUT POWER KEY [H/L(LOCK)D]

- ➔ Push to toggle between low and high power. (p. 11)
 - "LOW" appears while low power is selected.
- ➔ Push for 1 sec. to toggle the lock function on/off. (p. 11)
 - "L" appears while the lock function is activated.
- ➔ While pushing [PTT], this key sends a DTMF "D." (p. 21)

13 RIT KEY [RIT(TSCAN)#] (p. 13)

- ➔ Push, then rotate [DIAL] to change the RIT/VXO setting.
 - This function is only available for the 1.2 GHz band and RIT or VXO must be activated in set mode (p. 13).
- ➔ Push for 1 sec. to turn the tone scan function on/off. (p. 26)
- ➔ While pushing [PTT], this key sends a DTMF "F." (p. 21)

14 DIGIT KEYS

- ➔ Input the specified digit during frequency input, memory channel selection, etc.
- ➔ Transmit the DTMF code of the specified digit while pushing [PTT]. (p. 21)

15 MHz KEY [• (*)] (p. 10)

- ➔ Used as a shortcut for inputting frequencies.
- ➔ Transmits an "E" for DTMF operation while pushing [PTT].

16 EXTERNAL DC POWER JACK [DC13.5V]

Allows you to operate the transceiver with a 4.5 to 16 V DC power source using optional cables, CP-12L or OPC-254L.

CAUTION: DO NOT connect when a battery case is attached.

2 PANEL DESCRIPTION

■ Function display

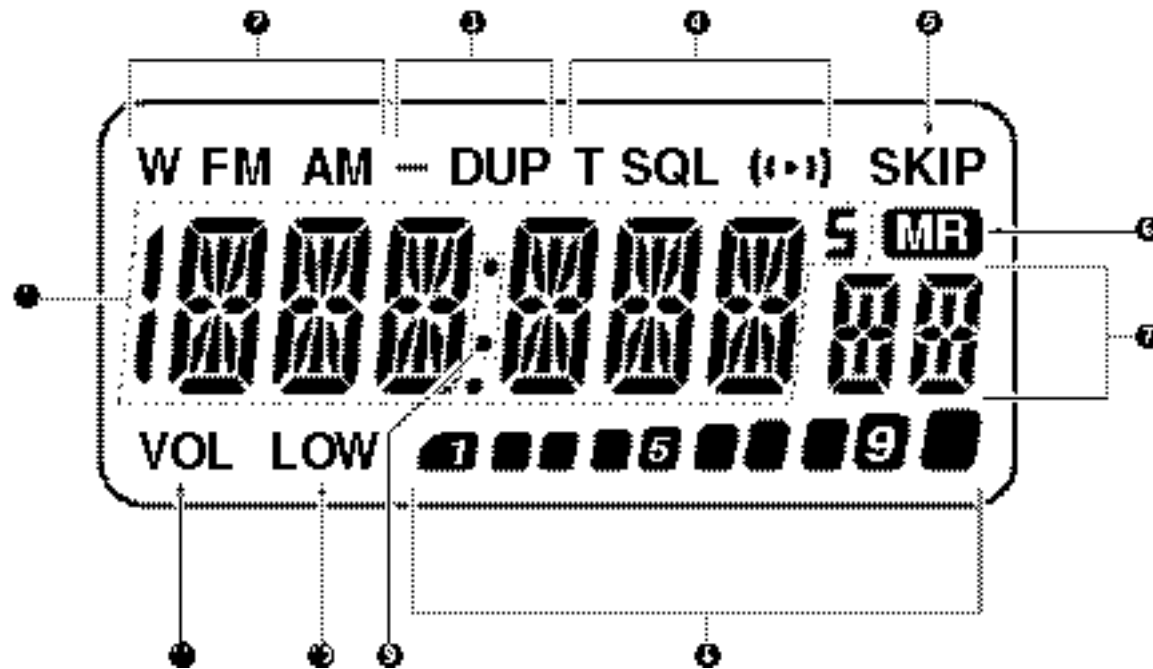

PANEL DESCRIPTION 2

❶ FREQUENCY INDICATION

Shows the selected frequency, set mode contents, etc.

❷ MODE INDICATORS

Indicate the operating mode.

❸ DUPLEX INDICATOR (p. 15)

Appears during semi-duplex operation.

- “-DUP” appears for minus duplex; “DUP” appears for plus duplex.

❹ TONE INDICATORS

“T” appears when the subaudible tone encoder (p. 15) is in use; “T SQL (·)” appears during pocket beep operation (p. 26) and “T SQL” appears when the tone squelch function (p. 25) is activated.

❺ SKIP INDICATOR (p. 23)

Appears when the selected channel is set as a “skip” channel.

❻ MEMORY MODE INDICATOR (p. 11)

Appears while in memory mode.

❼ MEMORY CHANNEL INDICATOR

Indicates the selected memory channel and other items such as the call channel, set mode items, etc.

❽ S/R/F INDICATORS (p. 11)

Show the relative signal strength while receiving and the output power selection while transmitting.

❾ RIT/VXO INDICATOR (p. 13)

Appears when either the RIT or VXO function is activated and the 1.2 GHz band is selected.

❿ LOW POWER INDICATOR (p. 11)

Appears when low output power is set.

⓫ VOLUME INDICATOR

Appears while adjusting the volume.

- Indicators also appear in place of the operating frequency while adjusting volume to visually indicate the selected volume level.

3

BATTERY PACKS AND CHARGING

■ Battery pack charging

The supplied* BP-198, BP-199 or BP-200 BATTERY PACK includes rechargeable Ni-MH batteries and can be charged approx. 300 times. Charge the battery pack before first operating the transceiver or when the battery pack becomes exhausted.

*Optional for versions which come with the BP-197 BATTERY CASE.

If you want to get the longest life out of your battery pack (300+ charges), the following points should be observed:

1. Avoid overcharging. The charging period should be less than 15 hours.
2. Use the battery until it becomes completely exhausted under normal conditions. We recommend battery charging just after transmitting becomes impossible.

■ Charging precautions

NEVER attempt to charge alkaline batteries. This will cause internal liquid leakage and damage the battery case and transceiver.

NEVER connect two or more chargers at the same time.

Charging may not occur under temperatures of 10°C (50°F) or over temperatures of 40°C (104°F).

■ About battery packs

◇ Operating period

Depending on attached battery pack, the operating period of the transceiver varies. When the approx. voltage of battery packs BP-198, BP-199 or BP-200 falls to 4, 5 or 8 V, respectively, charging is necessary. Refer to p. 33 for operating period details.

◇ Battery life

If your battery pack seems to have no capacity even after being fully charged, completely discharge it by leaving the power ON overnight. Then fully charge the battery pack again.

If the battery pack still does not retain a charge (or very little), a new battery pack must be purchased.

☞ **NOTE:** When using a battery pack for the first time or after long periods of inactivity between charges (approx. 2 months or more), the battery pack will not be able to retain a full charge immediately. Subsequent charge/discharge cycles will eventually bring the battery pack up to full charge capacity.

BATTERY PACKS AND CHARGING 3

■ Charging connections

◇ Regular charging

Attach the supplied or optional battery pack; then, connect the supplied* wall charger via an AC outlet as shown at right.

*Optional for versions which include

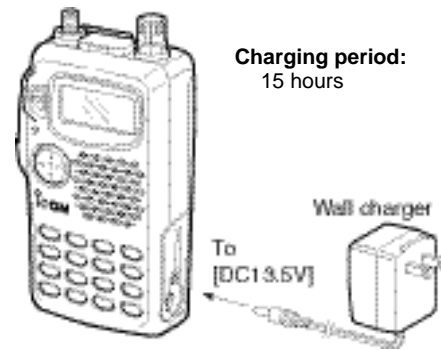

a battery case.

◇ Rapid charging with the BC-119

- ① Fix the optional AD-88 TERMINAL PC BOARD FOR CHARGER into the BC-119 with the 4 supplied screws.
- ② Insert the optional AD-87A CHARGEADAPTER into the charging slot of the BC-119.
- ③ Insert the optional AD-87B CHARGE ADAPTER into AD-87A (check orientation).
- ④ Insert the battery pack, either by itself or attached to the transceiver, into the whole assembly for charging (see right).

Charging periods: 1 hour (w/BP-198 or BP-199)
1.5 hours (w/BP-200)

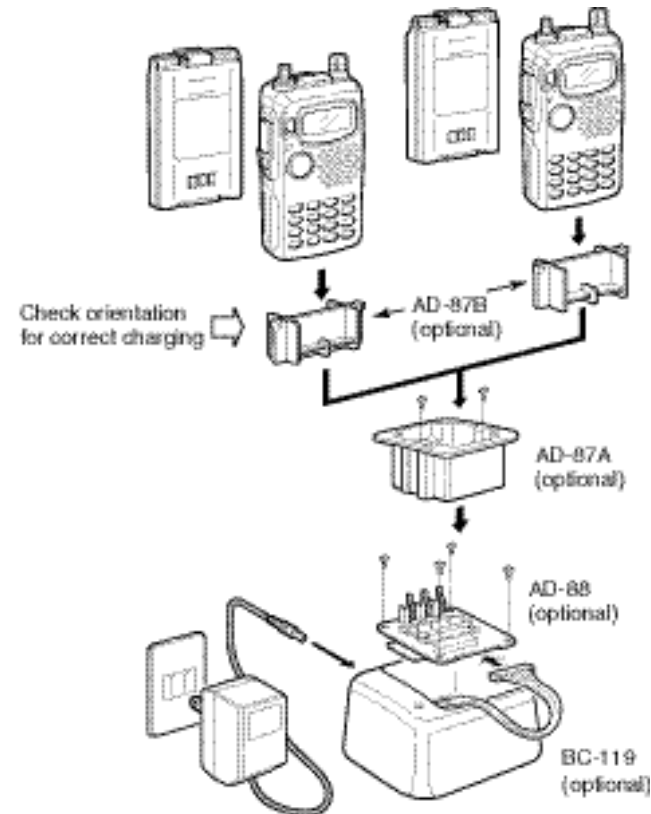

3 BATTERY PACKS AND CHARGING

◇ Operation with an optional cable

Connect an optional charger or cable to the transceiver as illustrated below. Be careful of battery overcharging as the connected battery is charged simultaneously.

u CAUTION: When the BP-197 BATTERY CASE IS CONNECTED, charging cannot take place.

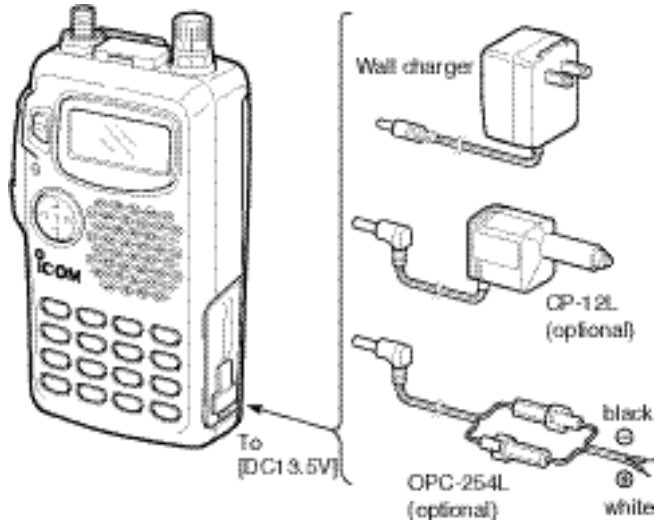

*To charge the battery pack 13 to 16 V DC is necessary.

■ Battery case

When using a battery case attached to the transceiver, install 3 AA(R6) size alkaline batteries as illustrated below.

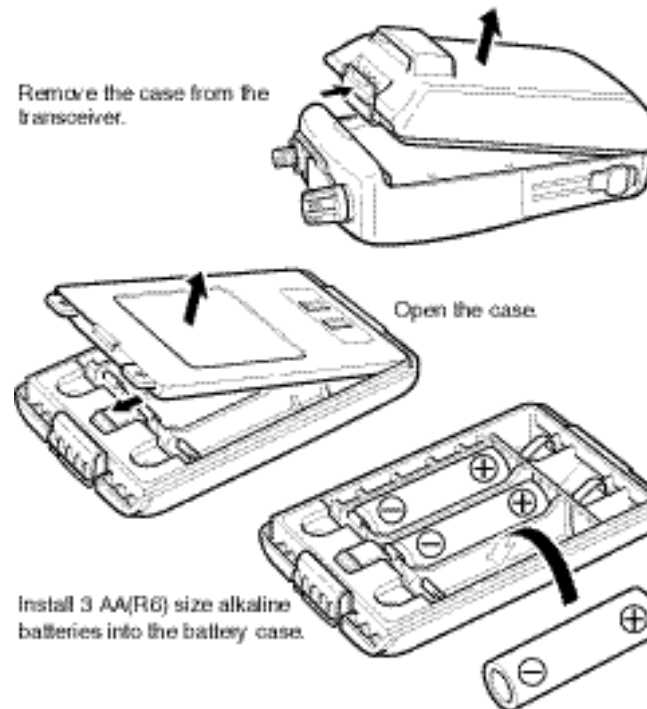

BASIC OPERATION

4

Power ON

NOTE: Charge the battery pack before turning power on for the first time (pgs. 6–8)

Push and hold [PWR] for 1 sec. to turn power on.

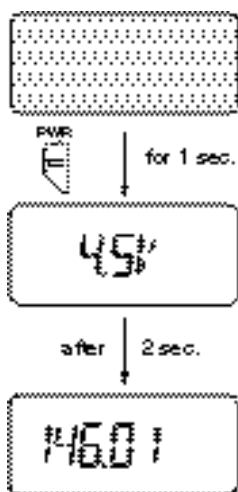

- Current battery voltage may be displayed for 2 sec.
- The display shows the approx. voltage in 0.5 V steps.
- When the battery voltage is lower than a specified level (varies according to battery pack used), "LOW V" appears. Charge the battery pack in this case; when using a battery case with alkaline cells this indication does not appear.
- If "OVER V" appears, **UNPLUG** the external DC plug immediately. Connected voltage is over 16 V and could damage the transceiver.

Setting a frequency

Via the keypad
(from the MHz digits)

- ① Push [VFO] to select VFO mode.
- ② Push digit keys corresponding to the desired frequency.
 - When inputting a frequency in the 50 MHz band, it is necessary to input the decimal point.
 - When a digit is mistakenly input, push [VFO] and input from the beginning.
 - When an unacceptable frequency is input, the display reverts to the previously displayed frequency.
 - "0," "2," "5" and "7" are acceptable as the 1 kHz digit input depending on the 10 kHz digit.

[Example]

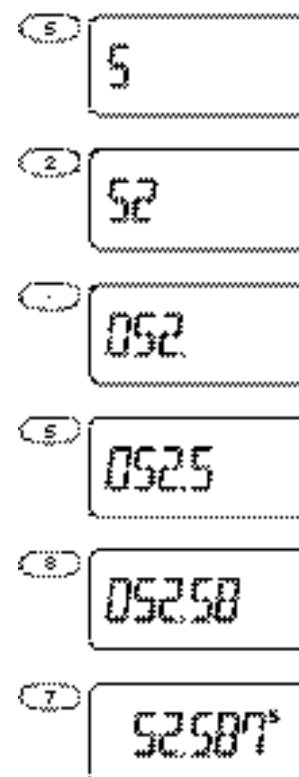

4 BASIC OPERATION

◇ Via the keypad

(from the decimal point)

- ① Push [VFO] to select VFO mode.
- ② Push [.] to leave the MHz setting as is and input from the kHz digits.

[Example]

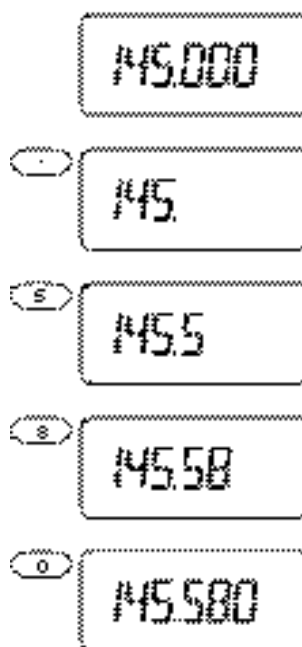

◇ Other methods

- ➔ *Via the [DIAL]:* Rotate [DIAL] to change the frequency according to the set tuning steps.
- ➔ *Via the MHz STEP:* Push [(VFO)MHz] for 1 sec., then rotate [DIAL] to change the frequency in 1 MHz steps.

■ Setting tuning steps USING SET MODE

The transceiver has 9 tuning steps* (each band has independent settings) as follows:

5 kHz	10 kHz	12.5 kHz	15 kHz	20 kHz
25 kHz	30 kHz	50 kHz	100 kHz	

*The 5 and 15 kHz steps are not available on the 1200 MHz band.

- ① Push [VFO] to select VFO mode.
- ② Push [MULTI(↔)] to select the desired band.
- ③ Push [MULTI] for 1 sec. to enter set mode.
- ④ Push [MULTI(↕)] one or more times until "TS" appears.
- ⑤ Push [MULTI(↔)] (or rotate [DIAL]) to select the desired tuning step.
- ⑥ Push [VFO] to exit set mode.

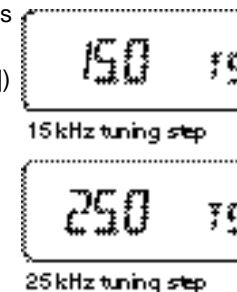

✓ CONVENIENT

Select a tuning step that matches the frequency intervals of repeaters in your area.

■ Selecting a memory channel

- ① Push [MR] to select memory mode.
- ② Push [MULTI(↔)] (or rotate [DIAL] or push digit keys) to select the desired memory channel.
 - Only programmed memory channels can be selected.
 - Memory channels 1–9 are preceded with a “0” when selecting with the digit keys; push “0#” to select scan edge 0A, push “0#” to select scan edge 0B.

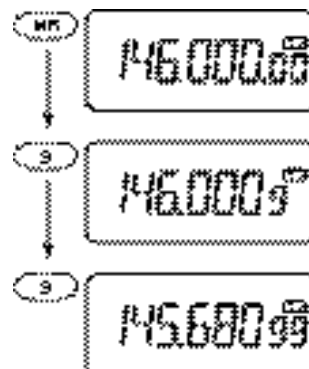

■ Lock function

Push [(H/L)LOCK] for 1 sec. to toggle the lock function on and off.

- “L” appears while the lock function is activated.
- [PTT], [PWR], [MULTI(↔)] (volume), [SQL] and [H/L] can be used even when the lock function is activated.

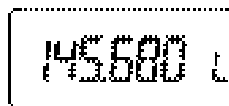

■ Receive and transmit

- ① Push [PWR] for 1 sec. to turn power on.
- ② Push [MULTI(↔)] to set a volume level.
- ③ Set the squelch level.
 - While pushing [SQL], rotate [DIAL].
 - 10 selections are available, “OPEN,” “AUTO,” and “SQL1 to “SQL8.”
- ④ Set an operating band and frequency.
 - When a signal is received:
 - Squelch opens and audio is emitted from the speaker.
 - The [TX/RX] indicator lights green.
- ⑤ Push [H/L] to toggle output power between high and low.
 - “LOW” appears when low output power is selected.
- ⑥ Push and hold [PTT] to transmit; then speak into the mic.
 - **Do not** hold the microphone too close to your mouth or speak too loudly. This may distort the signal.
 - The S/Rf indicator shows the output power selection.
 - The [TX/RX] indicator lights red.
- ⑦ Release [PTT] to return to receive.

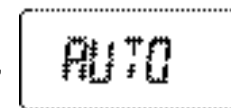

✓ CONVENIENT

Monitor function: Push and hold [SQL] to listen to weak signals that do not open the squelch.

4 BASIC OPERATION

■ FM broadcast reception

The transceiver can receive FM radio broadcasts. These are typically in the range 76–107.995 MHz (88–107.995 for some versions) and are in WFM receive mode.

To select the FM broadcast band:

- ➔ Push [MULTI(↔)] one or more times until “WFM” appears in the display, then rotate [DIAL] to select a frequency; or,
- ➔ Select a frequency with the digit keys directly.
 - “WFM” automatically appears when a frequency in the range 76–107.995 MHz is input.

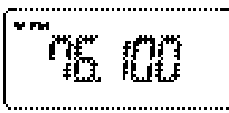

☞ **NOTE:** When pushing [PTT], “OFF” appears indicating the frequency and mode are outside the permitted range.

■ Air band reception (USA ver. only)

The transceiver can receive frequencies reserved for commercial/private aircraft and ground support. These are in the range 118–135.995 MHz and are in AM receive mode.

To select the air band:

- ➔ Push [MULTI(↔)] one or more times until “AM” appears in the display,



- play, then rotate [DIAL] to select a frequency; or,
- ➔ Select a frequency with the digit keys directly.
 - “AM” automatically appears when a frequency in the range 118–135.995 MHz is input.

☞ **NOTE:** When pushing [PTT], “OFF” appears indicating the frequency and mode are outside the permitted range.

■ Narrow FM*

USING SET MODE

operation (Eur., France, Italy ver. only)

- ① Push [MULTI(↔)] one or more times to select the 144 MHz band.
- ② Push [MULTI] for 1 sec. to enter set mode.
- ③ Push [MULTI(⬇)] one or more times to display “MO,” if necessary.
- ④ Push [MULTI(↔)] (or [DIAL]) to toggle narrow FM operation on and off.
 - “FM” appears when narrow FM operation is on.
- ⑤ Push [VFO] to exit set mode and return to regular operation.

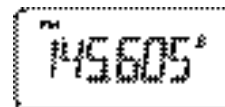

Narrow FM is on.

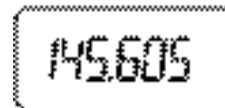

Narrow FM is off.

☞ ***NOTE:** FM narrow operation can be set for individual memory channels or in VFO mode; narrow FM affects

■ RIT/VXO function (1200 MHz band)

In the 1200 MHz band, differences between actual and displayed frequencies can often be large. The RIT (receive incremental tuning) function allows you to compensate the displayed frequency for differences in the actual receive frequency; the VXO (variable crystal oscillator) function allows you to compensate the displayed frequency for differences in the actual receive and transmit frequencies.

◇ Activating RIT/VXO

USING SET MODE

- ① Select a frequency in the 1200 MHz band (or a memory channel with a 1200 MHz band frequency; or the 1200 MHz band call channel).
- ② Push [MULTI] for 1 sec. to enter set mode.
- ③ Push [MULTI(⚡)] one or more times until "rV" appears.
- ④ Push [MULTI(↔)] one or more times to select "RIT" (RIT activated, "VXO" (VXO activated) or "OFF" (neither activated)—[DIAL] can also be used.
- ⑤ Push [VFO] to exit set mode and return to the previously selected mode.
 - When RIT or VXO is activated, "rV" appears above the decimal point in the frequency indication (in the 1200 MHz band).

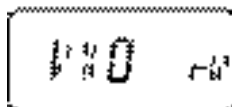
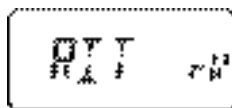

◇ Adjusting the frequency with RIT/VXO

Make sure that RIT or VXO is activated in set mode and that the 1200 MHz band is selected.

- ① Select a frequency in the 1200 MHz band (or a memory channel with a 1200 MHz band frequency; or the 1200 MHz band call channel).
- ② Push [RIT] to display the frequency offset in kHz.
- ③ Push [MULTI(↔)] one or more times (or rotate [DIAL]) to adjust the frequency offset.
 - The frequency offset can be set ± 5 kHz in 1 kHz steps.
- ④ Push [VFO] to return to regular display indication.

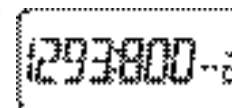

Offset minus 2 kHz

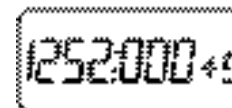

Offset plus 5 kHz

4 BASIC OPERATION

■ Receive mode

USING SET MODE

The IC-T81A/E allows you to receive frequencies in the 50 MHz band in AM mode (as well as to transmit in FM narrow mode in the 144 MHz band for Italy/Europe versions only—see p. 12).

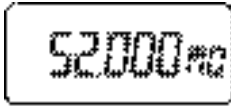
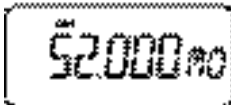
- ① Push [VFO] to select VFO mode.
- ② Push [MULTI(↔)] one or more times to select the 50 MHz band. 
- ③ Push [MULTI] for 1 sec. to enter set mode. 
- ④ Push [MULTI(↓)] one or more times until "MO" appears.
- ⑤ Push [MULTI(↔)] (or rotate [DIAL]) one or more times to select "AM."
- ⑥ Push [VFO] to exit set mode and return to VFO mode.
 - "AM" appears when frequencies in the 50 MHz band are selected.

NOTE:

- When AM operation is selected, transmit is not possible. When [PTT] is pushed, "OFF" appears.
- AM operation can also be selected for individual memory channels programmed with 50 MHz frequencies. In this way you can program individual frequencies for AM receive while allowing regular transmit/receive for 50 MHz frequencies in VFO mode.

REPEATER OPERATION

5

■ General

When using a repeater, the transmit frequency is shifted from the receive frequency by the offset frequency. It is convenient to program repeater info into memory channels (pgs. 18–20).

- ① Set the operating band and receive frequency (repeater output frequency).
- ② Push [MULTI] to enter duplex set mode.
 - “D” appears; if “T” appears instead of “D” push [MULTI(↕)] to select “D.”
- ③ Push [MULTI(↔)] (or rotate [DIAL]) one or more times to select DUP (plus duplex) or –DUP (minus duplex).
 - When the auto repeater function is in use (USAversion only) this selection and steps ④ and ⑤ are not necessary (p. 17).
- ④ Push [MULTI(↕)] to select tone set mode.
 - “T” appears.
- ⑤ Push [MULTI(↔)] (or rotate [DIAL]) to activate the sub-audible tone encoder according to repeater requirements.
 - Refer to the table of subaudible tone frequencies on the following page.
- ⑥ Push and hold [PTT] to transmit.
 - The displayed frequency automatically changes to the transmit frequency (repeater input frequency).
 - If “OFF” appears, check the offset frequency (p. 16).
- ⑦ Release [PTT] to receive.
- ⑧ Push and hold [SQL] to check whether the other station’s transmit signal can be directly received or not.

◇ Tone information

Some repeaters require a tone to be accessed. In this case, precede step ⑥ at left with the required tone.

DTMF TONES

While pushing [PTT], push the desired digit key(s) to transmit DTMF tones.

- The transceiver has 9 DTMF memory channels. See p. 21 for details.

1750 Hz TONE

While pushing [PTT], push and hold [MULTI] for 1 to 2 sec. to transmit a 1750 Hz tone signal.

✓ Convenient

Tone scan function: When you don’t know the subaudible tone used for a repeater, the tone scan is convenient for detecting the tone frequency.

Push [(RIT)TSCAN] for 1 sec. to activate the tone scan. See p. 26 for more details.

5 REPEATER OPERATION

■ Subaudible tones USING SET MODE for repeater use

Some repeaters require subaudible tones to be accessed. Subaudible tones are superimposed over your normal signal and must be set in advance.

- ① Push [VFO] to select VFO mode.
- ② Push [MULTI(↔)] to select a band.
- ③ Push [MULTI] for 1 sec. to enter set mode.
- ④ Push [MULTI(↓)] one or more times until "rT" appears.
- ⑤ Push [MULTI(↔)] (or rotate (DIAL)) to select the desired subaudible tone.
- ⑥ Push [VFO] to enter the selected tone and exit set mode.

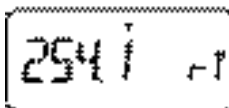
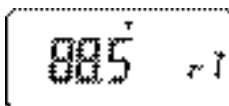

Available subaudible tone frequencies (unit: Hz)

67.0	79.7	94.8	110.9	131.8	156.7	171.3	186.2	203.5	229.1
69.3	82.5	97.4	114.8	136.5	159.8	173.8	189.9	206.5	233.6
71.9	85.4	100.0	118.8	141.3	162.2	177.3	192.8	210.7	241.8
74.4	88.5	103.5	123.0	146.2	165.5	179.9	196.6	218.1	250.3
77.0	91.5	107.2	127.3	151.4	167.9	183.5	199.5	225.7	254.1

■ Setting an offset frequency USING SET MODE

When communicating through a repeater, the transmit frequency is shifted from the receive frequency by an amount determined by the offset frequency.

- ① Push [VFO] to select VFO mode.
- ② Push [MULTI(↔)] to select a band.
- ③ Push [MULTI] for 1 sec. to enter set mode.
- ④ Push [MULTI(↓)] one or more times until "OW" appears.
- ⑤ Push [MULTI(↔)] (or rotate (DIAL)) to select the desired offset.
 - The offset frequency changes according to the selected tuning steps.
 - The MHz step may be helpful for large frequency changes—push [(VFO)MHz] for 1 sec.
- ⑥ Push [VFO] to enter the selected offset and exit set mode.

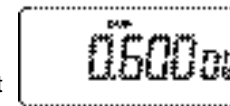

REPEATER OPERATION 5

■ Auto repeater function USING INITIAL SET MODE (USAversion only)

The USAversion automatically activates the repeater settings (duplex, ON/OFF, duplex direction, tone encoder ON/OFF) when the operating frequency falls within or outside of the general repeater output frequency range. The offset and repeater tone frequencies are not changed by the auto repeater function, reset these frequencies, if necessary.

- ① While pushing [MULTI], push [PWR] to turn power on and enter initial set mode.
- ② Push [MULTI(↓)] one or more times until "Ar" appears.
- ③ Push [MULTI(↔)] (or rotate [DIAL]) to select the desired condition.
 - "OFF"—the auto repeater function is turned off;
 - "ON1"—the auto repeater function activates for duplex only;
 - "ON2"—the auto repeater function activates for duplex and tone.
- ④ Push [VFO] to exit initial set mode.

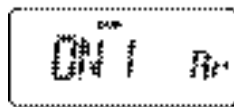

Activates for duplex only.

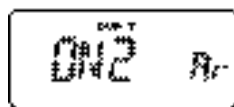

Activates for duplex and tone.

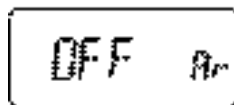

Auto repeater function is turned off

Frequency range and offset direction

FREQUENCYRANGE	DUPLEX DIRECTION
145.200– 145.495 MHz 146.610– 146.995 MHz	"-DUP" appears
147.000– 147.395 MHz	"DUP" appears
442.000– 444.995 MHz	"DUP" appears
447.000– 449.995 MHz	"-DUP" appears
51.620– 51.980 MHz 52.500– 52.980 MHz 53.500– 53.980 MHz	"-DUP" appears
1282.000–1287.995 MHz* 1288.000–1295.995 MHz	"-DUP" appears

*When operating in this range, the offset frequency must be set to -12 MHz (see previous page for setting an offset).

6

MEMORY/CALL PROGRAMMING

■ General

The transceiver has 124 memory channels (100 regular, 10 pairs of scan edge channels for mixed bands and 1 call channel for each band—VHF, UHF, 50 MHz and 1200 MHz). Note that memory channels are not grouped according to band. In other words, a given memory channel can be programmed with either a VHF frequency, a UHF frequency, a 50 MHz frequency or a 1200 MHz frequency. This is not the case with call channels. Call channels are band specific.

The following can be programmed into memory/call channels:

- Operating frequency
- Duplex direction with an offset frequency (pgs. 15, 16)
- Subaudible tone encoder or tone squelch on/off with a tone (CTCSS) frequency (pgs. 25, 26)
- Subaudible tone and tone squelch frequencies (pgs. 16, 25)
- Mode—AM, FM, etc. (p. 14)
- Skip information* (p. 23)

*Except for scan edge memory channels and call channels.

NOTE:

- ➔ Memory channels can be assigned names (of up to 6 characters).
- ➔ When memory names are assigned, each push of [MR] toggles between frequency and name indication.

■ Programming a memory channel

- ① Push [VFO] to select VFO mode.
- ② Set the desired frequency:
 - ➔ Set other data, such as repeater information, if required.
- ③ Push [(MR)MW] for 1 sec.
 - “[MR]” and the previously selected memory channel flash.
- ④ Push [MULTI(↔)] (or rotate [DIAL]) to select the desired memory channel.
 - Call channels and scan edge channels, as well as regular channels, can be programmed in this way.
 - Only the decimal point appears for memories not yet programmed.
 - If you want to confirm the VFO frequency, push [MR] momentarily—the VFO frequency briefly appears.
- ⑤ Push [(MR)MW] for 1 sec. to program.
 - “[MR]” and the memory channel number stop flashing.
 - VFO mode is selected.

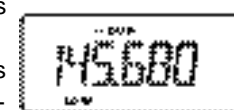
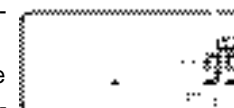
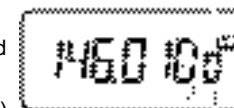
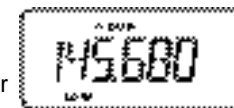

MEMORY/CALL PROGRAMMING 6

■ Memory editing

Memory (call) channel contents can be moved to VFO or to another memory.

◇ Transferring a memory (call) channel's contents

- ① Select the memory (call) channel to be transferred:

- ➔ Push [MR] ([CALL]) to select memory (call) mode.

- ➔ Push [MULTI(↔)] (or rotate [DIAL]) to select the memory (call) channel.

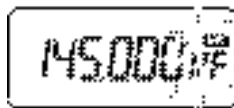
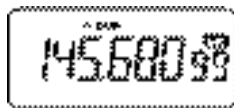

- ② Push [(MR)MW] for 1 sec.

- “VF” appears and flashes with “MR” and the previously selected VFO frequency appears..

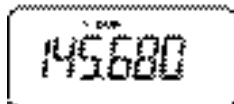

To transfer the contents to VFO:

- ③ Push [(MR)MW] for 1 sec.

- The contents are transferred and VFO mode is selected.

To transfer the contents to another memory (call) channel:

- ③ Push [MULTI(↔)] (or rotate [DIAL]) to select the memory (call) channel to be transferred to.

- ④ Push [(MR)MW] for 1 sec.

- The contents are transferred and memory (call) mode is selected.

◇ Clearing a memory

- ① Push [MR] to select memory mode.

- ② Push [MULTI(↔)] (or rotate [DIAL]) to select a channel to be cleared.

- ③ Push [VFO] to select VFO mode.

- ④ Push [(MR)MW] for 1 sec. to enter memory menu mode.

- “MR” and a memory channel number flash.

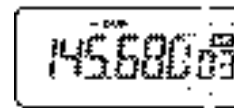

- ⑤ Push [MULTI(↕)] to display “CLR.”

- Scan edge channels 0A/0B and call channels cannot be cleared.

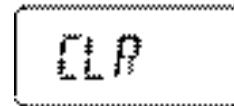

- ⑥ Push [(MR)MW] for 1 sec. to clear the previously selected memory channel.

- “MR” and a memory channel number flash and the previously stored information is erased.

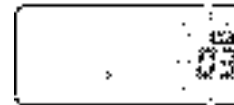

- ⑦ Push [VFO] to select return to VFO mode.

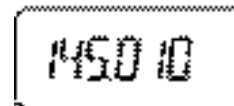

☞ **NOTE:** Be careful—the contents of cleared memories **cannot** be recalled.

6 MEMORY/CALL PROGRAMMING

Memory names

Memory channels can be programmed with names of up to six characters.

- ① Push [VFO] to select VFO mode (or select a memory channel).
- ② Push [(MR)MW] for 1 sec.
 - “MR” and the previously selected memory channel number flash.
- ③ Push [MULTI(↔)] (or rotate [DIAL]) to select the desired memory channel.
- ④ Push [MULTI(↕)] so that “NAME” appears.
 - Not valid for call channels.
- ⑤ Push [MULTI] to enter name editing mode.
 - The first character of the name flashes.
- ⑥ Rotate [DIAL] (or push [MULTI(↕)]) to select a character; then, push [MULTI(↔)] to advance to the next character.
- ⑦ Repeat step ⑥ until the desired name appears.
- ⑧ Push [MULTI] to program the name and return to the “NAME” display; then push [VFO] to return to VFO

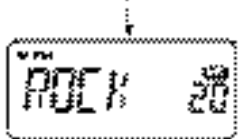
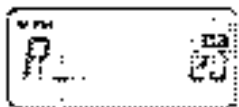
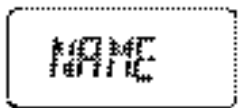
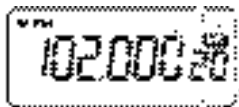

mode.

- Push [(MR)MW] for 1 sec. to erase a channel's name and return to VFO mode.
- When in memory mode push [MR] to toggle between memory name indication and frequency indication.

☞ **NOTE:** To clear a memory name (or remove one or more characters from a name) without clearing the rest of the memory channel contents, follow steps ① to ③ at left and insert an underscore “_” in place of other characters in steps ⑥ and ⑦.

DTMF MEMORY



■ Programming a DTMF code

The transceiver has 9 DTMF memory channels (D1 to D9) for storage of often-used DTMF codes of up to 16 characters.

- ① Push [(MR)MW] for 1 sec. to enter memory write mode; then push [MULTI(↕)] to enter DTMF memory mode.
 - One of “D1” to “D9” appears and flashes.
- ② Rotate [DIAL] (or push [MULTI(↔)]) to select the desired channel.
- ③ Push [MULTI] to enter DTMF programming mode.
 - The first character of the DTMF code flashes.
- ④ Push digit keys (or rotate [DIAL] or push [MULTI(↕)]) to enter the desired DTMF character; then push [MULTI(↔)] to advance to the next character.
 - A maximum of 16 characters can be input.
 - Pushing [MULTI(↕)] can also be used to enter DTMF characters.
 - When pushing [SQL], the programmed contents can be monitored.
- ⑤ Push [MULTI] to input the digits; then push [VFO] to exit DTMF programming mode.

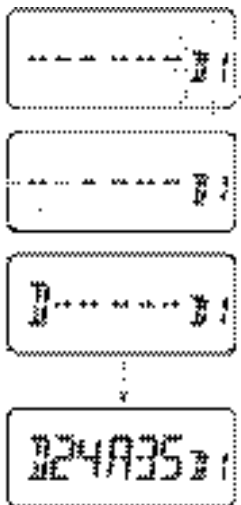

■ Transmitting a DTMF code

◇ Using a DTMF memory channel

- ① Push [(MR)MW] for 1 sec. to enter memory write mode; then push [MULTI(↕)] to enter DTMF memory mode.
 - One of “D1” to “D9” appears.
- ② Rotate [DIAL] (or push [MULTI(↔)]) to select the desired channel.
- ③ While pushing [PTT], push [SQL] to transmit the selected DTMF channel's contents.

◇ Manual DTMF code transmission

- ① While pushing [PTT], push digit keys to transmit a DTMF code manually.
- ② Release [PTT] to return to receive.

◇ DTMF transmit speed USING INITIAL SET MODE

When slow DTMF transmission speeds are required (such as for some repeaters) the transceiver's rate of DTMF transmission can be adjusted.

- ① While pushing [MULTI], push [PWR] to turn power on and enter initial set mode.
- ② Push [MULTI(↕)] one or more times until “DT” appears.
- ③ Rotate [DIAL] (or push [MULTI(↔)]) to select the a transmit speed.
 - 100 (default), 200, 300 and 500 msec. are available.
- ④ Push [VFO] to exit initial set mode.





8 SCAN FUNCTIONS

Scan types

FULL SCAN (p. 23) Repeatedly scans all frequencies over a selected band.

PROGRAMMED SCAN (p. 23) Repeatedly scans between two user-programmed frequencies. Used for checking for frequencies within a specified range such as repeater output frequencies.

MEMORY SCAN (p. 23) Repeatedly scans all programmed memory channels.

NOTE: Push [MULTI(↔)] during full/programmed scan to change the band being scanned or to select a different pair of scan edges.

MEMORY SKIP SCAN (p. 23) Repeatedly scans all memories, except those set as skip channels.

Push [MULTI(↔)] during memory (skip) scan to change the memory channel groups: 1.2 GHz, VHF, UHF, 50 MHz, air band or WFM programmed memories; or, all programmed memories.

■ Full/programmed scan

- ① Push [VFO] to select VFO mode, if necessary.
- ② Push [MULTI(↔)] for 1 sec. to start the scan; after that, each push of [MULTI(↔)] selects a different scan range.
 - To change the scan direction, rotate [DIAL].
 - ↳ The following scan ranges are selectable:
 - “ALL50” for full scan on the 50 MHz band.
 - “ALL144” for full scan on the 144 MHz band.
 - “ALL 430” or “ALL 440” for full scan on the 430(440) MHz band.
 - “ALL WFM” for full scan on the WFM (FM broadcast) band.
 - “ALL 118” for full scan on the air band.
 - “ALL1200” for full scan on the 1.2 GHz band.
 - “PROG 0” to “PROG 9” for one of the programmed scans.
- ③ To stop the scan, push [VFO].

☞ **NOTE:** For programmed scan, scan edges must be programmed in advance (0A/0B are programmed by default). Program scan edges in the same manner as regular memory channels (p. 18).

If the same frequencies are programmed into a pair of scan edges, programmed scan does not proceed.

■ Memory (skip) scan

- ① Push [MR] to select memory mode, if necessary.
- ② Push [MULTI(↔)] for 1 sec. to start the scan; after that, each push of [MULTI(↔)] selects a different scan group.
 - To change the scan direction, rotate [DIAL].
 - ↳ The following memory groups are selectable:
 - “SELALL” scans all programmed memory channels.
 - “SEL50” scans programmed memories in the 50 MHz band.
 - “SEL 144” scans programmed memories in the 144 MHz band.
 - “SEL430” or “SEL440” scans programmed memories in the 430(440) MHz band.
 - “SELWFM” scans all programmed WFM channels.
 - “SEL118” scans all programmed air band channels.
 - “SEL 1200” scans programmed memories in the 1.2 GHz band.
- ③ To stop the scan, push [VFO].

☞ **NOTE:** For memory skip scan, program memory channels you don't want to search, as “skip” channels (p. 24). Scan proceeds as above except that any channels specified as skip channels are not searched.

8 SCAN FUNCTIONS

■ Skip channel setting

Memory channels can be set to be skipped during memory scan. This is useful to speedup the memory scan interval.

- ① Push [MR] to select memory mode.
- ② Push [(MR)MW] for 1 sec. to enter memory write mode.
- ③ Rotate [DIAL] (or push [MULTI(↔)]) to select a memory channel.
- ④ Push [MULTI(↓)] twice times to select "SKIP."
- ⑤ Push [MULTI(↔)] (or rotate [DIAL]) to toggle the skip setting for the selected channel ON/OFF.
 - "SKIP" appears when the channel is set as a skip channel.
- ⑥ Push [VFO] to program the setting and exit memory write mode.

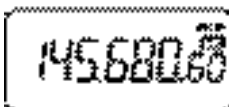

☞ **NOTE:** Scan edge channels, 0A to 9B, cannot be set to show "SKIP" settings, however, they will be skipped during scan.

■ Scan resume condition

USING SET MODE

The resume condition can be selected as a pause or timer scan. This setting is common for all scans.

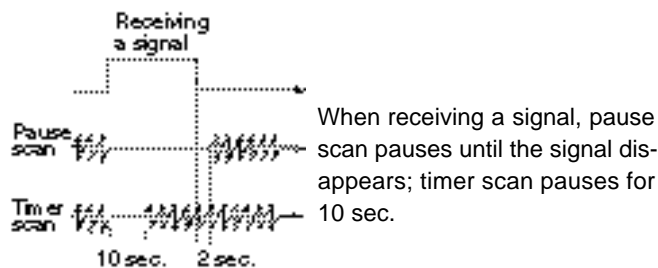

- ① Push [MULTI] for 1 sec. to enter set mode.
- ② Push [MULTI(↓)] one or more times until "SC" appears.
- ③ Push [MULTI(↔)] (or rotate [DIAL]) to select the desired scan resume condition.
 - "T-10": scan pauses for 10 sec. on a received signal.
 - "P-02": scan pauses on a received signal until it disappears.
- ④ Push [VFO] to exit set mode.

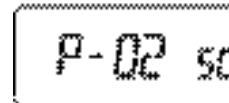
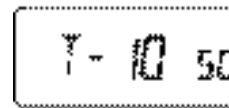

SUBAUDIBLE TONE OPERATION

9

■ Tone squelch

The tone squelch opens only when receiving a signal containing a matching subaudible tone. You can silently wait for calls from group members using the same tone.

- ① Set the operating frequency.
- ② Set the desired subaudible tone in set mode (see right).
- ③ Push [MULTI] to enter subaudible tone mode.
 - “T” appears; if “D” appears, push [MULTI(↓)] to select “T.”
- ④ Push [MULTI(↔)] (or rotate [DIAL]) one or more times until “TSQL” appears; then push [VFO] to exit set mode.
- ⑤ When the received signal includes a matching tone, squelch opens and the signal can be heard.
 - When the received signal’s tone does not match, tone squelch does not open, however, the S-indicator shows signal strength.
 - To open the squelch manually, push and hold [SQL].
- ⑥ Operate the transceiver in the normal way.
- ⑦ To cancel the tone squelch, repeat steps ③ and ④ so that no tone indicator appears.

☞ **NOTE:** Some tone frequencies may receive interference from adjacent tone frequencies.

✓ CONVENIENT

Store subaudible tone frequencies and tone squelch on/off settings in memories (call) for easy recall.

◇ Setting subaudible tones for USING SET MODE tone squelch operation (CTCSS* tones)

Separate tone frequencies can be set for tone squelch operation than for repeater operation (the same range of tones is available—see below).

- ① Select VFO or a memory channel.
- ② Push [MULTI] for 1 sec. to enter set mode.
- ③ Push [MULTI(↓)] one or more times until “CT” appears.
- ④ Rotate [DIAL] (or push [MULTI(↔)]) to select the a sub-audible tone.
- ⑤ Push [VFO] to program the selected tone and exit set mode.

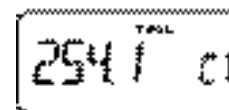
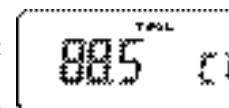

Available subaudible tone frequencies										(unit: Hz)
67.0	79.7	94.8	110.9	131.8	156.7	171.3	186.2	203.5	229.1	
69.3	82.5	97.4	114.8	136.5	159.8	173.8	189.9	206.5	233.6	
71.9	85.4	100.0	118.8	141.3	162.2	177.3	192.8	210.7	241.8	
74.4	88.5	103.5	123.0	146.2	165.5	179.9	196.6	218.1	250.3	

*CTCSS stands for continuous tone coded squelch system.

9 SUBAUDIBLE TONE OPERATION

■ Tone scan

The transceiver can detect the subaudible tone frequency in a received signal. By monitoring a signal, such as that being transmitted on a repeater input frequency, you can determine the tone frequency required to access the repeater.

- ① Set the desired frequency or memory channel to be checked for a tone frequency.
- ② Push [(RIT)TSCAN]] for 1 sec. to start the tone scan.
 - Rotate [DIAL] to change the scan direction.
- ③ When the tone frequency is decoded, the set mode contents are programmed with the tone frequency.
 - “TSQL” flashes: the matched tone is stored as a CTCSS tone;
 - “T” flashes: the matched tone is stored as a repeater tone.
 - When in memory mode, the decoded tone frequency is stored temporarily—changing memory channels or selecting VFO mode erases the matched tone.
 - “CT” appears during tone scan when the tone squelch is activated; “rT” appears when the tone squelch is not activated.
 - Subaudible tone frequencies flash as they are scanned.

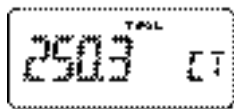

"CT" appears during tone scan with tone squelch

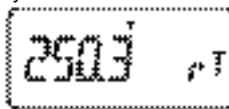

"rT" appears during tone scan without tone squelch

- ④ Push [TSCAN]] (or [PTT] or [VFO]) to stop the scan.

■ Pocket beep operation

This function uses subaudible tones for calling and can be used as a “common pager” to inform you that someone has called you while you were away from the transceiver.

◆ Waiting for a call from a specific station

- ① Set the operating frequency.
- ② Set the desired subaudible tone (same as that used for tone squelch operation, “CT”) in set mode.
 - See previous page for programming.
- ③ Push [MULTI] to enter subaudible tone mode.
 - “T” appears; if “D” appears, push [MULTI(↓)] to select “T.”
- ④ Push [MULTI(↔)] (or rotate [DIAL]) one or more times until “TSQL ((•))” appears; then push [VFO] to exit set mode.
- ⑤ When a signal with a matched tone is received, the transceiver emits beep tones for 30 sec. and flashes “((•)).”
- ⑥ Push [PTT] to answer or push [VFO] to stop the beeps and flashing.
 - Tone squelch is automatically selected.

◆ Calling a waiting station using pocket beep

A subaudible tone matched with the station’s tone frequency is necessary. Use the tone squelch on the previous page or subaudible tone encoder (p. 15).

OTHER FUNCTIONS 10

■ Help function

When in set mode or initial set mode and no operation is performed for 5 sec., the name of the selected item scrolls across the function display for convenience.

■ Initial set mode

AT POWER ON

Initial set mode is accessed at power on and allows you to set seldom-changed settings. In this way you can “customize” transceiver operations to suit your preferences.

- ① While pushing [MULTI], push [PWR] to turn power on.
 - The transceiver enters initial set mode and an initial set mode item is displayed.
- ② Push [MULTI(⌵)] to select the desired display as described on the following pages.
- ③ Push [MULTI(↔)](or rotate [DIAL]) to select the desired condition.
- ④ Push [VFO] (or [PTT]) to exit initial set mode for regular operation.

◇ Optional HM-75A functions

Microphone simple mode is used to change the function assignments for switches on the optional HM-75A REMOTE CONTROLMICROPHONE as at right.

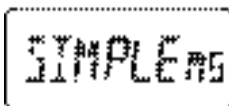

☞ **NOTE:** VFO mode cannot be selected via the microphone when SIMPLE mode is selected.

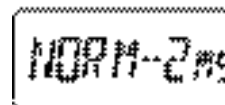
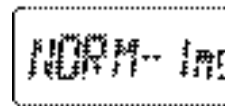

SWITCH	NORMAL 1/NORMAL 2	SIMPLE
	NORMAL1: BAND Selects a band. No function in memory mode.	MONITOR Toggles squelch between open and closed.
	NORMAL2: MONITOR Toggles squelch between open and closed.	
	VFO/MEMORY Toggles VFO and memory mode.	CALL Selects the call
	Change the frequency or memory channel when pushed.	M00 Selects memory
	Start previously selected scan when pushed and held. •Normal 2 (while squelch is open): Adjust volume.	M01 Selects memory

☞ **NOTE:** During transmit, pushing [A] transmits a 1750 Hz tone for Europe, France and Italy versions.

10 OTHER FUNCTIONS

◇ Auto power OFF

This item allows you to set a time at which the transceiver will automatically turn off. The power off time can be set to 20, 40, 60 min. or turned OFF (default).

OFF AO

20 AO

◇ Display backlighting

When set to AUTO (default), display backlighting automatically turns on when a key is pushed; when set to OFF, display backlighting cannot be turned ON; when set to ON, display backlighting remains ON continuously.

AUTO LI

ON LI

OFF LI

◇ Beep tones ON/OFF

Confirmation beep tones normally sound when you push a key or switch. These can be turned ON (default) or OFF as you prefer.

ON BE

OFF BE

◇ Auto repeater (see p. 17)

◇ Power saver

This item sets the power saver duty cycle—the ratio of receive circuit on to receive circuit off while standing by. The duty cycle can be set to automatic (default) or OFF. Setting to automatic conserves battery power.

AUTO PS

OFF PS

AUTO	Selects "1:4" duty ratio when receiving no signal for 5 sec., then "1:8" 60 sec. after that.
OFF	No power saver function.

OTHER FUNCTIONS 10

◇ **Voltage display**

This item sets the voltage display ON (default) or OFF. When set to ON, battery voltage is briefly displayed after turning power on.

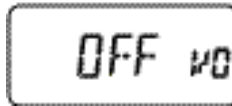
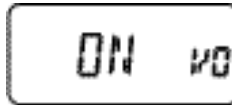

◇ **DTMF speed** (see p. 21)

◇ **Function display contrast**

This item sets the function display contrast to one of two levels—"1" is low contrast and "2" (default) is high contrast.

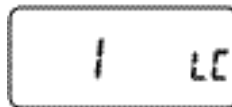
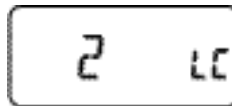

■ **Resetting the CPU**

AT POWER ON

Reset the CPU before operating the transceiver for the first time, or when the internal CPU malfunctions.

➔ While pushing [SQL] + [VFO] + [MR], push [PWR] to turn power on and reset the transceiver's CPU.

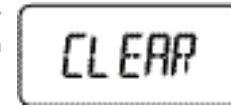

• "CLEAR" appears briefly to indicate the CPU has been reset.

uCAUTION: Resetting the CPU returns all programmed contents to their default settings.



10 OTHER FUNCTIONS

■ Cloning

AT POWER ON

Cloning allows you to quickly and easily transfer the programmed contents from one transceiver to another transceiver; or, data from a PC to a transceiver using the optional CS-T81 CLONING SOFTWARE.

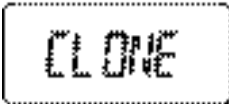
◇ Transceiver-to-transceiver cloning

- ① Connect the OPC-474 CLONING CABLE with adapter plugs to the [SP] jack of the master and slave transceivers.
 - The master transceiver is used to send data to the slave transceiver.
- ② While pushing [MR], push [PWR] to enter cloning mode (master transceiver only—power on only for slave transceiver).
 
 - “CLONE” appears and the transceivers enter the clone standby condition.
- ③ Push [PTT] on the master transceiver.
 
 - “CLOUT” appears in the master transceiver’s display and the S/RF indicator shows that data is being transferred to the slave transceiver.
 - “CL IN” appears automatically in the slave transceiver’s display and the S/RF indicator shows that data is being received from the master trans-

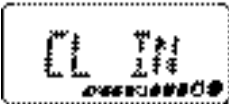

ceiver.

- When cloning is finished, “CLONE” appears in the master transceiver’s display and “CLEND” appears in the slave transceiver’s display.
- ④ When cloning is finished, turn power off, then on again to return to normal operation.

◇ Cloning using a PC

Data can be cloned to and from a PC (IBM compatible) using the optional CS-T81 CLONING SOFTWARE and the optional OPC-478 CLONING CABLE.

◇ Cloning error

- ☞ **NOTE:** DO NOT push the [PTT] on the slave transceiver during cloning. This will cause a cloning error.



When the display at right appears, a cloning error has occurred.

In such a case, memory contents return to their default settings and both transceivers automatically enter VFO mode. Cloning must then be repeated.

TROUBLESHOOTING 11



If your transceiver seems to be malfunctioning, please check the following points before sending it to a service center.

PROBLEM	POSSIBLE CAUSE	SOLUTION	REF.
No power comes on.	<ul style="list-style-type: none"> The battery is exhausted. (A slight current flows in the circuits even when the power is off.) 	<ul style="list-style-type: none"> Charge the battery pack or place new dry cell batteries in the battery case. (Remove the battery pack if you will not be using the transceiver for a long time.) 	pgs. 7, 8
Transmitting is impossible.	<ul style="list-style-type: none"> The battery is exhausted. 	<ul style="list-style-type: none"> Charge the batteries or place new dry cells in the battery case. 	pgs. 7, 8
Frequency cannot be set.	<ul style="list-style-type: none"> Memory (call) mode is selected. The lock function is activated. 	<ul style="list-style-type: none"> Push [VFO] to select VFO mode. Push [(H/L) LOCK] for 1 sec. 	p. 9 p. 11
Scan does not function.	<ul style="list-style-type: none"> The same frequencies are programmed into XA and XB (a pair of scan edges). Only CH00 is programmed; or, all other memory channels are set as skip channels. 	<ul style="list-style-type: none"> Program different frequencies. Program additional memories; or, cancel skip settings for one or more channels. 	p. 18 pgs. 18, 24
[▲] or [▼] keys do not function when using the optional HM-75A.	<ul style="list-style-type: none"> Memory channels 00 and/or 01 are not programmed and simple mode is selected. 	<ul style="list-style-type: none"> Program the memory channels or set to microphone normal 1 or normal 2. 	pgs. 18, 27
Squelch does not open for received signals.	<ul style="list-style-type: none"> Tone squelch is activated. 	<ul style="list-style-type: none"> Turn off the tone squelch. 	p. 25
Some memory channels cannot be selected.	<ul style="list-style-type: none"> Some memories have been cleared. 	<ul style="list-style-type: none"> Program the cleared memories. 	p. 19
RIT/VXO offset cannot be adjusted.	<ul style="list-style-type: none"> RIT/VXO function has not been activated or the 1200 MHz band is not selected. 	<ul style="list-style-type: none"> Activate the RIT/VXO function in set mode or push [MULTI(↔)] to select the 1200 MHz band. 	p. 13
Cannot transmit on the 50 MHz band.	<ul style="list-style-type: none"> AM mode has been set for the 50 MHz band. 	<ul style="list-style-type: none"> Turn AM mode off in set mode. 	p. 14

12 SPECIFICATIONS

GENERAL

•Frequency coverage : (Unit: MHz)

Version	50 MHz	144 MHz	430 MHz	1.2 GHz	WFM*4
USA	50-54 50-52	Rx: 118-174 ¹ Tx: 144-148	Rx: 400-470 ² Tx: 430-450 ²	1240-1300	76-107.995
Europe UK	50-52 (Rx only*)	144-146	430-440	1240-1300	88-107.995
Italy	50-52	136-174 ¹	400-470 ³	1240-1300	88-107.995
Asia	50-54	Rx: 118-174 ¹ Tx: 136-174 ¹	430-440	1240-1300	76-107.995
Australia	50-54	144-148	430-440	1240-1300	88-107.995
Taiwan	N/A	144-146	430-440	1260-1265	76-107.995

*Some versions may be able to transmit.

- Operating mode :FM(F3E), WFM(Rx), AM(Rx)
- No. of memory channels :124 (100 regular, 20 program scan edges and 4 call)
- Tuning steps :5*, 10, 12.5, 15*, 20, 25, 30, 50 and 100 kHz
*Not available for 1200 MHz band.
- Frequency stability :±3 ppm (-10°C to 60°C; 14°F to 140°F)
- Power supply requirements (negative ground):
4.5 to 16 V DC or specified battery pack/case
- Current drain(at 13.5 V DC):
Rx Power saved 40 mA(typ.)
standby 80 mA(typ.; 90 mA: 1200 MHz)
rated audio 220 mA(typ.)
Tx max. power 1.4 A(0.8 A typ.: 1200 MHz)
- Antenna connector :SMA(50)
- Usable temperature range :-10°C to +60°C; +14°F to +140°F
- Dimensions :58(W)×106(H)×28.5(D) mm;
2³/₃₂(W)×4³/₁₆(H)×1¹/₈(D) in
- Weight (approx.) :300 g; 10.6 oz (w/ant. & BP-197)
280 g; 9.9 oz (w/ant. & BP-199)
310 g; 10.9 oz (w/ant. & BP-200)

TRANSMITTER

- Modulation system :Variable reactance modulation
- Output power(at 13.5 V DC) :High 5 W typ. (except 1200 MHz)
1 W (1200 MHz)
Low 0.5 W typ. (0.1 W typ. for 1200 MHz)
- Spurious emissions :Less than -60 dB
(Less than -40 dB for 1200 MHz)
- Max. frequency deviation :±5 kHz
- Ext. microphone connector :3-conductor 2.5(d) mm (1/8)/ 2 k

RECEIVER

- Receive system :Double conversion superheterodyne
- Intermediate frequencies :1st 69.45 MHz (FM)
13.35 MHz (WFM)
2nd 450 kHz
- Sensitivity (except spurious points) :
FM 50 MHz Less than 0.18 μV
(at 12 dB SINAD) 144 MHz Less than 0.18 μV
430(440) MHz Less than 0.18 μV
1200 MHz Less than 0.25 μV
WFM 91.5 MHz Less than 1.99 μV
(at 12 dB SINAD; 1 kHz/52.5 kHz deviation)
- Squelch sensitivity :0.18 μV (FM)
0.25 μV (1200 MHz)
5.6 μV (WFM)
- Spurious and image rejection ration:
50, 144 MHz bands Less than -60 dB
430(440) MHz band Less than -50 dB
1200 MHz band Less than -50 dB
(-50 dB typ. for half IF; except 2nd image, 50 MHz band IF and WFM)
- Audio output power (at 25°C) :250 mW typ.at 10% distortion with an 8 load

OPTIONS 13

◇ Battery packs

BATTERY PACK	VOLTAGE	CAPACITY	OUTPUT POWER	OPERATING PERIOD*
BP-197	Battery case for R6(AA) × 3 alkaline or Ni-Cd cells		0.8 W	10/14 hr
BP-198	4.8 V	700 mAh	1.2 W	6/8.5 hr
BP-199	6.0 V	700 mAh	2.0 W	4/8 hr
BP-200	9.6 V	680 mAh	4.5 W	4/7 hr

*Operating periods are calculated under the following conditions:
 Tx:Rx:standby=1:1 :8;
 Longer operating times are when operating on the 1200 MHz band.

◇ Chargers and cables

BC-110A/C/D/V WALLCHARGER

Regularly charge battery packs attached to the transceiver in 15 hrs.

BC-119 DESKTOP CHARGER+

AD-88 TERMINALPC BOARD FOR CHARGER +

AD-87 BATTERY PACK ADAPTER +

Rapidly charge battery packs in 1 to 1.5 hrs. depending on the battery pack. An AC adapter is packed with the BC-119 (except for the UK version). The AD-87 must be used with the BC-119 for charging the battery pack. The CP-17L or OPC-515L can be used instead of the supplied AC adapter.

CP-12L CIGARETTE LIGHTER CABLE WITH NOISE FILTER

For operation and charging via a 12 V cigarette lighter socket.

OPC-254L DC POWER CABLE

For operation and charging via an external power supply.

◇ Speaker-microphones

HM-46



HM-54



HM-75A



Remote control capability (see p. 27)

HS-85



- PTTswitch
- VOX
- One-touch PTTfor hands-free operation

◇ Others

CS-T81 CLONING SOFTWARE

Allows you to clone the memory contents of an IC-T81 transceiver between transceivers or to a PC for editing.

LC-148 CARRYING CASE

SP-13 EARPHONE

Provides clear receive audio in noisy environments.

14 MODE ARRANGEMENT

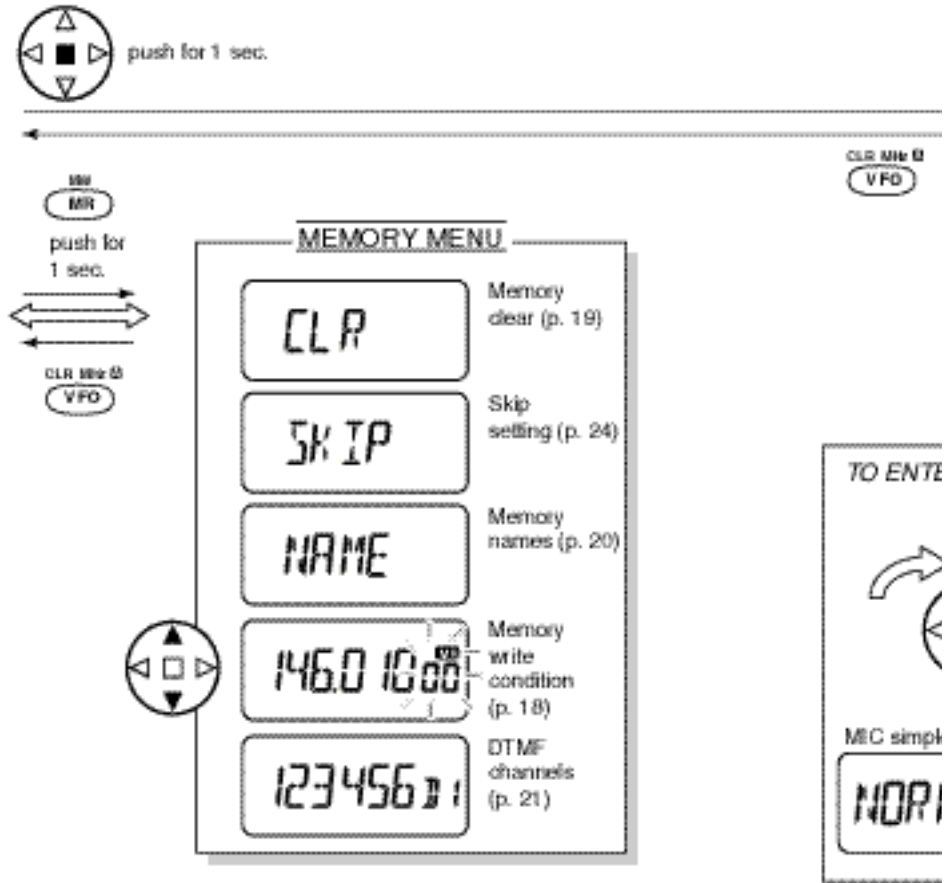
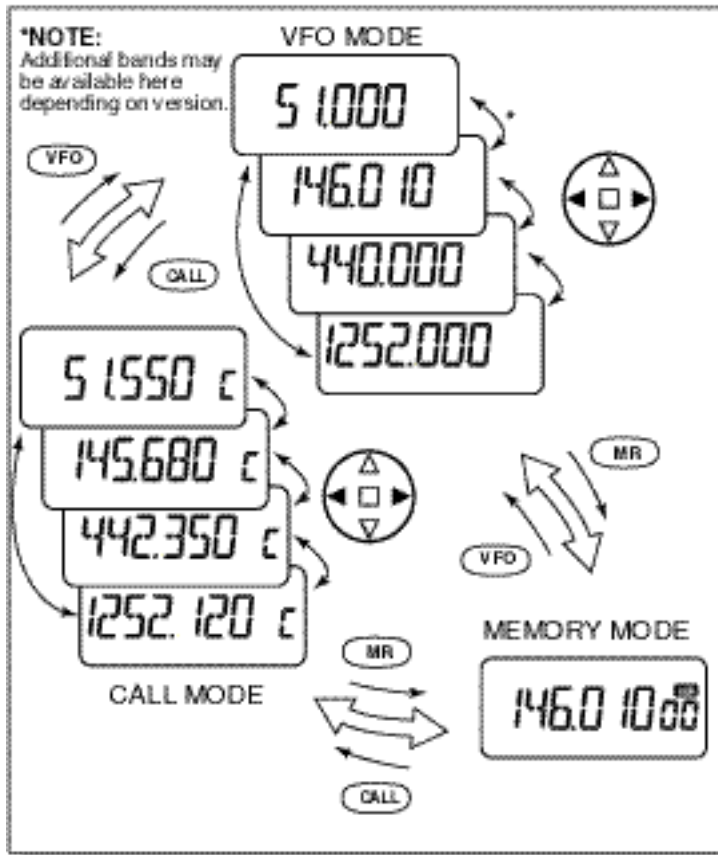

MODE ARRANGEMENT 14

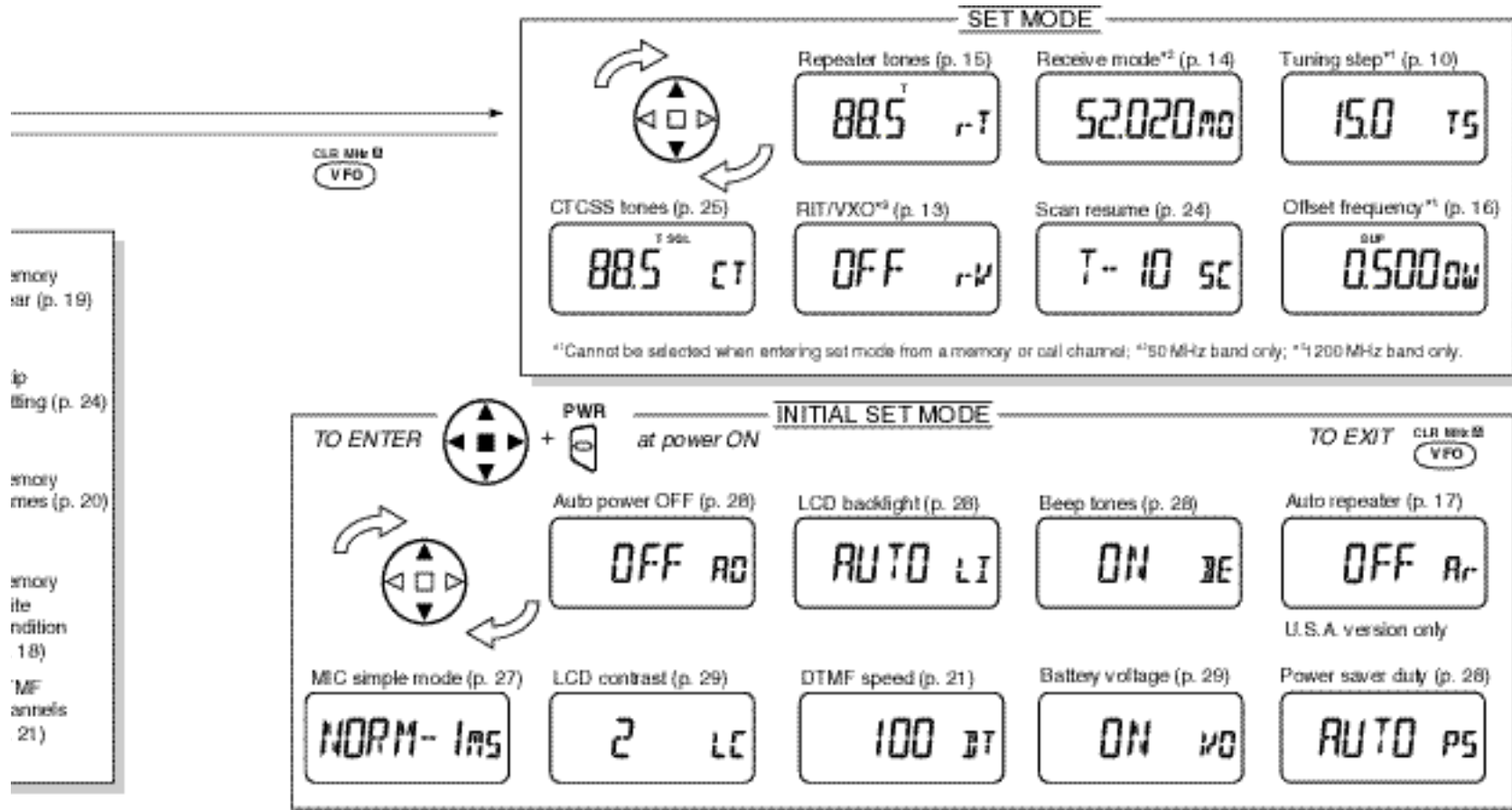

memory
call (p. 19)

memory
recall (p. 24)

memory
names (p. 20)

memory
list
condition
(p. 18)

MF
channels
(p. 21)

Count on us!



A-5518D-1EX
Printed in Japan
© 1998 Icom Inc.

Icom Inc.
6-9-16 Kamihigashi, Hirano-ku, Osaka 547-0002 Japan