

**Professional Weather Center  
Model: WMR200 / WMR200A**

**USER MANUAL**

**CONTENTS**

**Introduction**..... 1

**Packaging Contents** ..... 1

    Main Unit..... 1

    Wind Sensor / Temperature & Humidity Sensor..... 1

    Solar Panel ..... 1

    Rain Gauge..... 1

    Assembly Parts ..... 2

**Accessories - Sensors** ..... 2

**Overview**..... 2

    Front View ..... 2

    Back View ..... 2

    LCD Display ..... 2

**Detailed LCD Display View** ..... 2

    Barometer ..... 2

    Rainfall ..... 3

    UV ..... 3

    Clock / Moon Phase ..... 3

    Outdoor Temperature / Humidity ..... 3

    Indoor Temperature / Humidity ..... 3

    Wind Speed / Direction / Wind Chill ..... 3

    Bar Chart..... 3

    Wind Sensor ..... 4

    Rain Gauge ..... 4

    Outdoor Temperature / Humidity Sensor ..... 4

**Getting Started**..... 4

    Set Up Remote Wind Sensor ..... 4

    Set Up Remote Temperature / Humidity Sensor..... 4

    Remote Unit Assembly ..... 5

    Alternative Set Up: Remote Wind Sensor On Existing Pole ..... 6

    Temperature / Humidity Sensor Mounted Separately ..... 6

    Set up Rain Gauge..... 6

**Getting Started**..... 7

    Set up Base Station ..... 7

    Insert Batteries ..... 7

    Sensor Data Transmission ..... 7

**Clock**..... 7

    Clock Reception ..... 7

    Manually Set Clock ..... 8

**Pressure** ..... 8

    Set Altitude ..... 8

**Rainfall**..... 8

    Accumulated Rainfall ..... 8

**UV** ..... 8

**Weather Forecast** ..... 8

**Temperature and Humidity** ..... 8

    Auto Scanning Function ..... 8

    Temperature and Humidity trends..... 8

**Heat Index** ..... 8

**Wind**..... 9

**Moon Phase** ..... 9

**Bar Chart** ..... 9

**Alarm** ..... 9

**Memory**..... 9

    MAX / MIN Records ..... 9

    Hourly Records ..... 9

    Data Logger ..... 9

**Reset** ..... 10

**Troubleshooting** ..... 10

**Precautions** ..... 10

**Specifications** ..... 10

**About Oregon Scientific** ..... 11

**EU-Declaration Of Conformity**..... 11

**FCC Statement** ..... 11

    Declaration of Conformity..... 11

**INTRODUCTION**

Thank you for selecting the Oregon Scientific™ Professional Weather Center (WMR200 / WMR200A).

The base station is compatible with other sensors. To purchase additional sensors, please contact your local retailer.

Sensors with this logo  are compatible with this unit.

**NOTE** Please keep this manual handy as you use your new product. It contains practical step-by-step instructions, as well as technical specifications and warnings you should know about.

**PACKAGING CONTENTS**

**MAIN UNIT**

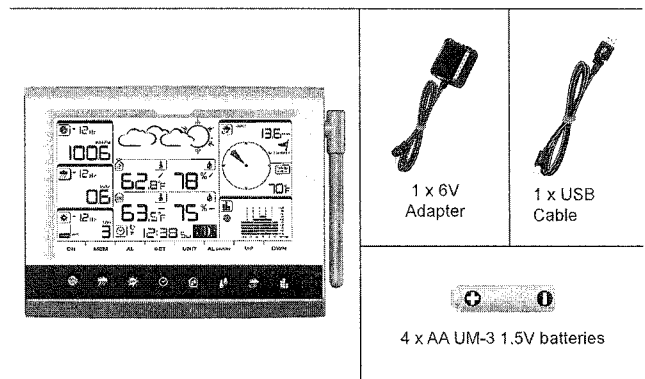

**WIND SENSOR, TEMPERATURE & HUMIDITY SENSOR**

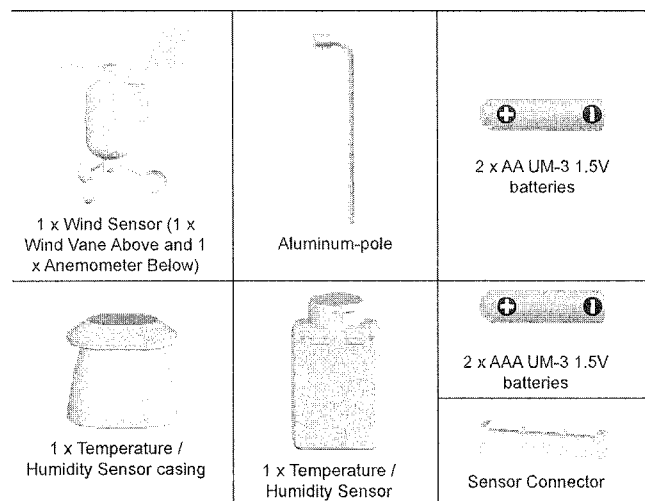

**SOLAR PANEL**

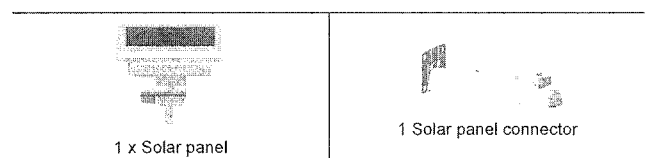

**RAIN GAUGE**

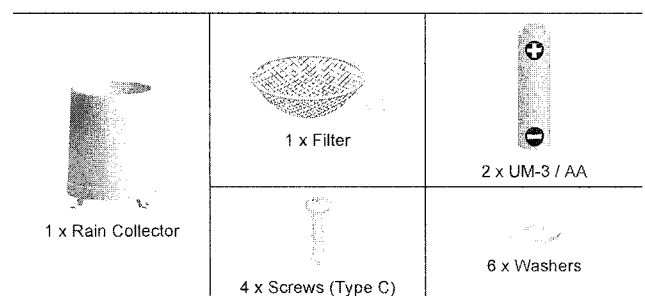

## ASSEMBLY PARTS

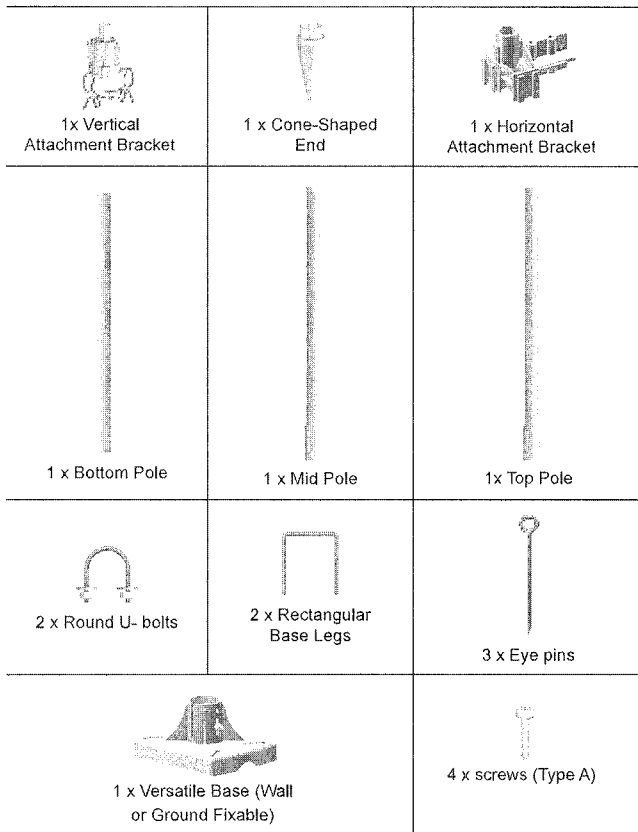

## ACCESSORIES - SENSORS

This product can work with up to 10 sensors at any one time to capture outdoor temperature, relative humidity or UV readings in various locations.

Optional wireless remote sensors such as those listed below can be purchased separately. For more information, please contact your local retailer.\*

- Thermo-hygro THGR800 (3-Ch)
- Thermo-hygro THGR810 (10-Ch)
- UV UVN800

\* Features and accessories will not be available in all countries.

## OVERVIEW

## FRONT VIEW

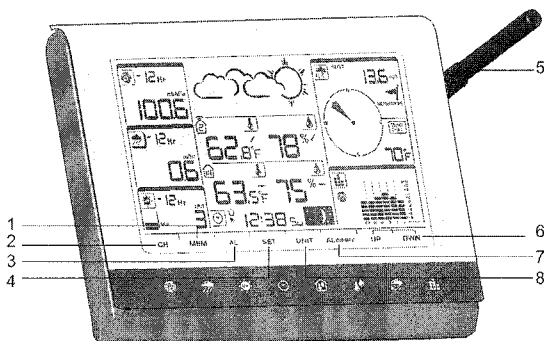

- MEM: View current, maximum and minimum readings
- CH: Toggle between 10 different channels
- AL: Set and view status of Clock and HI / LO alarms
- SET: Enter setting modes
- Antenna
- UP / DWN: Increase / decrease the values of the selected readings
- AL ON/OFF: Turn alarms on and off
- UNIT: Change display units

## BACK VIEW

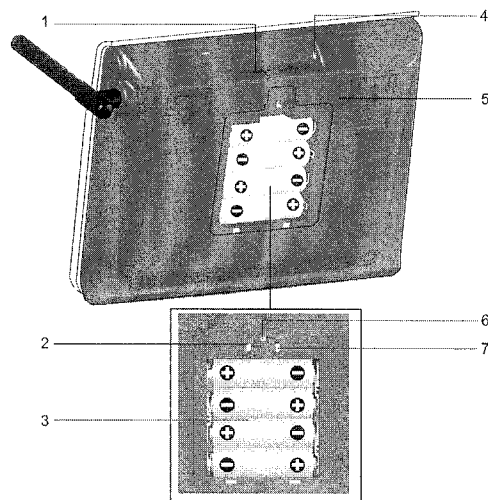

- USB socket
- Backlight (continuous) On/Off
- Battery compartment
- AC / DC socket
- Wall mount holes / Adjustable table stand
- RESET: Reset unit to default settings
- EU/UK slide switch (WMR200 only)

## LCD DISPLAY

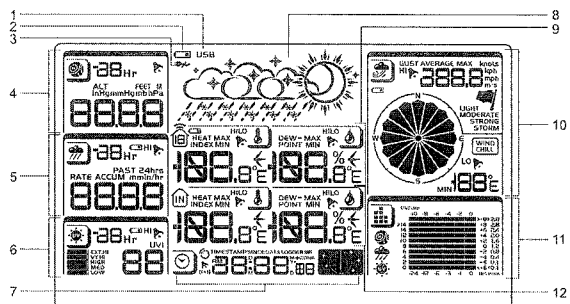

- Indicates a successful USB connection
- Indicates low battery
- Indicates no main power supply
- Barometer area
- Rainfall area
- UV area
- Clock / alarm / moon phase area
- Weather forecast area
- Outdoor temperature and humidity area
- Wind area
- Bar chart area
- Indoor temperature / humidity area

## DETAILED LCD DISPLAY VIEW

## BAROMETER

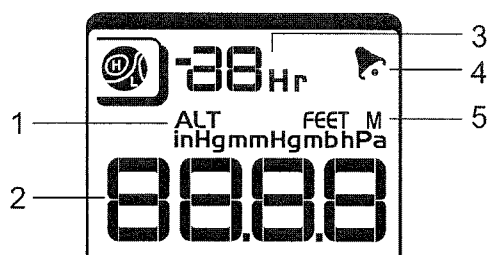

- Altitude indicator
- Altitude / pressure reading
- 0 (current) to - 24 hours barometer record

4. Indicates pressure alarm is ON
5. User selectable altitude / pressure measurement unit

**RAINFALL**

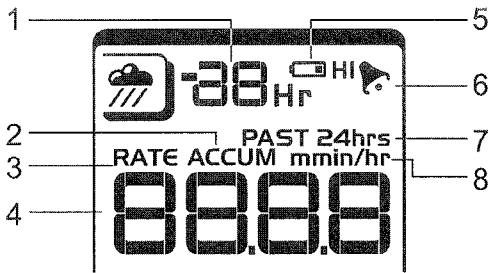

1. 0 (current) to - 24 hours rainfall record /
2. Accumulated total rainfall (refer to SINCE date stamp in clock area for further details)
3. Rain rate indicator
4. Rain reading
5. Sensor batteries low
6. Indicates high rainfall alarm is ON
7. Shows accumulated rainfall of past 24 hours
8. Rainfall unit

**UV**

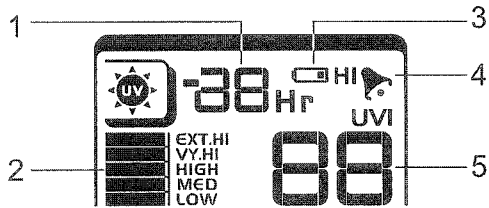

1. 0 (current) to - 10 hours UV record
2. UV level index
3. Sensor batteries low
4. Indicates high UV alarm is ON
5. UVI reading

**CLOCK / MOON PHASE**

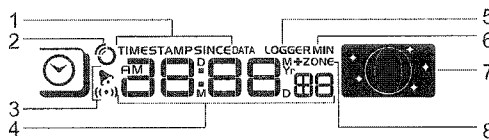

1. Displays time of records, time stamp for Indoor / Outdoor temperature / humidity sensors and initial date set (Since date) for rainfall.
2. Radio controlled clock
3. indicates daily alarm is ON
4. Displays Clock with seconds, Clock with day, Calendar, Data logger
5. Data Logger displaying remaining number of days memory will allow for data collection
6. Set Data Logging frequency (refer to Memory section)
7. Moon phase display
8. Offset time zone

**OUTDOOR TEMPERATURE / HUMIDITY**

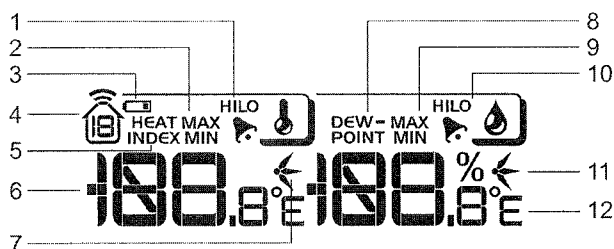

1. Indicates HI / LO outdoor temperature alarms are ON
2. MAX / MIN temperatures (refer to date stamp on clock area for more details)
3. Sensor batteries low
4. Displays from 1-10 outdoor sensors
5. Heat index
6. Outdoor Temperature readings
7. Temperature trend indicators
8. Dew point temperature
9. MAX / MIN humidity
10. Indicates HI / LO outdoor humidity alarms are ON
11. Humidity trend indicators
12. User selectable temperature units

**INDOOR TEMPERATURE AND HUMIDITY**

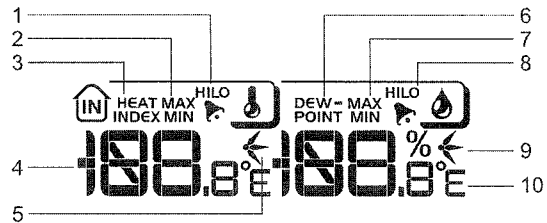

1. Indicates HI / LO temperature alarms are ON
2. MAX / MIN temperatures
3. Heat index
4. Indoor temperature reading
5. Temperature trend indicators
6. Dew point temperature
7. MAX / MIN indoor humidity
8. Indicates HI / LO humidity alarms are ON
9. Humidity trend indicators
10. User selectable temperature units

**WIND SPEED / DIRECTION / WIND CHILL**

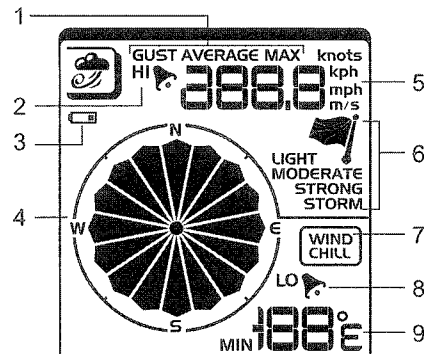

1. User selectable measured winds: Gust / Average; Displays MAX wind speeds recorded
2. Indicates HI alarm is ON
3. Sensor batteries low
4. Wind direction indicator
5. User selectable wind speed units
6. Wind speed level indicator
7. Wind chill temperature display
8. Indicates LO windchill alarm is ON
9. Windchill reading

**BAR CHART**

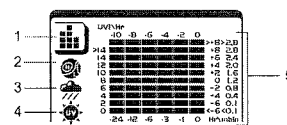

1. Bar chart icon area
2. Barometer bar chart display
3. Rainfall bar chart display
4. UV bar chart display
5. Measurement axis

## WIND SENSOR

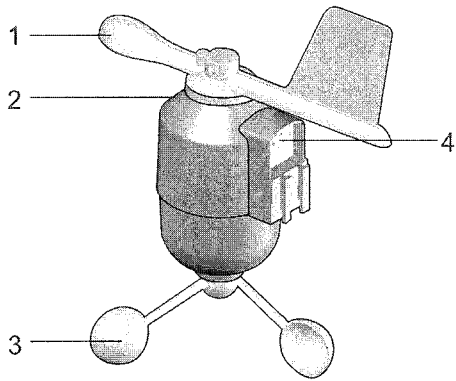

1. Wind Direction
2. Wind vane casing
3. Anemometer
4. Solar power socket

## RAIN GAUGE

Base and funnel:

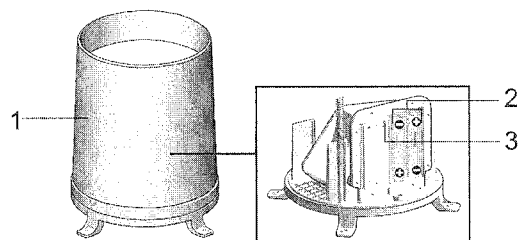

1. Rain Gauge
2. Battery compartment
3. RESET button

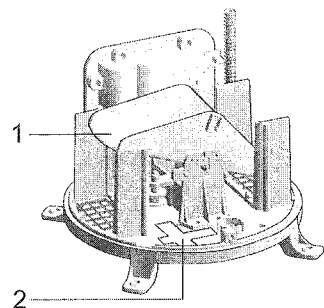

1. Funnel
2. Indicator

## OUTDOOR TEMPERATURE / HUMIDITY SENSOR

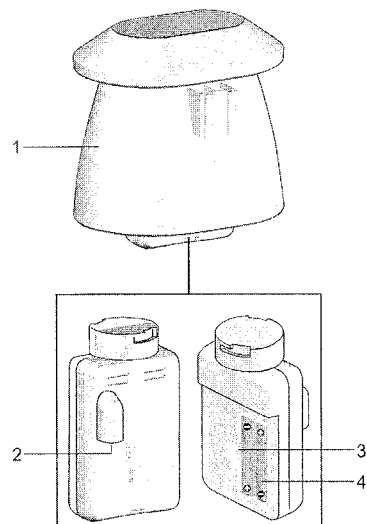

1. Temperature / humidity sensor casing
2. Solar power socket
3. RESET button
4. Battery compartment

## GETTING STARTED

## SETUP: REMOTE WIND SENSOR

The wind sensor takes wind speed and direction readings.

The sensor is battery and solar powered operated. It is capable of transmitting data to the base station wirelessly within an approximate operating range of 100 meters (328 feet).

**IMPORTANT** Ensure that the wind sensor is pointing North to enable it to record accurate readings.

**NOTE** The sensor should be positioned in an open area away from trees or other obstructions.

To insert batteries:

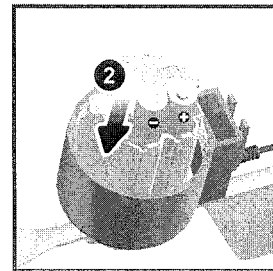
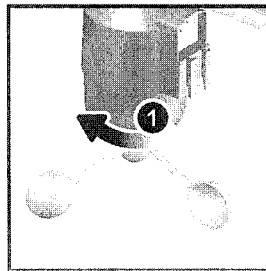

1. Unscrew the anemometer from the wind sensor carefully.
2. Insert batteries matching the polarities (+ / -) and replace the anemometer. Press RESET after each battery change.

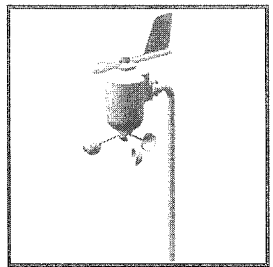
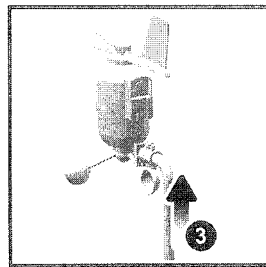

3. Slide wind vane onto the end of the plastic attachment located on the aluminium pole.

**NOTE** Use alkaline batteries for longer usage and consumer grade lithium batteries in temperatures below freezing.

## SETUP: REMOTE TEMPERATURE / HUMIDITY SENSOR

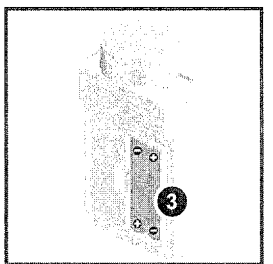
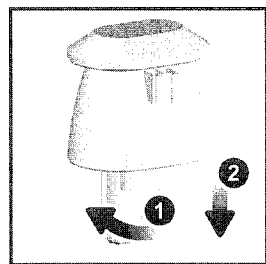

1. Holding sensor, twist and click to the left.
2. Pull sensor away from casing.
3. Insert batteries matching the polarities (+ / -). Press RESET after each battery change.

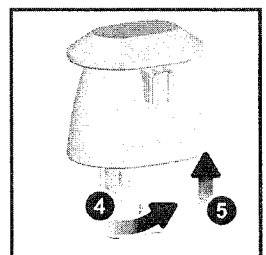

4. Insert sensor into the casing, twist and click to the right to secure.
5. Slide temperature and humidity sensor onto the smaller end of the sensor connector.

**REMOTE UNIT ASSEMBLY**

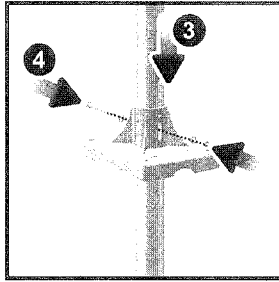
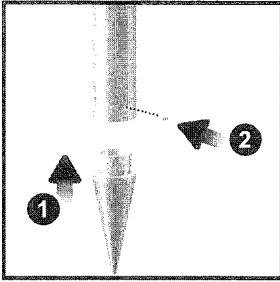

1. Insert the cone-shaped end into the pole.
2. Using 2 screws, fix it firmly into place.
3. Insert the versatile plastic base into the pole. Align the holes of the pole with the holes of the plastic base.
4. Secure the plastic base by inserting the screw and screwing it tightly into the holes of the plastic base and pole.

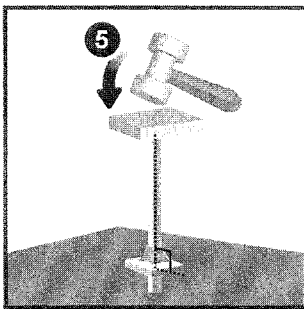

**IMPORTANT** The sensor should be positioned in an open area away from trees or other obstructions.

5. Hammer pole (cone end down) into the ground at the desired spot until versatile plastic base is level with the ground.

**TIP** Place a block of wood between the pole and the hammer to prevent damage to the pole.

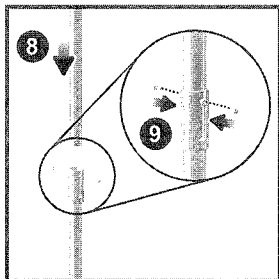
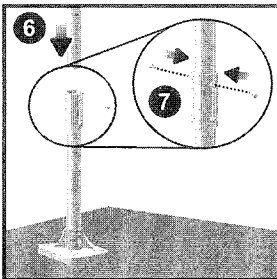

6. Assemble middle pole on top of the bottom one.
7. Using two screws, fix it firmly into place.
8. Assemble top pole on top of the middle one.
9. Using two screws, fix it firmly into place.

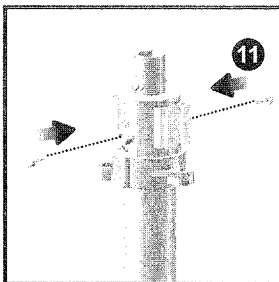
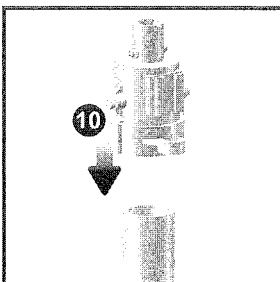

10. Slide the vertical attachment bracket on top of the top pole.
11. Using two screws, fix it firmly into place.

**To mount the temperature / humidity sensor:**

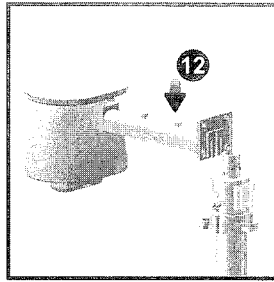

12. Slide outdoor sensor onto vertical attachment bracket.

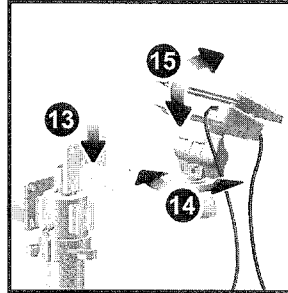

13. Slide the solar panel connector into place on the opposite side of the bracket. Slot the solar panel in place.
14. Adjust the solar panel. Once facing desired direction, use screw to fix in place.
15. Loosen the wing bolt and adjust the angle. Tighten wing bolt to secure solar panel at desired angle.

**NOTE** For best results, direct solar panel as follows:

Solar panel facing:	if you reside in the:
North	Southern Hemisphere
South	Northern Hemisphere

**To mount the wind sensor:**

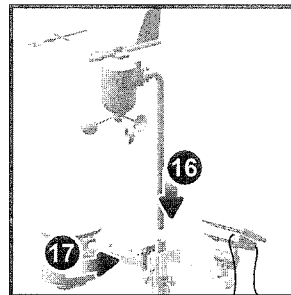

16. Insert the wind vane into the attachment bracket.
17. Screw aluminum pole firmly into place.

**IMPORTANT** For best results, point the wind vane North.

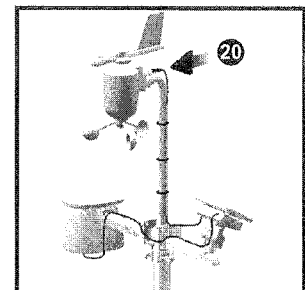
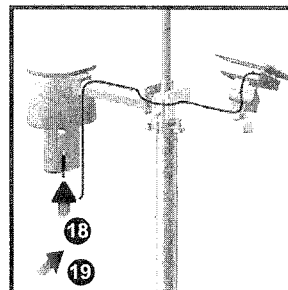

18. Remove outdoor sensor from casing. Plug one solar panel cable into the socket.
19. Replace sensor into the casing.
20. Plug the other solar panel cable into the socket on the wind vane.

This will provide the sensors with an additional power supply.

**NOTE** There are slots to insert the solar power cables for convenient storage. There are also fasteners to help tighten the cables.

**NOTE** The Solar panel is an energy saving feature, which is an environmentally friendly way to provide additional power to the sensors and prolongs battery life. However, it cannot replace battery power entirely. Sensors can operate entirely on battery power.

### Securing the assembled remote unit:

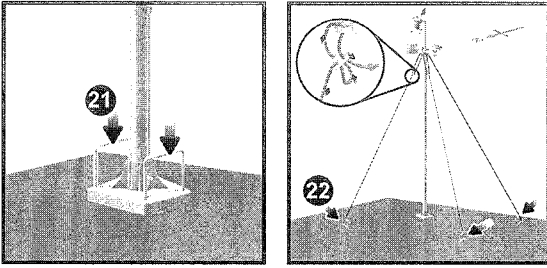

21. Insert the 2 rectangular base legs through the holes of the versatile base and hammer down.
22. Using the string, tie a knot on the eye pins. Hammer each eye pin into the ground at a 90° angle.

**IMPORTANT:** Using the fasteners, tighten the string. To tighten, pull fastener down. To loosen, thread the string up through the fastener eyelets.

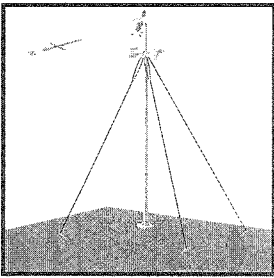

### ALTERNATIVE SET UP: REMOTE WIND SENSOR ON EXISTING POLE

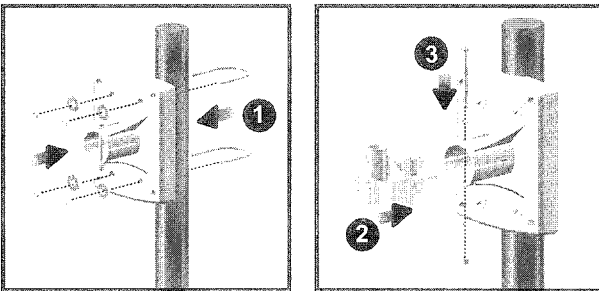

1. Secure the plastic base onto existing pole with U-bolts, washers and bolts.
2. Insert the horizontal attachment bracket into the base.
3. Using a screw, fix firmly into place.

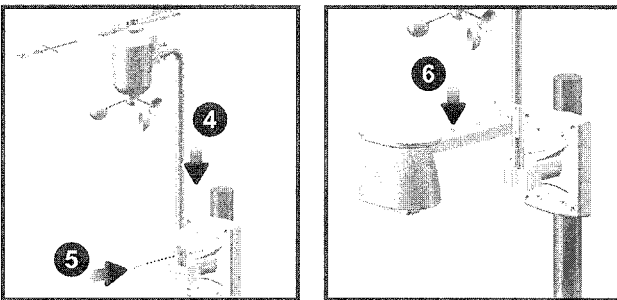

4. Insert wind sensor into the top of the bracket.
5. Using screws, fix aluminum pole firmly into place.
6. Slide outdoor sensor onto bracket.

**IMPORTANT:** For best results, point the wind vane North.

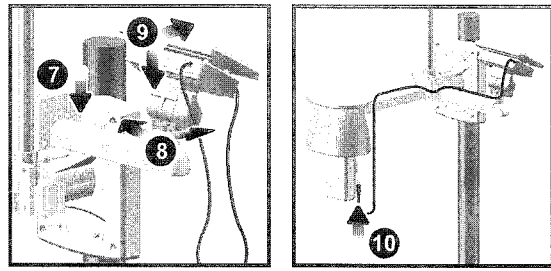

7. Slide the solar panel connector into place on the other side of the bracket. Slot the solar panel in place.
8. Adjust the solar panel. Once facing desired direction, use screw to fix in place.
9. Loosen the wing bolt and adjust the angle. Tighten wing bolt to secure solar panel at desired angle.
10. Remove outdoor sensor from casing. Plug one solar panel cable into the socket. Replace sensor into the casing.

**NOTE:** For best results, direct solar panel as follows:

Solar panel facing:	If you reside in the:
North	Southern Hemisphere
South	Northern Hemisphere

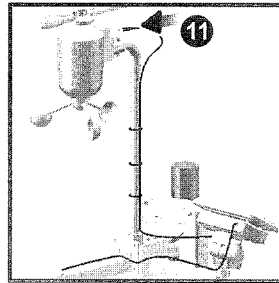

11. Plug the other solar panel cables into the socket on the wind vane.

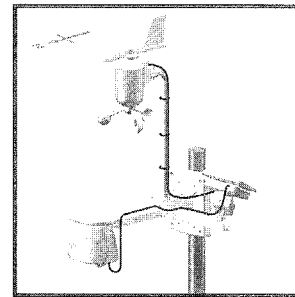

**NOTE:** There are slots to insert the solar power cable for convenient storage. There are also fasteners to help tighten the cables.

### ALTERNATIVE SET UP: TEMPERATURE/HUMIDITY SENSOR MOUNTED SEPARATELY

1. Insert 4 type A screws into the holes of the sensor connector. Screw firmly into place, i.e., fence.

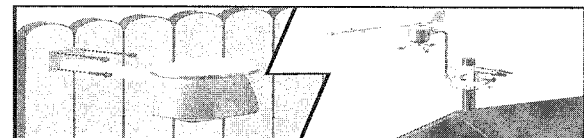

### SET UP RAIN GAUGE

The rain gauge collects rain and takes readings of rainfall rate and the total rainfall over a period of time. The sensor can remotely transmit data to the base station.

The base station and rain gauge should be positioned within an effective range: about 100 meters (328 Feet) in an open area.

The rain gauge should be mounted horizontally about 1 meter (3 feet) from the ground in an open area away from trees or other obstructions to allow rain to fall naturally for an accurate reading.

**To set up the Rain Gauge:**

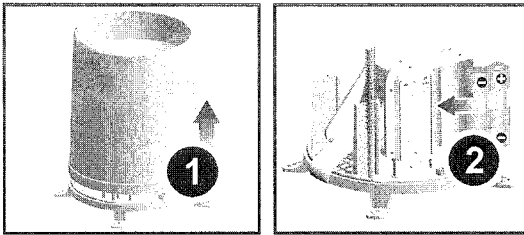

1. Remove screws and slide the cover off in an upwards motion.
2. Insert the batteries (2 x UM-3 / AA), matching the polarities (+ / -). Press **RESET** after each battery change.

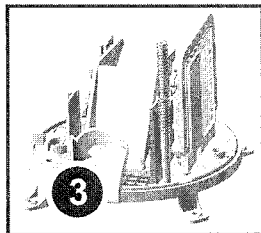

3. Remove the fibre tape.

**To ensure a level plane:**

Put a few drops of water on the cross at the base of the funnel to check the horizontal level.

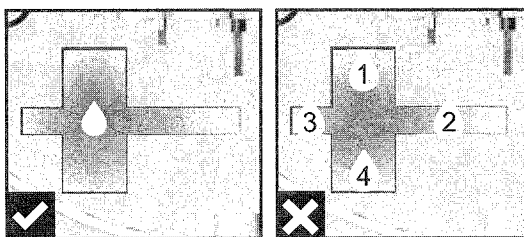

Water will pool to the center of the cross when the rain gauge is level.

If water remains on 1-4, the gauge is not horizontal.  
If necessary, adjust the level using the screw.

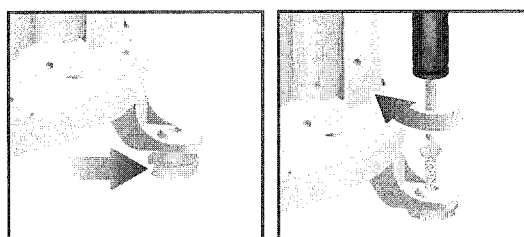

**NOTE:** For best results, ensure the base is horizontal to allow maximum drainage of any collected rain.

**GETTING STARTED**

**SET UP BASE STATION**

**NOTE:** Install batteries matching the polarities (+ / -) in the remote sensor before installing the base station.

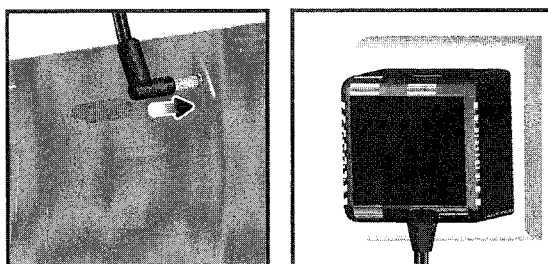

For continuous use, install the AC adapter. The batteries are for back-up use only.

**NOTE:** Please make sure the socket-outlet is installed near the equipment and is easily accessible.

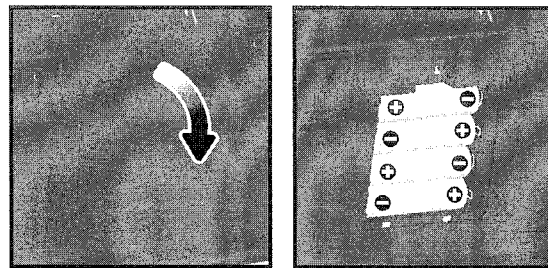

Install the base station batteries (4 x UM-3 / AA) matching the polarity (+ / -). Press **RESET** after each battery change.

**NOTE:** Do not use rechargeable batteries. It is recommended that you use alkaline batteries with this product for longer performance.

**INSERT BATTERIES**

1. Remove the battery compartment.
2. Insert the batteries, matching the polarities (+ / -).
3. Press **RESET** after each battery change.

LOCATION	MEANING
Weather forecast area	Main unit batteries low
Rainfall / UV / Wind / Outdoor temperature / humidity area	Sensor batteries low

**SENSOR DATA TRANSMISSION**

**To search for a sensor:**

1. Select desired area to activate.
2. Press and hold **CH** and **MEM**.
3. icons will flash for 5 minutes.

**NOTE:** Unit will search only for already registered sensors or new sensors reset within last 30 minutes. To register a new sensor, reset sensor prior to search.

The sensor reception icon in the remote sensor area shows the status:

ICON	DESCRIPTION
	Main unit is searching for sensor(s)
	A channel has been found
	Sensor 1 data received
	The sensor cannot be found.

**TIP:** The transmission range may vary depending on many factors. You may need to experiment with various locations to get the best results.

**CLOCK**

**CLOCK RECEPTION**

This product is designed to synchronize its clock automatically with a clock signal.

**WMR200:**

Slide switch to **EU / UK** to select the desired signal.

- EU: DCF-77 signal: within 1500km (932 miles) of Frankfurt, Germany.
- UK: MSF-60 signal: within 1500km (932 miles) of Anthorn, England.

**WMR200A:**

WWVB-60 signal: within 3200km (2000 miles) of Fort Collins Colorado. Manually set clock to select time zone (Pacific, Mountain, Central or Eastern).

indicates the status of the clock reception signal.

ICON	MEANING
	Time is synchronized Receiving signal is strong
	Time is not synchronized Receiving signal is weak

**NOTE** Reception takes 2-10 minutes. If the signal is weak, it can take up to 24 hours to get a valid signal.

To enable / disable signal reception:

Press and hold **Clock area**  to enable / disable signal reception. A beep will sound to confirm action.

**NOTE** For best reception, the base station should be placed on a flat, non-metallic surface near a window in an upper floor of your home. The antenna should be placed away from electrical appliances and not be moved around when searching for a signal.

#### MANUALLY SET CLOCK

1. Press **Clock area**  to activate.
2. Press **SET** to toggle between time zone offset, 12/24 hr format, hour, minute, year, day / month, month, day, time zone.
3. Once in desired setting, press **UP** or **DWN** to change the settings.
4. Press:
  - **SET** to confirm and continue to next setting OR
  - touch panel area (except tool bar) to confirm and exit.

**WMR200:** Time zone offset sets the clock +/- 23 hours from the received clock signal time.

**WMR200A:** Select the time zone: (PA) Pacific, (EA) Eastern, (CE) Central or (MO) Mountain.

**NOTE** The language options are English (E), German (D), French (F), Italian (I), and Spanish (S).

To select clock display mode:

Press **clock area**  repeatedly to toggle between:

- Clock with seconds
- Clock with weekday
- Date with year
- Data logger (please refer to Memory / Data logger section)

#### PRESSURE

To toggle barometer unit:

1. Press **barometer area**  to toggle between Altitude / current barometer.
2. Press **UNIT** to select FEET / M or inHg / mmHg / mb / hPA.

#### SET ALTITUDE

Set the altitude to reflect distance from sea level at your position.

1. Press **barometer area**  to display ALT.
2. Press **SET**.
3. Press **UP** / **DWN** to set the altitude in 10 m (33 ft) increments from -100 m (-328 ft) to 2500 m (8202 ft).
4. Press **SET** or touch panel area (except tool bar / forecast area) to confirm.

#### RAINFALL

To select rainfall display mode:



Press **rain area**  to toggle between:

- Rain rate
- Hourly Rainfall
- Accumulated rainfall
- Rainfall recorded in the past 24 hours

Press **UNIT** to select mm / in.

#### ACCUMULATED RAINFALL

To display **SINCE DATE**:

1. Press **rain area**  repeatedly until Accumulated Rainfall display. (**Clock area**  will display the start date / time of rainfall recording).

To reset **SINCE DATE**:

Press and hold **MEM** to set current time as start of accumulated rainfall records.







#### UV

The UV index levels are as follows:

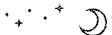
UV INDEX	DANGER LEVEL	ICON
0-2	Low	<b>LOW</b>
3-5	Moderate	<b>MED</b>
6-7	High	<b>HI</b>
8-10	Very high	<b>V.HI</b>
11 and above	Extremely high	<b>EX.HI</b>

#### WEATHER FORECAST

This product forecasts the next 12 to 24 hours of weather within a 30-50 km (19-31 mile) radius (US- with a 75% accuracy).

	Sunny
	Clear night
	Partly cloudy
	Partly cloudy at night
	Cloudy
	Rainy
	Snowy

#### TEMPERATURE AND HUMIDITY

To toggle temperature unit:

1. Press **Indoor**  / **Outdoor**  Temperature / Humidity area.
2. Press **UNIT** to select °C / °F.

To auto-scan between sensors (Outdoor):

1. Press **Outdoor Temperature / Humidity area**.
2. Press and hold **CH** to display data for each sensor.

#### AUTO SCANNING FUNCTION

To activate the outdoor temperature and humidity auto-scan function:

1. Press and hold **CH** to activate auto-scan. The temperature and humidity display will scroll from indoor to ch1 through to ch10.
2. Press **CH** / **MEM** to stop the auto-scan.

**NOTE** Channel 1 is used for the outdoor temperature and humidity sensor provided in this package. Additional temperature and humidity sensors can use other channels.



To change channel:

Press **CH** to change channel.

#### TEMPERATURE AND HUMIDITY TRENDS

The temperature and humidity trend icons are based on recent sensor readings.

The trend lines are shown next to the temperature and humidity readings. The trend is shown as follows:

RISING	STEADY	FALLING
		

#### HEAT INDEX

Press **Indoor**  / **Outdoor**  Temperature / Humidity area to display the actual temperature felt:

TEMPERATURE RANGE	WARNING	MEANING
27°C to 32°C (80°F to 89°F)	Caution	Possibility of heat exhaustion
32°C to 40°C (90°F to 104°F)	Extreme Caution	Possibility of heat dehydration



41°C to 54°C (105°F to 129°F)	Danger	Heat exhaustion likely
54°C to 92°C (130°F to 151°F)	Extreme danger	Strong risk of dehydration / sun stroke

**NOTE:** Heat index is only calculated when temperature is 80° F / 27°C or above.

**WIND**





To select wind display mode:

Press wind area  to toggle between:

- Gust
- Average









Press UNIT to select unit: knots / kph / mph / m/s.

The wind level is shown by a series of icons:

Lost sensor	Light	Moderate	Strong	Storm
	0-8 mph (3-13 km/h)	9-25 mph (14-41 km/h)	26-54 mph (42-87 km/h)	>55 mph (>88 km/h)
				

**MOON PHASE**

1. Press clock area  to activate.
2. Press SET repeatedly to display Year / Calendar date.
3. Press UP / DWN to view moon phase for specific dates.

	New Moon		Full Moon
	Waxing Crescent		Waning Gibbous
	First quarter		Last quarter
	Waxing Gibbous		Waning Crescent

**BAR CHART**

To select chart display mode:

Press bar chart area  to toggle between these chart displays:

- Barometer
- Rain
- UV

**ALARM**

Weather alarms are used to alert you of certain weather conditions. Once activated, the alarm will turn off when a certain criterion is met.

Area	Type of alarm	
Barometer	Barometer	HI
Rain	Rain rate	HI
UV	UV	HI
Temperature	Current Temperature	HI
		LO
	Heat Index	HI
Humidity	Current Humidity	HI
		LO
	Dew Point	HI
		LO
Clock	Daily Alarm	
Wind	Gust Wind Speed	HI
	Low Wind Chill	LO

To set the alarm:

1. Press desired area to activate.
2. Press ALARM to display Time and HI / LO alarm.
3. Press and hold ALARM.

4. Press UP / DWN to set the desired values.
5. Press
  - ALARM to confirm and continue to next setting OR.
  - touch anywhere on the screen (except tool bar / weather forecast area) to confirm and exit.

To enable / disable alarms:

1. Press desired area to activate.
  2. Press ALARM to display set Time and HI / LO alarm.
  3. Press ALARM ON/OFF to turn alarm ON / OFF.
- "- -" indicates alarm is not set / disabled.

**NOTE:** Clock alarm sound is different from weather alarms to allow for easy differentiation by user.

To silence any alarm: Press anywhere on the screen.

**NOTE:**  will continue flashing, despite silenced alarm, for at least 2 minutes or until condition ceases.

**NOTE:** When alarm is on, the channel of triggered alarm will be displayed.

**MEMORY**

**MAX / MIN RECORDS**

Area	Type of Memory	
Temperature	Current Temperature	MAX
		MIN
	Heat Index	MAX
		MIN
Humidity	Current Humidity	MAX
		MIN
	Dew Point	MAX
		MIN
Wind	Gust Wind Speed	MAX
	Wind Chill	MIN

To view MAX / MIN records:

1. Press desired area to activate.
2. Press MEM to toggle between MIN / MAX recorded values.

To clear individual area records:

1. Press desired area to activate.
2. Press and hold MEM.
3. Delete process is complete when display shows current reading.

**HOURLY RECORDS**

Display	Hourly readings of up to
Barometer	24 hours back
Hourly Rainfall	24 hours back
UV	10 hours back

To view hourly records:

1. Press desired area to activate.
2. Press UP / DWN to view current (0) / hourly reading.

When MAX / MIN reading is displayed, the corresponding timestamp will be displayed in the clock area .

**DATA LOGGER**

To set DATA LOGGER:

1. Press clock area  until DATA LOGGER mode is displayed.
2. Press SET.
3. Press UP / DWN to select frequency of data recording (1 / 2 / 5 / 10 / 15).
4. Press SET.
5. Number of days memory will allow for records will be displayed.

Frequency in minutes	No. of days available for data logging with Memory available*
1	29
2	58
5	145
10	291
15	436

\* based only on all provided sensors in this package being used, and after all memory has been cleared.

To view remaining days for records:

Press **clock area**  until DATA LOGGER mode is displayed.

**NOTE:** When DATA LOGGER is full, i.e., no more records can be stored on unit, 'DATA LOGGER' and 'O Days' will flash.

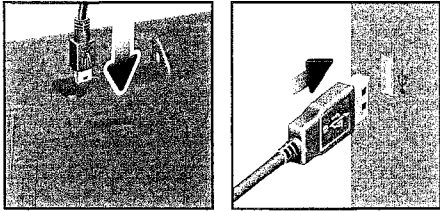

To upload records to PC:

Plug USB and upload onto computer.



**NOTE:** PC program provided must be installed before uploading of records from main unit.

To clear records:

1. Press **clock area**  until DATA LOGGER is displayed.
2. Press and hold **MEM**.
3. All LED icons will light up and turn off consecutively (right to left). Delete process is complete and successful after blinking of last icon .

## RESET

Press **RESET** to return to the default settings.

## TROUBLE SHOOTING

PROBLEM	SYMPTOM	REMEDY
Barometer	Strange readings	Set unit
Calendar	Strange date / month	Change language
Clock	Cannot adjust clock	Disable radio-controlled clock
	Cannot auto-synch	<ol style="list-style-type: none"> <li>1. Adjust batteries</li> <li>2. Press <b>RESET</b></li> <li>3. Manually activate radio controlled clock</li> </ol>
Temp	Shows "LL" or "HH"	Temperature is out-of-range
Remote sensor	Cannot locate remote sensor	<ol style="list-style-type: none"> <li>1. Check batteries</li> <li>2. Check if sensors are within range</li> </ol>

## PRECAUTIONS

- Do not subject the unit to excessive force, shock, dust, temperature or humidity.
- Do not cover the ventilation holes with any items such as newspapers, curtains etc.
- Do not immerse the unit in water. If you spill liquid over it, dry it immediately with a soft, lint-free cloth.
- Do not clean the unit with abrasive or corrosive materials.
- Do not tamper with the unit's internal components. This invalidates the warranty.
- Only use fresh batteries. Do not mix new and old batteries.
- Images shown in this manual may differ from the actual display.
- When disposing of this product, ensure it is collected separately for special treatment.
- Placement of this product on certain types of wood may result in damage to its finish for which Oregon Scientific will not be responsible. Consult the furniture manufacturer's care instructions for information.
- The contents of this manual may not be reproduced without the permission of the manufacturer.
- Do not dispose old batteries as unsorted municipal waste. Collection of such waste separately for special treatment is necessary.
- Please note that some units are equipped with a battery safety strip. Remove the strip from the battery compartment before first use.

**NOTE:** The technical specifications for this product and the contents of the user manual are subject to change without notice.

## SPECIFICATIONS

<b>GENERAL</b>	
Dimensions (L x W x H)	149 x 198 x 47 mm (5.9 x 7.8 x 1.9 inches)
Weight	510 g (1.12 lbs) without battery
<b>BAROMETER</b>	
Barometer unit	mb/hPa, inHg and mmHg
Measuring range	700 – 1050mb/hPa
Accuracy	+/- 10 mb/hPa
Resolution	1mb (0.0 inHg)
Altitude setting	Sea level User setting for compensation
Weather display	Sunny, Clear night, Partly Cloudy, Cloudy, Cloudy at night, Rainy and Snowy
Memory	Historical data and bar chart for last 24hrs
<b>INDICATED TEMPERATURE</b>	
Temp. unit	°C / °F
Displayed range	0°C to 50°C (32°F to 122°F)
Operating range	-30°C to 60°C (-4°F to 140°F)
Accuracy	0°C - 40°C: +/- 1°C (+/- 2.0°F) 40°C - 50°C: +/- 2°C (+/- 4.0°F)
Comfort	20°C to 25°C (68°F to 77°F)
Memory	Current, Min and Max temp. Dew Point w/ Min and Max
Alarm	Hi / Lo
<b>INDICATED RELATIVE HUMIDITY</b>	
Displayed range	2% to 98%
Operating range	25% to 90%
Resolution	1%
Accuracy	25% - 40%: +/- 7% 40% - 80%: +/- 5% 80% - 90%: +/- 7%
Comfort	40% to 70%
Memory	Current, Min and Max
Alarm	Hi / Lo
<b>INDICATED WIND SPEED AND DIRECTION</b>	
Synchronization	Auto or disabled
Clock display	HH:MM:SS
Hour format	12hr AM/PM or 24hr
Calendar	DD/MM or MM/DD
Weekday in 5 languages	(E, G, F, I, S)
Battery	4 x UM-3 (AA) 1.5V batteries AC adapter 6V
<b>REMOTE WIND SENSOR</b>	
Dimensions (L x W x H)	178 x 76 x 214 mm (7 x 3 x 8.4 inches)
Weight	100 g (0.22 lbs) without battery
Wind speed unit	m/s, kph, mph, knots
Speed accuracy	2 m/s ~ 10 m/s (+/- 3 m/s) 10 m/s ~ 56 m/s (+/- 10%)
Direction accuracy	16 positions
Transmission of wind speed signal	Approx. every 14 seconds
Memory	Max speed gust
Battery	2 x UM-3 (AA) 1.5V batteries
<b>OUTDOOR TEMPERATURE HUMANITY UNIT</b>	
• <b>RELATIVE TEMPERATURE</b>	
Dimensions (L x W x H)	115 x 87 x 118 mm (4.5 x 3.4 x 4.6 inches)
Weight	130 g (0.286 lbs) without battery
Temp. unit	°C / °F
Displayed range	-50°C to 70°C (-58°F to 158°F)
Operating range	-30°C to 60°C (-4°F to 140°F)
Accuracy	-20°C - 0°C: +/- 2°C (+/- 4.0°F) 0°C - 40°C: +/- 1°C (+/- 2.0°F) 40°C - 50°C: +/- 2°C (+/- 4.0°F) 50°C - 60°C: +/- 3°C (+/- 6.0°F)
Comfort	20°C to 25°C (68°F to 77°F)
Memory	Current, Min and Max temp. Dew Point w/ Max and Min Wind chill temp. and min
• <b>RELATIVE HUMIDITY</b>	
Displayed range	2% to 98%
Operating range	25% to 90%
Resolution	1%



Accuracy	25% - 40%: +/- 7% 40% - 80%: +/- 5% 80% - 90%: +/- 7%
Comfort	40% to 70%
Memory	Current, Min and Max
Battery	2 x UM-4 (AAA) 1.5V batteries

**RF TRANSMISSION**

RF frequency	433MHz
Range	Up to 100 meters (328 feet) with no obstructions
Transmission	Approx. every 60 seconds
No. of Channel	1 for Wind/ Rain/ UV and 10 for Temp. / Humidity

**REMOTE RAIN GAUGE**

Dimensions (L x W x H)	107 x 87 x 56 mm (4.2 x 3.4 x 2.2 inches)
Weight	134 g (0.3 lbs) without battery
Rainfall unit	mm/hr and in/hr
Range	0 mm/hr – 999 mm/hr
Resolution	1 mm/hr
Accuracy	< 15 mm/hr: +/- 1 mm 15 mm to 9999 mm: +/- 7%
Memory	Past 24hrs, hourly and accumulated from last memory reset
Battery	2 x UM-3 (AA) 1.5V

**ABOUT OREGON SCIENTIFIC**

Visit our website ([www.oregonscientific.com](http://www.oregonscientific.com)) to learn more about Oregon Scientific products. If you're in the US and would like to contact our Customer Care department directly, please visit: [www2.oregonscientific.com/service/support](http://www2.oregonscientific.com/service/support)

OR



Call 1-800-853-8883.

For international inquiries, please visit: [www2.oregonscientific.com/about/international](http://www2.oregonscientific.com/about/international)

**EU-DECLARATION OF CONFORMITY**

Hereby, Oregon Scientific, declares that this Professional Weather Center (Models: WMR200 / WMR200A) is in compliance with the essential requirements and other relevant provisions of Directive 1999/5/EC. A copy of the signed and dated Declaration of Conformity is available on request via our Oregon Scientific Customer Service.



**COUNTRIES RTTE APPROVAL COMPLIED**  
All EU countries, Switzerland   
and Norway 

**FCC STATEMENT**

This device complies with Part 15 of the FCC Rules. Operation is subject to the following two conditions: (1) This device may not cause harmful interference, and (2) This device must accept any interference received, including interference that may cause undesired operation.

**WARNING:** Changes or modifications not expressly approved by the party responsible for compliance could void the user's authority to operate the equipment.

**NOTE:** This equipment has been tested and found to comply with the limits for a Class B digital device, pursuant to Part 15 of the FCC Rules. These limits are designed to provide reasonable protection against harmful interference in a residential installation.

This equipment generates, uses and can radiate radio frequency energy and, if not installed and used in accordance with the instructions, may cause harmful interference to radio communications. However, there is no guarantee that interference will not occur in a particular installation. If this equipment does cause harmful interference to radio or television reception, which can be determined by turning the equipment off and on, the user is encouraged to try to correct the interference by one or more of the following measures:

- Reorient or relocate the receiving antenna.
- Increase the separation between the equipment and receiver.
- Connect the equipment into an outlet on a circuit different from that to which the receiver is connected.
- Consult the dealer or an experienced radio / TV technician for help.

**DECLARATION OF CONFORMITY**

The following information is not to be used as contact for support or sales. Please call our customer service number (listed on our website at [www.oregonscientific.com](http://www.oregonscientific.com)), or on the warranty card for this product) for all inquiries instead.

We  
Name: Oregon Scientific, Inc.  
Address: 19861 SW 95<sup>th</sup> Ave., Tualatin,  
Oregon 97062 USA  
Telephone No.: 1-800-853-8883

declare that the product  
Product No.: WMR200 / WMR200A  
Product Name: Professional Weather Center  
Manufacturer: IDT Technology Limited  
Address: Block C, 9/F, Kaiser Estate,  
Phase 1, 41 Man Yue St.,  
Hung Hom, Kowloon,  
Hong Kong

is in conformity with Part 15 of the FCC Rules. Operation is subject to the following two conditions: 1) This device may not cause harmful interference. 2) This device must accept any interference received, including interference that may cause undesired operation.