

Patient Monitor

DS-101 System

Ver.03

Operation Manual



- * Before using the product, please read this manual thoroughly.
- * Store this manual where it can be always referred to.

Fukuda Denshi Co Ltd.

© 2017 Fukuda Denshi. All rights are reserved. To support the intended use of the product described in this publication, the purchaser of the products is permitted to copy this publication, for internal distribution only, from the media provided by Fukuda Denshi. Fukuda Denshi assumes no responsibility for any injury to anyone, or for any illegal any improper use of the product, which may result from failure to use this product in accordance with the instructions, cautions, warnings, or statement of intended use published in this manual.

Fukuda is registered trademark of Fukuda Denshi.

Software in this product is Copyright 2016 Fukuda Denshi or its vendors. All rights are reserved. Japan copyright laws and international treaty provisions applicable protect the software worldwide. Under such laws, the licensee is entitled to use the copy of the software incorporated with this instruments as intended in the operation of the product in which it is embedded. The software may not be copied, decompiled, reverse-engineered, disassembled, or otherwise reduced to human-perceivable form. This is not a sale of the software or any copy of the software; all right, title, and ownership of the software remain with Fukuda Denshi or its vendors.

For information about any Fukuda Denshi product, call Fukuda Denshi technical Support:

USA +1 800 365 6668

+1 425 881 7734M

Japan +81 3 3822 2171

United Kingdom +44 1483 728 065

China +86 01 6788 0514

Fukuda Denshi Co. Ltd.
3-39-4 Hongo Bunkyo Tokyo
113-8483 Japan



BriteMED Technology Inc.

3F., NO.306, 306-3, SEC. 1, DATONG RD., SIJHIH DIST., NEW TAIPEI CITY 221, TAIWAN

www.fukuda.com

Contents

Contents	1
Introduction	4
Intended Use.....	4
Contraindications	4
Symbols	5
Documentation symbols	5
Power symbols.....	5
Connectivity symbols	5
Miscellaneous symbols.....	5
Screen elements.....	6
About warnings and cautions	7
General warnings and cautions	7
Controls, indicators, and connectors	13
Setup.....	15
Packing list.....	15
Installation precautions	18
Mounting the system	18
Charging the system	19
DS-101 connection.....	20
NIBP relay horse Connection.....	21
ECG cable connection	22
SpO2 cable connection	22
Power up the system.....	23
Replacing the battery	23
Start up.....	26
Power on screen	26
Patient login.....	26
Patient registration	27
Default Setting.....	27
Monitoring	29
Main Screen	29
Large screen	30
Wave	31
Dual channel mode	31
ECG cascade mode	31
ECG mode.....	31
SpO2 mode	32
Pause	32
Full Disclosure.....	32
Trend	33
Alarm History	33
List	33
Event	33
Print	34
Save	34

Menu.....	35
Menu.....	36
Display Mode.....	36
Patient.....	36
ALARM.....	37
Review.....	37
Parameter Set-up.....	42
Set-up.....	44
Power Off.....	48
Alarms.....	49
Alarm types.....	49
Non-latching alarm.....	49
Alarm notification locations.....	49
Icons on the Main screen.....	50
Reset (pause or turn off) audio alarms.....	51
Disable the alarm for a period.....	51
Modify audio pause, alarm pause period.....	52
Adjust vital sign alarm limits.....	52
Default alarm limit.....	53
Modify audio alarm notification.....	53
Alarm Confirmation.....	54
On Main screen.....	54
On Review screen.....	54
Alarm message and situation.....	55
Physiological alarms: Priority High.....	55
Technical alarms: Priority Low.....	55
Patient monitoring.....	57
ECG.....	57
ECG frame.....	57
ECG display.....	57
ECG Electrode Placement.....	58
ECG Alarm.....	58
ECG Monitor Setting (Lead, Sensitivity, Filter, Pacing Detect).....	59
RESP (Respiration).....	60
RESP frame.....	60
RESP display.....	61
RESP Alarm.....	61
RESP Setting.....	61
SpO2.....	62
SpO2 frame.....	62
Pulse wave display.....	63
PR display.....	63
SpO2 and PR Alarm.....	63
Measure SpO2 and pulse rate.....	64
NIBP.....	65
NIBP frame.....	65
NIBP measure window.....	66
NIBP Alarm.....	66

Select a cuff	67
Cuff measurements	67
Position the cuff	67
NIBP measurement	68
Take a manual NIBP measurement	69
Interval NIBP measurement and other setting	69
Temperature	70
Temperature frame	70
Temperature measurement display	70
Thermometer	70
Take a temperature in the Predictive mode	70
12 Lead ECG	73
12 Lead ECG display	73
12 Lead ECG Alarm	73
12 Lead ECG Setting (Sensitivity, Filter, Pacing Detect)	74
12 Lead ECG Electrode Placement	75
12 Lead ECG Measurement	75
12 Lead ECG Measurement Value	77
Specification	78
Specification	78
Dimensions	81
Standards and compliance	83
FCC warning	83
Safety	83
Performance	83
Sound Pressure	83
ECG	84
Respiration	85
SpO2 (Arterial Oxygen Saturation)	85
NIBP (Non-Invasive Blood Pressure)	85
Hazardous Materials Disclosure	錯誤! 尚未定義書籤。
Electromagnetic Compatibility	86
Precautions for Safe Operation under Electromagnetic Influence	86
EMC Guidance	86
Troubleshooting	90
Version History	94

Introduction

This manual (direction for use) is designed to help you understand the capabilities and operation of the Fukuda DS-101 series of monitors. The information in this manual, including the illustrations, is based on a monitor configured with electro-cardiogram (ECG), heart rate, noninvasive blood pressure (NIBP), body temperature, pulse oximetry (SpO₂), and pulse rate. If your monitor configuration lacks any of these options, some information in this manual may not apply.

Before using the monitor, read the sections of the manual that pertain to your use of the monitor.

Intended Use

The DS-101 Patient Monitoring System™ is intended for monitoring single adult patient conditions by measuring/displaying/recording/alarming the patient's parameters which include Electrocardiograms (ECG), Heart Rate (HR), Pulse Rate (PR), Respiration (RESP), Oxygen Saturation of Arterial Blood (SpO₂), non-Invasive Blood Pressure (NIBP).

The device is intended to be operated by trained healthcare professionals in hospital environment, private practices, and during patient transport using battery power.

The device is also used as a data collection terminal with it's equipped NFC Reader to read data, such as patient temperature data, from a passive NFC Tag. The NFC Reader interface does not provide any measurement functions.

The device is not intended to be used in Home, Ambulance, Airplanes, MRI environment, hyperbaric oxygen chambers, or near flammable anesthetic gasses.



Contraindications

This system is not intended to be used.





- I On patients connected to heart/lung machines
- I On patients being transported outside a healthcare facility
- I Near an MRI machine
- I In a hyperbaric chamber
- I Near flammable anesthetics
- I Near electro-cauterization devices

Symbols

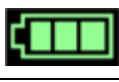

Documentation symbols

	WARNING The warning statements in this manual identify conditions or practices that could lead to illness, injury, or death
	Caution The caution statements in this manual identify conditions or practices that could result in damage to the equipment or other property, or loss of data
	Read operating instructions



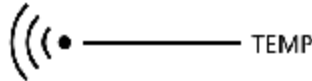

Power symbols

	Power on / standby		Monitor is plugged into Alternating Current power present, battery fully charged
	Alternating Current power present, battery is charging		Battery power operation
	Battery level		Battery Low / Charge Battery

Connectivity symbols

	Wireless LAN is not connected.		Wireless LAN is connected
		Temperature Sensor touch area	

Miscellaneous symbols

	Meets essential requirements of European Medical Device Directive 93/42/EEC		Manufacturer
	Defibrillation-proof Type CF applied parts		Defibrillation-proof Type BF applied parts
	Recycle the products separate from other disposables.		

Screen elements

Navigation			
HR			
	Sync Mark		Lead off
SpO2			
	SpO2 Sync Bar		Probe Off message
			Finger Off message
RESP			
	Resp Sync Bar		
NIBP			
	NIBP Oscillation Bar		NIBP Auto Interval Timer
Save			
	Auto Save On		
Alarm and information messages			
	Alarm Off		Alarm Pause & Count Down Timer
	Audio Pause Button		Audio Pause & Count Down Timer

About warnings and cautions

Warning and caution statements can appear on the monitor, on the packaging, on the shipping container, or in this document.

The monitor is safe for patients and clinicians when used in accordance with the instructions and with the warning and caution statements presented in this manual.

Before using the monitor, familiarize yourself with the sections of this direction for use that pertains to your use of the monitor.

- I Failure to understand and observe any warning statement in this manual could lead to patient injury, illness, or death.
- I Failure to understand and observe any caution statement in this manual could lead to damage to the equipment or other property, or loss of patient data.

General warnings and cautions



WARNING Many environmental variables, including patient physiology and clinical application, can affect the accuracy and performance of the monitor. The clinician must verify all vital signs information before treating the patient. If there is any question about the accuracy of measurements, verify the measurement using another clinically accepted method.



WARNING Alarm limits are patient- or facility-specific. The clinician must set or verify alarm limits appropriate for each patient. Each time the monitor is powered on, you must check that the alarm settings are appropriate for your patient before you start monitoring.



WARNING The monitor is not intended for use during patient transport outside of the medical facility. Do not use the monitor to take measurements on any patient in transit.



WARNING Use only Fukuda Denshi approved accessories. Using unapproved accessories with the monitor can affect patient and operator safety and adversely affect product performance and accuracy. To ensure patient safety and optimal product performance, use only Fukuda Denshi recommended accessories and supplies (i.e., cuffs, hoses, thermometer, SpO2 sensors, etc.) and use according to the accessory manufacturer's direction for use.



WARNING Inaccurate measurement risk. Do not connect more than one patient to a monitor.



WARNING Inaccurate measurement risk. Dust and particle ingress can affect the accuracy of blood pressure measurement. Use the monitor in clean environments to ensure measurement accuracy. If you notice dust or lint build-up on the monitor's vent openings, have the monitor inspected

and cleaned by a qualified service technician.



WARNING Liquid can damage electronics inside the monitor. Prevent liquids from spilling on the monitor.

If liquids are spilled on the monitor:

1. Power down the monitor
2. Disconnect the power plug.
3. Remove battery pack from the monitor.

Note Remove battery pack shall be proceed by trained specialist and shall not be proceed by user

4. Dry off excess liquid from the monitor.

Note If liquids possibly entered the monitor, remove the monitor from use until it has been properly dried, inspected, and tested by qualified service personnel.

5. Reinstall battery pack.

6. Power on the monitor and verify that the monitor functions normally before using it.

If liquids enter the USB Box

1. Power down the monitor
2. Disconnect the USB connector.
3. Dry off excess liquid from the USB Box.

Note If liquids possibly entered the USB Box, remove the monitor from use until it has been properly dried, inspected, and tested by qualified service personnel.

4. Connect the USB connector

Power on the monitor and verify that the monitor functions normally before using it.



WARNING Safety risk. Damaged cords, cables, and accessories can affect patient and operator safety. Never lift the monitor by the power supply cord or patient connections. Routinely inspect the AC power cord, blood pressure cuff, SpO2 cable, and other accessories for strain relief wear, fraying, or other damage. Replace as necessary.



WARNING Fire and explosion hazard. Do not operate the monitor in the presence of a flammable anesthetic mixture with air, oxygen, or nitrous oxide; in oxygen-enriched environments; or in any other potentially explosive environment.



WARNING The monitor may not function properly if dropped or damaged. Protect it from severe impact and shock. Do not use the monitor if you notice any signs of damage. Qualified service personnel must check any monitor that is dropped or damaged for proper operation before putting the monitor back into use.



WARNING Defective batteries can damage the monitor. If the battery shows any sign of damage or cracking, it must be replaced immediately and only with a battery approved by Fukuda Denshi.



WARNING Electric shock hazard. Do not open the monitor or attempt repairs. The monitor has no user-serviceable internal parts. Only perform routine cleaning and maintenance procedures specifically described in this manual. Inspection and servicing of internal parts shall only be performed by qualified service personnel.



WARNING Inaccurate measurement risk. Do not expose to temperatures higher than 42.9°C



WARNING Inaccurate measurement risk. Do not use the monitor on patients who are on heart-lung machines.



WARNING Use the monitor only as described in this directions for use. Do not use the monitor on patients as described in the Contraindications.



WARNING Inaccurate measurement risk. Do not use the monitor on patients who are experiencing convulsions or tremors.



WARNING Wall mounted equipment and accessories must be installed in accordance with accompanying instructions. Fukuda Denshi is not responsible for the integrity of any installation not performed by authorized Fukuda Denshi service personnel. Contact an authorized Fukuda Denshi service representative or other qualified service personnel to ensure professional installation for safety and reliability of any mounting accessory.



WARNING Do not place the monitor in any position that might cause it to fall on the patient.



WARNING Fukuda Denshi is not responsible for the integrity of a facility's power. If the integrity of a facility's power or protective earth conductor is in doubt, always operate the monitor on battery power alone when it is attached to a patient.



WARNING Equipment damage and personal injury risk. When transporting the monitor on a mobile stand, properly secure all patient cables and cords to keep them clear of the wheels and to minimize trip hazards.



WARNING For operator and patient safety, peripheral equipment and accessories that can come in direct patient contact must comply with all applicable safety, EMC, and regulatory requirements.



WARNING All signal input and output (I/O) connectors are intended for connection of only devices complying with IEC 60601-1, or other IEC standards (for example, IEC 60950), as applicable to the monitor. Connecting additional devices to the monitor may increase chassis or patient leakage currents. To maintain operator and patient safety, consider the requirements of IEC 60601-1. Measure the leakage currents to confirm that no electric shock hazard exists.



WARNING Equipment failure and patient harm risk. Do not cover the air intake or exhaust vents on the rear and base of the monitor. Covering these vents could cause overheating of the monitor or muffing of alarms.



WARNING This equipment is not suitable for use in the presence of electro-surgery.



WARNING Cross-contamination or nosocomial infection risk. Clean and maintenance the monitor on a routine basis according to your facility's protocol and standards or local regulations. Thorough hand-washing before and after contact with patients greatly reduce the risk of cross-contamination and nosocomial infection.



WARNING Do not modify this equipment without authorization of the manufacturer



WARNING Conductive parts of electrodes and associated connectors for type BF or CF applied parts, including the NEUTRAL ELECTRODE, should not contact any other conductive parts including earth



WARNING The stored data will not be affected. The measurement accuracy will temporarily decrease during electrosurgery, but it will not compromise the safety of patient and the equipment.



WARNING To avoid the risk of electric shock, this equipment must only be connected to a supply mains with protective earth.



WARNING When using SpO2 function under the room temperature of 40 °C, SpO2, SpO2 test finger temperature will up to 43°C



Warning The performance of the AUTOMATED SPHYGMOMANOMETER can be affected by extremes of temperature, humidity and altitude



Warning Connection to other equipment could result in previously unidentified risks to patients, operators or third parties. Fukuda Denshi is not responsible for the integrity of any installation or upgrade not performed by authorized Fukuda Denshi service personnel. Contact an authorized Fukuda Denshi service representative or other qualified service personnel to ensure professional installation for safety and reliability



Warning Changes to other equipment could introduce new risks that require additional analysis, changes including

- changes in network configuration
- connection of additional items
- disconnection of items
- update of equipment



Warning Devices connect to the system shall fulfill 60601-1 requirement



WARNING Please do not absolutely installation and operation of the program other than Fukuda Denshi specified in the device. Normal operation of this equipment cannot be guaranteed.



WARNING Please do not insert USB memory or other equipment while operating this device. When an application or installation starts automatically. Normal operation of this device can not be guaranteed



Caution Japan's Law restricts this monitor to sale, distribution, or use by or on the order of a physician or licensed healthcare professional.



Caution Electromagnetic interference risk. The monitor complies with applicable domestic and international standards for electromagnetic interference. These standards are intended to minimize medical equipment electromagnetic interference. Although this monitor is not expected to present problems to other compliant equipment or be affected by other compliant devices, interference issues still may occur. As a precaution, avoid using the monitor in close proximity to other equipment. In the event that equipment interference is observed, relocate the equipment as necessary or consult manufacturer's direction for use.



Caution Use only a Class I (grounded) AC power supply cord for powering this monitor.



Caution Do not use a long press of  to power down the monitor when it is functioning normally. You will lose patient data and configuration

settings.



Caution Never move the monitor or mobile stand by pulling on any of the cords as this may cause the monitor to tip over or may damage the cord. Never pull on the power cord when removing it from the power outlet. When disconnecting the power cord, always grasp the attachment plug and not the cord. Keep the cord away from liquids, heat, and sharp edges. Replace the power cord if the strain relief or cord insulation is damaged or being to separate from the attachment plug.



Caution Use only the Fukuda Denshi USB client cable to connect a USB Box to the USB port.



Caution If the touchscreen is not responding properly, refer to the troubleshooting section. If the problem cannot be resolved, discontinue use of the monitor and contact an authorized Fukuda Denshi service center or qualified service personnel.



Caution Summation of leakage currents when several items of ME EQUIPMENT are interconnected



Caution The electrocardiograph incorporates a means to protect the patient against burns when used with HIGH FREQUENCY(HF) SURGICAL EQUIPMENT



Caution Cleaning and maintenance procedures

- I When cleaning the touch panel, never use strong-acidic cleaning solution.
- I A special coating is applied to the surface of the touch panel. Do not wipe the surface with a cloth or gauze with coarse texture. Wipe the surface with an eyeglass cleaning cloth.
- I Clean the equipment frequently so stains can be removed easily.
- I To prevent injury, it is recommended to wear gloves when cleaning the equipment.
- I Do not allow liquids or cleaning solution to enter the equipment or connectors.
- I Do not use organic solvents, thinner, toluene and benzene to avoid damaging the resin case.
- I Do not polish the housing with abrasive or chemical cleaner.
- I When sterilizing the entire room using a spray solution, pay close attention not to have liquids get into the equipment or connectors, The surface resin coating may be damaged, resulting in discoloration, scratches, or other problems.
Example: Do not use chemical cloth, scrub brush, abrasive, polishing powder, hot water, volatile solvent and chemicals (cleanser, thinner, benzine, benzol, and synthetic detergent for house and furniture), or sharp-edged tools.
- I Do not open the housing.
- I Avoid alcohol or other liquids from getting into the equipment.
- I For safe operation of the equipment, regular inspection and maintenance are required. Once a year, check all cables, devices, and accessories for damage, earth impedance, earth and leakage currents, and all alarm functions. Also, ensure that all safety labels are legible. Maintain a record of these safety inspections.

- I Regular testing of devices and accessories on a daily basis (by the clinical OPERATOR) and on a scheduled basis (as a service activity) is recommended.



Caution Immediate maintenance has to be carried out for the following case.

- I When the equipment was subjected to extreme mechanical stress, e.g. after a heavy fall.
- I When the equipment was subjected to liquid spill.
- I When the monitoring function is interrupted or disturbed.
- I When parts of the equipment enclosure are cracked, removed, or lost.
- I When any connector or cable shows signs of deterioration.



Caution To prevent intrusion of computer viruses, please use this system in the closed network except for sending mail



Caution When using this system on a wireless network, please set the connected device by MAC address on access point and router.



Caution When using this system on a wireless network, please set the connected device by MAC address on access point and router.

Controls, indicators, and connectors

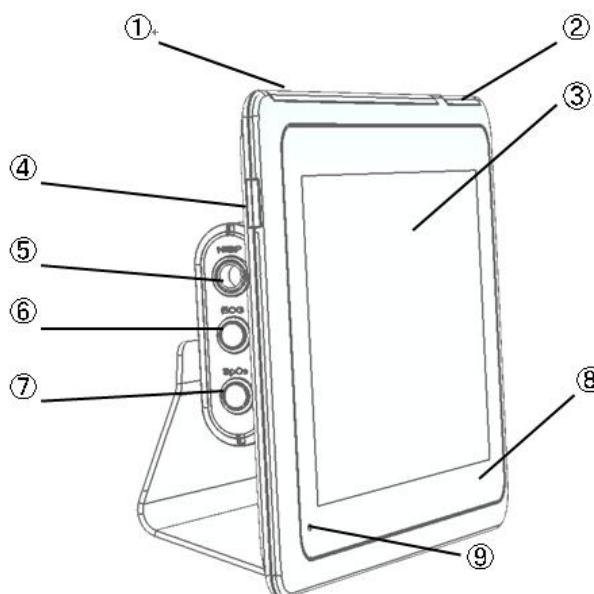

No.	Feature	Description
1	Light bar	Provides a visual alarm with red and blue LEDs.
2	Light bar	Provides a synchronized heartbeat with green LEDs.
3	LCD screen	1280 x 800 pixels color touchscreen provides a graphical user interface.
4	Power switch	Power-on/Standby switch.
5	NIBP connector	Self-contained module for easy replacement.
6	ECG connector	Self-contained module for easy replacement. Supports 3lead or 10lead ECG cables.
7	SpO2 connector	Self-contained module for easy replacement. Supports Clip-type or Tape-type SpO2 sensors.
8	NFC touch area	Receive body temperature by thermometer into contact with this place
9	Power Light	The LED indicates the charging status <ul style="list-style-type: none"> Green: Power on (Both AC and battery powered) Amber: The battery is charged. Amber blanking: The battery is charging. Black: Power off without AC powered

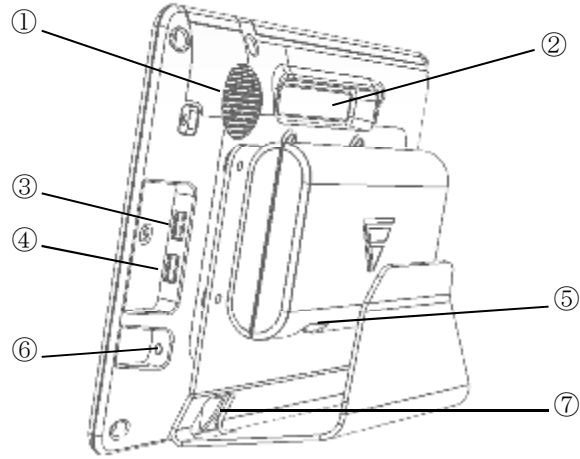

No.	Feature	Description
1	Speaker	Provides an audible Alarm (low or high) and synchronized heartbeat sound.
2	Handle	
3	AUX-1 connector	Provides a connection to secure USB-memory for software upgrades.
4	AUX-2 connector	Provides a connection to optional medical devices.
5	IO connector	Connect to display module
6	Power connection	Provides an external AC power connection.
7	IO connector	Connect to Main module.

Setup



WARNING The labels on the external box are best to be read at a distance of 30 cm due to the small label size.





To unpack the DS-101, follow the steps below:

1. Use box cutters, a knife or a sharp pair of scissors that seals the box.
2. Open the box.
3. Lift the DS-101 out of the box.
4. Pull the plastic cover off the DS-101.
5. Make sure all the components listed in the packing list are present.





Packing list

The DS-101 is shipped with the following components:

Note If any of these items are missing or damaged, contact the distributor or sales representative immediately.

Quantity	Description	Model Name	Image
DS-101			
1	Panel PC	DS-101	
1	AC adaptor 3P	ADP-101	
1	Power cord		
USB-BOX			
1	Multiport Data Collector	HS-101	

1	USB Cable	USB-101	
Stand			
1	Stand	101STAND	
Accessory			
1	SpO2 sensor Reuseable(3m) Clip type	SPO-10RAC3M	
1	ECG CABLE (3 Leads)	CMO-101HR3	
1	NIBPcuff for adult M (23-33 cm) (30 to 280mmHg)	CUF-101M	
1	NIBP relay horse	OA-101AP	

Accessory (Option)			
1	SpO2 sensor Reuseable(3m) Tape type	SPO-11RAT3M	
1	ECG CABLE 12Leads (3m)	CMO-101HR12	
1	NIBP cuff for adult L (31-43 cm) (30 to 280mmHg)	CUF-101L	
1	NIBPcuff for adult S (17-25 cm) (30 to 280mmHg)	CUF-101S	
1	NFC Thermometer	BT-A71-NFC	

Hardware installation

Installation precautions



WARNING Failure to take installation precautions during the maintenance of the device may result in permanent damage to the device and severe injury to the user.

When installing the DS-101, please follow the precautions listed below:

1. Install and keep the instrument away from splashing water.
2. Protect the instrument from shock and vibration while transporting it.
3. Do not install the instrument where humidity, ventilation, or direct sunlight.
4. Do not install the instrument in a chemical storage area or where gas is generated.

Mounting the system

The DS-101 came with a USB-BOX and a stand. To mount the USB-BOX and the stand, follow the steps below.

1. Secure the USB-BOX to the stand with four flat-head retention screws.

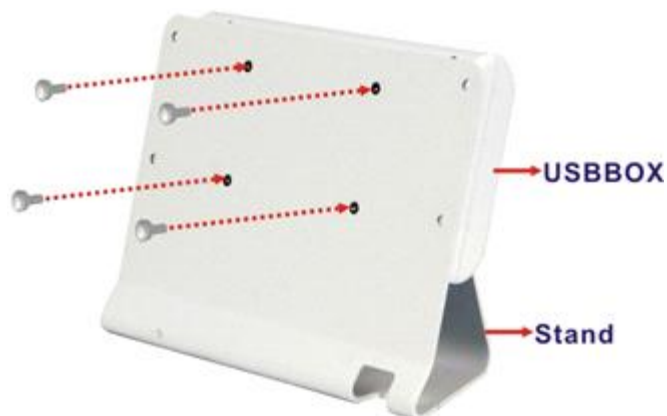

2. Secure the stand to the rear panel of the DS-101 with four retention screws.



3. Connect the micro USB cable. Plug the 180-degree connector into the Display connector of the USB-BOX, and plug the 90-degree connector into the Module connector of the DS-101.



Charging the system

To charge the DS-101, follow the steps below.

1. Connect the DS-101 with a power source through the power adapter came with the package.
2. The system starts to charge the battery and the power status LED lights up in amber indicating the battery is being charged.



- The user can turn on the system to check the battery capacity on the top right corner of the screen.



Note The battery can only be fully charged when the battery level is lower than 95% due to battery overcharge protection. In other words, the battery will not be charged after plugging in the power source when the battery level is in between 95% and 99%.

DS-101 connection

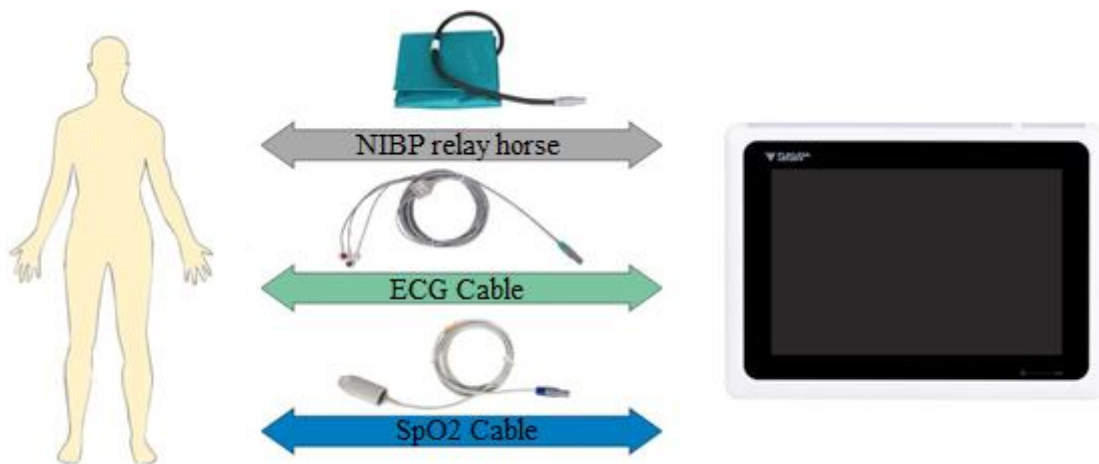

Illustrate the connection concept of the DS-101. Please follow the detailed instruction below to connect the cables for patient monitoring.

NIBP relay horse Connection

Line up the alignment tab of the NIBP relay horse connector with the notch of the NIBP connector of the USBBOX. Then, plug in the connector and make sure the connection is secure.



ECG cable connection

Line up the alignment tabs of the ECG cable connector with the notches of the ECG connector of the USBBOX. Then, plug in the connector and make sure the connection is secure.



SpO2 cable connection

Line up the alignment tab of the SpO2 cable connector with the notch of the SpO2 connector of the USBBOX. Then, plug in the connector and make sure the connection is secure.



Caution Observe the patient and instrument closely during use. If any abnormality is observed, immediate proper action, such as stopping the operation of the instrument, should be taken for the safety of the patient..

Power up the system

To power-up the system, push the power button on the right side panel for three seconds until the power status LED on the front panel lights up in green.



The following table lists the power LED status description.

DS-101 Status: Power On or Sleep	
Power LED	Status
Green	Power on
Solid amber	The battery is fully charged
Slowly flash in amber	The battery is being charged
LED off	Power cable disconnected
DS-101 Status: Power Off	
Battery Power	Status
Lower than 5%	The power LED flash rapidly in amber after long-pressing the power button. The battery power is too low to power up the DS-101.
5% ~ 10%	The power LED light up in green after long pressing the power button. The DS-101 can be powered on to access the software application.
Higher than 10%	The power LED light up in green after long pressing the power button. The DS-101 can be powered on to access the software application. When the power is lower than 10%, the DS-101 will shut down automatically.

Replacing the battery

This section describes how to replace the battery if necessary.

1. Remove the two retention screws that secure the battery access panel. Then, lift the panel to remove it.



2. Lift the battery pack and pull it out gently until the battery connector shows.



3. Disconnect the battery connector.



4. Connect the battery connector of the new battery pack to the battery connector of the DS-101 by correctly orienting the connector (align keying feature) onto the mating connector.

5. Gently organize and insert the connectors and cables back to the original position inside the DS-101.
6. Slide the new battery pack in at an angle to install it.



7. Secure the battery access panel with the two previously removed retention screws.

Start up

Power on screen

The following screen appears when the system is turned on.

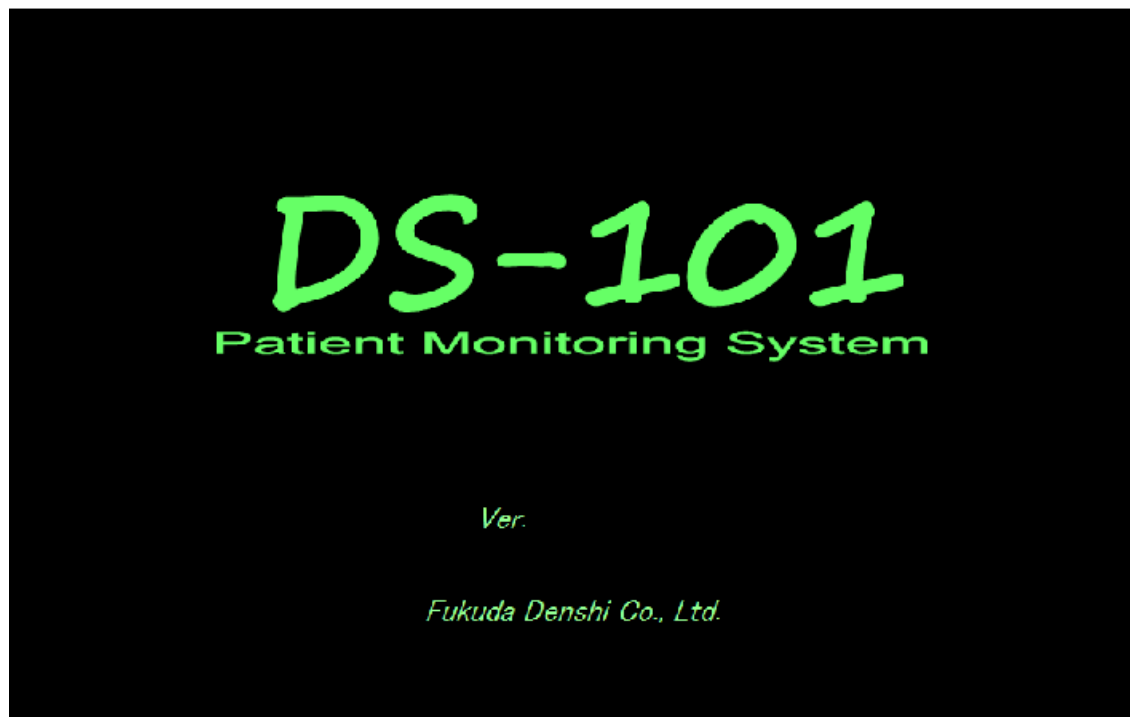

Patient login

The top of the Patient page displays the heart rate (HR) and the waveform detected by the sensor.

The page also contains three option buttons for users to choose:

- I **Admin New Patient:** Delete patient data, and enter the Patient Register page (refer to Section 0).
- I **Quick Admit:** Delete patient data, and enter the Monitor Mode page or the Large Mode page.
- I **Same Patient:** Return to the Monitor Mode page or the Large Mode page to monitor the current patient.

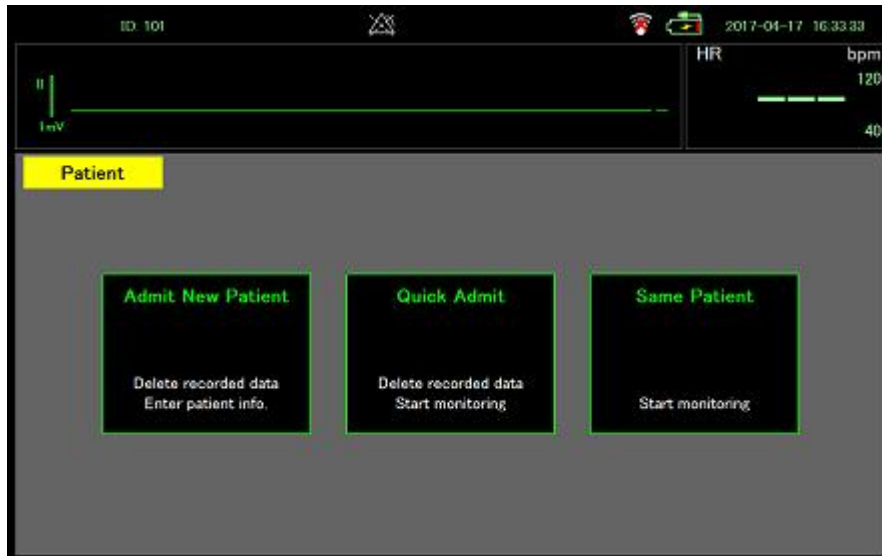

Patient registration

The Patient Registration page shown below allows users to input patient information.

Default Setting

The default setting at the start of monitoring is as follows.

The system setting can set whether to default or continue.

Parameter

Parameter	Item	Detail	Default
ECG Monitor	ECG Lead	I, II, III	II
	Sensitivity	x0.5, x1, x2, x4	x1

	Filter	Diag., Monitor, Drift Cut	Drift Cut
	Hum Filter	ON, OFF	ON
	Pacing Detect	ON, OFF	OFF
ECG 12 leads	Sensitivity	x0.25, x0.5, x1, x2, x4	x1
	Low Cut Filter	0.05Hz, 0.15Hz, 0.3Hz	0.05
	High Cut Filter	30Hz, 150Hz, 250Hz, OFF	OFF
	Hum Filter	ON, OFF	ON
	Pacing Detect	ON, OFF	OFF
NIBP	Pressure Pre-set	120, 150, 180, 200	180
	Pressure Limit	150, 200, 250, 300	250
	Auto Interval	ON, OFF	OFF
RESP	RESP Lead	I, II	II
	Sensitivity	x0.2, x0.5 x1, x2, x4	x1

Patient admit-discharge

Item		Default
Birth	Year	1970
	Month	1
	Day	1
Height		0
Weight		0

Alarm Limit

Parameter	Unit	Lower Limit	Upper Limit
HR/PR	BPM	40	120
SpO2	%	90	100
Resp	/min	5	30
NIBP Sys	mmHg	80	180
NIBP Dia	mmHg	40	100

Monitoring

Main Screen

Patient information, battery life, dates and countdown timer are displayed at the top of the page in the Monitor Mode. The countdown timer in green indicates the remaining time for next auto blood pressure check. If the number is absent, that means the auto check function is disabled.



Other displayed values are described below:

- I **HR:** heart rate. A heart icon and a beep will be generated every time the ECG peak is detected. The numbers under bpm on the right indicate the normal range of heart rate. If the heart rate exceeds the normal range, the warning sound and icon will be triggered.
- I **PR:** pulse rate (displayed when SpO₂ is selected without ECG channel). A beep will be generated every time the SpO₂ peak is detected.
- I **SpO₂:** oxygen saturation
 - i The five blocks on the left show the level of heart beat strength. The three blocks on the top show the level of the signal strength.
 - i The number beside the percentage sign (%) indicates the normal range. If the oxygen saturation exceeds the normal range, the warning sound and icon will be triggered.
- I **NIBP:** blood pressure
 - i The five blocks on the left show the strength level of the blood flow
 - i Time: the time at which the checkup is completed
 - i **Sys** in orange: Systolic pressure. The small number on the side indicates the normal range of systolic pressure. If the systolic pressure exceeds the normal range, the warning sound and icon will be triggered.
 - i **Dia** in orange: Diastolic pressure. The small number on the side indicates the normal range of diastolic pressure. If the diastolic pressure exceeds the normal range, the warning sound and icon will be triggered.
 - i **CUFF:** the pressure of the cuff
 - i Press **START/STOP** to start the checkup. After start, press **START/STOP** again can stop the checkup.
 - i Press any place other than the **START/STOP** button to enter the page with detail information of the NIBP check.

- I **RESP:** the number of breaths
- I **TEMP:** press TEMP to enter the page with detail temperature information

Large screen

Patient information, battery life, dates and countdown timer are displayed at the top of the page in the Monitor Large Mode. The countdown timer in green indicates the remaining time for next auto blood pressure check. If the number is absent, that means the auto check function is disabled.



Other displayed values are described below:

- I **HR:** heart rate. A heart icon and a beep will be generated every time the ECG peak is detected. The numbers under bpm on the right indicate the normal range of heart rate. If the heart rate exceeds the normal range, the warning sound and icon will be triggered.
- I **PR:** pulse rate (displayed when SpO2 is selected without ECG channel). A beep will be generated every time the SpO2 peak is detected.
- I **SpO2:** oxygen saturation
 - i The five blocks on the left show the level of heart beat strength. The three blocks on the top show the level of the signal strength.
 - i The number beside the percentage sign (%) indicates the normal range. If the oxygen saturation exceeds the normal range, the warning sound and icon will be triggered.
- I **RESP:** the number of breaths. The block on the left blinks every time a breath is detected.
- I **TEMP:** press TEMP to enter the page with detail temperature information
- I **NIBP:** blood pressure
 - i The block on the left blinks every time blood flow is detected.
 - i **Sys** in orange: Systolic pressure. The small number on the side indicates the normal range of systolic pressure. If the systolic pressure exceeds the normal

- range, the warning sound and icon will be triggered.
- i Dia in orange: Diastolic pressure. The small number on the side indicates the normal range of diastolic pressure. If the diastolic pressure exceeds the normal range, the warning sound and icon will be triggered.
- i CUFF: the pressure of the cuff
- i Press START/STOP to start the checkup. After start, press START/STOP again can stop the checkup.
- i Press any place other than the START/STOP button to enter the page with detail information of the NIBP check.

Wave

Dual channel mode

The upper waveform is ECG signal and the lower one is pulse wave.



ECG cascade mode

Display ECG waveform in two areas.



ECG mode

If ECG waveform is displayed in a bigger area, user can change waveform amplitude to see more detail.



SpO2 mode

If SpO2 waveform is displayed in a bigger area, user can change waveform amplitude to see more detail.



Pause

If an abnormal waveform is found, the user can click at the waveform display area to stop waveform update, allowing the user to check the abnormal waveform.



Full Disclosure

User can review previous waveform.

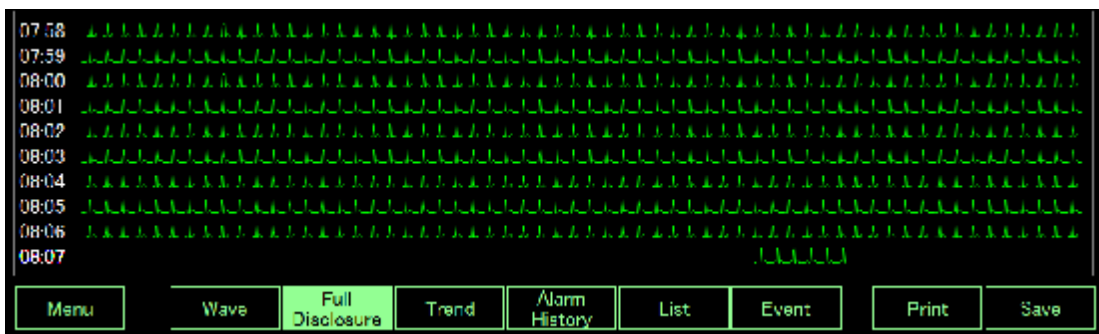

Full disclosure begins halfway corresponding to the time (second) when pressing the Full

Disclosure button as shown in the figure. When it comes to the right end, it scrolls and displays the data for one minute

Trend

User can check NIBP, SpO2, heart rate or temperature trend.

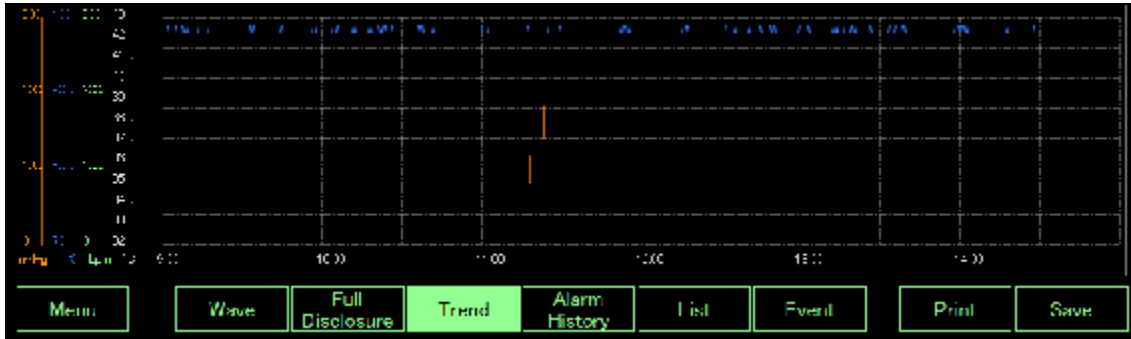

Alarm History

User can check the latest alarm history.

	ALL	HR D/M	SpO ₂ %	Sys mmHg	Dia mmHg	Resp /M	
2010/01/06 17:38:51	HR Alarm	126				60	
2010/01/06 17:39:14	HR Alarm	240				125	
2010/01/06 21:11:37	HR Alarm	47				7	
2010/01/06 08:56:54	SpO ₂ Alarm	70	99			6	
2010/01/06 08:57:16	SpO ₂ Alarm	70	95			6	

List

User can check all latest events in a list.

		HR E/M	SpO ₂ %	Sys mmHg	Dia mmHg	Resp /M	Temp °C
2010/01/06 17:27:36	EOG 12	80				53	
2010/01/06 17:27:48	EOG 12	80				53	
2010/01/06 17:38:51	HR Alarm	126				68	
2010/01/06 17:39:14	HR Alarm	240				125	
2010/01/06 21:11:37	HR Alarm	47				7	
2010/01/06 08:56:54	SpO ₂ Alarm	70	99			6	
2010/01/06 08:57:16	SpO ₂ Alarm	70	95			6	
2010/01/06 09:25:30	Manual	70	98			50	

Event

If there are ECG/SpO2/NIBP/Respiration/Temperature/Manual operations, those events will be recorded on the timescale.



Print

If the user clicks the Print button then the following message box will pop up. The user can select proper printer to print the waveform.

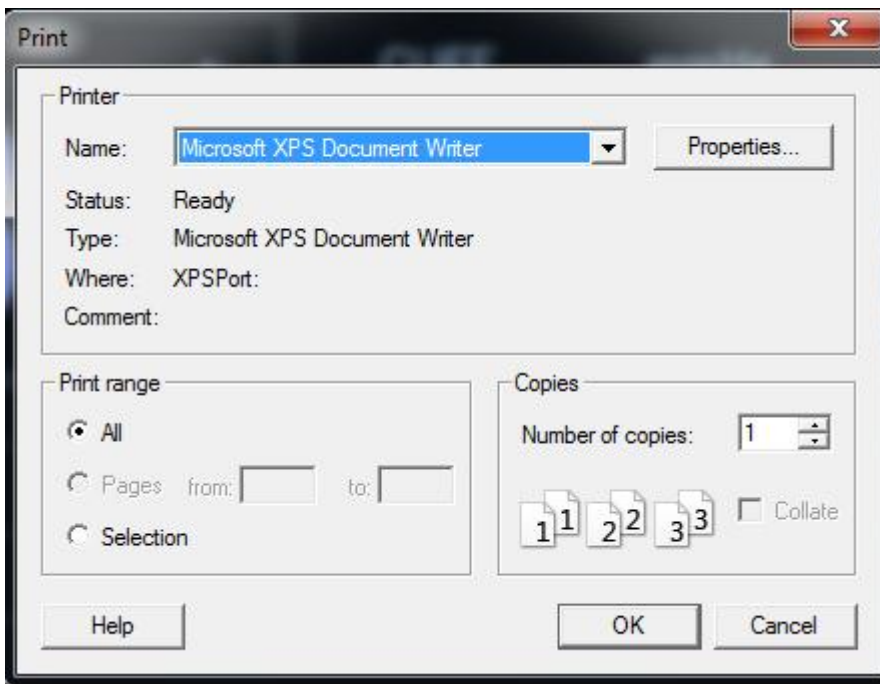

Caution Print setting need to go to Window Desktop as descript in Power off section.



Caution Print function is based on Window system, Fukuda Denshi is not responsible for the integrity of any installation or upgrade not performed by authorized Fukuda Denshi service personnel. Contact an authorized Fukuda Denshi service representative or other qualified service personnel to ensure professional installation for safety and reliability

Save

Once the **Save** button is clicked, the button is disabled and the color is changed to gray. The system will start storing the image.

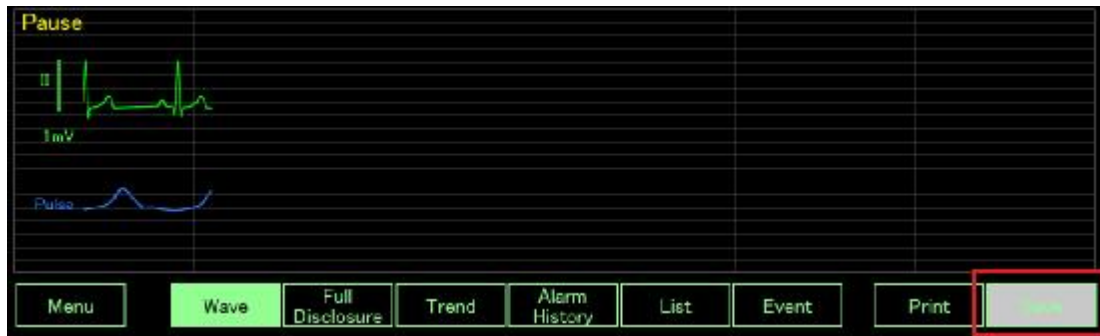

Menu

The Menu page contains several buttons for accessing the setting options of each function. In dual channel mode, ECG mode and ECG Cascade mode, the upper area of the Menu page always displays ECG waveform and heart rate number. In SpO2 mode, the upper area always displays SpO2 waveform and pulse rate number.

Click **EXIT** to go back to the Main Screen.

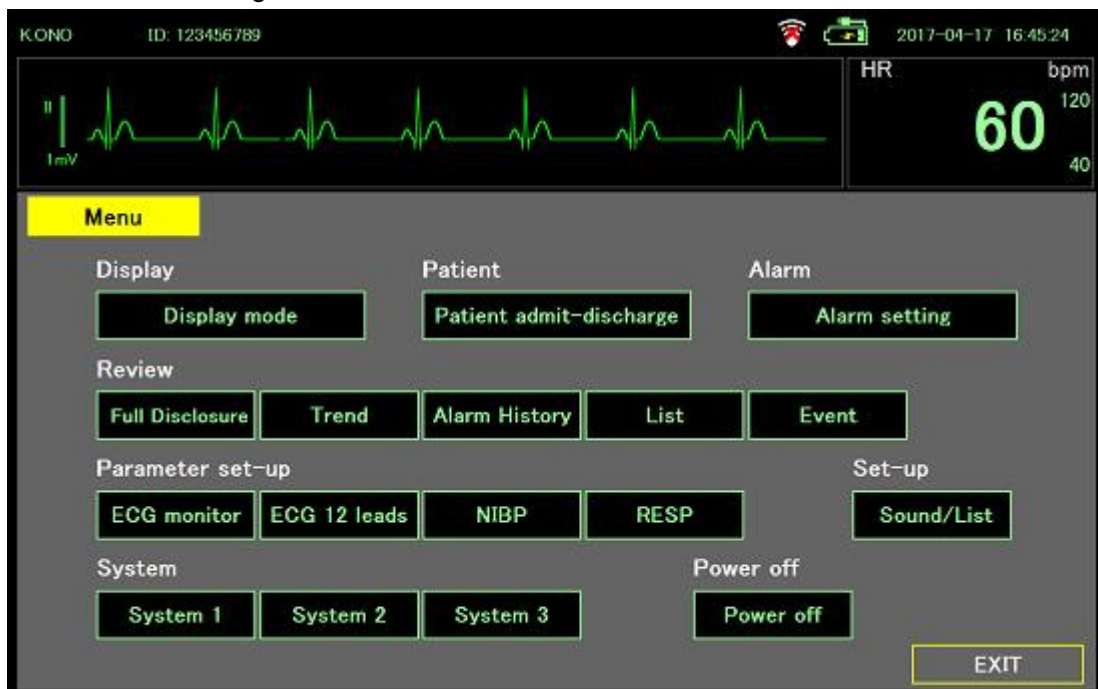

Menu

Display Mode

The Display page allows users to select monitor mode and waveform display mode. The options include:

- I Mode Select:
 - i Main Screen
 - i Large Screen
 - i 12 Lead ECG
- I Monitor Wave:
 - i Dual Channel
 - i ECG
 - i ECG Cascade
 - i SpO2
- I **BACK**: go to Menu page.
- I **EXIT**: exit the Menu page and go back to the Main Screen.

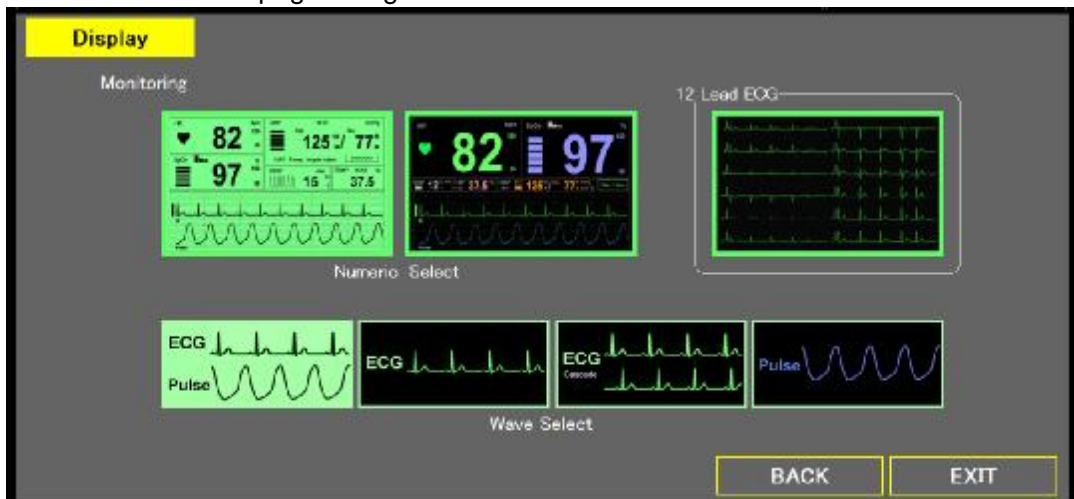

Patient

The Patient page allows users to input patient information, delete patient record or tentative discharge.

Patient

NAME: K ONO Gender: M

ID: 123456789 Birth: Y 1950 M 1 D 1 Age:

Height: 177 cm Weight: 70 kg

Comment:

Admit Registering patient.

Discharge Deleting recorded data and patient information.

Tentative discharge Tentative discharge and off-monitoring.

BACK EXIT

ALARM

Click each icon to enable or disable alarm function. User can set a normal range. If the measured value is not in the normal range then the alarm will be triggered.

ALARM

	Lower Limit	Upper Limit	
HR/PR 60 BPM	40	120	10
SpO ₂ 97%	90	100	1
Resp 20 /min	5	30	1
NIBP Sys 116 mmHg	80	180	10
Dia 76 mmHg	40	100	Default

Alarm Paused 1 min

Cancel All Alarms

BACK EXIT



Review

Full Disclosure

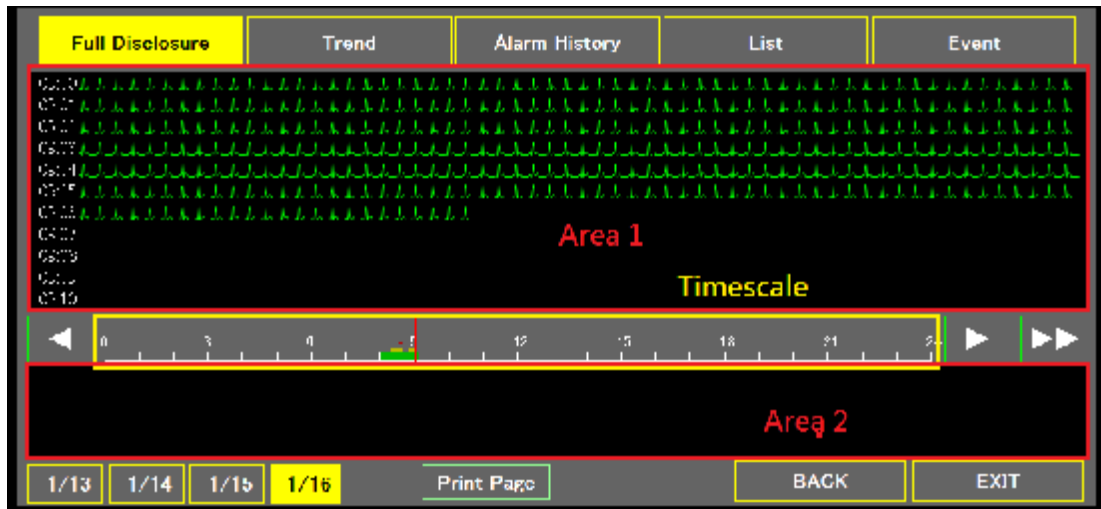
Users can check ECG shrinking waveform in the upper area (Area 1). If the user wants to see certain part of ECG, please click on Area 1 to have the ECG waveform display original ECG waveform in Area 2.



The Full Disclosure page also contains the following buttons:



- I : go back 10 minutes.
- I : go forward 10 minutes.
- I : jump to the end.
- I Timescale :
 - i Green bar: there are ECG waveforms in the database.
 - i Yellow dots: there are events at that time
 - i Red dots: there are alarms triggered at that time
- I **1/13, 1/14, 1/15, 1/16**: change Timescale range.
- I **Print Page**: print full disclosure waveform.
- I **BACK**: go to Menu page
- I **EXIT**: go to Main Screen.

Trend

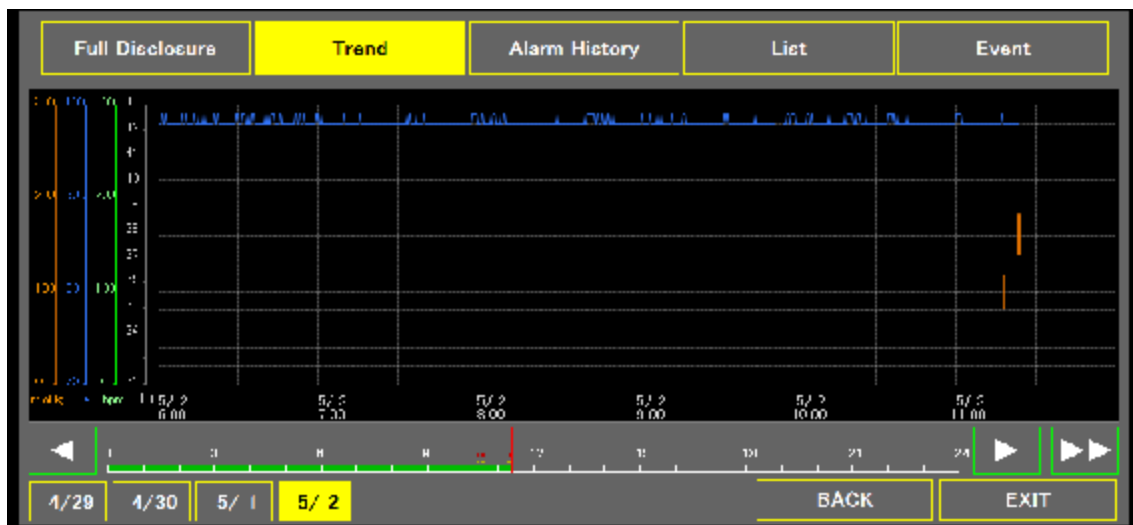
The Trend page displays ECG, SpO2, temperature trend and the time of NIBP measurement.





The Trend page also contains the following buttons:

- I : go back 6 hours.
- I : go forward 6 hours.
- I : jump to the end.
- I Timescale :
 - i Green bar: there are ECG waveforms in the database.
 - i Yellow dots: there are events at that time
 - i Red dots: there are alarms triggered at that time
- I **1/13, 1/14, 1/15, 1/16**: change Timescale range.
- I **BACK**: go to Menu page
- I **EXIT**: go to Main Screen.



Alarm History

The Alarm History page displays heart rate, SpO2, NIBP, respiration alarm time and related data. If you double click the alarm column, it will lead to the Review page.

Full Disclosure		Trend		Alarm History		List		Event	
	ALL	HR (bpm)	SpO2 (%)	System	Diagnosis	Resp. (bpm)			
1	2019-01-15 08:04:47	HR Alarm	30	92			51		
2	2019-01-15 08:05:47	SpO2 Alarm	50	92			51		
3	2019-01-15 08:06:47	HR Alarm	50	93			75		
4	2019-01-15 08:06:47	SpO2 Alarm	60	93			75		
5	2019-01-15 08:07:47	SpO2 Alarm	60	91			118		
6	2019-01-15 08:07:47	SpO2 Alarm	60	91			118		
7	2019-01-15 08:08:47	SpO2 Alarm	60	91			46		
8	2019-01-15 08:08:47	SpO2 Alarm	60	91			46		

Navigation bar:    **1/13** **1/14** **1/15** **1/16** **Print Page** **Print All** **BACK** **EXIT**

The Alarm History page also contains the following buttons:

- I : jump to previous 10 items.
- I : jump to next 10 items.
- I : jump to the end.
- I Timescale :
 - I Green bar: there are ECG waveforms in the database.
 - I Yellow dots: there are events at that time
 - I Red dots: there are alarms triggered at that time
- I **1/13, 1/14, 1/15, 1/16**: change Timescale range.
- I **Print Page**: print current list.
- I **Print All** : print all alarm list (the maximum number is 100)
- I **BACK**: go to Menu page

- I **EXIT:** go to Main Screen.



List

The List page displays all alarm, manual operation, time and related data. If you double click alarm column, it will lead to the **Review** page.

Full Disclosure		Trend	Alarm History	List	Event			
	Time	Alarm	HR	SpO ₂	Sys. artk	Diastolic	Resp. rate	Temp
7	2010/01/15 06:01:45	HR Alarm	60	93			75	
8	2010/01/15 06:03:45	SpO ₂ Alarm	60	93			75	
9	2010/01/15 06:04:11	SpO ₂ Alarm	60	91			115	
10	2010/01/15 06:04:11	SpO ₂ Alarm	60	91			115	
11	2010/01/15 06:07:35	SpO ₂ Alarm	60	91			46	
12	2010/01/15 06:07:35	SpO ₂ Alarm	60	91			46	
13	2010/01/15 06:01:20	Temp	60	91			100	35.9
14	2010/01/15 06:04:15	Manual	60	91			255	
15	2010/01/15 06:04:15	Manual	60	92			69	
16	2010/01/15 06:07:41	NIBP	60	92	113	64	75	

Navigation controls: 1/13, 1/14, 1/15, 1/16 (highlighted), Print Page, Print All, BACK, EXIT

The List page also contains the following buttons:



- I : jump to previous 10 items.
- I : jump to next 10 items.
- I : jump to the end.
- I Timescale :
 - i Green bar: there are ECG waveforms in the database.
 - i Yellow dots: there are events at that time
 - i Red dots: there are alarms triggered at that time
- I 1/13, 1/14, 1/15, 1/16: change Timescale range.
- I **Print Page:** print current list.
- I **Print All** : print all alarm list (the maximum number is 400)
- I **BACK:** go to Menu page
- I **EXIT:** go to Main Screen.

Event

The Event page shows marks of ECG, SpO₂, NIBP, RESP, temperature and Manual operation events.



The Event page also contains the following buttons:

- I : go back 1 hour.
- I : go forward 1 hour.
- I : jump to the end.
- I Timescale :
 - i Green bar: there are ECG waveforms in the database.
 - i Yellow dots: there are events at that time
 - i Red dots: there are alarms triggered at that time
- I **1/13, 1/14, 1/15, 1/16**: change Timescale range.
- I **BACK**: go to Menu page
- I **EXIT**: go to Main Screen.

Review

The Review page will be shown when the user double clicks an item from the list of the Alarm History page or the List page. The texts on the right side indicate the occurred time and the name of the selected item. Take the following figure as an example: **HR Alarm of List** means the information shown on the left is the content of the HR alarm in the List page, the 7th item of 16 items from the list.



The Review page also contains the following buttons:

- I **Previous:** previous stored image.
- I **Next:** next stored image.
- I **Print:** print image
- I **Email:** email to someone.
- I **BACK:** go to Alarm History page or List page.

Parameter Set-up

ECG monitor

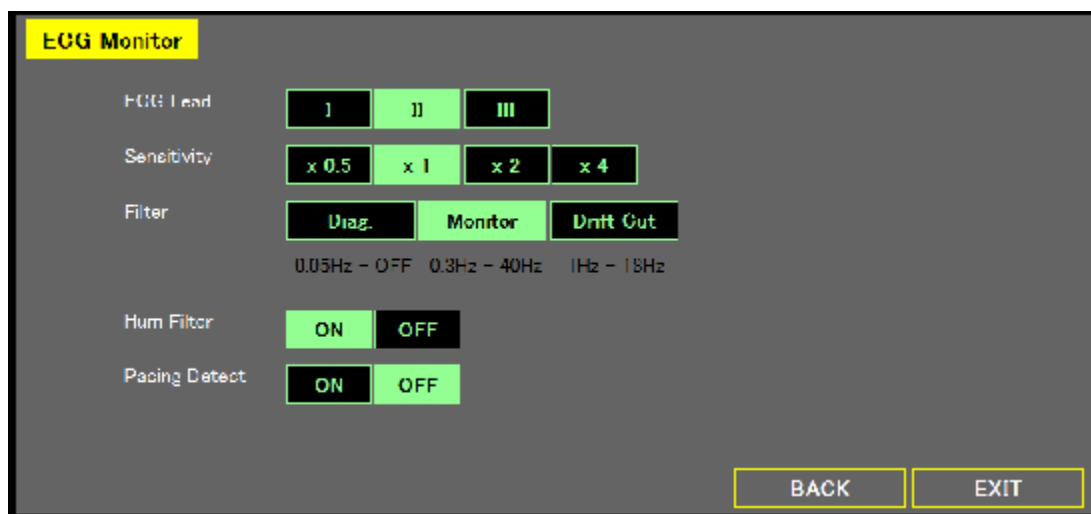

The ECG Main Screen contains the following setting options and buttons:

- I **ECG Lead:** select Lead source.
- I **Sensitive:** adjust ECG amplitude
- I **Filter:** select filter
- I **Hum Filter:** disable or enable hum filter
- I **Pacing Detect:** disable or enable pacing detect
- I **BACK:** go to Menu page.
- I **EXIT:** go to Main Screen.

ECG 12 Leads

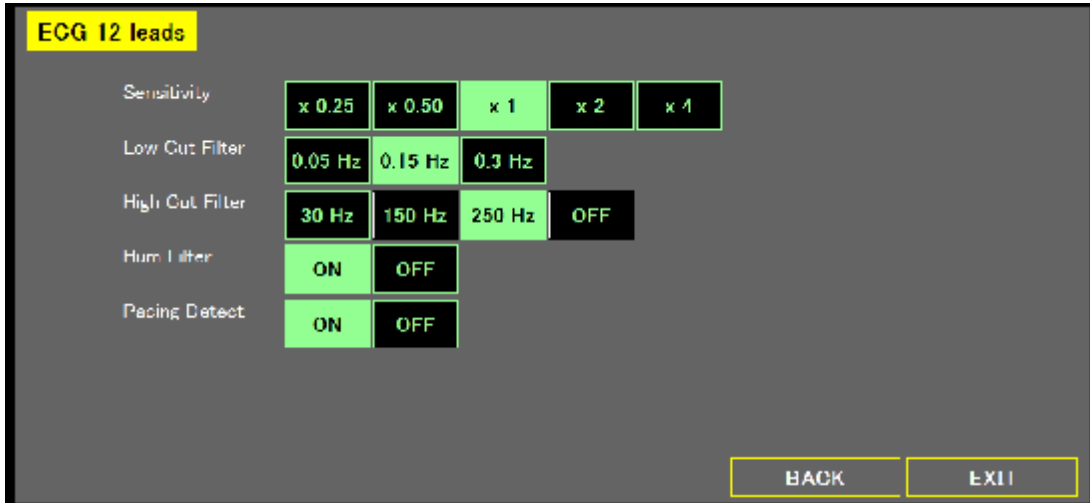

The ECG 12 Leads page contains the following setting options and buttons:

- I **Sensitive:** adjust ECG amplitude
- I **Low Cut Filter:** select frequency
- I **High Cut Filter:** select frequency
- I **Hum Filter:** disable or enable hum filter
- I **Pacing Detect:** disable or enable pacing detect
- I Rhythm Lead: select ECG source
- I **BACK:** go to Menu page.
- I **EXIT:** go to Main Screen.

NIBP

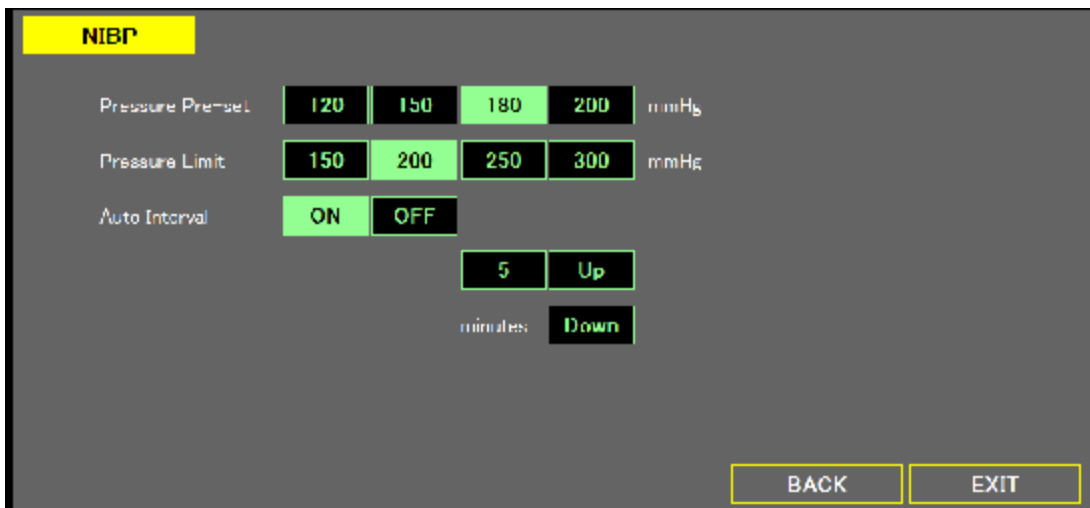

The NIBP page contains the following setting options and buttons:

- I Pressure Pre-Set & Pressure Limit: setting the air pump range.
- I Auto Interval:
 - i **OFF:** Disable
 - i **ON:** Enable auto measurement function. User can control Up & Down to adjust interval. A countdown timer will be displayed on the top of the Main Screen.
- I **BACK:** go to Menu page.
- I **EXIT:** go to Main Screen.

RESP

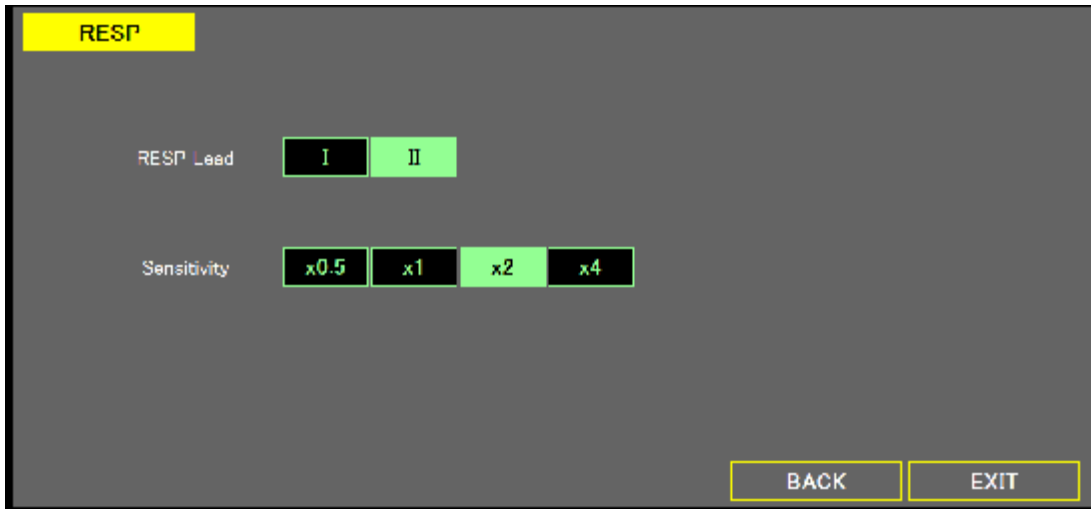

The RESP page contains the following setting options and buttons:

- I **RESP Lead:** select respiration lead
- I **Sensitivity:** adjust waveform amplitude.
- I **BACK:** go to Menu page.
- I **EXIT:** go to Main Screen.

Set-up

Sound/List

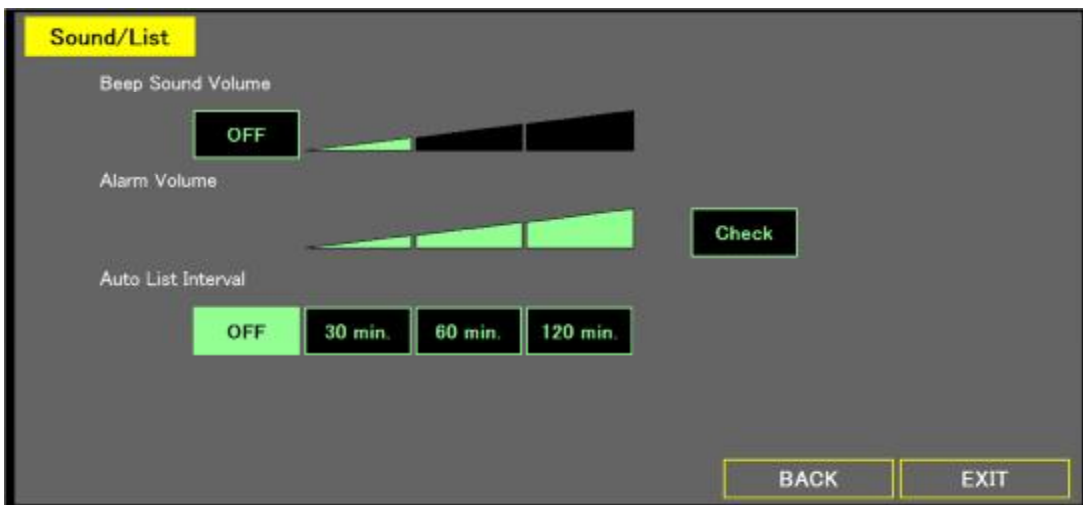

The Sound/List page contains the following setting options and buttons:

- I **Beep Sound Volume:** adjust beep sound volume.
- I **Alarm Volume:** adjust alarm volume.
- I **Auto List Interval:** depend on interval setting to store Monitor image.
- I **System Mode:** select different parameter setting.
- I **BACK:** go to Menu page.
- I **EXIT:** go to Main Screen.

System

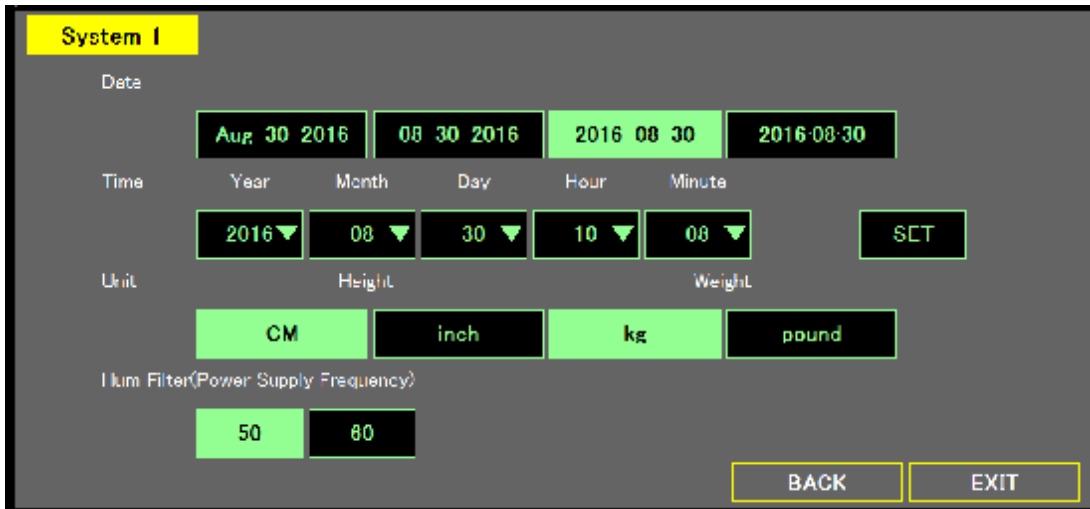

The System 1 page contains the following setting options and buttons:

- I **Date:** select date format
- I **Time:** set system time
- I **Unit:** change height and weight unit.
- I **Language:** select language
- I **Hum Filter:** select filter frequency.

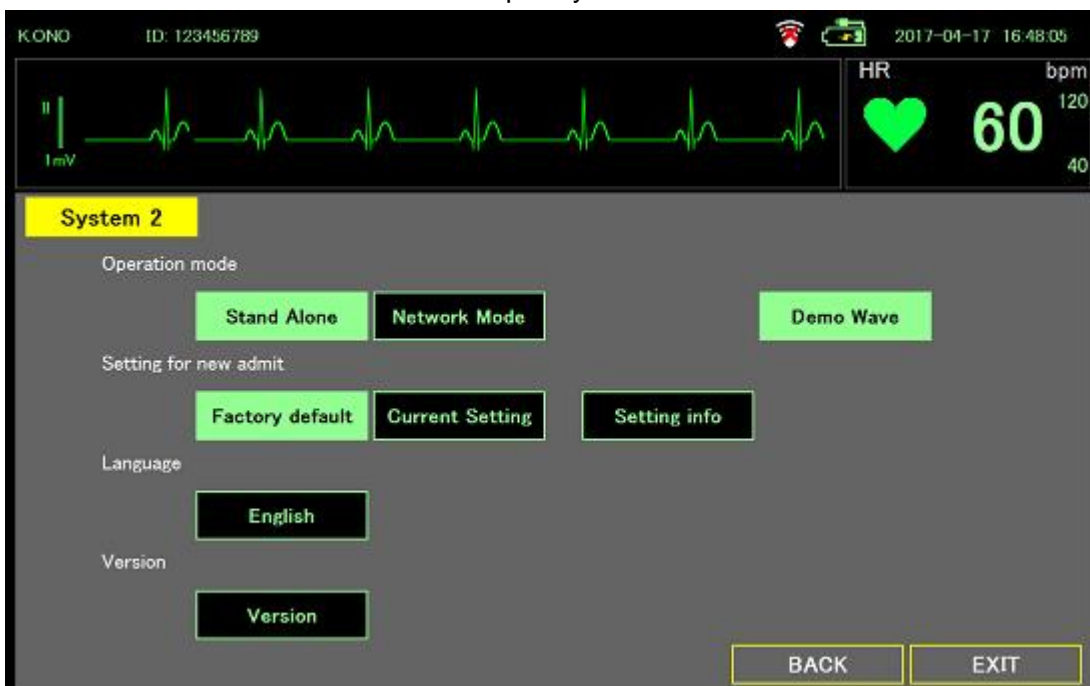

The System 2 page contains the following setting options and buttons:

- I **Operation mode:** Use as “Stand Alone” or “Network Mode”, currently these two mode has no difference. For demonstration purpose adding “Demo Wave” mode
- I **Setting for new admit:** For adding new user, using “Factory default” setting or “Current Setting” for new user, able to click “Setting info” has a summary page for all the settings as below picture
- I **Language:** Select proper language for use, currently support English only
- I **Version:** Click Version button to have the related information including hardware and software as below picture

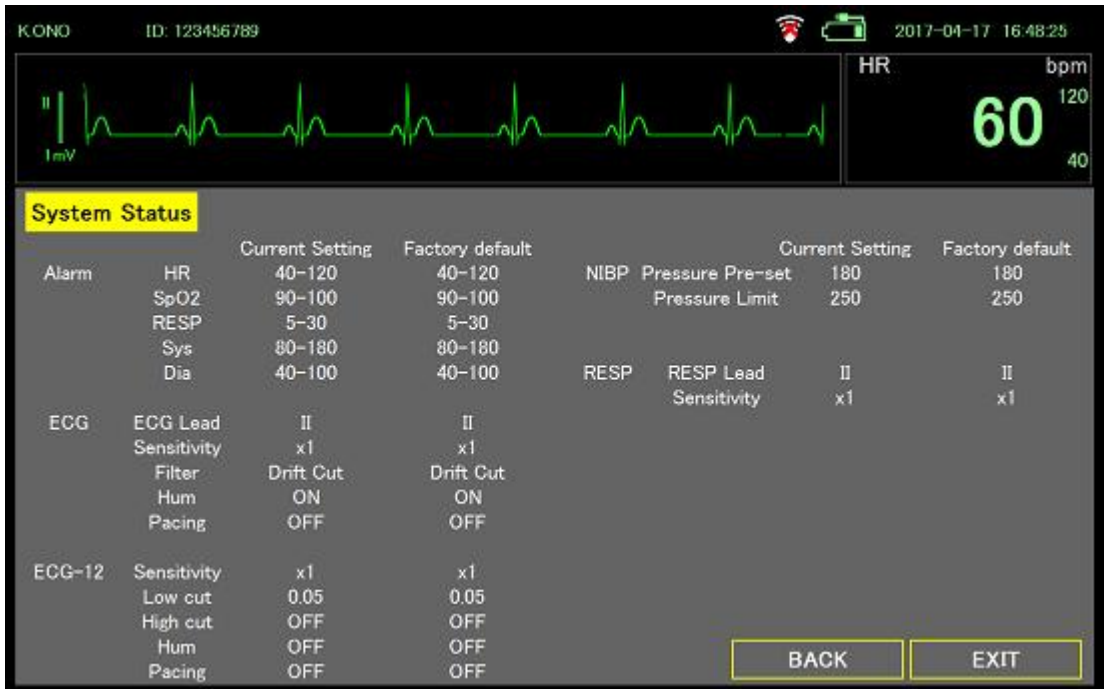

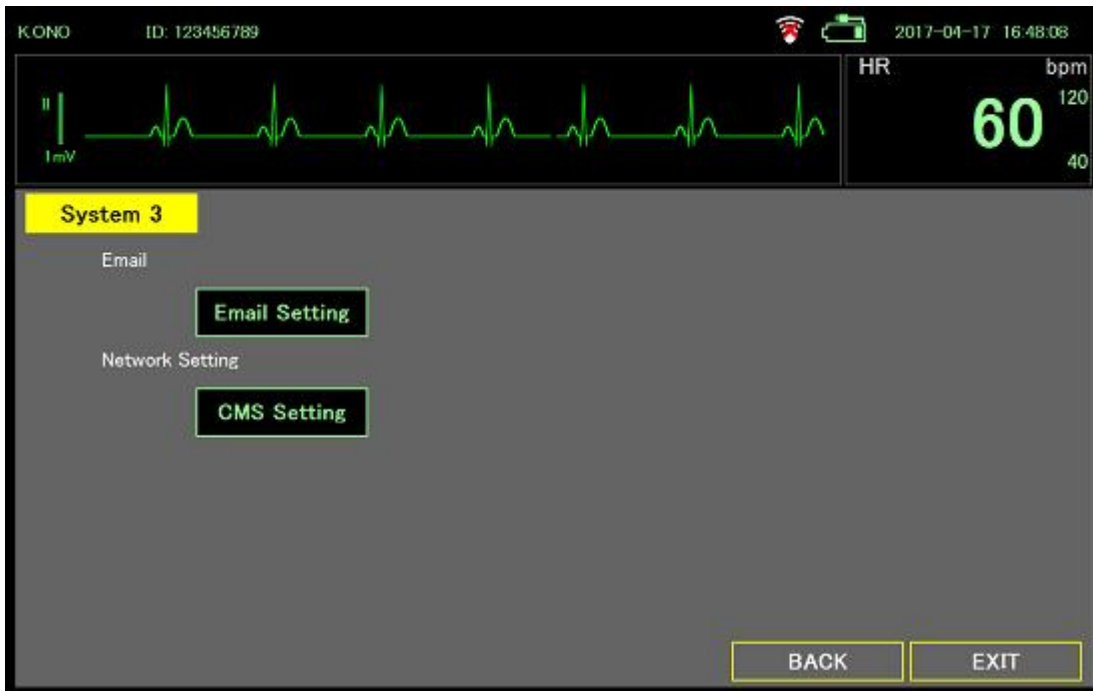

The System 3 page contains the following setting options and buttons:

- I **E-mail Setting:** Set the email related information for sending mail function, image as below.
- I **CMS Setting:** Setting up CMS IP information, current version software does not enable this function.



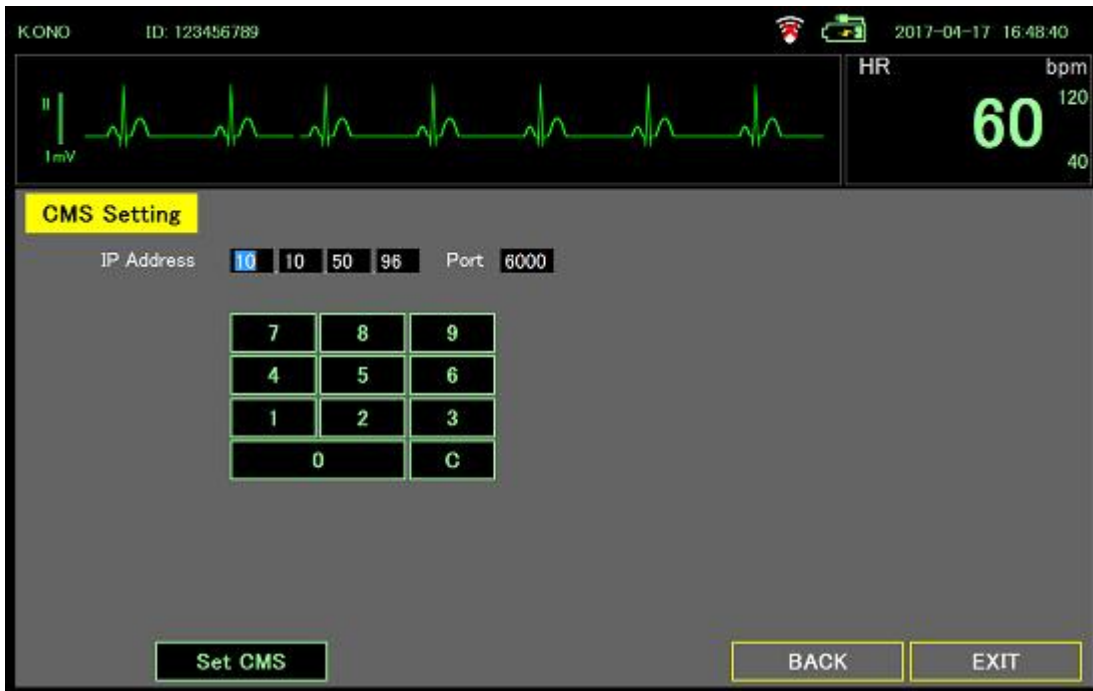

Power Off

The Power Off page provides the following three options for users to power off the system or to close the application:

- I Standard Shutdown
Press “Standard ShutDown” button.
DS-101 turns off
- I Sleep Mode
Press “Sleep mode Shut Down” button.
DS-101 enters sleep mode. Press the power button to start up quickly.
- I Exit Software

Press  button.

Entering the password and return key, ends DS-101 and returns to Windows.



Alarms

The monitor presents physiological alarms and technical alarms. Physiological alarms occur when vital sign measurements fall outside of set alarm limits.

Alarm types

Type	Priority	Color	Alarm audio tone
Heart Rate, Respiration rate, SpO2, NIBP, or Pulse rate limit exceeded	High	Red	5-pulse tone
Some technical alarms	Low	Blue	1-pulse tone

Non-latching alarm

The alarm of this monitor is non-latch type.

The alarm stops when the vital sign returns within the set alarm limits.

However, alarms that occurred in the past can be confirmed in the alarm history screen.

If there is an unconfirmed alarm, change the Alarm History button to red and inform it

Alarm notification locations



WARNING If you are relying on visual alarm notifications, maintain a clear line of sight with the monitor. If you are relying on audio alarm notifications, ensure that you can hear audio alarms from where you are. Set the volume as needed considering the environment and ambient noise levels.

LED light bar

The light bar on the top of the monitor illuminates as follows:

- ! Flashing red for high priority alarms
- ! Constant blue for low priority alarms

Main screen





Main screen notifications	
Notification	Description
Information area	Audio pause button appears when alarm occurs. If the audio pause button is pressed, a timer countdown appears. If monitoring is started within 1 minute (or 2 minutes), or alarm pause button is pressed, alarm does not work. During that time countdown timer is displayed. (Depending on the setting in 1 or 2 minutes)
Parameter area	Display alarm information with red (high priority) or blue (low priority) frame. If multiple alarms are active, the most recent alarm message appears. You can confirmation each alarm on the alarm history screen.
Menu area	Alarm History button changes color to red. By pressing this button you can confirmation alarm on the alarm history screen, and the button changes color to black.



Icons on the Main screen

Icons in the parameter area	
Icon	Name and status
	Alarm off. No visual or audio alarms occur for this limit.



WARNING Alarm does not work during 12-lead ECG measurement. Also, the countdown timer of Alarm Pause is displayed from the start of monitoring and returning to monitoring from the 12-lead ECG measurement during which the alarm will not operate

Icons in the information area	
Icon	Name and status

	Alarm off. No visual and audio alarms occur.
	Alarm paused. Audio and visual notifications are paused for a period ranging from 1 to 2 minutes. This icon remains until the pause time counts down to 0.
	Audio paused. The audio tone is paused for a period ranging from 1 to 2 minutes. This icon remains until the pause time counts down to 0.

Reset (pause or turn off) audio alarms

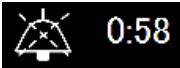
1. Alarm occur
 - I Audio and visual alarm occur when vital sign measurements fall outside of set alarm limits
 - I Flashing red LED and 5-pulse tone sound.
 - I Alarm message frame appears on parameter area.
 - I Sound Pause button appears on information area.
2. Audio paused
 - I Touch  button.
 - I Audio alarm stops but flashing LED continues.
 - I Audio pause count down timer appears. 
 - I Investigate the cause of the alarm and deal with it
 - I Change the alarm limits if necessary
 - I Alarm messages will not disappear unless Vital signs returns within alarm limits

Disable the alarm for a period

You can disable the alarm for a certain period of time

1. Go to the Alarm setting screen.
 - I Touch the Menu button on Main screen.
 - I Touch the Alarm setting button on Menu screen.
2. Disable the alarm for a period.
 - I Touch the Alarm Paused key

If the alarm is off, the icon on the Main screen in the parameter area.

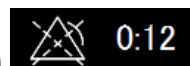



Modify audio pause, alarm pause period

You can modify the period of audio alarm pause

1. Touch the Menu key.
2. Touch the Alarm setting key.
3. Touch the Period setting key
4. On the Period setting screen, modify period.



Adjust vital sign alarm limits

You can adjust vital sign alarm limits or turn off alarm limit checking for individual parameters.



WARNING Alarm limits are user adjustable. All alarm limit settings should be set accordingly for each patient.

1. Go to the Alarm setting screen.
 - I Touch the Menu button on Main screen.
 - I Touch the Alarm setting button on Menu screen.
2. Adjust vital sign alarm limits.
 - I To adjust a limit: Enter the desired upper and lower alarm limits using the up/down arrow key by touch the Lower/Upper limit button.
 - I To turn alarm off: Touch the parameter button for which you want to turn off the

alarm.

If you turn off alarm, no visual or audio alarm signals will occur for those parameters.



If the alarm is off, the icon on the Main screen in the parameter area.



Default alarm limit

You can set the alarm limit to default with touch the “Default” button.

Default alarm limits are follows.

Parameter	Unit	Lower Limit	Upper Limit
HR/PR	BPM	40	120
SpO2	%	90	100
Resp	/min	5	30
NIBP Sys	mmHg	80	180
NIBP Dia	mmHg	40	100

NOTE Whether the alarm limit at patient admit to the default value or to use the previous patient value depends on System setting

Modify audio alarm notification

You can modify the volume of all audio alarm.



WARNING The alarm volume should be loud enough for you to hear it from where you are. Set the volume considering the environment and ambient noise level.

- I Touch the Menu key.
- I Touch the Sound/List key.
- I On the Sound/List screen, modify alarm volume level.



Note You can check the alarm sound volume by pressing the Check key.

Alarm Confirmation

You can check past alarms.

On Main screen

1. Touch the Alarm History key.
2. You can check up to 8 alarms in the past.



On Review screen

1. Touch the Menu key.
2. Touch the Alarm History in the Review category.
3. You can check up to 200 alarms with the arrow keys



4. Double-click on the alarm time to check the waveform at that time.



Alarm message and situation

Physiological alarms: Priority High

Alarm messages	Display area	Situation
HR XX hh:mm	ECG frame	Heart Rate alarm limit exceeded at hh:mm
RESP XX hh:mm	REP frame	Resp rate alarm limit exceeded at hh:mm
SpO2 XX hh:mm	SpO2 frame	SpO2 alarm limit exceeded at hh:mm
NIBP XX/YY hh:mm	NIBP frame	NIBP alarm limit exceeded at hh:mm

Technical alarms: Priority Low

Alarm messages	Display area	Situation
Lead-off	ECG frame	ECG lead is not connect or 1 or more electrodes out of the body
Lead-off	12L ECG screen	ECG lead disconnect or 1 or more electrodes out of the body
Lead-off	RESP frame	ECG lead disconnect or 1 or more electrodes are out of the body
Probe-off	SpO2 frame	SpO2 sensor is not connect

Finger-off	SpO2 frame	SpO2 sensor is out of finger
------------	------------	------------------------------

Patient monitoring

ECG

ECG frame

From the ECG frame, you can measure Heart Rate (HR).

Located in the upper right corner of the Main screen, the ECG frame contains data and features relevant to ECG. (Main Screen and Larged Screen)



- I You can check the Heart Rate
- I You can see the synchronized heart beat with blinking heart mark.
- I You can see Heart Rate alarm limits. (Upper and Lower), right of the Heart Rate.
- I If alarm is off, you can see alarm off mark. 
- I When either of If HR goes out of the alarm range, the red LED flashes, an alarm tone sounds and an alarm message is displayed.



ECG display

The ECG waveform is always display on the bottom of the Main screen, expect of SpO2 only modes.

ECG & SpO2 mode

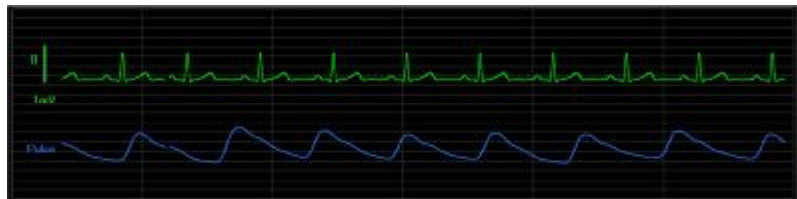

ECG mode





ECG cascade mode

- I ECG lead is displayed on the left side of the screen.
- I Calibration bar linked to the ECG sensitivity is displayed on the left side of the screen.
- I Touch the screen to fix the waveform.



WARNING If the system shows “LEAD OFF”, please refer to the trouble shooting section

ECG Electrode Placement

Please place electrode as below graph

Symbol	Color	Electrode Site
R	Red	On the right infraclavicular fossa
L	Yellow	On the left infraclavicular fossa
F	Green	On the left midclavicular line, near the supracrestal line.

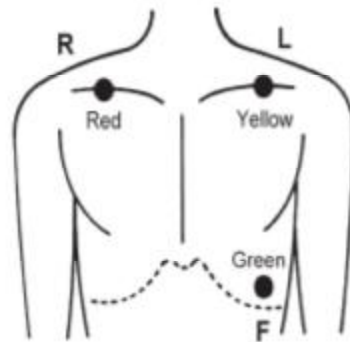

ECG Alarm

1. Touch the Menu key.
2. Touch the Alarm Setting key.
3. Heart Rate is displayed in the HR/PR key and the green line on the bar graph
4. To set the Hart Rate alarm limits, use the arrow key on the right side of the screen to follow these steps:
 - I Touch the Lower Limit key, change limit using arrow key.
 - I Touch the Upper Limit key, change limit using allow key.
 - I Alarm limit is changed immediately.
5. If you want to turn off the alarm, press the HR/PR key to make it black.



ECG Monitor Setting (Lead, Sensitivity, Filter, Pacing Detect)

1. Touch the Menu key.
2. Touch the ECG Monitor key.
3. You can configure the lead, sensitivity, filter, and pacing detect.



4. Select ECG Lead.
 - I The ECG function can use 3 wire and 10 wire lead.
 - I Only I, II, III leads can be selected regardless of which lead is used.
 - I Choose the lead with the QRS of ECG, the largest on the monitor.
5. Select Sensitivity

The height of the vertical ruler that appears to the left of the ECG waveform indicates 1 mV amplitude and is 10 mm high if x1 is chosen.
6. Select the Filter in accordance with the intended use.
 - I Diag.: Use when observing the ST change due to ischemia.
 - I Monitor: Usually, use this mode.
 - I Drift Cut: Select when using in an environment with a lot of ac noise. Waveform distortion increases.

Note This DS-101 does not have arrhythmia detection. Please carefully observe the patient's condition by using upper / lower limit alarm of Heart Rate.

Note Detection of ischemia is the interpretation of the clinician only, the DS-101 does not provide automated ischemia detection.

Note It is normal for the ECG baseline to wander slightly in Diag. Filter.

7. Turn on the Hum Filter with the intended use.
Turn on when AC noises enter even if electrode and lead wires are adjusted.
8. Turn on the Pacing Detect with the intended use.
 - I Used for pacemaker patients.
 - I Pacing Detection is on, the DS-101 displays pacemaker signals exactly as they are captured.



WARNING PACEMAKER PATIENTS. See this manual for disclosure of the pacemaker pulse rejection capability of this instrument”



WARNING Heart Rate may continue to count the pacemaker rate during occurrences of cardiac arrest or some arrhythmias. Do not rely entirely upon rate meter alarms. Keep pacemaker patients under close surveillance



RESP (Respiration)

RESP frame

From the RESP frame, you can measure Respiration Rate (RR).

Located in the center of the Main screen, the RESP frame contains data and features relevant to Respiration.

Main Screen

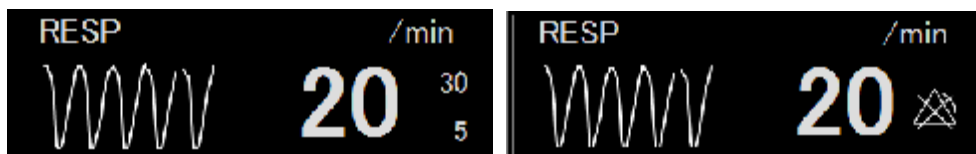

Large Screen



- I You can check the Respiration Rate
- I You can see the synchronized chest motion with RESP wave (Main Screen) or 5 level bar (Large Screen).
- I You can see Respiration Rate alarm limits. (Upper and Lower), right of the RR.
- I If alarm is off, you can see alarm off mark. 
- I When either of If RR goes out of the alarm range, the red LED flashes, an alarm tone sounds and an alarm message is displayed.

RESP display

- I The Respiration waveform is display on the left of the RESP frame (Main Screen).
- I The Respiration synchronized bar is display on the left of the RESP frame (Large Screen).

RESP Alarm

1. Touch the Menu key.
2. Touch the Alarm Setting key.
3. Respiration rate is displayed in the Resp key and the green line on the bar graph.
4. To set the Respiration Rate alarm limits, use the arrow key on the right side of the screen to follow these steps:
 - I Touch the Lower Limit key, change limit using arrow key.
 - I Touch the Upper Limit key, change limit using allow key.
 - I Alarm limit is changed immediately.
5. If you want to turn off the alarm, press the Resp key to make it black.



RESP Setting

1. Touch the Menu key.
2. Touch the ECG Monitor key.
3. You can configure the lead, sensitivity.



4. Select RESP Lead

Respiration Rate is measured with the ECG leads. As the chest expands and contracts during the respiration cycle, the resistance, or impedance, between the RA-LA electrodes (Lead I) changes. The result of these changes indicates the respiration rate.

If the respiration waveform is small, change it to lead II (RA-LF).

5. Select Sensitivity.

The amplitude of the respiration waveform is 10 mm with 1-ohm impedance change at x1.

To detect respiratory rate, a waveform of 3 mm or more is required. Adjust the sensitivity within the range not picking up heartbeat.

SpO2

SpO2 frame

From the SpO2 frame, you can measure the SpO2% and Pulse Rate (PR).

Located in the under of ECG frame on the Main screen, the SpO2 frame contains data and features relevant to SpO2. (Main Screen and Large Screen)

Main Screen

Alarm ON

Alarm OFF



I You can check the SpO2 %

I You can see the oximetry pulse volume, displayed as a vertical bar graph.

I You can see SpO2 % alarm limits. (Upper and Lower), right of the SpO2 %

I If alarm is off, you can see alarm off mark.



I When either of If SpO2 % goes out of the alarm range, the red LED flashes, an alarm tone sounds and an alarm message is displayed.

Pulse wave display

- I The Pulse waveform is always display on the bottom of the Main screen, expect of ECG 1ch, ECG cascade modes.

ECG & SpO2 mode

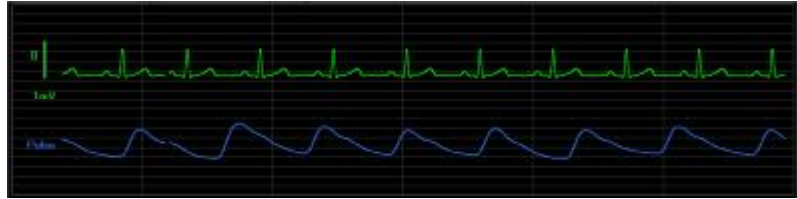

SpO2 mode

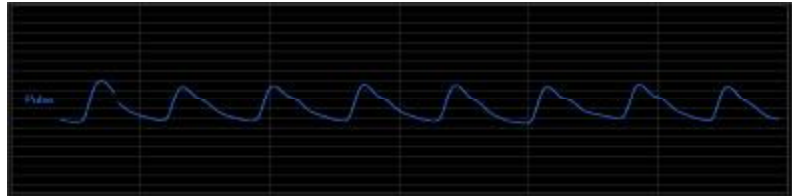

- I Amplitude of the pulse wave is automatically adjusted.
- I Touch the screen to fix the waveform.

PR display

When pulse only mode is selected, Heart Rate (HR) display changes to Pulse Rate (PR) display. You can check the Pulse Rate on ECG frame.

HR display



PR display



Note When the pulse only mode is selected, ECG and RESP related alarm are turned off. (Including ECG and RESP lead off warning)

SpO2 and PR Alarm

1. Touch the Menu key.
2. Touch the Alarm Setting key.
3. SpO2 % is displayed in the SpO2 key and the green line on the bar graph.
4. To set the SpO2 alarm limits, use the arrow key on the right side of the screen to follow these steps:
 - I Touch the Lower Limit key, change limit using arrow key.
 - I Touch the Upper Limit key, change limit using allow key.
 - I Alarm limit is changed immediately.
5. In the pulse only mode, use the arrow on the right side of the screen to set the alarm limits of the Pulse Rate
6. If you want to turn off the SpO2 alarm, press the SpO2 key to make it black.
7. If you want to turn off the PR alarm, press the HR/PR key to make it black.



Measure SpO2 and pulse rate

SpO2 and pulse rate monitoring continuously measures saturation level of oxygen in hemoglobin as well as the pulse in a patient through a pulse Oximeter.



WARNING The accuracy of the SpO2 measurement can be affected by any of the following:

- | The presence of significant amounts of dysfunctional hemoglobin, such as carboxyhemoglobin or methemoglobin
- | The presence of concentrations of some intravascular dyes, sufficient to change the patient's usual arterial pigmentation
- | Patient movement
- | Patient conditions such as shivering and smoke inhalation
- | Painted nails
- | Poor oxygen perfusion
- | Anemia or low concentrations of hemoglobin
- | Hypotension or hypertension
- | Severe vasoconstriction
- | Shock or cardiac arrest
- | Venous pulsations or sudden and significant changes in pulse rate
- | Proximity to an MRI environment
- | Moisture in the sensor
- | Excessive ambient light, especially fluorescent
- | Wrong sensor or sensor too tight

1. Verify the SpO2 sensor cable is connected to the monitor.



WARNING Patient injury risk. The SpO2 sensor and extension cables are intended only for connect to pulse oximetry equipment. Do not attempt to connect these cables to a PC or any similar device. Always follow the sensor manufacturer's directions for use for care and use of the SpO2 sensor.

2. Clean the application site. Remove anything, such as nail polish, that could interfere with sensor operation.

Note Do not use disposable sensors on patients who have allergic reactions to the adhesive.

- Attach the SpO2 sensor to the patient according to the manufacturer's directions for use, observing all warnings and cautions.

Note If a sterile sensor is required, select a sensor that has been validated for sterilization, and follow the sensor manufacturer's direction for use to sterilize the sensor.

Place the SpO2 sensor and the NIBP cuff on different limbs to reduce unnecessary alarms when you monitor NIBP and SpO2 at the same time.

Note A range of different sensors is available for different patient sizes and measurement sites. Consult the SpO2 sensor manufacturer's direction for use to select the correct sensor based on the patient's weight.

- Confirm the monitor display SpO2 and pulse rate data within 15 seconds of being connected to a patient.



WARNING Patient injury risk. Incorrect application or a long duration of use of an SpO2 sensor may cause tissue damage. Inspect the sensor site periodically as directed in the sensor manufacturer's direction for use.

During an SpO2 measurement, the displayed pulse rate is derived from the SpO2 sensor. If SpO2 is not available, the pulse rate is derived from NOBP.

Detaching the sensor during an SpO2 measurement in Monitor mode triggers an alarm.

If SpO2 is being measured continuously on a patient for an extended period, change the sensor location at least every three hours or as indicated by the sensor manufacturer's direction for use.

NIBP

NIBP frame

From the NIBP frame, you can measure blood pressure.

Located in the upper right corner of Main screen, the NIBP frame contains data and features relevant to noninvasive blood pressure measurement.

Main Screen

Alarm ON

Alarm OFF



Large Screen

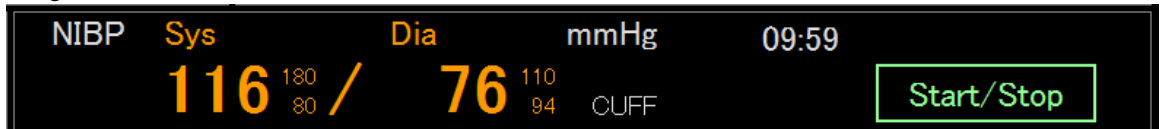

- The frame can display Systolic and Diastolic measurements.
- You can see blood pressure alarm limits. (Upper and Lower)
- If alarm is off, you can see alarm off mark. 

- When measuring blood pressure, cuff pressure is displayed and pulsation is indicated by vertical bar graph.

NIBP measure window

Touch the NIBP frame except the start/stop key opens a NIBP Measure window



- The frame can display Systolic and Diastolic measurements.
- You can see blood pressure alarm limits. (Upper and Lower)
- You can see previous NIBP measurement data.
- When blood pressure is measured, a graph of cuff pressure and pulsation is displayed.

NIBP Alarm

- Touch the Menu key.
- Touch the Alarm Setting key.
- Sys Dia is displayed in the NIBP key and the green line on the bar graph.
- To set the NIBP alarm limits, use the arrow key on the right side of the screen to follow these steps:
 - Touch the Lower Limit key, change limit using arrow key.
 - Touch the Upper Limit key, change limit using allow key.
 - Alarm limit is changed immediately.
- If you want to turn off the NIBP alarm, press the NIBP key to make it black.



Select a cuff



WARNING Use only blood pressure cuffs and hoses listed as approved accessories to ensure safe and accurate NIBP measurements.



WARNING This blood pressure measurement cannot be used for neonates and pediatric.



Caution Correct sizing of the blood pressure cuff is important for accurate blood pressure readings. A cuff that is too small might provide false high readings, while a cuff that is too large might provide false low readings.

The monitor uses the oscillometric method to determine blood pressure; therefore, if the cuff extends to the antecubital fossa (bend in the elbow), you can still acquire an accurate blood pressure reading.

Before taking an NIBP measurement, follow these steps to select the appropriate cuff for the patient.

1. Measure the circumference of the patient's bare upper arm. Midway between the elbow and shoulder.
2. Choose the appropriate cuff size based on the circumference measurement. If the circumference of the patient's arm falls between two cuff sizes, use the large cuff size.
3. Cuff size can also be selected using the circumference index at the end of the cuff. The size of the cuff is fit if the patient's upper arm's end is between the two arrows of the index mark
4. Wrap the cuff by placing the arterial index mark on the inside of the patient's bare upper arm.

Cuff measurements

The following tables provide measurement for BriteMed pressure cuffs.

Cuff	Circumference (cm)
ADULT-S	17.0 – 25.0
ADULT-M	23.0 – 33.0
ADULT-L	31.0 – 43.0

Position the cuff

Note The monitor and cuffs were validated using the bare upper arm site.



WARNING Patient injury risk. Do not use the NIBP for continuous monitoring without frequently checking the patient's limb. When a patient is being monitored frequently or for a prolonged period, regularly remove the cuff to inspect it and to check the cuff site for ischemia, purpura, or neuropathy.



WARNING Inaccurate measurement risk. Do not place the cuff where it can disturb proper circulation. Do not place the cuff on any area where circulation is compromised or on any extremity used for intravenous infusions. Do not use an SpO2 finger clip sensor and a blood pressure cuff simultaneously on the same limb. Doing so may cause a temporary loss of pulsation flow, resulting in either no reading or an inaccurate SpO2 or pulse rate until the flow returns.



WARNING The blood pressure cuff must be properly positioned to ensure blood pressure accuracy and patient safety. Wrapping the cuff too loosely (preventing proper inflation) may result in inaccurate NIBP readings.



Caution If a site other than the bare upper arm is used, the blood pressure measurements may be different. It is important to document the alternate site on the patient record.



Caution To minimize inaccurate measurement, limit patient movement during an NIBP measurement cycle.

Before taking an NIBP measurement, follow these steps and select the appropriate cuff for the patient.

1. Comfortably seated, Legs uncrossed, Feet flat on the floor, Back and arm supported, to relax as much as possible and not talk during the measurement procedure. Recommend to have 5 min elapse before the first reading is taken
2. Position middle of the CUFF at the level of the right atrium of the heart
3. Wrap the cuff snugly so that there is room for no more than two fingers between the cuff and the patient's bare upper arm.
4. Position the alignment mark on the cuff directly over the brachial artery.
5. Ensure that the blood pressure tubing has no kinks or twists.

NIBP measurement

The monitor enables you to take manual and automatic NIBP measurement



WARNING NIBP readings may be inaccurate for patients experiencing moderate to severe arrhythmia



WARNING Inaccurate measurement risk. Pulse rate measurements generated through the blood pressure cuff or through SpO2 are subject artifact and might not be as accurate as heart rate measurements generated through ECG or through manual palpation.



Caution Inaccurate measurement risk. Any external compression of the blood pressure hose or cuff may cause system errors or inaccurate measurements.

At the start of a measurement, the monitor inflates the cuff to the appropriate level. In the NIBP frame or NIBP measure window, the cuff display shows the cuff inflation pressure while the blood pressure measurement is in progress.

The monitor measures blood pressure as the cuff is inflating. If patient movement, excessive noise, or an arrhythmia prevent the monitor from determining the blood pressure while the cuff is inflating, the monitor inflating the cuff pressure again.

When the measurement is complete, the NIBP frame displays the measurement until you start another NIBP measurement.

Take a manual NIBP measurement



WARNING Patient injury risk. Never install Luer Lock connectors on Fukuda Denshi blood pressure cuff tubing. Using these connectors on blood pressure cuff tubing creates the risk of mistakenly connecting this tubing to a patient's intravenous line and introducing air into the patient's circulatory system.



Caution Inaccurate measurement risk. Any external compression of the blood pressure hose or cuff may cause system errors or inaccurate measurements.

1. Properly size the blood pressure cuff and position it around the patient's bare upper arm.
2. Touch Start/Stop to take a measurement.

Interval NIBP measurement and other setting

The monitor can take NIBP measurements automatically based on intervals you choose.

The NIBP setting screen provides interval features.

1. Touch the MENU key
2. Touch the NIBP key
3. Select Pressure Pre-set. The cuff inflates to this pressure for the first time. When it can not be measured, the cuff inflates to 50 mmHg higher pressure.
4. Select Pressure Limit. The cuff does not inflate above this pressure.
5. If you want interval measurement touch Auto Interval ON key.
6. When the Auto Interval is turned on, the interval setting key is displayed and can be set using the up and down keys
7. Turn on Interval measurement, and when you exit the setting screen the interval timer starts counting down
8. When the countdown becomes 0, blood pressure is measured.

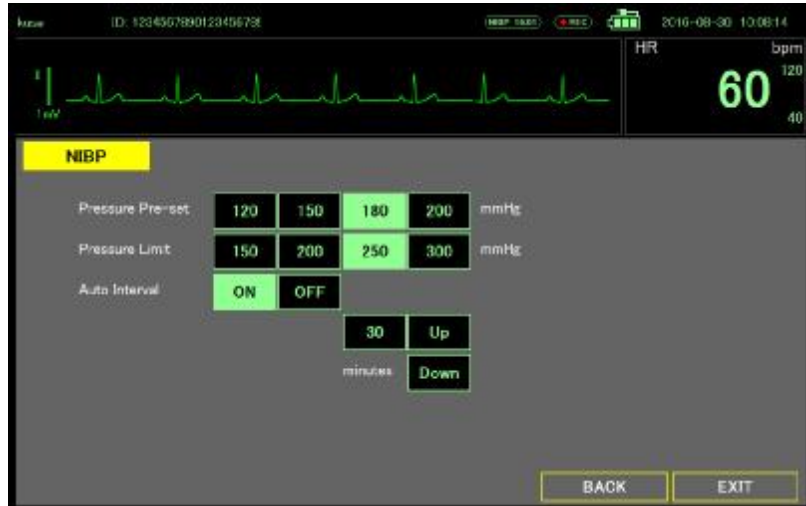

When the interval measurement is complete, the NIBP frame displays the measurement until the next measurement is complete.

The result of the interval measurement is saved as event data.

Note The result of the interval measurement is saved as event data

Note During intervals, each automatic and manual measurements clears all measurements from NIBP frame.

Temperature

Temperature frame

From the temperature frame you can measure patient temperature.

Located in the middle right of the Main screen, or center of Enlarge screen, the temperature frame contains data and features relevant to temperature measurement.

Main Screen



Enlarge Screen



Temperature measurement display

The frame can display temperature in Celsius or Fahrenheit. You can configure the default view in Settings. And display measurement time also.

Thermometer

The monitor receives thermometer data via NFC

Thermometer calculates patient's body temperature with thermistor and prediction algorithm.

Take a temperature in the Predictive mode



WARNING Inaccurate measurement risk. To ensure optimal accuracy, always confirm that the correct mode and site are selected.



WARNING Patient injury risk. Prior to taking a temperature, instruct the patient not to bite down on the probe as patient injury and damage to the probe may result.



Caution Probe covers are disposable, nonsterilized, and single-use. Probes are also nonsterilized. Do not autoclave probes and probe covers. Ensure that probe covers are disposed of according to facility requirements or local regulations.

1. Press the power button on the thermometer to turn it on. Sounds urge measurement
2. Insert the probe into a new probe cover.
3. Hold the probe tip in place at the measurement site.
 - I For oral temperatures, place the probe tip under the patient's tongue on either side of the mouth to reach the sublingual pocket and ask the patient to close his/her lips.
 - I For axillary temperatures, lift the patient's arm so that the entire axilla is easily seen and place the probe tip as high as possible in the mid-axilla. Verify that axillary tissue completely surrounds the probe tip and place the arm snugly at the patient's side.
4. While the measurement is taking place, the thermometer sounds a tone.
5. The thermometer sounds a burst tone when the final temperature is reached (in approximately 6 to 15 seconds).
6. Touch the temperature frame, temperature measurement screen displayed.



7. Touch the thermometer to NFC area of the monitor
NFC area

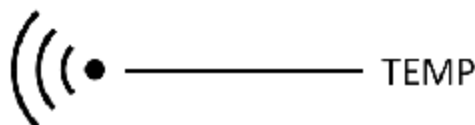

8. Sounds when the monitor receives temperature data from the thermometer. The temperature measure screen displays the temperature.



9. You can check the previous temperature data on record frame.

10. Touch exit to return Main screen, and temperature frame displays the temperature.

12 Lead ECG

In this mode, 12-lead electrocardiogram for measurement is measured with 10 leads cable. 3 lead cable is not suitable to use.

Vital sign alarm does not function because it is not continuous monitoring.

For that reason, Display setting of the MENU is separate from Monitoring.

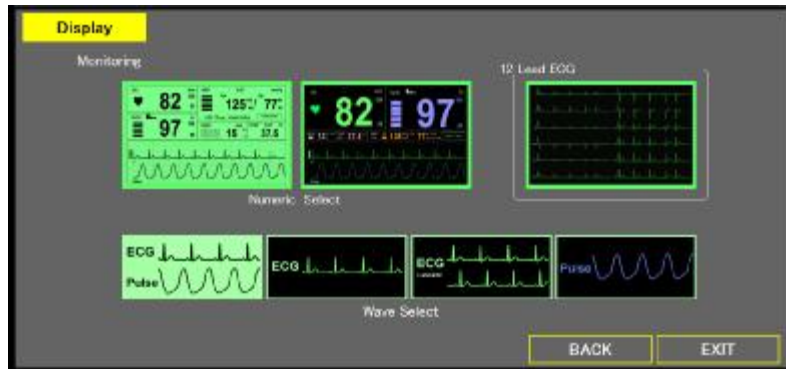

12 Lead ECG display

12 lead ECG is displayed for limb lead and chest lead for 5 sec.

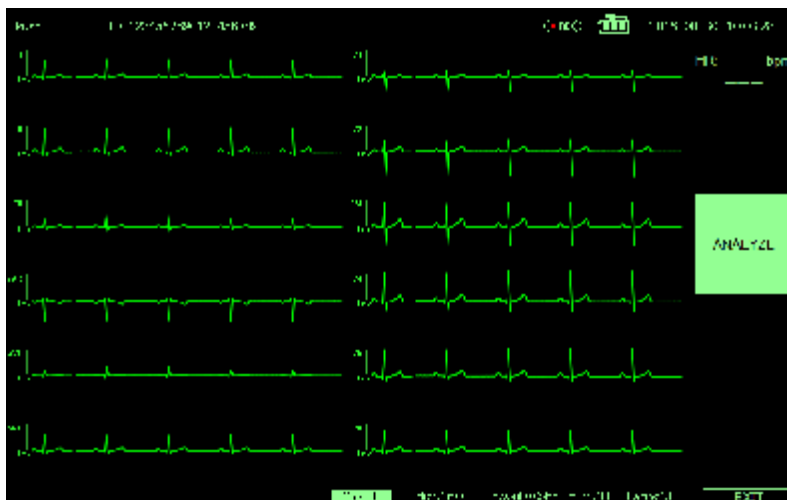

12 Lead ECG Alarm

12 L ECG does not have HR or arrhythmia alarm, it has only lead-off alarm.



12 Lead ECG Setting (Sensitivity, Filter, Pacing Detect)

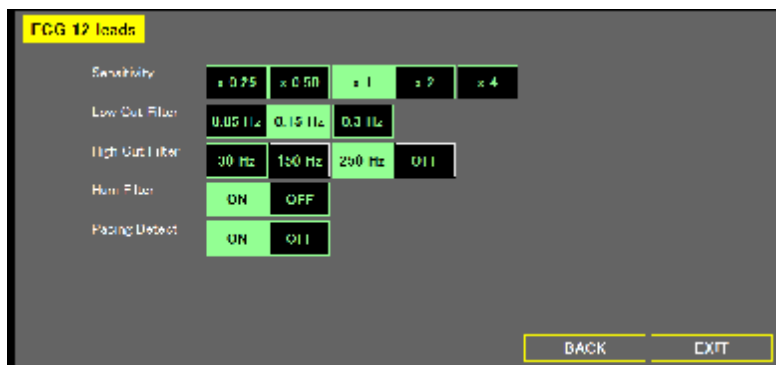

1. Touch the Menu key.
2. Touch the ECG 12 Leads.
3. You can configure the sensitivity, filter, and pacing detect.
4. Select Sensitivity
 - The height of the vertical ruler that appears to the left of the ECG waveform indicates 1 mV amplitude and is 10 mm high if x1 is chosen.
5. Select the Low Cut Filter in accordance with the intended use.
 - I 0.05Hz: This is standard for measurement ECG.
 - I 0.15Hz: Select when using 12-lead ECG as monitoring instead of diagnosis, draw less baseline drift.
 - I 0.3Hz: Select when patient's body movements are large, reduce the baseline drift.
 - I 0.3Hz: Select when using in an environment with a lot of ac noise. Waveform distortion increases.
6. Select the High Cut Filter in accordance with the intended use.
 - I OFF: This is standard for measurement ECG.
 - I 250Hz: Select this will reduce fine noise on the waveform
 - I 150Hz: Select when patient's EMG noise is large, reduce the EMG noise.
 - I 30Hz: Select when using in an environment with a lot of ac noise. Waveform distortion increases.
7. Turn on the Hum Filter with the intended use.

- Turn on when AC noises enter even if electrode and lead wires are adjusted.
- 8. Turn on the Pacing Detect with the intended use.
 - I Used for pacemaker patients.
 - I Pacing Detection is on, the DS-101 displays pacemaker signals exactly as they are captured.

12 Lead ECG Electrode Placement

For 12 lead ECG, please place electrode as below graph

Symbol	Color	Electrode Site
R	Red	On the right infraclavicular fossa
L	Yellow	On the left infraclavicular fossa
F	Green	On the left midclavicular line, near the supracrestal line.
N	Black	On the right midclavicular line at the same height as F.
C	White	Chest Lead (C1 to C6)

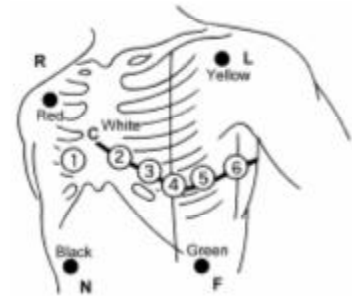

12 Lead ECG Measurement

Measurement value can be obtained by pressing the analysis button and measuring the 12L ECG for 10 seconds



1. Monitor the 12L ECG.
2. If you want to go back to Monitoring mode, Touch EXIT button.
3. Display monitoring condition with bottom area.
4. You can change the sensitivity by touch the Gain button
5. Touch ANALYZE key when ECG waveform stabilizes.
6. Measured value is displayed after taking in the waveform for 10 seconds

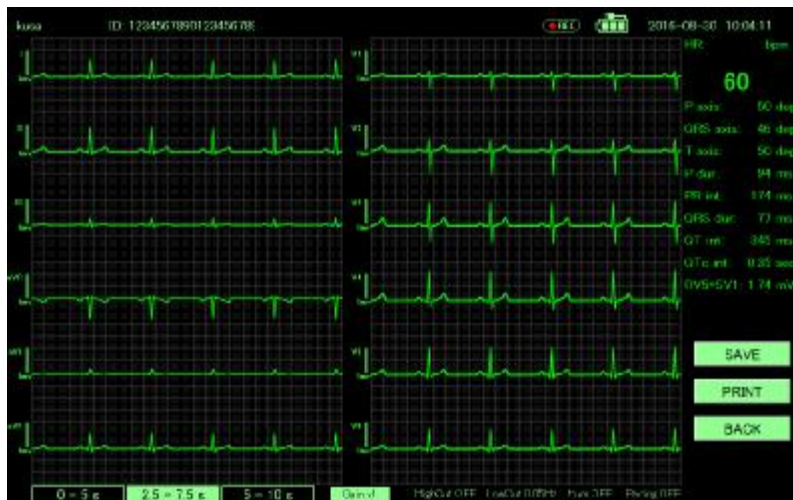

7. You can see 7 button
 - I SAVE: Save 12L ECG waveform with measurement value. Reviewable by List.
 - I PRINT: Print 12L ECG waveform with measurement value.
 - I BACJ: Go back to 12L ECG display mode.
 - I 0 – 5 s: Review 0 – 5sec waveform
 - I 2.5 – 7.5 s: Review 2.5 – 7.5sec waveform
 - I 5 – 10 s: Review 5 – 10sec waveform
 - I Gain: You can change the sensitivity, Touching x1(10mm/s) – x2(20mm/s) – x4(40mm/s) – x0.25(2.5mm/s) – x0.5(5mm/s) in turn
8. You can see the enlarged waveform by touching the waveform.

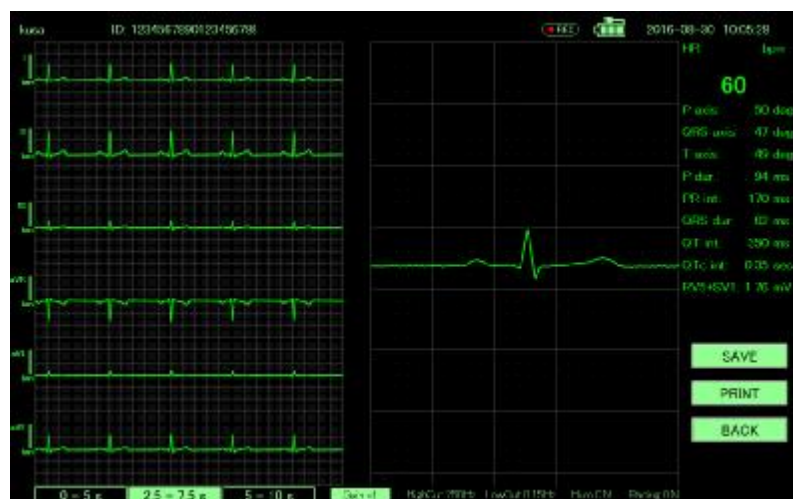

9. Print image is as follows.



12 Lead ECG Measurement Value

You can see 12 lead ECG measurement value are as follows.

HR, QRS axis, P dur, QRS dur, QTc int, P axis, T axis, PR int, QT int, RV5+SV1

Specification

Specification

DS-101 Specifications

Specification	DS-101
CPU	Intel® Celeron® processor N2807
Memory	On-board 2 GB 1333 MHz DDR3L
Boot-up Time	< 60 seconds
OS	Windows Embedded Standard 7
Storage	16 GB SSD mSATA module
OpenGL	Supported
Display	
Size	10.1" LCD display
Aspect Ratio	16:10
Resolution	1280 x 800
Interface	LVDS
Backlight	LED
Brightness (cd/m ²)	350 (Typ.)
Touch Panel	Projected capacitive touch panel
Alarm Noise	Sound pressure level over 60 dB(A)
Communication	
Wi-Fi	802.11a/b/g/n
Bluetooth	Bluetooth v4.0
NFC Reading Distance	Within 2 cm
I/O Interface, Button & Indicators	
USB Port	1 x USB 3.0 1 x USB 2.0
DC Power Output	Micro USB for 5V 2A with USB based define data transferring for USBBOX
DC Power Input	1 x 15 V DC-in power jack
Power Button	Yes
Power LED	Yes

Specification	DS-101
LED Light Bar	By embedded controller Green: heart beat Red/Yellow/Blue: alarm
Battery	
Battery Type	3S1P 103450 tap
Battery Contact	Wire
Battery Capacity	10.8 V, 2200 mAh
Battery Life	1 year
Minimum operation time	2 hour
Battery Charge time from depletion to 90%	About 2 hour
Power	
AC Adapter	60601 grade
DC-in Voltage & Current	Input: AC 100 V~240 V / 50-60Hz, 0.98A Output: DC 15 V, 2.4 A
Quick Charging	N/A, 0.3C
Power Consumption	PCBA: 7 W (typical) LCD: 3 W (typical) USB Box: 5 W (typical)
Regulation & Reliability	
Safety & EMC	IEC 60601-1, 60601-1-2, FCC Class B
Drop Survival	96 cm with package
Operating Temperature	0°C ~ 40°C (32°F ~ 95°F)
Storage Temperature	-10°C ~ 60°C (14°F ~ 140°F)
Transportation temperature	-10°C ~ 60°C (14°F ~ 140°F)
Operating Humidity	15% ~ 85% relative humidity
Storage Humidity	10% ~ 95% relative humidity
Transportation Humidity	10% ~ 95% relative humidity
IP Protection	IP 21
Expected Service Life	5 years
Others	
VESA Mount	75 mm x 75 mm
Dimensions (WxHxD)	287.24 mm x 207.23 mm x 24.00 mm

Specification	DS-101
---------------	--------

USB-BOX Specifications

Specification	HS-101
IO Board Model	USB-BOX-IOBD-R10
ECG Connector	ECG connector snap latch fixed socket, 14-pin, green
SpO2 Connector	Snap latch fixed socket, 6-pin, blue
NIBP Connector	Snap latch fixed socket, gray
Other Interface	USB 2.0 Micro-B plug
Defibrillator Protection	Yes
Operating Temperature	0°C ~ 40°C (32°F ~ 95°F)
Operating Humidity	15% ~ 85% relative humidity
Operating Altitude	Up to 3,000 m
Weight	157.5 g
Protection Level	IP 21

Dimensions

The physical dimensions of the DS-101 with stand are show bellow

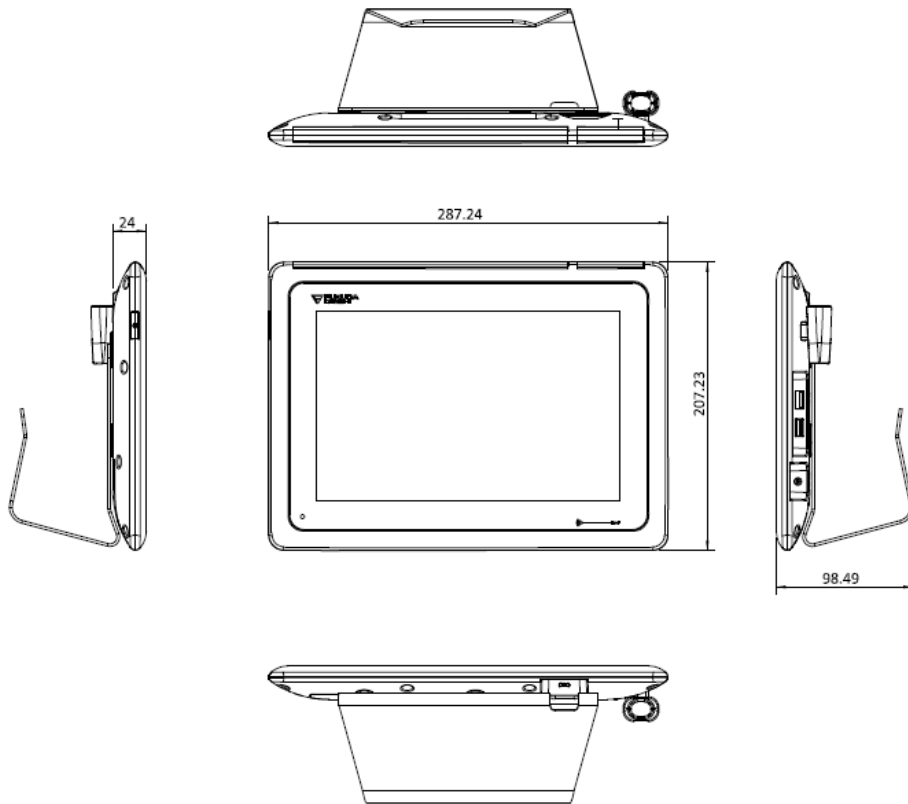

DS-101 Dimensions (Unit : mm)

The physical dimensions of the USB-BOX are show bellow.

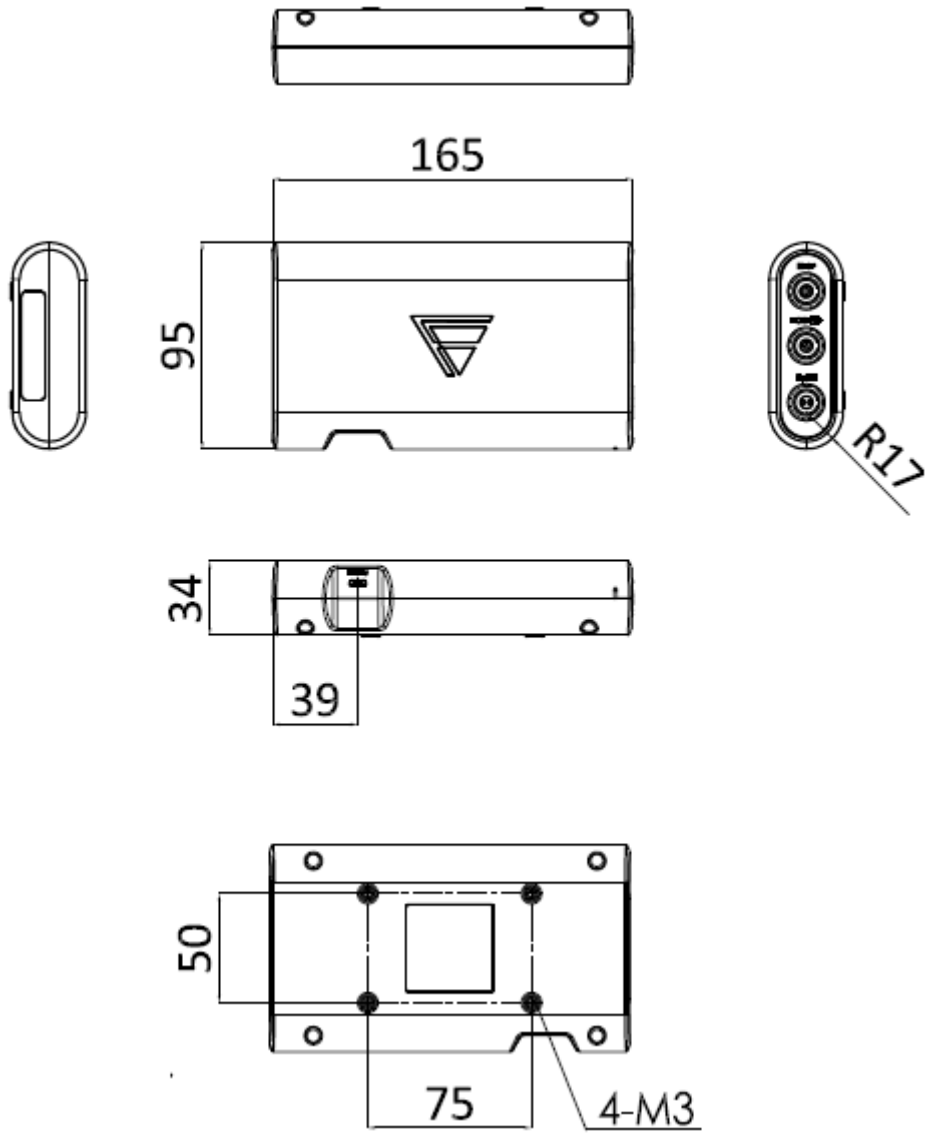

USB-BOX Dimensions (Unit : mm)

Standards and compliance

FCC warning



This equipment has been tested and found to comply with the limits for a Class B digital device, pursuant to Part 15 of the FCC Rules. These limits are designed to provide reasonable protection against harmful interference in a residential installation. This equipment generates, uses and can radiate radio frequency energy and, if not installed and used in accordance with the instructions, may cause harmful interference to radio communications. However, there is no guarantee that interference will not occur in a particular installation. If this equipment does cause harmful interference to radio or television reception, which can be determined by turning the equipment off and on, the user is encouraged to try to correct the interference by one or more of the following measures:

- I Reorient or relocate the receiving antenna.
- I Increase the separation between the equipment and receiver.
- I Connect the equipment into an outlet on a circuit different from that to which the receiver is connected.
- I Consult the dealer or an experienced radio/TV technician for help.

FCC Caution: Any changes or modifications not expressly approved by the party responsible for compliance could void the user's authority to operate this equipment.

This device and its antenna(s) must not be co-located or operating in conjunction with any other antenna or transmitter.

Safety

General Standard	EN 60601-1: 1990+A1: 1993+A2: 1995 (Medical Electrical Equipment – Part 1: General Requirement for Safety)
EMC Standard	EN 60601-1-2: 2007 (Medical electrical equipment - Part 1-2: General requirements for basic safety and essential performance Collateral standard: Electromagnetic compatibility – Requirements and tests)
Type of protection against electric shock	Class I Equipment (During AC power operation) Internally powered Equipment (During battery operation)
Degree of protection against electric shock	ECG/RESP: Type CF Applied Part SpO2, NIBP: Type BF Applied Part□
Operation Mode	Continuous Operating Equipment
The degree of protection against ingress of water	IP 21
Protection against Ignition of Flammable Gas	Not Provided

Performance

This section states the performance of this equipment.

Sound Pressure

Alarm	Maximum 83.0dB, Minimum 52.0dB
HR Synchronized Tone	Maximum 85.0dB, Minimum 32.0dB

ECG

Lead Type	Wired 3, 10-electrode
Frequency Characteristic	100Hz/40Hz/18Hz (3-electrode) 250Hz/150Hz/30Hz (10-electrode)
Input Impedance	2.5Mohm and above
Maximum Input Voltage	±5mV
Polarization Voltage	±300mV
Common Mode Rejection Ratio	90dB and above
HR Measurement Range	0, 20 to 300bpm
HR Measurement Accuracy	±1bpm
HR Display Response Time	Approx. 6 sec (12 Heartbeat average)
Waveform Size Selection	1/4 (10-electrode only), 1/2, 1, 2, 4 (1 means 10mm/1mV)
Seep Speed	25mm/sec
Auxiliary Output	Not Provided
Defibrillation Proof	Provided
Heart rate meter accuracy and response to irregular rhythm	80bpm Ventricular Bigeminy: 80bpm 60bpm Ventricular Bigeminy: 60bpm 120bpm Ventricular Bigeminy: 120bpm 90bpm Bidirectional Bigeminy: 90typ. (89-91) bpm
Response time of heart rate meter to change in heart rate	HR change from 80bpm to 120bpm: Range 7 to 9 sec., Average 8 sec HR change from 80bpm to 40bpm: Range 8 to 10 sec., Average 9 sec
Time to ALARM for tachycardia	Ventricular Tachycardia 1mVpp, 206bpm: Range 2 to 4 sec., Average 3 sec Ventricular Tachycardia 2mVpp, 206bpm: Range 2 to 4 sec., Average 3 sec Ventricular Tachycardia 0.5mVpp, 206bpm: Range 2 to 4 sec., Average 3 sec Ventricular Tachycardia 2mVpp, 195bpm: Range 2 to 4 sec., Average 3 sec Ventricular Tachycardia 4mVpp, 195bpm: Range 2 to 4 sec., Average 3 sec Ventricular Tachycardia 1mVpp, 195bpm: Range 2 to 4 sec., Average 3 sec
Tall T-wave Rejection Capability	1.2mV T-wave can be removed when tested according to IEC60601-2-27.
Transient Characteristic	3.2 sec, 0.3 sec, 0.1 sec (time constant can be changed)
Rejection of Pacemaker Pulse	a) Pacemaker Pulse without Over/Undershoot <input type="checkbox"/> Capable to reject pulses of pulse width 0.1 to 2ms, amplitude ±2mV b) Pacemaker Pulse with Over/Undershoot Rejection is not possible.

Respiration

Method	Impedance Method
Frequency Characteristic	1.5Hz
Current	100 μ A and below (at 64kHz \pm 5%)
Measurement Range	0, 4 to 150bpm
Measurement Accuracy	\pm 3rpm
Waveform Size Selection	1/5, 1/2, 1, 2, 4 (1 means 10mm/1 Ω)
Seep Speed	1.6mm/sec

SpO2 (Arterial Oxygen Saturation)

Measurement Method	2 Wavelength Pulse Wave Method Wavelength: Approx. 660nm (red light), Approx. 940nm (Infrared Light) Output: 15mW and below
Measurement Range	40 to 100%
Resolution	1%
Measurement Accuracy	Adult: \pm 3% when 70 to 100%
PR Measurement Range	20 to 250bpm
PR Accuracy	\pm 3bpm
Measurement Response Time	6 to 7 sec
Measurement Value Update Time	1 sec
Pulse Waveform Size Selection	Automatic
Pulse Waveform Seep Speed	25mm/sec

NIBP (Non-Invasive Blood Pressure)

Measurement Method	Oscillometric Method
Measurement Range	30 to 280mmHg/4 to 37.3kPa
Resolution	1mmHg
Static Pressure Accuracy	\pm 3mmHg/0.4kPa
BP Measurement Error according to the Clinical Performance Test	
Mean Error	Within \pm 5mmHg
Standard Deviation of Error	8mmHg or below
Error of Cuff Pressure Display	Within \pm 3mmHg
PR Measurement Range	40 to 240bpm
PR Accuracy	\pm 2% or \pm 2bpm (whichever greater)
Safety Mechanism	300mmHg or above

Electromagnetic Compatibility

The performance of this device under electromagnetic environment complies with EN 60601-1-2: 2007.

Precautions for Safe Operation under Electromagnetic Influence

If any sorts of electromagnetic wave, magnetic field, or static electricity exist around the device, noise interference or malfunction of the device may occur. If any unintended malfunction or noise occurs during monitoring, check the magnetic influence and take appropriate countermeasures.

The following are examples of the common cause and countermeasures.



WARNING Static Electricity

In a dry environment (room), static electricity is likely to occur. Take the following countermeasures.

- I Both operator and patient should remove any static electricity before entering the room.
- I Humidify the room.



WARNING Cellular Phone

- I The radio wave may cause malfunction to the device.
- I Cellular phones and radio sets should be turned off in the room (building) where medical device is located.



Caution Lightning

A lightning nearby may induce excessive voltage to the equipment. If any danger is suspected;

- I Use the uninterruptible power supply system.
- I Use the battery.



Caution High frequency noise interference from other device through the power outlet

- I Check where the noise is originated and remove it using filtering device, etc.
- I Stop using the device that is originating the noise.
- I Use other power outlet.

EMC Guidance

Essential Performance

- I Display function for ECG and SpO2 waveform and HR, SpO2 and NIBP numeric data
- I Alarm function
- I Accuracy of measured heart rate
- I Accuracy of measured SpO2
- I Accuracy of Measured NIBP

Conformity Criteria

<IEC60601-2-25> ECG-Electrocardiographs

- I ME EQUIPMENT may show temporary DEGRADATION during ESD discharges. Within 10 s the ME EQUIPMENT shall resume normal operation in the previous operating mode, without loss of any operator settings or stored data, and shall continue to perform its intended function and maintain ESSENTIAL PERFORMANCE.
- I When exposed to electrical fast transients and bursts, via the POWER SUPPLY CORD, the ME EQUIPMENT shall continue to perform its intended function as described in the particular standard. Testing of PATIENT CABLES and interconnecting cables specified to be more than 3m in length may show temporary DEGRADATION during exposure to fast transients and bursts. Within 10 s the ME EQUIPMENT shall resume normal operation in the previous operating mode, without loss of any operator settings or stored data, and shall continue to its intended function as described in the ACCOMPANYING DOCUMENTS. The ME EQUIPMENT shall comply with the requirements of 201.12.1.101.2 when the signal CAL20110 of Table GG.1 is applied.

<IEC60601-2-27> ECG / Heart Rate

- I ME EQUIPMENT shall comply with subclasses 6.2.1.10 of IEC60601-1-2:2007 and the accuracy of the detected heart rate shall be 60 ± 6 bpm.
- I ME EQUIPMENT may show temporary DEGRADATION during ESD discharges. Within 10 s the ME EQUIPMENT shall resume normal operation in the previous operating mode, without loss of any operator settings or stored data, and shall continue to perform its intended function and maintain ESSENTIAL PERFORMANCE.
- I When exposed to electrical fast transients and bursts, via the POWER SUPPLY CORD, the ME EQUIPMENT shall continue to display the heart rate. the accuracy of the detected heart rate shall be 60 ± 6 bpm. Testing of PATIENT CABLES and interconnecting cables specified to be more than 3m in length may show temporary degradation during exposure of fast transients and bursts. Within 10 s the ME EQUIPMENT shall resume normal operation in the previous operating mode, without loss of any operator settings or stored data, and shall continue to display the heart rate. The accuracy of the detected heart rate shall be 60 ± 6 bpm.
- I When exposed to a conducted radio frequency voltage, via the POWER SUPPLY CORD, the ME EQUIPMENT shall continue to display the heart rate. the accuracy of the detected heart rate shall be 60 ± 6 bpm. However, PATIENT CABLES are exempt from this requirement.

<IEC80601-2-30> NIBP

- I ME EQUIPMENT shall comply with subclasses 6.2.1.10 of IEC60601-1-2:2007 and the accuracy of the CUFF pressure shall be 180 ± 2 mmHg.

<IEC60601-2-49> Multifunction Monitor

- I ME EQUIPMENT may show temporary degradation during ESD discharges. Within 10 s the ME EQUIPMENT shall resume normal operation in the previous operating mode, without loss of any operator settings or stored data, and shall continue to perform its intended function as described in the ACCOMPANYNG DOCUMENTS.
- I When exposed to electrical fast transients and bursts(EFT/B), via the POWER SUPPLY CORD, the ME EQUIPMENT shall continue to perform its intended function as described in the DOCUMENTS. Testing of PATIENT CABLES, TRANCEDUCER cables and interconnecting cables specified to be more than 3m in length may show temporary DEGRADATION during exposure of fast transients and bursts. Within 10 s the ME EQUIPMENT shall resume normal operation in the previous operating mode, without loss of

any operator settings or stored data, and shall continue to perform its intended function as described in the ACCOMPANYING DOCUMENTS .

- I When exposed to a conducted radio frequency voltage, via the POWER SUPPLY CORD, the ME EQUIPMENT shall continue to perform its intended function and maintain ESSENTIAL PERFORMANCE..
- I PATIENT CABLES and TRANSDUCER cables are exempt from this requirement.

<ISO80601-2-61> SpO2

- I ME EQUIPMENT shall comply with subclasses 6.2.1.10 of IEC60601-1-2:2007 and shall continue to provide basic safety and essential performance.
- I No permanent degradation or unrecoverable loss of function, due to damage of ME EQUIPMENT or software, or loss of data shall be observed at any IMMUNITY TEST LEVEL.
- I Operation within the specified measurement accuracy limits (SpO2=90±5%, SpO2_PR=60 ±3bpm) or generation of a technical alarm condition.
- I In the event of disruption during IMMUNITY tests of IEC60601-1-2 6.2.2, 6.2.4, 6.2.5 and 6.2.7 may show temporary degradation. Within 30 s the ME EQUIPMENT shall resume normal operation in the previous operating mode, without loss of any operator settings or stored data, and shall continue to perform its intended function.

This equipment complies with EN 60601-1-2: 2007. However, if portable transmitter or wireless LAN equipment is used extremely nearby, the electromagnetic influence may largely exceed the compliance level and may cause unexpected phenomenon such as noise interference on the waveform, etc.

This equipment should be used in a location specified by each medical institution.

If any unexpected noise interference on the waveform or failure to the peripheral device occurs, stop using the equipment and follow the instruction of the technical engineer.

The following is the information relating to EMC (Electromagnetic Compatibility).

(When using this equipment, verify that it is used within the environment specified below.)

Compliance to the Electromagnetic Emissions

The DS-101 is intended for use in the electromagnetic environment specified below. The customer or the user of the DS-101 System should assure that it is used in such an environment.

Guidance and Manufacturer's Declaration – Electromagnetic Emissions		
Emission Test	Compliance	Electromagnetic Environment - Guidance
RF Emissions EN 55011	Group 1	The DS-101 uses RF energy only for its internal function. Therefore, its RF emissions are very low and are not likely to cause any interference in nearby electronic equipment
RF Emissions CISPR 11 Class B	Class B	The DS-101 System is suitable for use in all establishments other than domestic and those directly connected to the public low-voltage power supply network which supplies buildings used for domestic purposes.
Harmonic Emissions IEC 61000-3-2	Class A	
Voltage Fluctuations/ Flicker Emissions	Complies	

Compliance to the FCC

This device complies with Part 15 of the FCC Rules. Operation is subject to the following two conditions: (1) This device may not cause harmful interference, and (2) this device must accept any interference received, including interference that may cause undesired operation.

For product available in the USA/Canada market, only channel 1~11 can be operated. Selection of other channels is not possible.

This device is restricted to indoor use.

This equipment complies with FCC radiation exposure limits set forth for an uncontrolled environment. This equipment should be installed and operated with minimum distance 20cm between the radiator & your body.

This module is intended for OEM integrator only and limited to host with brand: Fukuda Denshi and model: DS-101. The OEM integrator is still responsible for the FCC compliance requirement of the end product, which integrates this module.

20cm minimum distance has to be able to be maintained between the antenna and the users for the host this module is integrated into. Under such configuration, the FCC radiation exposure limits set forth for an population/uncontrolled environment can be satisfied.

Any changes or modifications not expressly approved by the manufacturer could void the user's authority to operate this equipment.

Troubleshooting

General

Can't boot up and Power Light LED blanking Amber

Cause

System does not have enough battery capacity to boot up

Solution

Press power bottom after charge for 10min

The display is dark, or cannot be seen clearly

Cause

The service life of the LCD backlight has expired.

Solution

The backlight needs to be replaced. Contact our service representative.

The touch panel does not function properly.

Cause

A scratch on the touch panel surface or foreign object entering the touch panel junction is causing misdetection of the key area.

Solution

The touch panel needs to be replaced. Contact our service representative.

ECG

<LEAD OFF> is displayed

Cause 1

The electrode is detached, or is not making good electrical contact with the skin.

Solution

Check the electrode attachment.

Replace the electrodes.

Check if the lead cable or relay cable is defective (wire break, etc.).

Cause 2

High voltage (abnormal voltage) is detected

Solution

Check the electrode attachment.

Replace the electrodes.

Check if the lead cable or relay cable is defective (wire break, etc.).

Cause 3

Low voltage (abnormal voltage) is detected

Solution

Check the electrode attachment.
Replace the electrodes.
Check if the lead cable or relay cable is defective (wire break, etc.).

The ECG waveform is displayed in baseline

Cause 1

Electrode is detached.

Solution

Reattach the electrode. If the electrode contact is poor, replace the electrode.

Cause 2

The lead cable is disconnected from the electrode terminal.

Solution

Securely connect the lead cable.

Respiration

"0" is displayed for respiration rate

Cause

The amplitude of the respiration waveform is too low.

Solution

Change the electrode site, or select a lead with higher QRS amplitude.

SpO2 Measurement

The pulse waveform is not displayed, or interrupted

Cause 1

The amplitude of the pulse waveform is too low, or the sensor is not positioned correctly.

Solution

Check that the light emitting and receiving parts of the sensor LED are aligned.

Cause 2

The sensor is defective.

Solution

Replace the sensor.

Cause 3

SpO2 sensor is not firmly connected to the connector.

Solution

Make sure the SpO2 sensor is firmly connected.

Cause 4

Sensor is exposed to light.

Solution

Place a black or dark cloth over the sensor to avoid direct sunlight. When not using the sensor for measurement, avoid placing the sensor in light or unplug the sensor from the connector.

SpO2 value is unstable

Cause 1

There is excessive body motion from the patient which disables correct measurement.

Solution 1

Have the patient lie still.

Solution 2

Relocate the sensor, or change the sensor to which the body motion will have less influence.

Cause 2

Sensor is exposed to light.

Solution

Place a black or dark cloth over the sensor to avoid direct sunlight.

Non-Invasive Blood Pressure

The cuff is not inflated although the pump is operating.

Cause 1

The air hose is not firmly connected, and the air is leaking.

Solution

Check if the air hose is properly connected.

Cause 2

The cuff size does not match the selected patient type.

Solution

Use the cuff with correct size for the selected patient type.

The pump is not operating.

Cause

The air hose is disconnected from the NIBP Connector.

Solution

Check if the air hose is properly connected.

The measurement data is displayed as "---"

Cause 1

The measurement accuracy is not reliable due to body motion artifact.

Solution

During the measurement, have the patient stay still.

Cause 2

The pulse is too small to acquire reliable measurement accuracy.

Solution

Check if the cuff is properly attached to the patient, or cuff size is correct.

Cause 3

The air hose is disconnected.

Solution

Check if the air hose is tightly connected, and then measure again. If the same message is displayed again, air may be internally leaked.

Contact our service representative.

Temperature

No value display on the screen

Cause 1

Data is not transferring successfully

Solution

Please contact with PC directly with close enough distance and place in the correct location

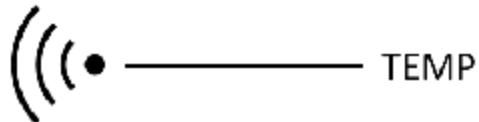

Cause 2

Thermometer value has been read once

Solution

Please measure and read the value again.

Version History
