



IEI Technology Corp.



MODEL:  
**AVL-2000PLUS**

**Auto Data Server with Intel® Atom™ CPU,  
Gigabit Ethernet, OBD-II, USB, GPS, Wi-Fi, Bluetooth,  
Video Capture, Audio, RS-232/422/485, RoHS Compliant**

# User Manual

Rev. 1.00 – 28 June, 2011



# Revision

---

Date	Version	Changes
28 June, 2011	1.00	Initial release

# Copyright

---

## **COPYRIGHT NOTICE**

The information in this document is subject to change without prior notice in order to improve reliability, design and function and does not represent a commitment on the part of the manufacturer.

In no event will the manufacturer be liable for direct, indirect, special, incidental, or consequential damages arising out of the use or inability to use the product or documentation, even if advised of the possibility of such damages.

This document contains proprietary information protected by copyright. All rights are reserved. No part of this manual may be reproduced by any mechanical, electronic, or other means in any form without prior written permission of the manufacturer.

## **TRADEMARKS**

All registered trademarks and product names mentioned herein are used for identification purposes only and may be trademarks and/or registered trademarks of their respective owners.

# Table of Contents

<b>1 INTRODUCTION.....</b>	<b>8</b>
1.1 OVERVIEW.....	9
1.2 FEATURES.....	9
1.3 FRONT PANEL.....	10
1.3.1 LED Indicators.....	11
1.4 REAR PANEL.....	11
1.5 RIGHT PANEL.....	12
1.6 LEFT PANEL.....	12
1.7 SYSTEM SPECIFICATIONS.....	13
1.8 DIMENSIONS.....	15
<b>2 UNPACKING .....</b>	<b>16</b>
<b>3 INSTALLATION .....</b>	<b>20</b>
3.1 ANTI-STATIC PRECAUTIONS.....	21
3.2 INSTALLATION PRECAUTIONS.....	21
3.3 INSTALLATION AND CONFIGURATION STEPS.....	22
3.4 SIM CARD AND SD CARD INSTALLATION.....	22
3.5 MOUNTING THE SYSTEM.....	23
3.6 I/O INTERFACE CONNECTORS.....	24
3.6.1 CAN Bus Connection.....	24
3.6.2 Digital I/O Connection.....	24
3.6.3 LAN Connection.....	25
3.6.4 OBD-II Connector.....	26
3.6.5 Power Input Connection.....	27
3.6.6 Remote Control Connection.....	28
3.6.7 Serial Device Connection.....	28
3.6.7.1 COM1 Pinouts.....	29
3.6.8 USB Device Connection.....	30
3.6.9 Video Capture Connection.....	30
3.6.10 VGA Monitor Connection.....	31



## AVL-2000PLUS Auto Data Server

3.7 POWER-ON PROCEDURE.....	錯誤! 尚未定義書籤。
3.7.1 Installation Checklist.....	錯誤! 尚未定義書籤。
3.7.2 Power-on Procedure .....	錯誤! 尚未定義書籤。
3.7.3 Power State .....	錯誤! 尚未定義書籤。
3.8 SYSTEM MAINTENANCE .....	32

# List of Figures

Figure 1-1: AVL-2000PLUS Auto Data Server .....	9
Figure 1-2: Front Panel .....	10
Figure 1-3: LED Indicators .....	11
Figure 1-4: Rear View .....	11
Figure 1-5: Right Panel .....	12
Figure 1-6: Left Panel .....	12
Figure 1-7: Dimensions (unit: mm) .....	15
Figure 3-1: Panel Retention Screw .....	22
Figure 3-2: Slot Locations .....	23
Figure 3-3: VESA Mounting Bracket .....	23
Figure 3-4: CAN Bus Connector Pinouts .....	24
Figure 3-5: Digital I/O Connector Pinouts Location .....	24
Figure 3-6: LAN Connection .....	25
Figure 3-7: OBD-II Cable and J1939/FMS Cable .....	26
Figure 3-8: OBD-II Connector Pinouts Location .....	26
Figure 3-9: OBD-II Connector Pinouts .....	27
Figure 3-10: J1939/FMS Connector Pinouts .....	27
Figure 3-11: Power Input Connector .....	27
Figure 3-12: Power Cable .....	錯誤! 尚未定義書籤。
Figure 3-13: Remote Control Connector Pinouts Location .....	28
Figure 3-14: Serial Device Connector .....	29
Figure 3-15: USB Device Connection .....	30
Figure 3-16: Video Capture Cable .....	31
Figure 3-17: Video Connector Pinouts Location .....	31
Figure 3-18: VGA Connector .....	32

# List of Tables

---

Table 1-1: Technical Specifications.....	14
Table 2-1: Packing List.....	18
Table 2-2: Optional Items .....	18
Table 3-1: Digital I/O Connector Pinouts .....	25
Table 3-2: OBD-II Connector Pinouts .....	26
Table 3-3: Remote Control Connector Pinouts .....	28
Table 3-4: COM1 Connector Pinouts .....	29
Table 3-5: Video Connector Pinouts.....	31



Chapter

1

# Introduction

---



## AVL-2000PLUS Auto Data Server

### 1.1 Overview



**Figure 1-1: AVL-2000PLUS Auto Data Server**

The AVL-2000PLUS is an embedded system for indoor only.

At the heart of the system is the Intel® Atom™ processor, offering low power in a powerful package. The chipset is rounded off with the Intel® US15WP.

The system also offers HSUPA/GPRS/GSM connection, Global Position System (GPS) and On-Board Diagnostic System (OBD) technology. Other peripherals include two USB ports, an RS-232/422/485 port, one GbE port, video capture port and audio line-in and line-out jacks. Wireless networking capabilities include Bluetooth 2.0 and 802.11 b/g.

### 1.2 Features

There are four models in the AVL-2000PLUS. Both models feature the following:

- Fanless system with 1.1GHz Intel® Atom™ Z510 CPU
- Pre-installed 1 GB 533 MHz DDR2 memory
- Supports Windows XP, Windows 7 Embedded
- Pre-installed 4 GB CF card for OS
- SD card slot for data storage
- VGA output port and NTSC/PAL video capture (120FPS@DI)
- Network connectivity via HSDPA/GPRS/GSM, Wi-Fi and Bluetooth
- RS-232/422/485 serial port (RJ-45 interface)
- 10/100/1000 Mbps Ethernet
- Digital input/output supported
- DIN rail mount support
- Two USB ports
- Audio line-in and line-out

- GPS system
- Optional UHF RFID reader module
- Supports OBD-II/FMS/J1939
- RoHS compliance

### 1.3 Front Panel

The following are found on the front panel.

- 1 x VGA connector
- 1 x Video capture connector
- 1 x RS-232/422/485 connector (RJ-45)
- 2 x USB ports
- 1 x Gigabit Ethernet RJ-45 port
- 1 x DB-9 connector (connects to OBD-II with included cable)
- 1 x CAN connector
- 1 x Audio line-in jack
- 1 x Audio line-out jack
- 1 x Power button
- 1 x GPS antenna connector
- 1 x 2.5G/3G/3.5G antenna connector
- 1 x Wi-Fi/Bluetooth antenna connector
- 4 x UHF RFID antenna connectors

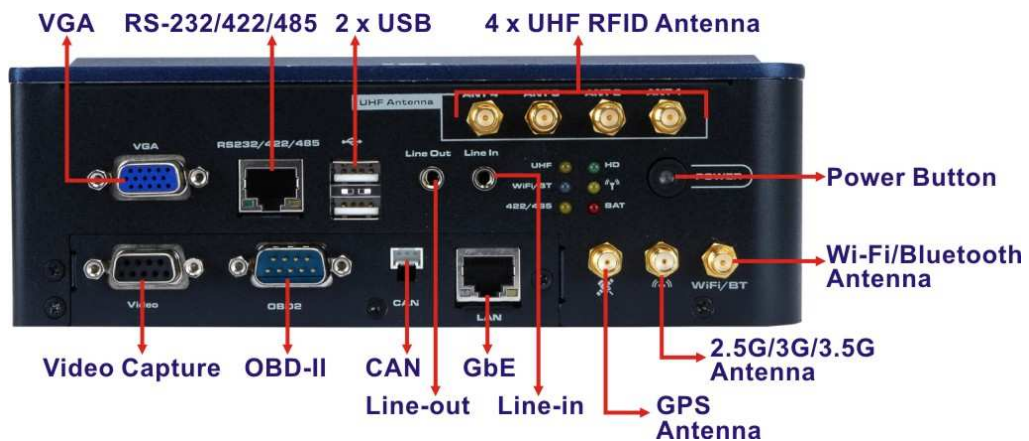

**Figure 1-2: Front Panel**

## AVL-2000PLUS Auto Data Server

### 1.3.1 LED Indicators

The LED indicators on the front panel show the status of UHF RFID, Wi-Fi/Bluetooth, RS-422/485, GPRS/HSUPA connection as well as CF card and battery activity.



Figure 1-3: LED Indicators

### 1.4 Rear Panel

The rear panel has VESA mounting screw holes for DIN rail mounting.

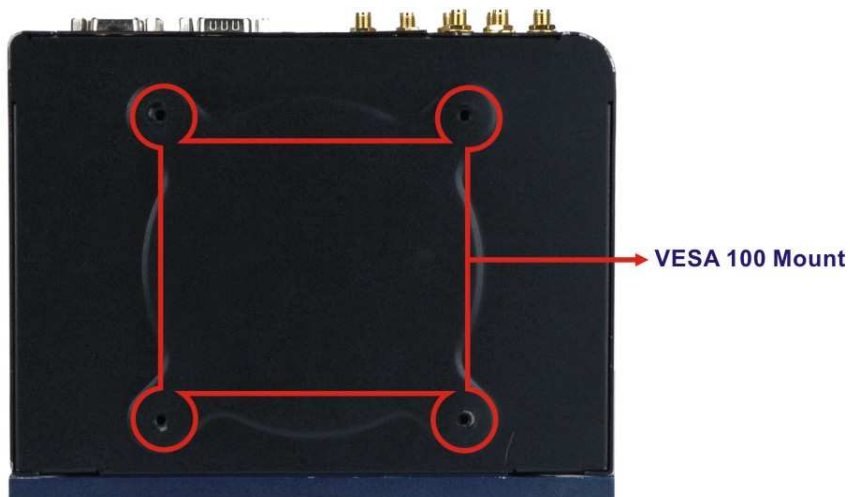

Figure 1-4: Rear View



### 1.5 Right Panel

The right panel has one remote control connector, one digital I/O connector and one 12 V DC power connector. The ACC/DC power switch is also located on the right panel.



Figure 1-5: Right Panel

### 1.6 Left Panel

The left panel provide access to the SD card slot, SIM card slot and CF card slot. These slots are protected by a cover. After inset the SD card slot, SIM card slot or CF card shell be closed the cover with screw before operation.

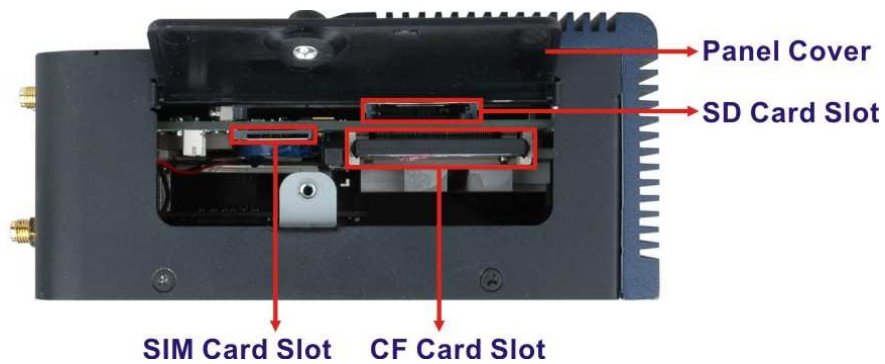

Figure 1-6: Left Panel

## AVL-2000PLUS Auto Data Server

### 1.7 System Specifications

The technical specifications for the AVL-2000PLUS systems are listed in **Table 1-1**.

System	
<b>CPU</b>	1.1 GHz Intel® Atom™ Z510
<b>Chipset</b>	Intel® US15WP
<b>Memory</b>	One 1.0 GB 533 MHz DDR2 pre-installed
<b>OS</b>	Windows 7 Embedded
<b>Storage</b>	1 x 4 GB CompactFlash® card (500x) preinstalled 1 x SD card slot
<b>Audio</b>	Realtek ALC888
<b>Digital I/O</b>	4 inputs / 4 outputs
Communication	
<b>LAN</b>	1 x 10/100/1000 Mbps RJ-45
<b>Wireless LAN</b>	802.11b/g
<b>Bluetooth</b>	Bluetooth 2.0 + EDR Class 1
<b>Data Rate</b>	WCDMA/HSUPA
<b>GPS</b>	Support GPS
Data Collection	
<b>RFID</b>	Optional ISO 18000-6C UHF RFID <b>operation frequency 915MHz Only</b>
<b>Video Capture</b>	Video input: 4-channel composite video (NTSC/PAL/SECAM) Frame rate: four channels with 120fps@D1 per channel (NTSC), four channels with 100fps@D1 per channel (PAL/SECAM)
Power	
<b>Power Input</b>	9~30 V DC input
Physical Character	
<b>Mounting</b>	DIN rail mount (VESA 100 mm x 100 mm)
<b>Dimensions (W x D x H)</b>	200 mm x 155 mm x 70 mm
<b>Operation Temperature</b>	-20°C ~ 40°C
<b>Storage Temperature</b>	-30°C ~ 80°C
<b>Humidity</b>	5% ~ 95% non-condense
<b>Net weight</b>	1.978 kg
<b>Safety</b>	CE, FCC, CCC, E-MARK



<b>Connectors and Buttons</b>	
<b>Antenna Connectors</b>	1 x GPS antenna connector 1 x 2.5G/3G/3.5G antenna connector 1 x Wi-Fi/Bluetooth antenna connector 4 x UHF RFID antenna connectors
<b>I/O Ports and Switches</b>	1 x Power connector 1 x VGA connector 1 x Video capture connector 1 x RS-232/422/485 connector (RJ-45) 2 x USB ports 1 x Gigabit Ethernet RJ-45 port 1 x DB-9 connector (connects to OBD-II with included cable) 1 x CAN connector 1 x Audio line-in jack 1 x Audio line-out jack 1 x Digital I/O connector
<b>Button and Switch</b>	1 x Power button 1 x ACC/DC switch

**Table 1-1: Technical Specifications**

AVL-2000PLUS Auto Data Server

1.8 Dimensions

The dimensions are shown below.

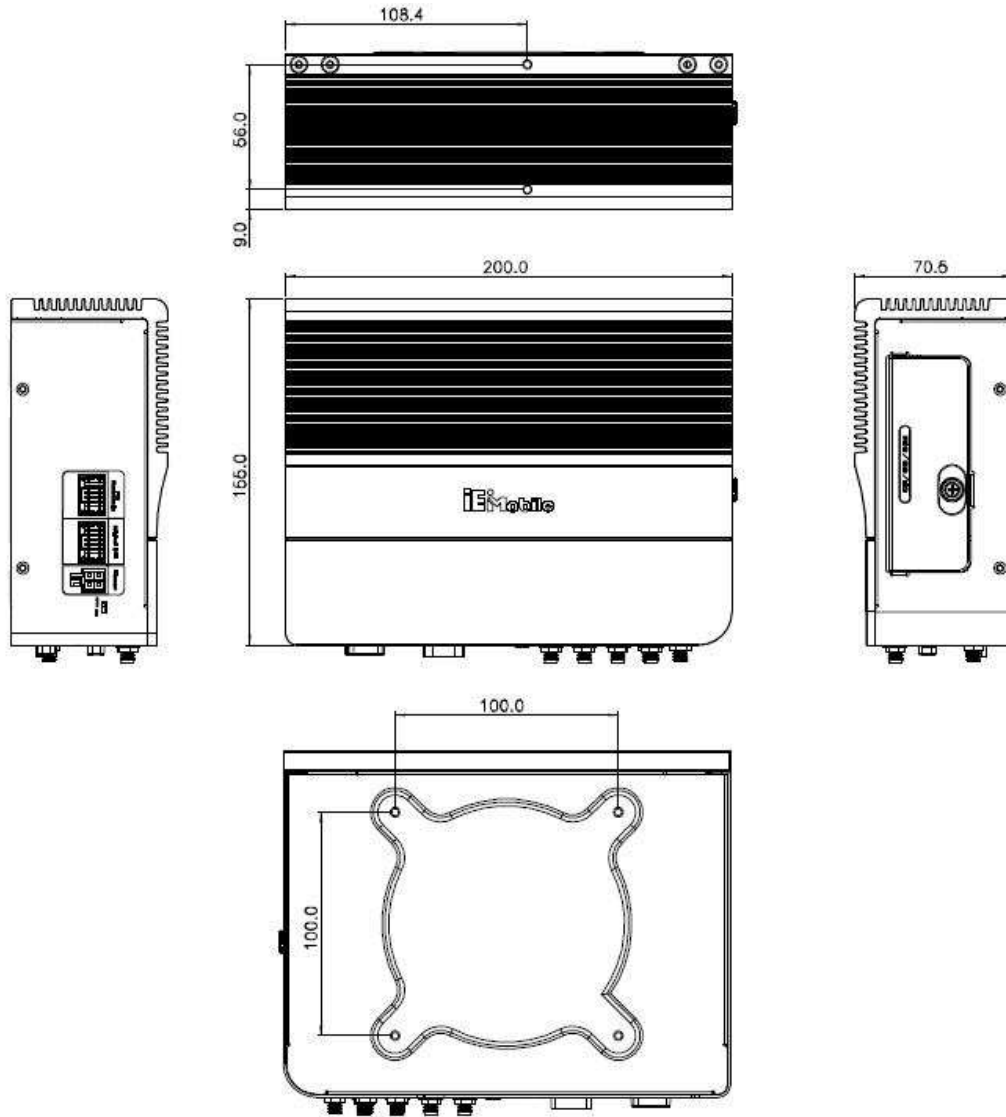

Figure 1-7: Dimensions (unit: mm)



Chapter

2

# Unpacking



---

## AVL-2000PLUS Auto Data Server

To unpack the AVL-2000PLUS, follow the steps below:

- Step 1:** Use box cutters, a knife or a sharp pair of scissors that seals the top side of the external (second) box.
- Step 2:** Open the external (second) box.
- Step 3:** Use box cutters, a knife or a sharp pair of scissors that seals the top side of the internal (first) box.
- Step 4:** Lift the monitor out of the boxes.
- Step 5:** Remove both polystyrene ends, one from each side.
- Step 6:** Pull the plastic cover off the AVL-2000PLUS.
- Step 7:** Make sure all the components listed in the packing list are present.

The AVL-2000PLUS is shipped with the following components:

Quantity	Item	Image
1	AVL-2000PLUS	
1	RS-232 cable (P/N: 32005-000200-200-RS)	
1	Capture cable (P/N: 32007-001400-100-RS)	

Quantity	Item	Image
1	GPS/GSM antenna (P/N: 32506-000100-100-RS)	
1	Wi-Fi/Bluetooth antenna (P/N: 32505-000400-100-RS)	
1	OBD-II cable (P/N: 32025-000300-100-RS)	
1	J1939/FMS cable (P/N: 32025-000400-100-RS)	
1	User manual CD and driver CD	

**Table 2-1: Packing List**

Item	Image
UHF RFID antenna with cable	

**Table 2-2: Optional Items**



## AVL-2000PLUS Auto Data Server

If any of these items are missing or damaged, contact the distributor or sales representative immediately.



Chapter

3

# Installation

---

### 3.1 Anti-static Precautions



**WARNING:**

Failure to take ESD precautions during the maintenance of the AVL-2000PLUS may result in permanent damage to the AVL-2000PLUS and severe injury to the user.

Electrostatic discharge (ESD) can cause serious damage to electronic components, including the AVL-2000PLUS. Dry climates are especially susceptible to ESD. It is therefore critical that whenever the AVL-2000PLUS is accessed internally, or any other electrical component is handled, the following anti-static precautions are strictly adhered to.

- **Wear an anti-static wristband:** - Wearing a simple anti-static wristband can help to prevent ESD from damaging the board.
- **Self-grounding:** - Before handling the board touch any grounded conducting material. During the time the board is handled, frequently touch any conducting materials that are connected to the ground.
- **Use an anti-static pad:** - When configuring the AVL-2000PLUS, place it on an anti-static pad. This reduces the possibility of ESD damaging the AVL-2000PLUS.
- **Only handle the edges of the PCB:** - When handling the PCB, hold the PCB by the edges.

### 3.2 Installation Precautions

When installing the AVL-2000PLUS, please follow the precautions listed below:

- **Power turned off:** When installing the AVL-2000PLUS, make sure the power is off. Failing to turn off the power may cause severe injury to the body and/or damage to the system.
- **Certified Engineers:** Only certified engineers should install and modify onboard functionalities.

- **Anti-static Discharge:** If a user opens the bottom panel of the AVL-2000PLUS, to configure the jumpers or plug in added peripheral devices, ground themselves first and wear an anti-static wristband.

### 3.3 Installation and Configuration Steps

The following installation steps must be followed.

- Step 1:** Unpack the system
- Step 2:** Install a SIM card or SD card (optional)
- Step 3:** Connect peripheral devices
- Step 4:** Mount the system
- Step 5:** Power up the system

### 3.4 SIM Card and SD Card Installation

To install a SIM card or a SD card, the cover plate must be removed. To remove the cover plate and install the SIM card or the SD card, follow the instructions below.

- Step 1:** Remove the retention screw and lift the cover.



Figure 3-1: Panel Retention Screw

## AVL-2000PLUS Auto Data Server

**Step 2:** Locate the SIM card slot or SD card slot. See **Figure 3-2**.

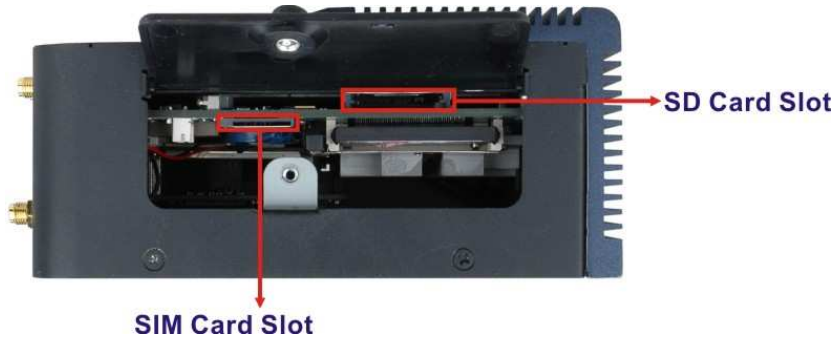

**Figure 3-2: Slot Locations**

**Step 3:** Insert the card into the correspondent slot.

### 3.5 Mounting the System

To mount the system onto a VESA bracket, please follow the steps below.

**Step 1:** Attach the VESA mounting bracket to the bottom panel of the AVL-2000PLUS. Secure the bracket to the AVL-2000PLUS with the supplied retention screws (Figure 3-3).

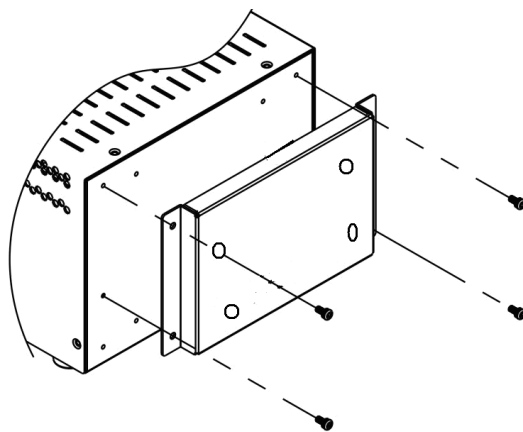

**Figure 3-3: VESA Mounting Bracket**



### 3.6 I/O Interface Connectors

This section provides an overview of the I/O interface connectors of the AVL-2000PLUS.

#### 3.6.1 CAN Bus Connection

There is one 3-pin CAN Bus connector. The connector pinouts are shown in

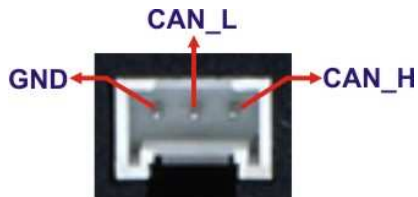

**Figure 3-4: CAN Bus Connector Pinouts**

#### 3.6.2 Digital I/O Connection

The AVL-2000PLUS right side panel has one 14-pin wafer connector for digital I/O connection. The pinouts for digital I/O connector are listed in the table below.

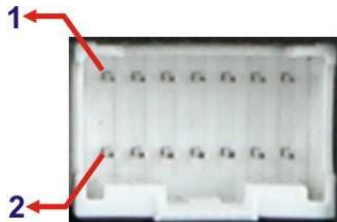

**Figure 3-5: Digital I/O Connector Pinouts Location**

PIN NO.	DESCRIPTION	PIN NO.	DESCRIPTION
1	ISO_GND	2	ISO_5V
3	GPI0_ISO	4	GPI1_ISO
5	GPI2_ISO	6	GPI3_ISO
7	GPO0_ISO	8	GPO1_ISO
9	GPO2_ISO#	10	GPO3_ISO
11	GND	12	VCC5

## AVL-2000PLUS Auto Data Server

13	SPEED_IN+	14	SPEED_IN-
----	-----------	----	-----------

**Table 3-1: Digital I/O Connector Pinouts**

### 3.6.3 LAN Connection

There is one external RJ-45 LAN connector. The RJ-45 connector enables connection to an external network. To connect a LAN cable with an RJ-45 connector, please follow the instructions below.

- Step 1:** Locate the RJ-45 connectors on the bottom panel of the AVL-2000PLUS.
- Step 2:** Align the connectors. Align the RJ-45 connector on the LAN cable with one of the RJ-45 connectors on the bottom panel of the AVL-2000PLUS.

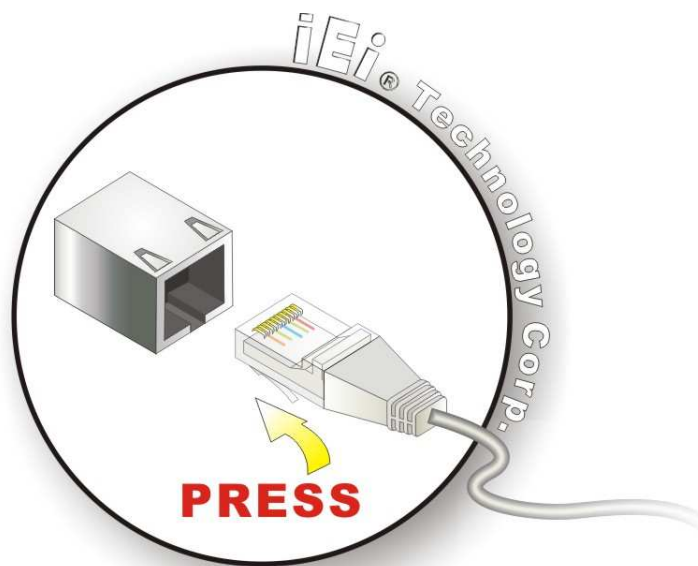

**Figure 3-6: LAN Connection**

- Step 3:** Insert the LAN cable RJ-45 connector. Once aligned, gently insert the LAN cable RJ-45 connector into the onboard RJ-45 connector.

### 3.6.4 OBD-II Connector

The AVL-2000PLUS has one DB-9 male connector for OBD-II connection. Use the OBD-II cable or J1939/FMS cable (Figure 3-7) in the package to connect the AVL-2000PLUS.

#### OBD-II Cable



#### J1939/FMS Cable



**Figure 3-7: OBD-II Cable and J1939/FMS Cable**

The pinouts for OBD-II connector are listed in the table below.

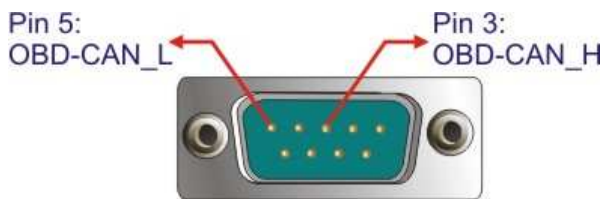

**Figure 3-8: OBD-II Connector Pinouts Location**

Pin	Description
1	NC
2	NC
3	OBD-CAN_H
4	ISO-9141-2-K
5	OBD-CAN_L
6	J1850-
7	J1850+
8	ISO-9141-2-L
9	NC

**Table 3-2: OBD-II Connector Pinouts**

AVL-2000PLUS Auto Data Server

The pinout locations of OBD-II cable connector and J1939/FMS cable connector are shown below.

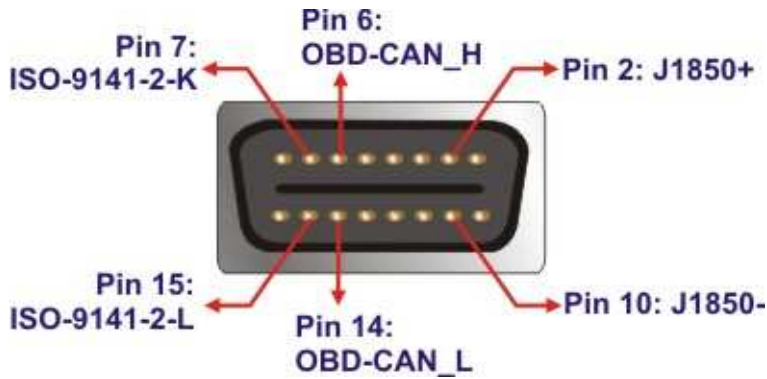

Figure 3-9: OBD-II Connector Pinouts

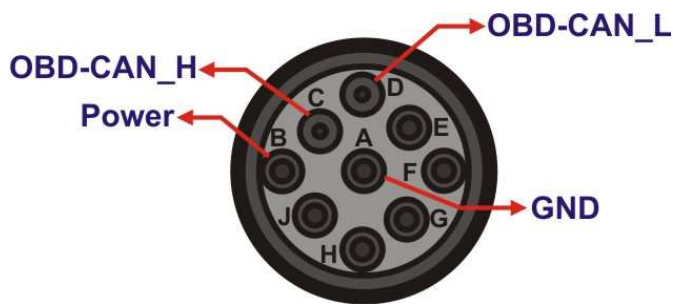

Figure 3-10: J1939/FMS Connector Pinouts

### 3.6.5 Power Input Connection

The AVL-2000PLUS has one 12 V DC input connector on the right panel.

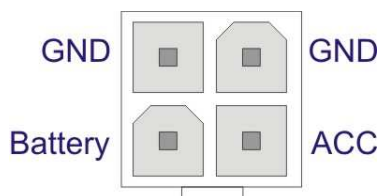
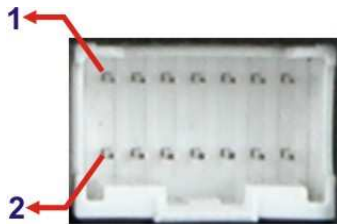

Figure 3-11: Power Input Connector



### 3.6.6 Remote Control Connection

The AVL-2000PLUS right side panel has one 14-pin wafer connector for the optional remote control connection. The pinouts for remote control connector are listed in the table below.



**Figure 3-12: Remote Control Connector Pinouts Location**

PIN NO.	DESCRIPTION	PIN NO.	DESCRIPTION
1	PWR_BTN	2	GND
3	FU1	4	GND
5	FU2	6	GND
7	FU3	8	GND
9	PW_BAT_LED#	10	GND
11	HDD_LED	12	3.5G_LED
13	BT_LED	14	WIFI_LED

**Table 3-3: Remote Control Connector Pinouts**

### 3.6.7 Serial Device Connection

The AVL-2000PLUS has one male RJ-45 connector on the bottom panel for serial devices to be connected. Follow the steps below to connect a serial device to the AVL-2000PLUS.

**Step 1: Locate the RJ-45 connector.** The location of the RJ-45 serial port connector is shown in **Chapter 1**. The RJ-45 connectors for the serial ports can be identified easily as the RJ-45 for the network has two LEDs on the port, while the connectors for the serial cables don't.

**Step 2: Insert the RJ-45 to DB-9 cable.**

## AVL-2000PLUS Auto Data Server

**Step 3: Insert the serial connector.** Insert the DB-9 connector of a serial device into the DB-9 connector on the cable. See **Figure 3-13**.

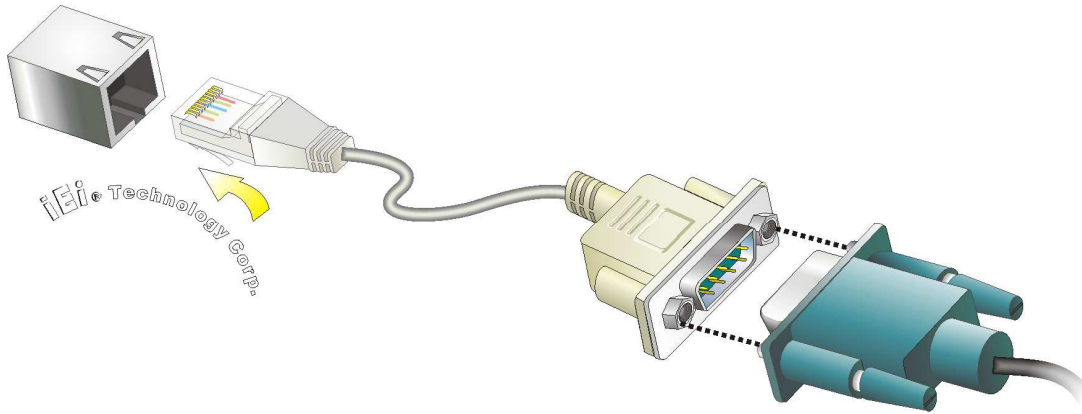

**Figure 3-13: Serial Device Connector**

**Step 4: Secure the connector.** Secure the serial device connector to the external interface by tightening the two retention screws on either side of the connector.

### 3.6.7.1 COM1 Pinouts

The COM1 connector can be set as RS-232 (default), RS-422 or RS-485 in BIOS. The pinouts for COM1 are listed in the table below.

Pin	RS-232	RS-422	RS-485
1	NRI1		
2	NDTR1		
3	NCTS1		
4	NTX1	TX-	DATA-
5	NRTS1	TX+	DATA+
6	NRX1	RX+	
7	NDSR1		
8	NDCD1	RX-	
9	GND	GND	GND

**Table 3-4: COM1 Connector Pinouts**

### 3.6.8 USB Device Connection

There are two external USB connectors. To connect a USB device, please follow the instructions below.

**Step 1: Located the USB connectors.** The locations of the USB connectors are shown in **Chapter 2**.

**Step 2: Align the connectors.** Align the USB device connector with one of the connectors on the bottom panel.

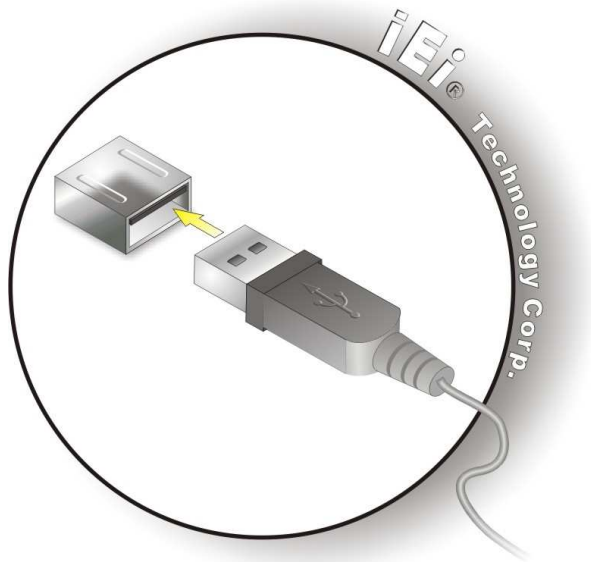

**Figure 3-14: USB Device Connection**

**Step 3: Insert the device connector.** Once aligned, gently insert the USB device connector into the onboard connector.

### 3.6.9 Video Capture Connection

The AVL-2000PLUS has one DB-9 female connector for video capture connection. Use the video cable (**Figure 3-7**) in the package to connect the AVL-2000PLUS with the device.

## AVL-2000PLUS Auto Data Server



**Figure 3-15: Video Capture Cable**

The pinouts for video connector are listed in the table below.

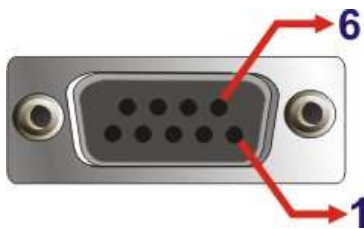

**Figure 3-16: Video Connector Pinouts Location**

Pin	Description
1	CN1_A
2	CN1_B
3	CN1_C
4	CN1_D
5	SIN1_A
6	GND
7	GND
8	GND
9	GND

**Table 3-5: Video Connector Pinouts**

### 3.6.10 VGA Monitor Connection

The AVL-2000PLUS has a single female DB-15 connector on the external peripheral interface panel. The DB-15 connector is connected to a CRT or VGA monitor. To connect a monitor to the AVL-2000PLUS, please follow the instructions below.



- Step 1: Locate the female DB-15 connector.** The location of the female DB-15 connector is shown in **Chapter 3**.
- Step 2: Align the VGA connector.** Align the male DB-15 connector on the VGA screen cable with the female DB-15 connector on the external peripheral interface.
- Step 3: Insert the VGA connector** Once the connectors are properly aligned with the insert the male connector from the VGA screen into the female connector on the AVL-2000PLUS. See Figure 3-17.

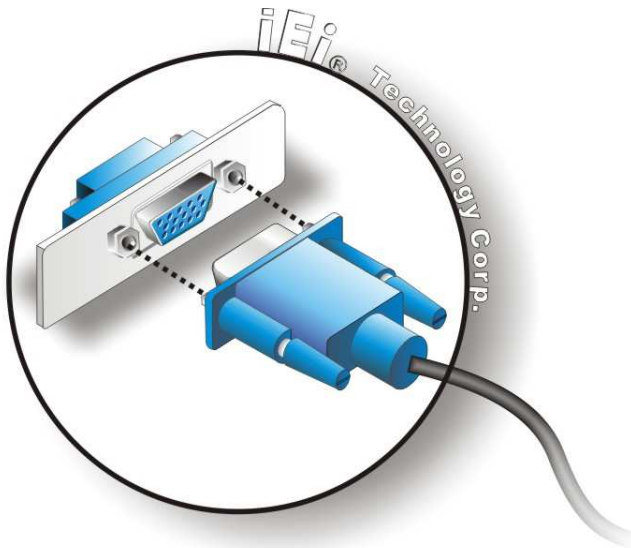

**Figure 3-17: VGA Connector**

- Step 4: Secure the connector.** Secure the DB-15 VGA connector from the VGA monitor to the external interface by tightening the two retention screws on either side of the connector.

### 3.7 System Maintenance

If the components of the AVL-2000PLUS fail, they must be replaced. Please contact the system reseller or vendor to purchase the replacement parts.



**NOTE:**

A user cannot replace a motherboard. If the motherboard fails it must be shipped back to IEI to be replaced. Please contact the system vendor, reseller or an IEI sales person directly.

**Federal Communication Commission Interference Statement**

This equipment has been tested and found to comply with the limits for a Class B digital device, pursuant to Part 15 of the FCC Rules. These limits are designed to provide reasonable protection against harmful interference in a residential installation. This equipment generates, uses and can radiate radio frequency energy and, if not installed and used in accordance with the instructions, may cause harmful interference to radio communications. However, there is no guarantee that interference will not occur in a particular installation. If this equipment does cause harmful interference to radio or television reception, which can be determined by turning the equipment off and on, the user is encouraged to try to correct the interference by one of the following measures:

- Reorient or relocate the receiving antenna.
- Increase the separation between the equipment and receiver.
- Connect the equipment into an outlet on a circuit different from that to which the receiver is connected.
- Consult the dealer or an experienced radio/TV technician for help.

FCC Caution: Any changes or modifications not expressly approved by the party responsible for compliance could void the user's authority to operate this equipment.

This device complies with Part 15 of the FCC Rules. Operation is subject to the following two conditions: (1) This device may not cause harmful interference, and (2) this device must accept any interference received, including interference that may cause undesired operation.

**Radiation Exposure Statement:**

This equipment complies with FCC radiation exposure limits set forth for an uncontrolled environment. This equipment should be installed and operated with minimum distance 20cm between the radiator & your body.