



Disk ON-Line Server

ICP Electronics Inc.

NAS-104R . NAS-2108R . NAS-2108RW . NAS-101R . NAS-101RW

User's Manual

FCC ID : RFHNAS-101RW (Only for NAS-101RW)

BROADBAND NETWORK ATTACHED STORAGE

Disk On-line Server User's Manual



Copyright 2000-2002, All Rights Reserved.
This manual applies to 2.12 or later versions of the Disk On-line Server

2002/06/06

CUSTOMER SERVICE

To obtain service or technical support for your system, please refer to the registration card for detailed contacts.

TRADEMARKS

Disk On-line Server™ and IEI® are trademarks of ICP Electronics Inc. Microsoft®, Windows® and Internet Explorer® are registered trademarks of Microsoft Inc. Novell® and NetWare® are registered trademarks of Novell Inc. Apple® and Macintosh® are registered trademarks of Apple Computer Inc. All other brand or product names are trademarks of their respective companies or organizations.

LIMITED WARRANTY

In no event shall IEI's liability exceed the price paid for the product from direct, indirect, special, incidental, or consequential software, or its documentation. IEI offers no refunds for its products. IEI makes no warranty or representation, expressed, implied, or statutory, with respect to its products or the contents or use of this documentation and all accompanying software, and specifically disclaims its quality, performance, merchantability, or fitness for any particular purpose. IEI reserves the right to revise or update its products, software, or documentation without obligation to notify any individual or entity.

FCC STATEMENT

The IEI Disk On-line Server has been tested and found to comply with the limits for a Class B digital device, pursuant to Part 15 of the FCC Rules. These limits are designed to provide reasonable protection. This equipment generates, uses and can radiated radio frequency energy and, if not installed and used in accordance with the instructions, may cause harmful interference to radio communications. However, there is no guarantee that interference will not occur in a particular installation. If this equipment does cause harmful interference to radio or television reception, which can be determined by turning the equipment off and on, the user is encouraged to try to correct the interference by one or more of the following measures:

- -Reorient or relocate the receiving antenna.
- -Increase the separation between the equipment and receiver.
- -Connect the equipment into an outlet on a circuit different from that to which the receiver is connected.
- -Consult the dealer or an experienced radio/TV technician for help.

Shielded interface cables must be used in order to comply with emission limits.

Changes or modifications not expressly approved by the party responsible for compliance could void the user's authority to operate the equipment.

This equipment complies with FCC radiation exposure limits set forth for an uncontrolled environment. In order to avoid the possibility of exceeding the FCC radio frequency exposure limits, human proximity to the antenna shall not be less than 20cm (8 inches) during normal operation.

CAUTION

Danger of explosion if battery is incorrectly replaced. replace only with the same or equivalent type recommended by the manufacturer. dispose of used batteries according to the manufacture's instruction.

Contents

Overview of the Disk On-line Server	5
Introduction	5
Package Contents	5
System Overview	6
Installation of the Disk On-line Server	16
Installing the Hardware	16
Set-up Before First Operation	19
Administration of the Disk On-line Server.....	22
Accessing the Administration Page.....	22
Server Administration	23
Quick Configuration.....	25
System Settings	25
Network Settings	26
Disk Configuration.....	31
User Management.....	32
Network Share Management	34
System Tools	36
Statistics & Logs	37
Accessing the Disk On-line Server	38
Using Microsoft Windows	38
Using the Apple Mac Operating System	39
Using the Unix/Linux Operating System	45
Using Novell NetWare	45
Using a Web Browser.....	45
Using File Transfer Protocol (FTP).....	45
Installing the Network Printer (For NAS-2108R/NAS-2108RW Only)	46
Enabling Network Printer Service.....	46
Setting Up the Printer on Your Computer	47
Disk On-line Server - Maintenance.....	51
Shutdown/Restart the Server	51
Reset the Administrator Password & Network Settings	51
Disk Failure or Malfunction	52
Power Outage or Abnormal Shutdown.....	52
Appendix A LCD Panel.....	53
Displayed Information.....	53
Checking IP Address, System and Disk Information	53

System Setup Function.....	54
Appendix B Web File Manager	55
Using Web File Manager.....	55
Web File Manager Icon.....	57
Appendix C Quick Install Wizard.....	58
Introduction	58
Screenshot	58
Operation Help	59
Appendix D Registering a Dynamic Domain Name.....	61
Introduction	61
Registration Procedure	61

Overview of the Disk On-line Server

Introduction

Thank you for choosing the Disk On-line Server. This product offers the following features:

- Share your storage over Microsoft, Unix and Apple network.
- Protect your data via RAID technology and management.
- Easy administration through simple web interface.
- Built-in firewall / NAT router function for Internet sharing.

Package Contents

The Disk On-line Server™ box contains:

- Disk On-line Server
- User's Manual
- Power Cord
- One CAT 5 Network Cable
- Quick Install Wizard CD-ROM or Floppy Diskette
- Warranty Registration Card

System Overview

NAS-2108R

- **Front View**

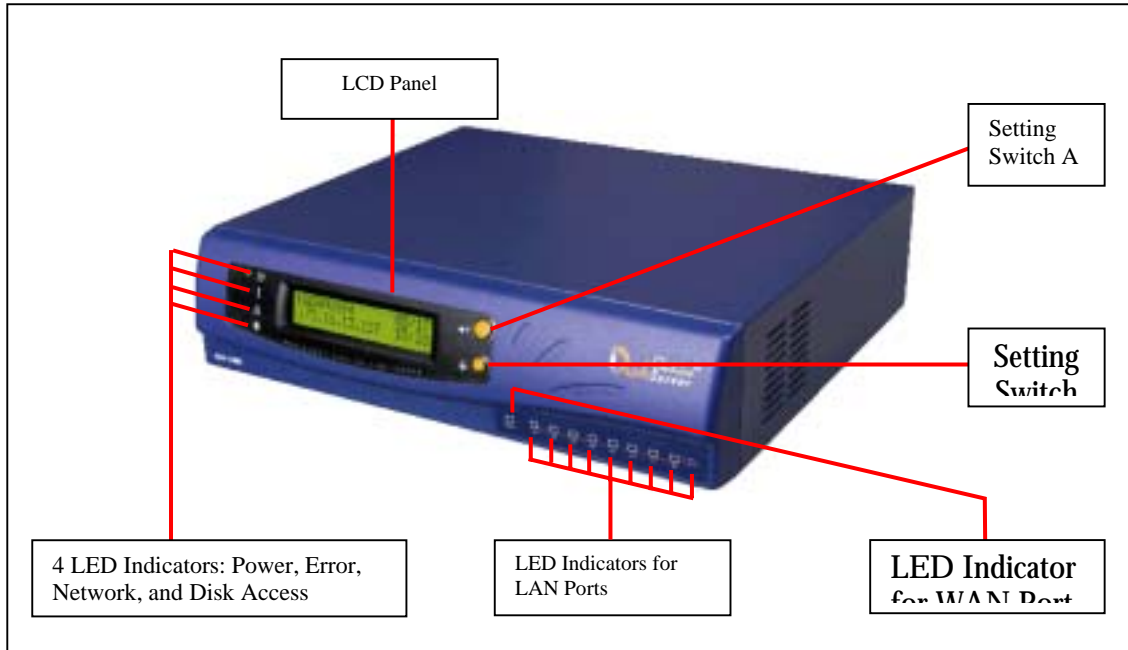

- **Front View**

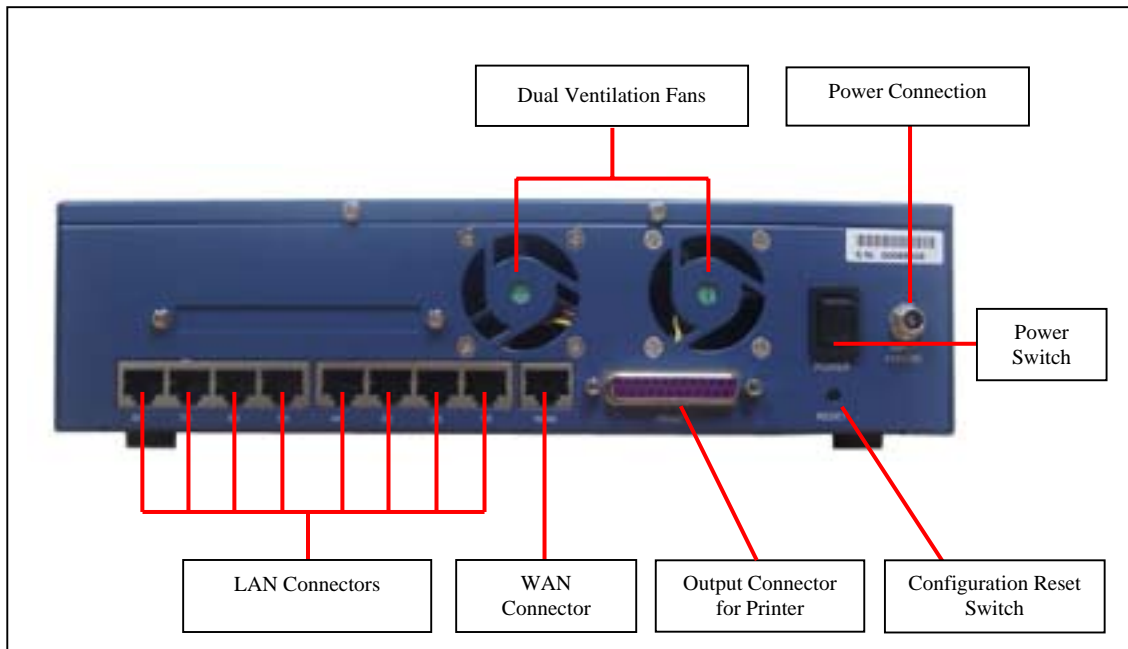





- **Network Status Indicators**

There are nine LED indicators at the lower right area of the rear panel. Each LED indicates the network status of the corresponding WAN or LAN port as below:

Color	Indicates
Green	Current connection is at 100Mbps. The flashing light indicates data is being transmitted.
Red	Current connection is at 10Mbps. The flashing light indicates data is being transmitted.

Indicator light at the left of the LCD panel

	Shines when power is on
	Indicates a system error which needs to be corrected
	This light flashes when data is being transmitted through the network
	This light flashes when data is being stored or retrieved from the disks

NAS-2108RW

● Front View

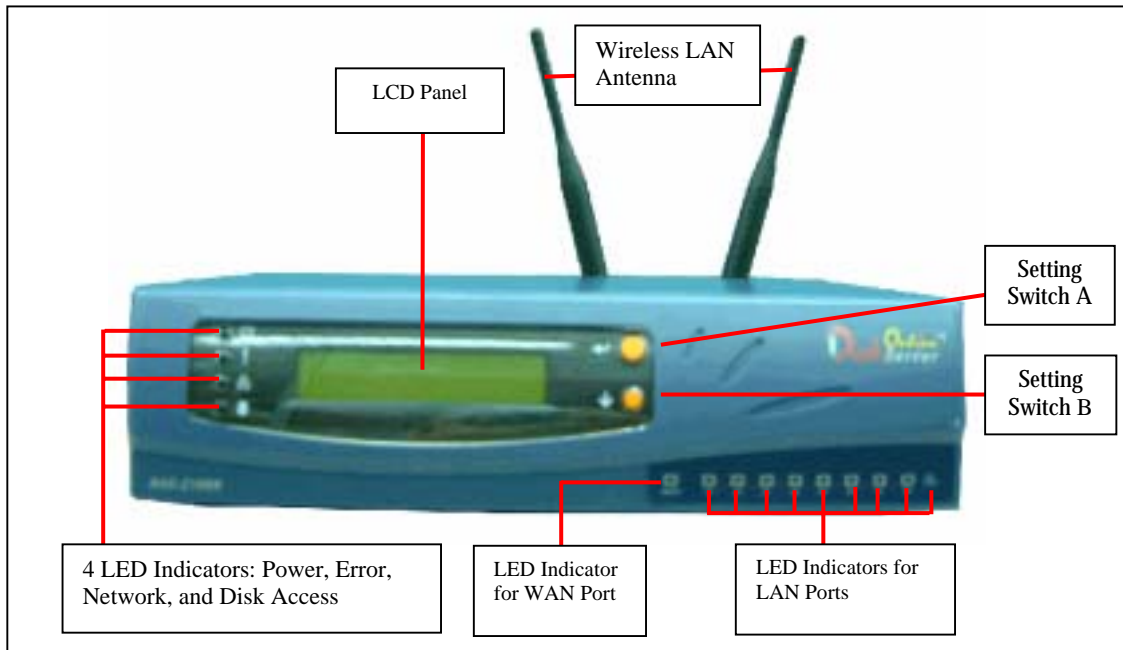

● Rear View

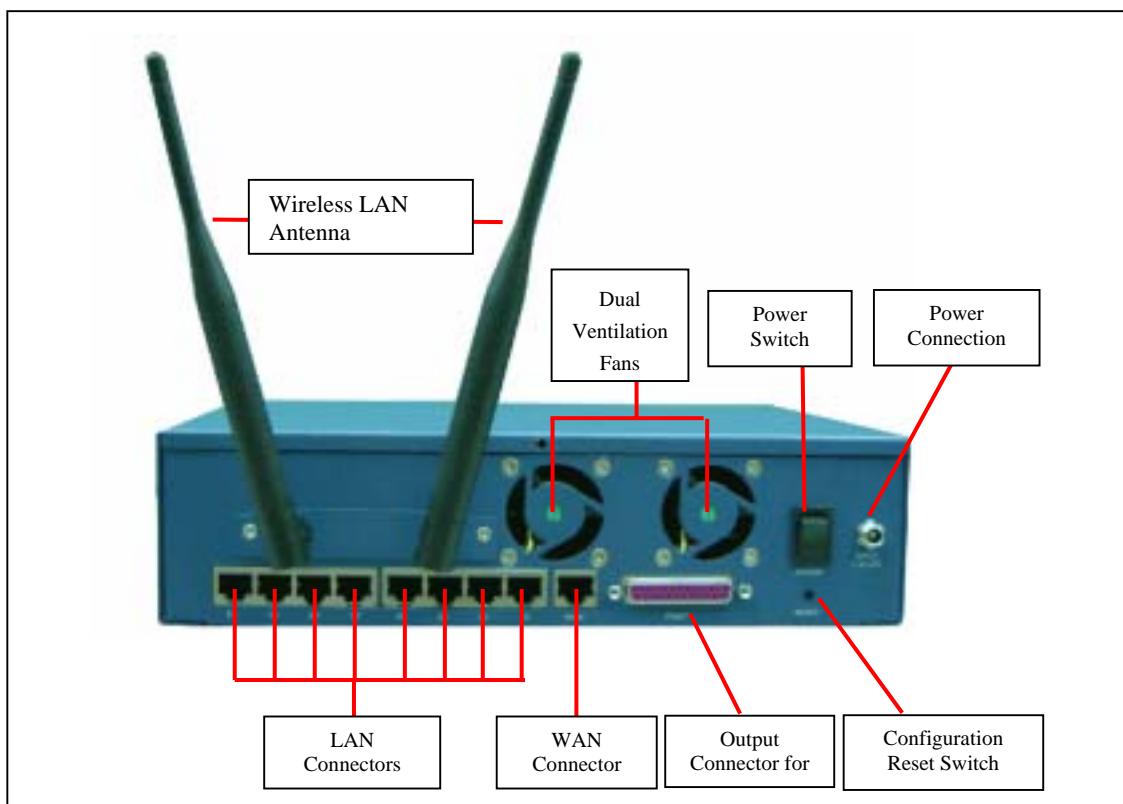





- **Network Status Indicators**

There are nine LED indicators at the lower right area of the rear panel. Each LED indicates the network status of the corresponding WAN or LAN port as below:

Color	Indicates
Green	Current connection is at 100Mbps. The flashing light indicates data is being transmitted.
Red	Current connection is at 10Mbps. The flashing light indicates data is being transmitted.

Indicator light at the left of the LCD panel

	Shines when power is on
	Indicates a system error which needs to be corrected
	This light flashes when data is being transmitted through the network
	This light flashes when data is being stored or retrieved from the disks

NAS-101R

- **Front View**

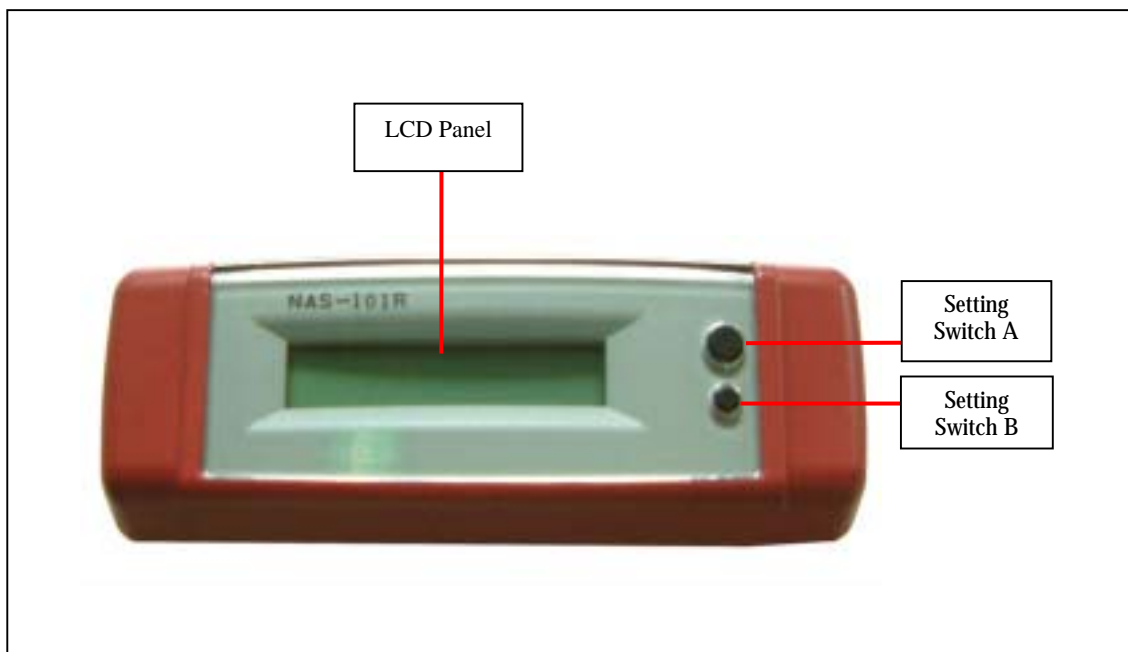

- **Rear View**

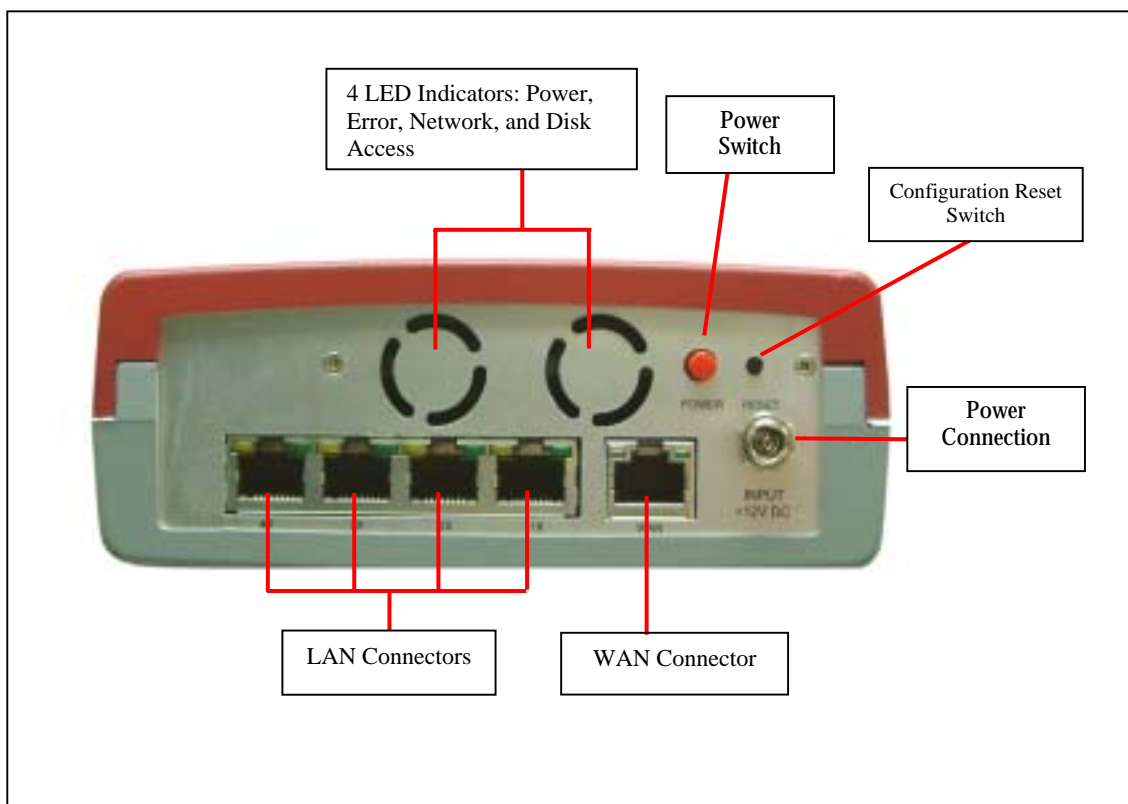

- **Network Status Indicators**

There are five LED indicators at the lower right area of the rear panel. Each LED indicates the network status of the corresponding WAN or LAN port as below:

Color	Indicates
Green	Current connection is at 100Mbps. The flashing light indicates data is being transmitted.
Orange	Lights up when connected at 100Mbps. If this LED does not light up, the connection is running at 10Mbps.

NAS-101RW

- **Front View**

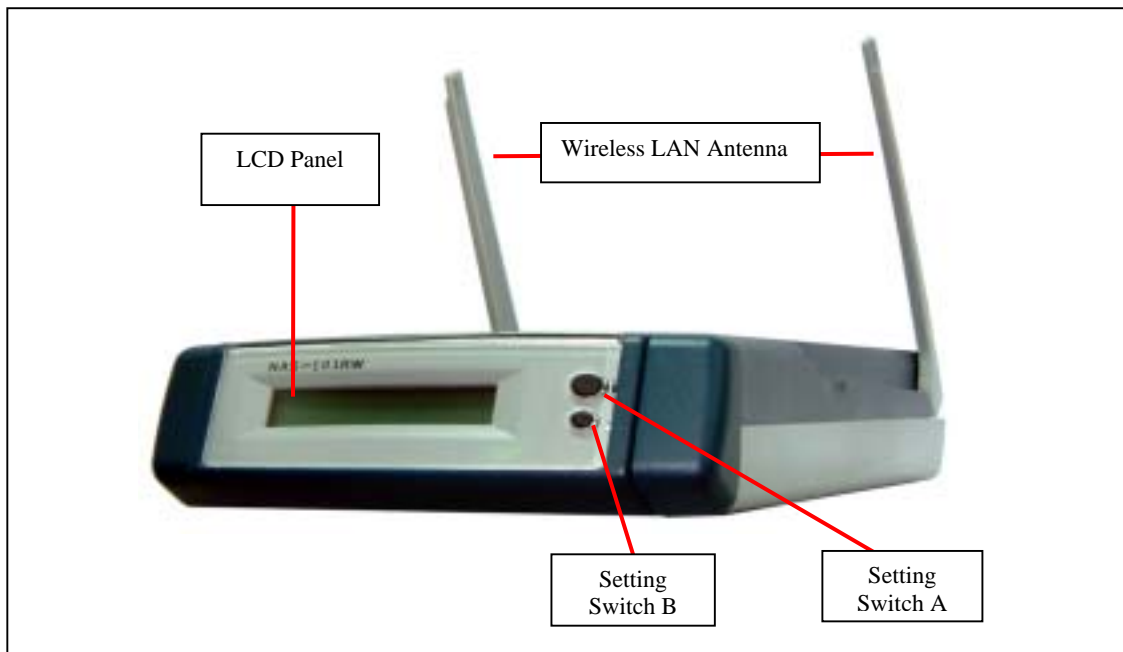

- **Rear View**

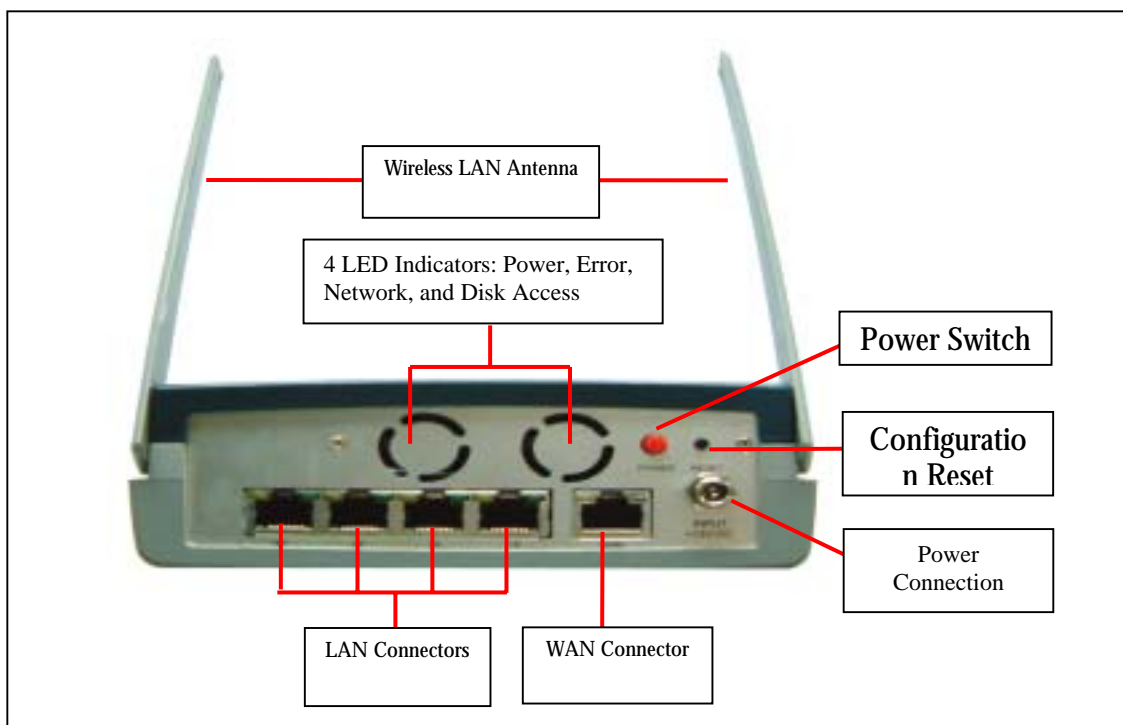

- **Network Status Indicators**

There are five LED indicators at the lower right area of the rear panel. Each LED indicates the network status of the corresponding WAN or LAN port as below:

Color	Indicates
Green	Current connection is at 100Mbps. The flashing light indicates data is being transmitted.
Orange	Lights up when connected at 100Mbps. If this LED does not light up, the connection is running at 10Mbps.

NAS-104R

- **Front View**

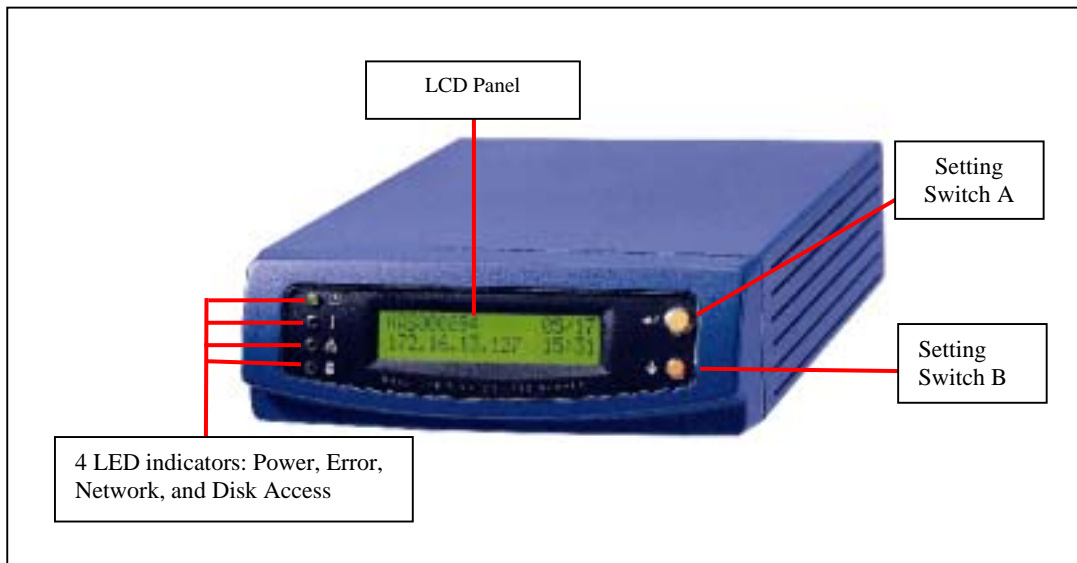

- **Rear View**

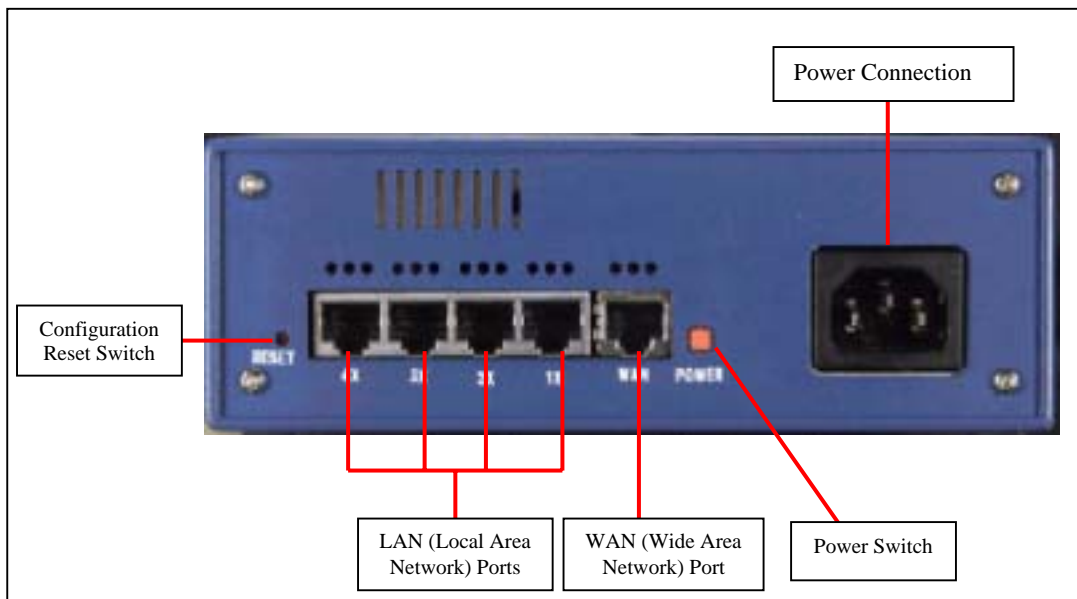

- **Network Status Indicators**

There are five 10/100Mbps network ports on the rear panel of the NAS-104R. Each port has three LED indicators which describe the network status as follows:





WAN Indicator

Color	Indicates
Green	Lights up when connected at 100Mbps.
Red	Lights up when connected at 10Mbps.
Orange	Flashing light indicates data is being transmitted.

LAN Indicators

Color	Indicates
Green	Lights up when connected at 100Mbps. If this LED does not light up, the connection is running at 10Mbps.
Red	Lights up if the connection is running in Full Duplex mode.
Orange	Lights up when connected. The flashing light indicates data is being transmitted.

Indicator light at the left of the LCD panel

	Shines when power is on
	Indicates a system error which needs to be corrected
	This light flashes when data is being transmitted through the network
	This light flashes when data is being stored or retrieved from the disks

Installation of the Disk On-line Server

Installing the Hardware

Please follow these instructions to install your Disk On-line Server.

1. Connecting the Disk On-line Server to the Internet

Consult the drawings below to make the connections.

- Broadband Internet Access via DSL Modem

Please use the network cable included with the Disk On-line Server to connect the WAN port to the DSL modem.

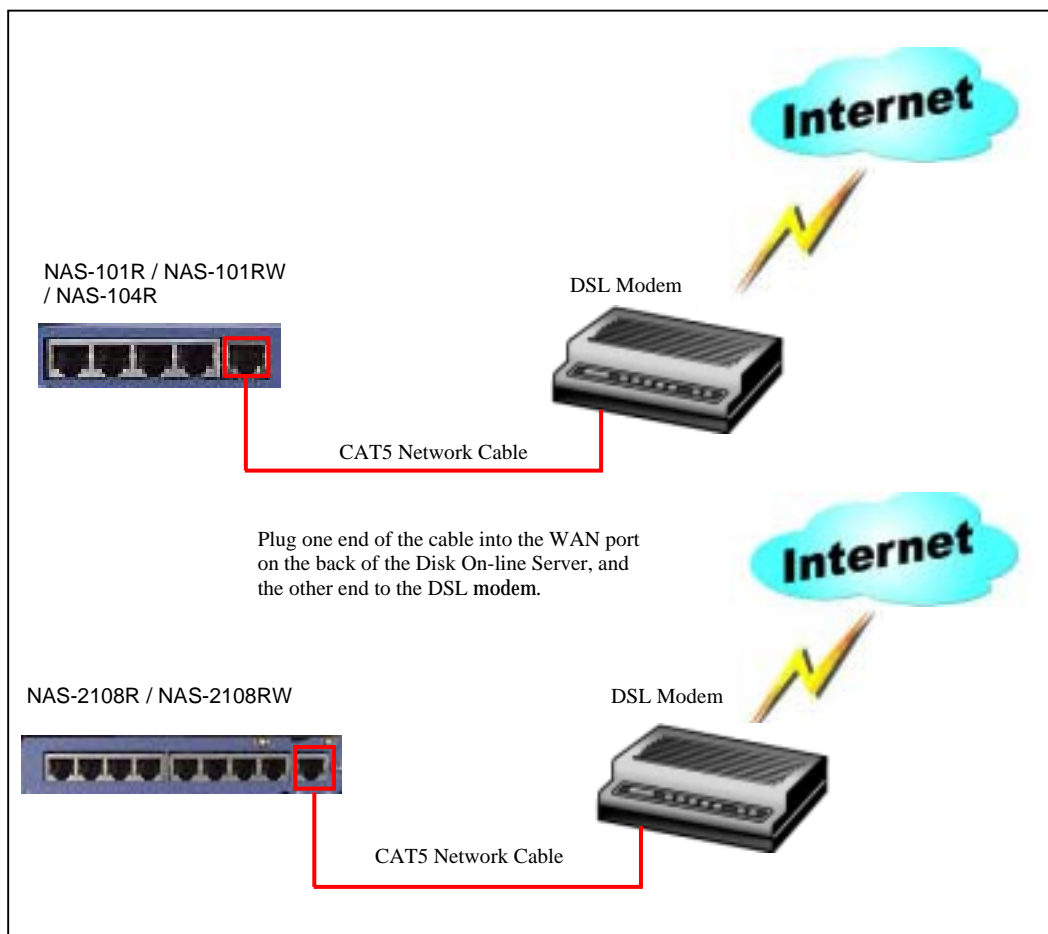

- Broadband Internet Access via Cable Modem
Please use the network cable to connect the WAN port to the cable modem.

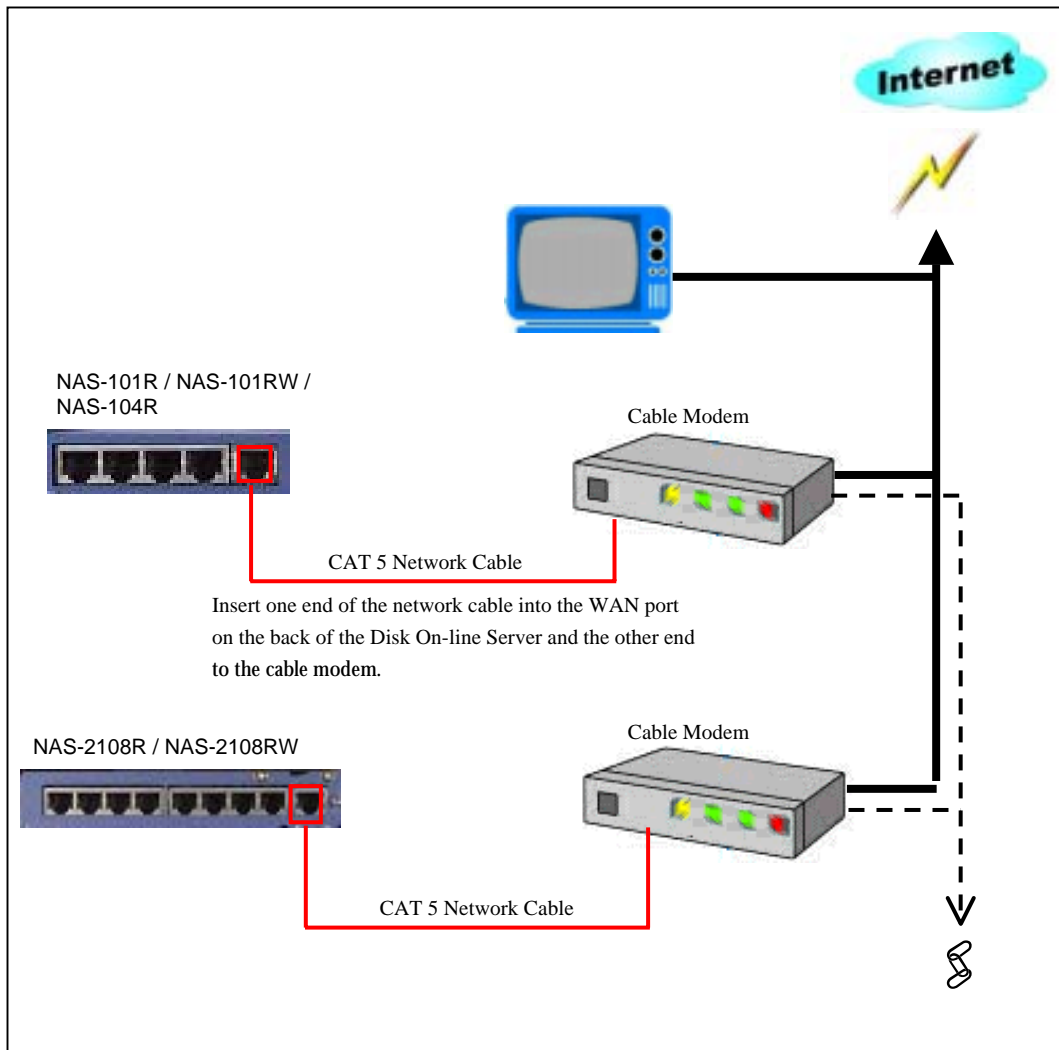

2. Connecting the PCs to the Disk On-line Server

Simply connect one end of a network cable from the one of the Disk On-line Server's LAN ports in to a network port of your computer.

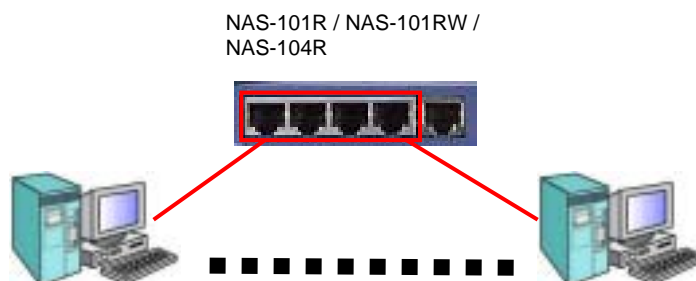

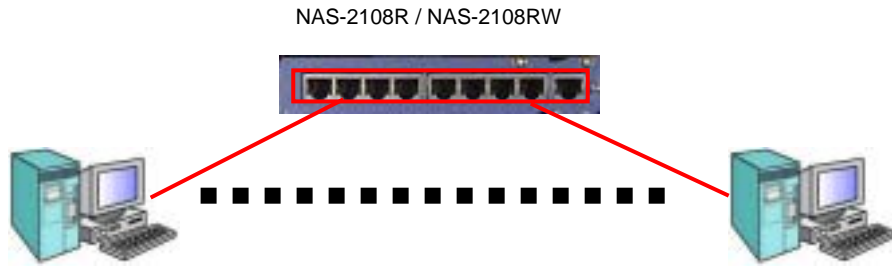

3. Connecting the Printer (For NAS-2108R/NAS-2108RW Only)

The NAS-2108R/NAS-2108RW can provide the function of a network print server by connecting a printer as shown in the diagram below. Please use the printer cable to connect the printer to the printer port on the back of the Disk On-line Server. Follow the software installation procedures described in Chapter 5, and the Disk On-line Server is ready to print your documents.



4. Connecting the Power

Please refer to the following diagrams to connect the power.

NAS-104R

Plug the power cable into the power receptacle.

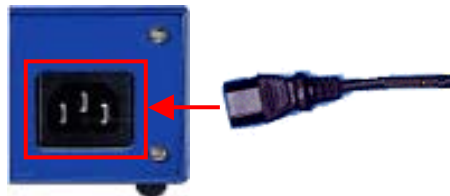

NAS-2108R / NAS-2108RW / NAS-101R / NAS-101RW

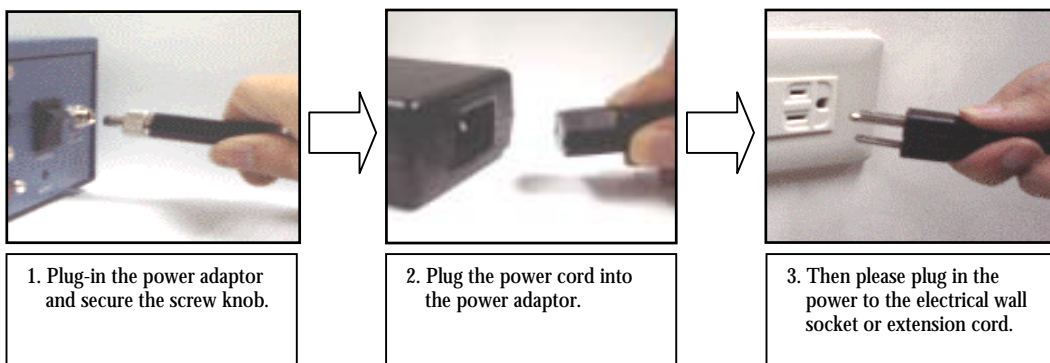

Please make sure the power adaptor is safely secured to the back end of the NAS-2108R/NAS-2108RW/NAS-101R/NAS-101RW prior to plug-in the electrical wall socket or extension cord.

5. Powering up the Disk On-line Server

Once all the cables have been properly connected, push the power switch on the back of the Disk On-line Server. The LCD panel will light up and the system is ready for set-up.

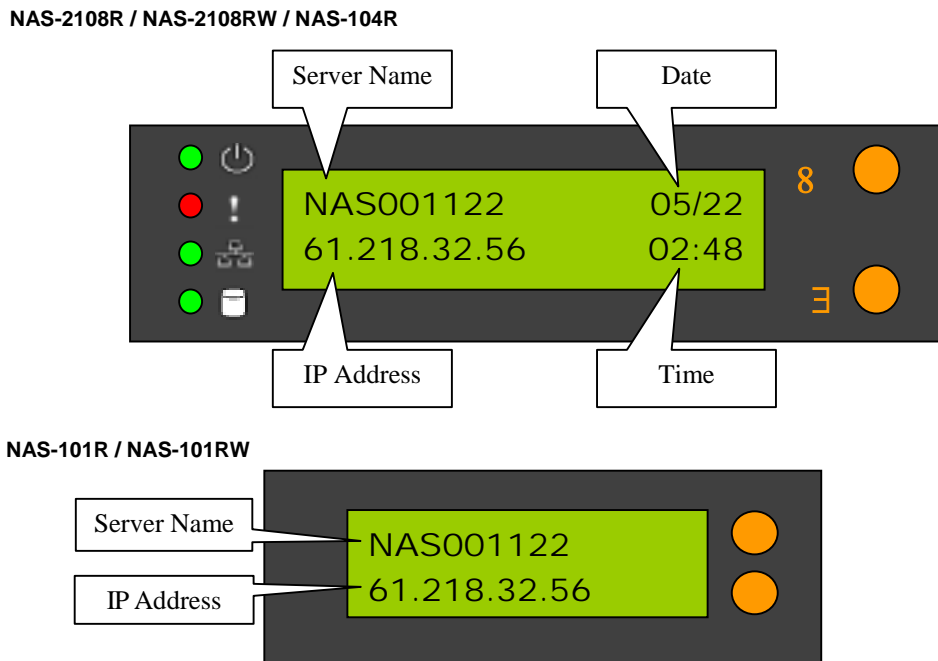

At this time the hardware installation of your Disk On-line Server is complete.

Set-up Before First Operation

Before proceed to further configuration, you need to properly adjust the network configuration of your computers in order to connect to the Disk On-line Server through the local network.

- **Default Network Configuration of the Disk On-line Server**

By factory default, your Disk On-line Server will try to build the connection to the Internet (WAN) via the DHCP protocol. If the Internet connection service that you are using does not support DHCP protocol, you will need to change the WAN configuration to successfully connect to the Internet. Please consult your Internet Service Provider (ISP) or network administrator to get the correct WAN configuration information.

Before you change the WAN configuration, your Disk On-line Server will continuously try to obtain the external IP address from WAN via the DHCP protocol. However, this will not affect the connection between the Disk On-line Server and the local computers. By factory default, the internal IP address of your Disk On-line Server in the local network is **192.168.1.254**, and the DHCP service is activated to perform IP address allocation and management for local network.

Please make sure the computer is connected to one of the LAN ports on the back of the Disk On-line Server, and then follow the instruction below to build the connection.

- **The Network Configuration of Computers in the Local Network**

To ease network management, it is suggested that you configure the local computers to accept dynamic IP addresses assigned by the Disk On-line Server. Please refer to below illustrations about how to set up local computer network configuration of the local computer that runs Windows 98 or Windows ME.

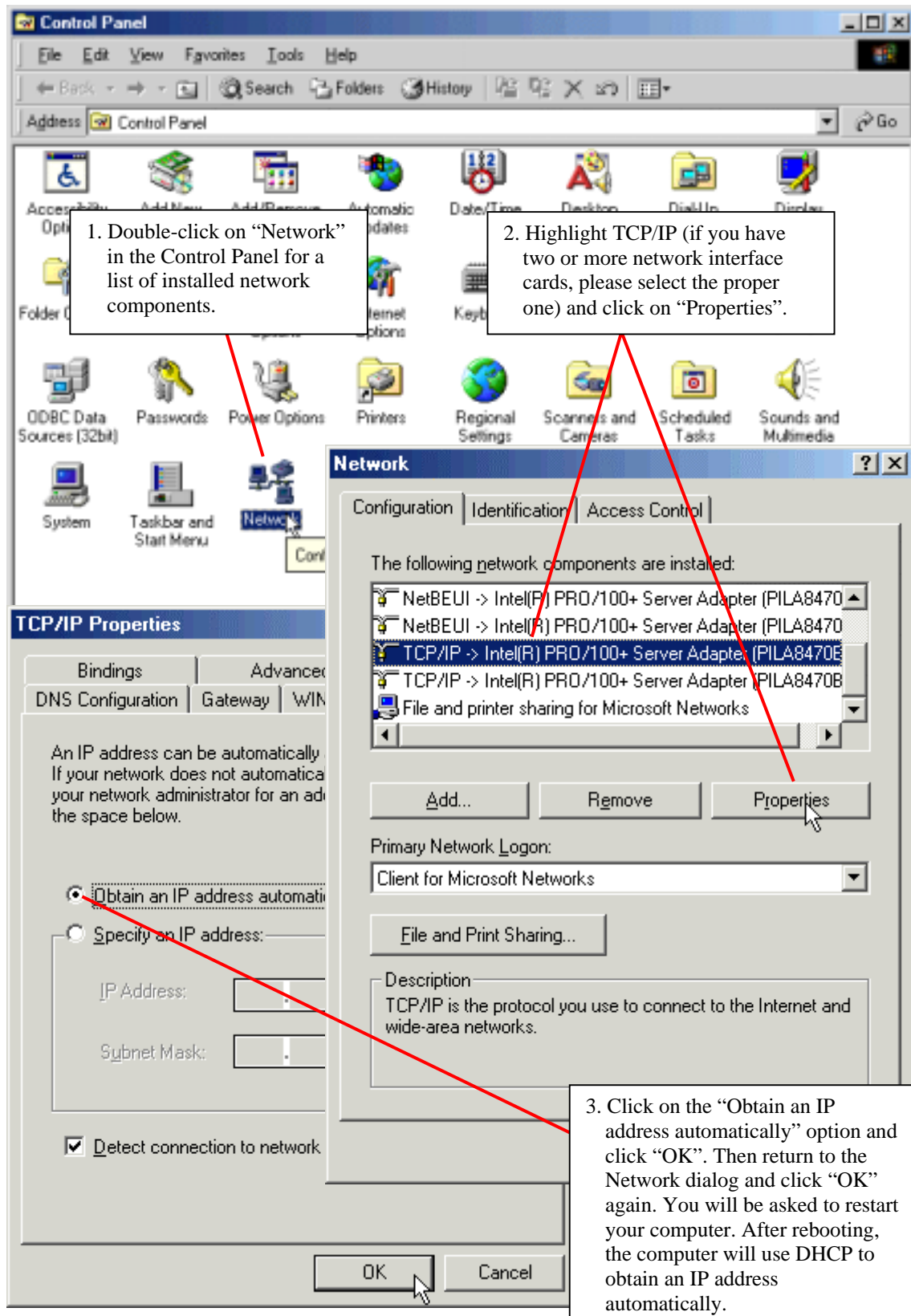

After rebooting, please check to ensure that your computer has successfully obtained its correct IP address. Below is a description of how this is done in Windows 98 or Windows ME:

1. Click "Run" in the Start menu.

2. Type "winipcfg" and click on "OK".

3. If the IP address is between 198.168.1.100 and 192.168.1.200, your computer has obtained a dynamic IP address successfully. Otherwise, please make that the network cable is properly connected to the LAN port and the network status indicator on the front of the Disk On-line Server lights up.

Once these steps have been successfully completed, you can connect to the Disk On-line Server by typing the default internal IP address (192.168.1.254) in the address bar of your browser as shown below:

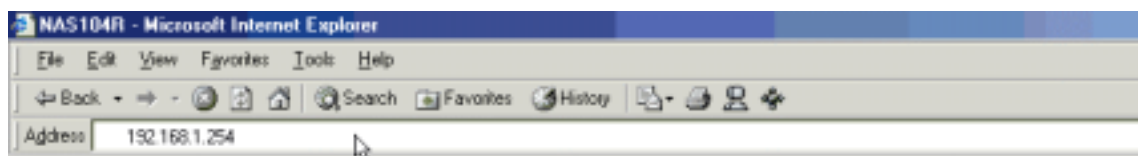

Administration of the Disk On-line Server

Once you have installed the Disk On-line Server and other hardware, and connected it to the network, you can use your browser (supports Microsoft Internet Explorer 5.0 or later and Netscape Navigator 4.5 or later; Microsoft Internet Explorer 5.5 is recommended) to complete administrative tasks for the Disk On-line Server.

Accessing the Administration Page

The following methods allows administrator to access the Administration page:

1. Launch your web browser (Microsoft Internet Explorer version 5.5 is recommended). If you know the IP address of the Disk On-line Server, type the IP address in the address bar of the browser and press “Enter”. The IP address can also be obtained on the LCD display of the Disk On-line Server (see Appendix A).

Note: If the computer you are using is connected to the Disk On-line Server via the LAN port, please type the LAN IP address of the Disk On-line Server (the default address is 192.168.1.254) in the address bar of the browser. If your computer is connected to the WAN port, please type the external IP address of the Disk On-line Server.

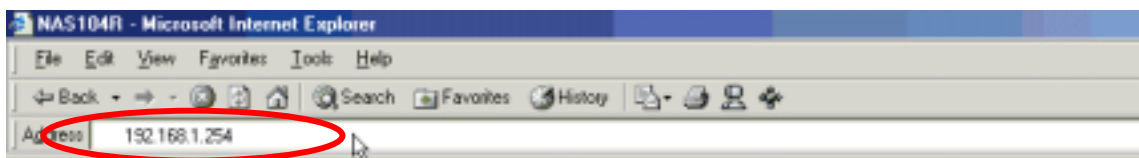

2. Use the Quick Installation Wizard (see Appendix C) and double-click on Disk On-line Server in the list which appears. When the browser displays the home page of your Disk On-line Server, click on the **Administration** link.



Enter the user name and password to continue the administration setup.



The factory default login name and password are as follows:

Login:	Administrator
Password:	admin

If this is the first time you enter the Administration page, the Quick Configuration page appears automatically. Please refer to the Quick Configuration section for more details.

Server Administration

The Server Administration comprise the following eight sections:

Server Administration

Administration

(Quick Configuration

(System Settings

(Server Name

(Date & Time

(Language Setting

(View System Settings

(Network Settings

(WAN Configuration

(LAN Configuration

(Network File Services

(Microsoft Networking

(Apple Networking

(NFS Service

(NetWare Service

(Web Service

(FTP Service

(DNS Service

(Network Printer Service (NAS-2108R/NAS-2108RW Only)

(Router and Firewall Configuration

(Routing Table

(Virtual Server

(One-to-one NAT

(Special Application

(Web Site Filter

(Web Content Filter

(Advanced Firewall Rule

(DMZ

(View Network Settings

(Disk Configuration

(Create Disk Volume

(Single Disk Volume

(RAID 1 Mirroring Disk Volume

(RAID 0 Striping Disk Volume

(RAID 5 Disk Volume (NAS-104R Only)

(Linear Disk Volume

(Delete Disk Volume

(Examine Disk Volume

(Format Disk Volume

(View Disk & Volume Status

(User Management

(Users

(Create

(Change Password

(Create Private Network Share

(Assign User Groups

(NFS Settings

(Quota Settings

(Delete

(User Groups

(Create

(Create Private Network Share

(Assign Users

(Delete

(PDC Authentication Settings

(Quota

(Backup/Restore User Settings

(Network Share Management

(Create

(Property

(Access Control

(Delete

(System Tools

(SNMP Settings

(Alert Notification

(Restart / Shutdown

(Hardware Settings

(System Update

(Change Logo

(Remove Replication

(Statistics & Logs

(Active Users

(Event Logs

(DHCP Logs



Quick Configuration

The Quick Configuration will guide you through the configuration process step-by-step, as follows:

1. Enter the name, workgroup and description for this server.
2. Change the administrator's password.
3. Enter the date, time and time zone for this server.
4. Select the language that this server will use for file names.
5. Enter the IP address, subnet mask and default gateway for this server
6. Select the network file services that you want to provide on this server.
7. Configure disk volume on this server.
8. Configure the method of user authentication.
9. Manage users and user groups for this server.
10. Manage network shares on this server.

Due to different configurations, it might takes from 3 to 10 minutes to complete the Quick Configuration.

System Settings

Basic system settings include the server name, date, time, and language settings.

- **Server Name**

You must assign a unique name for your Disk On-line Server for ease of identification within the local network. The server name can accommodate as much as 14 characters, which can be a combination of letters (A-Z or a-z), numbers (0-9) and hyphens (-). The

server will not accept name containing blank spaces, period (.), or names with only numbers. The LCD display will show the current server name.

Next, you must configure your Disk On-line Server to the workgroup. The workgroup represents a basic computer group within the Microsoft Network. Files are normally shared within the group. Workgroups can accommodate as much as 15 characters but must exclude the following characters:

`; : " < > * + = \ | ? , [] /`

The first character cannot be a period (.). For ease of management and usage, please set your Disk On-line Server and attached computer(s) in the same workgroup.

Moreover, the Disk On-line Server allows you to specify comments (such as administrator name, department, or location) that describe the Disk On-line Server for ease of identification to an on-line user.

- **Date & Time**

Set the date, time, and time zone according to your location. If the settings are incorrectly entered, the following problems may occur:

1. When using a web browser to access or save a file, the time of the file accessed or saved may be out of sync.
2. The system event log time will be incorrect compared to the actual time an action occurred.

- **Language Setting**

The server is based on the language settings and uses it accordingly while creating or displaying files and directories. Select the correct language settings to avoid the following problems:

1. Inability to create files or directories with special characters.
2. Inability to display files or directories name with special characters.

Network Settings

The network settings include the TCP/IP configuration for WAN and LAN, network service settings, router and firewall configuration, etc.

- **WAN Configuration**

According to your WAN connection, you can choose the following four methods to configure the TCP/IP settings to the external network:

1. **Use PPPoE Protocol**

PPPoE is commonly used in DSL-based broadband services to establish the Internet connection. Please check with you ISP to check if PPPoE is used. You will also need the user name and password information that supplied by your ISP to properly configure the PPPoE settings.

2. Use PPTP Protocol

If the Disk On-line Server is connecting to a remote PPTP server through the WAN port, you need to use the PPTP protocol.

3. Use DHCP Protocol

The DHCP protocol is usually used in a Cable modem environment or the intranet. The system will obtain the IP address settings automatically via DHCP.

4. Use Static IP Address

The fixed IP address is usually used in some DSL broadband services or intranet, and an IP address must be entered manually in configuring the network. You will need to enter the following information:

IP Address

The IP address is a 32-bit digit code used to identify each single entity on a network. The IP address is separated into 4 groups of eight bits separated by dots. (e.g. 61.218.1.5)

Subnet Mask

The subnet mask is used to define computer within the same local network. It is a 32-bit digit code. (e.g. 255.255.255.0)

Default Gateway

The gateway is generally referred as an interchange point that connects two networks. If you don't know the gateway's IP address, please ask your ISP or network administrator.

There are several available options in addition to the basic settings:

Allow entering administration web pages from external network

If this option was not enabled, you will not be able to perform system administration from the computers connected to the WAN port. You may also assign the HTTP port number for entering administration web pages.

Disable response to ICMP packets to avoid attacks from hackers

For additional security, when enabling this option, outside computers cannot use the 'ping' program to probe for IP address of this server.

- **LAN Configuration**

If you use the Disk On-line Server as the gateway to connect to the Internet, there is normally no need to change the LAN configuration. Simply change the network configuration of the computers on the LAN to automatically obtain IP addresses via DHCP protocol. By default, the Disk On-line Server provides the NAT function to allow the computers on your LAN to share a single WAN IP address for Internet access.

Fixed IP address

The IP address is a 32-bit digit code used to identify each single entity on a network. This address will be used for all clients in the internal LAN to access this Disk On-line Server. You can check the current LAN IP address of the Disk On-line Server from the LCD panel (see Appendix A).

Subnet Mask

The subnet mask is used to define computer within the same local network. It is a 32-bits digit code: 255.xxx.xxx.xxx.

Default Gateway

The gateway is generally referred as an interchange point that connects two networks, such as LAN and WAN. You don't need to configure gateway address if NAT function is enabled; just set it as 0.0.0.0.

Enable DHCP Server

Once the DHCP server function is activated, the Disk On-line Server will assign dynamic IP addresses to any computer in the local network that is configured to automatically obtain IP addresses.

Note: Only one DHCP server can be activated at any time in a network, or it may cause errors in communication.

Enable NAT Function(NAS-2108RW/NAS-101RW Only)

NAT (Network Address Translation) allows the clients that use the internal private IP address to access the Internet. This option should be enabled if you use the Disk On-line Server to connect to the Internet.

Wireless LAN Configuration

Your Disk On-line Server is designed to act as an Access Point (AP) in the wireless LAN. The system is fully compliant with IEEE 802.11b standard, and provides powerful WEP encryption support for wireless security enhancement.

- **Network File Services**

Microsoft Networking

Users using the Disk On-line Server on the Microsoft Windows operating systems must start Microsoft Network Services.

If the local network has a WINS server installed, please specify the IP address. The Disk On-line Server will automatically register its name and IP address with the WINS service. Or you can enable your Disk On-line Server as the WINS server for your network.

Apple Networking

Users using the Disk On-line Server on Apple Mac operating systems must enable AppleTalk network support.

If your AppleTalk network uses extended networks and is assigned with multiple zones, please assign a zone name to the Disk On-line Server. If you do not want to assign a network zone, please enter an asterisk (*). Asterisk (*) is the default setting.

NFS Service

Users using Disk On-line Server on Unix/Linux operating system computer or server must start Unix/Linux NFS service. The Disk On-line Server supports NFS version 2.0. To correctly use the NFS service, you must assign a User's UID and IP address. Please select **User Management** • **Users** • **NFS Settings** to start the setup.

NetWare Service

If you wish to use NetWare to access the Disk On-line Server, you should activate the NetWare service. The Disk On-line Server will then operate in a manner similar to a Novell NetWare 3.12 file server.

Web Service

Other than standard OS support, you have the choice to use a web browser to access your files on the Disk On-line Server. If your Disk On-line server is connected to the Internet and uses a valid IP address, the Disk On-line Server allows you to access your files using a web browser from anywhere in the world.

FTP Service

If you wish to download files from or upload files to your Disk On-line Server by using file transfer protocol (FTP), you must first activate the FTP service.

- **DNS Service**

DNS (Domain Name System) is used to map a domain name to its corresponding IP address and vice versa. A DNS server provides the domain name service through the network. Using this, you can create and manage your domain name in the Internet. If you do not know how to register a domain name, please contact your ISP. According to your domain configuration, you can configure the Disk On-line Server as the primary DNS server or as the secondary DNS server.

Primary DNS Server

The primary name server is responsible for maintaining a list of host name records and their associated IP addresses. You can add the following name records to your domain:

- A Forward Address Record
- NS Name Server Record
- MX Mail Exchange Server Record

You may also specify the forwarding servers; the Disk On-line Server will forward all DNS requests that can't be resolved locally to the specified DNS server (typically your ISP) and return the response to the client.

Secondary DNS Server

The Disk On-line Server can be configured as a secondary DNS server to provide redundant DNS service for your domain.

- **Network Printer Service (For NAS-2108R/NAS-2108RW Only)**

The network printer service enables printer sharing via Microsoft or Apple networking. Please refer to Chapter 5 for detailed procedure to configure the network printer.

- **Router and Firewall Configuration**

Routing Table

The static route defines the network path to reach a specific network or host. You may need to set up a static route if this system is connected to more than one network.

If you do not have other routers in the network, you will not need to add any static routing entry. The system will use the default routing table for communication between WAN and LAN.

Virtual Server

This feature allows you to make the service provided by the internal server accessible to the users from Internet. The Internet users will then use the WAN IP address of the Disk On-line Server to access all of your virtual servers.

One-to one NAT

This feature allows you to map an external public IP address to an internal private IP address hidden by NAT. To use this feature, you will need to have more than one public IP address from your ISP. You can use this feature to have several servers using internal IP addresses to be accessed from the Internet.

Special Application

This feature allows you to use some on-line applications that require 2-way communication or simultaneous sessions. If you use on-line games, conferencing or messaging software, you may need to configure this function.

Web Site Filter

The web site filter provides a mean to block access to undesirable web sites. If a web site address is added into web site filter, access to that site is blocked for all clients in the internal LAN.

Web Content Filter

The web content filter allows you to block access to web sites with undesirable contents.

Advanced Firewall Rule

This feature allows administrators to define a set of rules to examine the network packet flow between internal LAN and external WAN. By default, all packets from external networks are denied except for web site requests. No packets from the internal network are blocked or discarded.

DMZ

This feature allows one computer on your LAN to be exposed to all users on the Internet. This can allow 2-way communication between the DMZ host and other users from the external network. If you meet troubles to use some Internet gaming or video-conferencing application on your local computer, you may try to configure this computer as the DMZ host.

- **DDNS Service**

DDNS (Dynamic DNS) service allows the Internet users to use a domain name to access the Disk On-line Server or the servers on your LAN rather than an IP address. This feature is particularly useful if you are using the broadband service that assigns a dynamic WAN IP address. To activate the DDNS service, you must first apply an account from a free DDNS service provider (See Appendix D).

Note: The Disk On-line Server currently supports the DynDNS (<http://www.dyndns.org/>) DDNS service.

Disk Configuration

The Disk On-line Server can accommodate a maximum of four disks (NAS-2108R/NAS-2108RW can accommodate a maximum of two disks). The Disk Volume can be configured according to your needs.

- **Single Disk**

You can choose to use a stand-alone disk. However, if the disk is damaged, all data will be lost.

- **RAID 5 Disk Volume (For NAS-104R Only)**

Three or more hard disks can be teamed up to form a large-capacity RAID 5 disk group. This system will distribute and store data among its various member disks as it is received. At the same time it uses an amount of space roughly equivalent to a whole disk to store reference numbers with the same elements. Should one of the disks in the group suffer some kind of damage, you can shut down the computer and install a new disk, and the system will restore the data on the new disk using the reference number. In addition, if you have a system with four disks but use only three in your RAID 5 group, the fourth will serve as a spare disk. If one of the three disks is damaged the system will automatically start using the spare disk without powering down and changing the affected disk. Generally speaking, the capacity of a RAID 5 disk group is one disk's worth of space less than the total rated capacity of the group.

Note. RAID 5 may be used only with equipment which has three or more disks.

- **RAID 1 Mirroring Disk Volume**

Mirroring Disk protects your data by automatically backing up the contents of one disk onto the second disk of a mirrored pair. This protects your data if one of the disks fails. Unfortunately, the storing capacity is equal to a single disk, as the second drive is used to automatically back up the first. Mirroring Disk is suitable for personal or corporate use to store important data.

- **RAID 0 Striping Disk Volume**

Striping disk combines two or more disks into one larger disk. It offers the fastest disk access but it does not have any protection of your data if the striped array fails. The disk capacity equals the number of disks in the array times the size of the smallest disk. Striping disk is usually used to maximize your disk capacity or for fast disk access but not for storing important data.

- **Linear Disk Volume**

You can combine two or more disks into one larger disk. During file saving, the files are saved on physical disks but do not have a disk failure file protection function. The overall capacity of linear disks is the sum of all disks. Linear disks are generally used for storing large data and are not appropriate to use for protection of important data.

By factory default, the Disk On-line Server has been pre-set into one large disk. If you wish to use other disk configurations, the settings can be changed during the first Quick Configuration access. Furthermore, to increase the hard disk life, the hard disk will go to standby mode if there is no access within 30 minutes. If any data access happens while the hard disk is in stand-by mode, it will take 3 or 5 seconds for the hard disk to return to normal mode. You can select **System Tools · Hardware Settings** to change the setting.

You can also perform the following disk administration:

- Create Disk Volume
- Delete Disk Volume
- Examine Disk Volume
- Format Disk Volume
- View Disk & Volume Status

User Management

The Disk On-line Server can share its files with multiple users. It is important to plan and organize users and user groups' accessibility to ease the administration work.

- **User**

The factory default settings contains the following user settings:

Administrator

By default, the Administrator is a member of the Administrators group and has access to the system Administration. You cannot delete the user Administrator.

Guest

When you use a non-registered user name to login, the server recognizes it as a guest and will allow limited access. A guest does not belong to any user group. You cannot delete the user guest or create a password.

Anonymous

When you connect to the server by FTP service, you can use the name to login as a guest. You cannot delete this user or change its password.

You can create a new user according to your needs. The following information is required to create a new user:

- **User Name**

The user name must not exceed 32 characters. It is case insensitive and it can contain double-byte characters (Such as Chinese, Japanese, and Korean) But it cannot contain any of the characters below:

" / \ [] : ; | = , + * ? < > ` '

- **Password**

The password must not exceed 16 characters. Due to security concerns, the password must be at least 6 characters. Try to avoid using codes that are easily decipherable.

You can perform the following settings for users:

- Create User
- Change Password
- Create Private Network Share
- Assign User Groups
- NFS Settings
- Quota Settings
- Delete User
- **User Groups**

To administer access rights, you can create user groups. User groups are a collection of users with the same access rights to files or folders. By factory default, the server contains the following pre-defined user groups:

Administrators

All members of the administrators group have the rights to perform system management. You cannot delete the administrators user groups.

Everyone

All registered users belongs to everyone group. You cannot delete the everyone user group or any of its users.

You can administer user groups with the following:

- Create User Groups
- Create Private Network Share

- Assign Users
- Delete User Groups

User groups name must not exceed 256 characters. It is case insensitive and it can contain double-byte characters (Such as Chinese, Japanese, and Korean) But it cannot contain any of the characters below:

" / \ [] : ; | = , + * ? < > ` '

To properly manage security, it is very important to manage users and user groups. You may set the share access parameters of each user or user group accordingly.

- **PDC Authentication Settings**

If you have a Windows PDC (Primary Domain Controller) server to handle the domain security in your network, you don't need to re-enter all the users and groups with the Disk On-line Server. You can simply enable the PDC authentication feature; the Disk On-line Server will connect with the NT domain and get all the information of the domain users and groups automatically.

To enable PDC authentication, you must enter the domain name as well as the user name and password already established in this domain. The Disk On-line Server will use the user name and password to log in to the NT domain and retrieve user and group information. Once you have configured the Disk On-line Server to use PDC authentication, all NT domain users and groups will appear in lists of users and groups for which you can define access rights.

Note: NetWare users cannot be authenticated via the PDC server. To properly authenticate NetWare users, please go to **User Management · Users · Change Password** page and type the password for that user manually.

- **Quota**

The amount of space given out to all users in the system can be limited in order to manage and allocate it efficiently. Once these restrictions are in place, users will be prevented from obtaining more space once they have reached their limit. This prevents monopolizing of a large amount of disk space by a small group of users. No limitations are set on the system when it leaves the factory.

- **Backup/Restore User Settings**

You may back up all user settings on to your computer as well as restore previously backed up user settings file to your Disk On-line Server. This function allows you to easily maintain the user settings.

Network Share Management

The primary purpose of network storage is file sharing. In a standard operation environment, you can create different network share folders for various types of files, or provide different file access rights to users or user groups. By factory default, a "public" share folder is created. The share folder gives full access to all users or guests.

Administer network shares with the following:

- Create a Network Share
- Change the name, path and comment of a network share
- Set access right for a network share
- Remove a network share

You can create new network shares according to your needs. While creating a network share the following parameters must be set:

- **Network Share Name**

The network share name must not exceed 12 characters. It cannot contain double-byte characters (such as Chinese, Japanese, and Korean) as well as the characters listed below:

". + = / \ : | * ? < > ; [] %

- **Disk Volume**

The network share will be created under the specified disk volume.

- **Path**

All data are stored under the assigned path onto the disk volume. You can select **Specify Path Automatically** to allow the server to automatically create a new path on the disk volume to store the network share files. Or you can assign a specific path for the share folder. The manually assigned path cannot exceed 256 characters and cannot contain the characters listed below:

" \ : | * ? < > ; ` ' "

- **Comment**

The **Comment** field allows a brief description of the share folder to help users identify its purpose in a network neighborhood window. The comment cannot exceed 128 characters.

Once the network share is created, you can start assigning access rights to users or user groups:

- **Full Access**

Full access allows the user or user group to read, write, create, or remove all files and directories in the network share.

- **Read Only**

Reads files only in the network share but denies functions to write, create or delete files or directories.

- **Deny Access**

Denies all files on the network share.

System Tools

The following system tools allow optimized maintenance or management of your Disk On-line Server:

- **SNMP Settings**

In order to use Simple Network Management Protocol (SNMP) to manage the Disk On-line Server's network components, the SNMP service must be started.

- **Alert Notification**

Configures administrator's e-mail address and SMTP server's IP address. In case of warning or malfunction, an email is automatically sent to the administrator.

- **Restart / Shutdown**

Powers off or restarts the Disk On-line Server.

- **Hardware Settings**

You can enable or disable the following hardware functions of your Disk On-line Server:

1. **Enable LCD panel setting function**

Allow you to change the TCP/IP configuration using the LCD panel buttons.

2. **Enable configuration reset switch**

Depress and hold on the configuration reset switch for 5 seconds to reset the administrator password and network settings to the factory default.

3. **Enable hard disk standby mode**

Hard disk will go to standby mode if there is no access within the period you specify.

4. **Enable buzzer**

If the buzzer is disabled, it will not sound when a system error occurs, but the warning light will still shine.

- **System Update**

Performs system software updates. Make sure that the image file that you are about to update is the correct version and read through the instructions carefully. It is wise to back up all existing data on the Disk On-line Server prior to performing system software update. The current settings will remain unchanged after the system is upgraded.

- **Change Logo**

You can place a picture that you desire on the upper right corner of the home page. The size of the picture cannot exceed 20K.

- **Remote Replication**

User can backup data from local NAS to another NAS without backup software. It can provide schedule Full/Incremental/Sync remote replication.

Statistics & Logs

You can monitor the current logon user of the Disk On-line Server and the system event logs for the purpose of user administration or system diagnostic reference.

- **Active Users**

Displays information of all online users.

- **Event Logs**

The Disk On-line Server can store thousands of recent event logs, including warning, error and information messages. In the event of a system malfunction (LCD error indicator lights up), the event logs can be retrieved to help diagnose the system problem.

- **DHCP Logs**

If the DHCP server function is activated, you can use it to monitor all of the assigned dynamic addresses, client MAC addresses and other information.

Accessing the Disk On-line Server

Using Microsoft Windows

Under the Microsoft Windows operating system, you can access the Disk On-line Server using the following steps:

1. Use the locate and connect the Disk On-line Server within the local network:
 - Click on the **Start** button and select **Run** in the Windows menu bar. Enter the name of the Disk On-line Server, for example:
`\\NAS004001`
and press Enter.
 - You may also look for the Disk On-line Server within the Network Neighborhood. Locate the workgroup and find the name of your Disk On-line Server. When the server is found, double-click on the server name to connect.
 - You may also use the “Search for Computers” function to look for your Disk On-line Server in Windows. Under Windows ME or Windows 2000, please follow these steps:
 1. Open “My Network Places” folder.
 2. Under the tools bar menu click “Search”.
 3. Computer Name path key-in Disk On-line Server name.
 4. Click once on **Search**.Once the Disk On-line Server is found, double-click your mouse button on the icon to connect.
2. Once the connection to the Disk On-line Server is successful, all listing on your available network share are displayed. Move the mouse pointer to the network share you want to access and click the right button once. A popup menu appears; select “**Map Network Drive**”. A popup window that allows you to assign a drive letter for the network share appears (note: do not use the drive letter used by the CD-ROM). If you wish to make the share folder available for your next start-up, check the “**Reconnect at logon**” box on the popup window and click on “OK” to make the network share as one disk drive in your system.

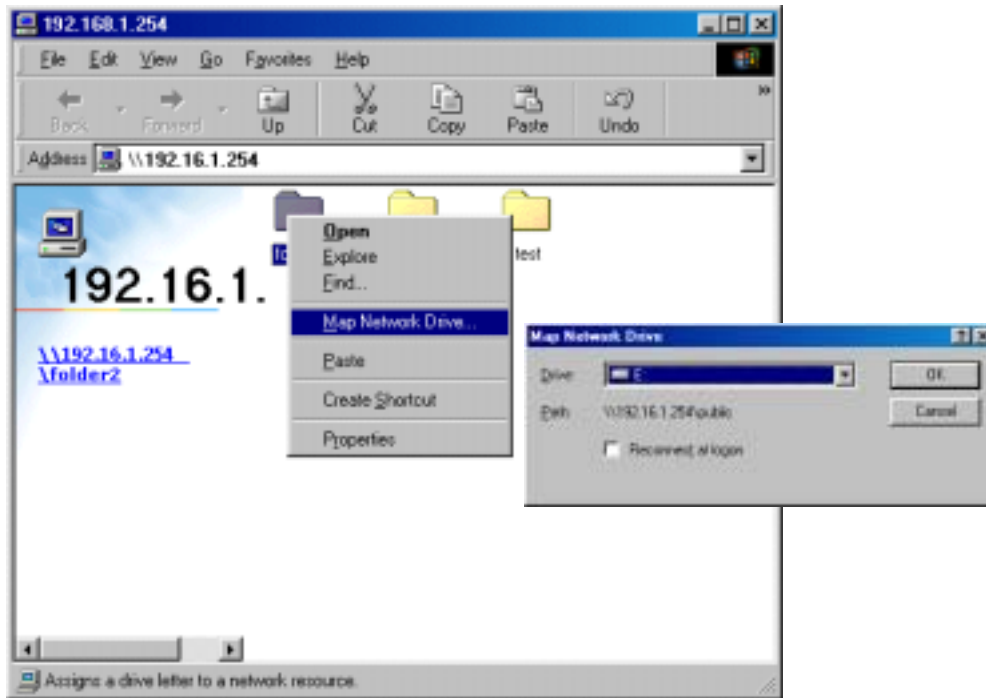

3. Once the network share is a part of your system disk drives, you can locate the network share in “My Computer” and access it as a regular hard disk drive.

Using the Apple Mac Operating System

If you are a Mac OS user, you can use the following two methods to access to your Disk On-line Server:

1. Using Network Browser

- a. Choose “Network Browser” in the Apple menu.

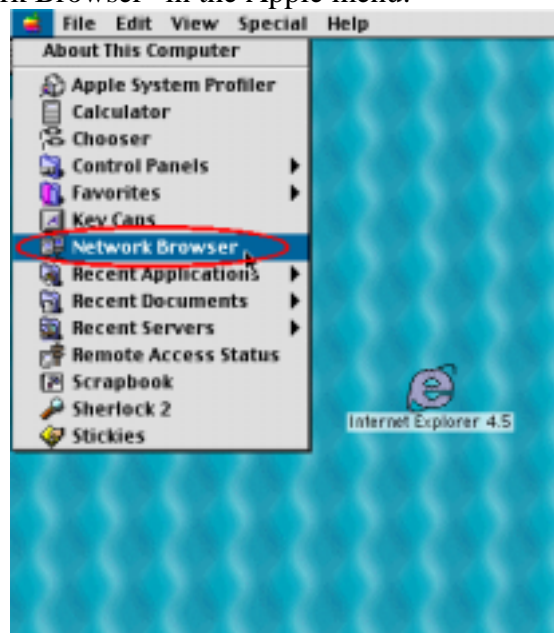

- b. In the “Network Browser”, choose AppleTalk; a list of all computers on the AppleTalk network appears. Choose the Disk On-line Server.

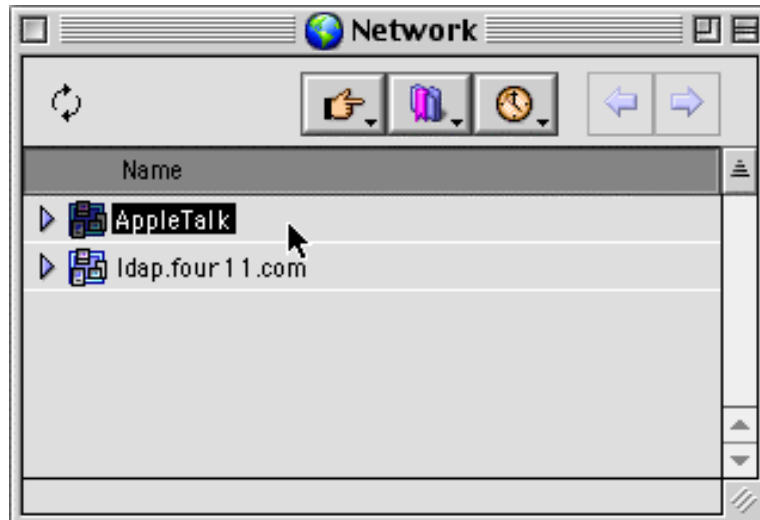

- c. Once the Disk On-line Server is chosen, the system will request you to input the login name and password. Click “Connect” or use “Guest” to enter. When the login name and password are confirmed, a popup window informs you that the connection is made with the Disk On-line Server.

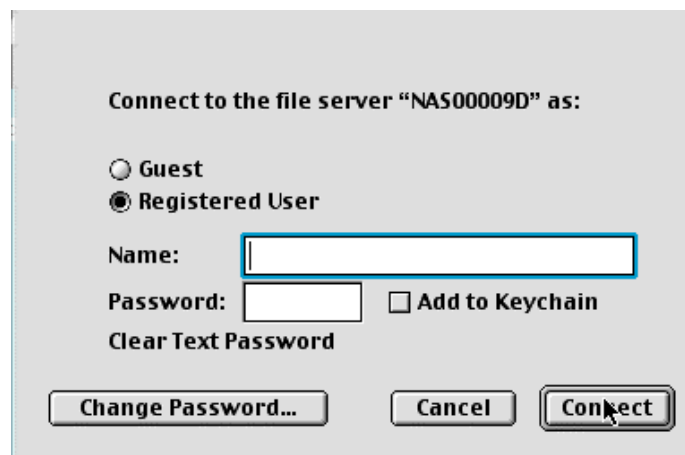

- d. When the Disk On-line Server is connected, the network browser displays all the network shares. You can then access or drag & drop the share folders.

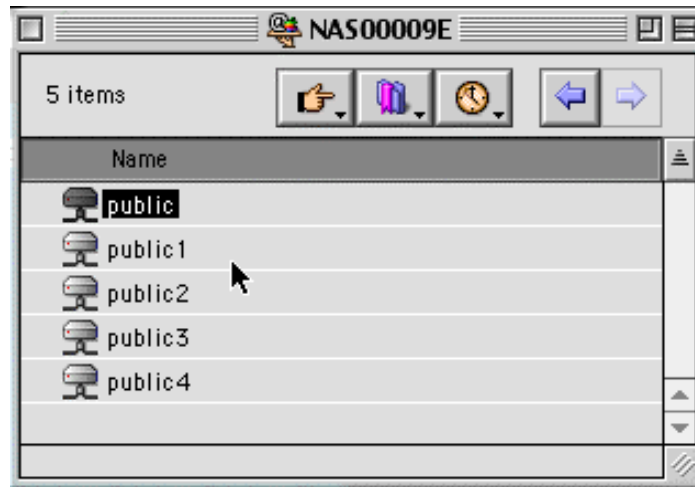

- e. Choose either one of the network shares to start to link. The network share appears on the Mac OS desktop.

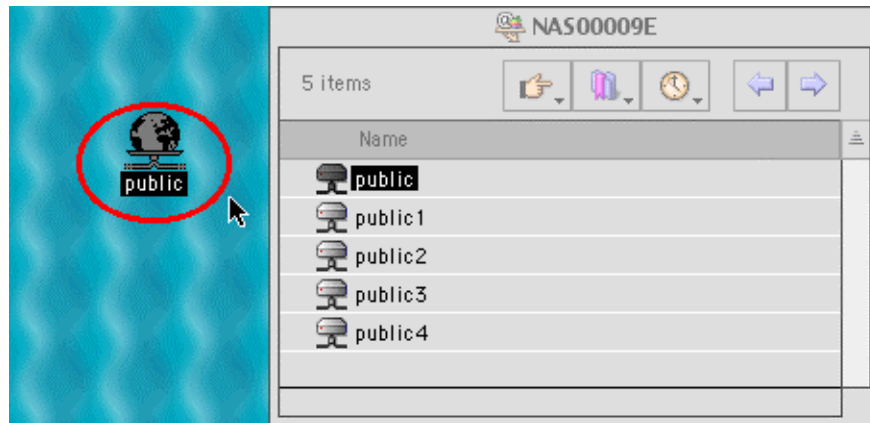

2. Using the Chooser

- a. Select **Chooser** in the Apple menu bar.



- b. Click on **AppleShare**. The name of the Disk On-line Server appears on the right side of the window.

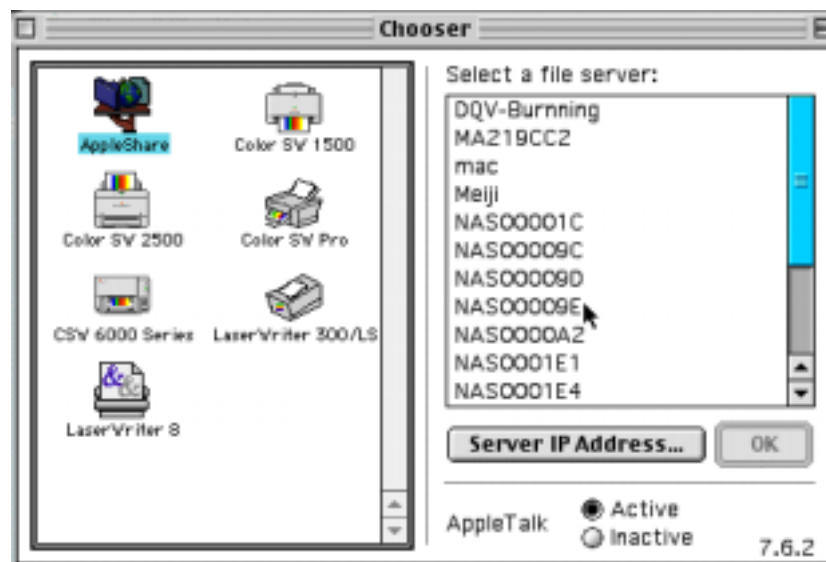

- c. Use the mouse to highlight the Disk On-line Server and then click on the “OK” bottom right-hand side of the screen.

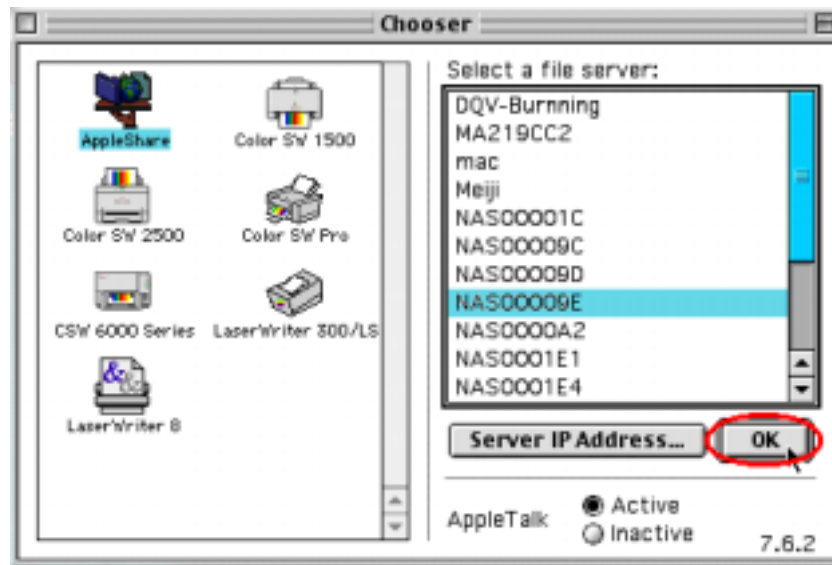

- d. Enter the correct login name and password or use “Guest” to login, then click on “Connect”.

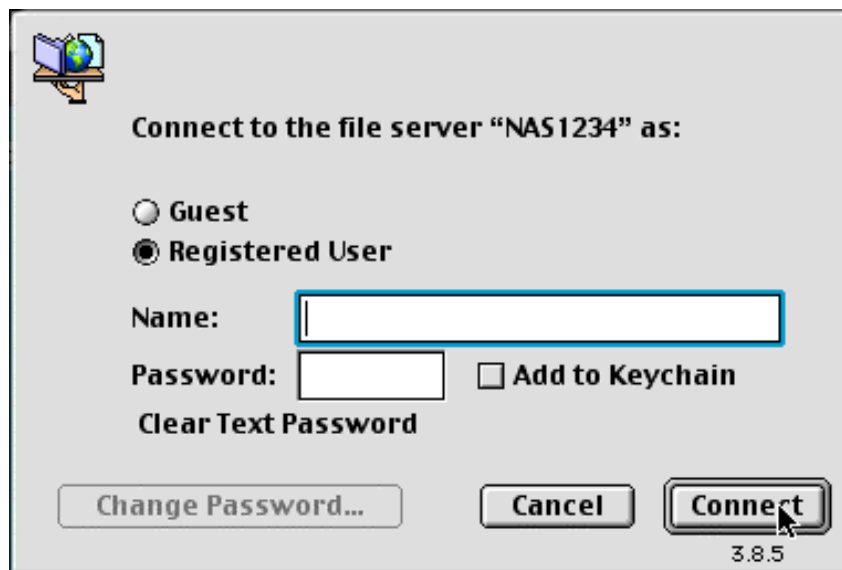

- e. All available network shares will be listed. Use the mouse to choose a network share and click on “OK”.

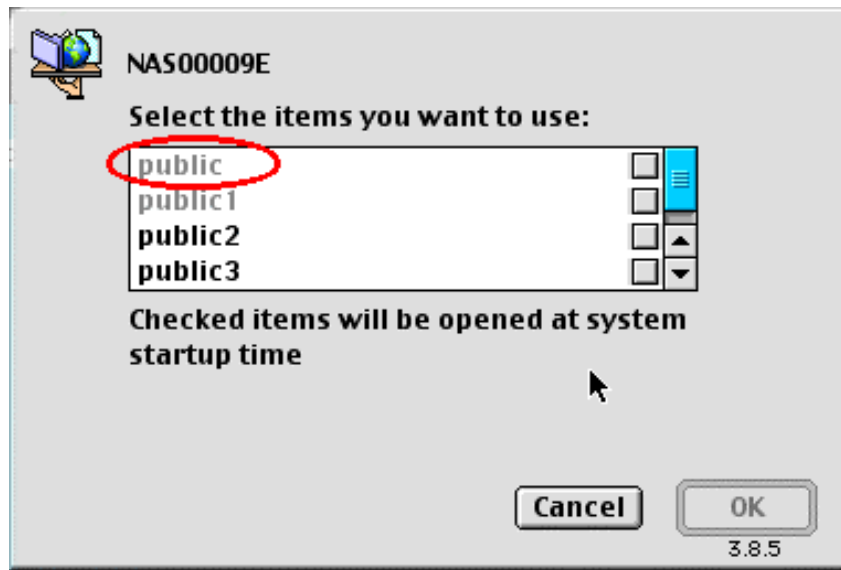

- f. You can then close the Chooser program. Double click on the icon on the desktop to access your files.

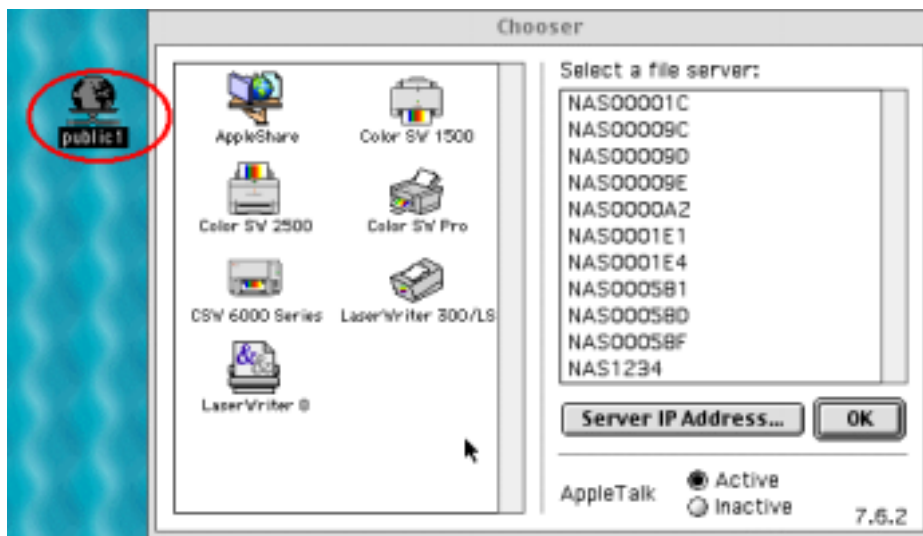

Using the Unix/Linux Operating System

Other than Microsoft OS and Mac OS, your Disk On-line Server supports Unix based systems (such as IBM AIX, HP-UX, Sun Solaris, Linux, Free BSD, etc) through the NFS service:

1. Under Unix, use the following commands:

```
mount -t nfs <Disk On-line Server IP address>:/<Network Share Name> <Directory to Mount>
```

For example, if your Disk On-line server's IP address is 192.168.0.1 and you want to link the network share folder "public" under the /mnt/pub directory, use the following command.

```
mount -t nfs 192.168.0.1:/public /mnt/pub
```

Note: You must login as "root" user to initiate the above command.

2. Logged in as the user id that you defined, you can use the mounted directory to access your network share files.

For more information about NFS settings, please refer to your Unix system documentation.

Using Novell NetWare

If you are accessing the Disk On-line Server from the NetWare client, please refer to the NetWare user's manual for more information. The Disk On-line Server functions as a NetWare 3.12 file server.

Using a Web Browser

Other than OS support, your Disk On-line Server also provides a convenient web style file management that allows using a standard web browser to access your data. If you link the Disk On-line Server onto the Internet and use a public IP address, you can logon to access the files from anywhere in the world.

For more information, please refer to Appendix B.

Using File Transfer Protocol (FTP)

In addition to working with multiple operating systems, the Disk On-line Server also supports FTP. You can use popular FTP software and enter the user name and password to connect to the Disk On-line Server. Or you may key in anonymous as the user name in order to access public network share folders that is open to guest users.

Installing the Network Printer (For NAS-2108R/NAS-2108RW Only)

Enabling Network Printer Service

To enable the print server function, please connect the printer to the printer port on the rear panel of your Disk On-line Server. Then enter the system administration web page via the browser, go to **Network Settings** . **Network Printer Service** to enable the network printer service.

Check the “Enable network printer service” option to enable the print server function.

Please enter the name for this network printer. You can see the network printer name in Microsoft or Apple networking.

Please enter a brief description about this network printer.

After updating all settings, please click on “Apply” to accept changes.

Setting Up the Printer on Your Computer

You will need to install the network printer on your computer. On a Windows 98 or Windows ME platform, please follow below procedure:

1. Select “**Settings**” in the **Start** menu and click on “**Printers**”.

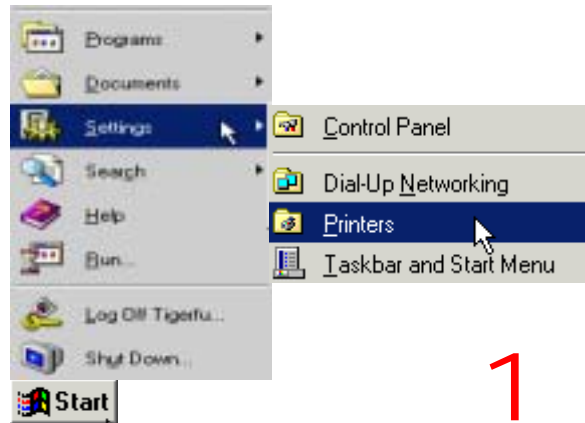

2. Click “**Add Printer**” to run the **Add Printer Wizard**.

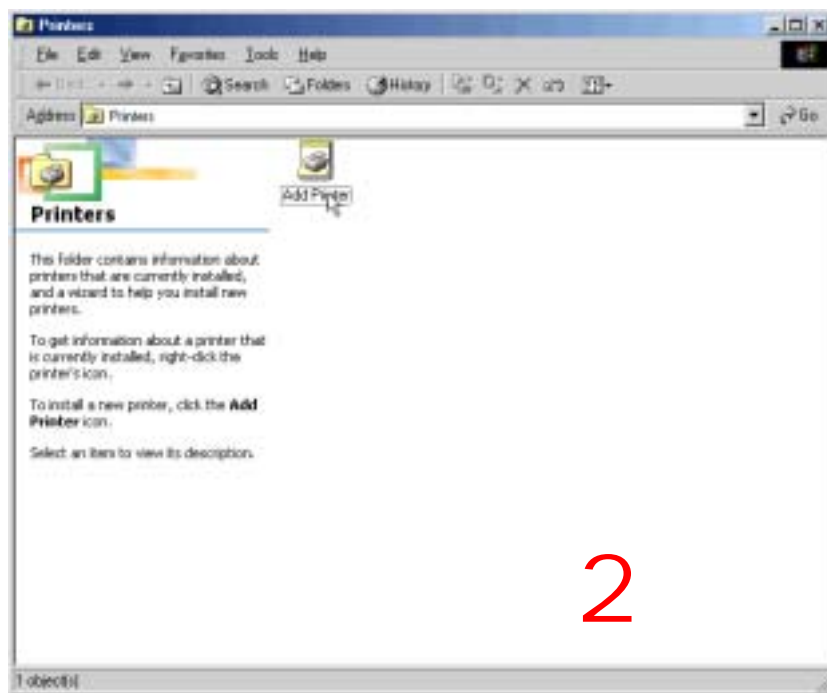

3. Follow the on-screen instruction and click “Next”.

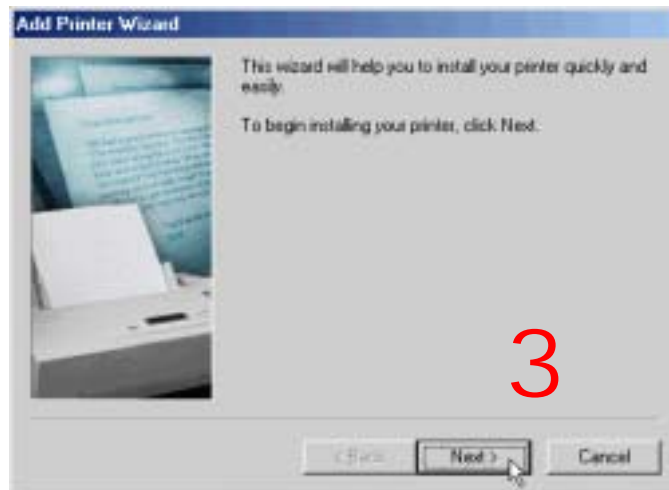

4. Choose “Network printer” and click “Next”.

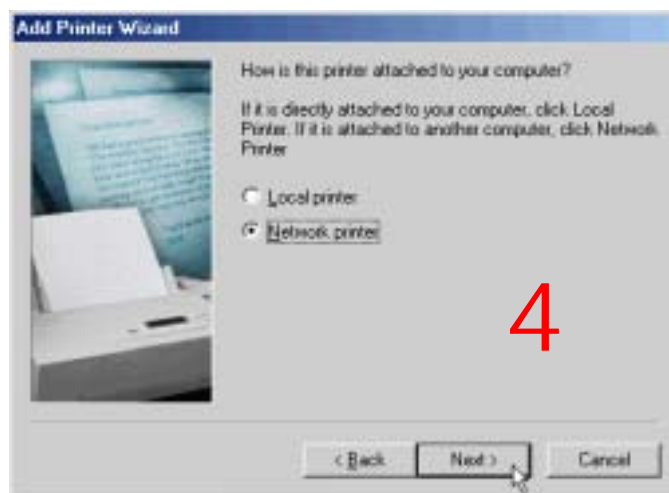

5. Enter the network path or queue name for the printer, or click on “Browse...” to view available network printers. If you enter a path or queue name, skip to step 7. Or you may click “Browse...” to locate the printer.



- Please find the Disk On-line Server within the network neighborhoods. Select the printer icon under your Disk On-line Server and click “OK”.

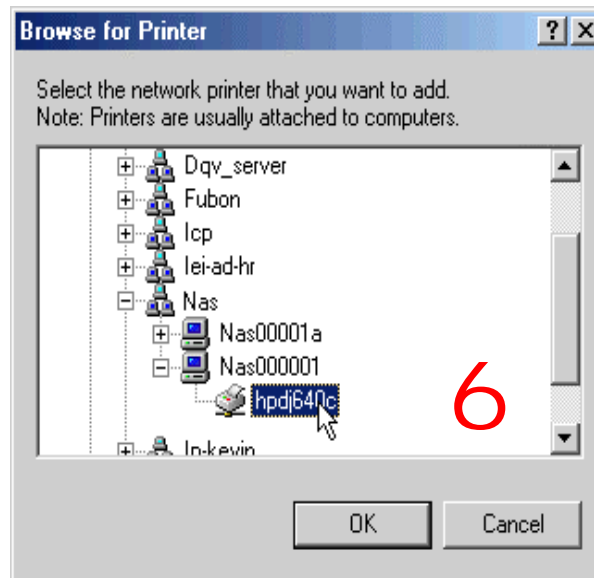

- Verify the network path and click “Next”.

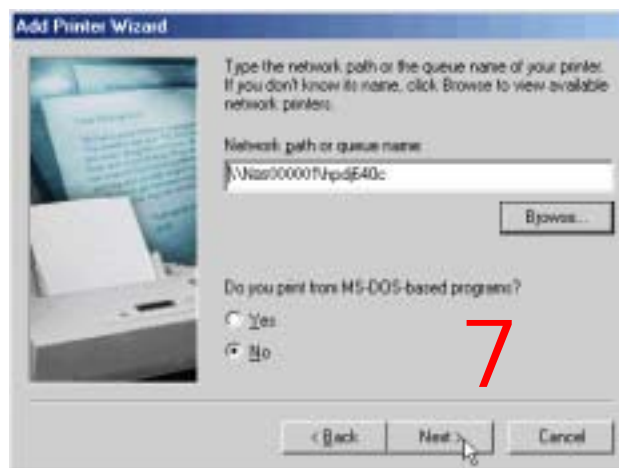

- You will be asked to choose the driver for your network printer. Please follow the on-screen instructions to install the driver.

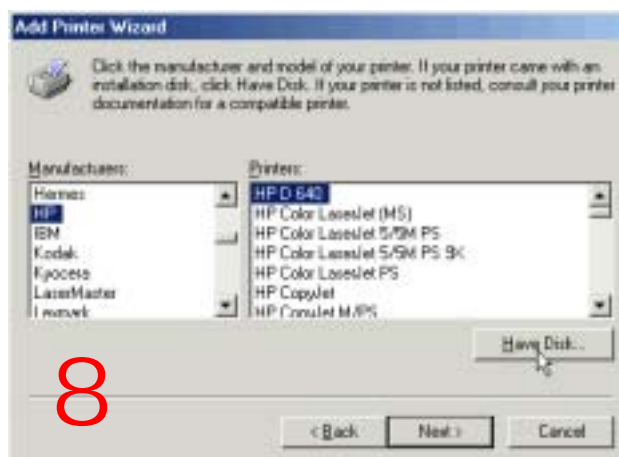

9. Enter the name for your printer and click “Next”.

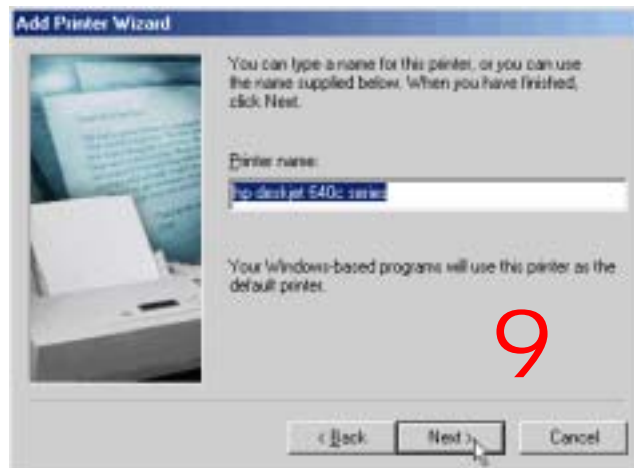

10. Click “Finish” to print a test page.

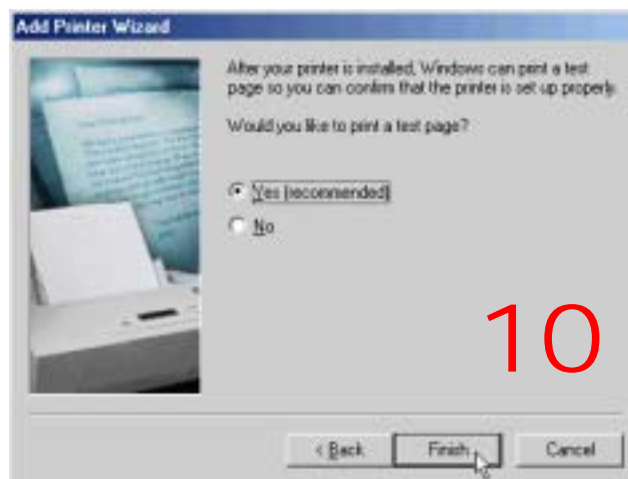

11. Please verify if the test page was printed successfully. If you find any problems, please consult the trouble-shooting guide or user’s manual of the printer.

Disk On-line Server - Maintenance

The Disk On-line Server has been specially designed to run on 24 hours, 7 days a week and to be ready at all times. It is also robust to protect against system crashes caused by power loss. This section provides a general maintenance overview.

Shutdown/Restart the Server

Please use the following steps to shutdown/restart the server:

1. Ask all the connected users to save their working files and stop using the Disk On-line Server.
2. Open the administration web page and go to **System Tools · Restart/Shutdown**. Follow the instructions to restart or shutdown the system.

Reset the Administrator Password & Network Settings

If you accidentally forget the administrator password, you will not be able to perform any administration work on the Disk On-line Server. Under this condition, you can reset the administrator password and network configuration to the factory default.

1. Use the tip of a ball point pen and depress the configuration reset switch located on the back of the Disk On-line Server. Hold it for about 5 seconds until the beep.
2. The network configuration will be reset, and you may need to re-configure some or all of the network settings before you can connect to the Disk On-line Server.
3. Use a web browser to connect to the Disk On-line Server. Enter the **System Administration** and enter the following login name and password.

Login:	Administrator
Password:	admin

You can then perform system administration.

Note: If the configuration reset switch is disabled in the **System Tools · Hardware Settings** page, you are no longer able to use this function. Please remember your administrator password.

Disk Failure or Malfunction

If you are suffering from a disk failure or malfunction, please do the following:

1. Log all abnormal events or messages for technician's reference.
2. Stop all operations of the Disk On-line Server and power it off.
3. Contact the customer service for technical support.

Note: Your Disk On-line Server must be repaired by a trained technician. Please do not try to repair the Disk On-line Server on your own.

Power Outage or Abnormal Shutdown

In the event of power outage or abnormal shutdown of the Disk On-line Server, the system should return to its original state prior to shutdown or power outage after restart. If the system is not operating within normal parameters, please proceed with the following steps:

1. In the event of system configuration setting lost during power outage or abnormal shutdown, please manually reset your desired configurations.
2. In the event of abnormal operation or an error message, please contact customer service for support.

To prevent similar occurrences, we suggest that you periodically backup all critical files or folders and remember the following tips:

1. Follow **Shutdown/Restart the Server** steps described above for normal shutdown or restart.
2. If you are able to anticipate power outage, please backup all critical files or folders prior to power outage and shutdown your server normally. Restart your server once the power has returned to normal.

To prevent major data lost of data in the event of a disk failure, please back up your data periodically.

Appendix A LCD Panel

Displayed Information

After system powers on, the following information is displayed on the LCD panel:

NAS-2108R / NAS-2108RW / NAS-104R

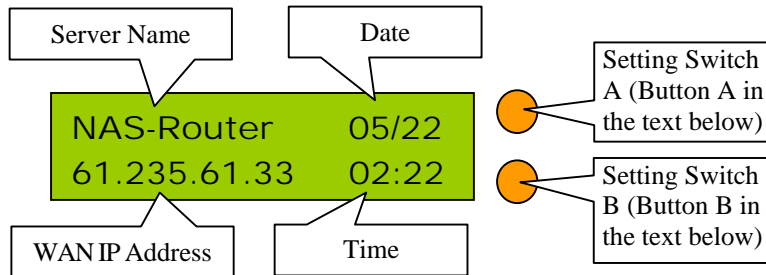

NAS-101R / NAS-101RW

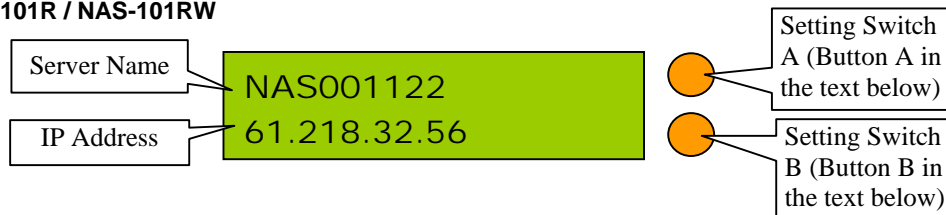

Checking IP Address, System and Disk Information

Press B to display the internal IP addresses of this Disk On-line Server in the local network. Computers connected to the LAN ports can access the Disk On-line Server via this IP address.

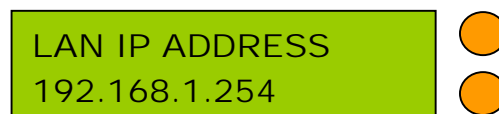

Click on B again to show the available disk space. Please note that this is actually the entire amount of disk space, and not the amount of space that you can use.

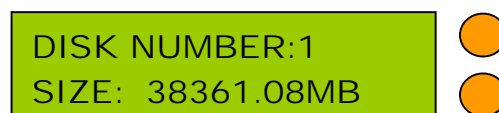

Click B again to display the model number and version information as shown below:

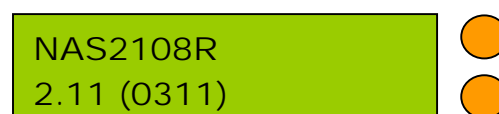

System Setup Function

- **Entering a System Page**

1. Press the switch A for two seconds to enter System Setting.
2. Press the switch B for selection options.
3. Press the switch A to enter the selection options.

- **NETWORK SETTINGS**

After enter the Network Settings menu, please press the switch B to choose DHCP or Static IP.

1. **DHCP** - Obtain IP Address Automatically

The Disk On-line Server will automatically obtain the IP address settings via DHCP protocol.

2. **STATIC IP** - Specify Static IP Address

Press the switch A to select STATIC IP and complete the following steps:

- *SET STATIC IP*

Press the switch B to set the IP address settings (press the switch B to select the number 0~25). Press the switch A for the next number.

- *SET NETMASK*

Follow the same procedure as above.

- *SET GATEWAY*

Follow the same procedure as above.

- *SELECT STATIC IP*

Press the switch B to select YES or NO and confirm by pressing the switch A. NO will return to the Network Settings menu.

- *RESTART SYSTEM*

You need to restart the system to make changes effective. Press the switch B to select YES or NO and press the switch A to confirm.

- **POWER DOWN**

Press the switch A to shutdown the system.

- **REBOOT SYSTEM**

Press the switch A to reboot the system.

- **EXIT**

Press the switch A to exit the settings menu.

Appendix B Web File Manager

Using Web File Manager

Start your web browser and enter your Disk On-line Servers home page. Select **Web File Manager** and enter the correct login name and password. You may also enter “guest” in the login name field with no password to access the network shares on the Disk On-line Servers as an anonymous guest.

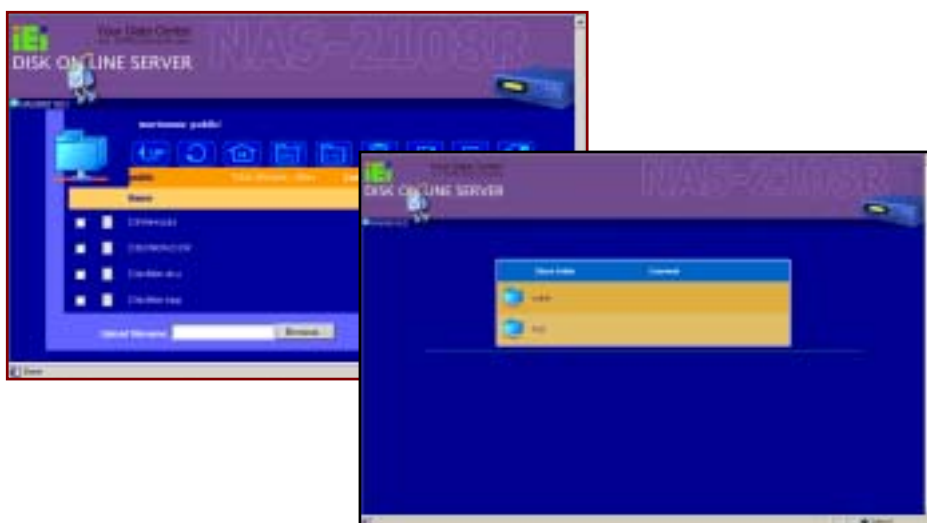

The Disk On-line Servers allows you to organize your network share folders on-line. You can save these files inside folders as well as rename and remove files or folders.

- **How to View Files On-line**

Click on a file displayed on the web page. The file's data are displayed on the browser. If your browser does not support the file format, the download window pops up automatically. Once the file is downloaded, you can open it on your computer.

- **How to Create Folders**

1. Enter the folder that you want to create the new folder.
2. On the tool bar, click on  (Create Folder).
3. Enter the name of the new folder and confirm.

- **Renaming Files or Folders**

1. Select the file or folder you want to rename.
2. On the tool bar, click on  (Rename).
3. Enter the new file or folder name and confirm.

- **Deleting Files or Folders**

1. Check the file(s) or folder(s) you wish to delete.

2. On the tool bar, click on  (Delete).
3. A window appears. Click on OK to delete the selected file or folder.

To delete all files and folders, click on  (Select All), then click on  (Delete).

- **Uploading**

1. Enter the folder of the file you want to upload.
2. Click on “Browse...” to select the file you want to upload.
3. Click on “Upload”.

- **Downloading**

1. Click the right mouse button on the file which you want to download.
2. A context menu appears. Click on “Save Target As...” to download the file.

- **Logging Out Web File Manager**

On the tool bar, click on  (Logout) to leave the web file manager.

Web File Manager Icon



Up - go back to the parent folder



Refresh – reload the current page



Home - go back to the network shares list home page



Create Folder – create a new folder



Rename – rename the selected file or folder



Delete – remove the selected file(s) or folder(s)



Select All – select all files and folders



Select None – cancel all selection

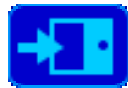

Logout – leave the web file manager



Full access network share folder



Read-only network share folder



Malfunction network share folder

Appendix C Quick Install Wizard

Introduction

The Quick Install Wizard enables you to list the Disk On-line Servers within your local network and display basic information such as server names, workgroups and IP addresses. You may also set up the server name, date/time and basic network configuration of the Disk On-line Server via this program.

Screenshot

The screenshot shows the 'Quick Install Wizard' window. At the top, there is a title bar and a logo for 'iEi' with the website 'www.iei.com.tw'. Below the logo, the text 'Disk On-line Server' is displayed. The main area contains a table with the following data:

Name	IP Address	Workgroup
LisaChiang	192.176.0.1	RMA
NAS00009C	172.16.13.193	NAS
eric huang	172.16.13.76	NAS
DQV-NAS	172.16.14.182	NAS
NAS39002C	172.16.14.167	NAS
NAS000004	172.16.13.108	NAS
NAS00009E	172.16.13.82	NAS
Teddy Kuo	172.16.13.174	Teddy NAS
DQV-2	172.16.14.125	NAS
DQV_TEST	172.16.14.107	NAS
Home	172.16.14.133	NAS
NAS0000A3	172.16.13.79	NAS

At the bottom of the window, there are five buttons: 'Configure', 'Details', 'Refresh', 'Help', and 'Exit'. The 'Configure' button is highlighted.

Callouts provide the following information:

- All Disk On-line Servers can be identified using a unique server name.
- Indicates the IP address of the server.
- Shows the Windows workgroup joined by the Disk On-line Server.
- Set up Server Name, Date / Time and basic network configurations.
- View detailed information about the selected server.
- Re-search for Disk Online Servers in the network.
- Display on-line help for Quick Install Wizard.
- Configuration complete; exit program.

Operation Help

1. Set up your Disk On-line Server:

Select the Disk On-line Server that you want to configure, and then click on the Configure button. An authentication window asking you to enter the administrator's password appears as shown below:

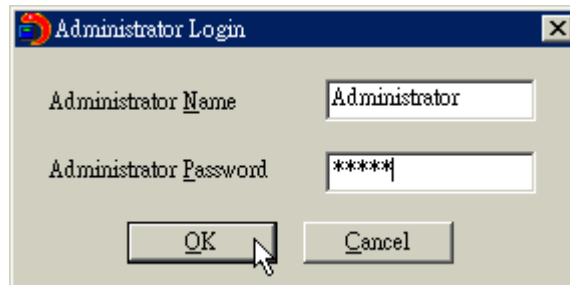

Click on OK after entering the password. If the name and password are correct, the configuration window is displayed on the screen:

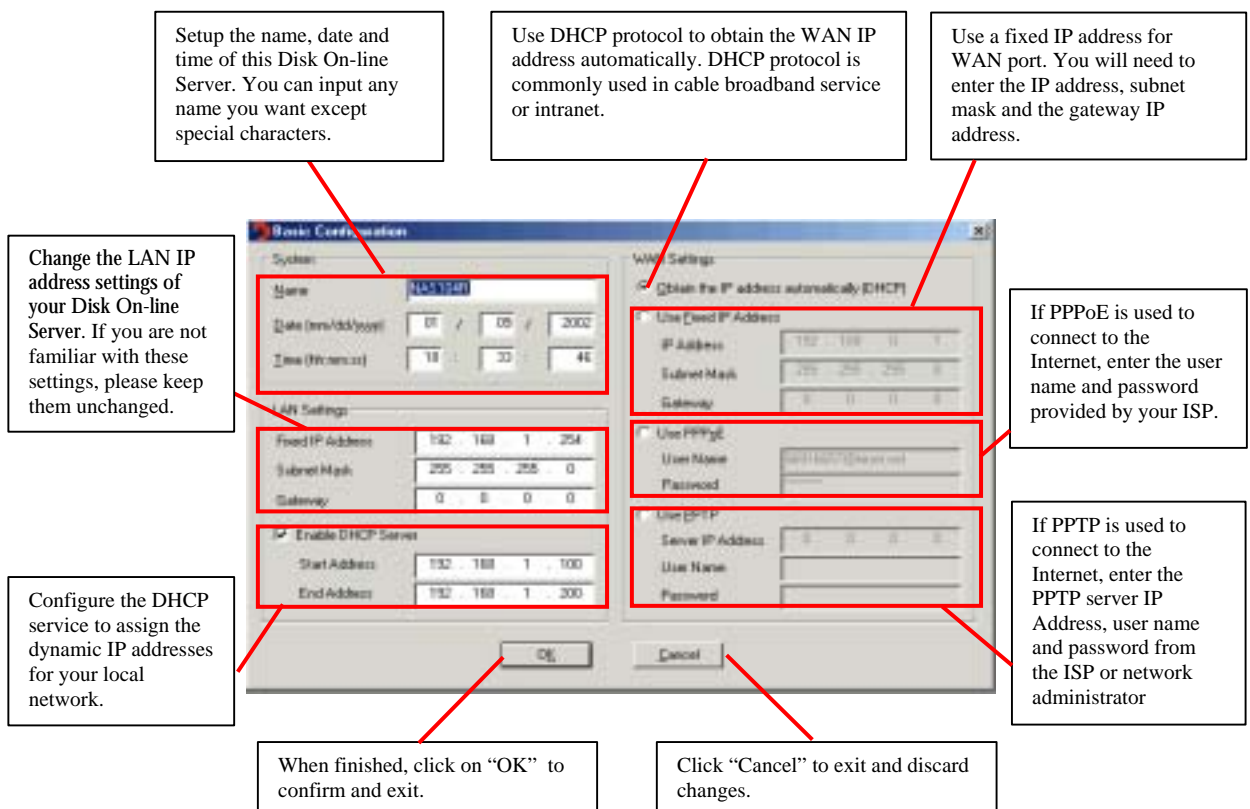
A screenshot of the 'Disk Configuration' dialog box with several callout boxes pointing to specific settings. The dialog box has a title bar with a red 'X' icon and the text 'Disk Configuration'. It is divided into several sections: 'System' (Name, Date, Time), 'LAN Settings' (Fixed IP Address, Subnet Mask, Gateway, Enable DHCP Service, Start Address, End Address), and 'WAN Settings' (Use DHCP, Use Fixed IP Address, IP Address, Subnet Mask, Gateway, Use PPPoE, User Name, Password, Use PPTP, Server IP Address, User Name, Password). At the bottom are 'OK' and 'Cancel' buttons. Callout boxes provide instructions for each section: 'System' (Setup the name, date and time...), 'LAN Settings' (Change the LAN IP address settings...), 'WAN Settings - DHCP' (Use DHCP protocol to obtain the WAN IP address...), 'WAN Settings - Fixed IP' (Use a fixed IP address for WAN port...), 'WAN Settings - PPPoE' (If PPPoE is used to connect to the Internet...), 'WAN Settings - PPTP' (If PPTP is used to connect to the Internet...), and 'Buttons' (When finished, click on "OK" to confirm and exit. Click "Cancel" to exit and discard changes.)

Change the settings and click on OK when done to complete the configuration setup.

Note:

1. After changing some settings, you may be asked to restart the Disk On-line Server.
2. If you want to set up detailed configuration, you need to enter the administration web page of the Disk On-line Server via the browser.

For more configurations, check your browser under "System Administration"

2. Viewing detailed information on the Disk On-line Server:

Choose the Disk On-line Server by highlighting it with the mouse, then click on “Group Data” to display current settings and status as shown below:

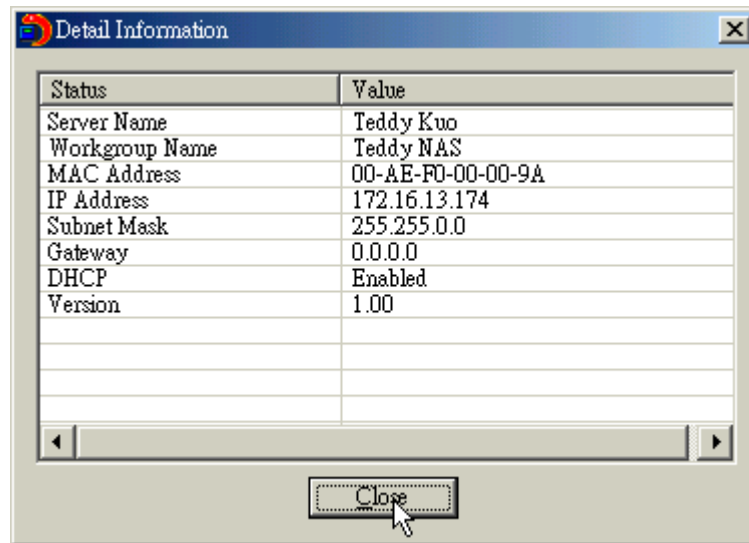

3. To find information on other Disk On-line Servers in the same network:

Click on “Refresh” in the Toolbar to find information on other Disk On-line Servers in the same network.

4. To display User Help File:

Click on “Help” display the Help file.

5. To enter the home page of the Disk On-line Server:

Double click on the name of the Disk On-line server to enter the web page for advanced administration.

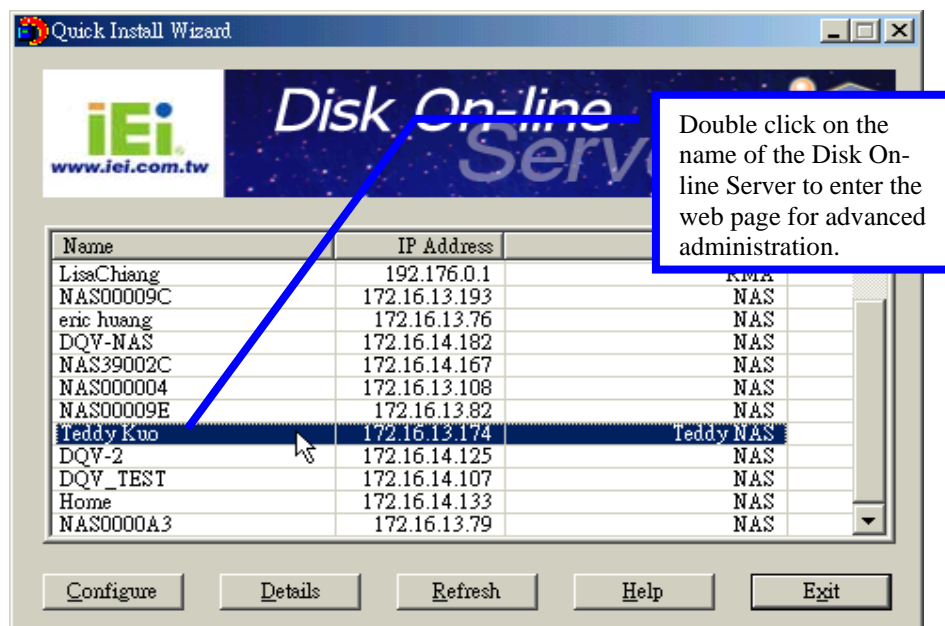

Appendix D

Registering a Dynamic Domain Name

Introduction

Your Disk On-line Server supports the DDNS service provided by DynDNS. You can go to the web site of DynDNS (<http://www.dyndns.org/>) and register for a dynamic domain name. Configure and activate the DDNS service, then the Internet users will be able to access your Disk On-line Server via this dynamic domain name. When the ISP assigns a new WAN IP address, the Disk On-line Server will update the new address to the DynDNS server automatically.

Registration Procedure

Please follow below steps to register a dynamic domain name:

Note: This guide is for reference only. If there are any changes, please refer to the instructions or documents on the web site.

- a. Open the browser and connect to <http://www.dyndns.org>. Click on “Sign Up Now” to begin the registration process.



b. Click on “Agree” if you accept the service agreement.

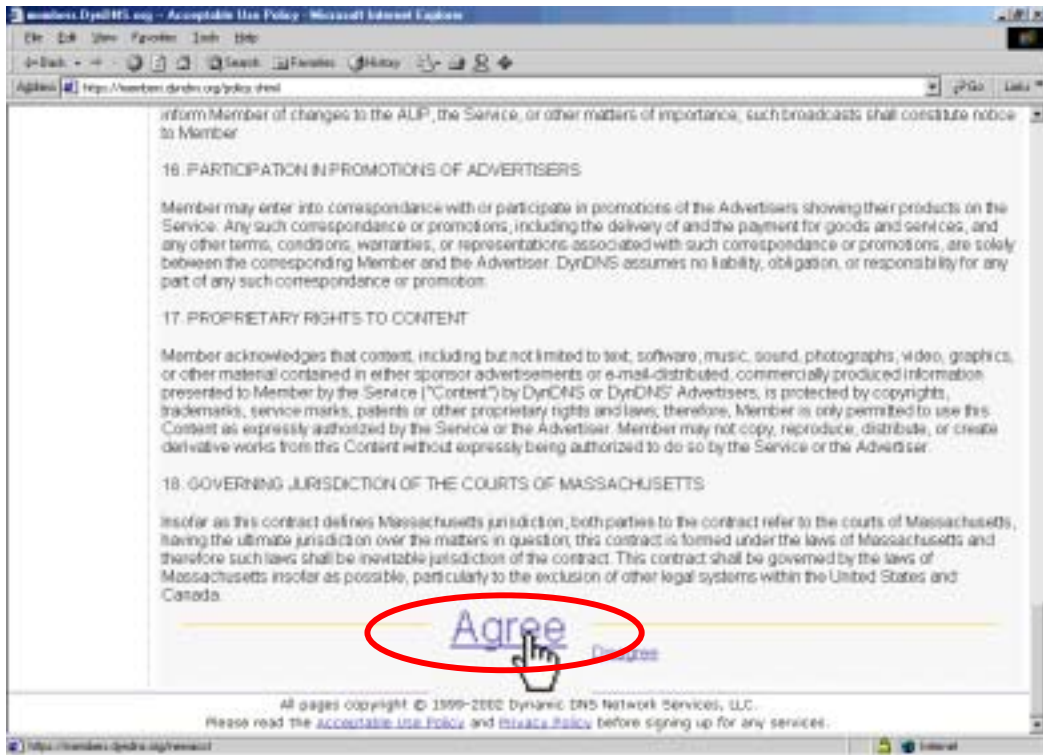

c. Enter the username, email address and password to create a DDNS service account. You will need to enter the same username and password in the **Network Settings . DDNS Service** page of the Disk On-line Server system administration. Please verify your email address to receive the confirmation message from the server. Then click on “Create Account” to proceed.

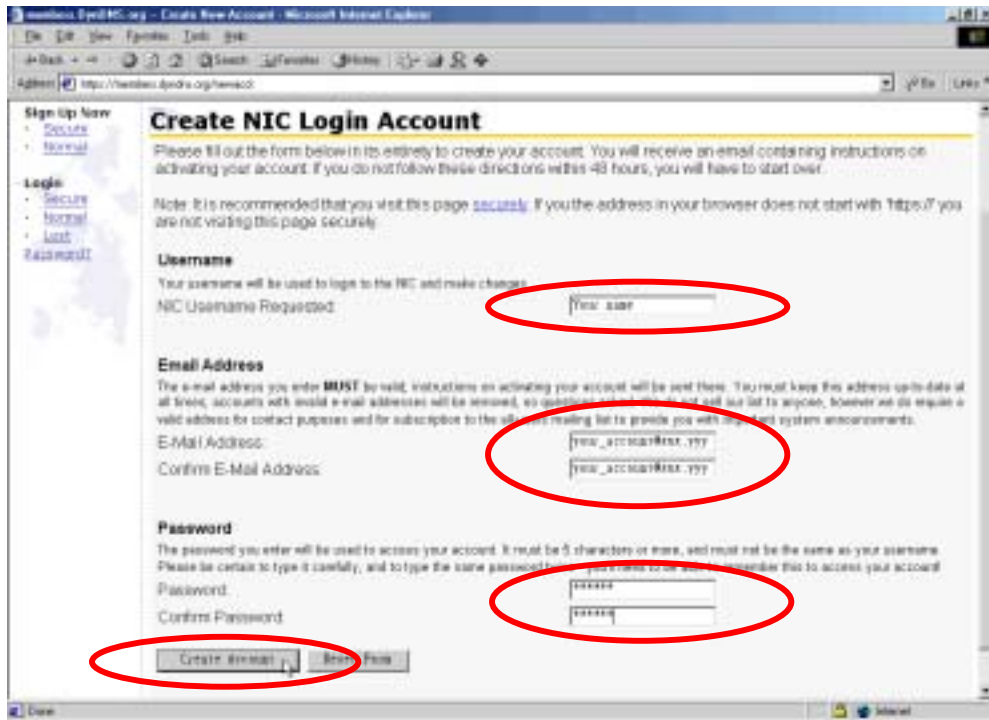

- d. If below web page appears on the screen, your account has been successfully created and a confirmation message has been sent to your -mail address. Please follow the instructions in the e-mail to activate your account within 48 hours.

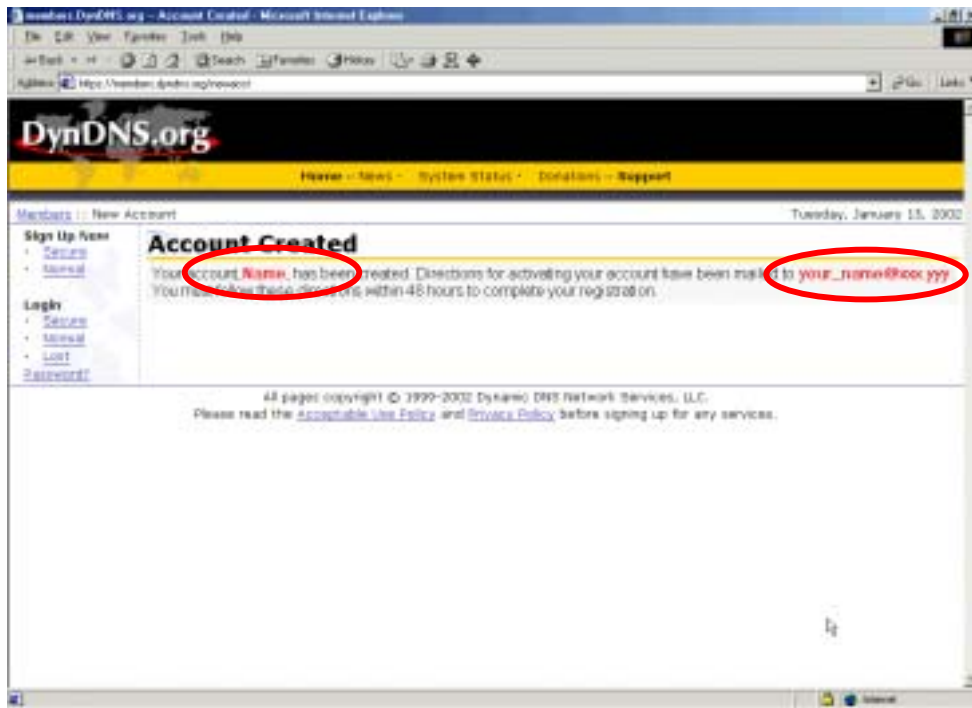

- e. When you have finished the process of confirmation, a new screen will appear and you can apply for your own dynamic domain name.

