

Document Revision History

- Revisions**
- Previous Edition: 2.0
 - Current Edition: 2.1
-

Reasons of change

The table below shows the reasons of the document change:

Change / Page	A (added) M (modified) R (removed)
Radiation Safety & FCC Statements	A

Equipment Disposal

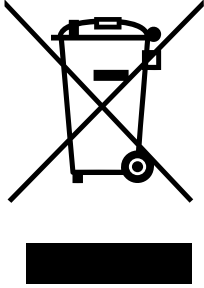

Disposal of old electrical and electronic equipment (applicable through the European Union and other European countries with separate waste collection systems).

This symbol, found on this product and any of its parts or on its operating instructions or on its packaging, indicates that electrical and electronic equipment may not be disposed of as unsorted municipal waste. Instead, this product should be handed over to applicable collection points for the recycling of electrical and electronic equipment.

By ensuring the correct disposal of this product, you will help prevent potential negative consequences to the environment and human health, which could otherwise be caused by inappropriate disposal of this product.

By recycling, reusing and other forms of recovery of old electrical and electronic equipment you are making an important contribution to the conservation of natural resources and to the protection of the environment.

For more information about the recycling of this product, please contact your local municipal authorities, municipal waste disposal service or the store where you purchased this product.

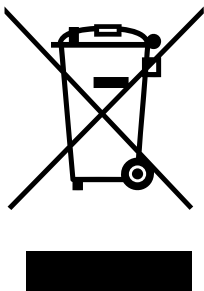

Απόρριψη παλαιών ηλεκτρικών και ηλεκτρονικών συσκευών (ισχύει στην Ευρωπαϊκή Ένωση και άλλες Ευρωπαϊκές χώρες με συστήματα χωριστής συλλογής απορριμμάτων).

Το σύμβολο αυτό, που απεικονίζεται πάνω στο προϊόν και σε τυχόν εξαρτήματα του ή στο εγχειρίδιο οδηγιών του ή στη συσκευασία του, δείχνει ότι οι ηλεκτρικές και ηλεκτρονικές συσκευές, μετά το πέρας της λειτουργίας τους, δεν θα πρέπει να απορρίπτονται μαζί με τα αστικά απόβλητα. Αντίθετα θα πρέπει να παραδίδονται σε κατάλληλα σημεία συλλογής για την ανακύκλωση των ηλεκτρικών και ηλεκτρονικών συσκευών.

Διασφαλίζοντας τη σωστή απόρριψη αυτού του προϊόντος, συνεισφέρετε στην πρόληψη πιθανών αρνητικών συνεπειών στο περιβάλλον και την ανθρώπινη υγεία, οι οποίες θα μπορούσαν να προκληθούν από την μη ενδεδειγμένη απόρριψη του προϊόντος.

Η ανακύκλωση, επαναχρησιμοποίηση και άλλες μορφές αξιοποίησης των παλαιών ηλεκτρικών και ηλεκτρονικών συσκευών βοηθούν στη διαφύλαξη των φυσικών πόρων και στην προστασία του περιβάλλοντος.

Για περισσότερες πληροφορίες σχετικά την ανακύκλωση αυτού του προϊόντος, παρακαλούμε επικοινωνήστε με τις τοπικές δημοτικές αρχές, την υπηρεσία αποκομιδής αστικών αποβλήτων ή το κατάστημα από το οποίο αγοράσατε το συγκεκριμένο προϊόν.

Για περισσότερες πληροφορίες, μπορείτε να επικοινωνείτε με το Συλλογικό Σύστημα Εναλλακτικής Διαχείρισης Αποβλήτων Ηλεκτρικού και Ηλεκτρονικού Εξοπλισμού "Ανακύκλωση Συσκευών Α.Ε." (www.electrocycle.gr).

Declaration of Conformity

Hereby, Intracom S.A. Telecom Solutions declares that the product **StreetNode™ 6250 PTP** is CE marked, complying with the requirements of the R&TTE Directive 1999/5/EC , EMC Directive 2004/108/EC, LVD Directive 2006/95/EC, ECO Design Directive 2009/125/EU & with the requirements of the RoHS Directive 2011/65/EU.

The product complies to all relevant FCC regulations.

For further information, please refer to [Appendix E: Standards of Compliance](#) on page [81](#).

Δήλωση Συμμόρφωσης

Με την παρούσα, η Intracom A.E. Τηλεπικοινωνιακών Λύσεων δηλώνει ότι το προϊόν **StreetNode™ 6250 PTP** φέρει την σήμανση CE συμμορφούμενο προς τις απαιτήσεις και τις λοιπές διατάξεις των οδηγιών R&TTE 1999/5/EC, EMC 2004/108/EC, LVD 2006/95/EC, ECO Design 2009/125/EU καθώς και με τις απαιτήσεις της οδηγίας RoHS 2011/65/EU.

Το προϊόν συμμορφώνεται σε όλους τους σχετικούς κανονισμούς της Ομοσπονδιακής Επιτροπής Τηλεπικοινωνιών της Ηνωμένων Πολιτειών Αμερικής (FCC).

Για περισσότερες πληροφορίες παρακαλώ δείτε το παράρτημα [Appendix E: Standards of Compliance](#) στην σελίδα [81](#).

Radiation Safety

Introduction

Any radio equipment is emitting Radio Frequency (RF) radiation through its antenna.

In the StreetNode™ 6250 PTP radio, the antenna is integrated and located inside the unit's enclosure.

It is important to follow any local, national or international regulation during installation and operation of the radio equipment to minimize radiation hazards.

Regulations

Many countries have issued and follow their own RF safety regulations, while many others have adopted international regulations, standards or guidelines.

In Europe, some countries follow the recommendations included in the 1999/519/EC directive, which is based on the guidelines document published by the International Commission on Non-Ionizing Radiation Protection (ICNIRP).

The above mentioned European directive provides the reference levels (limits) for assessment of the human exposure to electromagnetic fields based on health effects. Other regulators may define different reference levels.

The European Union and U.S. regulator (FCC) Reference Levels for the microwave frequencies are given below:

Regulation	Frequency, GHz	Electric Field Strength	Power Flux density	Notes
1999/519/EC	2.0 – 300	61 V/m	10 W/m ²	General Public
FCC OET 65	1.5 – 100	-	1 mW/cm ² (10 W/m ²)	General Public
FCC OET 65	1.5 – 100	-	5 mW/cm ² (50 W/m ²)	Occu-pational

Continued on next page

Radiation Safety, Continued

**General
installation
guidelines
(RF exposure)**

As a general rule, it is expected that the highest level of emission would be at the antenna emission lobe maximum, in direct line-of-sight condition and in the close vicinity of the antenna.

Additional requirements for the installation of the StreetNode™ 6250 PTP radio shall be as follows:

- The radio should be located in such a way to prevent the public from accessing the area where the RF radiation exceeds the regulation limits. For this, a compliance boundary is determined, based on its radio characteristics. Outside this area, the RF radiation levels are below the reference levels (limits).
- Operation and maintenance personnel, which have to work within the RF radiation compliance boundary area, should be informed about the source of radiation and should have the capability to power off the radio equipment before entering the compliance boundary area.
- The compliance boundary area should be defined by a relevant warning sign or physical barrier.

Continued on next page

Radiation Safety, Continued

Compliance boundary definition

The Compliance Boundary Definition for StreetNode™ 6250 PTP is shown to the following table below:

Parameter	Value			
Max EIRP	40,0	<i>dBm</i>	10,0	<i>W</i>
Max EIRP (worst case conditions)	~47,0	<i>dBm</i>	~50,00	<i>W</i>
Power Flux Density Limit (General Public)	10,0	<i>W/m²</i>		
Compliance Boundary (General Public)	0,64	<i>m</i>		
Power Flux Density Limit (Occupational)	50,0	<i>W/m²</i>		
Compliance Boundary (Occupational)	0,29	<i>m</i>		



The above calculations are based on information available at the time of issue of the current document.



RF exposure compliance boundary studies / reports are available upon request.

References

- 1999/519/EC, COUNCIL RECOMMENDATION of 12 July 1999 *on the limitation of exposure of the general public to electromagnetic fields (0 Hz to 300 GHz).*
- OET Bulletin 65, *Evaluating Compliance with FCC Guidelines for Human Exposure to Radiofrequency Electromagnetic Fields*, Edition 97-01, August 1997.
- *GUIDELINES FOR LIMITING EXPOSURE TO TIME-VARYING ELECTRIC, MAGNETIC, AND ELECTROMAGNETIC FIELDS (UP TO 300 GHz)*, International Commission on Non-Ionizing Radiation Protection (ICNIRP), 1998

FCC Part 15.19 Statement: Information to the User

This device complies with Part 15 of the FCC Rules. Operation is subject to the following two conditions:

- (1) this device may not cause harmful interference, and
 - (2) this device must accept any interference received, including interference that may cause undesired operation.
-

FCC Part 15.21 Statement: Information to the User

Changes or modifications made to this equipment, not expressly approved by the party responsible for compliance, could void the user's authority to operate the equipment.

FCC Part 15.105 Statement: Information to the User

This equipment has been tested and found to comply with the limits for a Class A digital device, pursuant to part 15 of the FCC rules.

These limits are designed to provide reasonable protection against harmful interference when the equipment is operated in a commercial environment.

This equipment generates, uses, and can radiate radio frequency energy and, if not installed and used in accordance with the instruction manual, may cause harmful interference to radio communications.

Operation of this equipment in a residential area is likely to cause harmful interference in which case the user will be required to correct the interference at his own.

Integrated Bluetooth Module FCC ID

The unit contains a certified Bluetooth Module.

The end user has no access to this module.

The FCC ID of the internal Bluetooth module can be found after the phrase "Contains FCC ID" on the label displaying the FCC IDs related to the unit.

This label is visible on the side of the unit.

Table of Contents

Table of Contents	1
1. Introduction	3
About this Document	3
2. Prior to Installation	4
List of Materials	4
Connections	16
Equipment Anchor Points	20
Safety Precautions	21
Site Prerequisites	24
Cable Length Restrictions	33
Antenna Hydrophobic Coating Protection	37
Recommended Tools	38
3. Installation of StreetNode 6250 PTP	41
Mechanical Installation & Grounding	41
Installation of Traffic Cable(s)	52
Installation of Power Cable (Direct Powering)	58
Installation of Power Injector (Power over Ethernet)	60
Appendix A: Terminating Ethernet (S-FTP) Cable	67
Appendix B: Terminating Power Supply Cable	75
Appendix C: Terminating Grounding cable	76
Appendix D: Removing StreetNode 6250 PTP	78
Appendix E: Standards of Compliance	81

(Page intentionally left blank)

1. Introduction

About this Document

Scope of document

This document is the Installation & Cabling Manual of **StreetNode™ 6250 PTP : Point-to-Point all-outdoor Gigabit Radio 60 GHz**.

Target Audience

This document is addressed to certified technicians with wireless equipment knowledge and skills concerning the following:

- Outdoor Radio Unit Installation (Lamp Post or Building Wall).
 - Preparation & Termination of: Ethernet, Power & Grounding cables.
 - Laying and Installing of: Ethernet, Power, Grounding & Fiber Optic Cables.
 - Testing Ethernet cables using Ethernet testers.
-

Reference manuals

Other necessary information about product features and set-up can be found in the related product documents :

Item	Product Documents Description
1	StreetNode™ 6250 PTP System Description
2	StreetNode™ 6250 PTP Start Up & Commissioning Manual
3	StreetNode™ 6250 PTP Node Manager - Reference Manual
4	StreetNode™ 6250 Release Notes

Conventions

This document applies the following conventions:

- Bold font is used when describing something very important.
- Blue bold font is used for order codes.
- Blue underline font is used when describing references.



This symbol means **DANGER**. The purpose of this symbol is to warn you that any wrong action can cause bodily injury or even death.



This symbol means **CAUTION**. The purpose of this symbol is to prevent you from performing an action that might result in damage or serious malfunction of the equipment.



A note denotes attention to important supplementary information.



A hint denotes helpful piece of advice or practical suggestion.

2. Prior to Installation

List of Materials

Topics

This section includes the following topics:

- Packing list materials
- Powering materials
- Grounding materials
- Data traffic materials
- Pole fastening materials

Continued on next page

List of Materials, Continued

Packing list materials

The packing list of the radio equipment includes the following items:

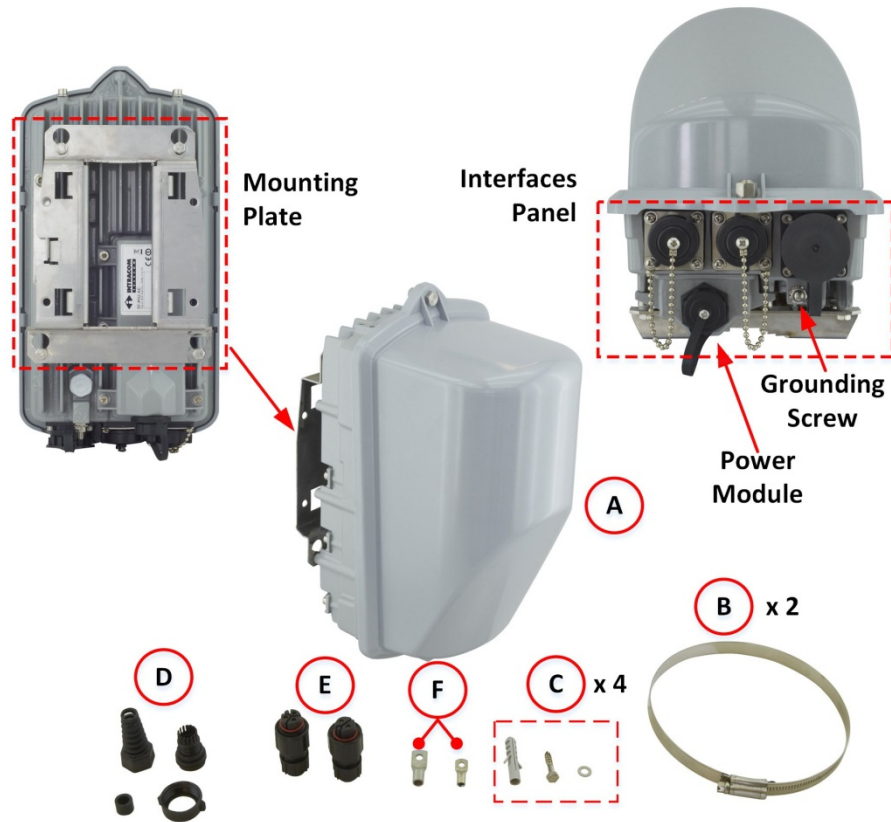

Order Code	Item	Description
SN62-XXXXXX	A	StreetNode™ 6250 PTP radio unit with attached mounting plate & safety screw.
	B	Pair of steel hose clamps to fasten the radio unit onto a pole of 60 mm to 114 mm diameter ⁽¹⁾ .
	C	4 x screws and upats for wall installation.
	D	Gland for RJ-45 connector, IP67 class (ETH-HOOD).
	E	AC power connector, three terminals, solder type, IP68, UV-rated, industrial type (ST-CONN-AC). (For radio unit equipped with the AC power module) <u>OR</u> DC power connector, two terminals, solder type, IP68, UV-rated, industrial type (ST-CONN-DC). (For radio unit equipped with the DC power module)
	F	Ring terminals (lugs) (M5, tinned copper) for 16mm ² and 6mm ² grounding cables.

Continued on next page

⁽¹⁾ For other available pole diameters, see [Steel hose clamps](#) on page [15](#).

List of Materials, Continued

Powering materials

The powering materials consist of the following categories:

- Power injectors
- Power cables
- Power modules & connectors

Power injectors

The following table shows the power injectors:

Item	Order Code / Photo	Description
A	<p>POE-ID-AC75</p> 	<p>PoE injector, indoor, -20°C to +40°C, 90 VAC to 264 VAC, 47 Hz to 63 Hz, 75 W. (AC power cord - EU plug⁽¹⁾ is included)</p>
B	<p>POE-IDH-AC56</p> 	<p>PoE injector, indoor, temperature hardened, -40°C to +60°C, 90 VAC to 264 VAC, 47 Hz to 63 Hz, 56 W. (AC power cord - EU plug is included)</p>
C	<p>PONE-OD-DC</p> 	<p>PonE injector, outdoor, wall mount⁽²⁾, -50°C to +65°C, 48 VDC, 60 W (4 x screws and upats, are included & an M3 grounding screw is pre-installed on the unit).</p>
D	<p>PONE-OD67-AC</p> 	<p>PonE injector, outdoor, wall mount, temperature hardened, -40°C to +55°C (operation), 90 VAC to 264 VAC, 47 Hz to 63 Hz, 70 W, IEC 60529 / IP67 class. Ethernet cable glands and power connector are included in the unit package. AC power cable should be ordered separately.</p> <ul style="list-style-type: none"> • For wall installation, 4 x screws and wall plugs are included in the unit package. • For pole installation, a bracket and accessories (INSTPONE-PL2) should be ordered. <p>For grounding requires GND-KIT16-OD (see page 9) For powering requires AC-PWR-CAB (see page 7)</p>





Continued on next page

⁽¹⁾ Other plug types can be made available upon customer request

⁽²⁾ For pole installation, a bracket and accessories (**INST-PONE-PL**) should be ordered

List of Materials, Continued

Power cables The following table shows the power cables:

Item	Order Code / Photo	Description
A	AC-PWR-CAB 	AC power bulk cable, 3 x 0.75 mm ² , 0.6 / 1 kV, stranded, UV-rated, industrial type, for outdoor use (per meter) ⁽¹⁾ (for distance between StreetNode™ 6250 PTP and local power source < 300 m).
B	ST-AC-CAB10 	AC power pre-fabricated cable, 10 m, terminated at radio unit side only (with ST-CONN-AC connector), 3 x 0.75 mm ² , 0.6 / 1 kV, stranded, UV-rated, industrial type, for outdoor use. Limited quantities for use in trials.
C	DC-PWR-CAB-1 	DC power bulk cable, 2 x 1 mm ² , 0.6 / 1 kV, stranded, UV-rated, industrial, for outdoor use (per meter) ⁽²⁾ (for distance between StreetNode™ 6250 PTP and local power source < 100 m).
D	ST-DC-CAB1 	DC power pre-fabricated cable, 1 m, terminated at radio unit side only (with ST-CONN-DC connector), 2 x 1 mm ² , 0.6 / 1 kV, stranded, UV-rated, industrial type, for outdoor use. Limited quantities for use in trials.
E	DC-PWR-CAB-2 	DC power cable, 2 x 2.5 mm ² , PVC, 1KV, for outdoor use (per meter). The following cable is used for: <ul style="list-style-type: none"> • Direct DC powering of StreetNode™6250 PTP <u>when distance from the local DC power supply source is from 100 m to 300 m⁽³⁾</u> Connecting the power injector (if existing) with the local DC power supply source (StreetNode™ 6250 PTP)

Continued on next page

⁽¹⁾ The **ST-CONN-AC** connector required for the cable termination is included in the radio equipment package.

⁽²⁾ The **ST-CONN-DC** connector required for the cable termination is included in the radio equipment package.

⁽³⁾ In this case, connection to the radio unit connector is via a short cable tail made with the 2 x 1 mm² cable (**DC-PWR-CAB-1** order code or the pre-fabricated cable with **ST-DC-CAB1** order code).

List of Materials, Continued

Power modules & connectors

The following table shows the power modules & connectors:



All StreetNode™ 6250 PTP models are provided by the manufacturer with an AC or a DC power module pre-installed on them.

However, the power modules can be ordered separately and installed on the radio unit by the customer, if power input modification is required. ⁽¹⁾



An AC or DC power connector is included in the radio equipment package depending on the power module pre-installed on the radio unit (AC power module or DC power module, respectively).

However the power connectors can also be ordered separately if required.

Item	Order Code / Photo	Description
A	ST-PSU-AC 	AC power module, 90 VAC to 240 VAC, outdoor, IP67 ingress protection.
B	ST-PSU-DC 	DC power module, outdoor, IP67 ingress protection.
C	ST-CONN-AC 	AC power connector, three terminals, solder type, IP68 ingress protection, UV-rated, industrial type. For use with the 3 x 0.75 mm ² cable (AC-PWR-CAB order code).
D	ST-CONN-DC 	DC power connector, two terminals, solder type, IP68 ingress protection, UV-rated, industrial type. For use with the 2 x 1 mm ² cable (DC-PWR-CAB-1 order code).

Continued on next page

⁽¹⁾ The customer needs to be trained to perform power module replacement.

List of Materials, Continued





Grounding materials

Grounding cables for indoor and outdoor installation are available depending on the installation premises requirements.

In each case, two wire gauges are available:

- 16mm² cable is used for units installed on structures where lightning strike is possible (rooftop, telecommunication towers etc.).
- 6mm² cable is used for units installed in structures and locations where lightning strike is not considered possible.

The following table shows the grounding materials:

Item	Order Code / Photo	Description														
A	<p style="text-align: center;">GND-KIT16-OD</p> 	<p>Grounding kit of StreetNode™ 6250 PTP radio unit:</p> <table border="1" style="width: 100%; border-collapse: collapse;"> <thead> <tr> <th style="text-align: left;">No</th> <th style="text-align: left;">Description</th> </tr> </thead> <tbody> <tr> <td>1</td> <td>16 mm² cable, stranded, green / yellow, 450 V (2 m).</td> </tr> <tr> <td>2</td> <td>M8 screws (2), nuts (2), washers (2), lock washers (6) & tie wrap.</td> </tr> <tr> <td>3</td> <td>M8 Ring Terminal.</td> </tr> <tr> <td>4</td> <td>M5 Ring Terminal.</td> </tr> <tr> <td>5</td> <td>Heat shrinkable tube, black, d= 9.5 mm / 4.8 mm.</td> </tr> <tr> <td>6</td> <td>Terminal pin, AWG6, non insulated.</td> </tr> </tbody> </table>	No	Description	1	16 mm ² cable, stranded, green / yellow, 450 V (2 m).	2	M8 screws (2), nuts (2), washers (2), lock washers (6) & tie wrap.	3	M8 Ring Terminal.	4	M5 Ring Terminal.	5	Heat shrinkable tube, black, d= 9.5 mm / 4.8 mm.	6	Terminal pin, AWG6, non insulated.
No	Description															
1	16 mm ² cable, stranded, green / yellow, 450 V (2 m).															
2	M8 screws (2), nuts (2), washers (2), lock washers (6) & tie wrap.															
3	M8 Ring Terminal.															
4	M5 Ring Terminal.															
5	Heat shrinkable tube, black, d= 9.5 mm / 4.8 mm.															
6	Terminal pin, AWG6, non insulated.															
B	<p style="text-align: center;">GND-CAB6-ID</p> 	Indoor grounding cable, 6 mm ² , stranded, green / yellow, 450 V (per meter).														
C	<p style="text-align: center;">GND-CAB6-OD</p> 	Outdoor grounding cable, 6 mm ² , stranded, BLK, UV-rated, 0.6 / 1 kV (per meter).														
D	<p style="text-align: center;">GND-CAB16-ID</p> 	Indoor grounding cable, 16 mm ² , stranded, green / yellow, 450 V (per meter).														
E	<p style="text-align: center;">GND-CAB16-OD</p> 	Outdoor grounding cable, 16 mm ² , stranded, BLK, UV-rated, 0.6 / 1 kV (per meter).														

Continued on next page

List of Materials, Continued

Data traffic materials



The data traffic materials consist of the following categories:

- S-FTP cables
- Fiber optic cables
- SFP

Continued on next page

List of Materials, Continued

S-FTP cables The following table shows the S-FTP cables, accessories and kits:

Item	Order Code / Photo	Description
A	ETH-CAB-SFTP 	Ethernet cable S-FTP, 4x2xAWG24, CAT5e, shielded, BLK, UV-rated (per meter).
B	ST-RJ45 	RJ-45 connector, shielded, for S-FTP cable termination.
C	ETH-HOOD 	Gland for RJ-45 connector, IP67 class. ⁽¹⁾
D	CRIMP-TOOL-S 	Hand crimping tool for RJ-45 connector (ST-RJ45 order code).
E	RELAY-CAB 	S-FTP Ethernet cable, 50 cm, both ends terminated with RJ-45 connectors (2 x ST-RJ45) & glands (2 x ETH-HOOD) (used to interconnect two radio units in relay application). Limited quantities for use in trials.
F	ST-SMC-CAB 	50 cm, one end terminated with RJ-45 connector (1 x ST-RJ45) & gland (1 x ETH-HOOD) (used to connect the radio unit to SMC (Small Cell)). Limited quantities for use in trials.

Continued on next page

⁽¹⁾ For equipping 2 x RJ-45 GbE interfaces per radio unit, an additional gland for RJ-45 connector needs to be ordered as the radio equipment package includes only one gland.

List of Materials, Continued

Fiber optic cables

The following table shows the fiber optic cables:

Order Code / Photo	Description	
FBROPTMM-025	25 m	
FBROPTMM-50	50 m	
FBROPTMM-100	100 m	
FBROPTMM-150	150 m	
FBROPTMM-200	Prefabricated, connectorized fiber optic cables for outdoor use, DX, 2 x LC / PC – LC / PC, available in Multi Mode (MM) & Single Mode (SM) in different lengths. ⁽¹⁾	
FBROPTSM-025		25 m
FBROPTSM-50		50 m
FBROPTSM-100		100 m
FBROPTSM-150		150 m
FBROPTSM-200	200 m	





Continued on next page

⁽¹⁾ Other lengths can be made available upon customer request.

List of Materials, Continued

SFP The following table shows the SFPs and gland:

Item	Order Code / Photo	Description
A	<p>SFP-MM-500M SFP-SM-10KM SFP-SM-40KM SFP-SM-80KM</p> 	<p>Optical SFP, Multi-Mode, up to 500 m, 1.25 Gbit/s, 850 nm</p> <p>Optical SFP, Single-Mode, up to 10 km, 1.25 Gbit/s, 1310 nm.</p> <p>Optical SFP, Single-Mode, up to 40 km, 1.25 Gbit/s, 1310 nm.</p> <p>Optical SFP, Single-Mode, up to 80 km, 1.25 Gbit/s, 1550 nm.</p>
B	<p>SFP-ELGFE-IN</p> 	<p>Electrical SFP for 10 / 100 / 1000Base-T operation. ⁽¹⁾</p>
C	<p>SFP-HOOD</p> 	<p>Cable gland, UV-rated for optic / electric connector, to be used on the SFP cage interface.</p>

Continued on next page

⁽¹⁾ This SFP is not SyncE capable.



List of Materials, Continued

Pole fastening materials

The pole fastening materials consist of the following categories:

- Mounting bracket
- Steel hose clamps
- Cable ties

Mounting bracket

	Order Code / Photo	Description
<p>INST-PONE-PL</p>		<p>Mounting bracket and accessories for installation of PONE-OD-DC power injector onto a pole of 50 mm to 120 mm diameter.</p>
<p>INSTPONE-PL2</p>		<p>Mounting bracket and accessories for installation of PONE-OD67-AC power injector onto a pole of 50 mm to 120 mm diameter.</p>

Continued on next page

List of Materials, Continued

Steel hose clamps

Order Code / Photo	Description	
ST-CL64-140	Ø64-140 mm, W=12 mm for Ø60-114 mm pole diameter. ⁽¹⁾	
ST-CL102-178	Stainless steel hose clamp to fasten the radio unit onto poles or lamp posts. Two hose clamps are needed per radio unit.	
ST-CL172-248		Ø102-178 mm, W=12 mm for Ø115-150 mm pole diameter. ⁽¹⁾
ST-CL242-318		Ø172-248 mm, W=14 mm for Ø151-234 mm pole diameter. ⁽¹⁾
		Ø242-318 mm, W=14 mm for Ø235-300 mm pole diameter. ⁽¹⁾



Cable ties

Order Code / Photo	Description
CAB-TIE-UV	Cable tie, 500 x 12.5, black, UV-resistant. One tie is recommended per cable meter.



⁽¹⁾ The pole diameters stated for each hose clamp type correspond to the use of the steel hose clamp with the radio unit mounting plate only.

Connections

StreetNode™ 6250 PTP⁽¹⁾

The layout and description of the StreetNode™ 6250 PTP external elements is given below:

With DC Power supply module

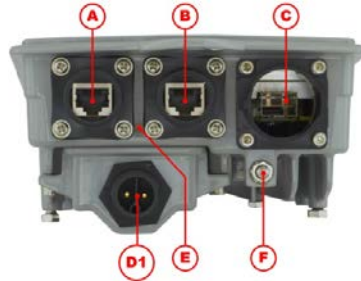

With AC Power supply module

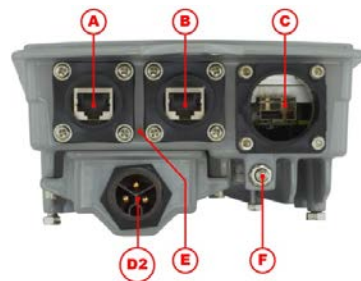

#	Marking	Details	Use
A	GbE2	Ethernet 100/1000Base-T, electrical (RJ-45).	Connection of Gigabit Ethernet cable (traffic / inband management / PoE ⁽¹⁾ input).
B	GbE1	Ethernet 100/1000Base-T, electrical (RJ-45).	Connection of Gigabit Ethernet cable (traffic / inband management).
C	GbE3	Ethernet 1000Base-T (SFP cage).	Installing a Gigabit Ethernet SFP (optical or electrical) for traffic / inband management.
D1, D2	PSU	Power supply receptacle with protective cap.	Connecting the DC (D1) or AC (D2) power supply cable when StreetNode™ 6250 PTP is self-powered.
E	STAT	Multi-functioning LED (Green / Red).	Providing system indications during operation.
F	GND	Enclosure grounding terminal.	Connecting the outdoor grounding cable.

Continued on next page

⁽¹⁾ StreetNode™ 6250 PTP radio can be powered by PoE / PonE only when fitted with the DC power module.

Connections, Continued

Outdoor DC PonE

The layout and description of the outdoor DC PonE external elements is given below:

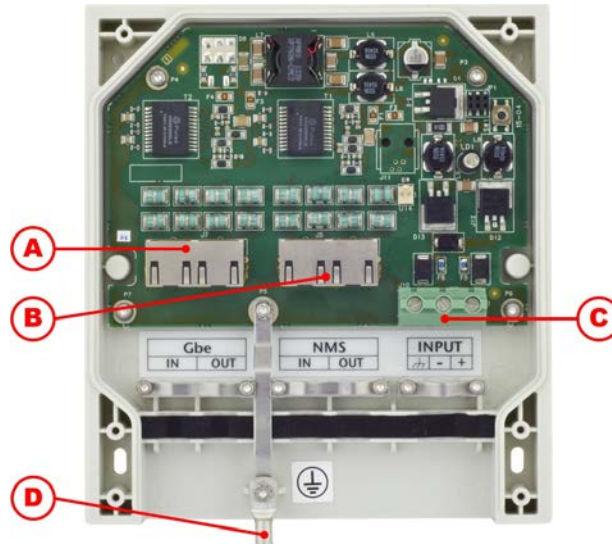

Item	Description	Use
A	Electrical Gigabit interface, RJ-45 (Gbe IN / OUT)	Connection of the traffic / power supply / inband management cable. (IN: cable from external Ethernet Switch, OUT: cable to the radio unit).
B	Fast Ethernet (10/100) interface, RJ-45 (NMS IN / OUT)	Connection of the outband management / power supply (secondary run) / cable. ⁽¹⁾ (IN: cable from external Ethernet Switch, OUT: cable to the radio unit).
C	DC power input (INPUT)	Connection of the external local DC power supply cable.
D	Grounding terminal.	Connection of PonE box to the local grounding bar.



PonE is suitable either for indoor or outdoor use.

Continued on next page

⁽¹⁾ When used, the **NMS (IN / OUT)** receptacle allows:

- outband management of the StreetNode™ 6250 PTP, and
- longer distances between the PonE device and StreetNode™ 6250 PTP (practically x2).

Connections, Continued

Outdoor AC PonE

The layout and description of the outdoor AC PonE external elements is given below:

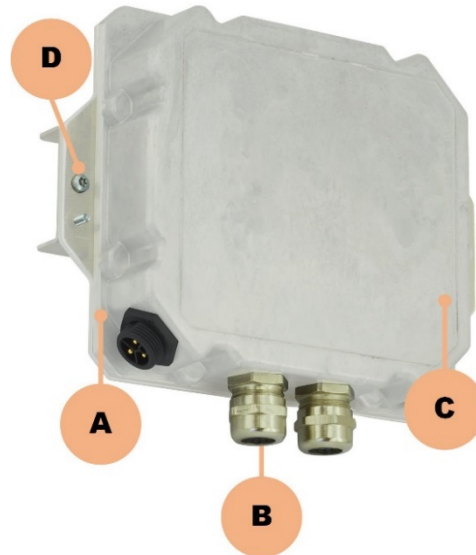

#	Marking	Details	Use
A	GbE IN / GbE OUT	Ethernet 100/1000Base-T, electrical (RJ-45 with gland)	<ul style="list-style-type: none"> • OUT: Connection of the Gigabit Ethernet S-FTP cable carrying payload traffic, inband management and superimposed DC power towards radio unit. • IN: Connection of the Gigabit Ethernet S-FTP cable carrying payload traffic and inband management to customer network equipment.
B	INPUT	AC power input, three terminals	Connection of the power supply cable (from the local AC power source)
C	LED	LED (Green / Red)	Providing system indications during operation.
D	GND	Grounding terminal.	Connection of PonE box to the local grounding bar.

Continued on next page

Connections, Continued

Indoor AC PoE The layout and description of the indoor AC PoE external elements is given below:

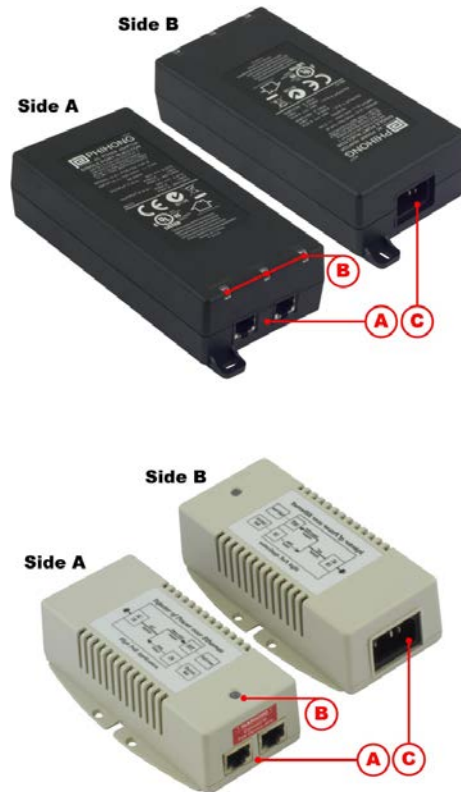

Item	Description	Use
A	Electrical Gigabit interface, RJ-45 (Gbe IN / OUT)	Connection of the traffic / power supply / inband management cable. (IN: cable from external Ethernet Switch, OUT: cable to the radio unit).
B	Multi-functioning LED (Green / Red).	Providing system indications during operation.
C	AC power input (INPUT)	Connection of the external local AC power supply cable.



PoE is suitable for indoor use only.

Equipment Anchor Points

Anchor point The upper 20 mm hole located on the safety bracket on the side (see below) serves as the StreetNode™ 6250 PTP anchor point.

This point can be used to install an appropriate safety lanyard⁽¹⁾.

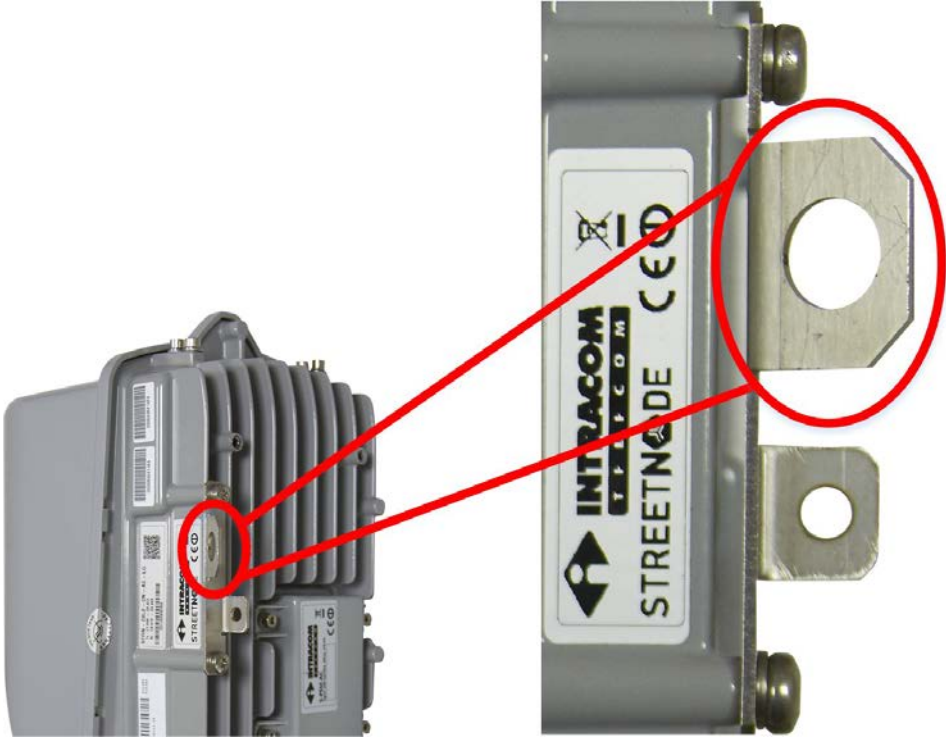

⁽¹⁾ For suggesting anchoring material contact Intracom S.A Telecom Solutions.

Safety Precautions



GENERAL

- Do not install or operate this system in the presence of flammable gases or fumes. Operating any electrical instrument in such an environment is a safety hazard.
- Only trained, authorized personnel should have access to the installed equipment.
- Outdoor units and antennas should be installed **ONLY** by experienced installation professionals who are familiar with local building and safety codes and, wherever applicable, are licensed by the appropriate government regulatory authorities. Failure to do so may void the product warranty and may expose the end user or the service provider to legal and financial liabilities.
- INTRACOM S.A. TELECOM SOLUTIONS and its resellers or distributors are not liable for injury, damage or violation of regulations associated with the installation of outdoor units or antennas.
- The equipment premises should be of restricted access.
- Appropriate labeling should exist at points with high risk of contact with hazardous voltage.
- A list with emergency phone numbers (e.g. medical assistance numbers) should be hung at easy-to-view positions.
- Also, recommended are for safety purposes, a fire detection system and fire extinguishers (installed at easy-to-access points) inside the installation premises.
- This equipment must be permanently earthed for protection and functional purposes.
- Changes or modifications to this equipment not expressly approved by INTRACOM S.A. TELECOM SOLUTIONS or the party responsible for compliance could void the user's authority to operate the equipment.



WORKING ON THE BUILDING'S ROOF

During stormy weather, do not perform any mechanical assembling or antenna installation/beaming works on the building's roof.

The metal structure of towers / masts is prone to lightning.

Continued on next page

Safety Precautions, Continued



- **LOCAL POWER AC SOURCE**

- Safety requirements require a single pole circuit-breaker to be employed between the local power AC source and StreetNode™ 6250 PTP (for AC direct powering) or AC power injector.
- The circuit breaker must disconnect the mains phase of the AC power.

- **LOCAL POWER DC SOURCE**

- Safety requirements require a single pole circuit-breaker to be employed between the local power DC source and StreetNode™ 6250 PTP (for DC direct powering) or DC power injector.
- The circuit-breaker must control (open / close) the negative (-) V pole of the power supply.
- The positive pole of the local power source must be grounded.

For circuit breaker requirements please refer to Circuit breakers on page 28.

- **POWER SUPPLY CABLES (AC/DC)**

- Power source cables must be tested for short circuits, open circuit or wrong wiring before installed.
- The ground wire of the AC power source cable must be connected to the protective earth (ground) point of the mains electricity installation.



- **AC or DC Power PROPER SWITCHING ON / OFF**

Never connect or disconnect the power cable to or from the radio unit as well as the power injector when the local power supply sources (AC or DC) is ON.

There is risk of equipment failure.

Continued on next page

Safety Precautions, Continued



GROUNDING

Never power on any equipment (except indoor AC PoE) unless you have completed the grounding installation as described in this manual.

There is risk of equipment failure and / or electrical shock.



Power Injectors devices PROPER CONNECTION

Never connect the power injectors OUT receptacle to network switches / routers / laptops.

There is risk of network devices failure due to potential power that is carried inside the cable.

Connect the OUT receptacle of power injectors to StreetNode™ 6250 PTP GbE2 port as described in this manual.



ETHERNET Cable

Neither plug in nor unplug the Gigabit Ethernet (S-FTP) cable of StreetNode™ 6250 PTP when outdoor PonE is powered on and operating unless you have completed the grounding installation as described in this manual.

There is risk of equipment failure and / or electrical shock.



LASER RADIATION

When using SFP, then the StreetNode™ 6250 PTP is a CLASS 1 laser product.

Site Prerequisites

Introduction

This paragraph describes all the prerequisites that must be considered prior to installing the equipment.

Site survey

Site survey should be done before start the installation taking in consideration the following:

Premises information

- Site details (address, contact persons, GPS and/or map co-ordinates, etc.)
- Site access and storage information (means of transport, equipment storage and lifting information, etc.)
- Site location maps

Network planning

- Site Coordinates
- LOS verification
- Rooftop information (height, status, access, dimensions, layout, etc.)
- Information about pre-existing indoor/ outdoor equipment
- Available mounting space (on the buildings' roofs) to reserve for the installation of the outdoor equipment

Site-specific information

- Mechanical specifications of masts/ towers (type, dimensions/ diameter, material, exterior finishing, etc.)
- Location of appropriate grounding points (bar or terminals).
- Location of appropriate power supply distribution points.
- Location of cable conduits available for routing the cables.
- Location of the network port distributors.
- Total length of the cables required.



The site survey report must be agreed and signed between all involved parties.

Continued on next page

Site Prerequisites, Continued

Preparation of the installation premises

Access to the installation premises must be facilitated during the installation period.
Entrances must be large enough to enable the easy transportation of the new equipment.
The floor must be level, smooth and able to bear the load of the equipment.
The roof must be engineered to bear the weight of the service personnel and the outdoor equipment.

Network port distributors

Regarding the network ports provided by the equipment, suitable optical (or electrical) network port distributors should be available.
The exact location of the network port distributors, as well as the network ports to reserve, should be known prior to installing the equipment.
Also, all the reserved ports on the network port distributors should be qualified and tested before realizing the network connections with the equipment.

Cables routing (lamp post)

When the StreetNode™ 6250 PTP is installed onto a lamp post then all the cables must be routed downwards from inside of the lamp post.

Power cable routing

Routing of AC or DC power supply power cable should be implemented as prescribed by the local regulations regarding outdoor electrical installations.

Cable conduits

Appropriate cable conduits should exist for the routing of installed cables.

Continued on next page

Site Prerequisites, Continued

Wall installation

All power injectors offered by Intracom Telecom can be installed as desktop or on a wall surface, as shown below:

- Indoor AC PoE:
Materials for wall mount installation **are not included** on the packing list of the product ((requires wood plugs (5 mm X 25 mm) and wood screws cross-headed (4 mm x 30 mm)).
 - Outdoor DC PonE:
Installed as described on Installation of Power Injector (Power over Ethernet) on page 60. For wall installation, 4 x screws and wall plugs are included in the unit package.
 - Outdoor AC PonE:
For wall installation, 4 x screws and wall plugs are included in the unit package.
-

Installation location

StreetNode™ 6250 PTP can be installed:

- either on a lamp post or pole, using the mounting plate and the supplied adjustable hose clamps,
 - on a wall surface, using the mounting plate and the supplied wall mounting accessories.
-

Lamp post or pole

- The lamp post or pole must be fastened to a foundation pad of concrete using anchor bolts.
 - The Lamp post or pole should not be swaying during winds more than $\pm 2^\circ$.
 - For lamp post or pole diameters⁽¹⁾ please refer to [Steel hose clamps](#) on page [15](#).
-

Continued on next page

⁽¹⁾ For diameters between 34 mm to 60 mm please contact Intracom S.A Telecom Solutions.

Site Prerequisites, Continued

Grounding

Ensure the following:

- To make a protective earth connection, use the grounding point located on the radio unit using an, as short as possible, length of grounding cable of at least 6mm² diameter (recommended 16mm²) or according to local electrical code.
 - A grounding bar is required close to each equipment installation position.
-

Outdoor grounding system

An appropriate, low-resistance grounding system as specified by the local regulations is required.

A grounding point (designated GND) should be located close to the mounting position of the equipment.

The equipment will be connected to this grounding point, via the supplied grounding cable.

This can also provide partial protection against Lightning-induced current.

For additional protection against lightning LSPs need to be used.

For more information regarding the installation of LSP/PSP please refer to the following manual:

[Lightning & Surge Protection for Intracom Telecom Radios – Installation Practices](#)

Continued on next page

Site Prerequisites, Continued

Power supply source

For the installation location, we assume the existence of an appropriate power supply source with the following specifications:

StreetNode™ 6250 PTP with DC power supply module:

-40.5 V dc to -60 V dc.

StreetNode™ 6250 PTP with AC Power Supply Module:

90-240 V / 50 Hz to 60 Hz (Live / Neutral).

For applicable input voltage ranges for power injectors please refer to Power injectors on page 6.

Circuit breakers

The following table provides the circuit breakers characteristics for powering of StreetNode™ 6250 PTP and power injectors:

Powering Type	Required Circuit Breaker
Direct AC powering	<ul style="list-style-type: none"> • single-pole MCB 6 A • 230 V AC (voltage rating) • C-curve (for Industrial Applications)
Direct DC powering	<ul style="list-style-type: none"> • single-pole MCB 6 A • min 72 V DC (voltage rating) • C-curve (for Industrial Applications)
Powering via outdoor AC PonE	<ul style="list-style-type: none"> • single-pole MCB 6 A • 230 V AC (voltage rating) • C-curve (for Industrial Applications)
Powering via indoor AC PoE	<ul style="list-style-type: none"> • single-pole MCB 6 A • 230 V AC (voltage rating) • C-curve (for Industrial Applications)
Powering via outdoor DC PonE	<ul style="list-style-type: none"> • single-pole MCB 6 A • min 72 V DC (voltage rating) • C-curve (for Industrial Applications)

Continued on next page

Site Prerequisites, Continued

Line Of Sight (LOS) verification

Prior to installation, the installer must verify LOS availability between the two StreetNode™ 6250 PTP.

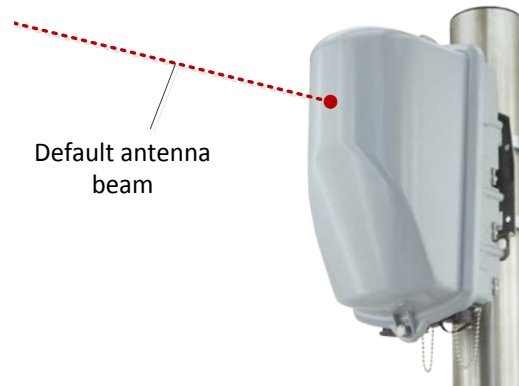

The orientation of the StreetNode™ 6250 PTP antenna is not critical as node has self-alignment capabilities with tilt range $30^{\circ} (\pm 15^{\circ})$ and elevation range $20^{\circ} (\pm 10^{\circ})$.

Continued on next page

Site Prerequisites, Continued

Lightning & Surge protection

In case additional protection against lightning is required for the radio the following should be applied:

a. For Ethernet (S-FTP) Cables:

Lighting surge protection device (LSP) is required to minimize equipment damage from lightning induced surges.

b. Power Supply Cables (for direct powering AC or DC):

A power surge protection device (PSP) is required to avoid equipment damage from lightning induced surges or power supply surges.

For more information regarding the installation of LSP/PSP please refer to the following manual:

[Lightning & Surge Protection for Intracom Telecom Radios – Installation Practices](#)

Continued on next page

Site Prerequisites, Continued

Internal ovp⁽²⁾ **AC Mains Line (StreetNode™ 6250 PTP)**

AC power supply module

Input Overvoltage Protection:

- **Live – Neutral:** 1 kV – 1.2/50 µs (8/20 µs)
- **Live – Earth:** 2 kV – 1.2/50 µs (8/20 µs)
- **Neutral – Earth:** 2 kV – 1.2/50 µs (8/20 µs)

Input Overcurrent Protection:

- Double-pole fused through 2 A time-lag fuses (potted, nonreplaceable).

Connection to the Power Source:

The AC power supply cable should be protected with single-pole MCB of 6 A / 230 V AC rating, suitable for industrial applications (C-curve).

DC power supply module

Input Overvoltage Protection:

- 500 V – 1.2/50 µs (8/20 µs), negative pulses at negative (-) pole, positive (+) pole connected to ground.

Input Overcurrent Protection:

- Double-pole fused through 3.5 A time-lag fuses.

Connection to the Power Source:

The DC power supply cable should be protected with single-pole MCB of 6 A / 72 V DC (minimum) rating, suitable for industrial applications (C-curve).

Outdoor signal line:

1 kV 1.2/50 µs (8/20 µs), shield-to-ground

In case additional protection against lightning is required please refer to Lightning & Surge protection on page 30

Continued on next page

⁽²⁾ Overvoltage.

Site Prerequisites, Continued

Safety

Ensure the following:

- Only trained, authorized personnel should have access to the installed equipment.
 - Appropriate labeling should exist at points with high risk of contact with hazardous voltage.
 - A list with emergency phone numbers (e.g. medical assistance numbers) should be hung at easy-to-view positions.
 - Also, recommended are for safety purposes, a fire detection system and fire extinguishers (installed at easy-to-access points) inside the installation premises.
-

Cable Length Restrictions

Introduction

Three types of cables can be connected to StreetNode™ 6250 PTP interfaces as follows:

- Gigabit Ethernet (S-FTP) Cable (Cat 5E or Cat 6)
- Fiber Optic Cable (Single mode or Multimode)
- Power Supply Cable (AC or DC).

Two types of powering are provided and can be either:

- **Directly** (AC or DC powering) or
- Via an external **power injector** (outdoor DC PonE or outdoor AC PonE or indoor AC PoE)



StreetNode™ 6250 PTP radio can be powered by PoE / PonE only when fitted with the DC power module.

Continued on next page

Cable Length Restrictions, Continued

Cable length restrictions

A): Maximum length of cables used for Data Traffic:

Given that the maximum line rate of each traffic interface supported by StreetNode™ 6250 PTP is 1Gbps Ethernet and depending on the type of cable used for data traffic, the following restrictions apply to the lengths of traffic bearing cables:

- Cat5E or Cat6 S-FTP cable:

The total length of Gigabit ETHERNET (S-FTP) cable up cannot exceed 100 meters, where total length of cable is defined as: length of cable between StreetNode™ 6250 PTP radio unit receptacle up to power injector receptacle (out) PLUS length of cable between power injector receptacle (in) up to customer network equipment receptacle.

- Multimode optical fiber cable (Combined with 1000Base-LX SFP):

OM1 (62.5/125) Multimode cable type combined with 1000Base-SX (850nm) SFP: Max length 275m

OM2 (50/125) Multimode cable type combined with 1000Base-SX (850nm) SFP: Max length 550m

- Single mode optical fiber cable:

Combined with 1000Base-LX SFP : Max length 5km

Combined with 1000Base-LX10 SFP : Max length 10km

Combined with 1000Base-EX SFP : Max length 40km

Combined with 1000Base-ZX SFP : Max length 80km

Continued on next page

Cable Length Restrictions, Continued

Cable length restrictions, continued

B): Maximum length of cables used for Powering:

Due to voltage drop along the length of the powering cable and the minimum voltage requirements at the input of the radio power supply, restrictions apply on the length of powering cables as follows:

- Direct DC powering cables:

The maximum cable length of the recommended 2 x 1 mm² cable is 100 m.

The maximum cable length of the recommended 2 x 2.5 mm² cable is 300 m



The lowest allowable voltage at the input of the cable is 40.5Volts.



In case more than 100 m cable length then 2 x 2.5 mm² power supply cable is required.

A short tail cable 2 x 1 mm² terminating to DC power supply connector (StreetNode™ 6250 PTP side) should be connected with 2 x 2.5 mm² power supply cable.

The power cables should be connected in a reliable and waterproof fashion.

- Direct AC powering cables:

The maximum cable length of the recommended 3 x 0.75 mm² cable is 300 meters.

- S-FTP cable (CAT5E or CAT6) used with provided power injectors⁽¹⁾:

– *S-FTP cable (CAT5E or CAT6) used with provided AC type power injectors (with order codes **POE-ID-AC75**, **PONE-OD67-AC** and **POE-IDH-AC56**):* The maximum length of S-FTP cable between StreetNode™ 6250 PTP radio unit receptacles up to power injector receptacle (out) is 100m (Restriction Cat5E or Cat6 S-FTP cable also applies).

Continued on next page

⁽¹⁾ Use of PoE/PonE powering is applicable only with radio units featuring DC power module.

Cable Length Restrictions, Continued

Cable length restrictions, continued

- S-FTP cable (CAT5E or CAT6) used with provided power injectors⁽¹⁾, continued

*S-FTP cable (CAT5E or CAT6) used with provided DC type power injectors (with order code **PONE-OD-DC**):*

The length of the SFTP cable, between PonE injector and radio unit, cannot reach 100 meters when the DC voltage at the input of the PonE is the lowest defined by the standards (40.5 V).

This is because the voltage drop on the S-FTP cable will result in the Voltage at the input of the DC power module of the radio unit to be less than the min allowable value for operation. Higher input voltage need to be applied to ensure proper powering of the radio.

The following table shows the maximum SFTP cable length versus the voltage at the input of the PONE for Cat5E and Cat6 cable types.

Input voltage to the PonE (VDC)	max length of Cat6 S-FTP cable (m)	max length of Cat5E S-FTP cable (m)
40	80.00	65
40.25	85.00	70.00
40.5	90.00	75.00
40.75	95.00	80.00
41	100.00	85.00
41.25	100.00	90.00
41.5	100.00	95.00
41.75	100.00	100.00
42-60	100.00	100.00

⁽¹⁾ Use of PoE/PonE powering is applicable only with radio units featuring DC power module.

Antenna Hydrophobic Coating Protection

Instruction

The polycarbonate cover in front of the antenna is covered by "**Cytonix Fluorothane™ -AD super-hydrophobic air drying polymer system**" in order to minimize the effects on antenna performance by heavy rain, snow fall and protect against ice accumulation.

Fluorothane™ AD will repel water, snow, ice and many aqueous liquids or suspensions. The coating is not repellent to organic solvents or products that contain them.

Cytonix Fluorothane™ -AD is sprayable featuring separate Base and Top coat materials. In most cases, surfaces will self-clean in the rain. Surfaces that have become contaminated with soot or organic materials may be spritzed with cleaners or detergent solutions and then rinsed with a gentle spray of water. Coated surfaces should never be cleaned with brushes, scouring pads or high pressure sprays.

Units should be handled with care in order to avoid damaging the Hydrophobic coating.

Avoid touching the polycarbonate top cover in the area in front of the antenna transmission window (as shown below).



Damaged coatings may often be restored by application of additional Top Coat.

In case of touching the coated surface in front of the antenna by mistake, assuming the contact is light and momentary and/or on a small area there is no need for coating restoration.

Recommended Tools







Topics

This paragraph describes the following tools that will be needed:

- Equipment installation tools.
- Ethernet cable termination tools.
- Power supply cable termination tools.
- Grounding cable termination tools.

The tools are not supplied and are installer responsibility to be available during installation.

Equipment installation tools





Item	Tool/ Photo	Description
1		Electrical screwdriver with extension and allen bits: <ul style="list-style-type: none"> • 3 mm (with internal safety pin) • 7 mm (2 Nm) • 8 mm (2 Nm / 4.2 Nm)
2		Adjustable torque spanners: R.8 (2 Nm / 4.2 Nm) R.28 (2 Nm)
3		PH-2cross headed screwdriver.
4		Flat-headed screwdriver.
5		Drill machine with appropriate: <ul style="list-style-type: none"> • 8 mm bit (for StreetNode™ 6250 PTP wall mounting). • 5 mm bit (for PonE wall installation). • Hole cutter metal⁽¹⁾ (for StreetNode™ 6250 PTP lamp post installation)
6		Tamper-proof torx screwdriver T10

Continued on next page

⁽¹⁾ The hole diameter should be defined by the local regulations regarding outdoor electrical installations. For passing all cables (1 x power, 2 x Ethernet, 1 x Fiber Optic and 1 x Grounding) 5 cm to 7 cm hole is required.

Recommended Tools, Continued

Ethernet cable termination tools

Item	Tool/ Photo	Description
7		Blade
8		Cable cutter.
9		Pliers (long nose).
10		Crimping tool for terminating S-FTP cable to RJ-45 jacks.
11		Ethernet cable tester.

Continued on next page

Recommended Tools, Continued

Power supply cable termination tools

Item	Tool/ Photo	Description
12		Soldering iron.
13		Solder.

Grounding cable termination tools

Item	Tool/ Photo	Description
14		Crimping tool for ring terminals (16 mm and 6 mm).
15		Hot Air Gun.

3. Installation of StreetNode 6250 PTP

Mechanical Installation & Grounding

Precautions



Before start any installation action please follow the instructions for **Antenna Hydrophobic Coating Protection** on page **37**.



Never leave unoccupied receptacles without cover. Covering receptacles is necessary to protect against humidity penetration.

Topics

This paragraph describes the following procedures of StreetNode™ 6250 PTP:

- Lamp post (or pole) installation
- Building wall surface installation
- Grounding cable installation

Tools and materials

#	Lamp Post (or pole) Installation	Building Wall Surface Installation	Grounding Cable Installation
Materials	Items A & F from Packing list materials on page 5 .	Items A & E from Packing list materials on page 5 .	<ul style="list-style-type: none"> • Item A from Packing list materials on page 5. • Item A from Grounding materials on page 9.
Tools	Item 1 from Equipment installation tools on page 38 .	Items 1 (with 3 mm and 8 mm), 2 (R.8) and 5 from Equipment installation tools on page 38 .	<ul style="list-style-type: none"> • Item 1 (with 8 mm) from Equipment installation tools on page 38. • Items 14 and 15 from Grounding cable termination tools on page 40.

Continued on next page

Mechanical Installation & Grounding, Continued

**Lamp post
(or pole)
installation
procedure**

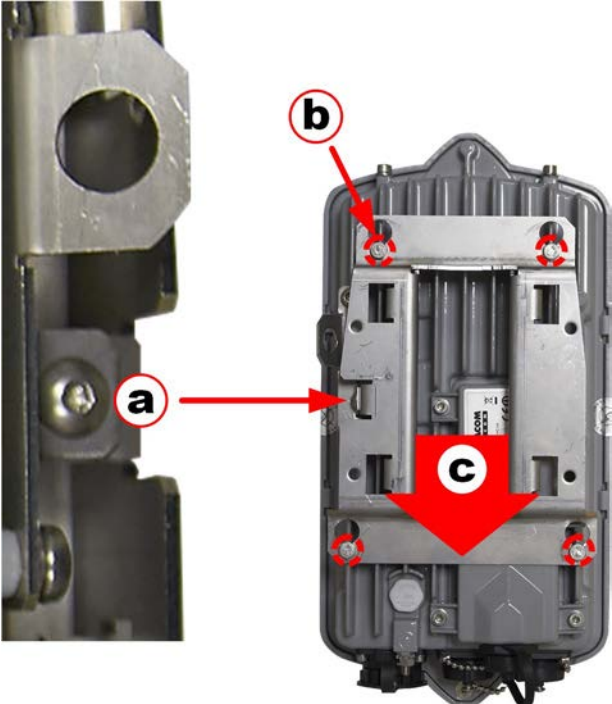

To install StreetNode™ 6250 PTP on a lamp post (or pole) , proceed as follows:

Step	Action
1	<p>Perform the following:</p> <ol style="list-style-type: none"> a. Using the electrical screwdriver, extension and 3 mm bit, unscrew the safety screw and lock washer (supplied) into the intended hole on the safety plate at the side. b. Using the electrical screwdriver, extension and 8 mm bit, loosen the four screws. c. Slide the plate downwards and then remove it. 

Continued on next page

Mechanical Installation & Grounding, Continued

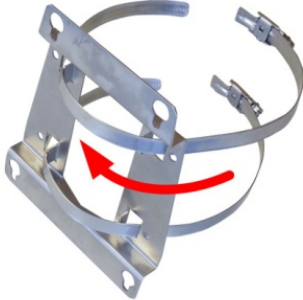

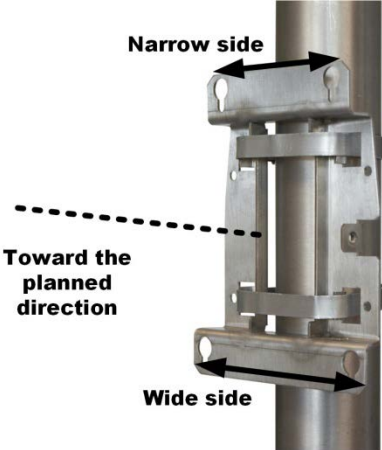
Lamp post
 (or pole)
 installation
 procedure,
 continued

Step	Action
2	<p>Install the two supplied hose clamps onto the mounting plate, as shown below:</p> 
3	<p>Using the electrical screwdriver, extension and 7 mm bit, install the mounting plate with clamps onto the pole.</p> <p>Beware of the correct positioning of the mounting plate, as shown below:</p> <ul style="list-style-type: none"> • Narrow side up • Wide side down <p> A StreetNode™ 6250 PTP node must have Line Of Sight (LOS) with the far-end StreetNode™ 6250 PTP.</p> 

Continued on next page

Mechanical Installation & Grounding, Continued

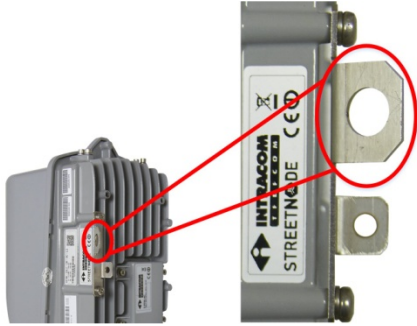
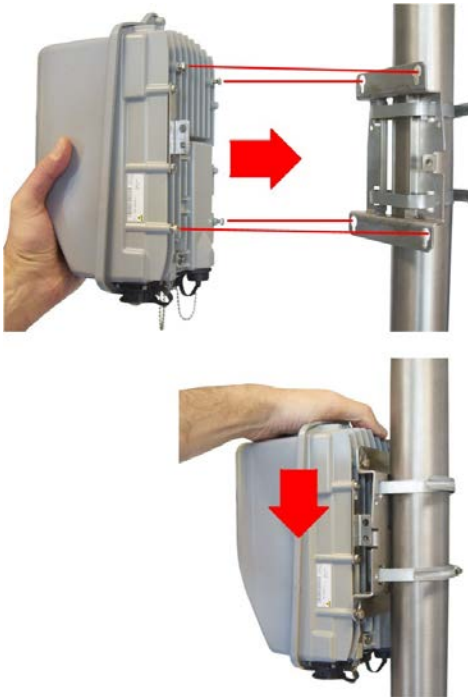

Lamp post
(or pole)
installation
procedure,
continued

Step	Action
4	<p>Prior to the elevation and installation on the lamp post (or pole), use the anchor point (see arrow below) to install an appropriate safety lanyard.</p> 
5	<p>Insert the StreetNode™ 6250 PTP through the intended mounting plate openings and then slide downwards, as shown below:</p>  <p> Ensure that StreetNode™ 6250 PTP is fully seated in the mounting plate.</p>

Continued on next page

Mechanical Installation & Grounding, Continued

Lamp post
(or pole)
installation
procedure,
continued

Step	Action
6	<p>Perform the following:</p> <ol style="list-style-type: none">Using the electrical screwdriver, extension and 8 mm bit, tighten the four screws.Using the electrical screwdriver, extension and 3 mm bit, tighten the safety screw and lock washer (supplied) into the intended hole on the mounting plate at the side.  <p> Do not over tighten screws. Adjust the electrical screwdriver for tightening of M5 screws. Ensure that the LOS is still remains between the existing one and the remote.</p>
7	Install the grounding cable as instructed in Grounding cable installation procedure on page 51.

End of procedure.

Continued on next page

Mechanical Installation & Grounding, Continued

Building wall installation procedure

To install StreetNode™ 6250 PTP onto building wall surface, proceed as follows:

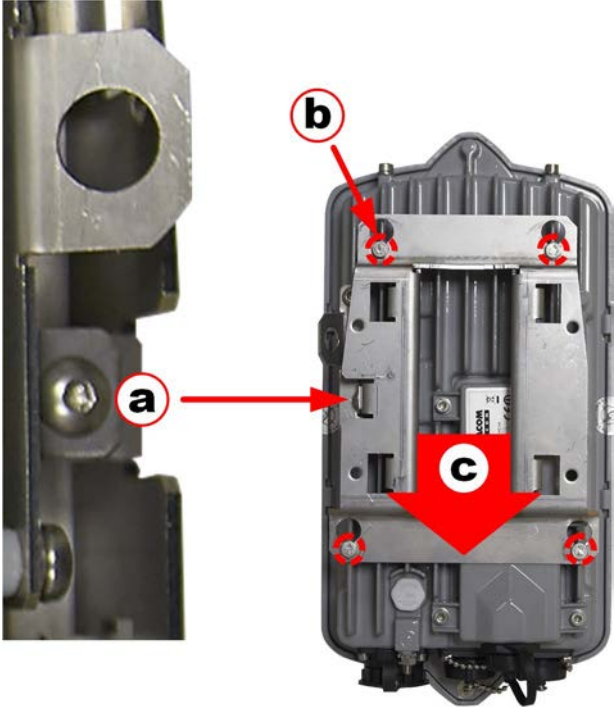
Step	Action
1	<p>Perform the following:</p> <div style="text-align: center;">  </div> <ol style="list-style-type: none"> <li data-bbox="555 1368 1369 1469">a. Using the electrical screwdriver, extension and 3 mm bit, unscrew the safety screw and lock washer (supplied) into the intended hole on the safety plate at the side. <li data-bbox="555 1480 1369 1547">b. Using the electrical screwdriver, extension and 8 mm bit, loosen the four screws. <li data-bbox="555 1559 1225 1592">c. Slide the plate downwards and then remove it.

Continued on next page

Mechanical Installation & Grounding, Continued

**Building Wall
installation
procedure,
continued**

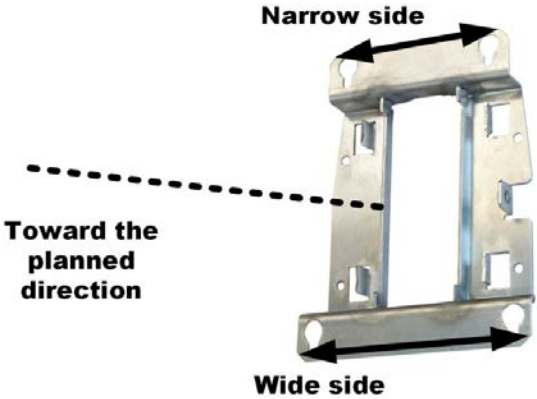
Step	Action
2	<p>Beware of the correct positioning of the mounting plate, as shown below:</p> <ul style="list-style-type: none">• Narrow side up• Wide side down <p> A StreetNode™ 6250 PTP node must have Line Of Sight (LOS) with the far-end StreetNode™ 6250 PTP.</p> 

Continued on next page

Mechanical Installation & Grounding, Continued

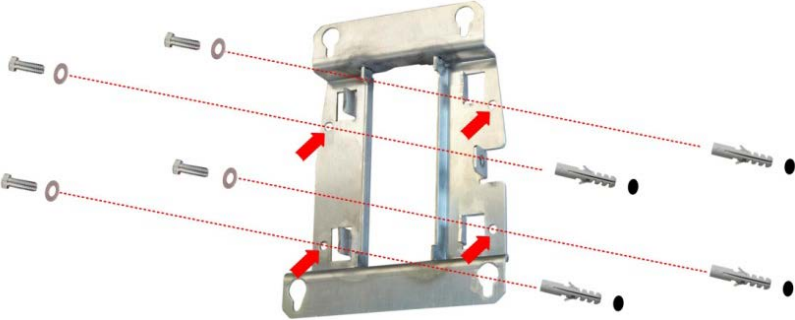

Building Wall installation procedure, continued

Step	Action
3	<p>Perform the following, as shown below:</p>  <ol style="list-style-type: none"> a. With the drill machine (fitted with 8 mm bit), drill four holes on the wall surface, at a depth of 55 mm. b. Install the four supplied wall plugs. c. Using the four screws and lock washers, install the mounting plate onto the wall. d. Using the electrical screwdriver, extension and 8 mm bit, tighten the four screws. <p>Do not over tighten screws. Adjust the electrical screwdriver for tightening of M5 screws.</p>

Continued on next page

Mechanical Installation & Grounding, Continued

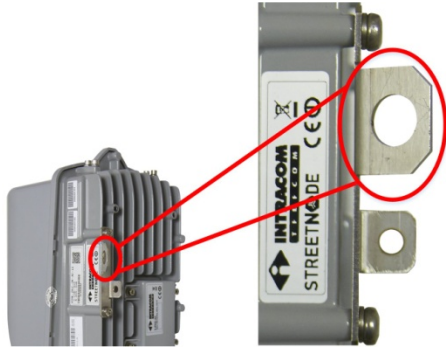
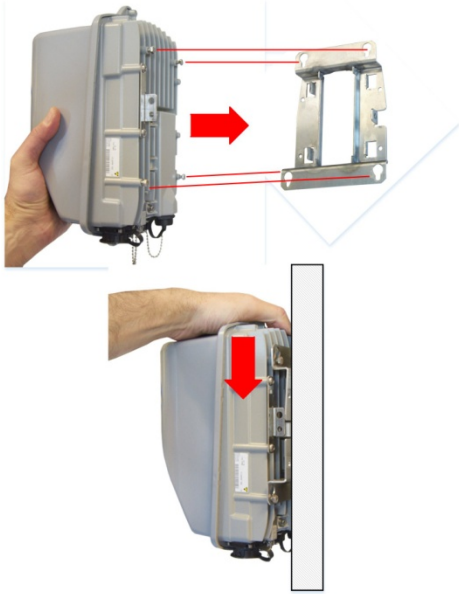

Building Wall
 installation
 procedure,
 continued

Step	Action
4	<p>Prior to the elevation and installation on the wall, use the anchor point (see arrow below) to install an appropriate safety lanyard.</p> 
5	<p>Insert the StreetNode™ 6250 PTP through the intended mounting plate openings and then slide downwards, as shown below:</p>  <p> Ensure that StreetNode™ 6250 PTP is fully seated in the mounting plate.</p>

Continued on next page

Mechanical Installation & Grounding, Continued

Building Wall installation procedure, continued

Step	Action
6	<p>Perform the following:</p> <ol style="list-style-type: none"> a. Use the spanner 8 mm for fastening StreetNode™ 6250 PTP onto the mounting plate. Do not over tighten screws. Adjust the spanner for tightening of M5 screws. b. Using the electrical screwdriver, extension and 3 mm bit, tighten the safety screw and lock washer (supplied) into the intended hole on the mounting plate at the side. <div style="text-align: center;">  </div> <p> Ensure that the LOS is still remains between the existing one and the remote.</p>
7	Install the grounding cable as instructed to the next procedure.

End of procedure.

Continued on next page

Mechanical Installation & Grounding, Continued

Grounding cable installation procedure

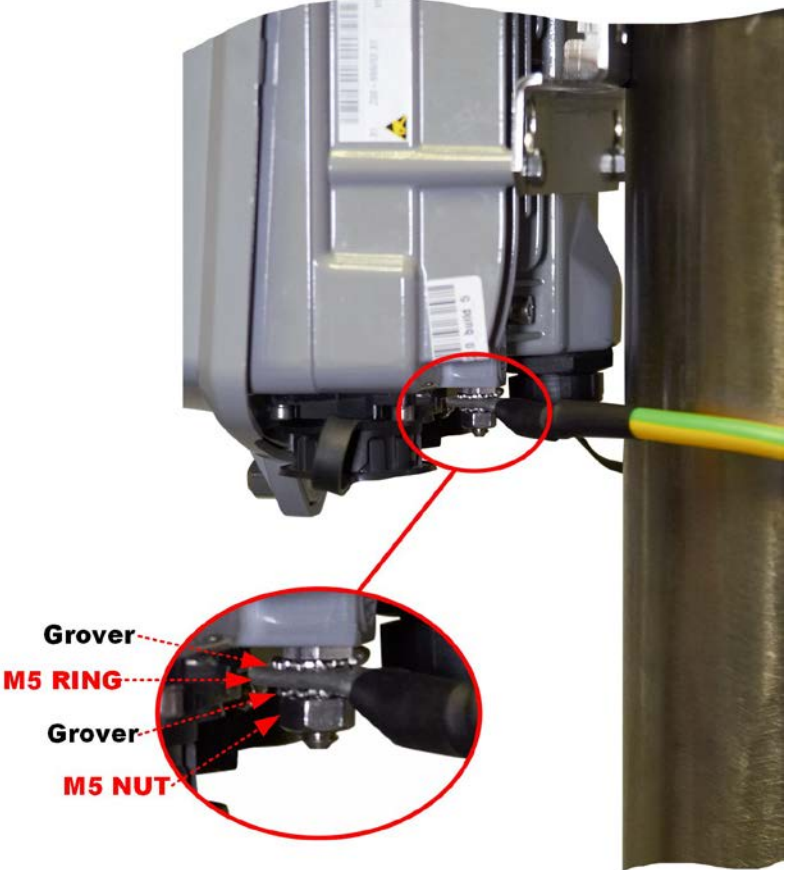
Step	Action
1	Prepare and terminate the grounding cable as instructed in Appendix C: Terminating Grounding cable on page 76.
2	<p>Use the electrical screwdriver with extension and 8 mm bit, to remove the M5 screw and one grover.</p> <p>Install the cable and then insert the grover and nut, as shown below.</p> <p>Use the electrical screwdriver with extension and 8 mm bit, to tighten the M5 screw.</p> <p>Do not overtighten. Adjust the electrical screwdriver for tightening of M5 screws.</p>  <p>The diagram shows a StreetNode device with a grounding cable attached. A red circle highlights the connection point. A magnified view below shows the components: Grover, M5 RING, Grover, and M5 NUT.</p>

End of procedure.

Installation of Traffic Cable(s)

Topics

This paragraph describes the following procedures of StreetNode™ 6250 PTP:

- Ethernet (S-FTP) cable installation (GbE1 – GbE2 Inputs).
- Ethernet (S-FTP) cable installation (SFP Input).



Either Optical SFP with fiber optic cable OR electrical SFP with Ethernet (S-FTP) cable is used the installation procedure is identical.

Tools and materials



#	S-FTP Installation for GbE1 – GbE2 Inputs	S-FTP Installation for GbE3 Input
Materials	Items A, B and C from S-FTP cables on page 11 .	<ul style="list-style-type: none"> • Items A, B and C from S-FTP cables on page 11. • Items B and C from SFP on page 13.
Tools	Ethernet cable termination tools on page 39 .	<ul style="list-style-type: none"> • Ethernet cable termination tools on page 39. • Item 2 (28 mm) from Equipment installation tools on page 38.

Continued on next page

Installation of Traffic Cable(s), Continued

Ethernet (S-FTP) cable installation procedure

To install StreetNode™ 6250 PTP Ethernet S-FTP cable, proceed as follows:

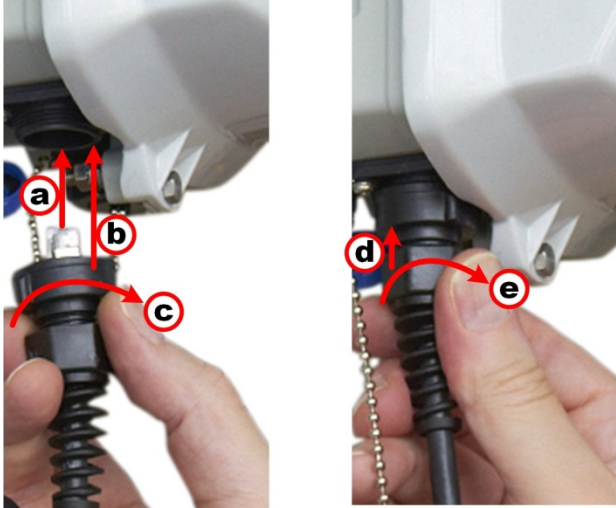
Step	Action
1	Slide all three parts of the supplied gland over the S-FTP cable (StreetNode™ 6250 PTP side), as shown below: 
2	Prepare and terminate the Ethernet cable as instructed in Appendix A: Terminating Ethernet (S-FTP) Cable on page 67. 
3	First plug the RJ-45 jack and then tighten the cable gland, as shown below: 
4	Cut the chain of the protective cup.

End of procedure.

Continued on next page

Installation of Traffic Cable(s), Continued

Ethernet (S-FTP) cable installation with SFP

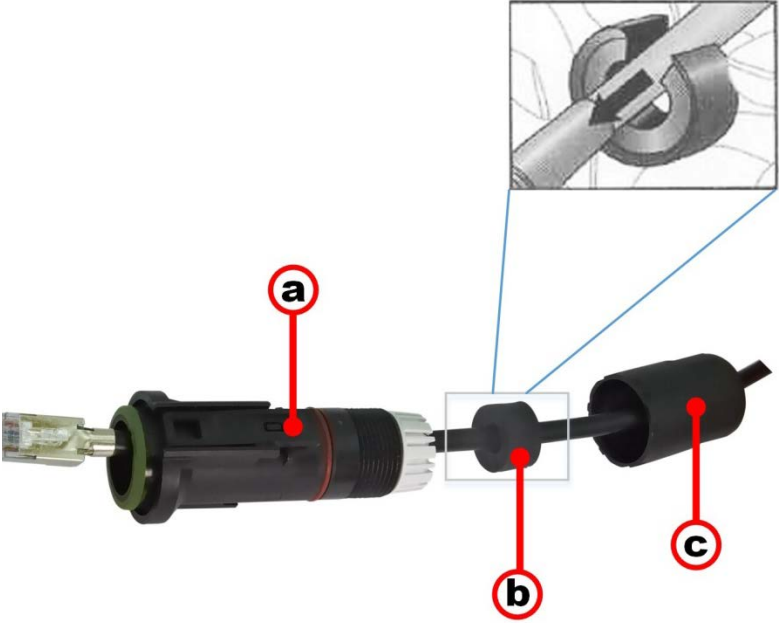

To install StreetNode™ 6250 PTP SFP Ethernet (S-FTP) cable with SFP, proceed as follows:

Step	Action
1	<p>Prepare and terminate the Ethernet cable as instructed in Appendix A: Terminating Ethernet (S-FTP) Cable on page 67.</p> <p>Slide all three parts of the supplied gland over the S-FTP cable (StreetNode™ 6250 PTP side), as shown below:</p> 

Continued on next page

Installation of Traffic Cable(s), Continued

Ethernet
(S-FTP) cable
installation with
SFP

Step	Action
2	Insert SFP module into SFP cage, as shown below: 
3	Plug the RJ-45 jack of the S-FTP cable into SFP cage, as shown below: 

Continued on next page

Installation of Traffic Cable(s), Continued

Ethernet (S-FTP) cable installation with SFP, continued

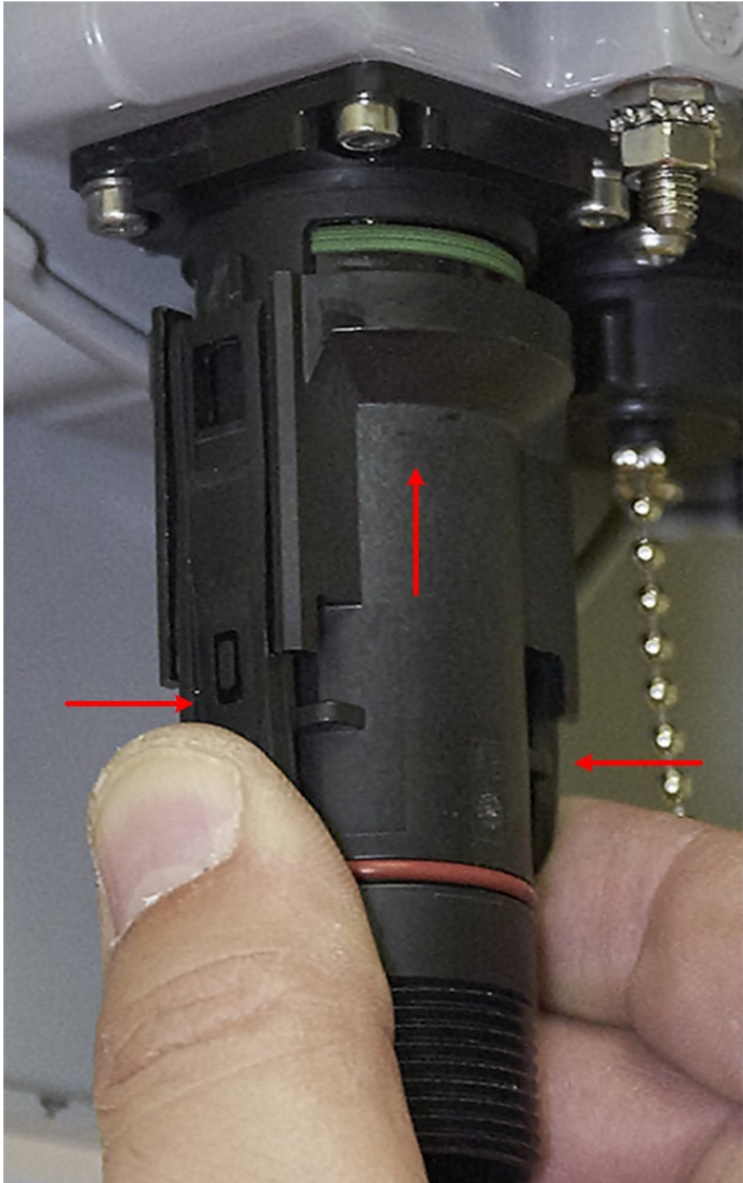
Step	Action
4	<p>Push the SFP HOOD flaps to open and then push upwards till the HOOD locked properly.</p> 

Continued on next page

Installation of Traffic Cable(s), Continued

Ethernet
(S-FTP) cable
installation with
SFP, continued

Step	Action
5	<p data-bbox="571 409 1356 472">Perform actions (a) and (b – using spanner R.28), as shown below:</p> 

End of procedure.

Installation of Power Cable (Direct Powering)

Topics

This paragraph describes the following procedure of StreetNode™ 6250 PTP:

- Power supply cable installation (direct powering - StreetNode™ 6250 PTP side)

Tools and materials

#	Prefabricated Cable	Bulk Cable
Materials	Items B or D from Power cables on page 7.	<ul style="list-style-type: none"> • Items A or C from Power cables on page 7. • Items A or C from Power modules & connectors on page 8.
Tools	-	Power supply cable termination tools on page 40.

Continued on next page

Installation of Power Cable (Direct Powering), Continued

Procedure To install the power supply cable in StreetNode™ 6250 PTP power input, proceed as follows:

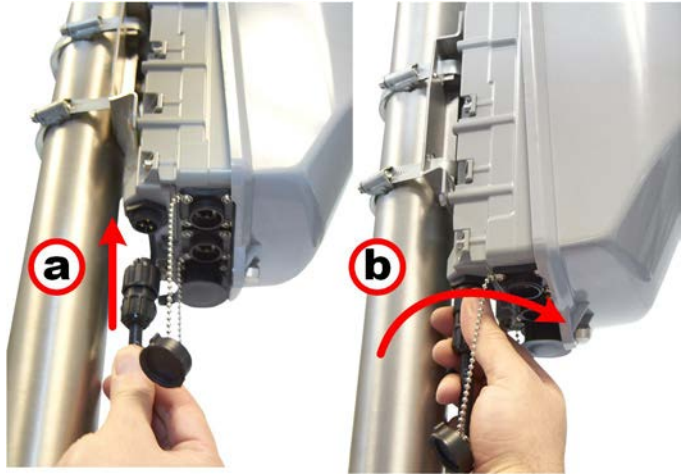
Step	Action
1	Prepare and terminate the power supply cable as instructed in Appendix B: Terminating Power Supply Cable on page 75.
2	Perform the following actions, as shown below: 

End of procedure.

Installation of Power Injector (Power over Ethernet)

Introduction

StreetNode™ 6250 PTP can be powered by either direct powering or Power injector.

The power injector can be either

PonE (DC -indoor or outdoor) or **PoE** (AC – outdoor only).

PonE:

- The power at the input of PonE box must be measured in the range of –40 V dc to –60 V dc.
- PonE must be connected to the DC distribution board and more specifically to a magnetic circuit breaker (single-pole MCB 6 A, 80 V dc, B-curve for Telecom Applications).



- Safety requirements require a single pole circuit-breaker to be employed between the Local DC Power Source and PonE box. The circuit-breaker must disconnect the negative (-) V pole of the power supply.



Before plugging or unplugging any cable into PonE device as well as into StreetNode™ 6250 PTP, you must switch-off the Local DC Power Source and set the circuit breaker to OFF!

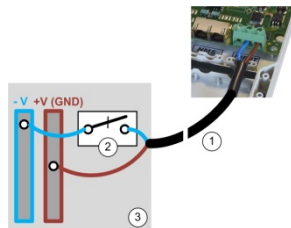

No	Description
1	Power Cable.
2	Single pole Circuit.
3	Local DC Power Distributor.

PoE:

PoE is an indoor device only and can be installed as desktop or in a wall surface, as shown below:



Materials for wall mount installation **are not included** on the packing list of the product ((requires wood plugs (5 mm X 25 mm) and wood screws cross-headed (4 mm x 30 mm)).

Continued on next page

Installation of Power Injector (Power over Ethernet), Continued

Topics This paragraph describes the following procedure of Power Injectors:

- Mechanical and Cabling Installation (PonE)
- Cabling Installation (PoE)

Tools and materials



#	PonE	PoE
Materials	<p>Lamp post:</p> <ul style="list-style-type: none"> • Item C from Power injectors on page 6. • Item E from Power cables on page 7. • Item B or C from Grounding materials on page 9. • Items A, B, C and D from S-FTP cables on page 11. • Item INST-PONE-PL from Pole fastening materials on page 14. <p>Wall:</p> <ul style="list-style-type: none"> • Item C from Power injectors on page 6. • Item E from Power cables on page 7. • Item B or C from Grounding materials on page 9. • Items A, B, C and D from S-FTP cables on page 11. 	<ul style="list-style-type: none"> • Items A or B from Power injectors on page 6. • Items A, B, C and D from S-FTP cables on page 11.
Tools	<ul style="list-style-type: none"> • Items 3, 4, 5 (5 mm bit) and 6 from Equipment installation tools on page 38. • Ethernet cable termination tools on page 39. • Grounding cable termination tools on page 40. 	<ul style="list-style-type: none"> • Ethernet cable termination tools on page 39.

Continued on next page

Installation of Power Injector (Power over Ethernet), Continued

Mechanical and cabling installation (PonE)

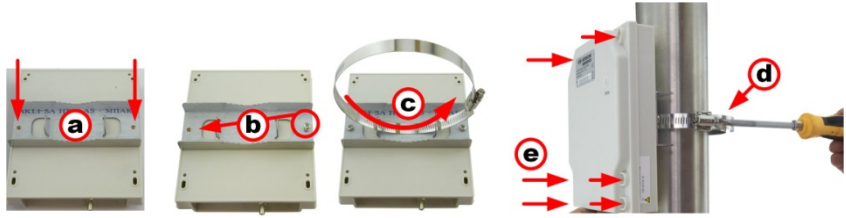
For mechanical installation and cabling of PonE, proceed as follows:

Step	Action
1	<p>Pole installation:</p> <ol style="list-style-type: none"> Attach the plate onto rear side of PonE, as shown below: Install grover and screw and using the PH-2 screwdriver fully tighten: Pass the hose clamp through the plate holes. Using the electrical screwdriver, extension and 7 mm bit, install the mounting plate with clamps onto the pole. Use a tamper-proof torx screwdriver T10 to remove the six screws (see below) and detach the PonE cover for installing the ground cable. <p>Be careful not to drop the screws while removing.</p>  <p>Wall Installation:</p> <ol style="list-style-type: none"> Use a tamper-proof torx screwdriver T10 to remove the six screws (see below) and detach the PonE cover. <p>Be careful not to drop the screws while removing.</p> <ol style="list-style-type: none"> Perform the following: <ul style="list-style-type: none"> Position the device on the wall surface and using a pencil mark the drill points. With the drill machine (fitted with 5 mm bit), drill four holes on the wall surface, at a depth of 45 mm. Install the four supplied wall plugs and using the cross headed screwdriver and tighten the four screws. 

Continued on next page

Installation of Power Injector (Power over Ethernet), Continued

Mechanical and cabling installation (PonE), continued

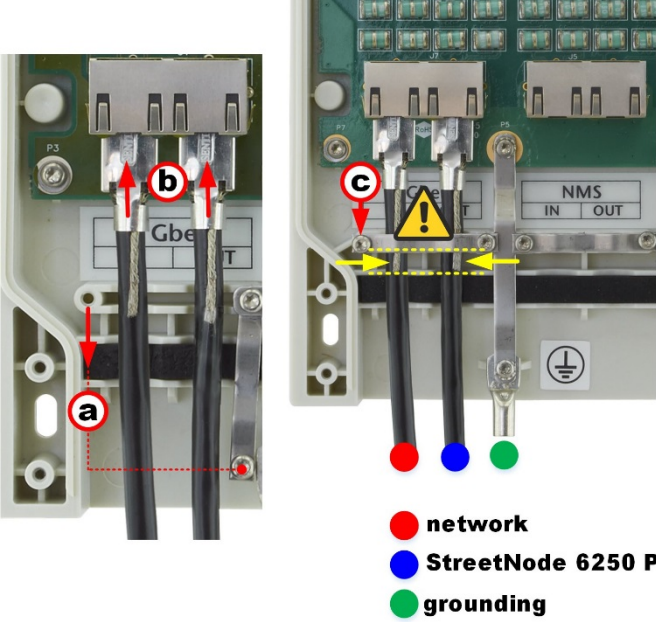
Step	Action
2	<p>Prepare and terminate the Ethernet cables (x 2) as instructed in Appendix A: Terminating Ethernet (S-FTP) Cable on page 67.</p> <p>Install the Ethernet cables, as follows:</p> <ol style="list-style-type: none"> Use a tamper-proof torx screwdriver T10 to remove the screw and release the clamp: Be careful not to drop the screws while removing. Plug the Ethernet cables to the GbE receptacles (OUT: goes to StreetNode™ 6250 PTP GbE2 and IN: goes to network) Use a tamper-proof torx screwdriver T10 to screw (applying maximum tightening torque of 0.9 Nm) the clamp for securing the cables in place. <p> The shielded wires should protrude from clamp about 0.5 cm (see yellow below).</p>  <p>● network ● StreetNode 6250 PTP GbE2 port ● grounding</p>

Continued on next page

Installation of Power Injector (Power over Ethernet), Continued

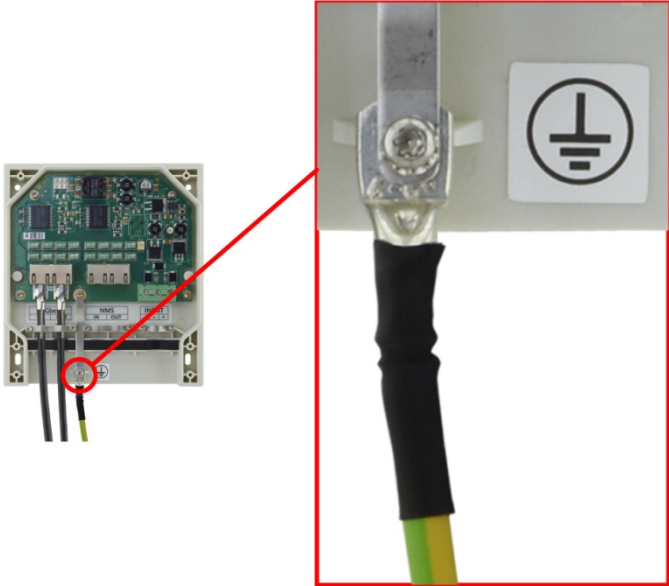

Mechanical and cabling installation (PoE), continued

Step	Action
3	<p>Prepare and terminate the grounding cable as instructed in Appendix C: Terminating Grounding cable on page 76.</p> <p>Install the grounding cable, as follows:</p> <p>Use a tamper-proof torx screwdriver T10 to remove the screw and then install the terminal ring.</p> <div style="text-align: center;">  </div> <p>Use the tamper-proof torx screwdriver T10 to screw (applying maximum tightening torque of 0.9 Nm) for securing the cable in place.</p>

Continued on next page

Installation of Power Injector (Power over Ethernet), Continued

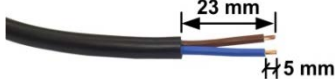
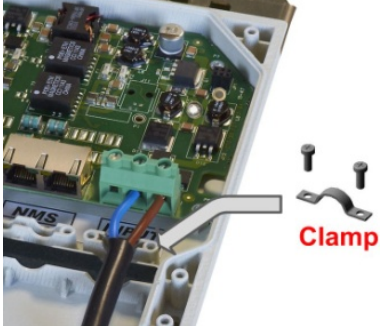
Mechanical and cabling installation (PonE), continued

Step	Action
4	<p>Install the power supply cable, as follows:</p> <p> Switch-off the Local DC Power Source & the circuit breaker connected between PonE and the Local DC Power Source.</p> <p>a. Connect the power cable to the Local DC Power Source (Brown wire: +V, blue wire: -V).</p> <p>b. At the other end of the cable, use a blade to strip the wires of the cable, as shown below. Twist strands well to facilitate their insertion into the receptacle of PonE device.</p>  <p>c. Use the tamper-proof torx screwdriver T10 to remove the clamp and insert the bare ends of the cable well into the corresponding positions of the receptacle, as shown below: Blue wire to INPUT -, Brown wire to INPUT +.</p>  <p>d. Use a flat-headed screwdriver to tighten the two screws on top of the receptacle to secure strands.</p> <p>e. Use the tamper-proof torx screwdriver T10 to screw (applying maximum tightening torque of 0.9 Nm) the clamp for securing the cables in place.</p> <p> Do not exceed the maximum tightening torque. Equipment damage will be occurred.</p> <p> Note The screws, securing the wire strands into the receptacle, are well isolated each other – no danger for accidental short circuit.</p>

End of procedure.

Continued on next page

Installation of Power Injector (Power over Ethernet), Continued

Cabling installation (PoE)

To install Ethernet and power cables , proceed as follows:

Step	Action
1	Prepare and terminate the Ethernet cables (x 2) as instructed in Appendix A: Terminating Ethernet (S-FTP) Cable on page 67.
2	Connect the receptacle OUT of the PoE to the GbE2 receptacle of the StreetNode™ 6250 PTP. Connect the receptacle IN of the PoE to the network switch.
3	Install the IEC plug to the respective input of the PoE an the other plug to the available main socket.

End of the procedure.

Appendix A: Terminating Ethernet (S-FTP) Cable

Introduction

The equipment to which you connect the cable requires a different way of cable termination.

Mainly there are two types of cable termination, as shown below:

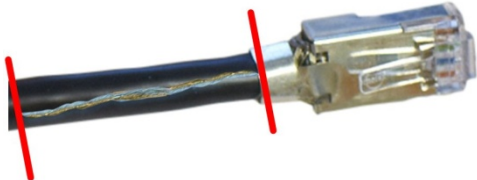
#Termination Type	Detail	Equipment to Connect
A	<p>No shield wires exposed</p> 	All, except PonE.
B	<p>Shield wires (twisted) exposed</p> 	PonE only.

Parts of RG-45 jack

The RJ-45 jack (for terminating the S-FTP cable) is composed of two parts:

- the main body and
- the wire guide (with numbering).

(Photo below shows the parts for a pair of RJ-45 jacks).

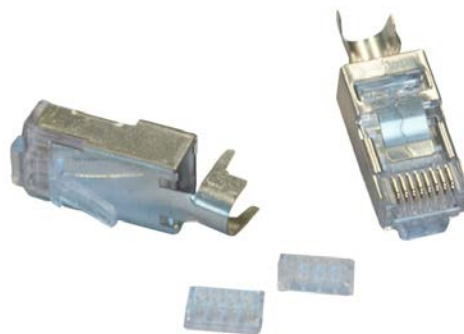

Continued on next page

Appendix A: Terminating S-FTP Cable, Continued

Termination procedure

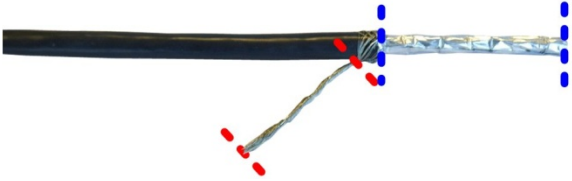
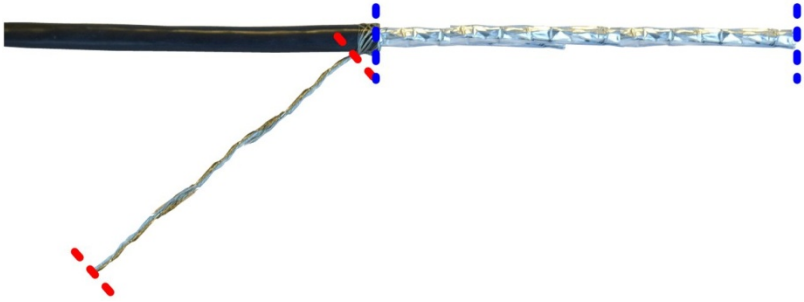
Step	Action
1	<p>a. For termination type A: Strip 40 mm of outer jacket.</p> <p>For termination type B: Strip 80 mm of outer jacket.</p> <p>b. Fold shield back (over the jacket).</p> <p>c. For termination type A: Twist shield wires together and allow 10 mm of shield to surround jacket's end.</p> <p>For termination type B: Twist shield wires together and allow 20 mm of shield to surround jacket's end.</p> <p>d. Completely remove the exposed foil.</p> <p>For termination type A:</p>  <p>For termination type B:</p> 

Continued on next page

Appendix A: Terminating S-FTP Cable, Continued

Termination
procedure,
continued

2 Untwist wire pairs and arrange according to the T-568 standard.

Straight-through cable (concerns the Ethernet cable connected to PoE's IN or StreetNode's traffic input port):

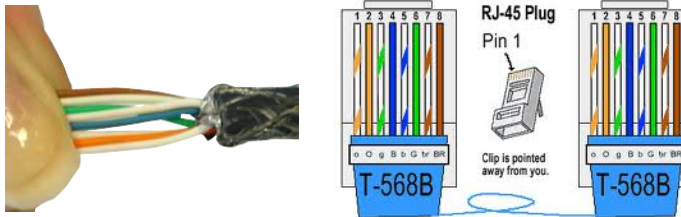

Cross-over cable (concerns the Ethernet cable connecting PoE with the OSDR):

(The green set of wires should be switched in place with the orange set of wires.)

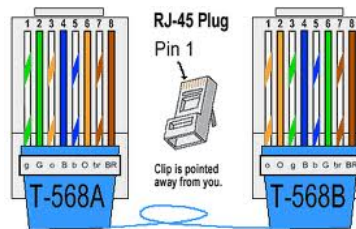

Continued on next page

Appendix A: Terminating S-FTP Cable, Continued

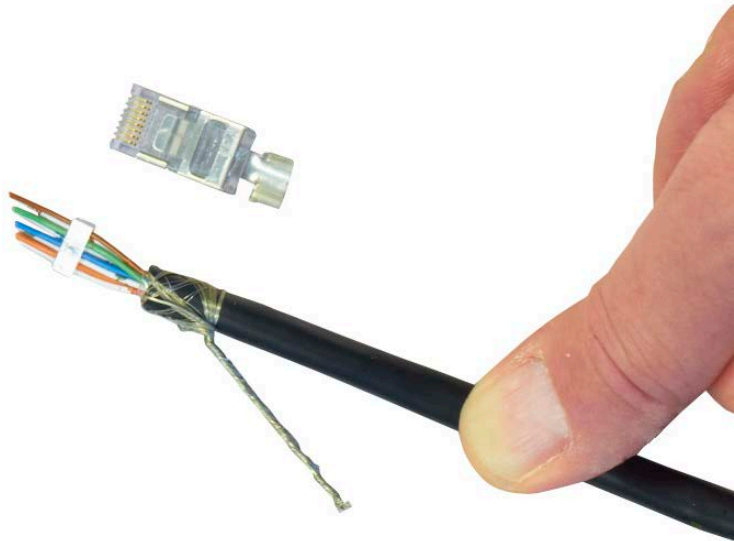
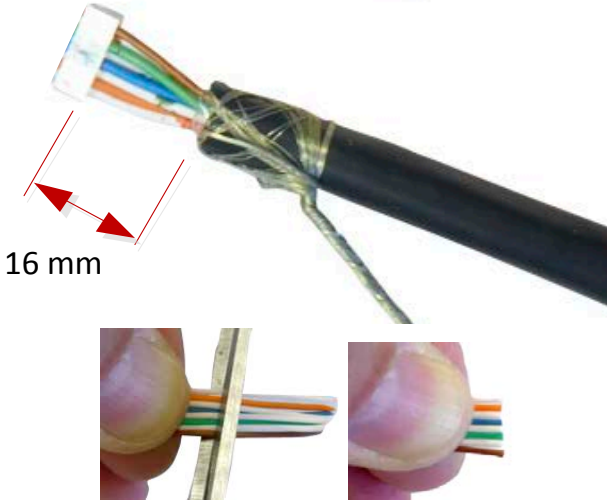

Termination procedure
(continued)

Step	Action
3	<p>Carefully insert the eight wires into the cavity of the wire guide so that its numbering is visible from the top.</p> 
4	<p>Measure 16 mm from the jacket's end and cut all wires protruding from the guide.</p> 

Continued on next page

Appendix A: Terminating S-FTP Cable, Continued

Termination
procedure,
continued

Step	Action
5	<p data-bbox="552 461 1378 607">a. Fold back the crimping terminal of the connector. b. Fully insert wire guide and cable into the connector's body until the shield (overlapping the jacket's end) reaches the crimping position.</p> <p data-bbox="552 663 874 696">For termination type A:</p>  <p data-bbox="552 999 874 1032">For termination type B:</p> 

Continued on next page

Appendix A: Terminating S-FTP Cable, Continued



Termination procedure, continued

Step	Action
6	Terminate the wires onto the RJ-45 jack. 

Continued on next page

Appendix A: Terminating S-FTP Cable, Continued

Termination
procedure
(continued)

Step	Action
7	<p data-bbox="536 412 1404 510">With the pliers, bring the terminal of the connector back, over the exposed shield, and press gently around the terminal to form. This will achieve good contact with the shield.</p> <p data-bbox="552 560 874 591">For termination type A:</p>  <p data-bbox="552 1182 874 1214">For termination type B:</p> 

Continued on next page

Appendix A: Terminating S-FTP Cable, Continued

Termination procedure (continued)

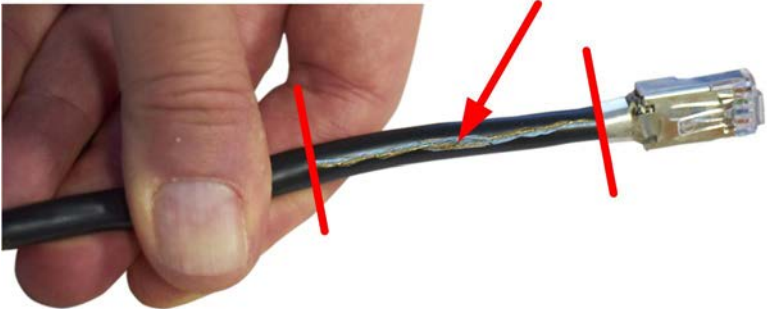

Step	Action
8	<p>With a wire cutter, trim away any braid leftovers extending beyond the end of the plug.</p> <p>When finished, termination should look as below:</p> <p>For termination type A:</p>  <p>For termination type B:</p> 
9	<p>Using the Ethernet tester, test cable for proper wire termination and continuity.</p>

End of procedure.

Appendix B: Terminating Power Supply Cable

Procedure

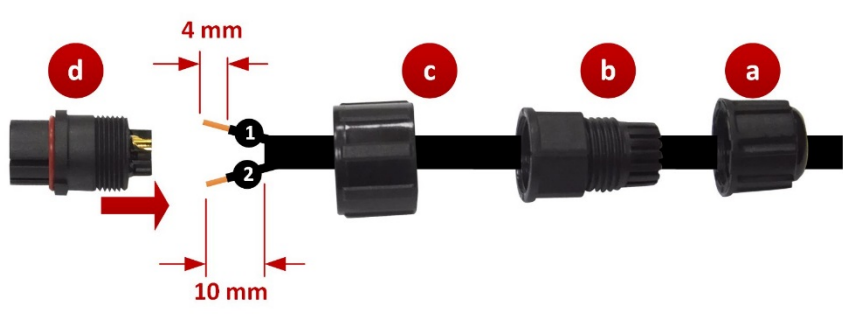
To terminate the power supply cable (AC or DC) to the respective connector⁽¹⁾ of StreetNode™ 6250 PTP, proceed as follows:

Step	Action
1	Strip approx. 10 mm from the cable's outer sheath.
2	Pass the connector parts a, b and c over the cable's end, as shown below: 
3	Strip approx. 4 mm from each wire insulation and solder to the pins of connector part d. For the DC connector (2-pin): There is no polarity concern. Each one of the two wires (1 or 2) can be soldered to any of the two pins of the connector. For the AC connector (3-pin): The AC Mains Earth (E) Yellow / Green wire must be soldered to the pin shown below with an arrow (the photo shows the connector underside and more specifically the StreetNode-facing side). The remaining two black wires marked (1) and (2) are for Live (L) and Neutral (N) and must be soldered to the other two pins. There is no polarity concern regarding these two specific wires (1 and 2). 
4	Assemble the connector by tightening all parts together.

End of procedure.

⁽¹⁾ The above procedure is based on the use of cables with order codes **AC-PWR-CAB** & **DC-PWR-CAB-1** (see Power cables on page [7](#))

Appendix C: Terminating Grounding cable



Topics

This paragraph describes the following procedures of grounding cable termination:

- StreetNode™ 6250 PTP
- PonE

StreetNode™ 6250 PTP

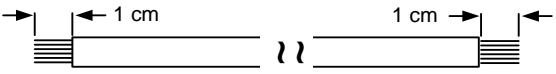
How to terminate the grounding cable of StreetNode™ 6250 PTP, proceed as follows:

Step	Action
1	Cut the grounding cable ⁽¹⁾ according to the distance between StreetNode™ 6250 PTP and grounding bar.
2	Use the blade to strip 1 cm from each end of the cable. 
3	Perform the following: <ol style="list-style-type: none"> Slide the M5 terminal ring over the wires at one end of the cable and crimp it with the special crimping tool (for 16 mm²). Cut the heat shrinkable tube in the middle in two equal pieces in order to use one piece per cable side. Slide the one piece of the heat shrinkable tube over the cable. Heat it over rear grounding ring body and down on to cable jacket using the hot air blower.
4	Repeat step 3 for the other end of the cable using the appropriate terminal ring. <ul style="list-style-type: none"> • M5 ring (StreetNode™ 6250 PTP side). • Appropriate ring (grounding terminal side). 

End of procedure.



Continued on next page

⁽¹⁾ If the distance is more than 2 m then use the cable [GND-CAB16-ID](#) or [GND-CAB16-OD](#).

Appendix C: Terminating Grounding cable, Continued

PonE

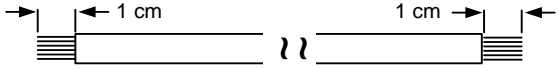
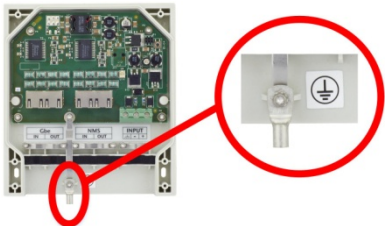
How to terminate the grounding cable of StreetNode™ 6250 PTP, proceed as follows:

Step	Action
1	Cut the grounding cable according to the distance between PonE and grounding bar.
2	Use the blade to strip 1 cm from each end of the cable. 
3	Perform the following: <ol style="list-style-type: none"> Use the tamper-proof torx screwdriver T10 to unscrew the terminal ring from PonE, as shown below: <div style="text-align: center;">  </div> Slide the M4 terminal ring over the wires at one end of the cable and crimp it with the special crimping tool (for 6 mm²). Cut the heat shrinkable tube in the middle in two equal pieces in order to use one piece per cable side. Slide the one piece of the heat shrinkable tube over the cable. Heat it over rear grounding ring body and down on to cable jacket using the hot air blower.
4	Repeat step 3 for the other end of the cable using the appropriate terminal ring. <ul style="list-style-type: none"> • M4 ring (PonE side). • Appropriate ring (grounding terminal side) 
5	Use the tamper-proof torx screwdriver T10 to screw (applying maximum tightening torque of 0.9 Nm) for securing the ring in place.

End of procedure.

Appendix D: Removing StreetNode 6250 PTP

Procedure



To remove a StreetNode™ 6250 PTP, proceed as follows:

Step	Action
<p>1</p>	<p>Use the StreetNode™ 6250 PTP anchor point (see below) to install an appropriate safety lanyard.</p> <p><i>This will provide extra safety during StreetNode™ 6250 PTP removal and transportation.</i></p> 
<p>2</p>	<ol style="list-style-type: none"> a. Disconnect StreetNode™ 6250 PTP from AC power supply (power supply side). b. Remove the Ethernet and power supply cables from the bottom of the StreetNode™ 6250 PTP.

Continued on next page

Appendix D: Removing StreetNode 6250 PTP, Continued

Procedure
(continued)

Step	Action
3	<p>Using the electrical screwdriver, extension and 8 mm bit, remove the safety screw from the side of the StreetNode™ 6250 PTP mounting plate.</p> 
4	<p>Using the electrical screwdriver, extension and 8 mm bit, loosen the four screws securing StreetNode™ 6250 PTP on the mounting plate.</p> 

Continued on next page

Appendix D: Removing StreetNode 6250 PTP, Continued

Procedure
(continued)

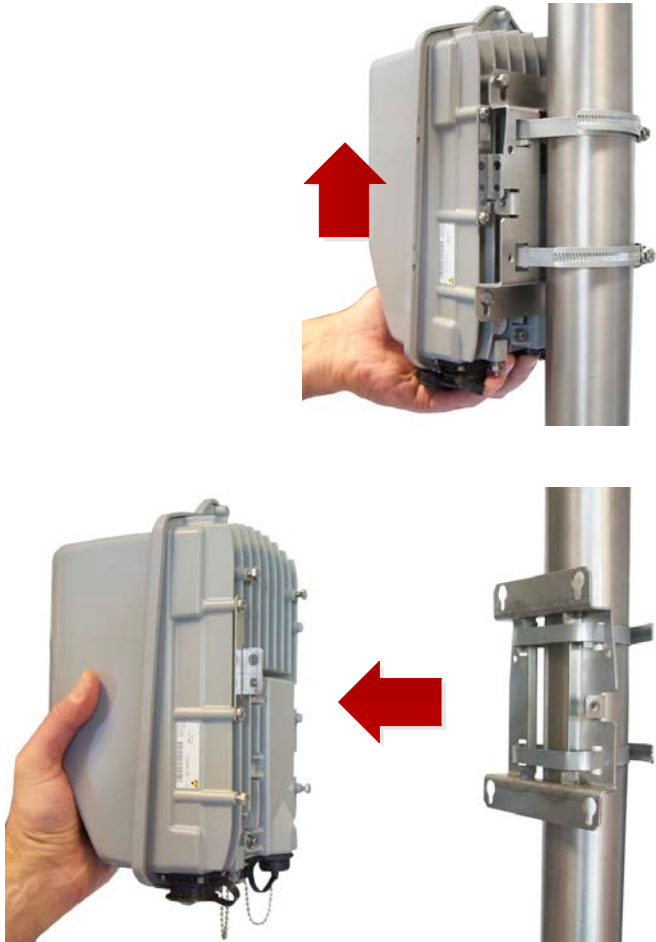
Step	Action
5	<p>Lift and extract StreetNode™ 6250 PTP.</p> <p><i>You can now safely transport StreetNode™ 6250 PTP to ground level.</i></p> 

End of procedure.

Appendix E: Standards of Compliance

This product is in full compliance with the following standards:

Radio/Use of Spectrum:

ETSI EN 302217-3 v2.2.1 : 2014
ETSI EN 302217-4-2 v1.5.1 : 2010 (antenna)
FCC Part 15.255

EMC / EMI :

ETSI EN 301 489-1 v1.9.2: 2011
ETSI EN 301 489-4 v2.1.1 : 2012
EN 55022:2010
EN 61000.3-2:2006 +A1:2009 +A2:2009
EN 61000-3-3:2008
FCC Part 15 Subpart B

Health and Safety:

EN 60950-1:2006 +A11:2009 +A1:2010 +A12: 2011
EN 60950-22: 2006
EN 50385 : 2002
EN 60215:1989 +A1:1992 +A2:1994
IEC/UL/CSA 60950-1
IEC/UL/CSA 60950-22

RoHS : EN 50581 :2012

Eco Design: CR (EC) No. 278/2009

Environmental:

ETSI EN 300019-2-4 V2.2.2, Class 4.1 / (Mechanical 4M5) (Operation)
(Within Spec Operating temperatures: -33°C to +55°C, Operational at -50°C).
IEC 60529, Class IP67 (Protection against dust and water)
ETSI EN 300 019-2-2 v2.1.2, Class 2.3 (Transportation)
ETSI EN 300 019-2-1 v2.1.2, Class 1.2 (Storage)

(Page intentionally left blank)

(Page intentionally left blank)