

# *IP*Series Base Station User Manual

Released: September 4, 2003

IPMN p/n: 516.80499.UM

Revision: A

16842 Von Karman Avenue, Suite 200 Irvine, CA 92606  
Voice: (949) 417-4590 Fax: (949) 417-4591  
[www.ipmobilenetinc.com](http://www.ipmobilenetinc.com)

## DOCUMENT REVISION CONTROL

---

Document Title: *IPSeries Base Station User Manual*

New Release Version: A

New Release Date	Previous Version	Action	Old Pages	New Pages
09/04/03	--	Release Revision A	N/A	N/A

## COPYRIGHTS STATEMENT

---

The *IPSeries Base Station User Manual* is copyrighted to *IPMobileNet, Inc.*

**All rights reserved.** This document is confidential and proprietary information of *IPMobileNet, Inc.* The distribution or duplication of this document is expressly forbidden without *IPMobileNet's* prior written consent.

**Disclaimer.** While reasonable efforts were made to ensure that the information in this document was complete and accurate at the time of printing, *IPMobileNet, Inc.* can assume no responsibility for any inaccuracies. Changes and corrections to the information within this document may be incorporated in future releases.

<b>MANUAL COMPONENTS</b> .....	4
Manual Purpose .....	4
Manual Contents .....	4
Manual Use .....	5
Audience.....	5
<b>CHAPTER 1: INTRODUCTION</b> .....	6
Product Description.....	6
Product Functionality .....	6
External Features .....	7
Product Specifications.....	9
Theory of Operation .....	10
<u>Block Diagram Definitions</u> .....	10
<b>CHAPTER 2: BASIC NETWORK CONFIGURATIONS</b> .....	12
Basic Network Connection.....	12
Network Connection to an Existing LAN.....	13
<b>CHAPTER 3: PRODUCT SETUP AND PRELIMINARY TESTING</b> .....	14
Base Station Setup .....	14
<u>Rack Unit Mounting</u> .....	14
Preliminary Testing.....	15
<u>Checklist for Required Material for Preliminary Testing</u> .....	15
Preliminary Testing Procedure.....	16
<b>CHAPTER 4: PRODUCT INSTALLATION</b> .....	17
Installation Overview.....	17
Adjusting the Power .....	18
Installation Instructions.....	21
<u>Interconnection Diagram</u> .....	21
<u>Base Station Installation into the Rack Unit</u> .....	21
<u>Single Base Station Configuration</u> .....	23
<u>Multiple Base Station Configurations</u> .....	23
<u>Typical Antenna Configuration</u> .....	24
Near-Field Exclusion Zone .....	25
<u>Power Connection</u> .....	26
<u>Post Installation Checklist</u> .....	27
<b>CHAPTER 5: PROGRAMMING INSTRUCTIONS</b> .....	28
Overview.....	28
HyperTerminal Setup .....	28
Factory Default Save and Restore .....	30
Additional Programming Needs .....	30
<b>CHAPTER 6: CUSTOMER SUPPORT</b> .....	31
Ordering Parts .....	31
Customer Support.....	31
Reporting Problems with the Documentation .....	31
<b>APPENDIX A: Backhaul Requirements</b> .....	32
<b>APPENDIX B: Base Station IPMessage Parameters</b> .....	34
<b>FIGURE LISTING</b> .....	37
<b>GLOSSARY</b> .....	38
<b>INDEX</b> .....	42

## Manual Purpose

The purpose of the *IPSeries* Base Station User Manual is to provide *IPMobileNet* dealers and customers with the necessary information required to install, operate, and troubleshoot problems with the *IPSeries* base station.

## Manual Contents

This user manual contains the following sections:

- Chapter 1: Introduction

The *Introduction* provides a description of the base station as well as a general overview of its functionality, product interfaces, and theory of operation with a block diagram and definitions.

- Chapter 2: Basic Network Configurations

*Basic Network Configurations* provides a series of network diagrams depicting possible network configurations.

- Chapter 3: Product Setup and Preliminary Testing

*Product Setup and Preliminary Testing* provides a diagram and information required for mounting the base station in a rack unit as well as preliminary testing prior to putting the base station into service.

- Chapter 4: Product Installation

*Product Installation* provides diagrams and instructions for installing the base station and other required components.

- Chapter 5: Programming Instructions

*Programming Instructions* provides programming and setup instructions for setting up the base station and its interfaces.

- Chapter 6: Customer Support

*Customer Support* provides instructions for ordering parts, documentation support, and reporting problems.

- Appendix A: Backhaul Requirements

- Appendix B: Base Station *IPMessage* Parameters

- Figure Listing

- Glossary

- Index

**Manual Use**

Special icons appear throughout this manual to emphasize important information related to the chapter in which the icons are found. The definitions for these icons are listed below.

- 1 It is imperative that the user read this section carefully prior to continuing to the next chapter of this user manual.

TABLE 1: ICON HELPS		
ICON	INDICATES	DEFINITION
	<b>NOTE</b>	This icon indicates that a note follows highlighting or stressing a special point.
<u>1</u>	<b>CAUTION</b>	This icon indicates that a precautionary message follows. <u>Carefully read the message following this icon and proceed with caution.</u>

**Audience**

This user manual is intended for specific use by *IPMobileNet*, Inc. staff, dealers, and customers. This user manual is not to be reproduced without expressed written consent of *IPMobileNet* Management.

## Product Description

 The content of this manual applies to all frequency ranges of the *IP*Series Base Stations, unless otherwise specified. This manual will note key differences when appropriate.

The *IP*Series Base Stations are intelligent devices designed for the stringent requirements of mobile data communication systems. Intended for mounting in rack units, the base station requires very little room at tower sites and may be connected to via Serial Line Internet Protocol (SLIP) ports or Ethernet. The base station circuit boards are built using surface mount technology (SMT) and through-hole components. At the minimum, the unit requires a 13.8 VDC power supply, antenna system, and high-speed data connection to an Internet Protocol Network Controller (IPNC) system to operate. The base station is typically teamed up with a Power Amplifier (PA) and third-party system components such as antennas, preamplifiers, preselectors, filters, and combiners.



Figure 1: *IP*Series Base Station External Illustration (Front View)

## Product Functionality

The base station utilizes an internal high-performance 4-level Frequency-Shift Keying (FSK) wireless data modem (19200 bps) for 25 kHz channel spacing, a multi-layered approach to signaling reliability, including patented multi-receiver Intelligent Diversity Reception™, dynamic scrambling, data interleaving for burst error protection, Forward Error Correction (FEC), and Viterbi soft-decision algorithms.

The *IP*Series Base Station technology includes *IP*MobileNet's Diversity Reception (DR) capability. Diversity Reception reduces the number of fades and the effects of multi-path reception. With the use of three (3) antennas, mounted as far apart as possible on the base station tower, the Diversity Reception System (DRS) minimizes the effects of fading. One of the antennas is likely to receive a viable signal while the others may not. DRS minimizes fading effects by comparing the signal levels from the three (3) antennas, and selecting the strongest signal.

 Diversity is most effective when the vehicle using an *IP*Series Mobile Radio is in motion.

**External Features**

The base station technology is enclosed in a sturdy aluminum case.

- 1 The product warranty becomes void if an uncertified or unauthorized individual removes the base station cover.

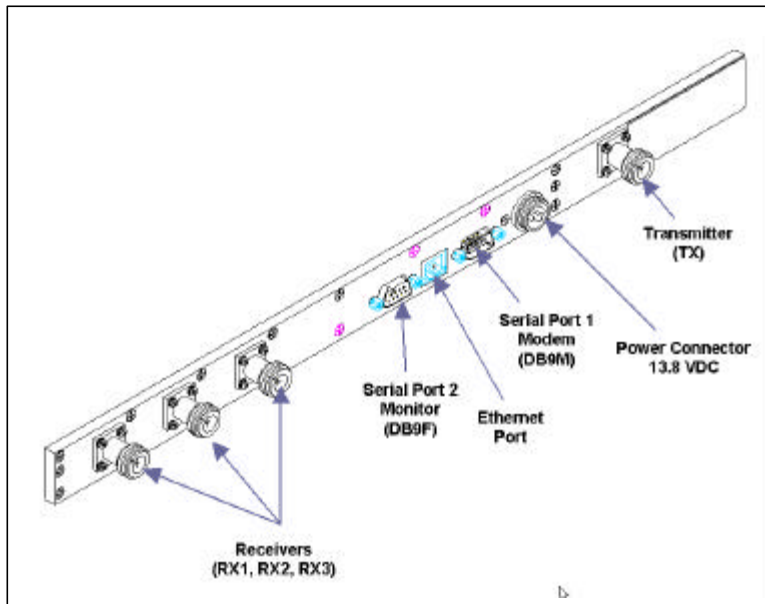

Figure 2: External Connectors of an IP Series Base Station (Rear View)

The base station's rear external connectors consist of the following components:

<b>TABLE 2: EXTERNAL FEATURES (Rear)</b>	
<b>FEATURE</b>	<b>DESCRIPTION</b>
TX	Transmitter antenna connection
RX1/RX2/RX3	Receivers 1, 2, and 3 antenna connections
Power Connector	13.8 VDC base station power connector
Serial Port 1 (DB9M)	RS232 Serial Line Internet Protocol (SLIP) interface port
Serial Port 2 (DB9F)	ANSI/TTY Terminal Connection (used for programming) (9600 bps, no parity, 8-databits, 1-stop bit)
Ethernet Port	RJ45 Ethernet 10 Base T interface port

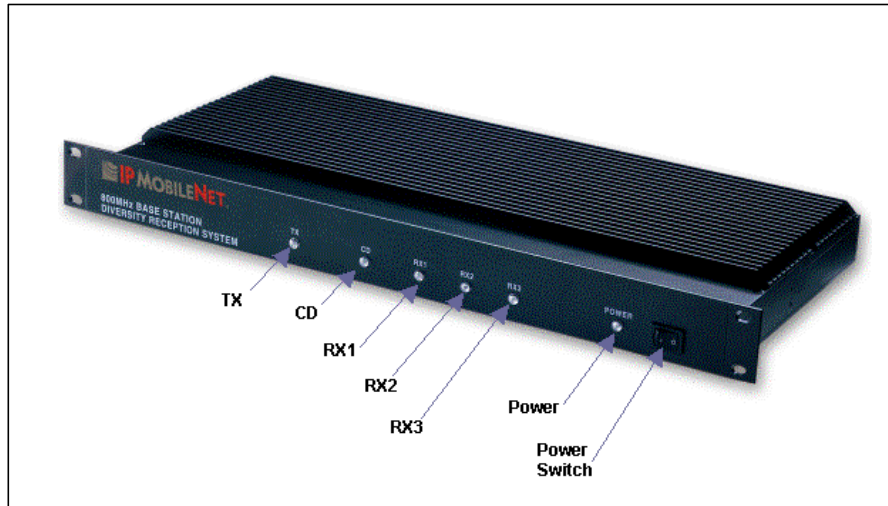

Figure 3: External Features of an *IP*Series Base Station (Front View)

The base station's front external features consist of six (6) LED (light emitting diodes) indicators defined as follows:

TABLE 3: EXTERNAL FEATURES (Front)	
LED Name	When lit....
TX	Indicates that transmission is in progress
CD	Carrier detect indicates an RF message is detected
RX1	Indicates that receiving is progress on Receiver 1
RX2	Indicates that receiving is progress on Receiver 2
RX3	Indicates that receiving is progress on Receiver 3
POWER	Indicates the base station is powered on



**Product Specifications**
**TABLE 4: PRODUCT SPECIFICATIONS**
**GENERAL SPECIFICATIONS**

<b>PARAMETER</b>	<b>Specification IP100</b>	<b>Specification IP400</b>	<b>Specification IP800</b>
frequency range	135 to 175 MHz	400 to 512 MHz	806 to 869 MHz
channel spacing / speed	12.5 kHz / 9600 bps 25.0 kHz / 19200 bps	12.5 kHz / 9600 bps 25.0 kHz / 19200 bps	12.5 kHz / 9600 bps 25.0 kHz / 19200 bps
mode of operation	full-duplex, diversity reception	full-duplex, diversity reception	full-duplex, diversity reception
operating temperature range	-30C to +60C (-22F to +140F)	-30C to +60C (-22F to +140F)	-30C to +60C (-22F to +140F)
power supply voltage	13.8 VDC +/-20%	13.8 VDC +/-20%	13.8 VDC +/-20%
power supply	<1 amps receive	<1 amps receive	<1 amps receive
current consumption	16 amps transmit	13 amps transmit	8 amps transmit
number of channels	256	256	256
intelligent diversity reception	triple receiver, diversity reception	triple receiver, diversity reception	triple receiver, diversity reception
antenna connections	four (4) type N jacks (tx, rx1, rx2, rx3)	four (4) type N jacks (tx, rx1, rx2, rx3)	four (4) type N jacks (tx, rx1, rx2, rx3)
interface connection	RS232 serial port connector or RJ45 Ethernet 10 Base T	RS232 serial port connector or RJ45 Ethernet 10 Base T	RS232 serial port connector or RJ45 Ethernet 10 Base T
dimensions (HxWxD / lbs)	1.75" X 19" X 8.2" / 9.5 lbs	1.75" X 19" X 8.2" / 9.5 lbs	1.75" X 19" X 8.2" / 9.5 lbs
regulatory	FCC Part 90 and Part 15	FCC Part 90 and Part 15	FCC Part 90 and Part 15

**IP TRANSMITTER SPECIFICATIONS**

<b>PARAMETER</b>	<b>Specification IP100</b>	<b>Specification IP400</b>	<b>Specification IP800</b>
frequency stability	+/- 2.4 ppm @ operating temp	+/- 1.5 ppm @ operating temp	+/- 1.0 ppm @ operating temp
emission designator	20KF01D	20KF01D	20KF01D
spurious and harmonic	-61 dBc max	-59 dBc max	-56 dBc max
transmit power	60 watts	40 watts	20 watts
transmit attack time	less than 5 ms	less than 5 ms	less than 5 ms

**IP RECEIVER SPECIFICATIONS**

<b>PARAMETER</b>	<b>Specification IP100</b>	<b>Specification IP400</b>	<b>Specification IP800</b>
sensitivity (voice)	12.0 dB SINAD@ -119 dB max level	12.0 dB SINAD@ -118dB max level	12.0 dB SINAD@ -118dB max level
distortion	less than 3% @ 1.0 kHz	less than 3% @ 1.0 kHz	less than 3% @ 1.0 kHz
spurious response	85 dBm minimum	85 dBm minimum	85 dBm minimum
intermodulation distortion	75 dB minimum	75 dB minimum	75 dB minimum

**Theory of Operation**

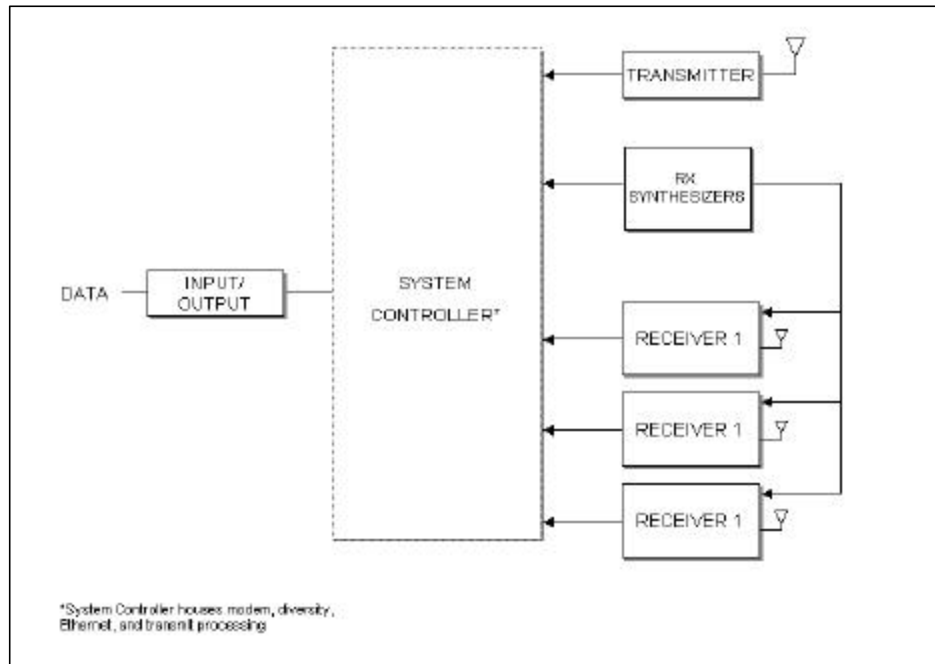



Figure 4: General Block Diagram

Block Diagram Definitions

 For increased data security, the modem supports the U.S. Government developed Digital Encryption Standard (DES) data encryption and decryption protocols. This capability requires installation of third-party Internet Protocol (IP) compliant DES encryption and decryption software.

The standard *IP*Series Base Station circuit board contains five (5) main sections defined below:

**Input/Output**

Circuitry associated with one of the following base station's data connectors:

- ❑ RS232 Serial Port DB9 Data Connector
- ❑ RJ45 Ethernet 10 Base T Interface Connection

 For further details on the Ethernet Controller refer to the Crystal LAN™ Ethernet Controller Product Bulletin (CS8900A-EthernetCtrlr.pdf) available on the Product Documentation CD.

**System Controller**

Houses the modem, diversity, and Ethernet circuitry. Manages the operation of the base station's modem providing transmit timeout protection in the event a fault causes the base station to become halted in the transmit mode. The system controller also handles the loading of selected transmit and receive frequencies into the injection synthesizer. Includes memory for storage through Electrically Erasable Programmable Read Only Memory (EEPROM) of the base station's

operating parameters, which are retained after the base station's power is cycled off.

<u>Modems</u>	Convert data into an analog audio waveform for transmission and analog audio from the receiver to serial data interface. There is one (1) modem that is dedicated to the transmit operation and two (2) modems dedicated to the receive operation. The modem dedicated to the transmit supports a 115.2 KBPS data transmission rate on the serial port, SLIP protocol, and a 19.2 KBPS OR 9.6 KBPS over-the-air data transmission rate. Provides Forward Error Correction (FEC) and Error Detection (using Cyclic Redundancy Check or CRC), bit interleaving for more robust data communications, and third generation collision detection and correction capabilities.
<u>Diversity Reception</u>	Circuitry selects one of three (3) diversity receiver audio outputs for processing by the modem by comparing the Received Signal Strength Indication (RSSI) output from each receiver. Audio from the receiver with the highest RSSI value is passed to the modems.
<b>RX Injection</b>	The Injection Synthesizer board provides a highly stable local oscillator signal for the three (3) receivers. This displays a serial data input/output interface, synthesizer, and VCO.
<b>Transmitter</b>	Consists of an exciter and a power amplifier module covering various frequency bands in segments. The transmitter power control is included with the power supply circuitry on the same board.
<b>Receiver 1/Receiver 2/ Receiver 3</b>	Uses three (3) discrete receivers tuned to the same frequency. The three (3) receivers are required to support IPMobileNet's base station Diversity Reception System (DRS).  <b>NOTE:</b> Some installations use only two (2) receivers.  The receivers are double-conversion superhetrodynes with an Intermediate Frequency (IF) of 45 MHz. Each receiver consists of bandpass filters, RF amplifiers, a mixer, 45 MHz crystal filter, and a one-chip IF system. The injection synthesizer provides the first local oscillator signal and outputs from each receiver include RSSI and analog audio for Diversity Reception.
<b>Power Supply</b>	Power supply circuitry derives the various operating voltages required by the base station. Fixed voltage regulators are employed through the base station for this purpose.

**Basic Network Configurations**

This section provides basic network connection samples to help the user better understand some of the possibilities in setting up their respective systems.

Basic Network Connection

Figure 5 depicts a basic network connection for a network inclusive of one (1) Internet Protocol Network Controller (IPNC) and a range of base stations, mobile radios, mobile computers, and additional components that can interface with the system.

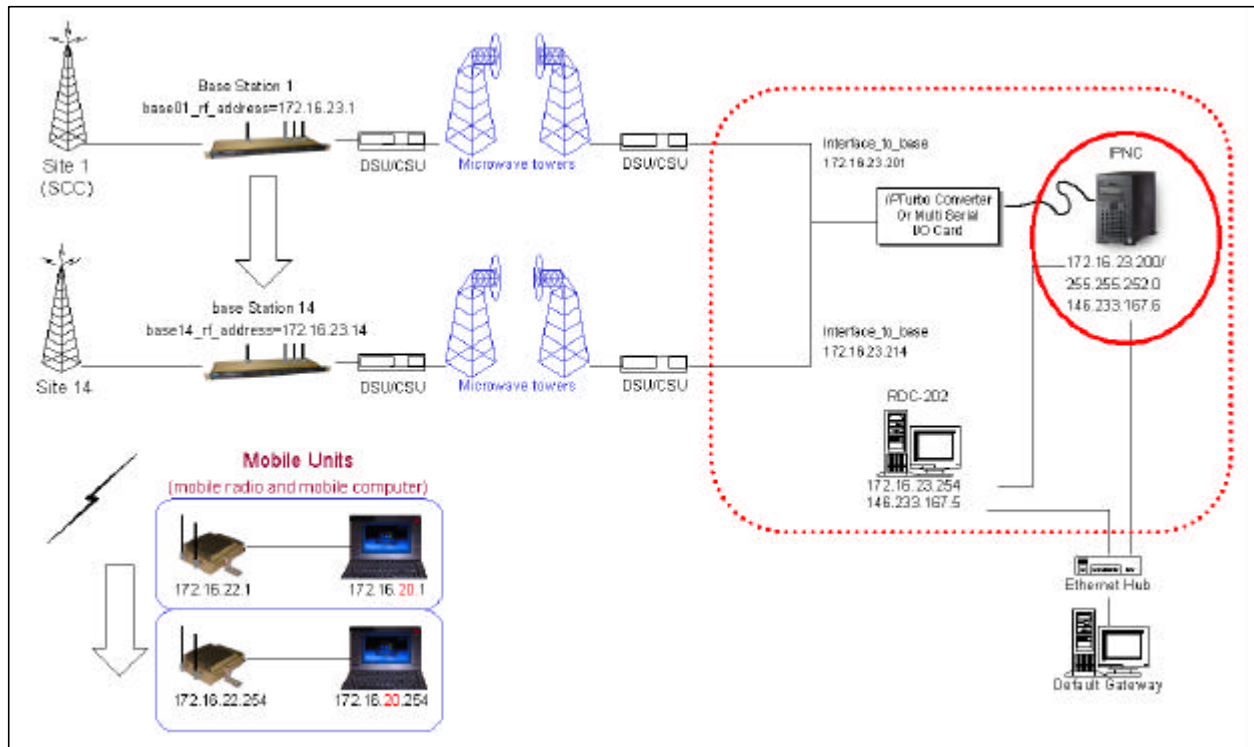



Figure 5: Basic Network Connection

 For serial connectivity to Ethernet only systems, please refer to the *IPTurbo Converter Quick Reference Guide* (IPMN p/n: 516.80496.QR) on the Production Documentation CD (IPMN p/n: 480.0001.001).

Network Connection to an Existing LAN

Figure 6 depicts network connection to an existing LAN (local area network) inclusive of one (1) IPNC, one (1) base station, and a range of mobile radios, VIUs (voice interface units), mobile computers, and additional components that can interface with the system. This diagram also shows a LAN VIU as well as Terminal Server VIU.

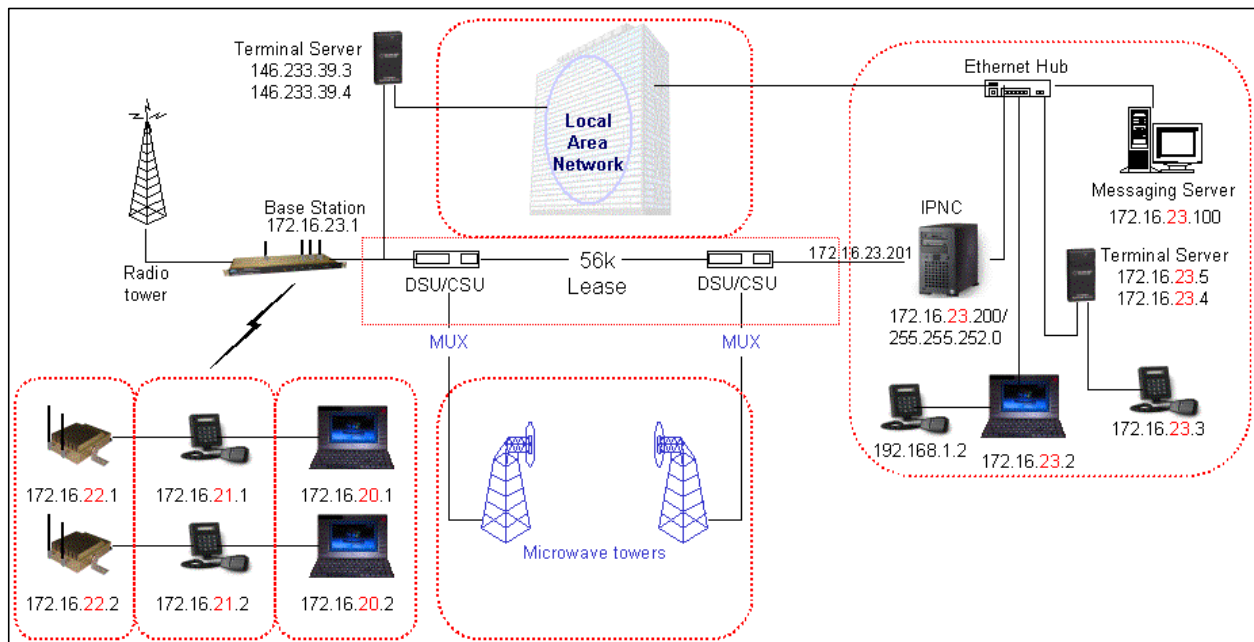



Figure 6: Network Connection to an Existing LAN

 For serial connectivity to Ethernet only systems, please refer to the *IPTurbo Converter Quick Reference Guide* (IPMN p/n: 516.80496.QR) on the Production Documentation CD (IPMN p/n: 480.0001.001).

### Base Station Setup

Intended for rack unit configuration, the base station can be installed in an existing rack or assembled into a rack of its own.

### Rack Unit Mounting

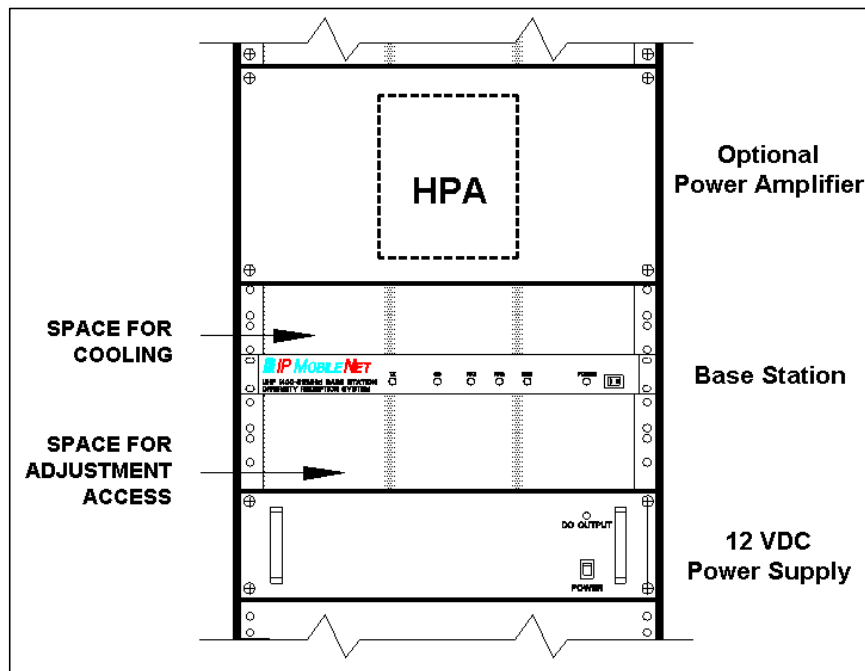



Figure 7: Base Station Mounting in the Rack Unit (Front View)

Table 5 lists the required components for a base station setup.

TABLE 5: BASE STATION COMPONENTS REQUIRED FOR INSTALLATION	
QTY	DESCRIPTION
1	Frequency appropriate <i>IP</i> Series Base Station
1	Ethernet cable
1	5' DC power input cable with connector
4	RF coaxial cables (may require an additional cable if connecting the base station to a power amplifier)

### Preliminary Testing

This section provides a functional preliminary test for the base station prior to installation. It is used to determine the condition of the new base station before placing into service. If the base station is found to be non-functional after completing this test, refer to Chapter 6: Customer Support for the appropriate action.

 This section applies to all base station frequency ranges.

#### Checklist for Required Material for Preliminary Testing

The following checklist provides a list of tools required to perform this preliminary test procedure.

<b>TABLE 6: CHECKLIST OF REQUIRED EQUIPMENT FOR PRELIMINARY TESTING OF A BASE STATION</b>		
<b>1</b>	Calibrated Base Station System – Consisting of the following components: (1) <i>IP</i> Series Base Station (2) Desktop or laptop computer configured as an Internet Protocol Network Controller (IPNC) (3) Corresponding <i>IP</i> Series Mobile Radio tuned to Base Station frequencies (If an IPB138 base, use IP138 mobile) (4) Desktop or laptop computer with two (2) available serial ports and Microsoft Windows 98 or greater, <i>IP</i> MobileNet Dial-Up Networking, <i>IP</i> Message software, and HyperTerminal for base station installed	
<b>2</b>	DC power supply with ammeter, with the appropriate volts, see page 9 <i>Current Consumption</i> for each base station (Astron VS12M or equivalent)	
<b>3</b>	Six (6) antennas (generic mag mounts) tuned to frequency or transceiver	
<b>4</b>	Base Station power cable.	
<b>Serial Base Station Interface</b>		
No.	Requirement	✓
<b>1</b>	DB9 RS232 serial cable	
<b>2</b>	<i>IP</i> TurboConverter (IPMN p/n: 900.00012.01)	
<b>3</b>	<i>IP</i> TurboConverter Quick Reference Guide (IPMN p/n: 516.80496.QR)	
<b>Ethernet Base Stations Interface</b>		
No.	Requirement	✓
<b>1</b>	Ethernet RJ45 Cable	
<b>2</b>	Ethernet Crossover Cable	

Preliminary Test Procedure

Perform the following initial setup to prepare the base station for preliminary test:

- Step 1**            Connect the base station to the 13.8 VDC power supply.
- Step 2**            Power on the base station and verify that the LED's illuminate and the power LED on the front panel remains illuminated.
- Step 3**            Verify that the base station DC-supply current is <1.2 amps.
- Step 4**            For the ideal serial or Ethernet setup please refer to the *IPTurboConverter Quick Reference Guide* (IPMN p/n: 516.80496.QR) available on the Product Documentation CD enclosed with this product.
- Step 5**            Connect the antennas to the mobile radio.
- Step 6**            Power on the mobile radio.
- Step 7**            Connect the antenna to the base station's TX port.
- Step 8**            Recycle the base station power.
- Step 9**            Connect the antennas to the base station's RX1.
- Step 10**           Verify that the RX1 and CD LED's is illuminated when the mobile is attempting to connect. Repeat Steps 9 and 10 with RX2 and RX3.
- Step 11**           From the Mobile PC, open the DOS prompt, then ping the IPNC with the following command:

**ping 172.16.23.200** (or replace with appropriate IPNC IP address).

Press **[ENTER]** and verify that the IPNC responds to the ping request. Also verify that the base station carrier detect (CD) LED is lit followed by the TX LED.



## Installation Overview

This chapter provides the basic setup involved in the installation process of an *IP*Series Base Station. For backhaul requirements, refer to Appendix A of this document.

- 1** Standard considerations such as air flow clearance above the base station for heat dissipation and ensuring adequate space exists behind the base station for the routing of cables are of primary importance.

A minimum clearance of 1 rack space is recommended for natural convection cooling. Adjustment points are available through holes in the base station bottom cover. Sufficient space below the base station should exist to facilitate adjustments.

Coax, power, and interface cabling service lengths with neat routing will make the removal and replacement of the base station easier for functional testing and maintenance purposes.

To prevent injury and damage to the base station, exercise extreme caution throughout the installation process and follow the reminders listed below.

- Follow safety precautions for handling rack unit installations.
- **Do not** alter the components listed in the Installation Requirements section, unless substitutions are noted within this chapter.

### Adjusting the Power

The power output of the base station will depend upon whether it will be used to drive an external power amplifier or transmit directly over-the-air.

 In either case it is important to measure and set the transmitter power output using a wattmeter and dummy load before connecting it to the power amplifier or antenna system.

The base station power is adjusted mechanically by tuning a potentiometer (pot) on the bottom of the base station. Depending upon the model, this pot can be reached through an access hole in the bottom cover on either the exciter board or power amplifier board. Figures 8, 9, and 10 display the Power Adjustment Potentiometer location for the IP1B, IP4B, and the IP8B.

1 Do not use a metal tool to make this adjustment, only use **non-conducting** alignment tools. Equipment will be damaged if this warning is ignored.

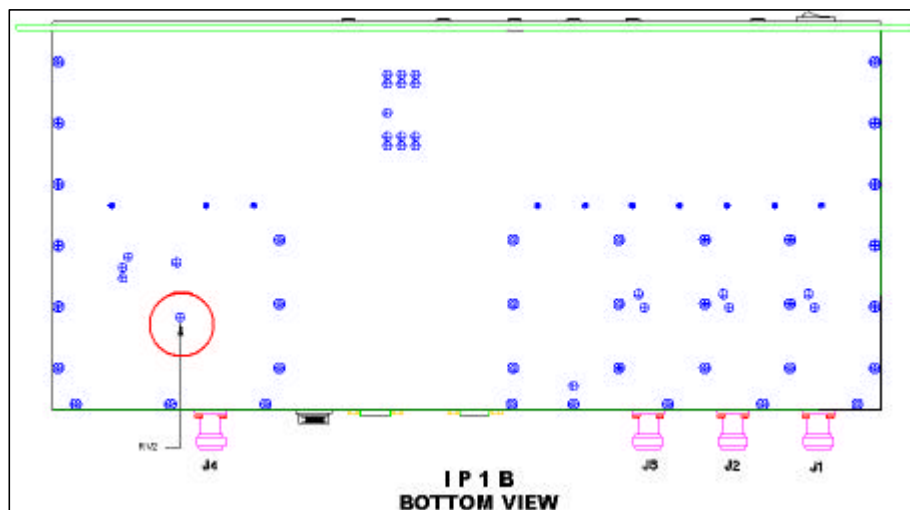

Figure 8: Power Adjustment Potentiometer Location for the IP1B

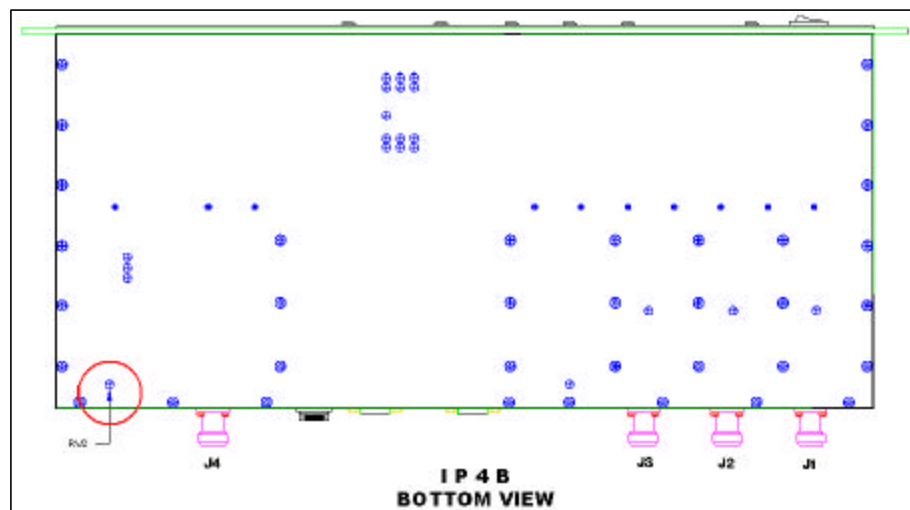

Figure 9: Power Adjustment Potentiometer Location for the IP4B

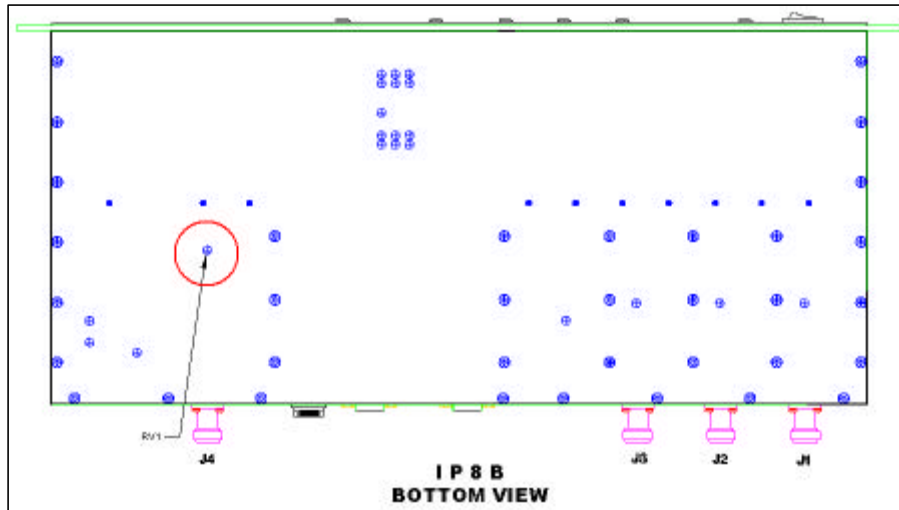



Figure 10: Power Adjustment Potentiometer Location for the IP8B

**Step 1** Connect a computer with the HyperTerminal utility to the base station's monitor serial port.

 Refer to the section titled *HyperTerminal Setup* located in *Chapter 5: Programming Instructions* for HyperTerminal Setup and access instructions.

**Step 2** Launch the HyperTerminal utility.

**Step 3** Locate the adjustment hole (see Figures 8, 9, or 10 according to the model being used).

**Step 4** Fit the tool to the potentiometer.

**Step 5** Key the transmitter on the base station by typing **X=1450,10** in the HyperTerminal window. The base station will generate 10 data packets, each 1450 bytes in length.

 If this does not work, check the base station's MTU parameter. The X=number must be smaller than the MTU value.

**1** To avoid damage to the amplifier, when setting the power to drive an external amplifier, set the base station power below the external amplifier's maximum drive limit.

**Step 6** If setting the power to drive an external amplifier, use a wattmeter and dummy load to measure the output power of the base and set it to the amount of drive power that is will be needed for the amplifier.

 Be aware that the coaxial cable that will connect the base station to the power amplifier may have completely different characteristics to the test cable used to measure power output. If possible, adjust the power with the coaxial cable that will be used in the system ensuring the power measured is exactly what will be fed into the amplifier.

**Step 7** Once the adjustment is made, connect the base station to the external amplifier and connect the wattmeter and dummy load to the amplifier's output.

**Step 8** Measure the power output of the amplifier.



If the amplifier does not produce the expected power, additional adjustments to the base station output are necessary. When making large adjustments in power, the external amplifier should be disconnected from the base station and the base station's power reset.

**1** Do not attempt to make large adjustments to the output power while the base is connected to the external amplifier or if the external amplifier is not producing any power. The base station power adjustment is very sensitive and it is possible to overdrive an external amplifier and ruin it with just small movements of the power adjustment potentiometer. You must be sure to keep the base station's output power below the input drive limit of the external amplifier.

**Step 9** Once the base station power is adjusted, reconnect the base station and the wattmeter to the external amplifier and measure the output power of the external amplifier again using the **X=1450,10** command.

**Step 10** Once the power amplifier is nearly at the proper output, small adjustments can be made to the power output, while the base station is connected. Turning the power adjustment very carefully while transmitting into the external power amplifier will enable the power to be adjusted to exactly the right level.

**1** Be careful not to apply sideways pressure to the adjustment potentiometer, otherwise the circuit can be damaged. Always use a light touch when adjusting base station output power.

## Installation Instructions

-  If setting up a new rack unit, make sure to complete the rack unit setup according to the Manufacturer's instructions.

### Interconnection Diagram

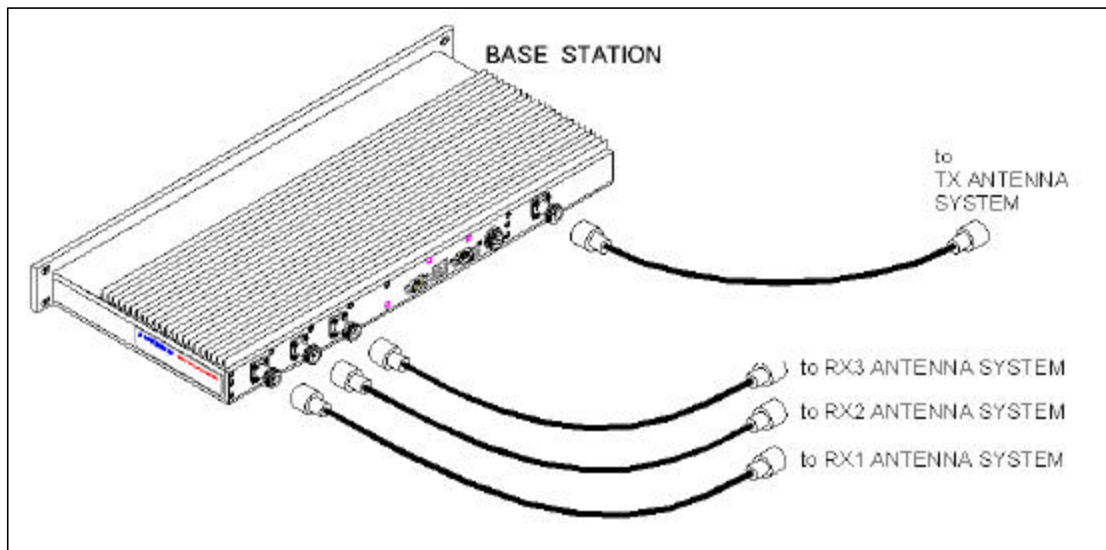



Figure 11: Interconnection Diagram

### Base Station Installation into the Rack Unit

#### Receiver and Transmitter Connections

To connect the base station, perform the following steps:

- Step 1** Connect the RF coaxial cable to Receiver 1 (RX1) on the back of the base station.
- Step 2** Route the cable neatly toward the top of the rack. Allow a little slack in the cable to avoid accidental disconnection.
- Step 3** Connect the RF coaxial cable to Receiver 2 (RX2) on the back of the base station.
- Step 4** Route the cable neatly toward the top of the rack. Allow a little slack in the cable to avoid accidental disconnection.
- Step 5** Connect the RF coaxial cable to Receiver 3 (RX3) on the back of the base station.
- Step 6** Route the cable neatly toward the top of the rack. Allow a little slack in the cable to avoid accidental disconnection.

-  For clear identification for troubleshooting and/or maintenance activities, avoid crossing the coaxial cables.

- Step 7** Connect the RF coaxial cable to the Transmitter (TX) connection on the back of the base station.
- Step 8** If connecting to a power amplifier (as shown in the figure below), connect the cable from the base station to the power amplifier via the Transmitter (TX) connection.
- If not connecting to a power amplifier, skip to Step 11.
- Step 10** If a power amplifier is used, connect an RF coaxial cable to the output port of the power amplifier.
- Step 11** Route the cable neatly toward the top of the rack. Allow a little slack in the cable to avoid accidental disconnection.
- Step 12** To perform the RX1, RX2, RX3, and TX antenna connections, refer to the *Typical Antenna Configuration* section in this chapter.

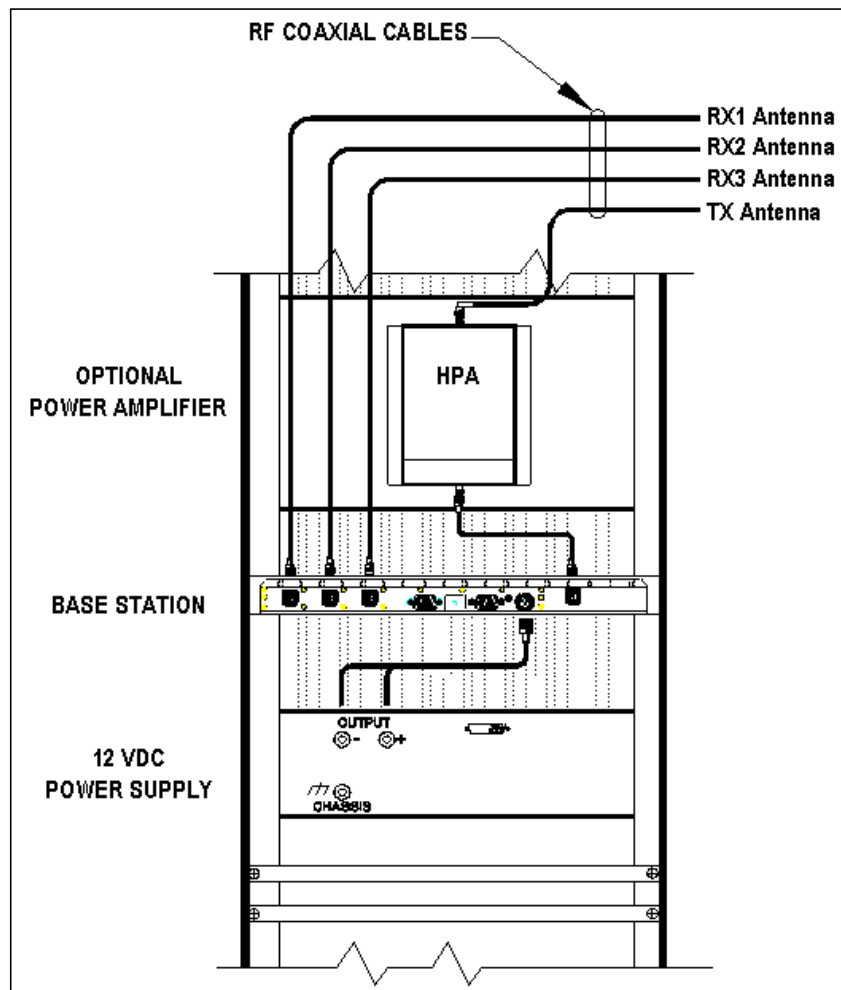

Figure 12: Base Station Mounting and Connection in the Rack Unit (Rear View)

Single Base Station Configuration

Figure 13: Base Station Ethernet Connection

To connect a single base station, perform the following steps:

- Step 1** Plug in the Ethernet crossover cable into the Ethernet port on the base station (as shown in the figure above).
- Step 2** Route and plug in the Ethernet crossover cable to an *IPMobileNet's* Internet Protocol Network Controller (IPNC) via the hardware as defined by the organization's configuration (see Chapter 2 Basic Configuration Samples).

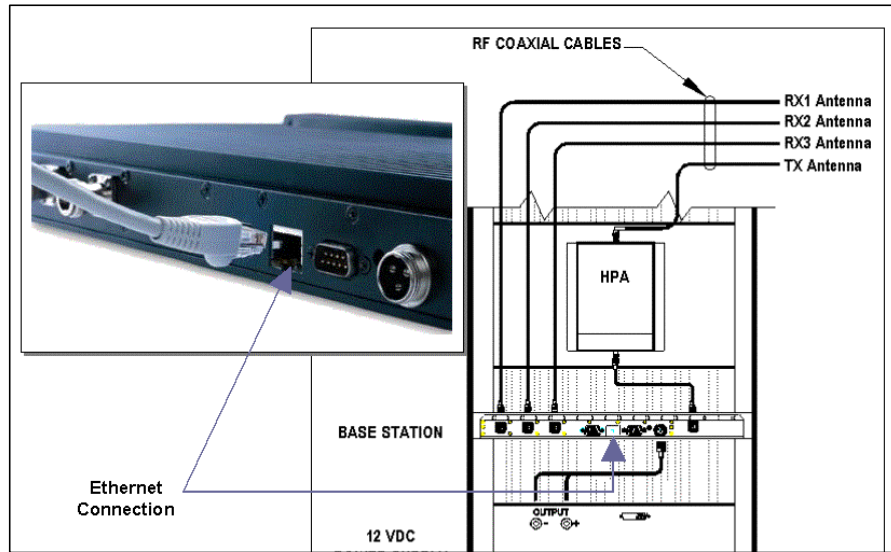

If connecting to a serial backhaul, an *IPMobileNet IPTurbo Converter* is required. If not already ordered, please refer to Chapter 6 for ordering information. For connection instructions, refer to 516.80496.QR *IPTurbo Converter Quick Reference Guide* (IPMN p/n: 516.80496.QR) available on the Product Documentation CD provided with this product.

Multiple Base Station Configurations

To connect multiple base stations, perform the following steps:

- Step 1** Plug in the Ethernet cables to the back of each base station (as shown in the figure above) and route according to selected setup (see Chapter 2 Basic Configuration Sample on page 12 and also refer to the 516.80496.QR *IPTurbo Converter Quick Reference Guide* for setup instructions and scenarios).
- Step 2** Route and plug in the Ethernet cables to an *IPMobileNet's* Internet Protocol Network Controller (IPNC) via the hardware as defined by the organization's configuration (see Chapter 2 Basic Configuration Samples).



If connecting to a serial backhaul, an *IPMobileNet IPTurbo Converter* is required. Refer to Chapter 6 for ordering information. For connection instructions, refer to 516.80496.QR *IPTurbo Converter Quick Reference Guide*.

### Typical Antenna Configuration

Base station antenna configurations may vary from site to site depending on the type of mounting structure, the presence of existing antennas, mounting structure loading limitations, etc. The following information is provided as a guideline for a typical scenario.

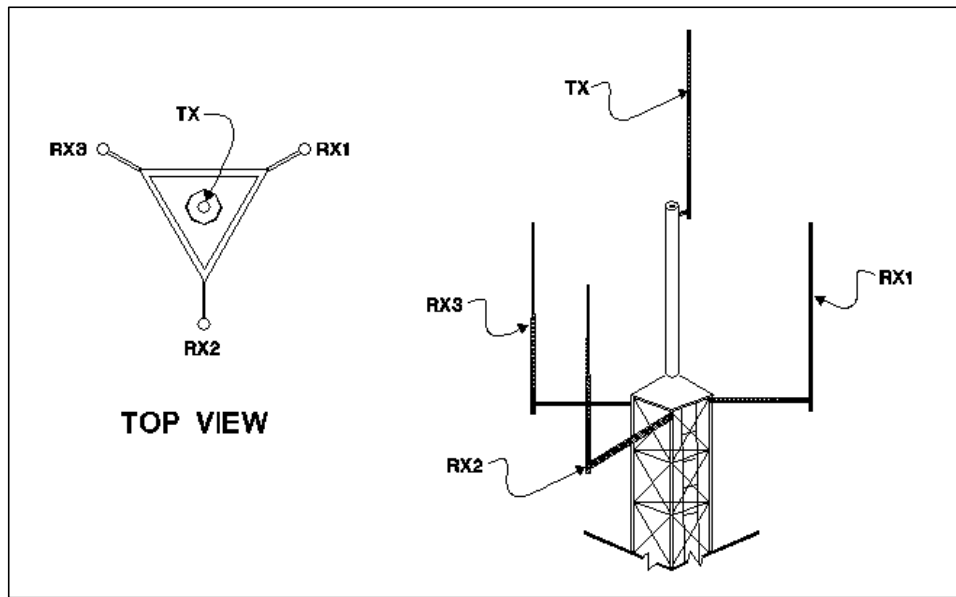

Figure 14: Typical Antenna Configuration

An optimal antenna mounting configuration is shown in the figure above. The transmit antenna and receive antennas are located at different elevations. This vertical separation provides the greatest degree of isolation between transmit and receive antennas. The three (3) receive antennas are mounted at the same elevation and are oriented in a 120 degree triangular pattern. A triangular orientation of the receive antennas provides optimal diversity performance in an omnidirectional pattern.



The greater the separation between receive antennas, the greater the diversity gain; therefore, the distance between antennas should be made as great as is practical.

In the event only two (2) receive antennas are used (i.e. a dual receiver diversity reception system), the receive antennas should be mounted in a broadside orientation with respect to the radio coverage area.



To prevent the antenna's radiation pattern from becoming distorted, the immediate area surrounding each antenna should be kept free from conductive objects (i.e. other antennas, guy wires, or the tower structure itself). The amount of clear area required to prevent pattern distortion is equal to the antenna's near-field exclusion.



### Near-Field Exclusion Zone

The near-field exclusion zone (NFEZ) is the required distance between antennas to any other surfaces to improve transmit and receive performance. The large radio frequency field that builds up around the antenna upon transmitting is essential for proper data transmission. It can be severely corrupted by metal objects in the NFEZ. As seen in the previous figure, the transmitting antenna is placed at the very top of the tower especially if the base station will be required to transmit in all directions (omni-directional).



If the transmitting antenna cannot be positioned on the top of the tower and must be placed on a tower arm, then it is important to realize that coverage will be shaded in the area behind the tower from the antenna. The installer must be certain that the area of desired coverage is away from the tower and not behind it.

Receiving and transmitting antennas should not be on the same plane, especially VHF and UHF systems where the frequency splits are relatively small. An antenna in the near-field exclusion zone that is tuned for the same frequency as the transmitting antenna will reradiate the signal and create unwanted effects on the transmitted signal. The receivers will be inundated by high levels of radio frequency energy from the transmitting antenna. This is why it is important to include vertical separation in the plan for the base station installation. The isolation provided by 30 feet of vertical separation can dramatically improve the performance of the base station.

An antenna's NFEZ can be calculated as follows:

$$D = \frac{2d^2}{\lambda}$$

Where: D is the distance to the antenna's near field boundary  
d is the antenna's longest linear dimension (in the same units as D)  
 $\lambda$  is the wavelength (in the same units as D)

Maximizing the distance between the receive antennas will provide maximum diversity gain and will minimize antenna radiation pattern distortion.

Power Connection

Figure 15: Base Station Power Connection

To connect the base station power connector, perform the following steps:

- Step 1** Connect the power cable to the base station power supply connection (as shown in the figure above).
- Step 2** Connect the wires to the appropriate output (+ and -) output posts on the power supply (as shown in the figure above).

### Post Installation Checklist

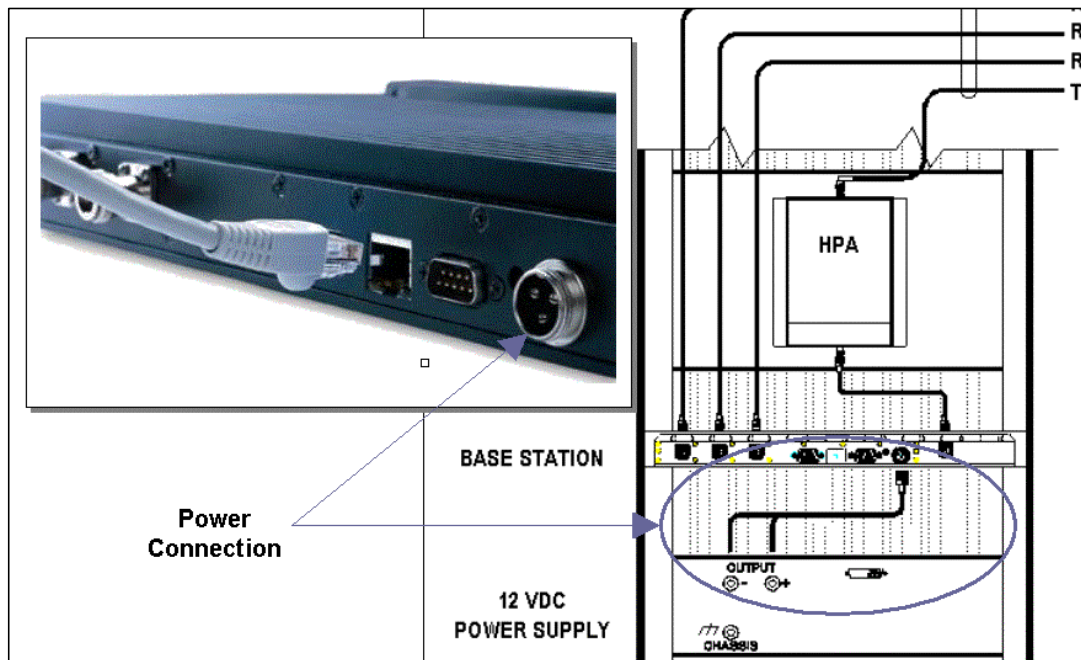
Table 7 lists the tasks that should be performed upon completing installation.

<b>TABLE 7: POST INSTALLATION CHECKLIST</b>		
NO.	CHECKLIST ITEM	<input checked="" type="checkbox"/>
1	Scope out the entire area setup to locate any obvious problem areas.	<input type="checkbox"/>
2	Check antenna routing for safety concerns and near-field boundary setup.	<input type="checkbox"/>
3	Use tie wraps, where possible to ensure that all cables routed in parallel are bundled together.	<input type="checkbox"/>
4	Perform appropriate testing to ensure base station works properly.	<input type="checkbox"/>



Once installation is complete make sure the area is clear of debris that would prevent proper airflow and ventilation.

### Overview

This section applies to all frequency ranges of the *IP*Series Base Stations. **Important!** The base station's IP address must be known prior to performing the procedures in this section.

The programming procedure should be performed when it is necessary to upgrade a base station's Firmware or to change the operating parameters to suit the customer's needs before putting into complete operation.

### HyperTerminal Setup

To communicate and access parameters from the base station, the base station must be connected to a HyperTerminal session setup on a personal computer.

Perform the following steps to setup the base station for communication with HyperTerminal:

**Step 1**            Connect the base station as shown in the figure below.

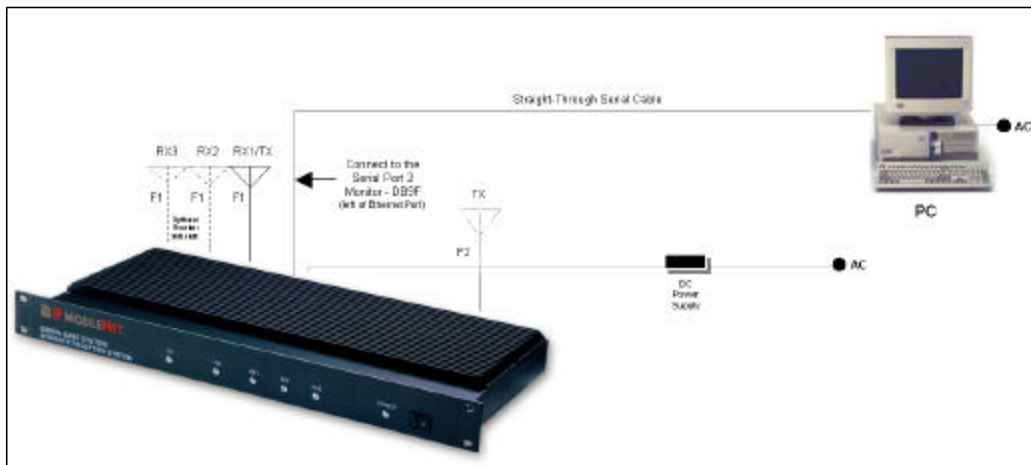

Figure #16: Base Station-to-HyperTerminal Connection Diagram

- Step 2**            Power on the personal computer.
- Step 3**            Power on the base station using the front panel power switch.
- Step 4**            On the personal computer's desktop, click on the **Start** button and select **Accessories**, **Communications**, and **HyperTerminal**.
- Step 5**            At the Connection Description window enter **IPMNBS** and click on the **OK** button.
- Step 6**            At the Connect To window, under **Connect using:** select **COM1** or **COM2** (whichever is available on the computer) and click on the **OK** button.
- Step 7**            At the COM Properties window make sure the properties selected are as follows:
- Bits per second:        **9600**
  - Data bits:                **8**
  - Parity:                    **None**
  - Stop bits:                **1**
  - Flow control:            **None**

- Step 8** Click on the **OK** button.
- Step 9** Open **HyperTerminal**.
- Step 10** Recycle the base power and HyperTerminal displays the base's Firmware revision.
- Step 11** Type in a ? in the HyperTerminal screen and press **[ENTER]**. This will list the Base Station parameters. If the cursor is not responsive, check the cables for proper connection.

```

Host serial = 115200,N,8,1, timeout=200
IPNC = 207.88.179.158, 207.88.179.157, 207.88.179.156, 207.88.179.152, 207.88.179.140
RF IP Address = 172.16.23.14
Tunnel Address = 8.4.2.14, Netmask = 255.255.255.240
Host interface = SLIP, no split frames, with status messages
tunnel = 1
Injection = LOW SIDE, 45MHz
pll type = MC145193
channel spacing = 12500
Reference frequency = 10.000 mHz
Channel Tx freq Rx freq Inj freq
Frequency=1 , 866.000000, 821.000000, 776.000000
Channel = 1
Serial number: 1234
TX quiet time = 5
Symbol sync time = 12 milliseconds, 0 extra inter-split-frame count
TX tail time = 5
Radio data rate = 19200
Max data tx time = 60 seconds
Carrier detect delay time = 8 milliseconds
Station ID = abcd
Station ID time = 0 minutes
Polarity = TX-, RX+
allow crc errors = 0
Allow base to base = 0
RSSI step = 25 (=18dBm)
default gateway = 0.0.0.0
Ethernet address = 00:00:00:00:00:00
Base station number = 14
SNTP interval = 16 seconds
num timeslots = 16
timeslot period = 992ms
timeslots per voice packet = 4
noise = -108dBm
DHCP Relay Agent = enable
-120dBm = (0)
-110dBm = (0)
-100dBm = (0)
-90dBm = (0)
-80dBm = (0)
-70dBm = (0)
-60dBm = (0)
-50dBm = (0)
-40dBm = (0)
-30dBm = (0)
Modem FEC = on
RX in progress message = 1
MTU = 1480
Signal Strength = DBM
IPNC query period = 10 secs

```



See Appendix A for Base Station Parameter definitions and default settings.

Ensure that the calibrated base station and the mobile radio antennas are separated by at least 10 feet. If the antennas are too close, the mobile radio receivers may overload by the transmitters resulting in intermittent communication and high data errors.

### Factory Default Save and Restore

For instructions on Factory Default Save and Restore Commands, please contact the Customer Service number provided in Chapter 6 of this document.

### Additional Programming Needs

Refer to the following technical notes and programming instructions and select the appropriate document for additional programming needs.

<b>TABLE #_: ADDITIONAL PROGRAMMING DOCUMENTS</b>	
<b>TN01-011</b>	<p><b>Base Station Setup for Programming using an F167 Processor</b></p> <p>This technical note provides instructions for establishing a connection that allows programming of a Base Station using an F167 processor.</p>
<b>TN01-0012</b>	<p><b>Base Station Setup for Programming using an F168 Processor</b></p> <p>This technical note provides instructions for establishing a connection that allows programming of a Base Station using an F168 processor.</p>
<b>TN01-0020</b>	<p><b>Remote Firmware Updates for the IPNC and Base Station</b></p> <p>This technical note provides instructions on how to perform remote Firmware updates for the <i>IPNetwork</i> Controller and <i>IPSeries</i> base stations.</p>
<b>TS.0004-PI</b>	<p><b>Black Box Terminal Server</b></p> <p>This programming instruction provides instructions on how to configure terminal server Firmware when used to interface with a base station.</p>

**Ordering Parts**

Replacement parts may be ordered from the following address:

Attn: Small Parts Sales  
IPMobileNet, Inc.  
16842 Von Karman Avenue, Suite 200  
Irvine, CA 92606

Voice: (949) 417-4590  
Fax: (949) 417-4591

**Customer Support**

To obtain assistance in troubleshooting problems with a product, please contact IPMobileNet's Customer Service Staff at (800) 348-1477.

**Reporting Problems with the Documentation**

To report problems or question concerning the documentation included in the shipment, please send an e-mail to [mlopez@ipmobilenetinc.com](mailto:mlopez@ipmobilenetinc.com) explaining the problem and the Publications Department will respond as soon as possible.

Please ensure to include the following information with the e-mail message:

- Your company name
- Your name or other contact name
- Return e-mail address
- Manual name
- Manual part number
- Page number(s)
- Description of the problem

### Backhaul Systems

Considering the backhaul system between the base station location and the Internet Protocol Network Controller location is one of the most critical elements of data transmission. Once data has been received at the base station, it must be relayed to the IPNC at the user's location quickly, accurately, and reliably. Industry standard backhauls are appropriate for *IPMobileNet* data transmission as long as data is transmitted cleanly and dependably. Depending upon conditions and accessibility, the preferred method of data transmission to the remote site is through wire.

#### Wired Backhaul

The Ethernet backhaul is preferred as it uses a T1 (or fractional T1) line or equivalent, which handles larger volumes of digital data. If the backhaul will be via SLIP connection, then four wire DDS telephone line capable of 56Kbps is recommended.



Do not order a 64Kbps line as it is incompatible with *IPMobileNet*'s equipment data transmission speed.

One disadvantage of using wired lines is that the system is under the control of an outside agency and telephone line faults or system outages impose potential loss of radio communication through the site affected.

#### Microwave Transmission Link

Using a microwave transmission link is another option, which is often used when wire cannot be brought into remote locations. Data transmission is generally very reliable, but adverse conditions can degrade the quality of the data. High winds, ice on the microwave dish, and other environmental variables can cause problems and prevent data or voice from completing transmitting.

#### Newest Backhaul

The 802.11 range of products for wireless data transmission. Several models of 802.11 have been used successfully.



Be aware of the possibility of interference on the 2.4 GHz frequency range. The 802.11 product should only be used for short hops with clear line-of-sight in an environment where minimal radio interference will exist.



### Serial Backhaul Capacity

The backhaul with the fastest speed that can provide clean, reliable, and dependable transmission should be considered when dealing with backhaul capacity. *IP*MobileNet's base stations operate at four (4) data transmission rates, which include the following:

- 115,200 bps
- 57,600 bps
- 38,400 bps
- 19,200 bps

The optimal goal is to select a backhaul data rate that remains ahead of the base station's data transmittal. For example:

Base Station	Backhaul	Results
19,200 bps	19,200 bps	Backhaul does not have the opportunity to remain ahead of the base station's transmittals if data packets are dropped or need to be rebroadcast from the IPNC to the base station.
19,200 bps	57,600 bps	System will be more efficient and always operate at the base station's peak performance never waiting for data to arrive from the IPNC.

The 56 Kbps DDS line is typically used to create the 57,600 bps asynchronous data line for the serial line Internet protocol (SLIP) connection between the Internet Protocol Network Controller location and the base station site.

<b>BASE STATION PARAMETERS</b>		
<b>1</b>	<p>Command:</p> <p>Description:</p> <p>Default:</p>	<p>Base station number = 1</p> <p>Each base station in a multi-site system has a unique base station number. Start at 1 and count up. Skipping numbers is allowed.</p> <p>1</p>
<b>2</b>	<p>Command:</p> <p>Description:</p> <p>Default:</p>	<p>ipnc=xxx.xxx.xxx.xxx,yyy.yyy.yyy.yyy,...zzz.zzz.zzz.zzz</p> <p>Sets the list of IPNC IP addresses. First one on the list should be the IP address of the primary IPNC.</p> <p>172.16.23.200</p>
<b>3</b>	<p>Command:</p> <p>Description:</p>	<p>ipnc+=xxx.xxx.xxx.xxx</p> <p>Append the IP address to the end of the existing list of IPNC addresses.</p>
<b>4</b>	<p>Command:</p> <p>Description:</p>	<p>ipnc=-xxx.xxx.xxx.xxx</p> <p>Delete the IP address in the existing list of IPNC addresses. If there is only one IPNC address in list, the address cannot be deleted.</p>
<b>5</b>	<p>Command:</p> <p>Description:</p> <p>Default:</p>	<p>ipncqueryperiod=xx</p> <p>This command sets the period, in seconds, that the base station should query the IPNC's for status of health. If there is only one IPNC, this parameter should be set to zero.</p> <p>0</p>
<b>6</b>	<p>Command:</p> <p>Description:</p> <p>Default:</p>	<p>signalstrength=dbm/adc</p> <p>When "signalstrength" is set to "adc" the base station will send the signal strength to the IPNC in ADC units (0 to 255). When "signalstrength" is set to "dBm", the base station will send the signal strength to the IPNC in dBm units (-128 to 0). dBm is preferred.</p> <p>dBm</p>
<b>7</b>	<p>Command:</p> <p>Description:</p> <p>Defaults:</p>	<p>Ping=xxx.xxx.xxx.xxx, l=sss, n=ccc, i=ttt</p> <p>Use this command to ping mobile radios, PC's or IPNC's. Where, "xxx.xxx.xxx.xxx" specifies the destination IP address to ping. The destination IP address must be specified. Other parameters are optional.</p> <p>"l=sss" specifies the size of the packets in number of bytes, not including the IP and ICMP header.</p> <p>"n=ccc" specifies the repeat count.</p> <p>"i=ttt" specifies the pinging interval in milliseconds.</p> <p>l=32 n=1 i=1000</p>
<b>8</b>	<p>Command:</p> <p>Description:</p>	<p>Host framing = slip, status</p> <p>The "status" option controls whether the base station reports signal strength information to the IPNC. "status" must be selected to support roaming.</p>

<b>BASE STATION PARAMETERS</b>		
<b>9</b>	<p>Command:</p> <p>Description:</p>	<p>Tunnel = 0 Tunnel = 1</p> <p>Set tunnel = 0 if the base station is attached to the IPNC via RS232. In this case the "slip address" is not used or Ethernet configuration using an <i>IPTurbo Converter</i>.</p> <p>Set tunnel = 1 if the base station is attached to the IPNC via Ethernet or <i>IPTurbo Converter</i>. In this case the "slip address" is used as the endpoint of an IP tunnel between the base station and the IPNC</p>
<b>10</b>	<p>Command:</p> <p>Description:</p> <p>Defaults:</p>	<p>RF IP address = XXX.XX.XX.XXX</p> <p>Set this to an available IP address that is within the IPNC's network.</p> <p>172.16.23.1</p>
<b>11</b>	<p>Command:</p> <p>Description:</p> <p>Defaults:</p>	<p>Tunnel address = XXX.XX.XX.XXX</p> <p>If tunnel = 1, set this to the appropriate address based upon where it is connected to the network.</p> <p>123.45.67.89</p>
<b>12</b>	<p>Command:</p> <p>Description:</p> <p>Defaults:</p>	<p>dhcprelayagent=enable; dhcprelayagent=disable</p> <p>Enable/Disable DHCP Relay Agent. Use to enable/disable the base as the DHCP relay agent. Unlock base before typing the command. The command is effective immediately.</p> <p><u>NOTE:</u> The base must have DHCP Relay Agent enabled if DHCP Client is enabled in the mobile radio.</p> <p>Disable</p>
<b>13</b>	<p>Command:</p> <p>Description:</p> <p>Defaults:</p>	<p>rxinprogressmessage=x</p> <p>Enable/Disable Receiving Packet Look-Ahead. Where "x" is either 1 or 0 (1=enable, 0=disable). Use to enable/disable the "receiving packet look-ahead" feature. If enabled, as soon as base receives the header of a packet, it sends a short packet to inform the IPNC of the length, source address, and arrival time of the packet being received. IPNC Scheduler uses this information to decide the appropriate time to send the next packet to the mobile radio. Unlock base before typing the command. The command is effective immediately.</p> <p>1</p>
<b>14</b>	<p>Command:</p> <p>Description:</p> <p>Defaults:</p>	<p>mtu=n</p> <p>Setting MTU. Where "n" is the desired MTU in decimal value, 1500 maximum. Use to change the MTU. Unlock base before typing the command. The command is effective immediately. When the base receives a packet with size greater than the MTU, it returns an ICMP packet (type=3, code=4) to the source. The original received packet is discarded.</p> <p>1480</p>
<b>15</b>	<p>Command:</p> <p>Description:</p> <p>Defaults:</p>	<p>updatefirmware=filename</p> <p>Update Base Firmware.</p> <p>Where "filename" is the file name of the Firmware. The filename cannot contain any path, and the file itself must reside in the "/ftpboot/" directory of the IPNC. Unlock the base before typing the command. When Firmware update is finished, the base will automatically reboot.</p> <p>None</p>

<b>BASE STATION PARAMETERS</b>		
<b>16</b>	Command: Description: Defaults:	default gateway=xxx.xxx.xxx.xxx  When the base station is connected to the IPNC through Ethernet connection the default gateway address must be set, otherwise it is not used.  default gateway=0.0.0.0
<b>17</b>	Command: Description: Defaults:	frequency = Channel number, Tx frequency, Rx frequency  Sets transmit and receive frequency for the channel. A maximum of 20 channel frequency combinations may be entered.  frequency=0, 450.125, 455.125
<b>18</b>	Command: Description: Defaults:	channel=x  Where x is the channel number.  Selects the operating frequency channel  channel=0
<b>19</b>	Command: Description: Defaults:	hostserial=baud rate, parity, data bits, stop bits, timeout  Sets the baud rate of the serial connection. "Timeout" specifies, in milliseconds, the time to end the frame if the end of frame character is not received.  hostserial=115200, N, 8, 1, timeout=200

 Use the command **unlock=password** entering the appropriate password to enable programming before issuing any commands above. Also, the base station should be reset by the "reboot" command when no more commands will be issued.

***For changes to parameters not listed in this Appendix, please contact Customer Support.***

No.	Description	Page No.
1	<i>IP</i> Series Base Station External Illustration	6
2	External Connectors of an <i>IP</i> Series Base Station (Rear View)	7
3	External Features of an <i>IP</i> Series Base Station (Front View)	8
4	General Block Diagram	10
5	Basic Network Configuration	12
6	Network Connection to an Existing LAN	13
7	Base Station Mounting in the Rack Unit (Front View)	14
8	Power Adjustment Potentiometer Location on the IP1B	18
9	Power Adjustment Potentiometer Location on the IP4B	18
10	Power Adjustment Potentiometer Location on the IP8B	19
11	Interconnection Diagram	21
12	Base Station Mounting and Connection in the Rack Unit (Rear View)	22
13	Base Station Ethernet Connection	23
14	Typical Antenna Configuration	24
15	Base Station Power Connection	26

<b>4-Level FSK</b>	A form of digital modulation in which four (4) discrete levels of carrier frequency displacement are employed to convey information.
<b>802.11</b>	Wireless LAN technology specifications, which specifies an over-the-air interface between a wireless client and a base station or between two wireless clients. 802.11 provide 2 or 2 Mbps transmission in the 2.5 GHz band using either frequency hopping spread spectrum (FHSS) or direct sequence spread spectrum (DSSS).
<b>Analog</b>	A classification of signal in which the amplitude of the signal may take on an infinite number of values.
<b>Backhaul</b>	To transmit voice and data traffic from a cell site to a switch, i.e., from a remote site to a central site.
<b>Bessel Filter</b>	A filter with a linear phase response.
<b>Broadband</b>	A term, which implies that the equipment can be operated over a wide (broad) band of frequencies.
<b>bps</b>	bits per second
<b>CMOS</b>	Complementary Metal Oxide Semiconductor – A type of integrated circuit with low power consumption.
<b>Collision Tolerant Modem</b>	A specially designed modem, which can tolerate transmissions that overlap in time.
<b>Continuous Duty</b>	Indicates that the equipment can be operated 100% of the time.
<b>CRC</b>	Cyclic Redundancy Checksum – An error detection scheme in which a known algorithm is used to operate on a message both prior to transmission and after reception. The output of the operation (the checksum) is compared on both sides of the link to validate the integrity of the received message.
<b>Data Interleaving</b>	A technique in which the order of the individual data bits within the data to be transmitted is shifted and interleaved so as to disassociate adjacent data bits in a message. This scheme is complementary to forward error correction (FEC) algorithms.

<b>Data Scrambling</b>	A technique used to ensure no repeating patterns exist in the transmitted data stream, a method of ensuring the data is reasonable random in nature.
<b>Digital</b>	A classification of signal in which the amplitude of the signal may take a discrete number of values.
<b>Diversity Reception</b>	A reception system using multiple antennas and/or multiple receivers to combat multi-path fading.
<b>Dynamic Range</b>	The range of amplitudes over which a receiver or amplifier will operate within specifications.
<b>EIA</b>	Electronic Industries Association
<b>EMI</b>	Electromagnetic Interference
<b>Ethernet</b>	A local area network (LAN) architecture, which uses a bus or star topology and supports data transfer rates of 10 Mbps.
<b>Exciter</b>	An exciter is that part of a radio, which creates the transmit RF carrier and performs the process of modulation.
<b>FEC</b>	Forward Error Correction – A methodology used to correct errors, which may occur in wireless transmission systems. With FEC, additional data is added to each message prior to transmission, at the receiving end, this additional information can be used to correct errors in the received message.
<b>FM</b>	Frequency Modulation – A form of modulation where the carrier is shifted an amount proportional to the modulating signal's amplitude at a rate proportional to the modulating signal's frequency.
<b>Frequency Stability</b>	A measure of the stability of a frequency with respect to temperature, usually expressed in ppm (parts per million) over a specified temperature range.
<b>FSK</b>	Frequency Shift Keying – Digital modulation (a form of FM) where the carrier frequency is shifted above and below the operating frequency (in discrete steps) in response to a digital data input.
<b>Full Duplex</b>	A dual frequency mode of operation in which transmission and reception occur simultaneously.

<b>GFSK</b>	Gaussian Filtered Frequency Shift Keying – A form of digital modulation in which the baseband modulation signal is filtered by a low-pass filter with a Gaussian response prior to modulating the carrier signal.
<b>GPS</b>	Global Positioning System
<b>Image Frequency</b>	An unwanted frequency, which will produce an on-frequency IF (Intermediate Frequency) signal.
<b>Injection</b>	An injection signal is a signal used in frequency conversion circuits, it is normally mixed with another signal to produce a third signal (which is a sum or difference of the original signal and the injection signal).
<b>Half Duplex</b>	A dual frequency mode of operation, which inhibits simultaneous transmission and reception.
<b>LO</b>	Local Oscillator – An on-board oscillator used in frequency conversion circuits.
<b>Modular Design</b>	A design in which the major functional components are separated into distinct modules.
<b>Multipath</b>	A radio propagation situation in which multiple RF (radio frequency) signal paths exist between a transmitter and receiver. These multiple paths or multi-path situations can create significant distortion in the received signal.
<b>NFEZ</b>	Near-Field Exclusion Zone
<b>Noise Figure</b>	The “Figure of Merit” of an amplifier. Specifically, noise figure is a measure of the degradation in SNR (signal-to-noise ratio) between the input and output ports of a network.
<b>PCB</b>	Printed Circuit Board
<b>Phase Linearity</b>	Implies a linear relationship between the phase of a signal and the frequency of that signal. A linear phase response ensures constant input to output delays regardless of frequency, important for wireless communication systems.
<b>Phase Noise</b>	A measure of the purity of a discrete frequency (expressed in $-dBc/Hz$ at some offset frequency).



<b>PLL</b>	Phase Locked Loop - A circuit configuration used to lock the frequency of a VCO (voltage controlled oscillator) to a high stability reference oscillator.
<b>ppm</b>	Parts Per Million
<b>RF</b>	Radio Frequency
<b>RFI</b>	Radio Frequency Interference
<b>SINAD</b>	The ratio of Signal + Noise + Distortion to Noise + Distortion.
<b>Sensitivity</b>	The measure of a receiver's ability to capture and faithfully reproduce weak signals.
<b>SMT</b>	Surface Mount Technology – electronic components, which make electrical contact on the surface layer of a PCB (as opposed to thru-hole components). SMT devices provide reduced size and increase performance.
<b>SNR</b>	Signal-to-Noise Ratio
<b>TCVCXO</b>	Temperature Compensated Voltage Controlled Crystal Oscillator
<b>TIA</b>	Telecommunications Industry Association
<b>Transmit Attack Time</b>	The elapsed time from transmit key assertion to 90% rated RF power is achieved.
<b>VCO</b>	Voltage Controlled Oscillator – An oscillator whose frequency can be adjusted by a DC control voltage.

**A**

antenna.....6

**B**

base station..... 4, 6, 7, 10, 12, 14, 15, 16, 21

**D**

Diversity ..... 6, 39  
 Diversity Reception.....6  
 Diversity Reception System.....6  
 DR..... See Diversity Reception  
 DRS..... See Diversity Reception System

**E**

Ethernet.....6, 7, 10, 39

**F**

Features .....3  
 FEC..... See Forward Error Correction  
 Forward Error Correction.....6

**G**

GPS.....40

**I**

Installation.....17  
 Internet Protocol Network Controller .....6  
 IP address.....28  
 /PMessage .....3  
 IPNC..... See Internet Protocol Network Controller  
 /PTurbo Converter ..... 12, 13

**L**

LAN ..... See Local Area Network  
 local area network..... 13

**M**

mobile radio .....4, 6, 7, 8, 27

**N**

network..... 12

**P**

PA ..... See Power Amplifier  
 Parameters .....3, 4  
 Power Amplifier .....6  
 PROGRAMMING.....3

**R**

rack .....14  
 receiver .....7, 39, 40, 41  
 RX .....7

**S**

Serial Line Internet Protocol .....6.  
 SLIP ..... See Serial Line Internet Protocol  
 Specifications .....3

**T**

Testing.....15  
 Transmitter .....7  
 TX ..... See Transmitter

**V**

VIU..... 13