

TOC

Welcome	8
Product introduction	8
Features	8
Contact us	9
Legal statements	9
IPS Group Confidential and Proprietary	9
Trademarks	10
FCC statements	10
FCC Interference Statement (Part 15.105 (b))	11
FCC Part 15 Clause 15.21 [Do not Modify warning]:	11
FCC Part 15.19(a) [interference compliance statement], unless the following statement is already provided on the device label: ..	11
RF Exposure Guidance Statement:	11
General Information and Concepts	13
SSPM Operating States	13
Idle / Expired	13

Paid	15
Fault	16
Cards only	16
Coins only	17
Out of order	18
Prepay	19
No payment accepted	19
SSPM Diagnostics Mode	20
Diagnostics modes levels	20
Level 1	20
Level 2	21
Level 3	22
Sub-menus	23
Faults	23
Coin Test	24
Card Test	24
Comms Test	25
Fault Logging	26
Meter Swap	27
Voltages	28

Sleep	29
Understanding M5™ Battery Voltages	29
Process flow	30
References and Specifications	33
M5™ Features, Functions, and Parts	33
M5™ parts with NFC	35
M5™ functions	36
M5™ circuit boards and internal electronics	37
M5™ top covers	39
Model 795	39
Model 132 / Model 147	40
Access Cards	41
Meter Diagnostics card	41
Coin Collection card	42
Maintenance Credit card	43
RFID Tag and Reader	43
RFID tag	43
RFID reader	44
RFID communication for identification and location	45

SSPM Card Slot	45
SSPM Coin Slot	46
SSPM Diagnostics Button	47
SSPM Display	48
SSPM Keypad	50
Primary functions	50
Secondary functions	50
Tertiary functions	51
SSPM LEDs	51
No Parking / After Hours	52
Idle / Expired	52
Paid	53
Out of Order	53
SSPM Payment Method Decal	53
SSPM Solar Panel	55
SSPM Validator	56
SSPM Error and Fault Codes	57
Error messages	57
Fault codes	58

SSPM Troubleshooting	58
Power issues	58
Coin issues	59
Communication issues	59
Cleaning and general maintenance	60
Display cleaning instructions	61
Tasks and Procedures	62
Basic Operations	62
Turn the SSPM On and Off	63
Turning the SSPM On	63
Turning the SSPM Off	65
SSPM Coin Operation	66
SSPM Card Operation	67
How To's	68
How To Clear an SSPM Coin Jam	69
How To Replace an SSPM Coin Slot	70
How To Clear an SSPM Card Jam	73
How To Check the M5™ Battery Voltage	75
Checking battery voltages	76

How To Charge the M5™ Main Battery	77
How To Replace an SSMP Backup Battery	82
How To Force an SSPM to Update	83
Glossary	85
Index	88

IPS Group, Inc. M5™

- User Guide

100-014

M5™ 132

M5™ 147

M5™ 795

Welcome

This guide provides an overall product description, describes primary operating features, and outlines basic maintenance procedures for the IPS Group, Inc. M5™ Single Space Parking Meter (SSPM).

Product introduction

The IPS Group, Inc. SSPM is a revolutionary product designed to enhance a city's current single space parking system by providing additional payment options (such as credit card), access to real-time data (via web-based management system), without disruption of current parking meter operations. This guide provides an overall product description, describes primary operating features, and outlines basic maintenance procedures.

Features

The primary features of the M5™ SSPM include:

- Ability to accept payments via coins, tokens, credit cards, debit cards, smart cards, contactless payment, at the meter terminal.
- Ability to accept payments via Android and iOS mobile device, at and / or away-from the meter terminal.
- Wireless connectivity to our web-based Data Management System (DMS).
Other than an Internet browser, no additional customer software is required. The SSPM utilizing cellular networks to initiate communication under a number of scenarios, including:
 1. Credit card use
 2. Fault notification
 3. Pre-configured call-in interval
- Solar panels and rechargeable batteries to provide ongoing and backup power.
- Wireless notification to parking operations staff of all meter faults via text message and / or email.
- A variety of reports detailing financial, technical, and administrative functions via a single web-portal, including but not limited to:

- Credit card reconciliation
- Cash collection reports
- Coin box level (% full)
- GPS location of SSPM

Although the IPS Group, Inc. SSPM provides countless advanced features, it is user-friendly and functions similarly to standard (traditional) parking meters. This makes their implementation and use, both intuitive and hassle-free.

Contact us

IPS welcomes customer feedback as part of the evolution of this product, so if you have any questions or concerns, please contact IPS Group, Inc. at:

(858) 404-0607

support@ipsgroupinc.com

www.ipsgroupinc.com

www.ipsmetersystems.com

Legal statements

IPS Group Confidential and Proprietary

IPS Group, Incorporated (“IPS”) has made an effort to provide pertinent and relevant information in this manual. In doing so, we are providing valuable and protected information, including ideas and concepts that IPS considers to be confidential. Release of IPS confidential information may cause irreparable harm to IPS by publicly disclosing such information that is not publicly known. IPS respectfully requests the right to be notified and provided an opportunity to redact such confidential information in the event of any third-party request for public disclosure.

Trademarks

IPS, IPS GROUP, IPS Group, Inc., and other IPS-owned marks are trademarks and / or registered trademarks of IPS Group, Incorporated in the United States, and may be registered in other countries. IPS reserves all rights to the IPS copyright materials contained herein.

FCC statements

This device complies with part 15 of the FCC Rules. Operation is subject to the following two conditions:

1. This device may not cause harmful interference.
2. This device must accept any interference received, including interference that may cause undesired operation.

In order to comply with FCC / ISED RF Exposure requirements, this device must be installed to provide at least 20 cm separation from the human body at all times.

Afin de se conformer aux exigences d'exposition RF FCC / ISED, cet appareil doit être installé pour fournir au moins 20 cm de séparation du corps humain en tout temps.

This device complies with Industry Canada's license-exempt RSS's. Operation is subject to the following two conditions:

1. This device may not cause interference; and
2. This device must accept any interference, including interference that may cause undesired operation of the device.

Le présent appareil est conforme aux CNR d'Industrie Canada applicables aux appareils radio exempts de licence. L'exploitation est autorisée aux deux conditions suivantes:

1. l'appareil ne doit pas produire de brouillage;
2. l'appareil doit accepter tout brouillage radioélectrique subi, même si le brouillage est susceptible d'en compromettre le fonctionnement.

FCC Interference Statement (Part 15.105 (b))

This equipment has been tested and found to comply with the limits for a Class B digital device, pursuant to Part 15 of the FCC Rules. These limits are designed to provide reasonable protection against harmful interference in a residential installation. This equipment generates uses and can radiate radio frequency energy and, if not installed and used in accordance with the instructions, may cause harmful interference to radio communications. However, there is no guarantee that interference will not occur in a particular installation. If this equipment does cause harmful interference to radio or television reception, which can be determined by turning the equipment off and on, the user is encouraged to try to correct the interference by one of the following measures:

- Reorient or relocate the receiving antenna.
- Increase the separation between the equipment and receiver.
- Connect the equipment into an outlet on a circuit different from that to which the receiver is connected.
- Consult the dealer or an experienced radio / TV technician for help.

FCC Part 15 Clause 15.21 [Do not Modify warning]:

Changes or modifications not expressly approved by the party responsible for compliance could void the user's authority to operate the equipment.

FCC Part 15.19(a) [interference compliance statement], unless the following statement is already provided on the device label:

This device complies with part 15 of the FCC Rules. Operation is subject to the following two conditions: (1) This device may not cause harmful interference, and (2) this device must accept any interference received, including interference that may cause undesired operation.

RF Exposure Guidance Statement:

In order to comply with FCC RF Exposure requirements, this device must be installed to provide at least 20 cm separation from the human body at all times.

Changes or modifications not expressly approved by IPS Group, Inc. could void the user's authority to operate the equipment. If this equipment does cause harmful interference to radio or television reception, which can be determined by turning the equipment off and on, the user is encouraged to try to correct the interference by one or more of the following measures:

- Reorient or relocate the receiving antenna.
- Increase the separation between the equipment and receiver.
- Connect the equipment into an outlet on a circuit different from that to which the receiver is connected.
- Consult the dealer or an experienced radio / TV technician for help. The FCC Identifier of the Meter, and other transmitters it may contain, are listed below.

General Information and Concepts

The chapters listed below provide high-level and general information for the IPS Group, Inc SSPM.

- [SSPM Operating States](#)
- [SSPM Diagnostics Mode](#)
- [Understanding M5™ Battery Voltages](#)

SSPM Operating States

This concept topic discusses the five IPS Group, Inc. SSPM operating states.

1. Idle / Expired
2. Paid
3. Fault
4. Prepay
5. No Payment Accepted

The following subsections discuss each of the five operating states, and provide examples of each default message.

Idle / Expired

An idle / expired SSPM LCD alternates between the present parking rate and time limit information (default screen), and the available payment options. When the meter goes into idle mode (not being used or calling in), the screen goes dark but can be “woken up” in two ways:

1. Insertion of credit card payment method.
2. Pressing the keypad buttons.

When environments have minimal ambient light (evening hours, indoors, garages, shaded areas, etc.), if the meter is "woken up", the back-light illuminates to help the motorist view the LCD.

The SSPM indicates an expired state (payment is required) by flashing red LEDs. (See the concept topic [SSPM LEDs](#) for more details.)

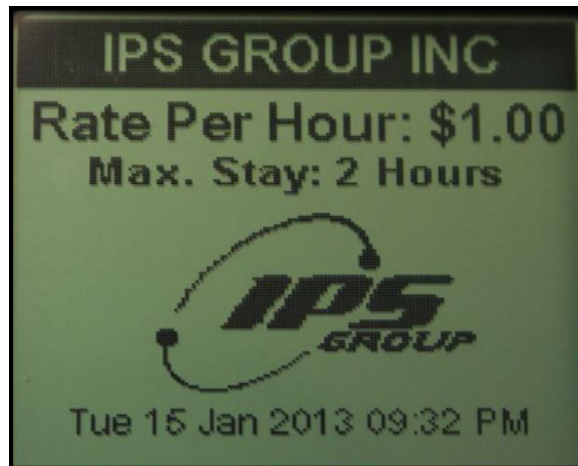

Paid

A paid SSPM LCD alternates between the present parking rate and time limit information (default screen), and the remaining time (in the HH:MM format) and the expiration time. (Optionally the SSPM can be configured through the DMS to display negative time duration (or "grace" time) once the meter expires.)

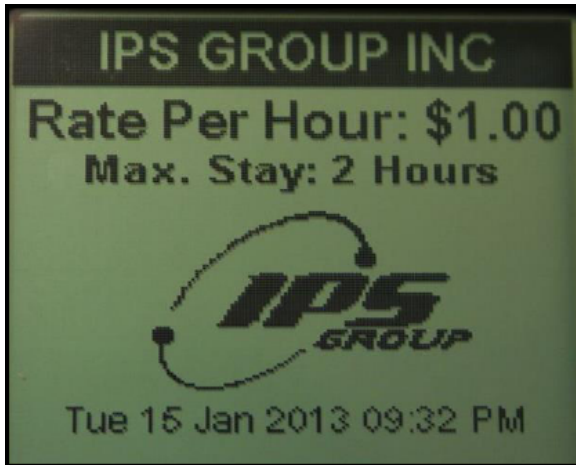

Fault

An SSPM can experience three types of fault operational states.

1. Cards Only
2. Coins Only
3. Out of Order

The LCD alternates between the present parking rate and time limit information (default screen), and the type of fault, accordingly.

Cards only

If the SSPM detects a coin jam, it experiences a "Cards Only" fault. While in this state the SSPM only accepts card payments, and does NOT accept coin payments. The following shows the alternating LCD messages.

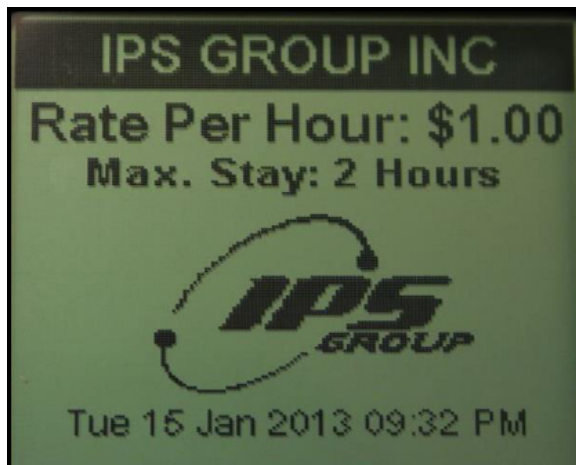



Coins only

If the SSPM detects a card jam, it experiences a "Coin Only" fault. While in this state the SSPM only accepts coin payments, and does NOT accept card payments. The following shows the alternating LCD messages.

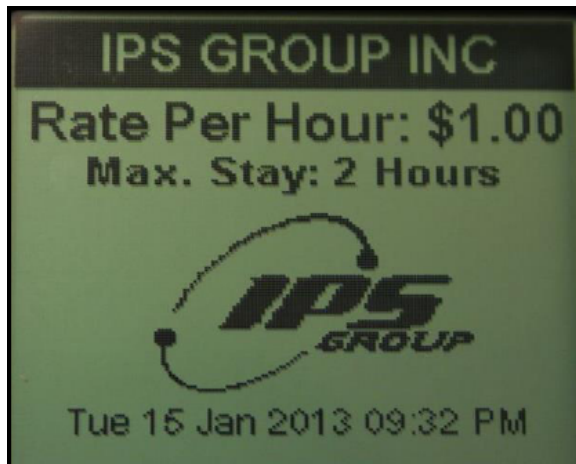

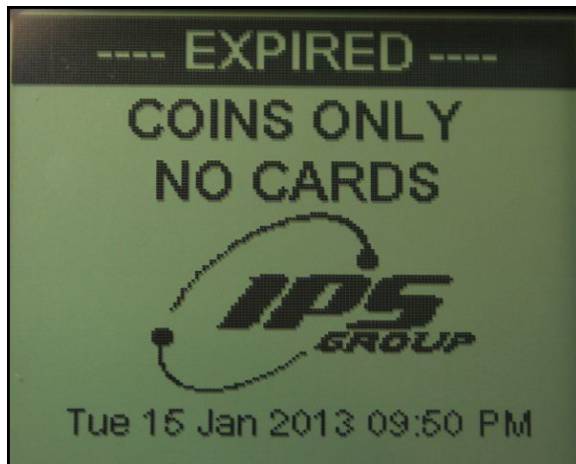

Out of order

If the SSPM detects a coin jam and a card jam (i.e. both payment options are unavailable), it experiences an "Out of Order" fault. While in this state the SSPM does NOT accept coin or card payments. The following shows the alternating LCD messages.

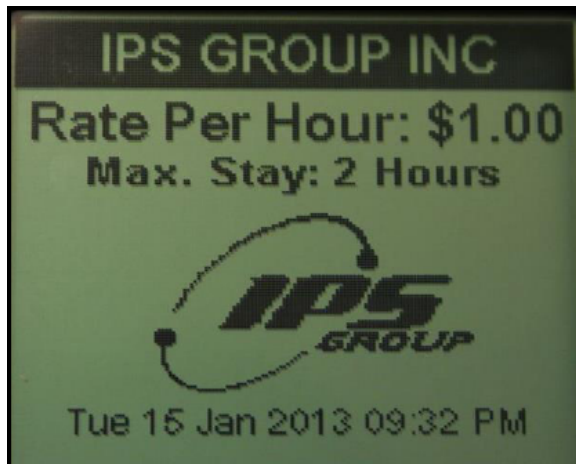

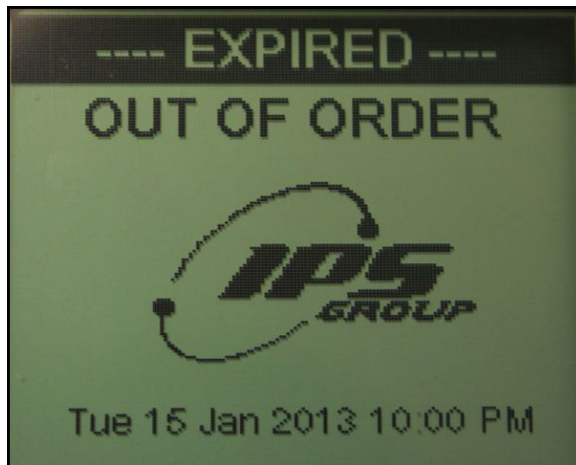

Prepay

A SSPM can be configured (through the DMS) to accept payment before the start of an enforcement period, by creating a "prepay" period. A prepay periods occur within a "free parking" period, and ends when the "pay period" begins (i.e. when enforcement starts). When an SSPM receives currency while in a prepay period, the LCD shows the amount of time purchased in addition to the amount of free parking time remaining (i.e., until the pay period / enforcement starts).

No payment accepted

There are two time period configurations that can cause a "No Payment Accepted" state. In both cases the meter ignores any payment inserted, and continues to display the configured screen. The messages for these time periods can be customized as necessary.

1. Free parking - Typically display when parking is not enforced.
2. No parking - Used for Tow-Away or Street Cleaning.

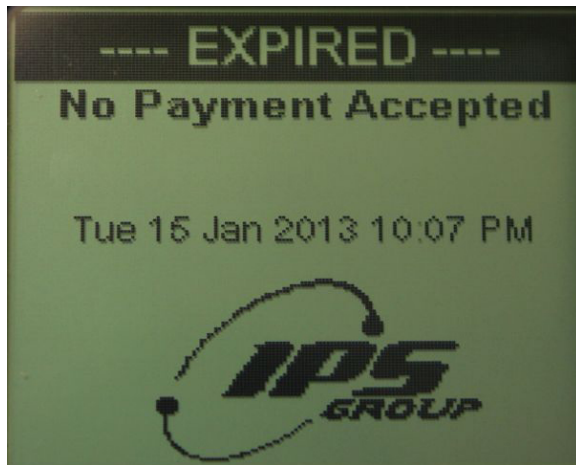

SSPM Diagnostics Mode

This concept topic discusses the IPS Group, Inc. SSPM Diagnostics mode. The SSPM's Diagnostic mode is used to determine meter issues and prevent potential problems.

Diagnostics modes levels

The SSPM offers three levels of Diagnostics mode. Level 1 contains the least amount of sub-menus; while Level 3 offers the highest amount of sub-menus.

Level 1

The following is an example of the level 1 Diagnostics mode main screen.

- To enter Diagnostics mode (level 1) on the SSPM, quickly insert and remove a Diagnostics card from the EMV card reader.

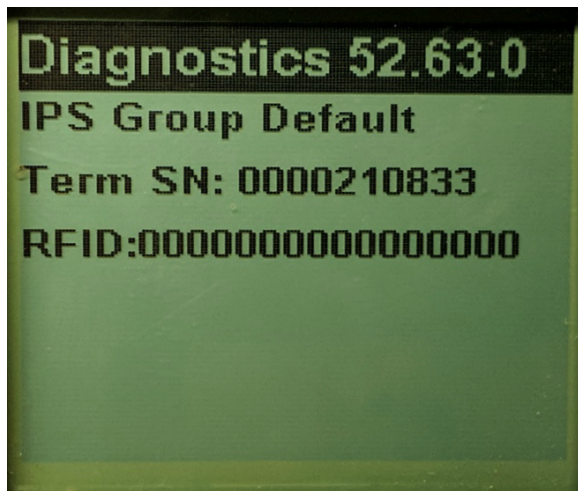

Level 2

Level 2 Diagnostics mode is signified by a blank hash mark in the upper-right hand corner of the Diagnostics mode main screen. (See the red circle in the following figure.)

- To enter Diagnostics mode (level 2) on the SSPM, quickly insert and remove a Diagnostics card from the EMV card reader, and press **√ OK > X Cancel**.

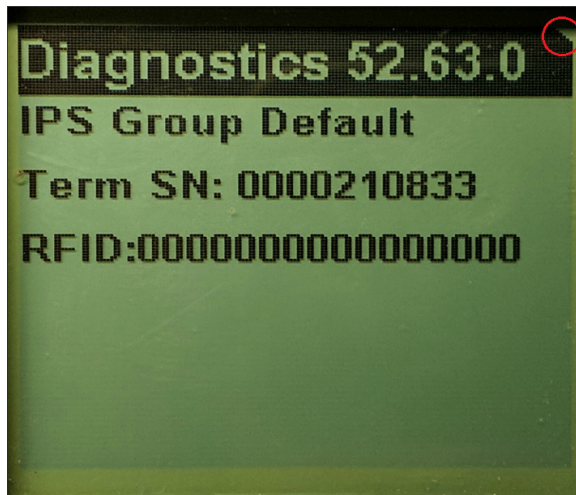

Level 3

Level 3 Diagnostics mode is signified by two blank hash marks in the upper-right hand corner of the Diagnostics mode main screen. (See the two red circles in the following figure.)

- To enter Diagnostics mode (level 3) on the SSPM, quickly insert and remove a Diagnostics card from the EMV card reader, and press **√ OK > + Time** (more time) > **— Time** (less time) > **X Cancel**.

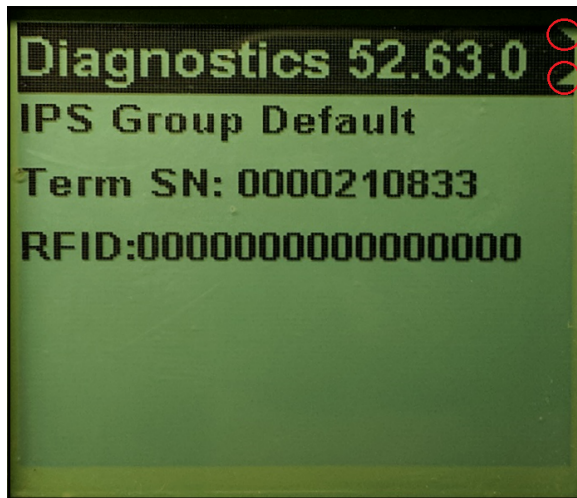

Sub-menus

From Diagnostics mode, press **+ Time** (more time) / **— Time** (less time) to scroll to sub-menu choices, and press **√ OK** to select / enter a sub-menu. (If **√ OK** is pressed within a sub-menu with no further options, press **X Cancel** to "back-out" of the sub-menu, and continue working within Diagnostics mode.)

Press **X Cancel** repeatedly at any time to exit Diagnostics mode, and return the SSPM to normal operating mode.

Faults

The *Faults* sub-menu shows any errors reported by the meter. When a fault / error occurs, the SSPM reports it to the IPS maintenance staff (through the DMS), as an email or SMS. The report conveys the type of fault, the time it occurred, and the location of the individual SSPM.

For example, an SSPM that experiences a coin blockage may report the following fault:
"Coin Blockage at Pole Serial Number X-YYY (Terminal Serial Number 0012345)"

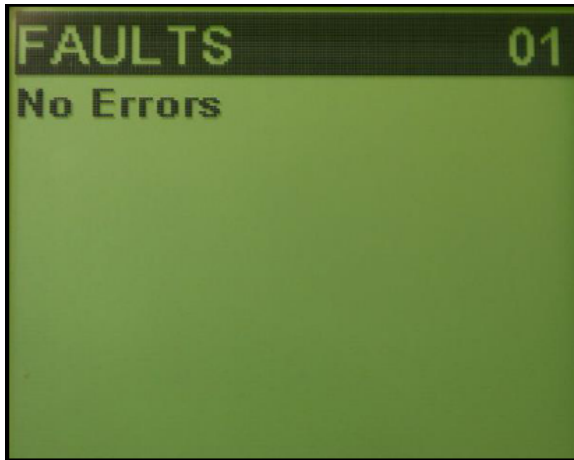

Coin Test

The *Coin Test* sub-menu allows IPS maintenance staff to verify the validator is operating properly, and coins are validated correctly. The two components in coin testing are:

- Coins = Shows the total coin count
- Value = Shows the value of the last coin inserted

When a coin is inserted into the SSPM, the *Coins* increases by one, and the *Value* shows the programmed value of that new coin. If a coin-type is inserted into the SSPM, but is programmed / configured as "not acceptable" (e.g. the U.S. Penny), the *Coins* increases by one, but the *Value* shows as a negative number.

If a coin is inserted but the *Coins* does not increase, there may be a fault with the meter and / or coin validator. If the *Value* shown for a specific coin is incorrect, the meter may not be programmed correctly.

Card Test

The *Card Test* sub-menu allows IPS maintenance staff to verify the card reader is operating properly. During a card test, quickly insert and remove a valid credit card. The LCD shows the card type, card number, and expiration date. If this information is not displayed, the card reader may be damaged or malfunctioning.

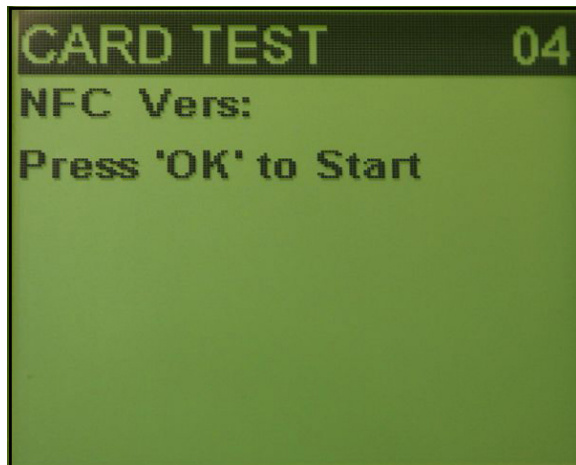

Comms Test

The *Comms Test* sub-menu allows IPS maintenance staff to test the SSPM's ability to communicate, by forcing it to “call-in” to the DMS. This test verifies that the SSPM can successfully communicate with the DMS, and updates the internal clock and available firmware / configurations.

At the Comms Test sub-menu, press $\sqrt{\text{OK}}$ to *Start* the communications test. The SSPM tests its communications through GSM, and then through GPRS.

Note: Once this communications test is initiated, do not press another button until the entire test is complete. Pressing any button during the communications test immediately interrupts it, and it does not finish.

A typical communications test steps through the following screens:

1. Press 'OK' to Start
2. GSM Starting
3. GSM Idle
4. GSM OFF
5. GPRS Connected
6. Switching OFF

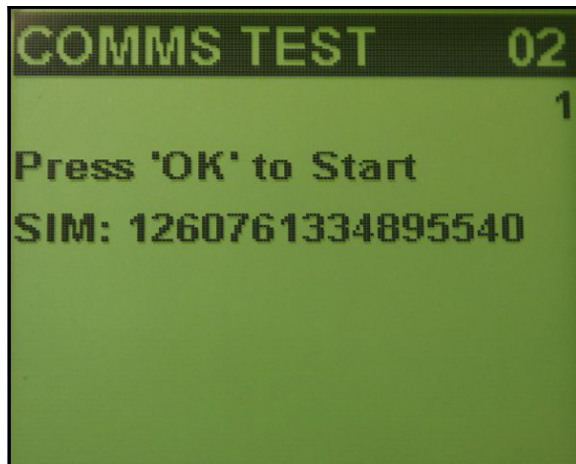

The bottom row of each screen displays information being transmitted / received. If at any point *Connected* is NOT shown on the LCD, or *Error* appears on the LCD, the meter is likely experiencing a communication error, due to a faulty communication module or a network error. In either case, ensure the meter receives a strong wireless signal before attempting the communications test again.

Fault Logging

The *Fault Logging* sub-menu allows IPS maintenance staff to research all faults that are logged on a meter. Scroll through the log to view each fault, and clear them each log event This log is transmitted wirelessly to the DMS, eliminating the need for pole-site fault log collection. Each meter can display the default fault-list, or you can contact IPS to customize the fault-list to your preference.

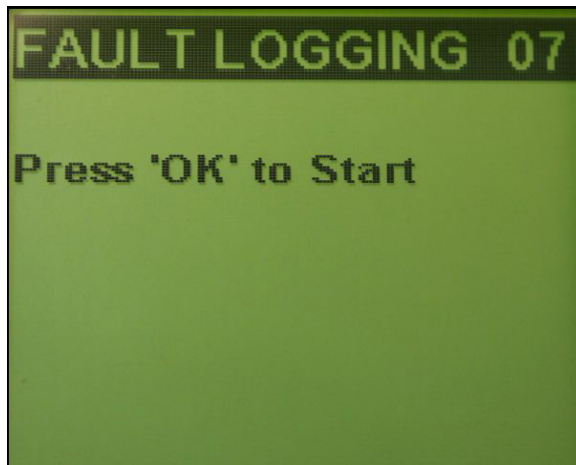

Meter Swap

The Meter Swap sub-menu must be used when removing a SSPM mechanism from a pole site, and replacing it with a different mechanism.

After the new mechanism is installed, enter *Diagnostics* mode and scroll to *Meter Swap*. Press \checkmark **OK** to *Continue*, then press **— Time** (less time) to *confirm*. The meter exits *Diagnostics* mode to return to normal operation, and completes the communication session in the background.

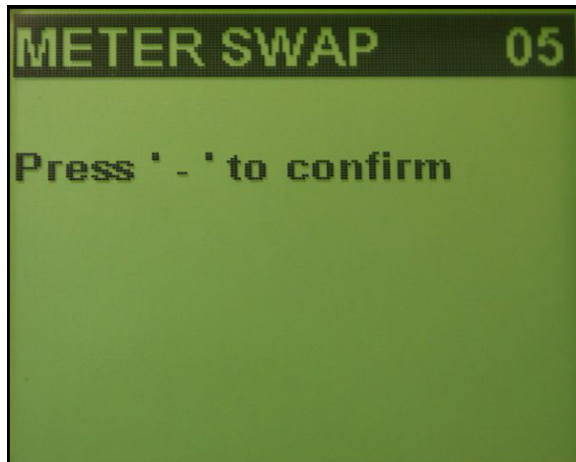
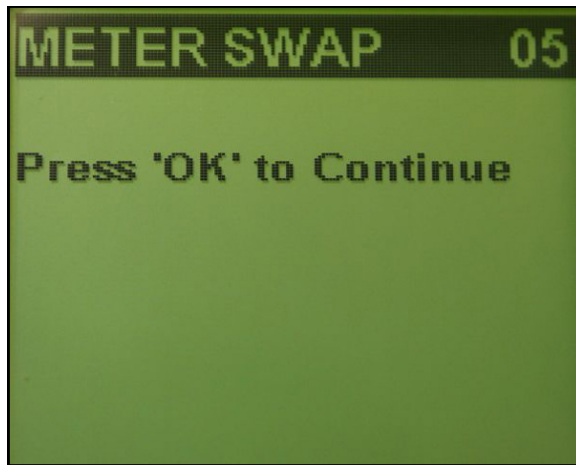

Voltages

The Voltages sub-menu shows the real-time power in milli-volts (mV) provided by the meter's solar panel, "Main" (rechargeable) battery , and "Backup" (non-rechargeable) battery, simultaneously.

The Main battery (a lithium polymer or cylindrical lithium-ion), is permanently mounted directly on the SSPM Main PCBA. The Backup battery (a lithium-thionyl chloride (Li-SOCl₂)), is a temporary battery housed and connected at the left side of the SSPM. Under optimal

conditions, this battery has a life expectancy of 5 years. Ultra-capacitors that always store power are installed in the M5™ SSPM to supplement the batteries, which are most beneficial in cold temperatures. The SSPM is designed to use power efficiently. When any light is available, the solar panel charges the Main battery. The Main battery supplies the SSPM with power until its voltage drops, and it can not power the meter sufficiently. At this point, power from the Backup battery supplements the meter's power consumption. Once the Main battery has enough power, it returns to powering the meter again, as usual.

Note: Once the voltage of the Backup battery has completely expired, it can no longer function and must be replaced.

The solar panel can be tested for proper operation by covering / uncovering the solar panel while ambient light is available. The voltage levels should change from low (covered), to high (uncovered) accordingly. The expected voltage levels are listed in the following table:

M5™ values	Maximum	Minimum	Nominal
Solar panel	5,500 mv	1,000 mv (with indoor lighting)	4,100 mv
Main battery	4,100 mv	2,800 mv	3,600 mv
Backup battery	3,680 mv	2,800 mv	3,600 mv

Sleep

The Sleep sub-menu allows the meter to be placed in sleep mode. Sleep mode places the SSPM in the lowest power-consumption state possible, without turning the meter completely OFF. If an SSPM must be "bagged" (out-of-service) for ≥ 48 hours, IPS recommends placing it into Sleep mode. If an SSPM must be bagged or stored for 1 month, IPS recommends turning the meter OFF (by disconnecting the jumper (JMP0002) at JMP6 header), and / or the Back-up battery.

To put the SSPM into Sleep mode, go to Diagnostics mode, and scroll to the Sleep sub-menu. Press $\sqrt{\text{OK}}$ to *Sleep*, then press **— Time** (less time) to *confirm*. The SSPM can also be put into Sleep mode by pressing and holding the Diagnostics button for ~5 seconds, until it emits an audible signal and (the LCD) turns OFF.

Understanding M5™ Battery Voltages

This concept topic discusses the IPS Group, Inc. M5™ SSPM batteries. It explains the process flow for checking the M5™ batteries, and what to do if one or both battery voltages are below an acceptable threshold.

This information is intended for internal use by IPS personnel, or a customer's authorized field technicians.

The M5™ SSPM uses two different batteries:

- Rechargeable Main Battery
- Non-rechargeable Backup Battery (Large external battery)

Process flow

The following figure summarizes the process flow.

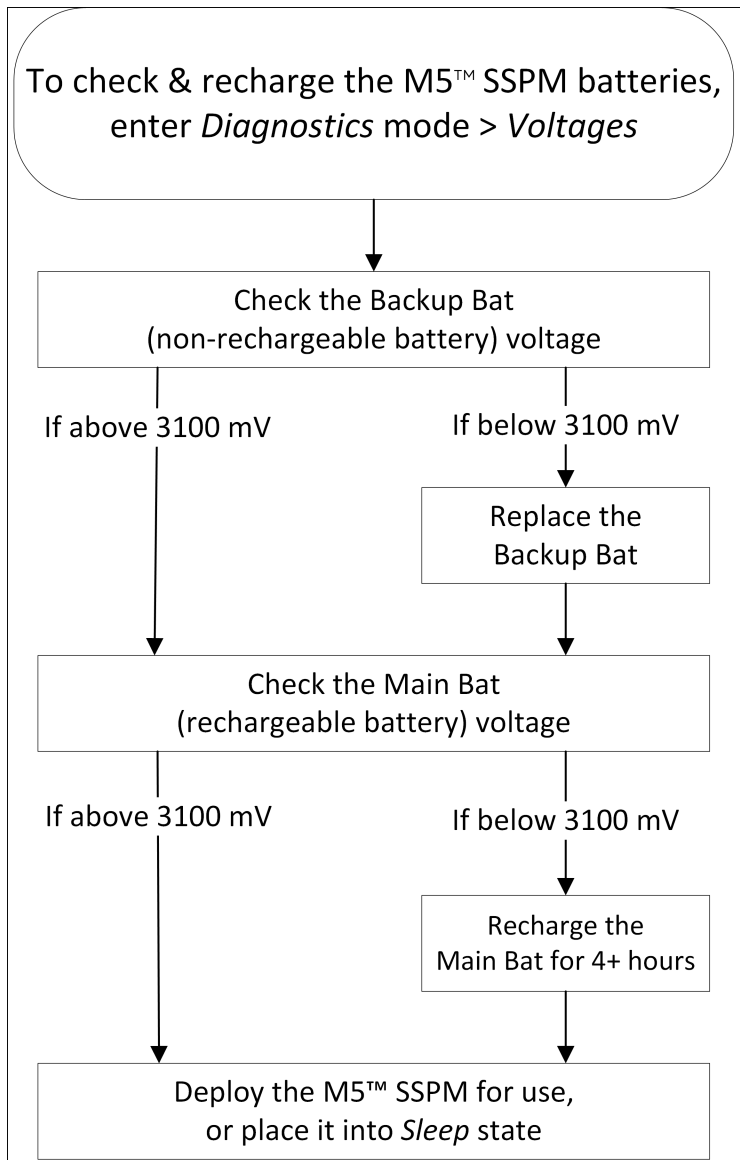

Related Topics

Click here to view the task topic [How To Check the M5™ Battery Voltage](#).

Click here to view the task topic [How To Charge the M5™ Main Battery](#).