



i-PORT MB Manual Version 1.1

IDENITEC SOLUTIONS AG
Millennium Park 2
6890 Lustenau
Austria

Tel. : +43 5577 87387-0
Fax : +43 5577 87387-15
info@identecsolutions.at
www.identecsolutions.com

Proprietary Notice

This document contains confidential information proprietary to IDEN TEC SOLUTIONS and may not be used or disclosed to other parties in whole or in part without prior written authorization from IDEN TEC SOLUTIONS.

Disclaimer and Limitation of Liability

IDEN TEC SOLUTIONS AG and its affiliates, subsidiaries, officers, directors, employees and agents provide the information contained in this Manual on an "as-is" basis and do not make any express or implied warranties or representations with respect to such information including, without limitation, warranties as to non-infringement, reliability, fitness for a particular purpose, usefulness, completeness, accuracy or up-to-dateness. IDEN TEC SOLUTIONS shall not in any circumstances be liable to any person for any special, incidental, indirect or consequential damages, including without limitation, damages resulting from use of or reliance on information presented herein, or loss of profits or revenues or costs of replacement goods, even if informed in advance of the possibility of such damages.

Trademarks

"IDEN TEC SOLUTIONS", "Intelligent Long Range", "ILR" and the stylized "i" are registered trademarks and "i-Q", "i-D", "i-B", "i-CARD", "i-PORT", "i-LINKS", "Solutions. It's in our name.", "Smarten up your assets" are trademarks of IDEN TEC SOLUTIONS, Inc. and/or IDEN TEC SOLUTIONS AG.

Copyright Notice

Copyright © 2006 IDEN TEC SOLUTIONS. All rights reserved.

No part of this document may be reproduced or transmitted in any form by any means, photographic, electronic, mechanical or otherwise, or used in any information storage and retrieval system, without the prior written permission of IDEN TEC SOLUTIONS.

Radio Frequency Compliance Statement

IDEN TEC SOLUTIONS is the responsible party for the compliance of the following devices:

MODEL:	i-PORT MB	i-CARD CF	i-B Tags
EUROPE:	CE	CE	CE

The user(s) of these products are cautioned to only use accessories and peripherals approved, in advance, by IDEN TEC SOLUTIONS. The use of accessories and peripherals, other than those approved by IDEN TEC SOLUTIONS, or unauthorized changes to approved products, may void the compliance of these products and may result in the loss of the user(s) authority to operate the equipment.

Operation is subject to the following conditions: (1) these devices may not cause harmful interference, and (2) these devices must accept any interference, including interference that may cause undesired operation of the device.

European Notification according R&TTE Directive (i-CARD 3 / EU)

This equipment complies to Art. 6.4 of R&TTE Directive (1999/5/EC). It is tested for compliance with the following standards:

EN 300 220-1 V1.3.1 (2000-09), EN 300 220-3 V1.3.1 (2000-09), ETSI EN 301 489 V1.4.1 (2002-08), ETSI EN 301 489 V1.4.1 (2002-08)

USA Notification

This device complies with part 15 of the FCC Rules. Operation is subject to the following two conditions: (1) This device may not cause harmful interference, and (2) this device must accept any interference received, including interference that may cause undesired operation.

Table of Contents

1	INTRODUCTION	5
1.1	FUNDAMENTALS.....	5
1.2	SYSTEM OVERVIEW	5
2.0	COMPONENTS	7
2.1	I-PORT MB.....	7
2.2	ANTENNAS	7
2.3.	I-B TAG	9
3.0	INSTALLATION AND SET-UP.....	10
3.1	MOUNTING THE I-PORT MB	12
3.2	INTERFACES AND LED DISPLAYS.....	15
4.0	COMMUNICATION PROTOCOL.....	17
4.1	TELEGRAM STRUCTURE, ESCAPING AND CRC	17
4.2	GET VERSION COMMAND	19
4.3	GET TAGS COMMAND	20
4.4	GET TAG EXTENDED COMMAND.....	22
4.5	GET TAG FULL COMMAND.....	24
4.6	SET PARAMETER COMMAND.....	26
4.7	GET PARAMETER COMMAND	27
4.8	READER PARAMETERS LIST	28
4.9	READER STATUS INFORMATION	31
5.0	INSTALLATION- CONFIGURATION	32
5.0	DEVICE ENUMERATION	32
5.1	FIRST TIME INSTALLATION ("SITE SETUP")	32
5.2	NORMAL INITIALIZATION ("APPLICATION ON HOST STARTING UP").....	33
5.3	NORMAL OPERATION ("HOST APPLICATION LOOP AFTER STARTUP").....	33
5.4	ERROR RECOVERY	33
5.5	HOW TO USE INHIBITS TIME, RE-REPORT INTERVAL AND LIST BEHAVIOR.....	33
5.6	EXCHANGING A READER WITHIN THE DAISY CHAIN	34
	TECHNICAL SPECIFICATIONS.....	35
6.0	APPENDIX	36
7.1	SAMPLE CRC CALCULATION	36

1 INTRODUCTION

1.1 Fundamentals

IDEN TEC SOLUTIONS' ILR[®] (Intelligent Long Range[®]) technology is the next generation of long range RFID (Radio Frequency IDentification). The objective is wireless and automated data collection over large distances.

HOW RFID WORKS

Data is transmitted via high frequency radio waves between a tag and an interrogator. Information stored on the tag can be read and processed. Data can be exchanged over large distances, even in extreme environmental conditions such as dust, dirt, paint or oil.

The core element of the system is the active ILR tag, which can communicate its' unique ID at a rapid rate of transmission over very large distances (up to 100 meters/300 feet). The reader (i-PORT MB) can decode data simultaneously from hundreds of these tags within seconds. Connection of the reader to a host computer system enables global data accessibility via a variety of software platforms (Internet).

CHARACTERISTICS OF ILR:

- UHF Frequency (868 / 915 MHz)
- Large read range of up to 100 meters (300 feet)
- Variable read range from just a few meters up to 100 meters (300 feet)
- Memory capacity 13 Bytes
- Long transponder battery lifetime (up to 6 years)
- Anti-collision process and multi-tag handling

1.2 System Overview

IDEN TEC SOLUTIONS' ILR-System consists of 4 main components:

- Active tags (also called transponders) with internal power supply, which are used to identify goods or assets
- Reader (i-PORT; fixed-mounted) or handheld devices (mobile) which exchange information with the tags and host computer systems
- Various antenna types/characteristics for different applications
- A central computer system as basis for control and monitoring

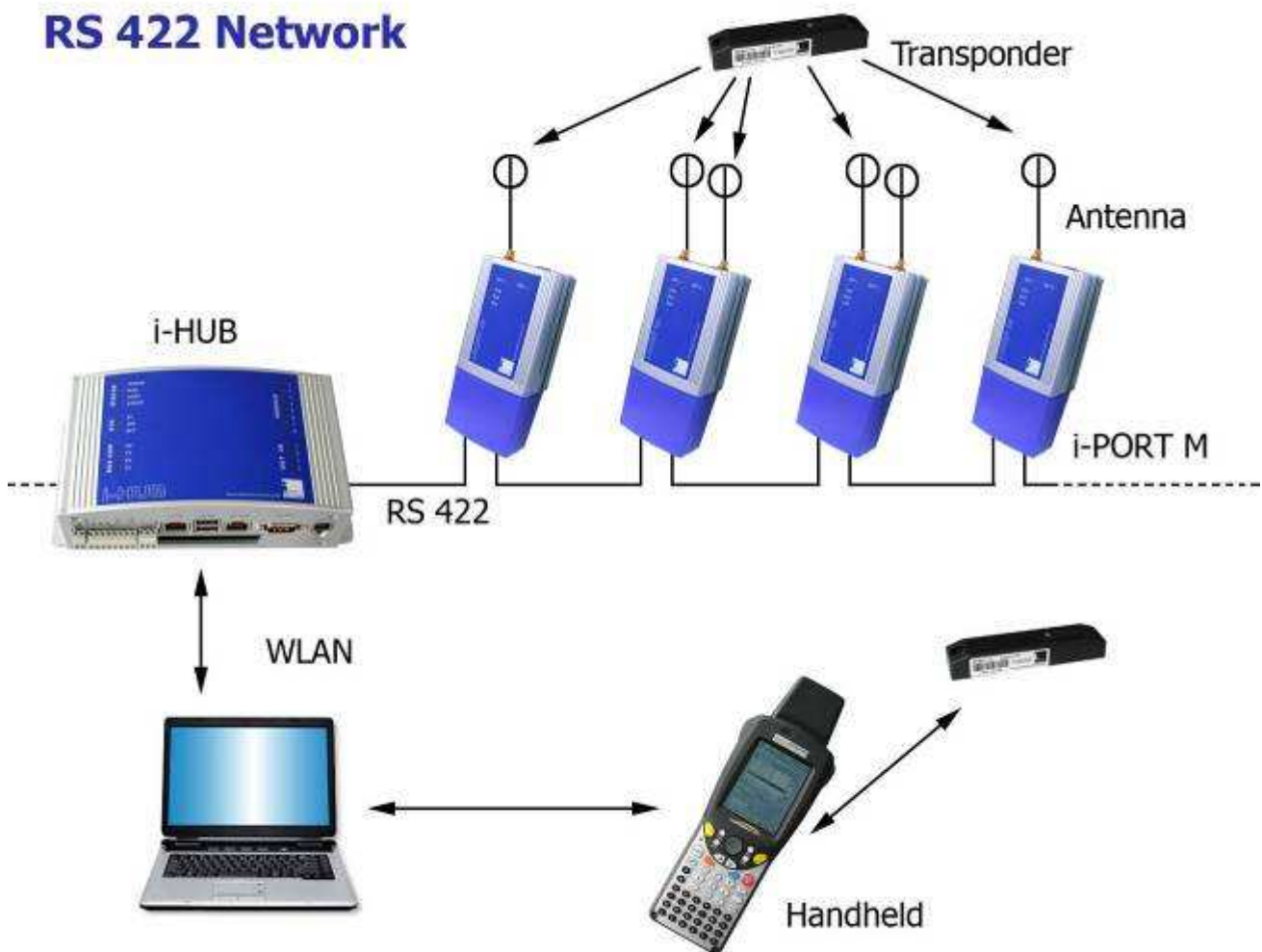

Figure 1: ILR System Components

ILR System Components:

- Tags from the i-B series transmit stored data over large distances. The high data transmission rate ensures optimal communication.
- The fixed reader (i-PORT MB) receives the data transmitted by the tags in regular intervals and buffers the received data for later transmission via a RS422 network connected to a master PC.
- Handheld readers, based on the PC-card i-CARD R2 or Compact Flash i-CARD CF iB, can also be used to receive transmissions from the tags over distances up to 30m. After decoding this data can either be processed locally or transferred to a network via optional radio cards (WLAN, GPRS).

2.0 COMPONENTS

2.1 *i-PORT MB*



The i-PORT MB is a reader for the i-B series of ILR® Broadcast Tags. Built into a compact plastic housing, the i-PORT MB receives transmissions from the i-B tags at distances of up to 100 meters (300 feet). Connection to the host system is established via a RS422 interface, resulting in the capability to connect up to 8 readers in a Daisy Chain using commercially available CAT 5 cables and connectors.

A simple master/slave protocol enables data exchange. Not only does the protocol contain the data received from the tag but it can also provide information about the time of data reception, field strength and information about the number of times the tag has been received by the reader.

2.2 *Antennas (EU only)*

IDENTEC SOLUTIONS' antennas are distinguished by their compact design. A variety of antennas can be used, depending on application. The antennas are differentiated by characteristics such as polarization, apex angle, and gain. Optimal fit to the read zone is achieved by the right choice of antenna (characteristics) and receive sensitivity. As the antennas are passive system elements, no tuning is required, which facilitates installation and maintenance.

Elliptical Polarized Antennas



Because of the wide apex angle (120°) a large read zone is achieved, which is desirable when a large quantity of tags need to be read at one time, or when tags moving at great speeds need to be interrogated.

Since the polarization is elliptical, orientation of the tag relative to the antenna is not important: if the tag is in front of the antenna the tag may be polarized horizontally or vertically along the line of sight of the antenna. Due to its small size and weight, this antenna is very easy to integrate.

Orientation Diagrams: Elliptical polarized antenna

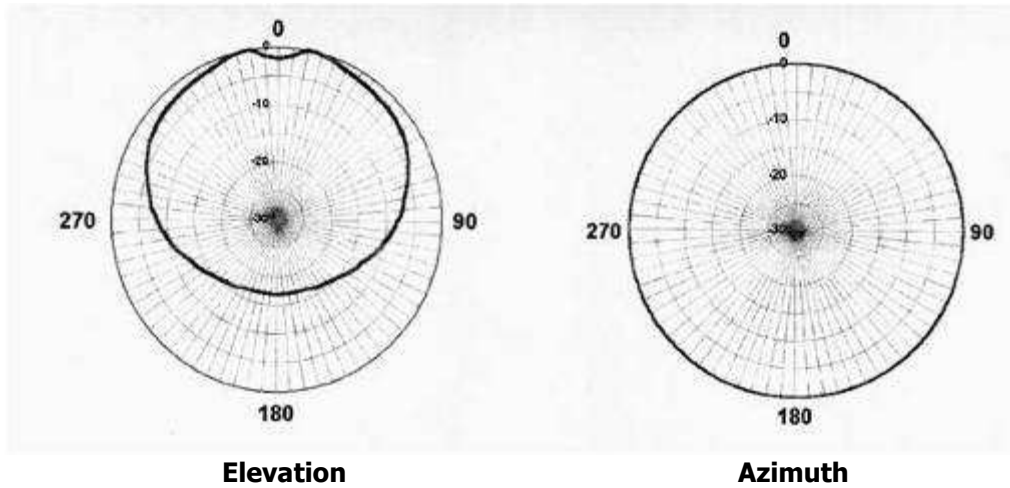

Linear Polarized Antennas



Because of the smaller apex angle (60°), this antenna is more suited to selective data collection and restriction of read zones.

Depending on the direction of mounting, the antenna's field is either vertically or horizontally polarized, requiring the tag to have the same orientation.

Because of the greater gain, longer read ranges can be achieved with this antenna compared to the elliptical polarized type above.

Orientation Diagrams: Linear polarized antenna

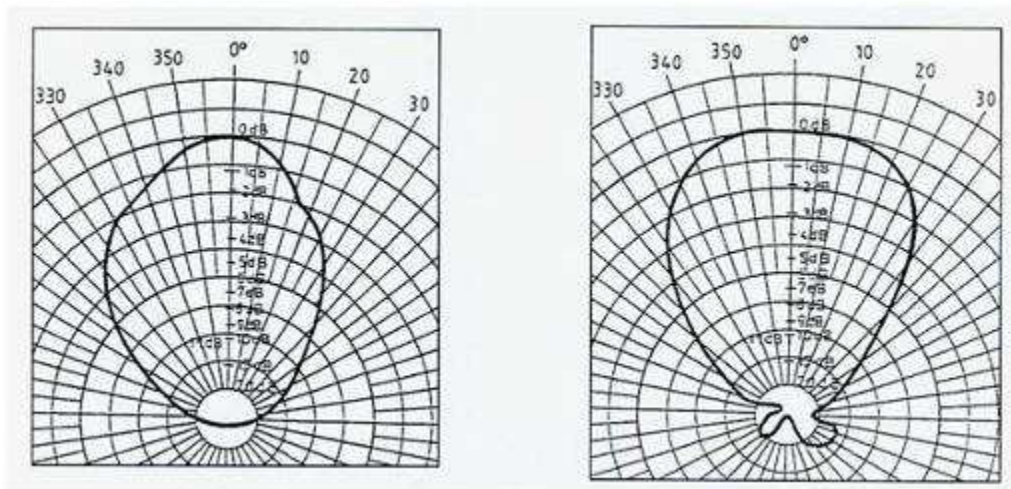

**Elevation
Vertical Polarization**

**Azimuth
Horizontal Polarization**

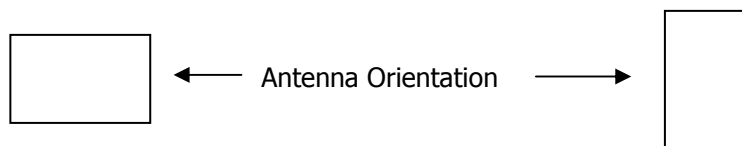

2.3. i-B Tag



This active tag is particularly suited for:

- Identification
- Tracking and Tracing

Using ILR technology, distances of up to 100 meters (300 feet) can be achieved with this tag. An operation lifetime of up to 6 years (depending on ping rate) can be expected due to the tag's minimal energy requirement.

Used in combination with the i-PORT R2 or i-CARD R2, several hundred tags can be detected nearly simultaneously, thanks to an anti-collision algorithm.

i-B tags are available in a variety of configurations and form factors. Memory capacity is 13 Byte (17 characters packed). Furthermore, they are available at 868 MHz for use in Europe and at 915 MHz for use in America.

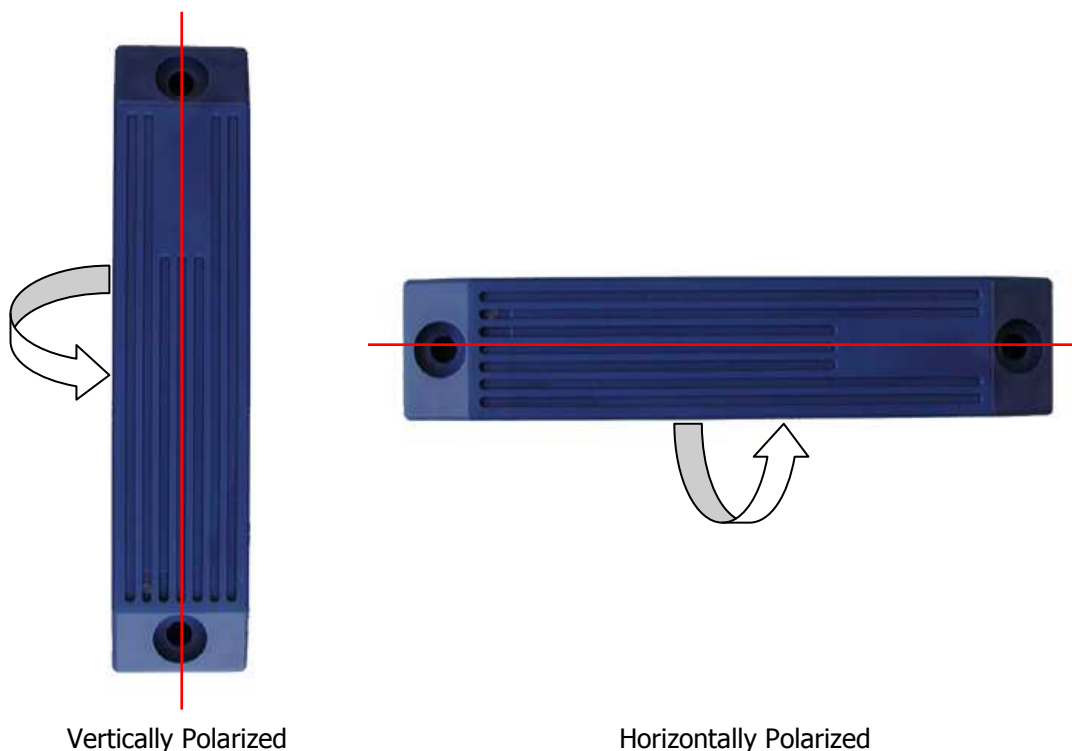

Polarization is dependent on orientation and is rotation symmetrical.

3.0 INSTALLATION AND SET-UP

IDEN TEC SOLUTIONS' ILR-System consists of several components:

- Tags (also called transponders)
- Readers (fixed i-PORT reader or i-CARD in mobile handheld/notebook)
- Antennas
- A central computer system as basis for control and monitoring or a handheld with an i-CARD

Before installation, the user should have thorough knowledge of the application. The read locations need to be defined; whether the object is moving or stationary needs to be determined. If the objects in question are moving objects, their speed is important for calculating receiving probability and the needed ping rate of the tag.

Mounting Site:

The i-PORT should be mounted fairly close to the read location as lengthy antenna cables reduce the range of the system. A 10-meter coaxial cable (RG 58 C/U) shows a loss of 6 dB. This in turn means a reduction of the read range by 50% (see diagrams).

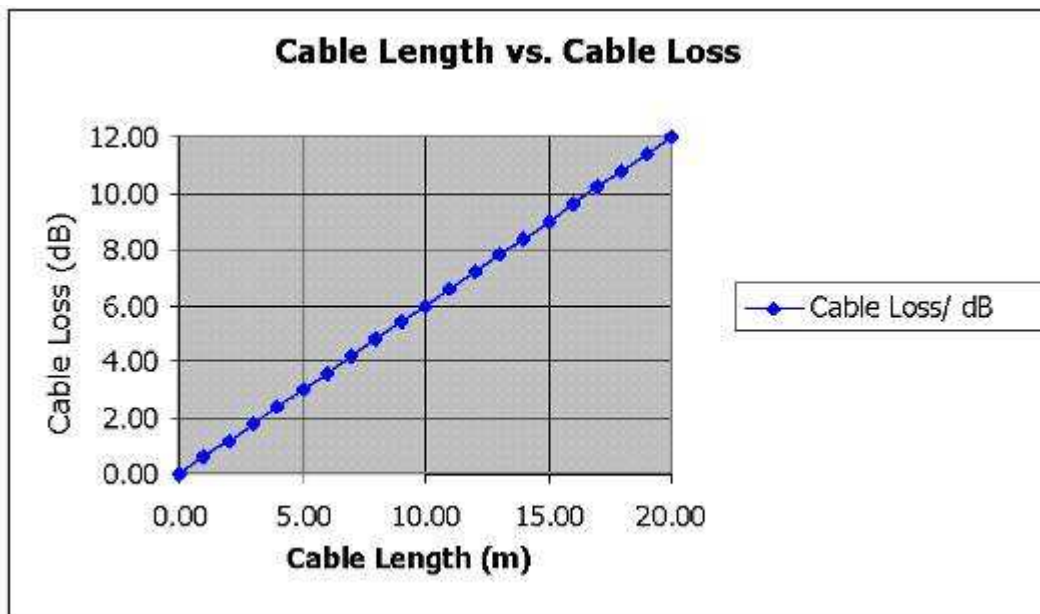

Cable losses as a function of cable length are displayed in the above diagram. The values are based on an RG58 coaxial cable at a frequency of 900 MHz.

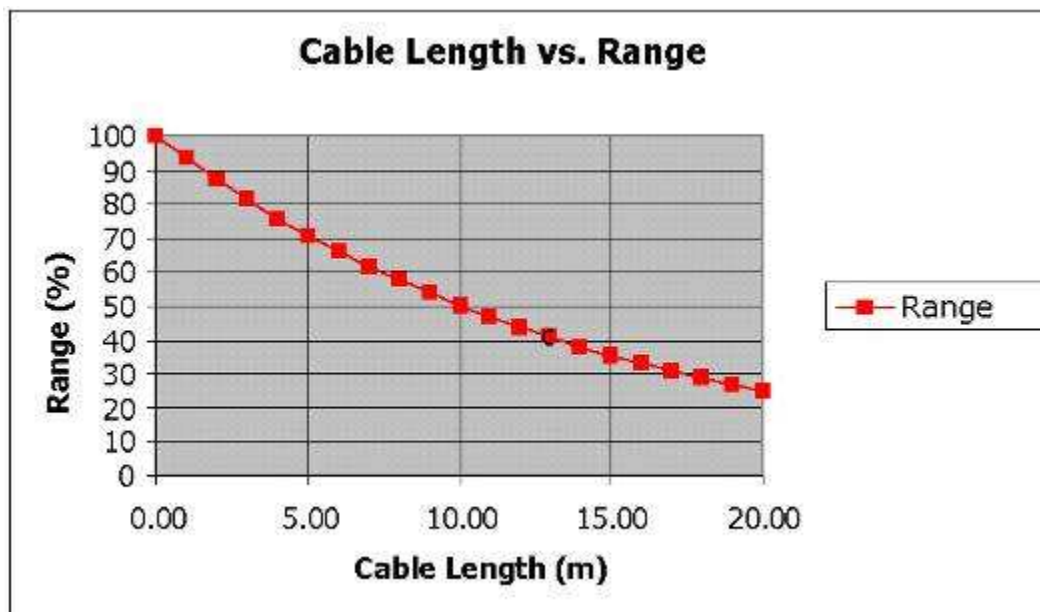

In the diagram above, the **relative** range is displayed as a function of the cable length. Relative because the range is dependent on the environment of the system. Under ideal conditions (free field, i-PORT R2), ranges of up to 100 meters (300 feet) can be achieved. But if 20 meters of antenna cabling are used, the cable losses amount to approx. 12 dB, which reduces the original range to just one-quarter (25 meters)!

The range losses as displayed in the diagram are independent of the original range. If the range is 30 meters (100 feet) and 10 meters of antenna cabling are used, the range is reduced by 50%.

After mounting the i-PORT MB, the antennas need to be installed and connected to the designated antenna sockets. If antenna extension cables are required, check these for function or short circuits before you begin with the start-up.

Alignment of Antennas:

Align the antennas with the tags or the objects to be monitored. Linearly polarized antennas must have the same polarization as the tags, either horizontal or vertical. Circular polarized antennas are not dependent on the polarization of the tags.

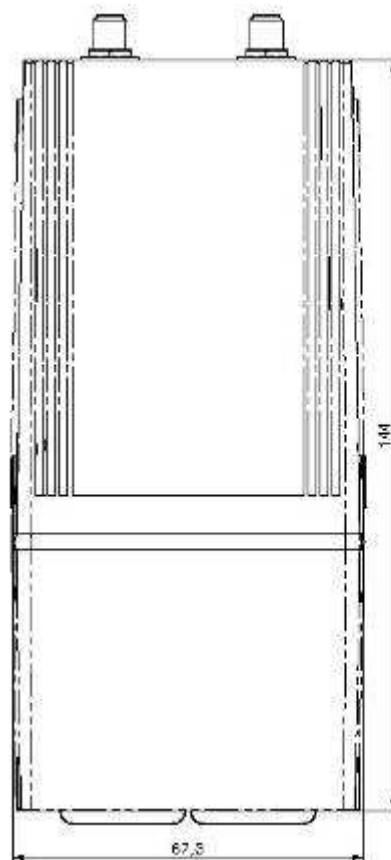
3.1 Mounting the i-PORT MB**Dimensions without mounting kit and with end cap**

Dimensions without mounting kit and without end cap

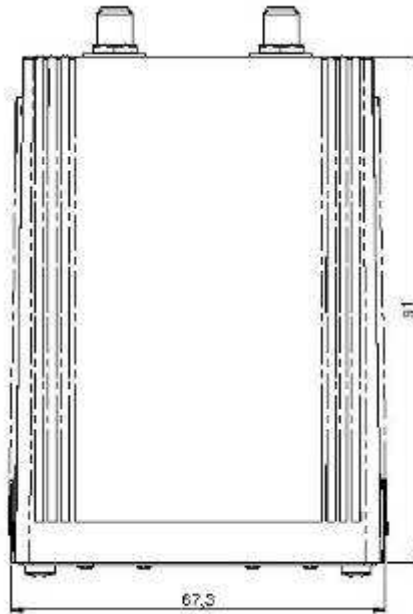

Mounting kit

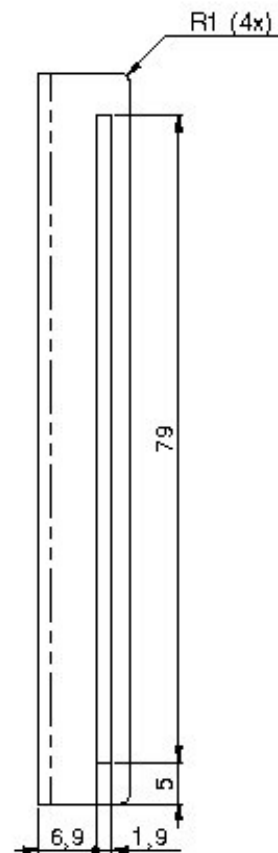
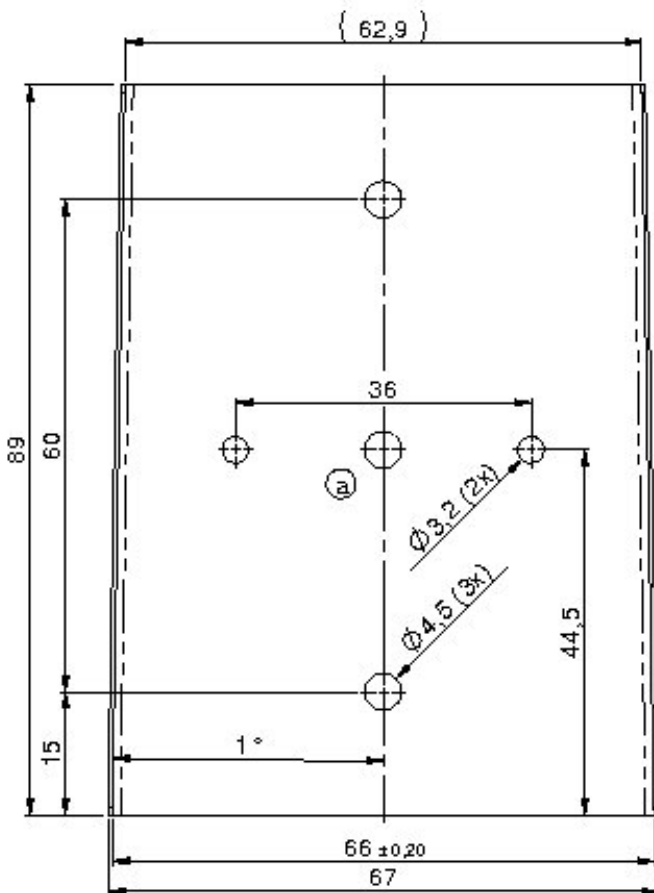

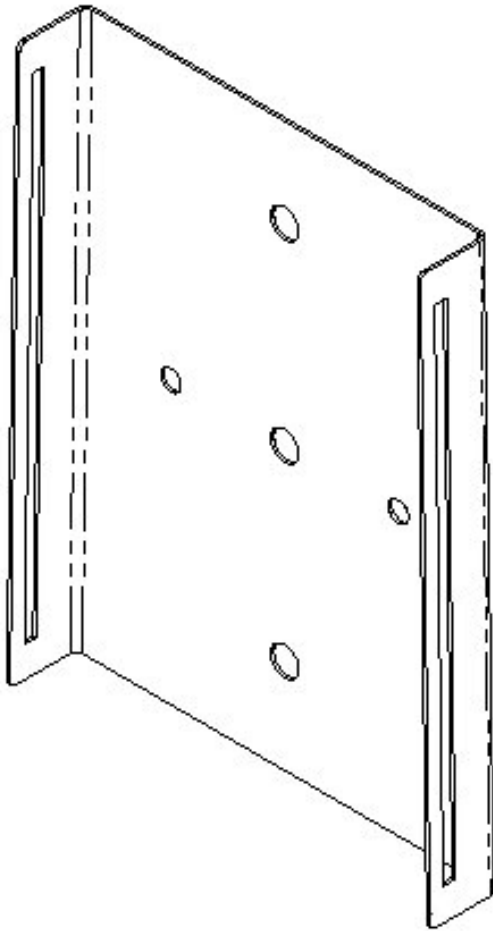

The mounting kit is to be clipped on the back of the i-PORT MB, there is 5 mm space left for the screws between the mounting kit and the reader.

Use the two mounting holes (diameter 4,5 mm) to attach the i-PORT MB mounting kit to a suitable mounting surface. Once the mounting kit is fixed, clipped in the i-PORT MB reader.

Please add to the i-PORT MB dimensions approximately 70 mm on the antenna side and 40 mm on the cable side to calculate the required mounting space. The i-PORT MB weights approx. 150 g.

Enclosure rating is IP40 without the end cap and IP64 with. If greater enclosure rating is required, the i-PORT MB must be placed in an additional protective housing, in this situation the end cap could be removed.

3.2 Interfaces and LED Displays

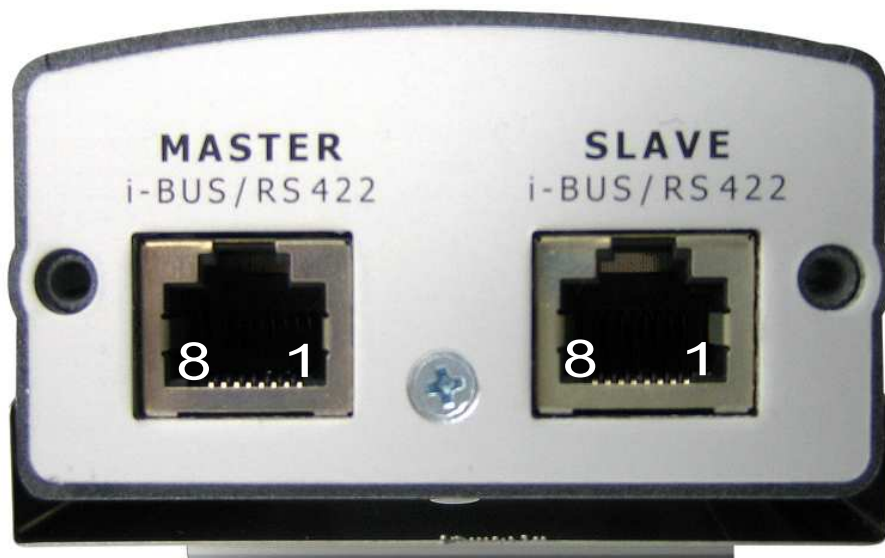

1 - RX+
2 - RX-
3 - TX+
4 - V+ (10..30V)
5 - V+ (10..30V)
6 - TX-
7 - GND
8 - GND

1 - TXS+
2 - TXS-
3 - RXS+
4 - V+
5 - V+
6 - RXS-
7 - GND
8 - GND

T568B colors

1 - White/orange
2 - Orange
3 - White/Green
4 - Blue
5 - White/Blue
6 - Green
7 - White/Brown
8 - Brown

Please note:

- The device uses RS422 levels on its RX and TX Pins, although Ethernet jack/plugs mechanically fit, the device is not Ethernet compatible.
- Industry standard cat 5 straight patch cables can be used to daisy chain the devices

Connectors:

To Master: RJ 45 connector to the Host computer or the Slave port of the previous i-PORT MB in the Daisy Chain.

To Slave: RJ 45 connector to the Master port of the next i-PORT MB in the Daisy Chain. Leave this connector open at the last device in the chain.

Connection parameters:

Signal levels: RS422
Baud rate: 115200 bits per second
Data bits: 8
Stop bits: 1
Parity: none
Mode: half duplex

Status LEDs:**ANT 1/ANT 2**

LED blinks green when a telegram preamble has been detected. It blinks RED when a tag telegram has been decoded correctly and the tag RSSI level is within the limit defined in the parameters (Tag RX entry level and tag RX exit level).

RUN

Device is running properly (LED blinks at approx 1Hz)

BUS

Blinks GREEN when data is received from the host. Blinks RED when sending data to the host

ERR

Blinks RED when an error occurs

4.0 COMMUNICATION PROTOCOL

4.1 Telegram Structure, Escaping and CRC

Operation of the i-PORT MB follows strictly the Master/Slave principle. Readers are slaves and there is no information sent by the readers unless requested by the master computer.

The data is divided into separate messages with the following structure:

SOH	Addr	Cmnd	data	...	Crc16	EOT
------------	-------------	-------------	-------------	------------	--------------	------------

SOH and EOT are the ASCII characters 0x01 and 0x04, respectively.

Addr is the bus address of the telegram recipient.

Cmnd represent the command ID or response ID.

Data represent the Command specific information.

Crc16 is the telegram cyclic redundancy check.

Bus communication

The bus has only 1 master and various slaves uniquely identified by a bus address.

Communication can only occur between the master and 1 of the slave. There is no direct communication possible between 2 slaves.

The bus address in a telegram identifies the recipient if sent by master or the sender if sent by slave.

Addresses 0xF0 up to 0xFD are reserved.

0xFF is the broadcast address.

0xFE addresses any reader which has its slave port disconnected which give an opportunity to communicate with the last reader connected on the bus. This functionality is used to discover readers on the bus.

Starting at addresses $\geq 0x11$ is recommended to avoid the need for escape sequences for the device address.

Addresses 0x30 ('0') or 0x41 ('A') might be convenient values to start with. Commands sent to the broadcast address cause no response unless otherwise noted. A reader addressed with 0xfe responds with its assigned short address (as opposed to 0xfe) in its response telegram.

Escape sequences

As the protocol is binary and does not contain length information some special characters must be "escaped" in order to allow correct reception and decoding. This is done by adding a DLE- (0x10) character and adding binary 0x80 to the character being escaped. These characters and the corresponding escape sequences are:

Character	Code	Escape sequence
SOH	0x01	0x10, 0x81
EOT	0x04	0x10, 0x84
DLE	0x10	0x10, 0x90

This encoding is done after the CRC is added; removing on the receiving side must be done before the CRC is checked.

Using this procedure it is ensured, that neither the EOT nor the SOH character will appear in a message sent by the reader and the host software gets a clear indication when a telegram starts and ends.

Please note, that due to these inserted characters the maximum telegram length can be nearly doubled so the host program has to provide a sufficiently large reception buffer.

If an addressed device detects an error when receiving a command (f.e. CRC is not valid or an invalid command is detected) the device will not respond to avoid collision of messages sent by multiple readers.

CRC calculation

Telegram integrity is ensured by adding a cyclic redundancy check to each frame.

The CRC16 is calculated according to the code provided in the appendix of this document. The CRC16 is calculated over the entire message, including Addr and Cmnd, but excluding the delimiting characters SOH and EOT and extra escaped characters.

Note: CRC is calculated by the sender before any DLE replacement of special characters takes place and checked by the receiver after any DLE replacement sequence has been decoded.

General information

The protocol uses a query response scheme, so a reader does not send data unless requested to. As there is no handshake over individual characters the host has to be able to receive the complete response. The host shall check that there is enough memory to receive the full reader response.

If a host message is broadcasted to multiple readers using a broadcast address, there will be no response from any reader.

The communication between readers and host is always with the **Less Significant Byte transmitted first**.

Any command sent by a host to a reader and decoded with no framing error will be acknowledged unless a broadcast address has been used. In case of framing error during a message reception, the reader will not process and not acknowledge the message.

4.2 Get version command

Get Version Command telegram

This command is used to get both a binary version number plus a version identification string from the reader.

Parameter	Range	Length/byte
Start	SOH	1
Address		1
Command	0x33	1
Crc16		2
End	EOT	1

Get Version Response telegram

The reader responds with a message as follows:

Parameter	Range	Length/byte
Start	SOH	1
Address		1
Command	0xB3 (= 0x33 + 0x80)	1
Major Version		1
Minor Version		1
Info	ASCII string	20
Crc16		2
End	EOT	1

4.3 Get Tags command

Command telegram

After power-up the reader automatically starts reading and stores detected tags in an internal list. With this command the tags can be retrieved from the reader:

Parameter	Range	Length/byte	Remark
Start	SOH	1	
Address		1	
Command	0x41	1	
SubCmd	0x00	1	
CRC16		2	
End	EOT	1	

Response telegram

The Reader can be configured to send more than one Response telegrams to one Get Tags Command. The maximum number can be configured by the Set Parameter command (see below). If less than 256 tags have newly been detected, these tags will be transmitted in their detection order. Additional tags or tags which are re-reported (see parameters 0x13, 0x15) might be transmitted in any order.

Parameter	Range	Length/byte	Remark
Start	SOH	1	
Address		1	
Command	0xC1	1	
Status	0x00/0x10	1	Note 1
AgeCount		2	Note 2
TagID		4	LSB first
UserData		9	Note 3
Flags		1	Note 4
RSSI		1	Note 5
CRC16		2	
End	EOT	1	

Notes:

- Status is 0x00 on success. If all received tags have been sent but the maximum number of response telegrams (see Set Parameter 16 below) is not reached an empty telegram is sent as termination. In this status is set to 0x10, data to binary 0x00 and RSSI to -128.

If the number of response telegrams is limited by parameter 0x16 the inner loop could follow the algorithm (Pseudo-C)

```
for( i=0; i<Parameter_0x16_Number_of_tags_allowed; i++ )
{
    receive_response_telegram();
    if( (0x10 == response_telegram.status) || timeout )
        break;
}
else
```

```

    process_response_telegram();
}

```

- The transmitted AgeCount contains the lower 8 bits b0..b7 and the highest 8 bits b20..b27 of the tag age counter c0..c15 (this is the result of a "mapping" of the 32 bit age counter on the tag to 2 byte transmitted by RF).

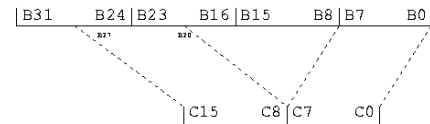

The lowest bits are used to change telegram contents and encryption between transmissions while the upper bits are used to estimate tag life (and remaining lifetime). This byte counts up by one roughly all 1 million telegrams (12 days @ 1 second ping rate).

- 9 byte of data, can be programmed according customer's need by IDEN TEC SOLUTIONS or representative
- 1 byte of flags, are set during programming of tag. Depending on tag version additional information (i.e. battery status in bit7) can be part of this byte. The lowermost 6 bit are freely available (Tag Firmware 0.3).
- Signal strength of tag as signed char (0xff = -1dBm, 0x80 = -128dBm). This is the maximum RSSI value of the last detection recorded on both antennas. If the last detection was on 1 antenna only then the reader returns the RSSI of this antenna.

4.4 Get Tag extended command

Command telegram

This command corresponds to the "Get Tags" Command but requests additional information.

Parameter	Range	Length/byte	Remark
Start	SOH	1	
Address		1	
Command	0x42	1	
SubCmd	0x00/0x01	1	With 0x01 an additional TelegramCount is transmitted, see below
CRC16		2	
End	EOT	1	

Response telegram

Parameter	Range	Length/byte	Remark
Start Delimiter	SOH	1	
Addr		1	
Cmdnd	0xc2 (= 0x42 + 0x80)	1	
Status	0x00/0x10	1	See remark at "Get Tags Response telegram"
Len		1	
HFProtID		1	As transmitted by the tag
AgeCount		3	MSB currently not used
TagID		4	LSB first
UserData		9	
Flags		1	
BatteryNumber		1	Not used (reserved)
DecryptKeyIndex		1	Not used (reserved)
Reserved		4	Not used (reserved)

TimeFirst		4	Time first detected (Note 1)
TimeLast		4	Time last detected (Note 1)
RSSI		1	Receive Signal Strength Indicator
RSSI(max)		1	Maximum RSSI since last transmission
#seen		1	number of times tag was detected since last transmission to host

TelegramCount		0/1	This byte is only transmitted if the SubCmd is 0x01. It is incremented each time it is transmitted. If the value on host and reader are inconsistent the complete list of tags can be scheduled for retransmission with parameter 0x15. If you should see errors here please also check for timeouts and crc errors on the host and on the reader (parameter 0x04)
crc16		2	
End Delimiter	EOT	1	

Note 1: Time in seconds, signed integer (relative to the time the last command was issued).

TimeFirst: This is the first time the tag has been detected on one of the antenna

TimeLast: This is the last time the tag has been detected on one of the antenna

RSSI: This is the maximum value of the last detection information on both antennas → MAX(RSSI ant 1, RSSI ant2) for last detection time.

RSSI Max this is the maximum RSSI value detected on any antenna. MAX (Max RSSI ant1, Max RSSI ant2) since last transmission.

#seen: This is the maximum number of detection of the tag on both antenna → MAX(#seen ant1, #seen ant2) since last transmission.

4.5 Get Tag Full command

This command corresponds to the "Get Tags extended" Command but requests additional information regarding all antennas.

Command telegram

Parameter	Range	Length/byte	Remark
Start	SOH	1	
Address		1	
Command	0x40	1	
SubCmd	0x00/0x01	1	With 0x01 an additional TelegramCount is transmitted, see below
CRC16		2	
End	EOT	1	

Response telegram

Parameter	Range	Length/byte	Remark
Start Delimiter	SOH	1	
Addr		1	
Cmdnd	0xc0 (= 0x40 + 0x80)	1	
Status	0x00/0x10	1	See remark at "Get Tags Response telegram"
Len		1	
HFProtID		1	As transmitted by the tag
AgeCount		3	MSB currently not used
TagID		4	LSB first
UserData		9	
Flags		1	
BatteryNumber		1	Not used (reserved)
DecryptKeyIndex		1	Not used (reserved)
Reserved		4	Not used (reserved)
TimeFirst Ant 1		4	Time first detected (Note 1)
TimeLast Ant 1		4	Time last detected (Note 1)
RSSI Ant 1		1	Receive Signal Strength Indicator
RSSI(max) Ant 1		1	Maximum RSSI since last transmission
#seen Ant 1		1	number of times tag was detected since last transmission to host
TimeFirst Ant 2		4	Time first detected (Note 1)
TimeLast Ant 2		4	Time last detected (Note 1)
RSSI Ant 2		1	Receive Signal Strength Indicator
RSSI(max) Ant 2		1	Maximum RSSI since last transmission
#seen Ant 2		1	number of times tag was detected since last transmission to host

TelegramCount		0/1	This byte is only transmitted if the SubCmd is 0x01. It is incremented each time it is transmitted. If the value on host and reader are inconsistent the complete list of tags can be scheduled for retransmission with parameter 0x15. If you should see errors here please also check for timeouts and crc errors on the host and on the reader (parameter 0x04)
crc16		2	
End Delimiter	EOT	1	

Note 1: Time in seconds, signed integer (relative to the time the last command was issued).

4.6 Set parameter command

Command telegram

This command is used to initialize and configure the reader. All the parameters and functions are defined in a sub- command field contained in the telegram.

Parameter	Range	Length/byte	Remark
Start	SOH	1	
Address		1	
Command	0x43	1	
SubCmd		1	See table below
Arg		4	See table below. Most significant byte first.
CRC16		2	
End	EOT	1	

Response telegram

Parameter	Range	Length/byte	Remark
Start	SOH	1	
Address		1	
Command	0xc3	1	
Status		1	Note: 0x00 denotes success, 0x11 Voltage to low to write
CRC16		2	
End	EOT	1	

4.7 Get parameter command

Command telegram

Parameter	Range	Length/byte	Remark
Start	SOH	1	
Address		1	
Command	0x44	1	
SubCmd		1	See table below
CRC16		2	
End	EOT	1	

Response telegram

Parameter	Range	Length/byte	Remark
Start	SOH	1	
Address		1	
Command	0xc4	1	
Status		1	
Argument		4	Most significant byte first.
CRC16		2	
End	EOT	1	

4.8 Reader parameters list

Each parameter is coded on 4 bytes with LSB transmitted first.

ID	R/W	Default	Definition	Description
0x00	W	NA	Reset To default	Used to reset all parameters to default values.
0x01	R		Serial number	Reader serial number
0x02	R	NA	Up Time	Seconds since last reset
0x03	R	NA	Checksum and bootloader	Byte 0 → Checksum Status Byte 1 → Boot loader version
0x04	R	NA	Status	See Reader Status information table below for bit definition
0x05	R	NA	External supply voltage	In mV.
0x06	R	NA	Get temperature	Internal voltage in units of 1/100 th degree Celsius. This is an estimate of CPU temperature, don't use this.
0x10	R/W	1	Slave port connected	0 → Disconnect 1 → Connect (always default value after Power-up)
0x11	R/W	0	Bus Address	0x00 up to 0xEF
0x12	R/W	60	Inhibit Time	Time in seconds until tag is removed from the internal list. 0x00 – don't remove tags from list When using 0x00 here the host application typically should clear or reschedule the list (SubCmd 0x15) on startup
0x13	R/W	60	Re-reporting interval	0x00 – do not re-report. time in seconds after which a tag is re-reported if it is still detected. See Note 1
0x14	R/W	0	List behaviour	0x00 → discard old tags if list gets too full. This is the recommended setting for most applications. 0x01 → clear list if list gets too full. 0x04 → remove tags from list when they are reported. This mode is used to determine the ping rate of the tag. Please Clear or reschedule list (SubCmd 0x15) or power cycle the device after changing this parameter
0x15	W	NA	List command	0x00 - Clear list now 0x01 – mark all tags in list as not yet reported. This causes a resend of all tags in memory ('schedule for retransmission').
0x16	R/W	0	Max transmitted tags	Set to any number below 100. Allows for predictable runtime behaviour of the host application. 0 → no limit
0x17	R/W	-128	Tag entry RX level	Signed char 0xff = -1dBm 0x80 = -128dBm
0x18	R/W	-128	Tag exit RX level	Signed char 0xff = -1dBm 0x80 = -128dBm
0x19	R/W	1	RF sensitivity	0x00 – low sensitivity (-55 dBm) 0x01 – high sensitivity (-85 dBm)
0x1A	R/W	-70	RF reference level	Signed char (used for HF statistics, default -70dBm. 0xff = -1dBm 0x80 = -128dBm This parameter is not used in the MB reader

0x1B	R/W	-128	Tag entry RX level Ant 1	Signed char 0xff = -1dBm 0x80 = -128dBm
0x1C	R/W	-128	Tag exit RX level Ant 1	Signed char 0xff = -1dBm 0x80 = -128dBm
0x1D	R/W	1	RF sensitivity Ant 1	0x00 – low sensitivity (-55 dBm) 0x01 – high sensitivity (-85 dBm)
0x1E	R/W		Reserved	
0x1F	R/W	0	RF offset Ant 1	Signed char in dB This offset is added to the tag RSSI value before being processed
0x20	R/W	-128	Tag entry RX level Ant 2	Signed char 0xff = -1dBm 0x80 = -128dBm
0x21	R/W	-128	Tag exit RX level Ant 2	Signed char 0xff = -1dBm 0x80 = -128dBm
0x22	R/W	1	RF sensitivity Ant 2	0x00 – low sensitivity (-55 dBm) 0x01 – high sensitivity (-85 dBm)
0x23	R/W		Reserved	
0x24	R/W	0	RF offset Ant 2	Signed char in dB This offset is added to the tag RSSI value before being processed
0x25	R/W		Frequency	This parameter is writable only if the reader supports more than 1 frequency and the frequency can be changed otherwise it will return the reader frequency. 1 → EU 2 → NA
0x26	R/W		Reserved	

Note 1: Tags which have not been detected for an interval longer on than the inhibit time (and have been transmitted to the host) are removed from the list. Tags which are still in the list are re-reported if the re-reporting interval has expired.

Tags are only removed from the list after one of those conditions:

- Tag is reported and the inhibit time condition occurs.
- The list is full and list behaviour is set to 0
- After issuing a clear list command (parameter 0x15).

List Command:

When a tag is reported, the maximum RSSI value and Number of count seen are resetted so after using the List command to mark all tag has not reported, the get Tag command may return a list of tag with invalid Maximum RSSI value or count number.

Parameters 0x17 to 0x1A are used for compatibility with the iPort R2 reader.

These parameters should be used only if we do not need to know on which antenna a tag has been detected and if the parameters are identical on both antennas.

CAUTION:

If these parameters are used please DO NOT USE parameters 0x1B to 0x24 and vice-versa. The reader uses parameters above 0x1A, setting parameters 0x17 to 0x1A will also change corresponding parameters above 0x1A. If one of the parameters above 0x1A is changed, reading parameters 0x17 to 0x1A may return an invalid value.

Inhibit Time:

This parameter defines the maximum time the tag must not be detected by the reader before to be removed from the internal list.

A tag is removed only if it is marked as reported. If the tag was not marked as reported, it will stay in the list as long as it is not reported or removed from the list.

If List behavior is equal to 4 then the tag is removed from the list as soon as it is reported so this parameter has no effect.

Re-Report interval:

If a tag has been reported to a host with the GetTag commands, it will be reported only after the Re-report time interval and only if it has been detected again.

If List behavior is equal to 4 then the tag is removed from the list as soon as it is reported so this parameter has no effect.

RF Offset:

This offset is added to the tag RSSI value just after detection and before being processed by the reader.

This setting may be useful when the RF path loss from the reader to the antenna (included) is not identical on both antenna due to longer cable length or antenna with different gain.

4.9 Reader status information

The GetParameter Command (with parameter ID = 4) is identified as the GetStatus command. The get status command returns 32 bits, this table details the type of error each single bit indicates.

If a bit is set, it indicates the defined error occurred at least once since the last Getstatus command was sent. All status bits are cleared after reception of the Getstatus command. More than 1 bit can be set at the same time.

Status bit position	Definition	Description
0	CRC	CRC of telegram received is not valid
1	Host command	Unknown command
2	Internal version	This firmware is not a released version
3	Host timeout	Timeout receiving command from host
4	Escape DLE not used properly	Invalid escape sequence detected
5	Reserved	
6	Reserved	
7	Rebooted	The device has rebooted
8	EEPROM parameter CRC	Checksum over EEPROM parameters is invalid and reset to default values.
9	Watchdog reboot	Hardware or software failure
10	EEPROM calibration CRC	Checksum over EEPROM calibration/configuration is invalid and reset to default values. Please contact IDENTEC Solutions AG
11	Reserved	
12	Reserved	
13	Reserved	
14	Reserved	
15	Fallback Software	The device has 2 firmware images and the checksum over the last image fails so the device run the previous firmware
16	Supply voltage too low was detected once.	The voltage has been detected too low at least once since the last status query.
17	Current supply voltage too low.	Current voltage is too low.
18	Temperature out of range (too cold)	The temperature has been detected too cold (< -20°C) at least once since the last status query.
19	Temperature out of range (too hot)	The temperature has been detected too hot (> +80°C) at least once since the last status query.
30	Clock error	Quartz error.
31	I2C error	EEPROM error.

5.0 INSTALLATION- CONFIGURATION

This chapter provides some useful hints and procedures how the reader should be used under different operating modes

5.0 *Device enumeration*

On power-up the "To Slave" RJ45 port of the reader transparently transmits and receives data from and to the "To Master" RJ45 port. The device responds to either the broadcast address or the last static address assigned to the device.

Proposed enumeration algorithm on first time enumeration:

- a) Send connect slave port (parameter 0x10) to the broadcast address (n times for n readers)
- b) Send disconnect slave port to the broadcast address. Only the first reader with a disconnected slave port in the chain will respond to a command send to address 0xfe now.
- c) Read serial number, set unique static address for the reader with the disconnected slave port (address 0xfe).
- d) Read status (parameter 0x04) and check supply voltage (parameter 0x05).
- e) Connect slave port and return to step c) (n times for n readers)

At normal application start-up a new device enumeration is not necessary but the above scheme can be used to check for readers which might have been newly connected and which possibly have a static address which has already been assigned to another reader. It is recommended to check whether the combination of serial number and static address match for all readers.

5.1 *First time installation ("site setup")*

- Enumerate readers
- check that voltages are OK
- store corresponding serial numbers (parameter 0x01) and short address (parameter 0x11) on host
- Setup parameters for list behaviour and RF, additionally save these in host system.

Remarks:

- After initial setup the program on the host is not expected to do frequent changes of parameters marked as "permanent" in the table for the set parameter command.
- Apart from first time installation the application on the host application should not need to know about parameters like i.e. the RF sensitivity.

5.2 Normal initialization ("application on host starting up")

- Enumerate readers
- check that voltages are OK
- For each reader get serial number and compare to values stored on host.
- Report mismatch as error, if desired automatically redo first time initialization.

5.3 Normal operation ("host application loop after startup")

- The host application typically polls the readers for data (with the commands "Get Tags" or "Get Tags Extended").
- Besides processing these data the host application might routinely log or monitor the uptime of the readers (parameter 0x02) and the status (parameter 0x04) for error conditions (voltage, crc, timeout).

5.4 Error recovery

Tag data of broadcast tags is inherently acquired without handshake and thus might potentially be missed by RF detection.

The communication errors on the RS422 lines usually fall into the categories Timeout/Framing Error/CRC Error/lost character/unexpected characters received. Most probable causes for these are:

- supply voltage at the readers is too low
- dropped characters on host receive side
- cabling problems
- reader malfunction
- Changing reader configuration without knowing of the host application.

As the communication over the serial RS422 link is considered stable and the tag data has been acquired without handshake the protocol only foresees a retransmit for a single response telegram (firmware revision ≥ 0.4).

If the data telegrams of the reader are considered very valuable the host program is expected to use the "get tags extended" telegram which includes the time of first and last detection and a message counter.

On errors the complete data on the reader can be rescheduled for transmission and reprocessed. As error recovery code is always critical and seldom tested well, this ensures the recovery can be done using the same algorithm which would be needed for readers which have an intermittent connection to the host.

Connect up to 16 Readers per RS422 line. While the protocol supports more and the signal levels are refreshed by the daisy-chained readers this limit is imposed the skew between hi/lo and lo/hi transitions on the data lines. Please note the buffering schemes of the readers allow to significantly reduce the amount of the transmitted data but the accumulated data rate of events (like newly detected tags or tag re-reporting) should be lower than the net data rate on the RS422 line.

5.5 How to use inhibits time, re-report interval and list behavior.

When the list behaviour is set to 4 → remove tag when reported, the parameters inhibit time and re-report interval have no influence on the system.

See in the table below for some typical settings:

Application	Inhibit time (seconds)	Re-reporting time (seconds)	List behaviour	Uses get tags extended telegram	Remark
Gate application	60	0	0	no	Tag is reported once if it enters the reading range and reported again if it reenters after not having been detected for longer than the inhibit time value (60 seconds).
Area inventory	300	10	0	optional	Tag is reported if it enters the reading range. If it stays within the reading range it is reported again if 10 seconds have expired since the last reporting. A short re-reporting time is typical for applications which use the short "Get Tags" command.
Area inventory with low bandwidth to database	300	290	0	yes	Keeping a database with a time resolution of f.e. 300 seconds needs at least one message in the interval. So the re-reporting time is set slightly shorter than 300 seconds (sum of tag ping rate, message transfer latency, jitter of message transfer latency and of database query cycle jitter have to be accounted for). Use fields TimeFirst and TimeLast in the Get Tags extended Command telegram.
Tag control or test purpose	NA	NA	4	no	Allows getting each transmission of the tag to f.e. check for the ping rate. Typically this will be used in conjunction with a low sensitivity setting. Note: this mode causes the highest traffic on the bus. The parameters inhibit time and re-reporting time don't have an effect in this mode and are left at the default setting here.

5.6 Exchanging a reader within the daisy chain

- Stop the application program on the host
- exchange the reader
- Restart the application program on the host. If the application on the host checks on startup the readers serial numbers as recommended, it will detect the changed configuration and require either manual intervention or automatically configure the reader.

TECHNICAL SPECIFICATIONS

Technical Specifications

Read Range:	Up to 100m; adjustable
Operating Frequency:	868.3 MHz (EU), 915 Mhz (NA)
Number of Antennas:	2
Antenna Connection:	SMA
Transmission Security:	16 Bit CRC
Certification:	CE, EN 300220 (EU), FCC part15 (US)
Program Updates:	Via Host Computer Interface
Configuration Memory:	EEPROM
Read Buffer:	Up to 400 Tags
Host Interface:	RS 422; Daisy Chain
Baud Rate:	115 kBaud, fixed
Status Display:	5 LEDs
Power Source:	10 to 30V DC
Input Power:	< 0.5W
Operating Temperature:	-40°C to +80°C
Humidity:	up to 90% non-condensing
Maximum number of readers per daisy chain:	16
Maximum distance between any two readers:	300m
Maximum overall length of daisy chain (With GND free power supplies at the readers):	1000m
Case Material:	Plastic
Dimensions:	97 mm x 67 mm x 37 mm (157 mm x 67mm x 37 mm with end cap)
Mass:	150 g
Package Rating:	IP40, IP64 with plastic end cap.
Mounting:	Mounting kit with 2 mounting Holes M4

Maximum overall length of daisy chain / Cat5 cabling AWG24

Number of readers	Length / m	Remark
1	300	One 24V supply at host
2	600	One 24V supply at host
3	400	One 24V supply at host
4	250	One 24V supply at host
5	200	One 24V supply at host
10	100	One 24V supply at host
16	60	One 24V supply at host
16	1000	GND potential free power supplies at the readers

6.0 APPENDIX

7.1 Sample CRC calculation

The following sample code is provided 'as is'. IDENDEC SOLUTIONS does not guarantee compatibility with any interface or protocol except this used in the standard version of the i-PORT R2.

```

//! crc table for host communication
unsigned char code crc_tab_hi[256] =
{
    0x00, 0xc1, 0x81, 0x40, 0x01, 0xc0, 0x80, 0x41, //01
    0x01, 0xc0, 0x80, 0x41, 0x00, 0xc1, 0x81, 0x40, //02
    0x01, 0xc0, 0x80, 0x41, 0x00, 0xc1, 0x81, 0x40, //03
    0x00, 0xc1, 0x81, 0x40, 0x01, 0xc0, 0x80, 0x41, //04
    0x01, 0xc0, 0x80, 0x41, 0x00, 0xc1, 0x81, 0x40, //05
    0x00, 0xc1, 0x81, 0x40, 0x01, 0xc0, 0x80, 0x41, //06
    0x00, 0xc1, 0x81, 0x40, 0x01, 0xc0, 0x80, 0x41, //07
    0x01, 0xc0, 0x80, 0x41, 0x00, 0xc1, 0x81, 0x40, //08
    0x01, 0xc0, 0x80, 0x41, 0x00, 0xc1, 0x81, 0x40, //09
    0x00, 0xc1, 0x81, 0x40, 0x01, 0xc0, 0x80, 0x41, //10
    0x00, 0xc1, 0x81, 0x40, 0x01, 0xc0, 0x80, 0x41, //11
    0x01, 0xc0, 0x80, 0x41, 0x00, 0xc1, 0x81, 0x40, //12
    0x00, 0xc1, 0x81, 0x40, 0x01, 0xc0, 0x80, 0x41, //13
    0x01, 0xc0, 0x80, 0x41, 0x00, 0xc1, 0x81, 0x40, //14
    0x01, 0xc0, 0x80, 0x41, 0x00, 0xc1, 0x81, 0x40, //15
    0x00, 0xc1, 0x81, 0x40, 0x01, 0xc0, 0x80, 0x41, //16
    0x01, 0xc0, 0x80, 0x41, 0x00, 0xc1, 0x81, 0x40, //17
    0x00, 0xc1, 0x81, 0x40, 0x01, 0xc0, 0x80, 0x41, //18
    0x00, 0xc1, 0x81, 0x40, 0x01, 0xc0, 0x80, 0x41, //19
    0x01, 0xc0, 0x80, 0x41, 0x00, 0xc1, 0x81, 0x40, //20
    0x00, 0xc1, 0x81, 0x40, 0x01, 0xc0, 0x80, 0x41, //21
    0x01, 0xc0, 0x80, 0x41, 0x00, 0xc1, 0x81, 0x40, //22
    0x01, 0xc0, 0x80, 0x41, 0x00, 0xc1, 0x81, 0x40, //23
    0x00, 0xc1, 0x81, 0x40, 0x01, 0xc0, 0x80, 0x41, //24
    0x00, 0xc1, 0x81, 0x40, 0x01, 0xc0, 0x80, 0x41, //25
    0x01, 0xc0, 0x80, 0x41, 0x00, 0xc1, 0x81, 0x40, //26
    0x01, 0xc0, 0x80, 0x41, 0x00, 0xc1, 0x81, 0x40, //27
    0x00, 0xc1, 0x81, 0x40, 0x01, 0xc0, 0x80, 0x41, //28
    0x01, 0xc0, 0x80, 0x41, 0x00, 0xc1, 0x81, 0x40, //29
    0x00, 0xc1, 0x81, 0x40, 0x01, 0xc0, 0x80, 0x41, //30
    0x00, 0xc1, 0x81, 0x40, 0x01, 0xc0, 0x80, 0x41, //31
    0x01, 0xc0, 0x80, 0x41, 0x00, 0xc1, 0x81, 0x40 //32
};

//! crc table for host communication
unsigned char code crc_tab_lo[256] =
{
    0x00, 0xc0, 0xc1, 0x01, 0xc3, 0x03, 0x02, 0xc2, //01
    0xc6, 0x06, 0x07, 0xc7, 0x05, 0xc5, 0xc4, 0x04 //02
    0xc8, 0x0c, 0x0d, 0xcd, 0x0f, 0xcf, 0xce, 0x0e //03
    0x0a, 0xca, 0xcb, 0x0b, 0xc9, 0x09, 0x08, 0xc8 //04
    0xd8, 0x18, 0x19, 0xd9, 0x1b, 0xdb, 0xda, 0x1a //05
    0x1e, 0xde, 0xdf, 0x1f, 0xdd, 0x1d, 0x1c, 0xdc //06
    0x14, 0xd4, 0xd5, 0x15, 0xd7, 0x17, 0x16, 0xd6 //07
    0xd2, 0x12, 0x13, 0xd3, 0x11, 0xd1, 0xd0, 0x10 //08
    0xf0, 0x30, 0x31, 0xf1, 0x33, 0xf3, 0xf2, 0x32 //09
    0x36, 0xf6, 0xf7, 0x37, 0xf5, 0x35, 0x34, 0xf4 //10
    0x3c, 0xfc, 0xfd, 0x3d, 0xff, 0x3f, 0x3e, 0xfe //11
    0xfa, 0x3a, 0x3b, 0xfb, 0x39, 0xf9, 0xf8, 0x38 //12
    0x28, 0xe8, 0xe9, 0x29, 0xeb, 0x2b, 0x2a, 0xea //13
    0xee, 0x2e, 0x2f, 0xef, 0x2d, 0xed, 0xec, 0x2c //14
    0xe4, 0x24, 0x25, 0xe5, 0x27, 0xe7, 0xe6, 0x26 //15
    0x22, 0xe2, 0xe3, 0x23, 0xe1, 0x21, 0x20, 0xe0 //16
    0xa0, 0x60, 0x61, 0xa1, 0x63, 0xa3, 0xa2, 0x62 //17
    0x66, 0xa6, 0xa7, 0x67, 0xa5, 0x65, 0x64, 0xa4 //18
    0x6c, 0xac, 0xad, 0x6d, 0xaf, 0x6f, 0x6e, 0xae //19
    0xaa, 0x6a, 0x6b, 0xab, 0x69, 0xa9, 0xa8, 0x68 //20
    0x78, 0xb8, 0xb9, 0x79, 0xbb, 0x7b, 0x7a, 0xba //21
    0xbe, 0x7e, 0x7f, 0xbf, 0x7d, 0xbd, 0xbc, 0x7c //22
    0xb4, 0x74, 0x75, 0xb5, 0x77, 0xb7, 0xb6, 0x76 //23
    0x72, 0xb2, 0xb3, 0x73, 0xb1, 0x71, 0x70, 0xb0 //24
    0x50, 0x90, 0x91, 0x51, 0x93, 0x53, 0x52, 0x92 //25
    0x96, 0x56, 0x57, 0x97, 0x55, 0x95, 0x94, 0x54 //26
    0x9c, 0x5c, 0x5d, 0x9d, 0x5f, 0x9f, 0x9e, 0x5e //27
    0x5a, 0x9a, 0x9b, 0x5b, 0x99, 0x59, 0x58, 0x98 //28
};

```

```

0x88, 0x48, 0x49, 0x89, 0x4b, 0x8b, 0x8a, 0x4a, //29
0x4e, 0x8e, 0x8f, 0x4f, 0x8d, 0x4d, 0x4c, 0x8c, //30
0x44, 0x84, 0x85, 0x45, 0x87, 0x47, 0x46, 0x86, //31
0x82, 0x42, 0x43, 0x83, 0x41, 0x81, 0x80, 0x40, //32
};

//! CRC calculation for Host communication
unsigned int build_crc16(unsigned char *host_msg, unsigned int len)
{
    unsigned char crc_hi = 0xFF; // high CRC byte initialized
    unsigned char crc_lo = 0xFF; // low CRC byte initialized
    unsigned char index; // will index into CRC lookup table
    while (len--) // pass through message buffer
    { // and calculate the CRC
        index = crc_hi ^ *host_msg++;
        crc_hi = crc_lo ^ crc_tab_hi[index];
        crc_lo = crc_tab_lo[index];
    }
    return crc_lo<<8 | crc_hi;
}

```

Example commands with CRC

This example shows two commands sent to a reader.

Sending “disconnect slave port” to the broadcast address:

```
\x01\xff\x43\x10\x90\x00\x00\x00\x00\x3f\xdb\x04
```

Note, there is no response to this command as it is sent to the broadcast address. The character 0x10 has been translated into the sequence 0x10 0x90.

Sending “get parameter serial number” to the last reader in chain:

```
\x01\xfe\x44\x10\x81\xf0\xe2\x04
```

The character 0x01 has been translated into the sequence 0x10 0x81. The device responds with its serial number:

```
\x01\x11\xc4\x00\x18\x7f\x5d\xca\x3a\x85\x04
```