

iHome®

Model iH22
Dual Alarm Clock
for your iPod®

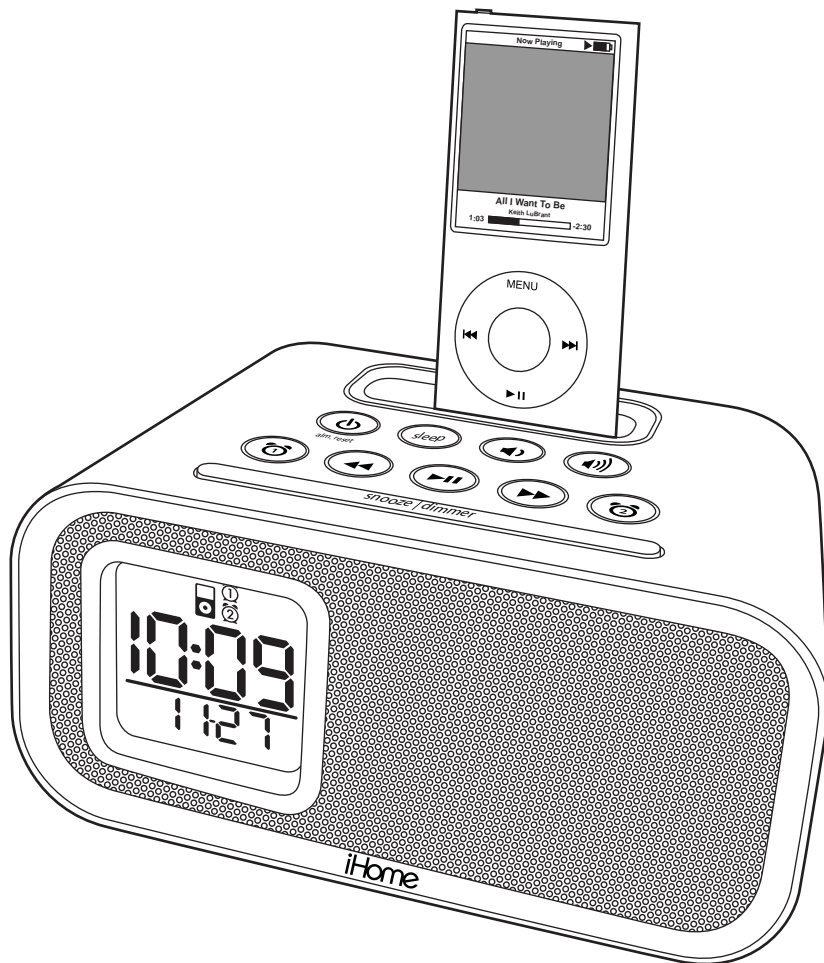



CAUTION
RISK OF ELECTRIC SHOCK.
DO NOT OPEN



CAUTION: TO REDUCE THE RISK OF ELECTRIC SHOCK, DO NOT REMOVE COVER (OR BACK). NO USER-SERVICEABLE PARTS INSIDE. REFER SERVICING TO QUALIFIED SERVICE PERSONNEL.

WARNING: TO REDUCE THE RISK OF FIRE OR ELECTRIC SHOCK, DO NOT EXPOSE THIS APPLIANCE TO RAIN OR MOISTURE.



The lightning flash with arrowhead symbol, within an equilateral triangle, is intended to alert the user of the presence of uninsulated “dangerous voltage” within the product’s enclosure that may be of sufficient magnitude to constitute a risk electric shock to persons.



The exclamation point within an equilateral triangle is intended to alert the user of the presence of important operating and maintenance (servicing) instructions in the literature accompanying the appliance.

The symbols above are located at the bottom of the cabinet.

CAUTION: To prevent electric shock, do not use this (Polarized) plug with an extension cord receptacle, or other outlets unless the blades can be fully inserted to prevent blade exposure.

ATTENTION: Pour prévenir les chocs électriques ne pas utiliser cette fiche polarisée avec un prolongateur. Une prise de courant, ou une autre sortie de courant sauf si les lames peuvent être insérées à fond sans en laisser aucune partie à découvert.

A Consumer Guide to Product Safety

- The apparatus shall not be exposed to dripping or splashing and that no objects filled with liquids, such as vases, shall be placed on apparatus.
L'appareil ne doit pas être exposé aux écoulements ou aux éclaboussures et aucun objet ne contenant de liquide, tel qu'un vase, ne doit être placé sur l'objet.
- Main plug is used as disconnect device and it should remain readily operable during intended use. In order to disconnect the apparatus from the mains completely, the mains plug should be disconnected from the mains socket outlet completely.
La prise du secteur ne doit pas être obstruée ou doit être facilement accessible pendant son utilisation. Pour être complètement déconnecté de l'alimentation d'entrée, la prise doit être débranchée du secteur.
- Battery shall not be exposed to excessive heat such as sunshine, fire or the like.
Les piles ne doivent pas être exposées à de forte chaleur, tel qu'à la lumière du soleil, au feu ou autres choses de semblable.
- Caution marking is located at the bottom of apparatus.
Les précautions d'emploi sont inscrites en bas de l'appareil.
- The marking information is located at the bottom of apparatus.
Les marquages sont inscrits en bas de l'appareil.

IMPORTANT SAFETY INSTRUCTIONS

This unit has been designed and manufactured to assure your personal safety. Improper use can result in potential electrical shock or fire hazards.

1. Read these Instructions.
2. Keep these Instructions.
3. Heed all Warnings.
4. Follow all instructions.
5. **Water and Moisture** - Do not use this apparatus near water. For example: near a bathtub, washbowl, kitchen sink, laundry tub, swimming pool or in a wet basement.
6. **Ventilation** - Do not block any of the ventilation openings. Install in accordance with the manufacturers instructions. For example, it should not be situated on a bed, sofa, rug or similar surface that may block ventilation openings. Also, it should not be placed in a built-in installation, such as a bookcase or cabinet that may impede the flow of air through the ventilation openings.
7. **Heat** - Do not install near any heat sources such as radiators, heat registers, stoves, or other apparatus (including amplifiers) that produce heat.
8. **Power Sources** - The unit should be connected to a power supply only of the type described in the operating instructions or as marked on the appliance.
9. **Grounding or Polarization** - Do not defeat the safety purpose of the polarized or grounding - type plug. A polarized plug has two blades with one wider than the other. A grounding type plug has two blades and a third grounding prong. The wide blade or the third prong are provided for your safety. When the provided plug does not fit into your outlet, consult an electrician for replacement of the obsolete outlet.
10. **Power-Cord Protection** - Protect the power cord from being walked on or pinched particularly at plugs, convenience receptacles, and the point where they exit from the apparatus. It is always best to have a clear area from where the cord exits the unit to where it is plugged into an AC outlet.
11. **Cleaning** - Unplug this product from the wall outlet before cleaning. Do not use liquid cleaners or aerosol cleaners. Clean only with a dry cloth.
12. **Non-Use Periods** - The power cord of the unit should be unplugged from the outlet when it is to be left unused for a long period of time.
13. **Objects and Liquid Entry** - Care should be taken so that objects do not fall and liquids are not spilled into the enclosure through openings.
14. **Attachments** - Only use attachments/accessories specified by the manufacturer.
15. **Lightning** - Unplug this apparatus during lightning storms or when unused for long periods of time.
16. **Overloading** - Do not overload wall outlets, extension cords, or integral convenience receptacles as this can result in a risk of fire or electric shock.
17. **Damage Require Service** - Refer all servicing to qualified service personnel. Servicing is required when the apparatus has been damaged in any way, such as power-supply cord or plug is damaged, liquid has been spilled or objects have fallen into the apparatus, the apparatus has been exposed to rain or moisture, does not operate normally, or has been dropped.
18. **Servicing** - The user should not attempt to service the unit beyond that described in the user's operating instructions. All other servicing should be referred to qualified service personnel.
19. **Safety Check** - Upon completion of any service or repairs to this product, ask the service technician to perform safety checks to determine that the product is in proper operating condition.
20. **Antenna** - Do not connect to an external antenna.

Table of Contents

Quick Start	1
Controls and Indicators	2
iH22 display / Install Clock Backup Battery / Install iPod Insert	3
Using the iH22	4-6
Trouble Shooting	7
Warranty Information	8

FCC Information

This device complies with Part 15 of the FCC Rules. Operation is subject to the following two conditions: (1) This device may not cause harmful interference, and (2) this device must accept any interference received, including interference that may cause undesired operation.

Warning: Changes or modifications to this unit not expressly approved by the party responsible for compliance could void the user's authority to operate the equipment.

NOTE: This equipment has been tested and found to comply with the limits for a Class B digital device, pursuant to Part 15 of the FCC Rules. These limits are designed to provide reasonable protection against harmful interference in a residential installation. This equipment generates, uses and can radiate radio frequency energy and, if not installed and used in accordance with the instructions, may cause harmful interference to radio communications. However, there is no guarantee that interference will not occur in a particular installation. If this equipment does cause harmful interference to radio or television reception, which can be determined by turning the equipment off and on, the user is encouraged to try to correct the interference by one or more of the following measures:

- Reorient or relocate the receiving antenna.
- Increase the separation between the equipment and receiver.
- Connect the equipment into an outlet on a circuit different from that to which the receiver is connected.
- Consult the dealer or an experienced radio/TV technician for help.

Maintenance

- Place the unit on a level surface away from sources of direct sunlight or excessive heat.
- Protect your furniture when placing your unit on a natural wood and lacquered finish. A cloth or other protective material should be placed between it and the furniture.
- Clean your unit with a soft cloth moistened only with mild soap and water. Stronger cleaning agents, such as Benzene, thinner or similar materials can damage the surface of the unit.

Quick start

1:power

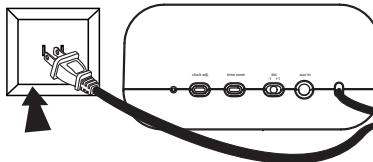

Plug the AC cord into a working wall socket.

2:inserts

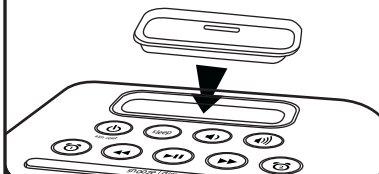

Select the dock insert for your iPod model from the table below and place insert in dock. Never dock an iPod without an insert in place.

3:iPod

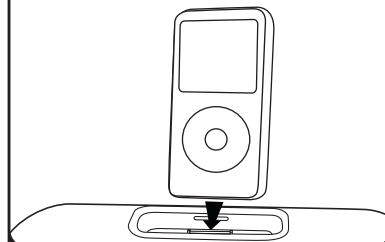

Insert an iPod into the dock with proper insert (iPod must not be in a skin or case). The iPod will charge while docked. Press the ►► Button on the iH22 to play your iPod.

4:time



- Press & hold the Time Zone button on back until the display flashes
- Press the ◀◀ or ▶▶ button to select your time zone
- Press the Time Zone button again.
- Move the DST switch on back of unit to +1 or -1 (adds or subtracts an hour)

Use this insert

thin iPod with video (30 GB)
Insert 9

iPod touch 2G
Insert 16

nano 5G
Insert 18

For this iPod

thin (30 GB) iPod with video
thin (80/120 GB) iPod classic

iPod touch 2G

nano 5G

NOTE: If you do not have an insert for your iPod, please visit www.ihomeaudio.com or call iHome toll free at 800-288-2792 to purchase one

Controls and Indicators

Top Panel

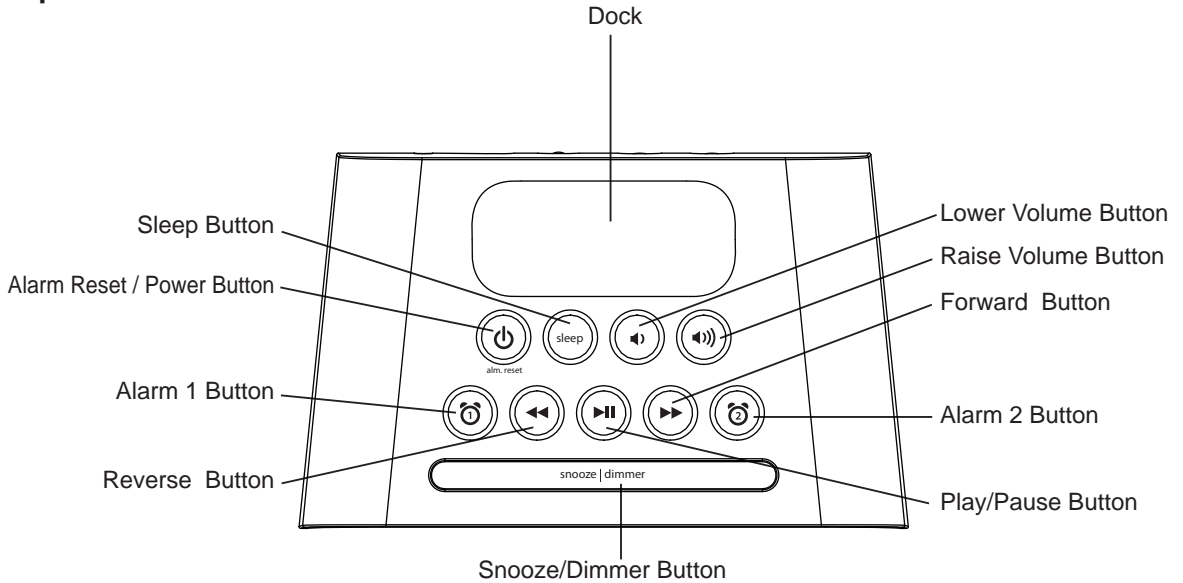

Rear Panel

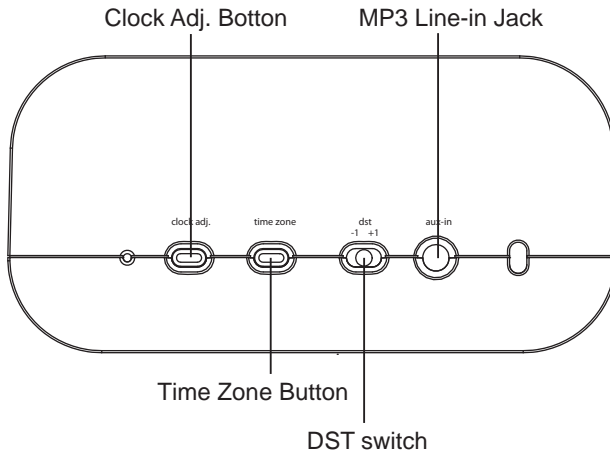

iH22 display



Installing Clock Backup Batteries

The iH22 uses 3 AAA batteries (installed) for backup to provide continuous alarm operation and clock settings in the event of a power failure. If the backup batteries have been installed and a power failure occurs or the AC cord is accidentally disconnected, the display backlight will not remain lit, but current time and alarm time settings will be temporarily maintained. Otherwise, you must reset the time and alarm settings.

Note: You should replace backup batteries when the **Battery Low Indicator** appears on the display.

1. Please make sure the AC cord is connected. Otherwise all settings may be lost during battery replacement.
2. Open backup battery compartment door located on the bottom of the unit.
3. Insert three "AAA" batteries, checking the + and - ends of the batteries. We recommend to use alkaline battery for longer life time. Do not mix alkaline, standard (carbon-zinc) or rechargeable (nickel-cadmium) batteries.
4. Close the compartment cover.

Note: Make sure you dispose of batteries properly (see your local regulations).

Battery Low Indicator

The **Battery Low Indicator** is located in the top of display. When it lights up it is time to replace backup batteries.

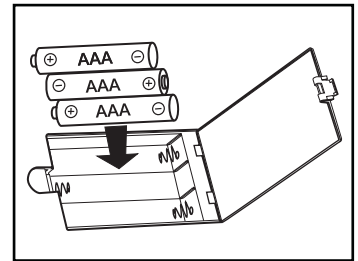

Installing iPod Insert

Your iH22 comes with 3 inserts to ensure your iPod fits properly in the dock on the top of the system. If the inserts that come with the unit do not match your iPod model, use the insert that came with your iPod or visit www.ihomeaudio.com or call 1-800-288-2792 toll free to purchase the proper insert for our iPod model.

To place an insert:

1. Select the insert for your iPod. Using the correct insert ensures the proper fit to your iPod.
2. Gently press the iPod insert into the dock.
3. Carefully place your iPod into the dock. The iPod must not be in a case or "skin".
4. To remove/replace an insert, first remove your iPod then press down the insert latch, grip the insert and pull gently upwards.

Using the iH22

This unit is a **PRESET Clock**: the time is already preset at the factory. Simply match the time zone setting to where you live.

1. Depending on your location and whether or not Daylight Saving Time (DST) is in effect, set the **DST Switch** located on the back of the unit to +1 to add an hour or to -1 to subtract an hour to/from the currently displayed time.
2. Press and hold the **Time Zone Button** located on the back of the unit until the current time zone flashes. Press the **◀** or **▶** **Button** to select your time zone.
3. Press the **Time Zone Button** again (or no button within 10 seconds) to exit the setting mode.
4. If time displayed is not correct, see Setting Time and Calendar to set the clock.

Setting Time and Calendar

1. Press and hold the **Clock Adjust Button** located on the back of the unit until the current time flashes on the display. Press the **◀** or **▶** **Button** to adjust to correct time (holding the button for few seconds will advance or reverse rapidly).
2. Remember to set the correct **AM** or **PM** time. The **PM Indicator** is located above the minute digits.
3. Press the **Clock Adjust Button** again to adjust year. Press the **◀** or **▶** **Button** until the current year is displayed.
4. Press the **Clock Adjust Button** again to adjust month and date. Press the **◀** or **▶** **Button** until the current month/date is displayed. Holding the button for a few seconds will advance or reverse rapidly.
5. Press the **Clock Adjust Button** again (or no button within 10 seconds) to exit the time/calendar setting mode. You will hear two beeps to confirm Time and Calendar setting are completed.

Using the Alarms

Setting the Alarms

1. By default, the unit selects iPod as your wake source. If no iPod is docked or detected, the iH22 will automatically default to buzzer alarm.
Note: make sure you have an hour of audio on your iPod.
2. Press and hold the **🕒 Button** until the current alarm time flashes in the lower part of the display. Press the **◀** or **▶** **Button** to set the alarm time. Remember to set the correct AM or PM time.
3. Press the **🕒 Button** (or if no button is pressed within 10 seconds). Two beeps will confirm alarm time and exit alarm setting mode. The alarm will be armed and the corresponding alarm icon will appear.
4. To set Alarm 2 just follow steps 2 - 3 using the **🕒 Button**.

Reviewing, Arming and Disarming Alarm (Turn Alarm Function On and Off)

1. Once an alarm is set, it is armed and the lower part of the display will show the alarm time. If both alarms are armed, the earliest alarm time will show.
2. To arm/disarm the alarm, just press the associated alarm button to toggle it on or off. If the alarm is armed, the related alarm icon will appear in the upper part of the display.

Resetting the Alarm to Come on the Next Day

1. When the alarm is sounding, press the **🕒 Button** to stop alarm and reset it to come on the following day.

Snooze Operation

1. Press and hold the **Snooze/Dimmer Button** for a few seconds to set snooze time. Press the **◀◀** or **▶▶** **Button** to set the snooze timer from 1 to 30 minutes.
2. Press the **Snooze/Dimmer Button** after the alarm sounds. The alarm will be silenced and come on again after the set snooze time. Snooze can be pressed several times during the 1 hour alarm cycle.

Sure Alarm





The iH22 has a sure alarm feature. If backup batteries are installed, the buzzer alarm will still sound in the event of power failure.

Charging your iPod

Note: Please make sure you are using the correct insert for your iPod (see Installing iPod Insert) and that the iPod is properly docked into the iH22. Failure to do so may damage your iPod.





1. While your iPod is docked in the unit and the unit is connected to AC power, it recharges (until fully charged). Backup batteries will NOT charge iPod. Note that non-docking iPod models will NOT charge.

Listening to your iPod

1. Dock your already playing iPod. The iH22 will automatically turn on and you will hear the music playing from your iPod.
Note: If the volume on the playing track is too low, iH22 may not detect that your iPod is in play mode. If this happens, press the **▶▶** **Button** on the main unit to play it.
2. When the iPod is docked and in standby mode, press the **▶▶** **Button** on the iH22 to play it. The  will appear on the display, indicating iPod play mode.
3. Press the **▶▶** **Button** again to pause play; press again to resume it.
4. Press the **Volume**  and **Volume**  **Button** to adjust the system volume.
5. Press the **◀◀** or **▶▶** **Button** on the unit to go to the next or previous track. Press and hold while a track is playing for high speed forward or reverse music search of the current track.
6. To turn off the unit, press the  **Button**. The iPod will continue charging while in the dock.

Listening to non-docking iPod or other portable audio devices

If you are using an iPod without a docking port or another MP3 player or portable audio device, you can play it through the iH22 via the MP3 Line-in Jack located on the back of the unit.

1. Plug one end of an audio patch cord (available at www.ihomeaudio.com) into the headphone or line-out jack on your device and the other end of the patch cord into the iH22 MP3 Line-in Jack.
2. Press the  **Button** to turn the iH22 on.
3. Turn on and play your device.
4. Press the **Volume**  and **Volume**  **Button** to adjust the system volume. You may need to adjust your device volume, too.
5. To turn off the unit, press the  **Button**. Please remember to turn off your device, too.

Sleep Operation

Sleep mode lets you sleep to your iPod until the unit shuts off at a selected time.

1. Press the **Sleep Button** to enter sleep mode. The Sleep Icon will appear on the display to indicate it is in sleep mode.
2. Press the **Sleep Button** as needed to adjust the sleep timer from 90, 60, 30 or 15 minutes (or turn sleep off).
3. When the display changes back to show the real time, press the **Sleep Button** once to show the sleep time remaining. Pressing it again to change sleep time to the next lowest increment.
4. To stop listening at any time, press the **⏻ Button** to turn unit off.

Dimmer Operation

During normal operation, press the **Snooze/Dimmer Button** to control the brightness of the LCD display.

Trouble Shooting

Symptom	Possible Problem	Solution
Unit doesn't respond (no power)	Wall outlet is not functioning	Plug another device into the same outlet to confirm the outlet is working
iPod does not dock properly	Using no or wrong iPod insert	Make sure the dock insert is the proper one for your iPod
	Dock or connector is obstructed	Remove your iPod from the dock and check for obstruction on the connectors in the dock and on your iPod. Then reseal it in the dock.
iPod does not respond to the unit	iPod is not docked properly	Remove your iPod from the dock and check for obstruction on the connectors in the dock and on your iPod. Then reseal it in the dock.
	Your iPod software is too old	Upgrade software on your iPod via iTunes
	iPod is locked up	Please refer to your iPod manual for details. Please make sure your iPod is working properly before docking in the unit.
iPod doesn't charge up	iPod is not docked properly	Remove your iPod from the dock and check for obstruction on the connectors in the dock and on your iPod. Then reseal it in the dock.
	Using 3rd generation iPod	iH22 doesn't support 3rd generation iPod
	iPod is locked up/frozen	Please refer to your iPod manual for details. Please make sure your iPod is working properly before dock into the unit.
	iPod battery has problem	
Sound is distorted	Volume level is set too high	Decrease the volume.
	Sound source is distorted	If iPod original sound source is poor quality, distortion and noise are easily noticed with high-power speakers. Try a different audio source such as a music CD.
		If you are using an iPod Shuffle or external sound source like older generation iPod, try reducing the output volume on the device itself. Also, try reducing bass.

Limited 90-Day Warranty Information

iHome Products, a division of SDI Technologies Inc. (hereafter referred to as SDI Technologies), warrants this product to be free from defects in workmanship and materials, under normal use and conditions, for a period of 90 days from the date of original purchase.

Should this product fail to function in a satisfactory manner, it is best to first return it to the store where it was originally purchased. Should this fail to resolve the matter and service still be required by reason of any defect or malfunction during the warranty period, SDI Technologies will repair or, at its discretion, replace this product without charge (except for a \$10.00 charge for handling, packing, return UPS/postage, and insurance). This decision is subject to verification of the defect or malfunction upon delivery of this product to the Factory Service Center listed below. The product must include proof of purchase, including date of purchase. The fee for service without proof of purchase is \$35.00.

Before returning this product for service, please first replace the batteries (if applicable) with fresh ones, as exhausted or defective batteries are the most common cause of problems encountered.

If service is still required:

1. Remove the batteries (if applicable) and pack the unit in a well padded, heavy corrugated box.
2. Enclose a photocopy of your sales receipt, credit card statement, or other proof of the date of purchase, if within the warranty period.
3. Enclose a check or money order payable to the order of SDI Technologies, for the sum of \$10.00 (\$35.00 without proof of purchase).
4. Send the unit prepaid and insured, to the Factory Service Center listed below.

Consumer Repair Department

*SDI Technologies Inc.
1330 Goodyear Drive
El Paso, TX 79936-6420*

Disclaimer of Warranty

NOTE: This warranty is valid only if the product is used for the purpose for which it was designed. It does not cover (i) products which have been damaged by negligence or willful actions, misuse or accident, or which have been modified or repaired by unauthorized persons; (ii) cracked or broken cabinets, or units damaged by excessive heat; (iii) damage to digital media players, CD's or tape cassettes (if applicable); (iv) the cost of shipping this product to the Factory Service Center and its return to the owner.

This warranty is valid only in the United States of America and does not extend to owners of the product other than to the original purchaser. In no event will SDI Technologies or any of its affiliates, contractors, resellers, their officers, directors, shareholders, members or agents be liable to you or any third party for any consequential or incidental damages, any lost profits, actual, exemplary or punitive damages. (Some states do not allow limitations on implied warranties or exclusion of consequential damages, so these restrictions may not apply to you.) This warranty gives you specific legal rights, and you may also have other rights which vary from state to state.

Your acknowledgement and agreement to fully and completely abide by the above mentioned disclaimer of warranty is contractually binding to you upon your transfer of currency (money order, cashier's check, or credit card) for purchase of your SDI Technologies product.

© 2009 SDI Technologies, Inc. All rights reserved

**Questions? Visit www.ihomeaudio.com
or call 1-800-288-2792 Toll Free**