

EFFEKTIV

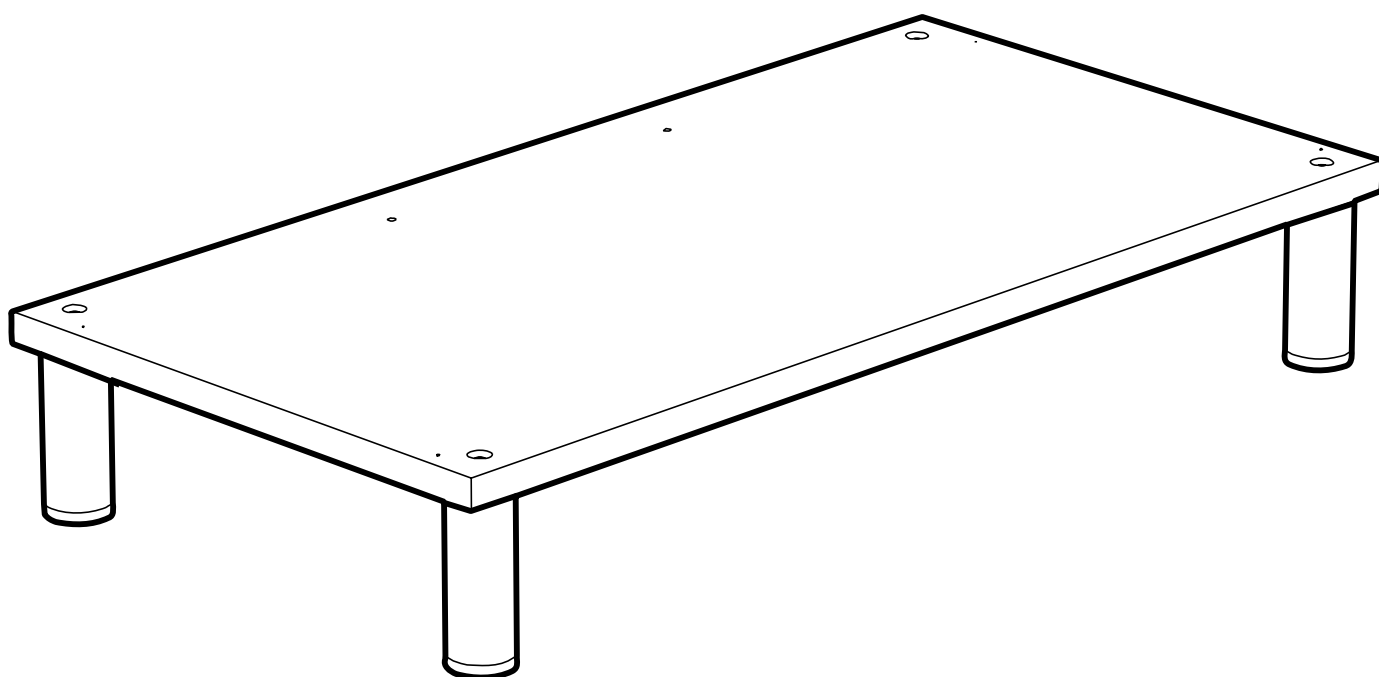

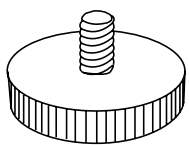
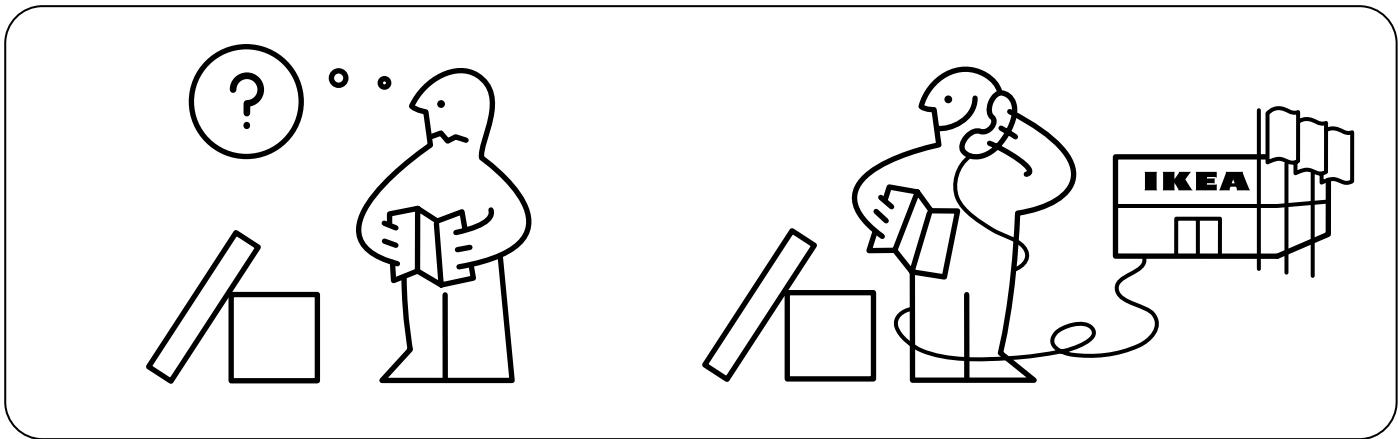
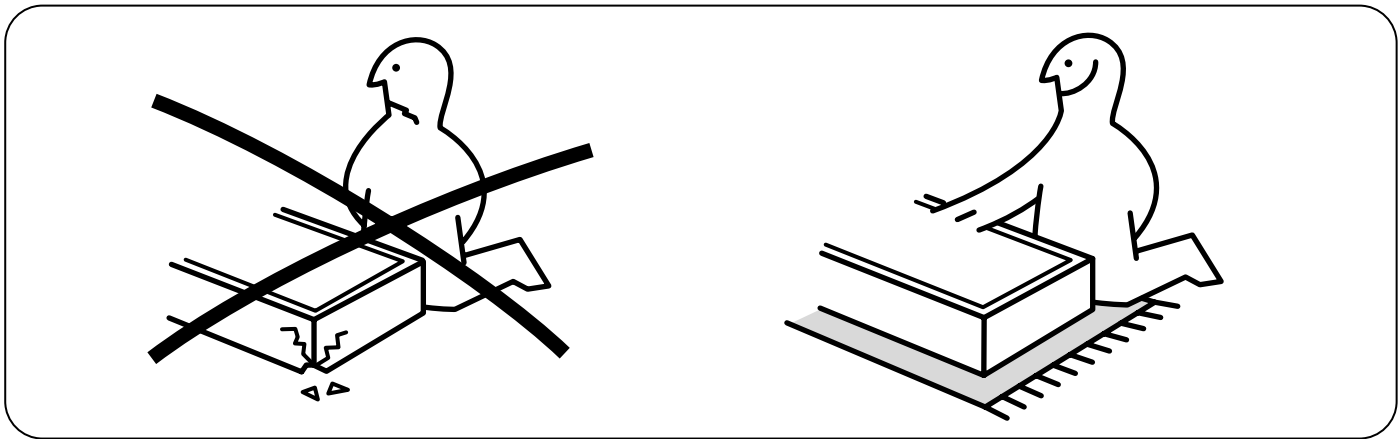
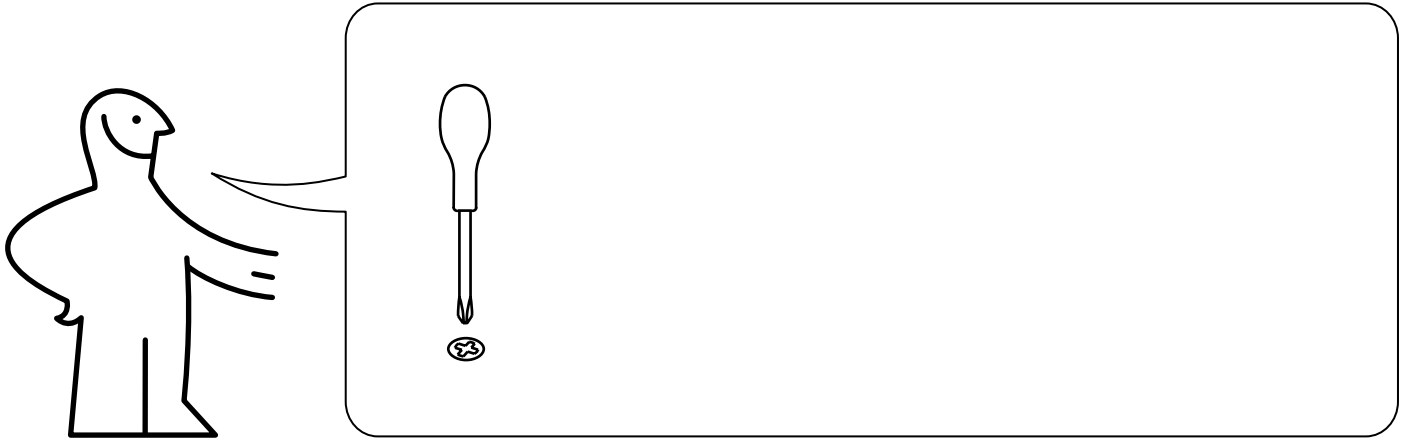

112762

4x

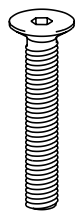

110004

4x



100707

2x

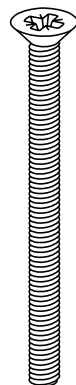

112993

2x

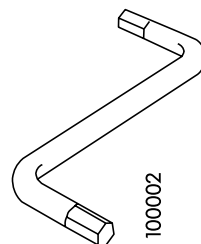

100002

1x

