

# FRAMTID

GB

OV9



Design and Quality  
IKEA of Sweden





## Contents

Safety information	4	What to do if...	13
Product description	5	Technical data	13
Before first use	6	Installation	14
Daily use	6	Electrical connection	14
Cooking tables	10	Environment concerns	15
Care and cleaning	10	IKEA GUARANTEE	15

Subject to change without notice

## Safety information

**i** For your safety and correct operation of the appliance, read this manual carefully before installation and use. Always keep these instructions with the appliance even if you move or sell it. Users must fully know the operation and safety features of the appliance.

### Correct use

- Do not leave the appliance unattended during operation.
- The appliance is designed exclusively for domestic use.
- The appliance must not be used as a work surface or as a storage surface.
- Do not place or store flammable liquids, highly inflammable materials or fusible objects (e.g. plastic film, plastic, aluminium) in or near the appliance.
- Watch out when connecting electric appliances to sockets nearby. Do not allow connecting leads to come into contact with or to catch beneath the hot oven door.
- Do not keep moist dishes and food in the oven after finishing the cooking as the moist can damage the enamel or get into the units.
- Do not do repairs yourself to prevent injury and damage to the appliance. Always contact your local Service Centre.
- Do not use harsh abrasive or sharp metal scrapers to clean the oven door glass since they can scratch the surface, which may result in shattering of the glass.

### **i** Note on enamel coating

Changes in the colour of the oven enamel coating as a result of use do not affect the appliance suitability for normal and correct use. They therefore do not constitute a defect in the sense of the warranty law.

### Child safety

- Only adults can use this appliance. Children must get supervision to make sure that they do not play with the appliance.
- Keep all packaging away from children. There is a risk of suffocation.
- Keep children away from the appliance when the door is open.

### General safety

- This appliance is not intended for use by persons (including children) with reduced physical, sensory or mental capabilities, or lack of experience and knowledge, unless they have been given supervision or instruction concerning use of the appliance by a person responsible for their safety.
- Risk of burns! The interior of the oven becomes hot during use.
- Always stand back from the appliance when opening the oven door during cooking or at the end of it to allow any build up of steam or heat to release.

### Installation

- Make sure that the appliance is not damaged because of transport. Do not connect a damaged appliance. If necessary, contact the supplier.

- Only an authorised service engineer can repair this appliance. Use only original spare parts.
- Built-in appliances can only be used after they are built-in to suitable built-in units and work surfaces that meet standards.
- Do not change the specifications or modify this product. Risk of injury and damage to the appliance.

**⚠ Warning!** Carefully obey the instructions for electrical connections.

### Oven lamp

- Bulb lamps used in this appliance are special lamps selected for household appliances use only. They cannot be used for the full or partial illumination of a household room.

- If it becomes necessary to replace the lamp use one of the same power and specifically designed for household appliances only.

### Information on acrylamides

**Important!** According to the latest scientific knowledge, intensive browning of food, especially in products containing starch, can constitute a health risk due to acrylamides. Therefore, we recommend cooking at the lowest possible temperatures and not browning foods too much.

## Product description

### General overview

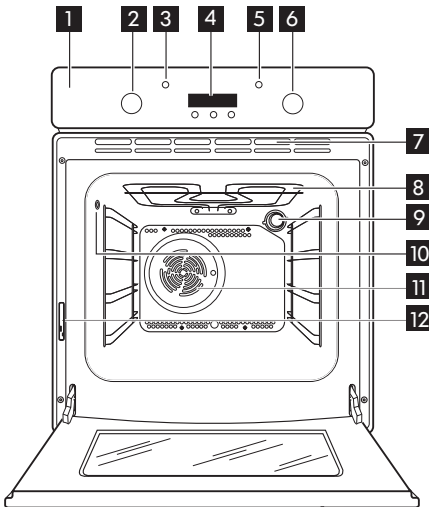

- 1 Control panel
- 2 Temperature control knob
- 3 Temperature indicator
- 4 Display
- 5 Power indicator
- 6 Control knob for oven function
- 7 Air vents for cooling fan
- 8 Grill
- 9 Oven lamp
- 10 Meat probe socket
- 11 Fan
- 12 Rating plate

**Oven accessories**

Dripping pan

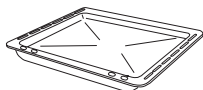

1x

Baking tray

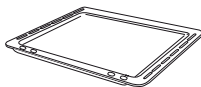

1x

Grid

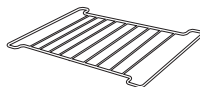

1x

Meat probe

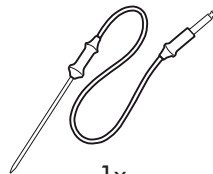

1x

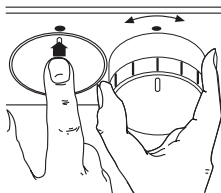
**Push-pull control knobs**

The oven is provided with push-pull control knobs. You can sink the push-pull control knobs inside the control panel when the oven is off.

Turn the push-pull control knobs clockwise to set the temperature and the oven function.

**Before first use**

**i** Remove all packaging, both inside and outside the oven, before using the appliance. Do not remove the rating plate.

When you connect the appliance to the electrical supply or in case of a power cut, the Time function indicator flashes automatically. To set the current time use "+" or "-" button. After approx. 5 seconds the flashing stops and the clock displays the time of the day set.

If the time of the day is not set the appliance does not work.

**Initial cleaning**

Clean the appliance before first use. Clean the accessories and the oven interior with a soft cloth with warm water and soap.

After that preheat the oven up without food.

**Preheating**

Turn the oven function control knob to  and run the oven for 45 minutes at maximum temperature, to burn off any residue from the cavity surface. Accessories can become hotter than in normal use. During this period an odour can be emitted. This is normal. Make sure the room is well ventilated.

**Daily use****Switching the appliance on**

Set the oven function and the temperature.

**Setting the oven function**

Turn the control knob for oven functions (refer to "Product description").











**Setting the temperature**

Turn the temperature control knob (refer to "Product description"). You can set the temperature between 50 °C and 250 °C.

**Switching the appliance off**

Turn the temperature and oven functions control knobs to the off position.

**Oven functions**

Oven function	Application
	OFF position
	Oven lamp - lights up without any cooking function.
	Conventional cooking - heats both from the top and bottom element. To bake and roast on one oven level.
	Top heating element - heats only from the top of the oven. To finish cooked dishes.
	Bottom heating element - heats only from the bottom of the oven. To bake cakes with crispy or crusty bases.
	Grill - to grill flat food items in small quantities in the middle of the shelf. To make toasts.
	Full grill - the full grill element is on. To grill flat food items in large quantities. To make toasts.
	Thermal grilling - the grill element and the oven fan operate together and circulate hot air around the food. To cook large pieces of meat.
	Fan cooking - to roast or roast and bake the food that requires the same cooking temperature, using more than one shelf, without flavour transfer.
	Defrost - thaws frozen food. The temperature control knob must be on off position.
	Pizza - the bottom element provides direct heat to the base of pizzas, quiches or pies, while the fan ensures air is circulated to cook the pizza toppings or pie fillings.

**Power indicator**

The power indicator (refer to "Product description") comes on when the control knob for oven function is set.

**Temperature indicator**

The temperature indicator (refer to "Product description") comes on when the oven heats up. It goes off when the oven reaches the correct temperature. It then cycles on and off to show the temperature adjusts.

**Safety thermostat**

To prevent dangerous overheating (through incorrect use of the appliance or defective components), the oven is fitted with a safety thermostat, which interrupts the power supply. The oven switches back on again automatically, when the temperature drops. Should the safety thermostat fail to work, do not attempt to fix it yourself. Please contact After Sales Service.

**The cooling fan**

The cooling fan (not visible) keeps the front panel, the knobs and the oven door handle cool. When the oven is on the cooling fan switches on automatically. Warm air blows out through the air vents near the oven door handle. To keep the controls cool, the cooling fan can still run after the oven is off.

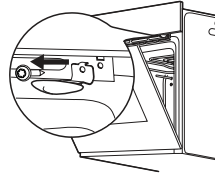

To remove the child lock open the oven door and unscrew it using the torx key included in the oven fitting bag.

**Mechanical child lock**

The appliance is delivered with fixed and activated child lock. It is situated just below the oven control panel on the right side.

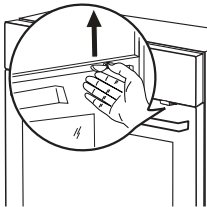

To open the oven door with the child lock inserted, pull the child lock handle up as shown in the picture. Close the oven door without pulling the child lock.

**Clock functions**

Symbol	Function	Description
→	Cooking duration	To set how long the oven is to be in use
→	End of cooking	To set when the oven is to switch off
→  →	Cooking duration and End of cooking combined	To set delayed start of the appliance
🔔	Minute minder	To set a countdown. A signal sounds when the time elapses
🕒	Clock	To set the time of the day
🍖	Meat probe	Measures the core temperature while roasting larger pieces of meat



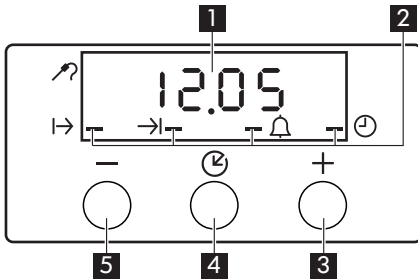

- 1** Time and meatprobe temperature display
- 2** Function indicators
- 3** Button "+"
- 4** Selector button (↻)
- 5** Button "-"

### Setting the clock functions

- Push selector button (↻) again and again until the desired function indicator flashes.
- To set or modify the time use "+" / "-" in the next 5 seconds. After that the set time begins to run.

### Cancelling the clock function

Push selector button (↻) again and again until the function indicator shows the right function and push "-" button. After few seconds the clock function goes out.

### Meat probe 🔪

Meat probe measures the core temperature of the meat. When the meat reaches set temperature the oven switches off automatically.

**i** It is kindly suggested to use only the recommended meat probe for this appliance.

**⚠ Warning!** The meat probe is hot! Risk of burns! Be careful when you remove the tip and plug of the meat probe.

1. Insert the meat probe plug into the socket in the side wall of the oven.
2. Insert the meat probe point in the middle of the meat, as far as it goes.
3. Push selector button (↻) again and again until Meat probe indicator 🔪 flashes.

4. Use "+" / "-" buttons to set the desired core temperature. You can set the temperature from 30 °C to 99 °C. Refer to suggested values in the table.
5. Use control knobs to set the desired oven cooking function and temperature.
6. When the meat reaches set core temperature, the oven switches off automatically.
7. Remove the meat probe.

Suggested core temperatures	
50 °C	Rare
60 °C	Medium
70 °C	Well done

In case the level of cooking is not satisfactory do above steps once again and set higher core temperature.

### Switching off the display

**i** You can save energy by switching off the clock display.

1. Push "+" and "-" buttons at the same time and hold for 5 seconds. The display switches off.
2. To switch on the display push any button.

## Cooking tables

Weight (kg)	Food	Oven Function	Level	Oven temperature (°C)	Cooking Time (min)
1	Pork / lamb		2	180	100-110
1	Veal / Beef		2	190	70-100
1,2	Chicken/Rabbit		2	200	70-80
1,5	Duck		1	160	120-150
3	Goose		1	160	150-200
4	Turkey		1	180	210-240
1	Fish		2	190	30-40
1	Stuffed Pepperoni Tomatos/Roasted Potatos		2	190	50-70
	Instant cakes		2	160	45-55
1	Pies		2	160	80-100
	Biscuits		3	140	25-35
2	Lasagne		2	180	45-60
1	White Bread		2	190	50-60
1	Pizza		1	190	25-35

**⚠ Warning!** Do not line the oven with aluminium foil and do not place a roasting pan or baking tray on the floor. Build-up heat can damage the oven enamel.

**⚠ Warning!** Always cook with the oven door closed, even while grilling. Be

careful when opening the drop down oven door. Do not allow it to fall open - support the door using the door handle, until it is fully open.

## Care and cleaning

**⚠ Warning!** Switch the appliance off and let it cool down before you clean it.

**⚠ Warning!** For safety reasons, do not clean the appliance with steam blasters or high-pressure cleaners.

**⚠ Warning!** Keep the appliance clean at all times. A build-up of fats or other foodstuffs can cause a fire, especially in the dripping pan.

### Outside of the appliance

- Clean the front of the appliance with a soft cloth and warm water with soap.
- For metal fronts, use normal cleaning agents.
- Do not use scouring agents and abrasive sponges.

### Oven interior

- Turn the oven lamp on before cleaning.

- Clean the oven with a soft cloth with warm water and soap and leave it to dry .

**Accessories**

Clean all slide-in units with a soft cloth with warm water and soap (shelf, baking tray, shelf support rails etc.) after each use and dry well. Soak briefly to make them easier to clean.

**Cleaning the oven door**

The oven door has two panels of glass installed one behind the other. To make the cleaning easier remove the oven door and the internal panel of glass.

**⚠ Warning!** The oven door can close if you try to remove the internal panel of glass when the door is still assembled.

**Removing the oven door and the glass panel**

1

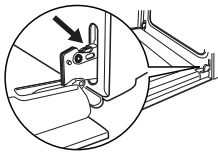

Open the door fully and hold the two door hinges .

2

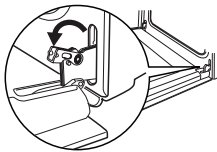

Lift and turn the levers on the two hinges.

3

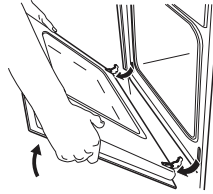

Close the oven door to the first opening position (approx. 45°). Then pull forward and remove it from its seat.

4

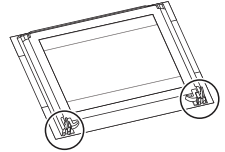

Place the door on a stable surface protected by a soft cloth.

5

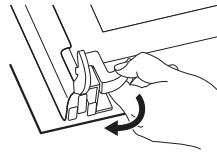

Release the locking system to remove the internal panel of glass.

6



7

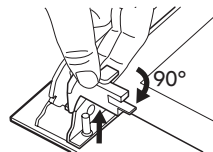

Turn 2 fasteners by 90° and remove them from their seats.

8

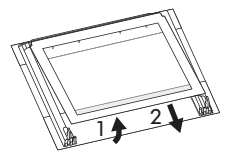

Carefully lift and remove the panel of glass.

Clean the glass panel with water and soap. Dry it carefully.

**Inserting the door and the glass panel**

When the cleaning procedure is completed, insert the glass panel and the oven door. To do so, follow the steps in reverse.

The inner glass panel must be assembled keeping the decorative frame (screen-printing) turned towards outside of the oven. To double check you did the above operation in a proper way simply pass your fingers on the inner glass surface. If the panel of glass is assembled correctly you should not feel any roughness.

Insert the internal panel of glass into the right seats as shown below.

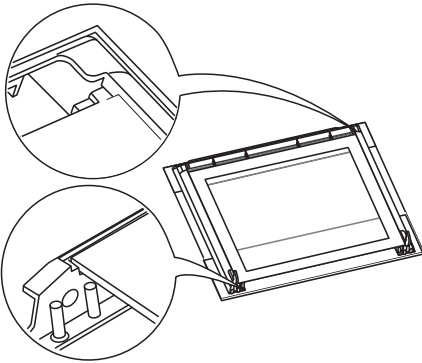

**Side rails**

To clean the side walls of the oven cavity, remove the side rails.

1

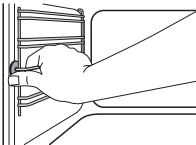

Pull the rails away from the oven wall at the front.

2

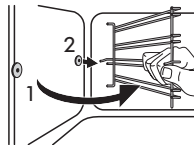

Then unhook the rails at the back.

To put the side rails back, follow the instruction in reverse.

**Important!** The rounded ends of the guide bars must point to the front.

**Changing the oven lamp and cleaning the glass cover**

**Warning!** Before you change the oven lamp (refer to "Product description"), switch off the appliance and disconnect it from the electrical supply.

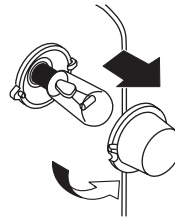

1. Turn the glass cover anti - clockwise and remove it. Clean the glass cover.
2. If necessary, replace the old oven lamp with a 15/25 watt, 230V (50Hz), 300 °C heat resistant oven lamp (Connection type: E14).
3. Refit the glass cover.

### What to do if...

Problem	Possible cause	Solution
The oven does not operate	The required setting have not been set	check if cooking function and temperature are selected
The oven does not operate	The appliance is not correctly connected or/and the mains supply to the oven is not on	Check if the appliance is correctly connected and the mains supply to the oven is on
The temperature indicator does not come on	The required setting have not been set	Select the cooking function and temperature
The oven lamp is not working	The oven lamp bulb is faulty	Replace the oven lamp bulb
Steam and condensation settle on the food and in the oven cavity	Dishes have been left in the oven for too long	Do not leave the dishes standing in the oven for longer than 15-20 minutes after the cooking process ends
"12.00" appears on the display and the clock LED is flashing	Interruption of the power supply.	Reset the time
F11 appears on the display	The plug of the meat probe is not firmly in position in the socket	Insert the meat probe plug into the socket in the side wall of the oven as far as it can go

If there is a fault, first try to find a solution to the problem yourself. If you cannot find a solution to the problem yourself, contact your dealer or the After Sales Service.

**i** If you operated the appliance wrongly, or the installation was not carried out by a registered engineer, the visit from the After Sales Service technician or dealer may not take place free of charge, even during the warranty period.

### Technical data

Dimensions (internal)	Width Height Depth	395 335 400
Usable volumes	53 l	
Area of largest baking sheet (net surface)	1130 cm <sup>2</sup>	
Bottom heating element	1000 W	
Top heating element	800 W	
Full oven (Top + Bottom)	1800 W	
Grill	1650 W	

Full grill	2450 W
Thermal grill	2450 W
Fan cooking	2025 W
Pizza	2675 W
Oven lamp	25 W
Cooling fan	25 W
Hot air fan motor	25 W
Total rating <sup>1)</sup>	2700 W
Number of functions	9
Energy consumption	0,78 kWh
Energy Consumption with a standard load and bottom heating	0,79 kWh
Energy Consumption with a standard load forced air oven	0,78 kWh

<sup>1)</sup> Information on the electrical connection, voltage and overall power is given on the rating plate (refer to "Product description").

## Installation

**⚠ Caution!** Refer to the assembly instructions for the installation.

**⚠ Warning!** Only a qualified and competent person must do the installation of the appliance. If you do not contact qualified or competent person, the guarantee becomes invalid if there is damage.

- Before you built in the appliance to the kitchen cabinet make sure that the recess dimensions are suitable.
- Make sure that there is anti-shock protection for the installation.

- According to the regulations of force, all parts which ensure the anti-shock protection must be fixed in such a way that they cannot be undone without tools.
- The appliance can be placed with its back and one side close to the higher appliances or walls. The other side must be placed close to the furniture with the same height.
- The built-in unit must meet the stability requirements of DIN 68930.
- Built-in ovens and built-in cooking surfaces are fitted with special connection systems. For safety reasons, you must only combine appliances from the same manufacturer.

## Electrical connection

**⚠ Warning!** Only a qualified electrician and competent person must do the electrical installation.

- The manufacturer is not responsible if you do not follow these safety precautions.
- Ground the appliance according to safety precautions.

- Make sure that the rated voltage and type of power on the rating plate agree with the voltage and the power of the local power supply.
- This appliance is supplied with a mains cable without plug.
- The yellow-green earth wire should be 2-3 cm longer than all other cables.

- Any electrical component must be installed or replaced by the After Sales Service technician or qualified service personnel.
- Always use a correctly installed shockproof socket.
- Do not use multi-way plugs, connectors and extension cables. There is a risk of fire.
- Make sure that the mains plug is accessible after installation.
- Do not pull the mains cable to disconnect the appliance. Always pull the mains plug.
- Connect the appliance to the mains using a device that allows to disconnect the appliance from the mains at all poles with a contact opening width of at least 3 mm, eg. automatic line protecting cut-out, earth leakage trips or fuse.



This appliance complies with the E.E.C. Directives.

## Environment concerns

The symbol  on the product or on its packaging indicates that this product may not be treated as household waste. Instead it should be taken to the appropriate collection point for the recycling of electrical and electronic equipment. By ensuring this product is disposed of correctly, you will help prevent potential negative consequences for the environment and human health, which could otherwise be caused by inappropriate waste handling of this product. For more detailed information about recycling of this product, please contact your local council, your household waste disposal service or the shop where you purchased the product.

### Packaging materials

The materials with the symbol  are recyclable. Dispose the packaging in a suitable collection containers to recycle it.

### Before disposal of appliance

 **Warning!** Do these steps to dispose the appliance:

- Pull the mains plug out of the mains socket.
- Cut off the mains cable and discard it.
- Discard the door catch. This prevents the children to close themselves inside the appliance. Risk of suffocation.

## IKEA GUARANTEE

### How long is the IKEA guarantee valid?

This guarantee is valid for five (5) years from the original date of purchase of Your appliance at IKEA, unless the appliance is named LAGAN in which case two (2) years of guarantee apply. The original sales receipt is required as proof of purchase. If service work is carried out under guarantee, this will not extend the guarantee period for the appliance,

### Which appliances are not covered by the IKEA five (5) years guarantee?

The range of appliances named LAGAN and all appliances purchased in IKEA before 1st of August 2007

### Who will execute the service?

IKEA service provider will provide the service through its own service operations or authorized service partner network.

### What does this guarantee cover?

The guarantee covers faults of the appliance, which have been caused by faulty construction or material faults from the date of purchase from IKEA. This guarantee applies to domestic use only. The exceptions are specified under the headline "What is not covered under this guarantee?" Within the guarantee period, the costs to remedy the fault e.g. repairs, parts, labour and travel will be covered, provided that the appliance is accessible for repair without special expenditure. On these conditions the EU guidelines (Nr. 99/44/EG) and the respective local regulations are applicable. Replaced parts become the property of IKEA.

### What will IKEA do to correct the problem?

IKEA appointed service provider will examine the product and decide, at its sole discretion, if it is covered under this guarantee. If considered covered, IKEA service provider or its authorized service partner through its own service operations, will then, at its sole discretion, either repair the defective product or replace it with the same or a comparable product.

### What is not covered under this guarantee?

- Normal wear and tear.
- Deliberate or negligent damage, damage caused by failure to observe operating instructions, incorrect installation or by connection to the wrong voltage, damage caused by chemical or electro-chemical reaction, rust, corrosion or water damage including but not limited to damage caused by excessive lime in the water supply, damage caused by abnormal environmental conditions.
- Consumable parts including batteries and lamps.
- Non-functional and decorative parts which do not affect normal use of the appliance, including any scratches and possible color differences.
- Accidental damage caused by foreign objects or substances and cleaning or unblocking of filters, drainage systems or soap drawers.

- Damage to the following parts: ceramic glass, accessories, crockery and cutlery baskets, feed and drainage pipes, seals, lamps and lamp covers, screens, knobs, casings and parts of casings. Unless such damages can be proved to have been caused by production faults.
- Cases where no fault could be found during a technician's visit.
- Repairs not carried out by our appointed service providers and/or an authorized service contractual partner or where non-original parts have been used.
- Repairs caused by installation which is faulty or not according to specification.
- The use of the appliance in a non-domestic environment i.e. professional use.
- Transportation damages. If a customer transports the product to their home or other address, IKEA is not liable for any damage that may occur during transport. However, if IKEA delivers the product to the customer's delivery address, then damage to the product that occurs during this delivery will be covered by this guarantee.
- Cost for carrying out the initial installation of the IKEA appliance. However, if an IKEA service provider or its authorized service partner repairs or replaces the appliance under the terms of this guarantee, the service provider or its authorized service partner will re-install the repaired appliance or install the replacement, if necessary.

This restriction do not apply to fault-free work carried out by a qualified specialist using our original parts in order to adapt the appliance to the technical safety specifications of another EU country.

### How country law applies

The IKEA guarantee gives You specific legal rights, which covers or exceed local demands. However these conditions do not limit in any way consumer rights described in the local legislation



### Area of validity

For appliances which are purchased in one EU country and taken to another EU country, the services will be provided in the framework of the guarantee conditions normal in the new country. An obligation to carry out services in the framework of the guarantee exists only if the appliance complies and is installed in accordance with:

- the technical specifications of the country in which the guarantee claim is made;
- the Assembly Instructions and User Manual Safety Information;

### The dedicated After Sales Service for IKEA appliances:

Please do not hesitate to contact IKEA After Sales Service to:

1. make a service request under this guarantee;
2. ask for clarification on installation of the IKEA appliance in the dedicated IKEA kitchen furniture. The service won't provide clarifications related to:
  - the overall IKEA kitchen installation;
  - connections to electricity (if machine comes without plug and cable), to water and to gas since they have to be executed by an authorized service engineer.
3. ask for clarification on user manual contents and specifications of the IKEA appliance.

To ensure that we provide you with the best assistance, please read carefully the Assembly Instructions and/or the User Manual section of this booklet before contacting us.

### How to reach us if You need our service



Please refer to the last page of this manual for the full list of IKEA appointed contacts and relative national phone numbers.

**Important!** In order to provide You with a quicker service, we recommend that You use the specific phone numbers listed at the end of this manual. Always refer to the numbers listed in the booklet of the specific appliance You need an assistance for. Before calling us, assure that You have to hand the IKEA article number (8 digit code) for the appliance of which you need our assistance.

**Important! SAVE THE SALES RECEIPT!** It is Your proof of purchase and required for the guarantee to apply. Note that the receipt reports also the IKEA article name and number (8 digit code) for each of the appliances you have purchased.

### Do You need extra help?

For any additional questions not related to After Sales of your appliances, please contact our nearest IKEA store call centre. We recommend you read the appliance documentation carefully before contacting us.

Country	Phone number	Call Fee	Opening time
België	070 246016	Binnenlandse gesprekskosten	8 tot 20 Weekdagen
Belgique		Tarif des appels nationaux	8 à 20. En semaine
България	0700 10 218	Такса за повикване от страната	От 9 до 18 ч в работни дни
Česká republika	246 019721	Cena za místní hovor	8 až 20 v pracovních dnech
Danmark	70 15 09 09	Landstakst	man.-fre. 09.00-20.00 lør. 09.00-16.00 1 søndag pr. måned, normalt første søndag i måneden
Deutschland	01803-334532	(0,09 € / Min.*) * aus dem Festnetz der DTAG; Mobilfunkpreise abweichend	8 bis 20 Werktage
Ελλάδα	211 176 8276	Υπεραστική κλήση	8 έως 20 κατά τις εργάσιμες ημέρες
España	91 1875537	Tarifa de llamadas nacionales	De 8 a 20 en días laborables
France	0170 36 02 05	Tarif des appels nationaux	9 à 21. En semaine
Ireland	0 14845915	National call rate	8 till 20 Weekdays
Ísland	5880503	Innanlandsgjald fyrir síma	9 til 18. Virka daga
Italia	02 00620818	Tariffa applicata alle chiamate nazionali	dalle 8 alle 20 nei giorni feriali
Κυπρος	22 030 529	Υπεραστική κλήση	8 έως 20 κατά τις εργάσιμες ημέρες
Magyarország	061 998 0549	Belföldi díjszabás	Hétköznap 8 és 10 óra között
Nederland	0900 235 45 32 and/or 0900 BEL IKEA	"0,10 EUR/min (niet lokaal) Incl. BTW"	ma-vr 9.00-21.00 zat 9.00-20.00 zon 9.00-18.00
Norge	815 22052	Takst innland	8 til 20 ukedager
Österreich	0810 300486	zum Ortstarif	8 bis 20 Werktage
Polska	012 297 8787	Stawka wg taryfy krajowej	Od 8 do 20 w dni robocze
Portugal	211557985	Chamada Nacional	9 às 21. Dias de Semana *excepto feriados
România	0212121224	Tarif apel național	8 - 20 în zilele lucrătoare
Россия	8 495 6662929	Действующие телефонные тарифы	с 8 до 20 по рабочим дням Время московское
Schweiz	031 5500 324	Tarif für Anrufe im Bundesgebiet	8 bis 20 Werktage
Suisse		Tarif des appels nationaux	8 à 20. En semaine
Svizzera		Tariffa applicata alle chiamate nazionali	dalle 8 alle 20 nei giorni feriali
Slovensko	(02) 3300 2554	Cena vnútroštátneho hovoru	8 až 20 v pracovných dňoch
Suomi	0207 85 1000	Kotimaan puhelun hinta	arkipäivisin 8.00-20.00
Sverige	0775 700 500	lokalsamtal (lokal taxa)	mån-fre 8.30-20.00 lör-sön 9.30-18.00
Türkiye	212 244 0769	Ulusal arama ücreti	Hafta içi saat 09:00'dan 18:00'a kadar
Україна	044 586 2078	Міжміські дзвінки платні	9 - 21 в робочі дні
United Kingdom	020 3347 0044	National call rate	9 till 21. Weekdays



