

Content

1.	Introduction.....	7
1.1.	About This Manual	7
1.2.	The Risk of Injury	7
1.3.	Before You Begin.....	7
1.4.	Related User Materials.....	8
1.5.	Conventions	8
2.	General Information.....	9
2.1.	Product Dimensions	9
2.2.	INMOTION SCV Serial Number.....	10
2.2.1.	Specifications	10
2.3.	How the INMOTION SCV Works	11
2.4.	INMOTION SCV Components.....	13
2.5.	Assembling the INMOTION SCV	14
2.5.1.	Unpacking the box.....	14
2.5.2.	Assembling the INMOTION SCV	15
2.6.	SmartKey	17
2.6.1.	SmartKey Buttons and Display	17
2.6.2.	SmartKey Functions	20
2.7.	Info LED and Sound Prompt.....	23
2.7.1.	Info LED	23
2.7.2.	Sound Prompt.....	25

2.8.	Working Mode	25
2.8.1.	Introduction	25
2.8.2.	State Transition Diagram Among Working Modes	28
2.9.	The Front Light and the Rear Light.....	29
2.10.	The Driver Detect Sensors	29
2.11.	Communication and Charge Port	30
2.11.1.	WIFI Port	30
2.11.2.	GPRS & GPS	30
2.12.	USB Charging Port	31
2.13.	Smart phone APP	32
3.	Driving Your INMOTION SCV.....	33
3.1.	Driving Guidelines	33
3.1.1.	Safety Cautions	33
3.1.2.	Prepare for Driving.....	33
3.1.3.	Powering On the INMOTION SCV	34
3.1.4.	Stepping On.....	35
3.1.5.	Moving Forward and Backward	36
3.1.6.	Stopping	37
3.1.7.	Turning the INMOTION SCV.....	38
3.1.8.	Stepping Off	39
3.1.9.	Securing Your INMOTION SCV	40
3.1.10.	Powering Off the INMOTION SCV.....	40

3.2.	Practice Driving	40
3.3.	Training Mode and Speed Mode	41
3.4.	Assist Mode	42
3.5.	Remote Control Mode.....	42
3.5.1.	Remote Control	42
3.5.2.	Action Order.....	42
3.6.	Self-examination Mode.....	43
3.7.	Safety Alerts.....	44
3.7.1.	Speed Limiter	44
3.7.2.	Shaft Shake Warning	46
3.7.3.	Safety Shutdown	47
3.8.	Environmental Factors Affected the Vehicle’s Performance	47
3.8.1.	Driving Distance.....	47
3.8.2.	Driving in Hot Temperatures	48
3.8.3.	Driving in Cold Temperatures	49
3.8.4.	Climbing.....	49
3.8.5.	Declining.....	49
4.	Using the Battery Pack.....	50
4.1.	Battery Safety.....	50
4.2.	Specifications for the Battery Pack	52
4.3.	Charging the INMOTION SCV	52
4.3.1.	Charging Procedures	53

4.3.2.	Charging Indicator.....	53
4.4.	Replacing the Battery Pack	54
4.5.	Transporting Battery Pack.....	55
5.	Safe Driving.....	56
5.1.	Rules that You Must Follow.....	56
5.2.	Actions that You Must Avoid	57
5.3.	Safety Alerts.....	58
6.	Operating and Maintaining Your INMOTION SCV	60
6.1.	Lifting Your INMOTION SCV	60
6.1.1.	Lifting your INMOTION SCV by the Turning Shaft	60
6.1.2.	Lifting your INMOTION SCV by the Metal Grip.....	60
6.2.	Cleaning your INMOTION SCV	61
6.3.	Storing Your INMOTION SCV	61
6.4.	Maintaining Your INMOTION SCV.....	62
7.	Troubleshooting the INMOTION SCV.....	63
7.1.	Diagnosing Errors with SmartKey	63
7.2.	The INMOTION SCV Will Not Power On	65
7.3.	The INMOTION SCV Will Not Enter Balance Mode	65
7.4.	The INMOTION SCV is Prone to Shake	66
7.5.	The Turning Shaft Slips or is Off-Centered.....	66
7.6.	The INMOTION SCV Will Not Power Off	66
7.7.	The INMOTION SCV Cannot Link to the APP.....	67

8.	Contact and Legal Information	68
8.1.	Report a Problem	68
8.2.	How to Reach Us	68
8.3.	Obey All Laws and Regulations.....	68

1. Introduction

1.1. About This Manual

This User Manual is intended to help you set up and use your INMOTION SCV. You need to read this Manual carefully, watch the Safety Videos and make sure to use your INMOTION SCV following the safety instructions.

It is important that you adhere to all safety warnings and cautions that appear throughout this User Manual.

This User Manual is suitable for INOMTION R1 and INMOTION R1S.

If you have questions or require more information beyond this User Manual, please contact an authorized INMOTION SCV dealer or distributor in your area.



WARNING!

- ◆ Whenever you drive the INMOTION SCV, you risk injury from loss of control, collisions, and falls. To reduce risk of injury, you must read and follow all instructions in this User Manual and watch the Safety Videos.

1.2. The Risk of Injury

INMOTION SCV is a self-balancing sensor control vehicle. Balancing technology cannot prevent injury if you do not drive the INMOTION SCV safely.

1.3. Before You Begin

Before you begin, it may be necessary to assemble your INMOTION SCV. The Battery Pack should be charged for 5 hours. To assemble the INMOTION SCV and charge the Battery Pack for the first time, please refer to “2.5 Assembling the INMOTION



SCV” and “4.3 Charging the INMOTION SCV” section in this Manual.

1.4. Related User Materials

INMOTION provides an electronic copy of the User Manual, the Safety Videos, and the help documents for your convenience. You can download them as well as the applications for smart phones and tablets from www.imscv.com

1.5. Conventions

The following conventions are used throughout this manual:

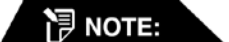
 WARNING!	Warns you about actions that may result in personal injury.
 CAUTION!	Cautions you about actions that may result in operational issues or physical damage to the INMOTION SCV.
 NOTE:	Identifies important points, helpful hints, special circumstances, or alternative methods.

2. General Information

2.1. Product Dimensions



2.2. INMOTION SCV Serial Number

The serial number is unique to your INMOTION SCV. Please write it down and store it in a safe place. The serial number is a 16-digit number along with the barcode printed on your INMOTION SCV.

The serial number is required when the customer claims after-sales service, warranty, insurance, or confirmation of loss.

Locations of INMOTION SCV Serial Number:

- The packing;
- Warranty Card;
- Battery Slot (Pull out the Battery Pack and you will see the SN in the slot).

2.2.1. Specifications

Item	Value	Note
Model	INMOTION R1	^① Max Speed can be adjusted through the application. You may get a higher instant speed but will stabilize at the set speed. ^② Distance per charge was acquired under the following test conditions: 25°C, 70 Kg payload and smooth road. The cruising distance is varied regarding different driving conditions. ^③ The Machine Weight is acquired with a 4 Ah Battery Pack. Different models weigh differently because of different materials applied. R1 is about 15.5 Kg, R1S is about 14 Kg. ^④ Dimensions were measured when the Turning Shaft is at its longest.
Max. Speed	15 Km/h ^①	
Distance per charge	20 Km ^②	
Max Climbing Angle	15°	
Machine Weight	15.5 Kg / 14 Kg ^③	
Load	25 ~ 100 Kg	
Turning Radius	0 m	
Dimensions (W * D * H)	460*490*1440 mm ^④	
Battery	72 V 4 Ah Lithium Ion(Li-ion) ^⑤	

Power Requirements	AC 110 ~ 240 V 50 ~ 60 Hz	◎4 Ah battery is the standard configuration. You can also choose a 6 Ah Battery Pack to get a longer cruising distance, but it will increase the total weight. ◎Charging time of SCV varies regarding different environment temperature and capacity of the Battery Pack.
Full Charge Time	About 5 Hours ◎	
Tire Type	Tubeless Tires	
Operating Temperature Range	15 ~ 30 °C	



NOTE:

- For additional information about Maximum Payload (Driver Plus all Cargo), turn to later chapters.
- For additional information about how to raise driving distance per charge, turn to Chapter 3, “Environmental Factors Affected the Vehicle’s Performance”.

2.3. How the INMOTION SCV Works

The INMOTION SCV works like the human body. When walking, if you lean forward, you take a step forward to keep your balance. If you lean back, you step back. On an INMOTION SCV when you lean forward or back the machine powers the Wheels in the direction that you lean.

The INMOTION SCV uses dynamic stabilization technology and applies many gyroscopes, sensors and Permanent Magnet Synchronous Motor (PMSM) to maintain its balance and move forward or backward.

When you pivot the Turning Shaft left, the INMOTION SCV turns left. When you pivot the Turning Shaft right, the INMOTION SCV turns right. To turn the INMOTION SCV, point the Turning Shaft in the direction you want to go, keeping the Handlebar in line with your body. When the Turning Shaft is centered, the INMOTION SCV travels straight ahead.

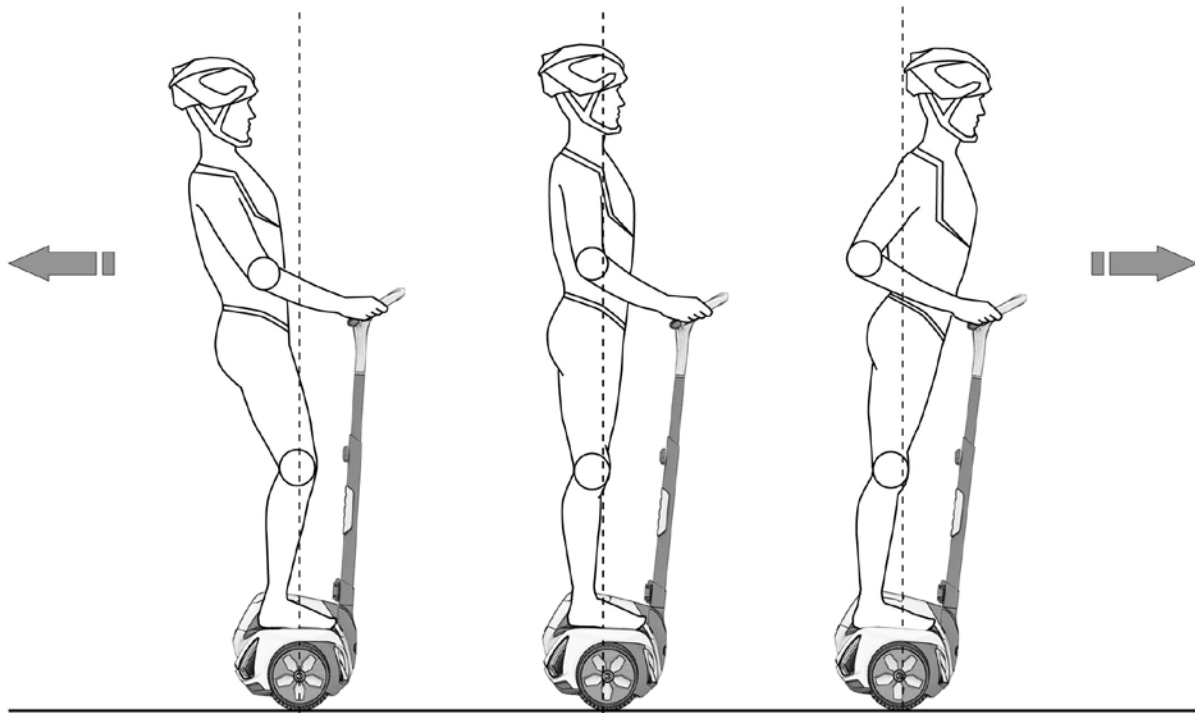

2.4. INMOTION SCV Components

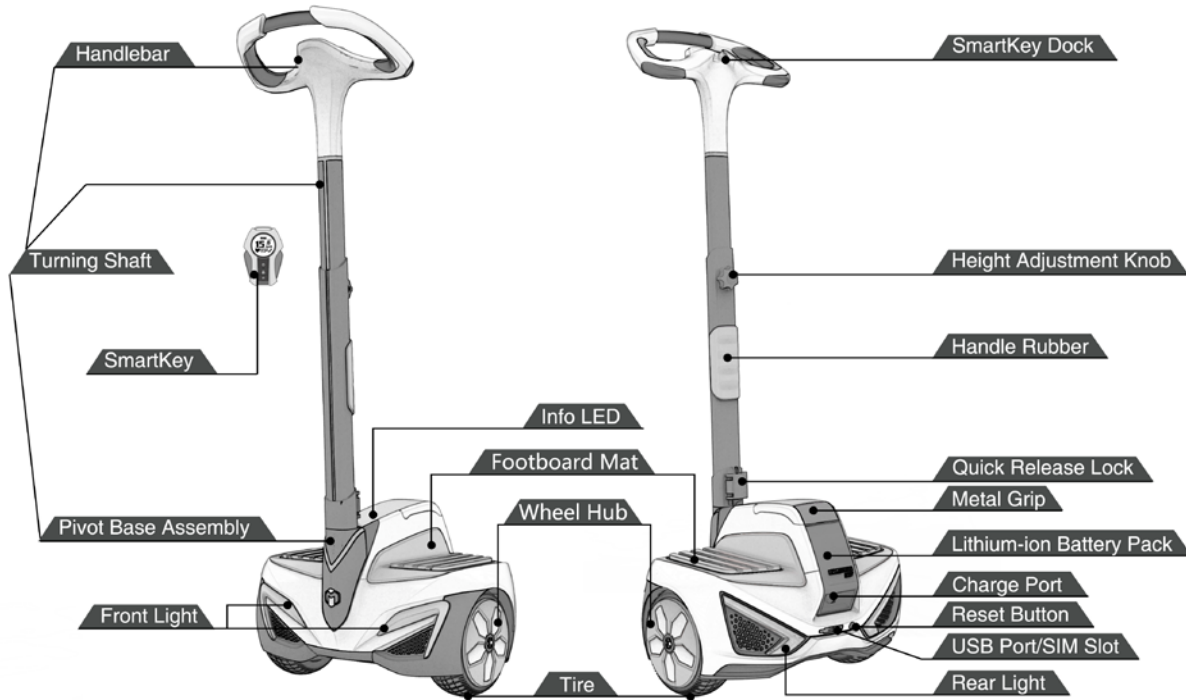

2.5. Assembling the INMOTION SCV

2.5.1. Unpacking the box

Any missing or visibly damaged parts should be reported to your dealer immediately.

1. INMOTION SCV body	5 .Installation Tool and a few Screws
2.Handlebar (R1 uses ABS plastic, R1S uses Carbon Fiber)	6. SmartKey and SmartKey Chain
3. Turning Shaft	7. User Manual, Warranty Card, Product Certification and Useful Tips Card
4. Charger	
8. 4 Ah Lithium Battery Pack (Separate package and a Useful Tips Card is included.)	



WARNING!

- All INMOTION SCV parts must be approved by INMOTION, and properly installed.
- Never attempt to stand on an INMOTION SCV without the Turning Shaft properly attached.
- Using your INMOTION SCV without all parts properly installed could damage your INMOTION SCV and result in serious injury from loss of control, collisions, and falls.
- Do not modify the INMOTION SCV. Modifications to the INMOTION SCV without the prior written approval of INMOTION could interfere with the operation of the INMOTION SCV, could result in serious injury or damage.

2.5.2. Assembling the INMOTION SCV

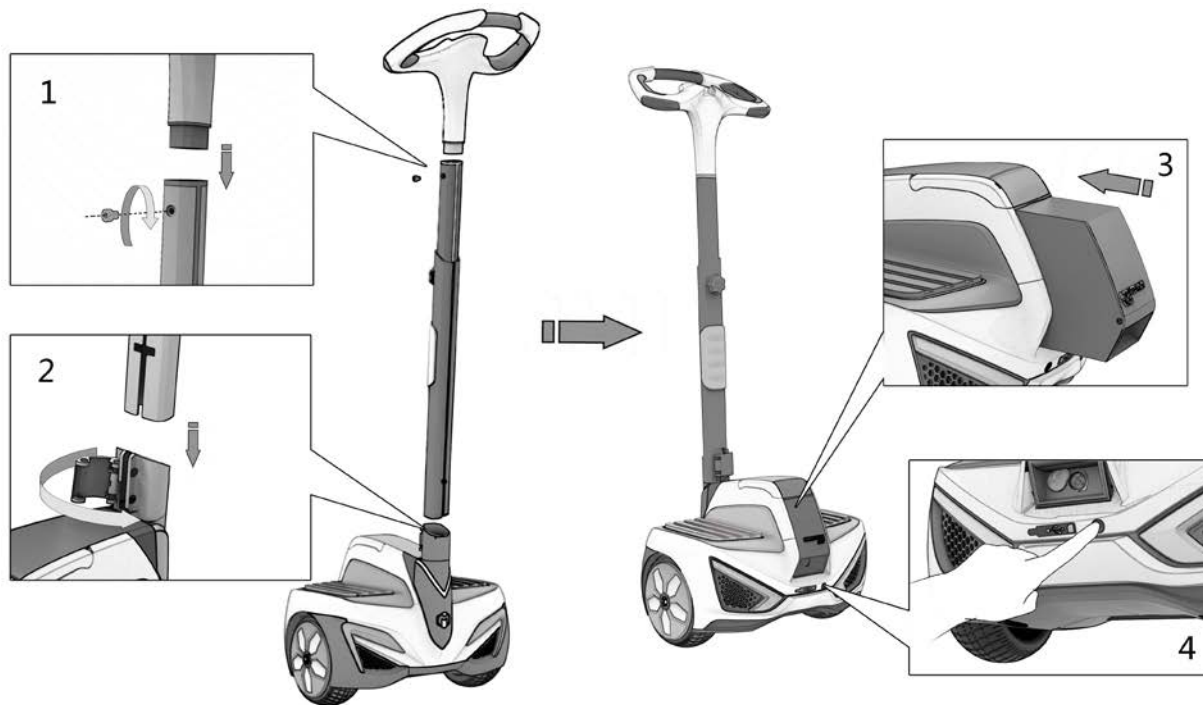

To assemble an INMOTION SCV:

1. Insert the Handlebar into the top of the Turning Shaft (the slimmer part), and tighten it with the sockets (sockets and installation tool are included in the box. Please pay attention to the front and back of the Handlebar.).

2. Unlock the Quick Release Lock, insert the Turning Shaft into Pivot Base Assembly to the bottom, and lock the Quick Release Lock (If the Turning Shaft has not been inserted to the bottom, the Quick Release Lock cannot be locked properly). Now assembling the Turning Shaft is finished, including the Handlebar, the Shaft and Pivot Base Assembly. If necessary, the Turning Shaft can be removed from the SCV by unlocking the Quick Release Lock.

3. Take the Battery Pack out from the battery package, and put the Battery Pack into the Battery Slot with the other hand holding the INMOTION SCV body. After hearing a clear clucking, try slightly pulling it out. If the Battery Pack cannot be pulled out, then the Battery Pack is installed properly.

4. Press the Reset Button on the back of the SCV, and power on the INMOTION SCV with SmartKey.



NOTE:

- If necessary, especially when you need to put the INMOTION SCV in the trunk of your car, the Turning Shaft and the Handlebar can be quickly removed or assembled by unlocking the Quick Release Lock.



WARNING!

- Please confirm the Turning Shaft is installed properly because of the movable joint. You can try lifting the Turning Shaft with both hands to check if it is loosen (If it is loosen, tighten the sockets.).
- If you need to remove the Turning Shaft, hold it tight with one hand, unlock the Quick Release Lock with another hand, and slightly shake it and pull it out.

2.6. SmartKey

The SmartKey is a chargeable and upgradable device with information display and remote control function. The INMOTION SCV can be operated or monitored by remote control.

The SmartKey has three buttons and a display in the center, and its effective communication range is 5~10m (depends on working environment and using methods).





2.6.1. SmartKey Buttons and Display

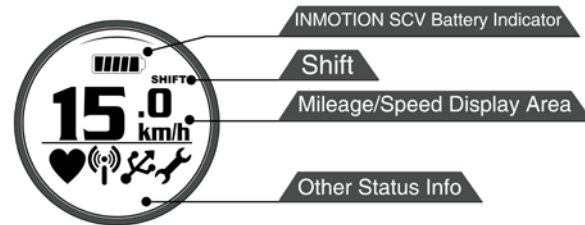







The display area shows the operational state of the INMOTION SCV and some information (including speed, distance, battery, etc.).















The following chart shows the function of buttons on the SmartKey:

Button	Description
	Power/Standby Button: Allows you to power the INMOTION SCV on and off.
	Lock/Unlock Button: Allows you to lock or unlock the INMOTION SCV.
	Shift Button: Allows you to shift among different modes.

The following chart shows the function of icons on the SmartKey:

Icon	Description	Icon	Description
	Battery icon: Indicates the amount of power remaining in the INMOTION SCV Battery Pack.		Speedometer icon: Indicates the mileage of the INMOTION SCV, to an accuracy of 0.1 Km
	Shift icon: Indicates the INMOTION SCV is in Shift Mode.		Odometer icon: Indicates the speed of the INMOTION SCV, to an accuracy of 0.1 Km/h
	INMOTION Logo icon: Shows when the SmartKey is powered on.		No Signal icon: Indicates the SmartKey has no signal. Shows when the SmartKey is not detected the INMOTION SCV.
	INMOTION Logo icon: Shows when the SmartKey is power off.		Unpair icon: Indicates the SmartKey is not paired with any INMOTION SCV.

	<p>Manned Speed Mode icon: Indicates the INMOTION SCV has detected a driver, and it is in Speed Mode.</p>		<p>Assist Mode icon: Indicates the INMOTION SCV is in Assist Mode.</p>
	<p>Manned Training Mode icon: Indicates the INMOTION SCV has detected a driver, and it is in Training Mode.</p>		<p>Remote Control Mode icon: Indicates the INMOTION SCV is in Remote Control Mode.</p>
	<p>USB icon: Indicates the INMOTION SCV is plugged in to USB.</p>		<p>Speed Mode icon: Indicates the INMOTION SCV is in Speed Mode.</p>
	<p>Wrench icon: Indicates a system fault on the INMOTION SCV that requires service.</p>		<p>Training Mode icon: Indicates the INMOTION SCV is in Training Mode.</p>
	<p>SmartKey Link Signal icon: Indicates the SmartKey has detected the INMOTION SCV.</p>		<p>Power Off icon: Indicates the INMOTION SCV is power off.</p>
	<p>SmartKey Unlink Signal icon: Indicates the SmartKey has not detected the INMOTION SCV.</p>		<p>Security icon: Indicates the security function is activated.</p>



Low Battery icon: Indicates the SmartKey battery needs to be charged for about 2 hours with a micro USB cable.

2.6.2. SmartKey Functions

The SmartKey includes the following functions: power on/off the INMOTION SCV, lock/unlock the INMOTION SCV, power on/off the SmartKey, pair, enter/exit Shift Mode, and enable LED backlighting. These functions are all triggered by 3 buttons on the SmartKey. Key combinations are used to activate/deactivate different functions. You can press, press and hold for 2 seconds, or combine the keys to activate different functions. Also, Shift Mode is designed to reduce the complexity of operating the SmartKey, and some less frequently used functions are merged into Shift Mode. The same key combination indicates different meanings in Shift Mode.

The following chart shows the function of buttons on the SmartKey:

Non-Shift Mode				
Button \ State	Unpair	Power on	Power off	Standby
Press Power/Standby Button	Pair	Power on	Power off	N/A
Press Lock/Unlock Button	N/A	Lock/Unlock the INMOTION SCV	Lock/Unlock the INMOTION SCV	N/A
Press Shift button	N/A	Switch between Training Mode, Speed Mode and Assist Mode Switch between Training Mode and Speed Mode when Driver	Switch between Training Mode and Speed Mode (it won't take effect until the next time you log on)	Power on the SmartKey

		Detect Sensors are depressed		
Press and hold Lock/Unlock Button for 2 seconds	N/A	Shows total distance traveled on the INMOTION SCV	Shows total distance traveled on the INMOTION SCV	N/A
Press and hold Shift button for 2 seconds	N/A	Enter Shift Mode	Enter Shift Mode	N/A
Press and hold Power/Stand by Button and Shift button together for 2 seconds	N/A	Illuminate the Backlight	Illuminate the Backlight	N/A

Shift Mode				
Button \ State	Unpair	Power on	Power off	Standby
Press Power/Standby Button	N/A	Shows the event log	Shows the event log	N/A
Press Lock/Unlock Button	N/A	Self-examination Mode	N/A	N/A
Press Shift button	N/A	Illuminate/turn off Front Light	Illuminate/turn off Front Light	N/A
Press and hold Lock/Unlock Button for 2 seconds	N/A	Turn off the SmartKey	Turn off the SmartKey	N/A
Press and hold Shift button for 2 seconds	N/A	Exit Shift Mode	Exit Shift Mode	N/A
Press and hold Power/Standby Button and Shift button together for 2 seconds	N/A	Shut down the INMOTION SCV	Shut down the INMOTION SCV	N/A

NOTES:

- “N/A” indicates the key is not responding in the state.
- The INMOTION SCV will only accept commands when nobody stands on, because executing commands from the SmartKey when you are driving may cause damage (including power off the INMOTION SCV, lock/unlock, self-examine, enter/exit Assist Mode and shut down). If you do not operate the SmartKey within 30 seconds, backlight of the SmartKey will turn off.
- The SmartKey will power off after different periods of time under below conditions:
- When the SmartKey is not paired with any INMOTION SCV: 1 minute;
- When the SmartKey and the INMOTION SCV are paired, but the SmartKey cannot detect the INMOTION SCV or no driver is on the INMOTION SCV: 3 minutes;
- When the SmartKey and the INMOTION SCV are paired, the SmartKey can detect the INMOTION SCV and driver INMOTION SCV is under Balance Mode: 10 minutes.
- If the SmartKey is off, you can restart it by pressing the Power/Standby Button.





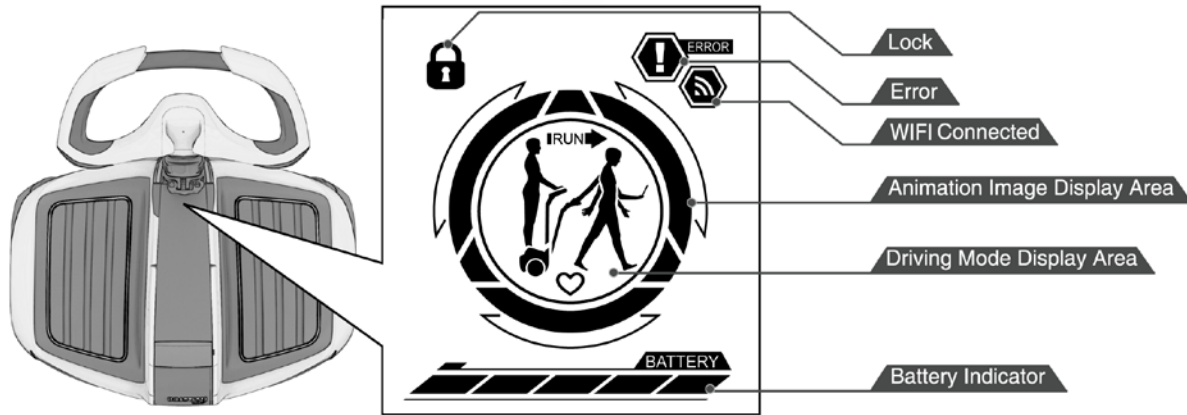

2.7. Info LED and Sound Prompt

2.7.1. Info LED

The Info LED is a display screen that shows running state of the INMOTION SCV as below:



Icons and descriptions:

Icon	Description	Icon	Description
	<p>Manned Speed Mode icon: Indicates the INMOTION SCV has detected a driver, and it is in Speed Mode</p>		<p>Assist Mode icon: Indicates the INMOTION SCV is in Assist Mode.</p>
	<p>Manned Training Mode icon: Indicates the INMOTION SCV has detected a driver, and it is in Training Mode.</p>		<p>Remote Control Mode icon: Indicates the INMOTION SCV is in Remote Control Mode.</p>
	<p>Error icon: Indicates a system fault of the INMOTION SCV.</p>		<p>Lock Mode icon: Indicates the INMOTION SCV is in Lock Mode. When the Lock Mode icon is not displayed, the Lock Setting has been disabled.</p>
	<p>WIFI Signal icon:</p> <ul style="list-style-type: none"> ● Red indicates WIFI is unable to connect now. ● Blue indicates WIFI link is activated. ● Off indicates WIFI works fine but it is unconnected. 		

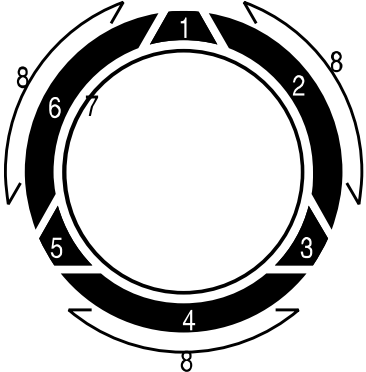
	<p>Battery icon: Battery Gauge, 5 bars</p> <ul style="list-style-type: none"> • More than 3 bars: Green • 2 bars and 3 bars: Yellow • 0 bar and 1 bar: Red, the gauge flashes to warn low battery
	<p>Panel icon:</p> <ul style="list-style-type: none"> • Icon 1, 3 and 5 flash in blue when the INMOTION SCV is in Standby Mode. • Under Balance Mode, Assist Mode or Remote Control Mode, the circle will turn following the sequence (6,1)→(2,3)→(4,5)→(6,1), the faster you drive, the faster the circle turns. • Icon 1, 3 and 5 flash in red when the INMOTION SCV encounters a problem.

2.7.2. Sound Prompt

The built-in speaker in the INMOTION SCV will make different sounds to indicate instant running state and working mode.

The Sound Prompt is on by default. You can turn off the tone or customize the sounds that accompany events with your APP on smart phones or tablets. See “**Smart phone APP**” for more information.

2.8. Working Mode

2.8.1. Introduction

The table below lists some of the important working modes:

Working Mode	Description
Standby Mode	The INMOTION SCV is in Standby Mode by default. Most of the other modes will be shift from Standby Mode.
Balance Mode	Indicates the INMOTION SCV has detected a driver and the footboard angle is between 0° and 2°. Training Mode and Speed Mode can be activated under Balance Mode. Read the following chapter for more information.
Automatic Lay Flat Mode	When a driver steps a foot on the INMOTION SCV, if the footboard angle is moderate(between 2° and 15°. An excessive angle will affect your experience when you step on, a small angle will lead your INMOTION SCV into Balance Mode.) , the control system will lay flat the footboard, and your INMOTION SCV may travel a short distance backward.
Excessive Angle Mode	When a driver steps a foot on the INMOTION SCV, if the footboard angle is excessive, it will vibrate to warn the driver to lay flat the footboard slowly. During this process, the INMOTION SCV will go through Automatic Lay Flat Mode and Balance Mode.
Self-examination Mode	The INMOTION SCV will examine and calibrate itself in Self-examination Mode. Self-examination Mode can be operated from the SmartKey. Read the following chapter for more information.
Error Mode	During normal riding, if the INMOTION SCV detects an error or a system fault, it will automatically reduce its speed till it stops. The INMOTION SCV will automatically lock the Tires if the damaged SCV or the system needs to be restored by INMOTION engineers. Once the Tires are locked, it is unable to unlock. Please contact the local distributor for maintenance service.
Assist Mode	Under Assist Mode, the INMOTION SCV will proactively provide certain power according to the

	initial angle and climbing angle, which helps transport and climbing a slope (not when riding). For more information about Assist Mode, please refer to
Remote Control Mode	Remote Control Mode is a Balance Mode without driver which needs to link with APP on smart phones. The INMOTION SCV can receive and execute simple orders under Remote Control Mode. Read the following chapter for more information.
Sleep Mode	In Sleep Mode, WIFI module and the SmartKey are in standby state, but the rest circuit of the INMOTION SCV is powered off to lower the power consumption. After 18 hours in Sleep Mode, the entire system will power off automatically to protect the Battery Pack. You have to press the start button on the back of the INMOTION SCV to turn the power on.

2.8.2. State Transition Diagram Among Working Modes

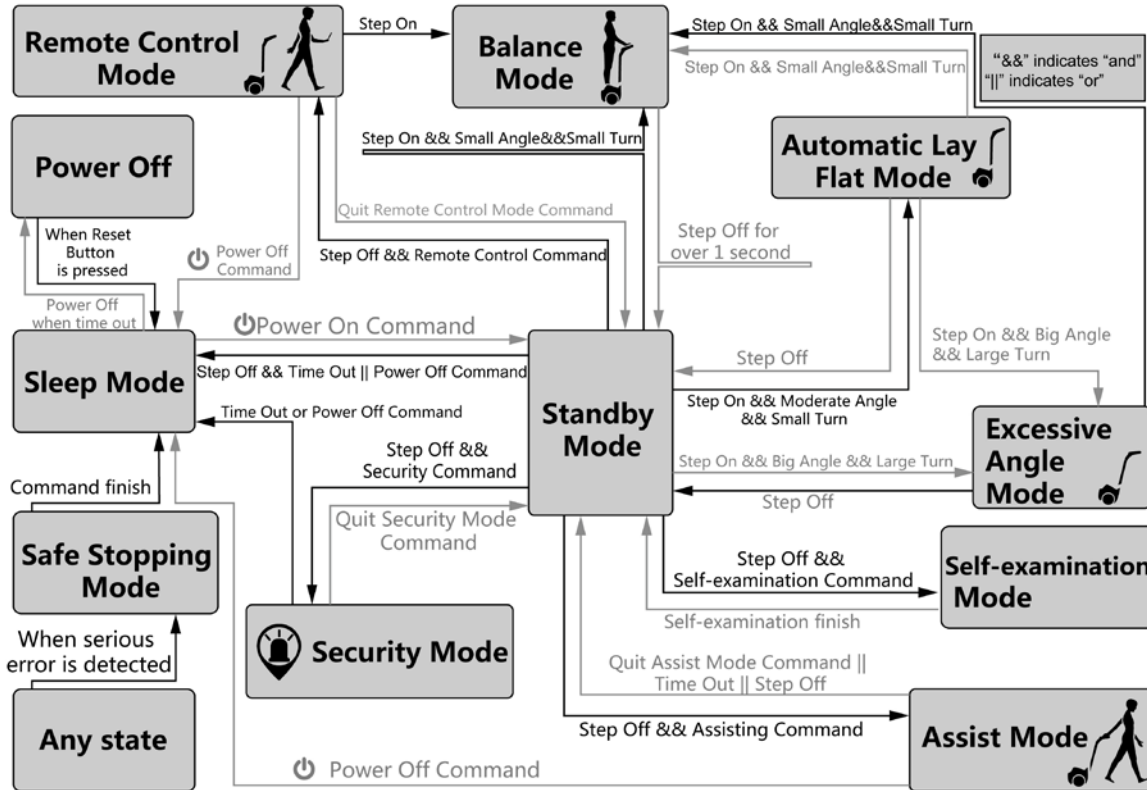

2.9. The Front Light and the Rear Light

The Front Light of the INMOTION SCV is a pair of blue LED lights, and the Rear Light is a pair of red LED lights. They flash in different modes according to your operation. The following chart shows different functions of the Front Light and the Rear Light:

Operation	Description
Power On	The Front Light and the Rear Light illuminate for 1 second.
Switch On	The Front Light and the Rear Light flash.
Standby	The Front Light and the Rear Light illuminate for 0.5 second every 3 seconds.
Error Sending	The Front Light and the Rear Light illuminate at the frequency of 1 Hz.
Balancing	The Rear Light illuminates in half brightness.
Slowing down	The Rear Light illuminates for 1 second, and then illuminates in half brightness
Turning	The Rear Light of the turning direction illuminates, and the Front Light flashes from both sides to the middle.

You can turn the Front Light and the Rear Light on or off by pressing the shift button under Shift Mode, and turn off the Front Light and the Rear Light completely through the mobile application. Once it is completely turned off, the SmartKey is no longer responding to any command regarding the lights.

2.10. The Driver Detect Sensors

Driver Detect Sensors detect the presence or absence of a driver while the INMOTION SCV is powered on. The Driver Detect Sensors work like a weighing machine. They can detect the driver is standing on one foot or two feet,

The Driver Detect Sensors can also weight the driver and show the weight on the APP, and the margin of the measurement error will be within 1Kg.

2.11. Communication and Charge Port

The INMOTION SCV is not only a simple personal transporter, but also able to communicate with your smart phones or tablets through our APP. The built-in SIM card and GPS chipset allow you to track your INMOTION SCV.

2.11.1. WIFI Port

The INMOTION SCV can communicate with Smart phones via Wi-Fi, and it can work both under client mode and AP mode, and it will automatically switch to the right mode according to the wireless access point's working mode. Under client mode, the INMOTION SCV will be used as a network card on your computer or phone, it will work when connects to a wireless AP; and AP mode, the INMOTION SCV will turn into a wireless AP waiting for smart phones to connect.

A Wi-Fi AP list is created in the control system, but this list is empty when the INMOTION SCV leaves the factory.

At the start up, the INMOTION SCV will automatically search APs in the surroundings and match with the inside AP list, if the searching result matches an entry in the list, the INMOTION SCV will connect to the AP; if no match is found, the INMOTION SCV will switch to AP mode and wait for other devices to connect. For the first startup of the INMOTION SCV, it will only starts in AP mode since the inside AP list is empty. The SSID of the INMOTION SCV under AP mode is INMOTION-XXXXXXXX by default, the password is INMOTION123. XXXXXXXX is a random serial number and both SSID and password can be modified through your Smart Phones APP.

2.11.2. GPRS & GPS

You can track the INMOTION SCV through its built-in GPS chipset and SIM card. The GPRS & GPS Function is off by default to protect your privacy. You need to activate this function through your APP if necessary. The INMOTION SCV will upload your location and some motion data occasionally while the GPRS & GPS Function is activated.

- The following functions can be realized by activating GPRS & GPS Function:
- Acquire location of the INMOTION SCV through your APP when you lost your INMOTION SCV;

- Acquire history record of locations you have been to and speed data;
- Search for other INMOTION SCV drivers around you;

Set up a safety area for the INMOTION SCV to be driven in. If the INMOTION SCV is out of this area it will appear an error sign and lock itself, only when it is returned to the designated area or manually turn off Area Lock Function that can deactivate the security lock.

NOTE:

- The GPRS & GPS Function relies on the local GSM Network, therefore you need to insert a SIM Card and the SIM Card slot is located on the back of the INMOTION SCV body by the USB Port.
- ASIM Card is provided for INMOTION SCV sold within Mainland China.
- For INMOTION SCV sold outside of Mainland China, you need to purchase a SIM Card from local service provide to realize the GPRS function.
- It will generate some data cost by using the SIM card, please contact your local network operator for detailed information.

2.12. USB Charging Port

USB Charging Port is located on the back of the INMOTION SCV body. The INMOTION SCV can charge some mobile devices (including phones, tablets etc.) as well as the SmartKey through the USB Charging Port. The output voltage of the USB Charging Port is 5 volts and the electrical current is 300 mA.



2.13. Smart phone APP

APP is another control panel on your Smart Phone and it can realize advanced functions. The APP name is INMOTION. You can download it from our website, Apple APP Store for IOS System, or Google Play for Android System.

The following functions can be realized by our APP:

- Showing the operational state of the INMOTION SCV and some information (including speed, distance, battery, etc.);
- Setting vehicle parameters including WIFI, GPS, Average Speed, etc.;
- Querying the Event Log;
- Upgrading the INMOTION SCV;
- Providing Location Based Service (LBS) Service;
- Customizing Voice Prompt of the INMOTION SCV;
- Receiving and executing simple orders by remote control;
- Providing maintenance service and immediate response to your request;
- Read the help documents on your APP for more information on what the APP can do.

3. Driving Your INMOTION SCV

3.1. Driving Guidelines

INMOTION SCV is a high-tech sensor control vehicle. If you try to drive INMOTION SCV before getting familiar with the driving guidelines, it will cause unpredictable damage, including injury or even death. This section describes how to drive the INMOTION SCV. It discusses driving for the first time and helpful hints for all drivers.

3.1.1. Safety Cautions

Follow these steps to learn to drive your INMOTION SCV. It is important that you practice driving in a controlled, familiar environment until you are comfortable using your INMOTION SCV and SmartKey. Before driving, make sure your INMOTION SCV is assembled and charged. Inspect your INMOTION SCV before each use. Do not drive if any part is loose, damaged, or if tires are not properly inflated. Do not wear loose clothing or jewelry that could get caught in the INMOTION SCV.

3.1.2. Prepare for Driving

To prepare for your first drive:

- Select an appropriate area for your first drive. This area may be indoors or outdoors and should measure at least 12 feet by 12 feet (4 meters by 4 meters). It must have a level, smooth driving surface with good traction and should be free of obstructions and away from vehicles, bicycles, pets, small children, and other distractions.
- Do not select a slippery area for your first drive.

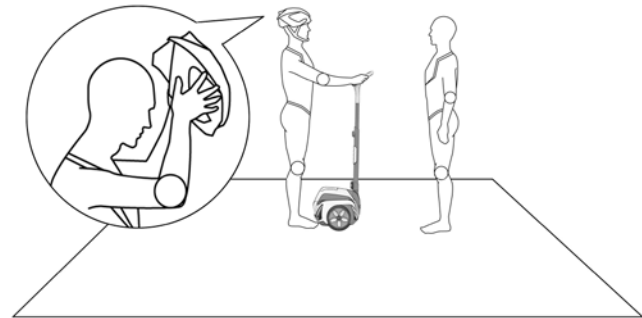

- You will need a helper who is familiar with INMOTION SCV and has studied all the instructions and warnings in this manual.
- Put on a proper helmet.
- Move the INMOTION SCV to the center of the driving area.
- Adjust the Handlebar height.

3.1.3. Powering On the INMOTION SCV

- Using the SmartKey, power on your INMOTION SCV by pressing the Power/Standby Button. The Power/Standby Button is located on the top of the SmartKey.
- You will hear a Voice Prompt from the INMOTION SCV which indicates the INMOTION SCV is in Training Mode (please make sure the INMOTION SCV is in Training Mode for your first drive), and an icon appeared on the LED Screen will illuminate to indicate the power is ON and the INMOTION SCV is in Standby Mode.
- Do not step onto the INMOTION SCV yet! Your INMOTION SCV is powered on, but it is not balancing.

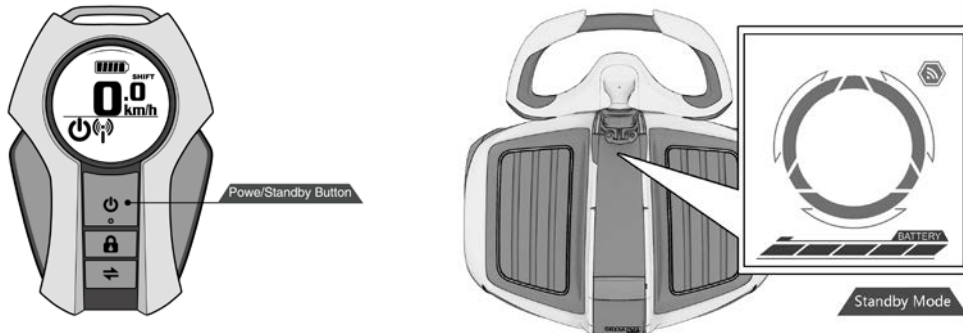

3.1.4. Stepping On

- Before you attempt to step on for the first time, have your helper stand in front of the INMOTION SCV, face you, and hold the Handlebar securely with both hands. Your helper should be prepared to firmly hold the INMOTION SCV to keep it from moving. Make sure the Footboard Mat is level.
- Hold the Handlebar with both hands, and as you step up, look forward and not down.
- Place just one foot on the Footboard Mat.
- Slowly transfer your weight to your foot on the Footboard Mat.
- After hearing a Voice Prompt from the INMOTION SCV, you can raise your back foot off the ground and place it on the Footboard Mat slowly while avoiding moving the Handlebar. Stay calm and relaxed. Look forward. Some people rock back and forth involuntarily when they first step on. The helper should hold the Handlebar firmly.

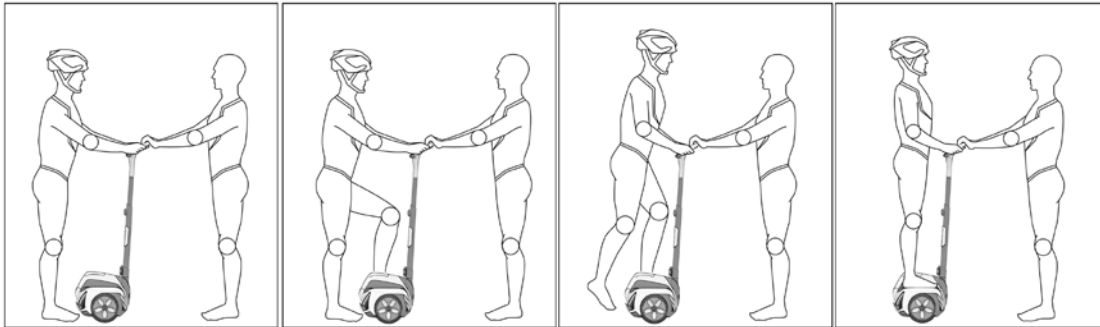

- If you feel unstable, step off the INMOTION SCV, one foot at a time, and pause before stepping back on. The helper should continue holding firmly the entire time, and be prepared to keep the INMOTION SCV from moving as you step on or off.



WARNING!

- If you are standing on the INMOTION SCV now, please remain the Footboard Mat horizontal and stand still. Do not move before you are familiar with it.

3.1.5. Moving Forward and Backward

The INMOTION SCV moves forward and backward in response to changes in your position. When standing on the Footboard Mat, to move forward or backward:

- With your helper available to assist you, slowly lean forward and feel the INMOTION SCV move forward. Then stop leaning forward and feel it slow down and stop. Do this a few times.
- Avoid rocking back and forth or shifting your weight abruptly, as this could result in a loss of traction and cause a fall.
- Look behind you and then slowly lean back and feel the INMOTION SCV move backward. Then stop leaning back and feel it slow down and stop. Do this a few times.

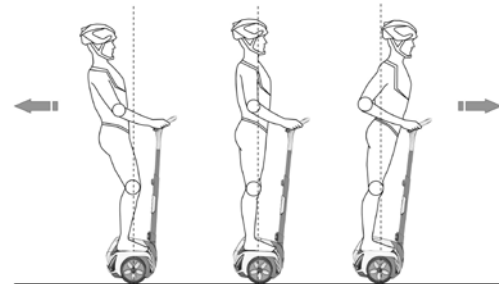

WARNING!

- You should not drive backward in normal driving process. Because of lack of rear view and direction change of turning centrifugal force, driving backward could cause unpredictable fall. Instead, turn and drive forward.
- With your helper standing close by, practice going forward and backward a short distance in each direction. Be careful not to run the Wheels into any object or go too fast. This could cause you to fall.

3.1.6. Stopping

Stop the INMOTION SCV by shifting your weight away from the direction you are moving. To stop the INMOTION SCV:

- When you are moving forward, gently shift your hips back (as if you are preparing to sit down) to bring the INMOTION SCV to a stop.
- Once stopped, center your weight over the Footboard Mat to remain stationary. If you continue to lean back, you will move backward.
- Practice choosing a spot on the ground, and coming to a smooth controlled stop at that spot. Then remain stationary.
- Avoid abrupt stops and slippery surfaces. Stopping abruptly, especially on slippery surfaces, can cause the INMOTION SCV's tires to lose traction, and you could fall.

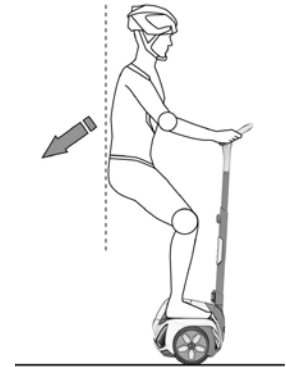

WARNING!

- Please avoid abrupt stops. Always perform a controlled stop by gently shifting your weight away from the direction of movement.
- Avoid slippery surfaces. The INMOTION SCV's Tires could lose traction causing you to fall.

3.1.7. Turning the INMOTION SCV

The INMOTION SCV turns in the direction that you lean the Handlebar. You turn the INMOTION SCV by leaning the Handlebar left or right.

- First, practice turning in place. To turn in place, slowly pivot the Handlebar to the side in the direction that you want to turn. The INMOTION SCV will rotate so that you turn in place.
- After you are comfortable going forward and backward and turning in place, try slowly driving forward and turning at the same time. Keep your body lean in the direction of the turn in coordination with the angle of the Turning Shaft while turning.
- Because abrupt turns can be dangerous, always lean into turns slowly and smoothly.

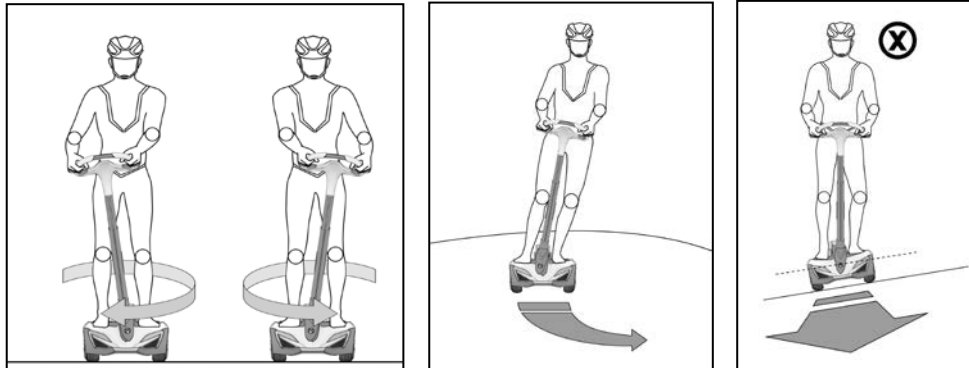

WARNING!

- Do not drive crosswise or turn on the slope, or it will cause balance angle shifting and thus dangerous.

3.1.8. Stepping Off

When you are ready to step off the INMOTION SCV for the first time, your helper should hold the Handlebar. To step off the INMOTION SCV:

- Remain stationary by keeping your weight centered over the Wheels and Footboard Mat and keep the Handlebar vertical. Step off the INMOTION SCV slowly, one foot at a time.
- After you have stepped off, continue to hold the Handlebar for about one second. You can park the INMOTION SCV backward when you hear a tone.

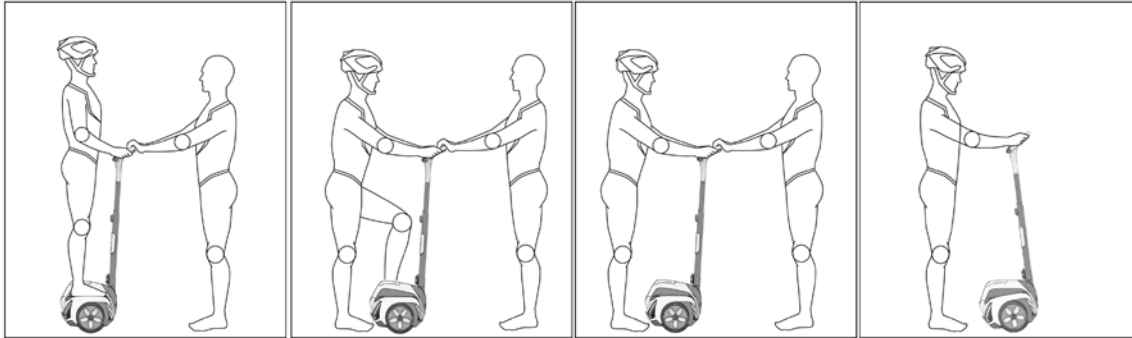

WARNING!

- Do not pull the Turning Shaft backward when stepping off. It may make the SCV moving backward, cause unpredictable damage.
- Practice stepping off for the first time with your helper standing close by.

3.1.9. Securing Your INMOTION SCV

The INMOTION SCV provides Security Mode in case you need to leave your INMOTION SCV unattended. When the INMOTION SCV is in Security Mode:

- If anyone tries to move or shake the INMOTION SCV, it will trigger an alarm and Stick Shake Warning.
- The Wheels will be locked to make it difficult to move your INMOTION SCV.
- The system will exit Security Mode and shut off after four hours of securing to save energy. At this time, the Security Mode is no longer activated.

The Security Mode is intended for use when you remain in the general area of the INMOTION SCV, and are able to respond to an alarm. The best way to discourage tampering with your INMOTION SCV is to keep it in a secure indoor location with the SmartKey stored separately.

GPS chip is built inside, and it can lead you to the INMOTION SCV.

3.1.10. Powering Off the INMOTION SCV

- Power off the INMOTION SCV by pressing the Power/Standby Button on the SmartKey.
- The display on the SmartKey will show an icon and shut off.

3.2. Practice Driving

You will need to become very familiar with your INMOTION SCV before you attempt to drive outside of your controlled practice environment. The more you practice, the safer you will be when you move into new places. Remember the following as you practice:

- Use the Training Mode and drive in areas free of obstacles and distractions until you are comfortable on your

INMOTION SCV. Practice at the Training level until you can step on, drive forward and backward, turn, stop, and step off with the same precision and confidence as you walk.

- With practice, you should be able to drive in narrow areas. Make sure you leave enough wheel clearance.
- Until you can drive with this precision, do not attempt to drive outdoors.
- Use caution when driving in new environments.
- Be careful when driving through a doorway.
- Watch out for terrain transitions such as pavement and grass.

3.3. Training Mode and Speed Mode

Training Mode is set to learn how to control the INMOTION SCV better and safer for a new driver; Speed Mode is set to have a better driving experience for a skillful driver. The following chart shows the differences between Training Mode and Speed Mode:

Item	Training Mode	Speed Mode
Characteristics	Slower and Stable	Quicker and Deft
Speed Limit	≤5Km/h	≤15Km/h
Sensitivity	Low	High
Turning(steping on)	Turn only with both feet on	Turn with one foot or both feet on
Turning(steping off)	Turning failure when single foot falling to the ground	Turn when single foot falling to the ground
Exit Balance Mode	Exit Balance Mode when single foot falling to the ground	Exit Balance Mode when both feet falling to the ground

3.4. Assist Mode

In Assist Mode, the system will provide appropriate power to help the driver drag the INMOTION SCV when the driver is unwilling or unable to drive the SCV. The characteristic of the Assisting Function is as below:

- The Assist Mode is activated under any angle, and the INMOTION SCV can turn around in a complete circle on the ground.
- The INMOTION SCV shifts to Speed Mode when either side of the Footboard Mat is stepped on.
- The Assist Mode is disabled and the Sleep Mode is activated when the driver is leaning or shaking the Turning Shaft forward and backward at high speed.
- The Assist Mode is disabled and the Sleep Mode is activated after 2 minutes of taking no action.

See “**SmartKey**” for more information on how to activate the Assist Mode.

3.5. Remote Control Mode

The INMOTION SCV is just like a robot in Remote Control Mode. It can go forward, go backward, turn and stop by remote Control through your APP.

3.5.1. Remote Control

The INMOTION SCV will “stand up” automatically (get itself into a balance status when it is laid back) under manual control mode after the INMOTION SCV and your APP are linked. Now you can control your INMOTION SCV easily by toggling the buttons on and off.

3.5.2. Action Order

INMOTION SCV can execute some simple orders that you designated in your APP. These orders are very easy to master and they are explained as following. By executing orders, your INMOTION SCV can be unique and bring you extra joy.

Speed, Forward/Backward Speed Difference (SD), Duration and Music are four major properties for each action.

If **Speed** is set to 0, **SD** to a positive number, your INMOTION SCV will turn left at the current spot.

If **Speed** is set to a positive number, **SD** to 0, your INMOTION SCV will roll forward.

If **Speed** is set to a positive number, **SD** to a positive number, your INMOTION SCV will turn left while it is rolling forward.

You can set **Duration** and specific **Music** for each action.

INMOTION SCV can do many amazing moves by executing the orders that you combine. This function is not available on INMOTION R1. You can download some default program orders from our website to understand how it works. Refer to your APP for more information.

WARNING!

- Avoid using the Remote Control Mode on slippery and wet surfaces. It may result in slip of the Wheels and cause serious injury or damage.
- Activating the Remote Control Mode in an open area.
- Be careful and avoid passengers and obstacles.

3.6. Self-examination Mode

Self-examination Mode allows you to run an automatic thorough examination of your INMOTION SCV to see if any parameters have changed after a period of operation. INMOTION SCV will run all the above tests under Self-examination Mode and stores the result data. Refer to “Info LED and Sound Prompt” for more information. The following chart shows what the items are detected in the Self-examination Mode:

Item	Description
Steer Balance	Run the Steer Balance calibration if you detect your INMOTION SCV anyway turns to a certain direction when it stands in balance.
Footboard Mat Sensor	Calibrate the Footboard Mat sensors to level up the sensitivity.
RTC Time	Adjust time with assistance of GPRS and GPS.

CAUTION!

- Select an open area when you are about to activate the Self-examination Mode.
- Park the INMOTION SCV on the ground and keep one meter distance.
- Make sure the Handlebar is vertical. Do not pull the Turning Shaft or hold the Handlebar.
- Do not place anything on the Footboard Mat, including your feet.
- Doing so could interfere with the result of self-examination and causing injury or damage.



3.7. Safety Alerts

The INMOTION SCV is equipped with multiple safety alerts. It is important to understand these alerts before you attempt to drive your INMOTION SCV.

3.7.1. Speed Limiter

Because the motor power of INMOTION SCV is limited, when you approach the maximum allowed speed for a given situation, the INMOTION SCV will push the handlebar back to slow you down. The following figure shows the process of speed limiter.

The INMOTION SCV's Speed Limiter is an alert that you are moving too fast. When the INMOTION SCV pushes the

handlebar back, stop leaning forward and slow down. Always leave a gap between yourself and the handlebar to ensure safety and a smoothly driving feeling. When you slow down, INMOTION SCV will balance itself according to your body movements.

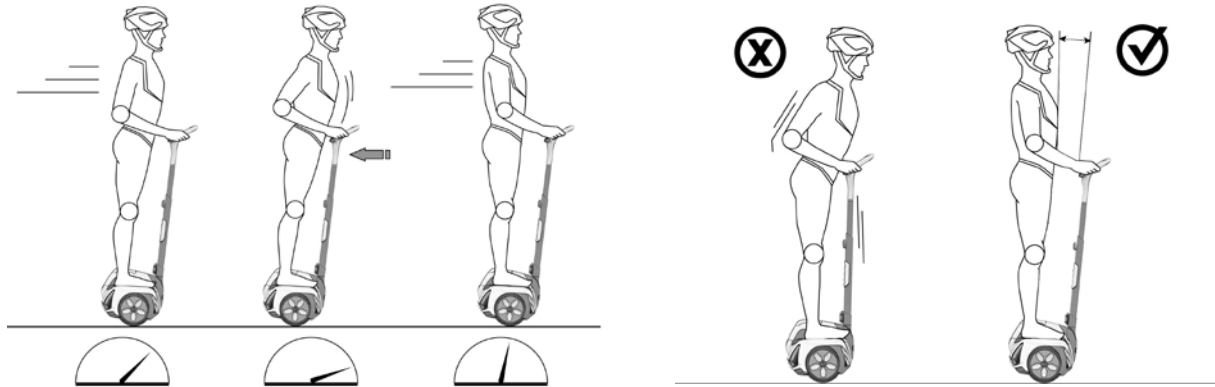

⚠ WARNING!

- Keep accelerating and driving against the Handlebar could cause injury or damage from loss of control, collisions, and falls.
- The speed at which the handlebar pushes back depends on a variety of factors including set-up speed limiter, terrain, payload, Battery condition, etc. These are certain conditions that will trigger the speed limiter.

Continuous Climbing	Motor temperature high
Driving on complicated roads	Circuit temperature high
The moment it powers on	Battery temperature too high or too low
Low battery	Continuous declining

3.7.2. Shaft Shake Warning

One of the ways that the INMOTION SCV notifies you when you are at risk of falling is by shaking the Handlebar and making growling noises.

The following chart shows the situations that trigger Stick Shake Warning and recommended actions:

Possible Causes	Recommended Action
Driving aggressively, accelerating or stopping abruptly.	Drive smoothly.
Driving against the Handlebar to speed up.	Leave a gap between yourself and the handlebar.
Driving on rough terrain or steep slopes.	Drive on smoother and flatter terrain.
Driving backwards too quickly.	Stop, turn in place, and proceed forward.
Safety Shutdown has begun.	Come to a controlled stop and safely step off the Powerbase within 10 seconds.
Pulling the INMOTION SCV too fast in the Assist Mode.	Pull more smoothly and slowly.
Stepping on when Footboard Mat angle is excessive	Step on when the Footboard Mat is lay balanced.

3.7.3. Safety Shutdown

If the INMOTION SCV detects some severe faults or restriction (such as outside specified driving range), it performs a Safety Shutdown.

When a Safety Shutdown occurs, the INMOTION SCV automatically reduces its speed, gives the Stick Shake Warning (shakes the handlebar and makes growling noises), and emits a warning tone.

You have approximately 14 seconds from the start of a Safety Shutdown to come to a controlled stop and step off. After 14 seconds, the INMOTION SCV will immediately shut down when the Wheels reach zero speed.

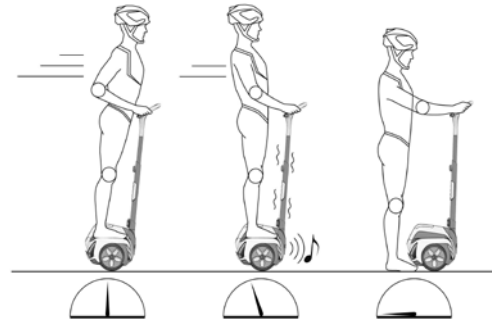

WARNING!

- Never restart and drive your INMOTION SCV after it has indicated an empty Battery condition or performed Safety Shutdown due to low Battery. The INMOTION SCV may not have enough power to keep you balanced, especially if you move strenuously on INMOTION SCV, which needs more power.
- If you restart and continue driving after Safety Shutdown due to low Battery, you risk falling. Also, you risk damaging your Battery Pack, resulting in reduced Battery life and capacity.

3.8. Environmental Factors Affected the Vehicle's Performance

3.8.1. Driving Distance

Driving distance per charge is greatly influenced by driving habits and environmental factors. The following chart shows factors that have great influence:

Factors	Possible Causes
Road Condition	Driving the INMOTION SCV on flat roads will increase driving distance per charge. On the contrary, driving on the hillside or the hollow will decrease driving distance.
Speed and driving habits	Driving the INMOTION SCV with constant speed will increase driving distance per charge. On the contrary, stepping on and off and speeding up and slowing down frequently will decrease driving distance.
Load	Driving the INMOTION SCV under low load will increase driving distance per charge.
Temperature	Driving the INMOTION SCV in a low temperature will decrease driving distance per charge. The INMOTION SCV performs most efficiently when it is close to the center of the recommended driving temperature range.
Battery Condition	Keeping the Battery in a good condition will increase driving distance per charge. Using the old, overload and poorly maintained Battery Pack will significantly decrease driving distance.
Wind Direction	Driving with the wind behind will increase driving distance per charge, and vice versa.

3.8.2. Driving in Hot Temperatures

The temperature of components (including the motor, Battery Pack, driving system, etc.) is raised when driving the INMOTION SCV in hot temperatures. It could affect the INMOTION SCV's service life. If the temperature of components is hot ($\geq 50^{\circ}\text{C}$) while driving, the INMOTION SCV will slow down automatically. The hotter the temperature of components is, the lower the speed will be. If the temperature of components is very hot ($\geq 80^{\circ}\text{C}$) while driving, the INMOTION SCV may activate a safety alert. You should step off and stop driving immediately for a while to lower the temperature of components.

3.8.3. Driving in Cold Temperatures

Too low temperature will deteriorate of lubrication among components and thus increase resistance. Also the battery discharge capability and capacity will decrease dramatically in low temperature environment. Avoid to apply strong moves with your INMOTION SCV in cold temperatures($\leq -5^{\circ}\text{C}$), otherwise can cause the INMOTION SCV to lose control, and you could fall.

3.8.4. Climbing

When the INMOTION SCV is climbing, the inner temperature will increase, especially during long period of continuous climbing. Even though the system will slow down the speed while climbing, we still suggest you to avoid long period of continuous climbing.

3.8.5. Declining

The INMOTION SCV will collect energy while declining, and the motor will work as a power generator to store electricity into the Battery Pack. Thus continuous declining will allow you to travel longer miles.

When the battery is nearly full, the recharge to the battery will cause excessive charge thus cause damage to the battery, therefore the system will automatically lower down the max speed to reduce the possibility of excessive charge.

4. Using the Battery Pack

This chapter describes how to charge and maintain your INMOTION SCV Battery Pack and some safety rules.

4.1. Battery Safety

For your safety and the safety of others, and to maximize Battery Pack life and performance, follow the instructions in this Manual.

CAUTION!

- Do not use the Battery Pack if the casing is broken, emits an unusual odor or excessive heat or leaks any substance.
- Follow the instructions of battery charging and storage, or the Battery Pack could fully discharge over time, causing permanent damage.
- Charging time of the INMOTION SCV is about 5 hours. The charger will power off automatically after it is fully charged.
- Battery Life Cycle is about 500 times. The battery life is drastically reduced over extended periods of time.
- The INMOTION SCV Battery Pack should be charged for 4 hours before the first use.
- Battery charges most efficiently when it is close to the center of the recommended charging temperature range (+10°C ~+30°C).
- It is normal that the Battery Pack become hot after long use.
- Driving in a cold area will reduce battery life.
- Comply with all local and federal and individual country laws when disposing of and transporting the INMOTION SCV Battery Pack.



WARNING!

- Avoid contact with any substance seeping from the Battery Pack.
- Keep Battery Pack out of reach of children and pets. Exposure to Battery voltage could result in injury.
- The cells within the Battery Pack contain toxic substances. Do not attempt to open Battery Pack. Do not insert any object into the Battery Pack or use any device to pry at the Battery Pack casing. If you insert an object into any of the Battery Pack' ports or openings you could suffer electric shock, injury, burns, or cause a fire.
- Only charge the Battery Pack using charging devices approved by INMOTION.
- Use a grounded AC outlet.
- Keep the Charger, Charge Port, Power Cord and AC outlet clean and dry.
- Do not insert the plug if the Charge Port, Power Cord or AC Power outlet is wet.
- Do not heat up the Battery Pack or throw it into fire. Do not put the Battery Pack at high temperature.
- Do not throw the Battery Pack into fire. Put the Battery Pack in a dry place for storage.
- Do not put any conductive object into the Charge Port. It may damage electronic device inside the INMOTION SCV.
- Do not attempt to open the Battery Pack. There are no user-serviceable parts inside.

4.2. Specifications for the Battery Pack

The following chart lists the specifications for the Battery Pack.

Specifications	Item	Note
Battery type	Lithium-ion Battery	①③④ These data are measured with battery capacity of 4 Ah. ② The voltage here refers to lithium battery voltage when the capacity is moderate. The voltage range is 64V~84V.
Charging Time	5 hours ①	
Voltage	72 V ②	
Capacity	4 Ah ③	
Battery Pack Weight	2.5 ± 0.1 Kg ④	
Dimensions(W * D * H)	225*147*82 mm	
Operating Temperature Range	-10 °C ~ 50 °C	
charging Temperature Range	-10 °C ~ 50 °C	
Storage Temperature Range	-20 °C ~ 50 °C	

4.3. Charging the INMOTION SCV

To maximize the performance of your INMOTION SCV Battery Pack, fully charge your Battery Pack for 5 hours, once a month, or after every 12 hours of operation—whichever comes first. Charge your Battery Pack only when they are within the specified charging temperature range.

! WARNING!

- Failure to charge the Battery Pack could result in permanent damage to them. Left unplugged, the Battery Pack could fully discharge over time, causing permanent damage.
- Be sure to use the original charger for INMOTION charging.

4.3.1. Charging Procedures

To charge the Battery Pack:

1. Open the Charge Port of your INMOTION SCV. Verify that the Charge Port is dry.

2. Plug one end of the Power Cord into the Charge Port of your INMOTION SCV with the INMOTION LOGO on the charger facing up. Plug the other end of the Power Cord into an AC outlet (100 V~ 240 V; 50 Hz or 60 Hz).

3. Verify that the Charge Indicator lights are red which indicates the INMOTION SCV is charging. When charging completes (indicator lights turn green), remove the charger from the electrical outlet.

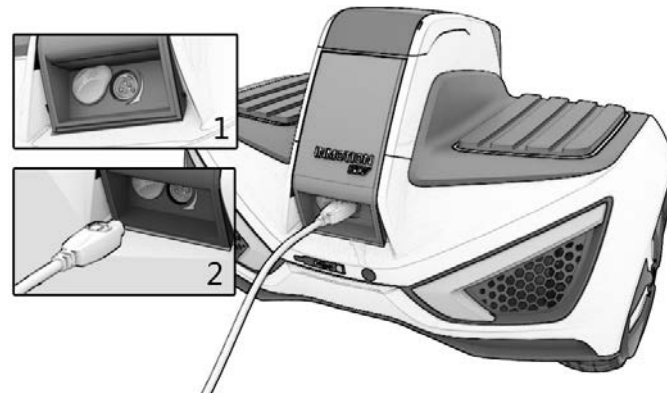

4.3.2. Charging Indicator

The Info LED shows the current battery amount and the next bar of battery gauge in a flashing light to indicate the Battery Pack is charging (for example, the fourth bar is flashing when the current battery amount are 3 bars.).

4.4. Replacing the Battery Pack

The Battery Pack of the INMOTION SCV usually can be used about 500 times. After that, the capacity will reduce to 80%. You need to replace the Battery Pack to ensure the best performance of the INMOTION SCV. You can purchase a back-up Battery Pack to satisfy needs of driving farther in certain occasions. If you need to purchase a back-up Battery Pack, please contact an Authorized INMOTION Dealer or Distributor.

The Battery Pack of the INMOTION SCV is designed to be replaced easily, so you can replace it when necessary.

To replace the Battery Pack:

1. Make sure the INMOTION SCV is unplugged and powered off.
2. Hold the back of the INMOTION SCV with one hand and pull the Battery Pack out from the Battery Slot with another hand. Do not pull it too hard in case the Battery Pack falls on the ground.
3. Keep Battery Pack in a dry place and out of reach of children. You can still charge the Battery Pack after pulling out from the Battery Slot.
4. Shove the Battery Pack into the Battery Slot until you hear a clear chucking. Pull it out gently to see if it is loosen. If it is tighten, press the Reset Button to power on the INMOTION SCV.

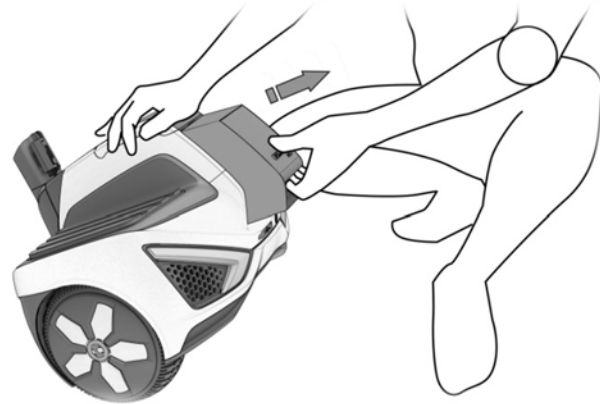

4.5. Transporting Battery Pack

If you are transporting your INMOTION SCV, protect the Battery Pack to avoid damage during shipment. Do not expose the Battery Pack to direct heat or moisture, and avoid heavy vibration during transportation.

WARNING!

- Do not use or transport a Battery Pack if the casing breaks open.
- Lithium-ion Battery Pack are considered Hazardous Materials under shipping regulations. Comply with all local, federal and individual country laws when transporting the INMOTION SCV Battery Pack

The shipping methods of Lithium-ion Battery Pack are as below:

	Ground	Sea	Air
Battery Pack Installed	Allowed	Allowed	Certificates Needed*
Battery Pack Not Installed	Certificates Needed*		
* If you need certificates for transportation, contact INMOTION for relevant certificates on shipping of Battery Pack.			

5. Safe Driving

INMOTION SCV is not only an intelligent and convenient vehicle, but also an entertaining terminal. We hope all INMOTION SCV users can drive it in a safe way and enjoy its convenience and pleasure.

We have to remind you that once the INMOTION SCV is on public roads or places, the driving situations are more complicated, even if you follow all the instructions in User Manual strictly, you may still risk injury from other people's mal driving behaviors.

5.1. Rules that You Must Follow

- Read the User Manual and watch the Safety Videos carefully (you can download them from our website), be familiar with the contents and follow the safety instructions.
- Be familiar with and obey all local laws and regulations, and only drive your INMOTION SCV in places that are allowed.
- Make sure you are sober, have not drunk any alcohol or taken any depressant drugs.
- Wear a helmet, elbow pads and knee caps before driving your INMOTION SCV.
- Wear proper clothes. Do not wear sharp jewelry or high heels to avoid damage or injury.
- The INMOTION SCV's efficient payload is between 25 Kg and 100 Kg. Do not easily attempt to drive it if you are below or beyond this weight range.
- Always make sure the battery is full before driving. If not, do not drive it longer than 5 Km.
- Make sure the Quick Release Lock is locked, the Turning Shaft and the Handlebar is installed properly, and the sockets are not loosened before driving.
- Make sure the INMOTION SCV body is firm before driving, and there is no abnormal noise while driving.

- Adjust the Turning Shaft to a proper height.
- Be aware of the traffic or objects ahead of you, and keep a clear view and wear glasses or contact lens if you don't have right eyesight.
- Keep alert while driving and keep a safe distance from other people or other transportation vehicles.

5.2. Actions that You Must Avoid

- Do not use the INMOTION SCV in forbidden areas according to local laws or regulations.
- Do not drive the INMOTION SCV on motor ways. Some governmental authorities forbid use of sensor control vehicles on public roads and sidewalks. You should consult local authorities to become familiar with applicable laws and regulations before driving.
- Do not modify the components of the INMOTION SCV or drive a modified SCV which will affect its performance or even cause damage.
- Do not drive the INMOTION SCV on slippery roads or in bad weather conditions, such as heavy rainfall, heavy snow and so on.
- Do not drive the INMOTION SCV on uneven roads that are full of sticks, trash or stones.
- Do not drive the INMOTION SCV in dangerous environment, such as road with pits and cracks, steep slopes that are steeper than 15°, water deeper than 3 cm and so on.
- Do not drive the INMOTION SCV in unsafe places where flammable gas, steam, liquid or dust may cause fire or explosion.
- The INMOTION SCV cannot be driven by two or more people at the same time.
- Do not drive the INMOTION SCV on roads unless you are familiar with the operations.
- Children under 14 should not drive the INMOTION SCV alone.

- Pregnant women, heavy drinkers, medicating patients, cardiac patients, mobility-restricted people, the disables and elders who are over 60 should not drive the INMOTION SCV.
- Do not drive the INMOTION SCV with both hands off the Turning Shaft. Do not press your body on the Handlebar.
- Do not move your foot off the Footboard Mat while driving the INMOTION SCV.
- Do not force restart the INMOTION SCV when it shuts off automatically or when the battery ran out, or it will cause falls because of losing balance.
- Do not drive backwards either slow or fast for a long distance. Do not turn when you drive backwards. Do not go down or upstairs or spring off the ground with the INMOTION SCV.
- Do not drive crosswise on steep slopes.
- Do not make or answer phone calls, listen to music, eat or drink while driving. Even checking battery information on the SmartKey or Info LED may distract you.
- Do not break any other rules in the User Manual. Pay special attention to the content in the WARNING or NOTE column.

5.3. Safety Alerts

- If you let others enjoy your INMOTION SCV, make sure that they also have read this User Manual carefully and watched Safety Videos before driving the INMOTION SCV.
- Whenever you drive the INMOTION SCV, please wear a quality helmet that fits your head size, also handle guard, knee cap, waist protector and eye protector are necessary if the driving condition is not clear.
- Please make sure to drive the INMOTION SCV in a well illuminated area. Be cautious and drive slowly if the light is not sufficient. An external LED light is advised to be mounted if necessary.
- You are 23 cm taller when step on the INMOTION SCV. Be careful with the obstacles above you, especially when you

drive to cross doors, door frames, branches, signs and so on.

- Be careful with passengers and children. Slow down when you are near them and let them pass first.
- Keep a distance from the other SCV drivers. Do not drive side by side.
- Remember to control the driving speed and make sure that you are ready to stop anytime.
- Remain relax, slightly bend your elbows and knees, and look straight forward while driving.
- Do not drive the INMOTION SCV backward unless you are trying to avoid obstacles in a few steps.
- Do not pull the Handlebar forward and backward heavily or change your body position drastically. It may cause injury or damage.
- Always leave a fist-width gap between yourself and the Handlebar. Do not lean against the Handlebar or the Turning Shaft because it may cause falls and injury.
- Please step off the INMOTION SCV and charge the Battery Pack when the INMOTION SCV is in low battery and activate the Speed Limiter.
- Do not park the INMOTION SCV in places where traffic will be blocked.
- Do not put anything else on the Footboard Mat.
- Stay where you are and wait for the police when you are in a traffic accident.
- If you need to carry something, you can use the INMOTION Front Bag as a backpack. If you attach the bag on the Handlebar, the total load cannot be over 5 Kg.
- Make sure the INMOTION SCV is powered off before transporting. Use auxiliary parts to transport if necessary. Do not lift the INMOTION SCV from sides of the Tires to avoid fingers being stuck between the case and the Tires.
- Clean and maintain your INMOTION SCV regularly.

6. Operating and Maintaining Your INMOTION SCV

6.1. Lifting Your INMOTION SCV

The INMOTION SCV is designed to be lift conveniently. You can lift it by using the Turning Shaft or the Grip.

6.1.1. Lifting your INMOTION SCV by the Turning Shaft

Lift your INMOTION SCV with one hand by Handle Rubber on the Turning Shaft when necessary.

6.1.2. Lifting your INMOTION SCV by the Metal Grip

Lift your INMOTION SCV with one hand by the Metal Grip when you need to carry it for long distance or carry it without the Turning Shaft.

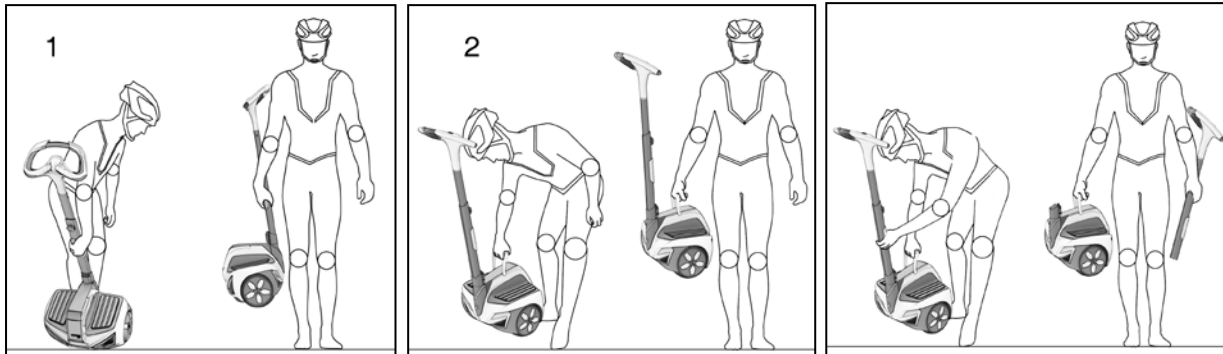

6.2. Cleaning your INMOTION SCV

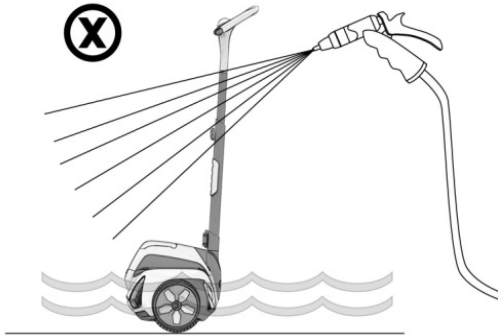

To clean your INMOTION SCV:

- Make sure the INMOTION SCV is unplugged and powered off.
- Always close the Charge Port Cover after charging, and prior to cleaning.
- Gently clean your INMOTION SCV with soap and water and a soft cloth.
- Do not allow water to get into the Charge Port.

⚠ WARNING!

- IP Ratings of the INMOTION SCV is IP65 (Protected against dust - limited ingress). You should not dip it in water, because it may cause permanent damage to the INMOTION SCV.
- Do not use a power washer or high pressure hose to clean your INMOTION SCV.

6.3. Storing Your INMOTION SCV

Store your INMOTION SCV indoors, in a place that is free of moisture, humidity, and temperature extremes. To maximize the performance of your INMOTION SCV Battery Pack, fully charge your Battery Pack before storage, and then fully charge it

once every three months.

6.4. Maintaining Your INMOTION SCV

- Check the Tires and wheels once in a while. Press and shake the Tires to see if they become loosened. If the Tires are loosened, check the sockets and tighten them. Checking the bottom of the Tires to see if they are badly/uneven worn. If they are badly/uneven worn, please contact us to replace them.
- Check the Handlebar once in a while. Tilt the Handlebar fully left and then right. If it is loosened, check the sockets and tighten them.
- Check the quick remove mechanism once in a while. If it is loosened, tighten it.
- Check that parts of outward appearance are in good shape. Parts of outward appearance should be replaced if any part is broken. Please contact us for further maintenance or replacement.

WARNING!

- Do not attempt to open the ABS shell, circuit board and gear box. There are no user-serviceable parts inside.
- You could void your limited warranty, damage your INMOTION SCV, and render it unsafe to use.

7. Troubleshooting the INMOTION SCV

You can troubleshoot certain problems with your INMOTION SCV before contacting an Authorized INMOTION Dealer or Distributor, or INMOTION Customer Care. This chapter provides lists of problems and recommended actions.

The common problems are as below:

- The INMOTION SCV will not power on.
- The INMOTION SCV will not enter Balance Mode.
- The INMOTION SCV is prone to shake.
- The Turning Shaft slips or is off-centered.
- The INMOTION SCV will not power off
- The INMOTION SCV cannot link to your smart phones or tablets.

7.1. Diagnosing Errors with SmartKey

If you are unable to solve the problem, look through the section showing the SmartKey icons that display during error or failure conditions in “**SmartKey**”. If, after reviewing the troubleshooting procedures and the SmartKey icons, you are still unable to resolve the problem, contact an Authorized INMOTION Dealer or Distributor, or INMOTION Customer Care.

Code	Description	Possibly Causes	Recommended Action
27	Age Error	The INMOTION SCV reaches its lifetime or mileage is expired.	Stop using the INMOTION SCV
29	WIFI Error	WIFI is not set properly or the INMOTION SCV cannot get an IP address.	Re-set WIFI, and restart the INMOTION SCV

31	CAN Error	Electric Circuit Failure	Contact INMOTION Customer Care
32	Sensor Error	Sensor Failure	Contact INMOTION Customer Care
33	Excessive Angle	Excessive angle due to road condition or other reasons when the INMOTION SCV is in Balance Mode	Drive the INMOTION SCV following instructions
34	Excessive Speed	Excessive Speed when the INMOTION SCV exits Balance Mode	Slow down the INMOTION SCV till it stops before stepping off
35	Locked and move	The angle or the position is changed when the INMOTION SCV is in Security Mode	Move or use the INMOTION SCV after it is unlocked
46	Battery Access Error	The Battery Pack is not designed by INMOTION or battery failure	Use the INMOTION Battery Pack or contact INMOTION Customer Care
47	Battery Discharge Error	Battery Failure	Contact INMOTION Customer Care
49	Low Battery Voltage	Battery voltage is too low.	Stop using the Battery Pack and charge it
62 63	Unmoral Motor Temperature	Motor temperature or environment temperature is too high or too low.	Stop using the INMOTION SCV and run a rest. Use the INMOTION SCV at the proper temperature.
66 67	Large Motor Electric Current	Overload	Drive the INMOTION SCV following instructions and do not drive it on the rugged surface or precipitous long path.

7.2. The INMOTION SCV Will Not Power On

Recommended Action:

- Make sure your INMOTION SCV's Battery Pack is charged.
- Make sure your SmartKey is charged.
- Make sure you are standing with the SmartKey no further than 5m from your INMOTION SCV.
- Check the SmartKey icons to make sure the SmartKey and your INMOTION SCV are linked.
- Check the SmartKey icons to make sure the INMOTION SCV is not locked.
- If the INMOTION SCV will still not power on, remove the Battery Pack and then reattach it.

7.3. The INMOTION SCV Will Not Enter Balance Mode

Recommended Action:

- Confirm the INMOTION SCV is power on.
- Confirm the Turning Shaft is centered and the Footboard Mat is level.
- Confirm there is no weight on the Footboard Mat.
- Tap the Footboard Mat with your foot without stepping on, then move your foot and tap it with another foot.
- If the INMOTION SCV still will not enter Balance Mode, identify the error icon on the SmartKey.
- If the INMOTION SCV will still not power on, remove the Battery Pack and then reattach it.

7.4. The INMOTION SCV is Prone to Shake

Recommended Action:

- Check the joints between the Handlebar and the Turning Shaft. If they are loosened, tighten them.
- Check the joints between the Handlebar and the Quick Release Lock. If they are loosened, tighten them.
- Check the joints between the Tires and the Wheels. If they are loosened, tighten them.

7.5. The Turning Shaft Slips or is Off-Centered

Recommended Action:

- Step on the Footboard Mat and stand still. If the INMOTION SCV turns to one side automatically, activate the Self-examination Mode.
- Check the Tires and make sure the Tires are not worn. If the Tires are fine, activate the Self-examination Mode.
- Use your APP on smart phones or tablets to adjust steering sensitivity.

7.6. The INMOTION SCV Will Not Power Off

Recommended Action:

- Check the Footboard Mat and make sure there is nothing on it and it is not stuck.
- If the INMOTION SCV still will not power off, lift it upside down (the Handlebar pitched at an angle of 30), and the Wheels will be rolling and then you can shut it down.
- If the INMOTION SCV will still not power off, remove the Battery Pack and then reattach it.
- Press and hold the Power/Standby button on the SmartKey for two seconds to restart the INMOTION SCV and check the SmartKey icons.

7.7. The INMOTION SCV Cannot Link to the APP

Recommended Action:

- Make sure the INMOTION SCV is not powered off. If it is powered off, restart it.
- WIFI system needs 1~2 minutes to initialize.
- If the INMOTION SCV is set to use Dynamic IP Address, to get a dynamic IP address needs 1~2 minutes. (Make sure there is a DHCP server which can effectively distribute IP address.)
- The INMOTION SCV will active AP mode automatically if you have not set up WIFI AP list before. You can manually search your INMOTION SCV SSID via the APP and then connect.

8. Contact and Legal Information

8.1. Report a Problem

If you or any other user of your INMOTION SCV has any problem or suggestion(revise to “if you or other people around you in the use INMOTION SCV has any problems or suggestions), please contact INMOTION Customer Care by email at service@imscv.com.

8.2. How to Reach Us

- INMOTION Technologies Co., Ltd.
- E-mail: service@imscv.com.
- Website: www.imscv.com.

8.3. Obey All Laws and Regulations

The INMOTION SCV is designed as an intelligent transport-aid vehicle, but it is not completely a substitute of the existing transportation vehicle. Do not drive the INMOTION SCV on public roads and sidewalks. If you have to do so, you should consult local authorities before driving to become familiar with applicable laws and regulations.

Federal Communications Commission (FCC) Statement

This device complies with part 15 of the FCC Rules. Operation is subject to the following two conditions: (1) This device may not cause harmful interference, and (2) this device must accept any interference received, including interference that may cause undesired operation.

Note: This equipment has been tested and found to comply with the limits for a Class B digital device, pursuant to part 15 of the FCC Rules. These limits are designed to provide reasonable protection against harmful interference in a residential installation. This equipment generates, uses and can radiate radio frequency energy and, if not installed and used in accordance with the instructions, may cause harmful interference to radio communications. However, there is no guarantee that interference will not occur in a particular installation. If this equipment does cause harmful interference to radio or television reception, which can be determined by turning the equipment off and on, the user is encouraged to try to correct the interference by one or more of the following measures:

- Reorient or relocate the receiving antenna.
- Increase the separation between the equipment and receiver.
- Connect the equipment into an outlet on a circuit different from that to which the receiver is connected.
- Consult the dealer or an experienced radio/TV technician for help.

Warning: Changes or modifications made to this device not expressly approved by **INMOTION Technologies Co., Ltd** may void the FCC authorization to operate this device.

Note: The manufacturer is not responsible for any radio or tv interference caused by unauthorized modifications to this equipment. Such modifications could void the user's authority to operate the equipment.