



Operation and Maintenance Manual for Series QS1L and QS1T Lever In-line Screwdrivers

NOTICE

Series QS1L and QS1T Lever In-line Air Screwdrivers are designed for fastening applications in automotive and appliance assembly, the electronic and aerospace industries and for woodworking.

WARNING



- **IMPORTANT SAFETY INFORMATION ENCLOSED.**
- **READ THIS MANUAL BEFORE OPERATING TOOL.**
- **IT IS THE RESPONSIBILITY OF THE EMPLOYER TO PLACE THE INFORMATION IN THIS MANUAL INTO THE HANDS OF THE OPERATOR.**
- **FAILURE TO OBSERVE THE FOLLOWING WARNINGS COULD RESULT IN INJURY**

PLACING TOOL IN SERVICE

- Always install, operate, inspect and maintain this product in accordance with all applicable standards and regulations (local, state, country, federal, etc.).
- Always use clean, dry air at 90 psig (6.2 bar/620 kPa) maximum air pressure at the inlet. Higher pressure may result in hazardous situations including excessive speed, rupture, or incorrect output torque or force.
- Be sure all hoses and fittings are the correct size and are tightly secured. See Dwg. TPD905-2 for a typical piping arrangement.
- Ensure an accessible emergency shut off valve has been installed in the air supply line, and make others aware of its location.
- Do not use damaged, frayed or deteriorated air hoses and fittings.
- Keep clear of whipping air hoses. Shut off the compressed air before approaching a whipping hose.
- Always turn off the air supply, bleed the air pressure and disconnect the air supply hose before installing, removing or adjusting any accessory on this tool, or before performing any maintenance on this tool or any accessory.
- Do not lubricate tools with flammable or volatile liquids such as kerosene, diesel or jet fuel. Use only recommended lubricants.
- Use only proper cleaning solvents to clean parts. Use only cleaning solvents which meet current safety and health standards. Use cleaning solvents in a well ventilated area.
- Keep work area clean, uncluttered, ventilated and illuminated.
- Do not remove any labels. Replace any damaged label.

USING THE TOOL

- Always wear eye protection when operating or performing maintenance on this tool.
- Always wear hearing protection when operating this tool.
- Always use Personal Protective Equipment appropriate to the tool used and material worked. This may include dust mask or other breathing apparatus, safety glasses, ear plugs, gloves, apron, safety shoes, hard hat and other equipment.
- When wearing gloves always be sure that the gloves will not prevent the throttle mechanism from being released.
- This tool is not designed for working in explosive environments, including those caused by fumes and dust, or near flammable materials.
- This tool is not insulated against electric shock.
- Prevent exposure and breathing of harmful dust and particles created by power tool use.
Some dust created by power sanding, sawing, grinding, drilling and other construction activities contains chemicals known to cause cancer, birth defects or other reproductive harm. Some examples of these chemicals are:
 - lead from lead based paints,

USING THE TOOL (Continued)

- crystalline silica from bricks and cement and other masonry products, and
- arsenic and chromium from chemically treated lumber.

Your risk from these exposures varies, depending on how often you do this type of work. To reduce your exposure to these chemicals: work in a well ventilated area, and work with approved safety equipment, such as those dust masks that are specially designed to filter out microscopic particles.

- Be aware of buried, hidden or other hazards in your work environment. Do not contact or damage cords, conduits, pipes or hoses that may contain electrical wires, explosive gases or harmful liquids.
- Keep others a safe distance from your work area, or ensure they use appropriate Personal Protective Equipment.
- Keep hands, loose clothing, long hair and jewelry away from working end of tool.
- Power tools can vibrate in use. Vibration, repetitive motions or uncomfortable positions may be harmful to your hands and arms. Stop using any tool if discomfort, tingling feeling or pain occurs. Seek medical advice before resuming use.
- Keep body stance balanced and firm. Do not over-reach when operating this tool. Anticipate and be alert for sudden changes in motion, reaction torques, or forces during start up and operation.
- Tool and/or accessories may briefly continue their motion after throttle is released.
- To avoid accidental starting - ensure tool is in "off" position before applying air pressure, avoid throttle when carrying, and release throttle with loss of air.
- Ensure work pieces are secure. Use clamps or vises to hold work piece whenever possible.
- Do not carry or drag the tool by the hose.
- Do not use power tools when tired, or under the influence of medication, drugs, or alcohol.
- Never use a damaged or malfunctioning tool or accessory.
- Do not modify the tool, safety devices, or accessories.
- Do not use this tool for purposes other than those recommended.
- Use accessories recommended by Ingersoll-Rand.
- Note the position of the reversing mechanism before operating the tool so as to be aware of the direction of rotation when operating the throttle.
- Use only bits, sockets and adapters which are in good condition and are intended for use with power tools
- Tools supported on torque reacting balance devices shall have these devices installed to absorb the torque reaction of the tool.
- When a suspension device is used, ensure that it is securely fastened.
- Keep clear of pinch point between reaction bar or support handles and any fixed object in the work area.
- After repair or replacement of parts, tools with automatic shutoff or clutch devices shall be tested to verify that the device is functioning properly.
- Set the air pressure prior to setting the clutch to desired torque. Maintain this pressure during use.
- The Throttle Valve Cap is under pressure from the Throttle Valve Spring. Use care when removing the Throttle Valve Cap.

NOTICE

The use of other than genuine Ingersoll-Rand replacement parts may result in safety hazards, decreased tool performance, and increased maintenance, and may invalidate all warranties.

Repairs should be made only by authorized trained personnel. Consult your nearest Ingersoll-Rand Authorized Servicenter.

WARNING SYMBOL IDENTIFICATION

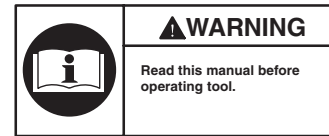
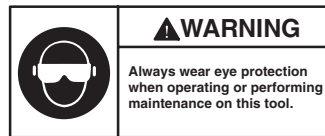
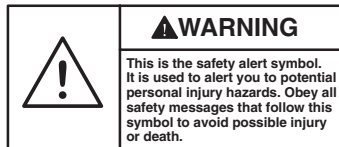

AGENCY SYMBOL IDENTIFICATION

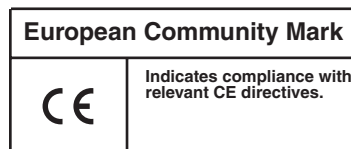

ADJUSTMENTS

CLUTCH ADJUSTMENT



Disconnect the air supply from the Tool before proceeding.

NOTICE

The Clutch Adjusting Hole Cover has a left-hand thread. Rotate the Cover clockwise to loosen or remove the Cover.

1. Unscrew the Clutch Adjusting Hole Cover far enough to expose the clutch adjusting hole in the Clutch Housing.
2. Insert a 1/4" hex wrench into the Bit Holder and rotate the clutch mechanism until the area having an

opening between the faces of the Clutch Adjusting Nut Washer and Clutch Adjusting Nut is visible.

3. Using a screwdriver that has a #1 Phillips tip, insert the tip of the screwdriver into the opening and rotate the screwdriver to adjust the Clutch. Rotate the screwdriver clockwise to decrease Clutch Spring tension and torque and counterclockwise to increase the tension and torque.

NOTICE

The most satisfactory adjustment is usually obtained by using the tool on the actual application and increasing or decreasing the delivered torque until the desired setting is reached. In any event, it is recommended that final adjustment be made by gradual progression.

LUBRICATION



Ingersoll-Rand No. 10



Gearing:
Ingersoll-Rand No. 67
Clutch:
Ingersoll-Rand No. 28

Always use an air line lubricator with this tool.

We recommend the following Filter-Lubricator-Regulator Unit:

Inside USA use FRL unit #C28-04-FKG0-28

Outside USA use FRL unit #C28-C4-FKG0

Whenever the tool is disassembled for maintenance or repair, lubricate the gear train with Ingersoll-Rand No. 67 Grease.

Whenever the tool is disassembled for maintenance or repair, lubricate the clutch assembly with Ingersoll-Rand No. 28 Grease.

INSTALLATION

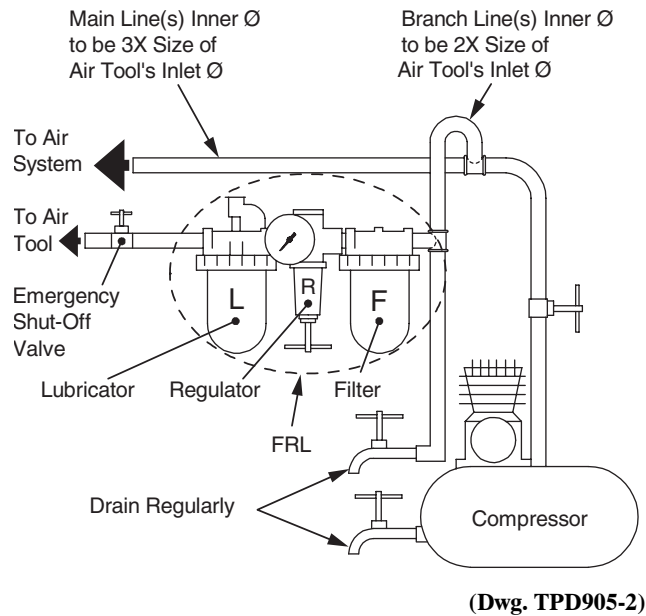

NOTICE

SAVE THESE INSTRUCTIONS. DO NOT DESTROY.

When the life of the tool has expired, it is recommended that the tool be disassembled, degreased and the parts be separated by material so that they can be recycled.

MODEL IDENTIFICATION

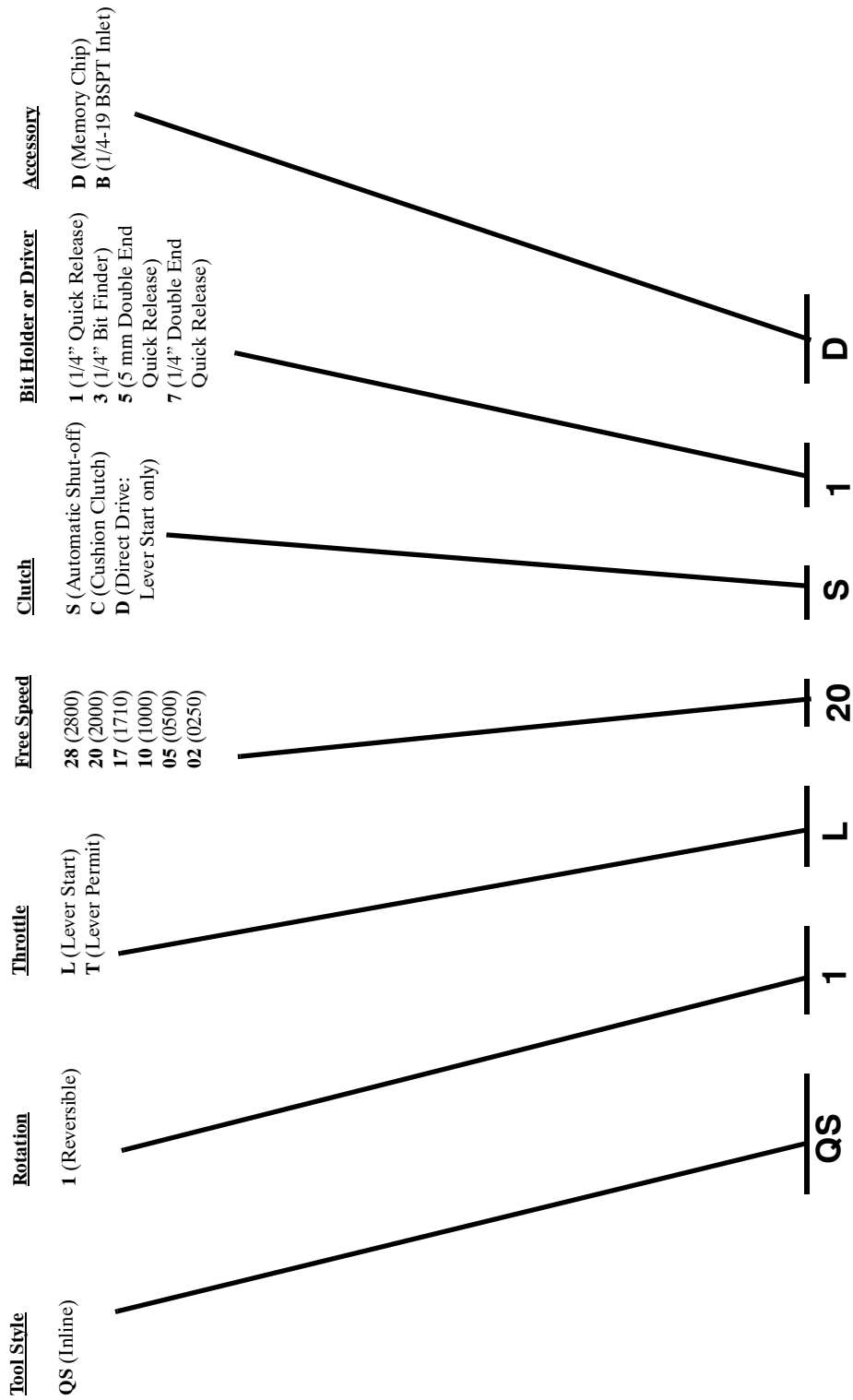

MANUEL D'EXPLOITATION ET D'ENTRETIEN DES VISSEUSES DROITES: SERIES QS1L ET QS1T

AVIS

Les visseuses pneumatiques droites des Séries QS1L et QS1T sont destinées au serrage des fixations : d'assemblage automobile, d'équipements ménagers, d'industries électroniques et aérospatiales du travail du bois.

ADVERTISSEMENT



- D'IMPORTANTES INFORMATIONS DE SECURITÉ SONT JOINTES.
- LIRE CE MANUEL AVANT D'UTILISER L'OUTIL.
- L'EMPLOYEUR EST TENU À COMMUNIQUER LES INFORMATIONS DE CE MANUEL AUX EMPLOYÉS UTILISANT CET OUTIL.
- LE NON RESPECT DES AVERTISSEMENTS SUIVANTS PEUT CAUSER DES BLESSURES.

MISE EN SERVICE DE L'OUTIL

- Installez, exploitez, inspectez et entretenez toujours ce produit conformément à toutes les normes et réglementations (locales, départementales, nationales, fédérales, etc.) en vigueur.
- Utilisez toujours de l'air sec et propre à une pression maximum de 90 psig (6,2 bar, 620kPa). Toute pression supérieure peut créer des situations dangereuses y compris une vitesse excessive, une rupture ou un couple ou effort de sortie incorrect.
- S'assurer que tous les flexibles et les raccords sont correctement dimensionnés et bien serrés. Voir Plan TPD905-2 pour un exemple type d'agencement des tuyauteries.
- Vérifiez qu'un robinet d'arrêt d'urgence accessible a bien été installé dans le circuit d'alimentation d'air et notifier son emplacement à tout le personnel.
- Ne pas utiliser des flexibles ou des raccords endommagés effilochés ou détériorés.
- En cas de rupture ou d'éclatement du flexible d'air ne pas s'approcher. Couper le réseau d'air comprimé avant d'approcher du flexible d'air.
- Coupez toujours l'alimentation d'air comprimé, purgez la pression d'air et débranchez le flexible d'alimentation avant d'installer, déposer ou ajuster tout accessoire sur cet outil, ou d'entreprendre une opération d'entretien quelconque sur l'outil.
- Ne lubrifiez jamais les outils avec des liquides inflammables ou volatils tels que le kérosène, le gasoil ou le carburant d'aviation. Utilisez seulement les lubrifiants recommandés.
- N'utilisez que des solvants de nettoyage appropriés pour nettoyer les pièces. Utilisez seulement les solvants répondant aux réglementations de santé et de sécurité en vigueur. Utilisez les solvants de nettoyage dans une zone adaptée.
- Maintenez le lieu de travail propre, sans obstruction, aéré et bien éclairé.
- Ne retirer aucune étiquette. Remplacer toute étiquette endommagée.

UTILISATION DE L'OUTIL

- Porter toujours des lunettes de protection pendant l'utilisation et l'entretien de cet outil.
- Porter toujours une protection acoustique pendant l'utilisation de cet outil.
- Portez toujours les équipements de protection personnelle adaptés à l'outil utilisé et au matériau travaillé. Ces équipements peuvent être des masques anti-poussière ou autre appareil respiratoire, des lunettes de sécurité, des bouchons d'oreille, des gants, un tablier, des chaussures de sécurité, un casque et d'autres équipements.
- Si vous portez des gants, vérifiez toujours que les gants ne vous empêcheront pas de relâcher le mécanisme de commande.
- Cet outil n'est pas conçu pour fonctionner dans des atmosphères explosives, y compris celles créées par les vapeurs ou les poussières ou près de matériaux inflammables.
- Cet outil n'est pas isolé contre les chocs électriques.

UTILISATION DE L'OUTIL (Continué)

- Evitez toute exposition et respiration des poussières et particules nocives créées par l'emploi de l'outil pneumatique:
Certains poussières produites par les opérations de ponçage, sciage, meulage, perçage et autres activités de construction contiennent des produits chimiques qui sont reconnus comme pouvant causer le cancer, des infirmités de naissance ou d'autres risques à effets nocifs. Parmi ces produits chimiques on trouve:
 - le plomb des peintures à base de plomb,
 - les cristaux de silice contenus dans les briques, le ciment et d'autres produits de maçonnerie, et
 - l'arsenic et le chrome des bois traités chimiquement.Le risque présenté par l'exposition à ces poussières est fonction de la fréquence et du type de travail effectué. Pour réduire l'exposition à ces produits chimiques : travaillez dans une zone bien aérée, et utilisez les équipements de sécurité approuvés, tels que les masques à poussière qui sont spécialement conçus pour filtrer et arrêter les particules microscopiques.
- Soyez conscient des risques, cachés ou autres dans votre environnement de travail. N'entrez jamais en contact avec les câbles, les conduites, les tuyaux ou les flexibles qui pourraient contenir des câbles électriques, des gaz explosifs ou des liquides dangereux.
- Tenez les gens à une distance sûre de la zone de travail ou vérifiez qu'ils utilisent des équipements de protection personnelle appropriés.
- Gardez les mains, vêtements amples, cheveux longs et bijoux éloignés de l'extrémité rotative de l'outil.
- Les outils électriques peuvent vibrer pendant l'usage. Les vibrations, les mouvements répétitifs et les positions inconfortables peuvent causer des douleurs dans les mains et les bras. Cessez d'utiliser les outils en cas d'inconfort, de picotements ou de douleurs. Consultez un médecin avant de recommencer à utiliser l'outil.
- Garder une position équilibrée et ferme. Ne pas se pencher trop en avant pendant l'utilisation de cet outil. Anticiper et prendre garde aux changements soudains de mouvement, couples de réaction ou forces lors du démarrage et de l'exploitation.
- L'outil et/ou les accessoires peuvent continuer à tourner brièvement après le relâchement de la gâchette.
- Pour éviter toute mise en marche accidentelle - vérifiez que l'outil est à la position "arrêt" avant d'appliquer l'air comprimé, évitez de toucher la commande de mise en marche lorsque vous transportez l'outil et relâcher la commande lorsque la pression d'air chute.
- Vérifiez que les pièces à travailler sont fermement fixées. Utilisez des brides ou un étai pour retenir les pièces lorsque possible.
- Ne transportez pas l'outil par son flexible d'air comprimé.
- N'utilisez pas d'outils lorsque vous êtes fatigué ou sous l'influence de médicaments, de drogues ou d'alcool.
- N'utilisez jamais un outil ou accessoire endommagé ou de fonctionnement douteux.
- Ne modifiez jamais l'outil, les dispositifs de sécurité ou les accessoires.
- N'utilisez pas cet outil à des fins autres que celles recommandées.
- Utilisez les accessoires recommandés par Ingersoll-Rand.
- Notez la position du mécanisme d'inversion avant de mettre l'outil en marche de manière à savoir dans quel sens il va tourner lorsque la commande est actionnée.
- Utilisez seulement des embouts, douilles et adaptateur en bon état et destinés aux outils pneumatiques.
- Les dispositifs d'équilibrage réagissant au couple supportant des outils doivent être installés de manière à absorber le couple de réaction de l'outil.
- Lorsqu'un dispositif de suspension est employé, vérifier qu'il est fermement attaché.
- Ne vous approchez pas du point de pincement entre la barre de réaction ou les poignées de support et tout autre objet fixe se trouvant dans la zone de travail.
- Après réparation ou remplacement de pièces, les outils équipés d'arrêt automatique ou de limiteurs doivent être testés pour vérifier que le dispositif fonctionne correctement.
- Réglez la pression d'air avant de régler le limiteur au couple désiré. Maintenez cette pression pendant toute l'utilisation.
- Le chapeau de la soupape de commande est soumis à la pression du ressort de soupape. Prenez les soins nécessaires lors de la dépose du chapeau de soupape de commande.

AVIS

L'utilisation de rechanges autres que les pièces d'origine Ingersoll-Rand peut causer des risques d'insécurité, réduire les performances de l'outil et augmenter l'entretien, et peut annuler toutes les garanties.

Les réparations ne doivent être effectuées que par des réparateurs qualifiés autorisés. Consultez votre Centre de Service Ingersoll-Rand le plus proche.

SIGNIFICATION DES SYMBOLES D'AVERTISSEMENT

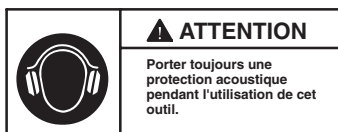
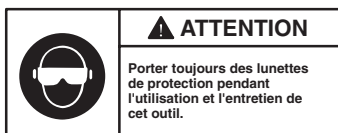
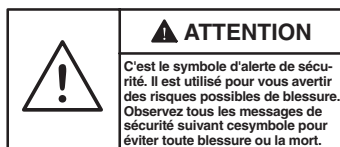

SIGNIFICATION DES SYMBOLES D'AGENCY

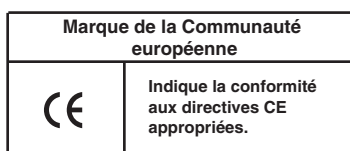

RÉGLAGES

REGLAGE DU LIMITEUR



Débrancher l'alimentation d'air comprimé de l'outil avant d'entreprendre les opérations suivantes.

AVIS

Le capuchon du trou de réglage du limiteur est fileté à gauche. Tourner le capuchon dans le sens horaire pour desserrer ou déposer le couvercle.

1. Dévisser suffisamment la bague pour accéder au trou de réglage du limiteur.
2. Insérer une clé hexagonale de 1/4" dans le porte-embout et tourner le mécanisme du limiteur jusqu'à ce que la zone ayant une ouverture entre les faces de la rondelle et de l'écrou de réglage du limiteur soit visible.

3. A l'aide d'un tournevis Phillips No.1, insérer la lame du tournevis dans l'ouverture et tourner le tournevis pour régler le limiteur. Tourner le tournevis dans le sens horaire pour réduire la tension du ressort du limiteur et le couple, et dans le sens antihoraire pour augmenter la tension et le couple.

AVIS

La meilleure méthode de réglage est normalement obtenue en utilisant l'outil sur l'application requise en augmentant ou en diminuant le couple fourni jusqu'à ce que le réglage désiré soit obtenu. De plus, il est toujours recommandé d'obtenir le réglage final au moyen de réglages progressifs.

LUBRIFICATION



Ingersoll-Rand No. 10



Pignonnerie:
Ingersoll-Rand No. 67
Limiteur:
Ingersoll-Rand No. 28

Utiliser toujours un lubrificateur avec ces outils. Nous recommandons l'emploi du filtre-régulateur-lubrificateur suivant:

Aux États-Unis, utiliser FRL #C28-04-FKG0-28

En dehors des États-Unis, utiliser FRL #C28-C4-FKG0

Lubrifier le train d'engrenages avec de la graisse Ingersoll-Rand No. 67 à **chaque fois que l'outil est démonté pour entretien ou réparation.**

Lubrifier l'ensemble de limiteur avec de la graisse Ingersoll-Rand No. 28 à **chaque fois que l'outil est démonté pour entretien ou réparation.**

INSTALLATION

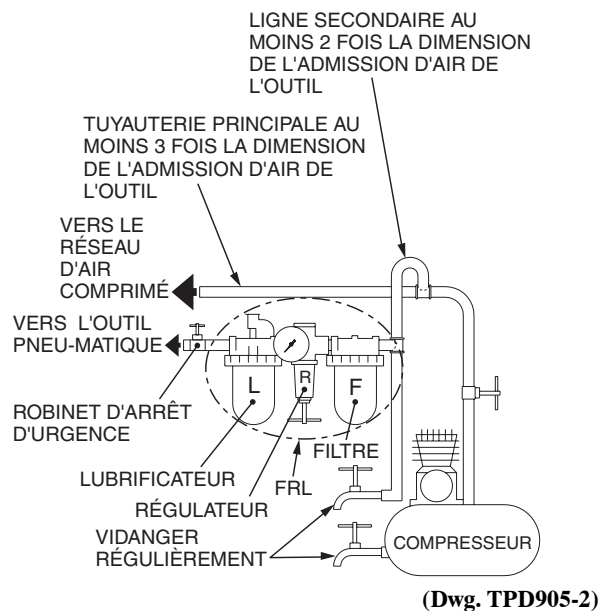

AVIS

CONSERVEZ SOIGNEUSEMENT CES INSTRUCTIONS. NE PAS LES DÉTRUIRE.

A la fin de sa durée de vie, il est recommandé de démonter l'outil, de dégraisser les pièces et de les séparer en fonction des matériaux de manière à ce que ces derniers puissent être recyclés.

IDENTIFICATION DES MODÈS

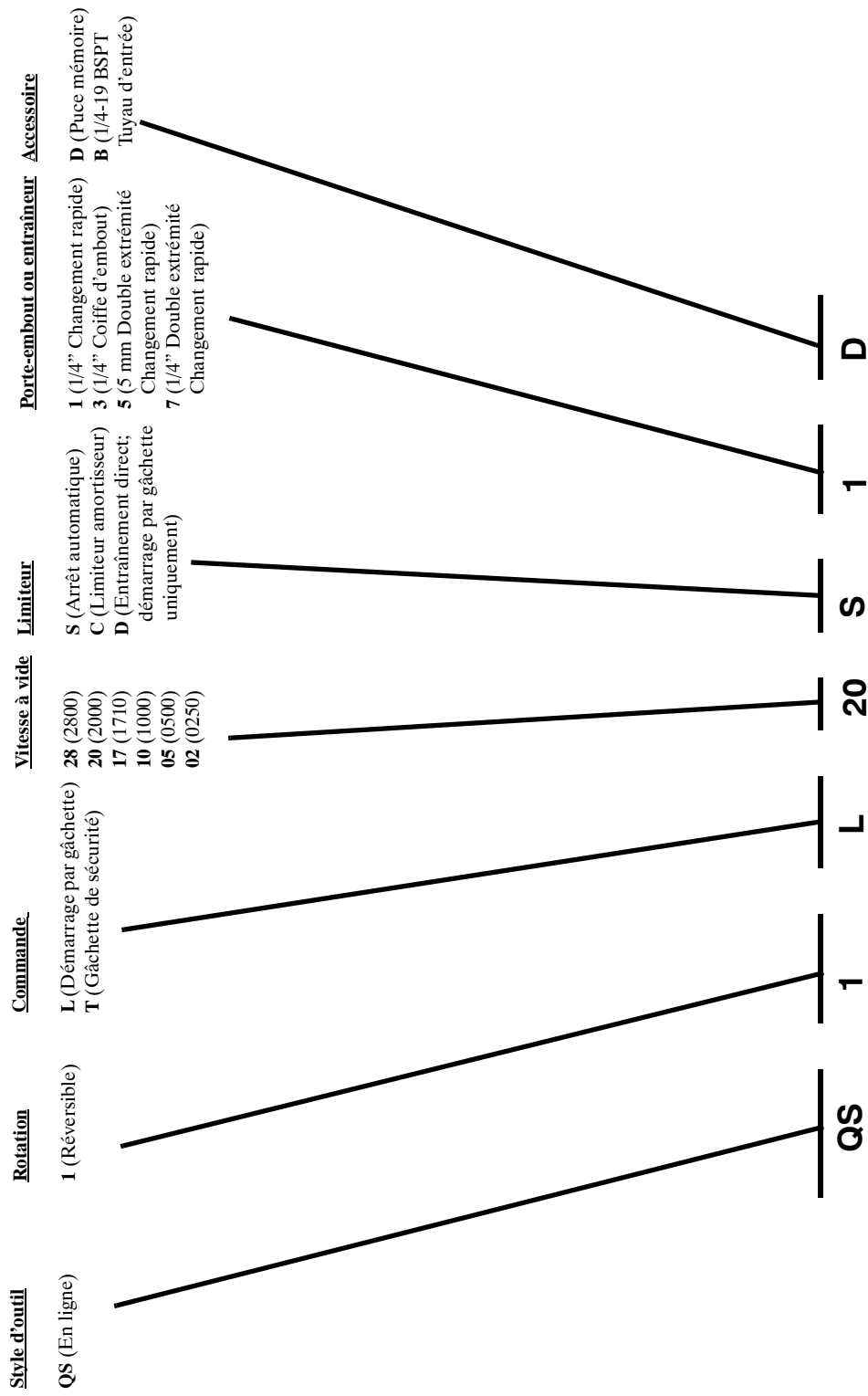



MANUAL DE USO Y MANTENIMIENTO DE LOS ATORNILLADORES RECTOS DE PALANCA DE LAS SERIES QS1L Y QS1T

AVISO

Los atornilladores neumáticos rectos de palanca de las series QS1L y QS1T están diseñados para aplicaciones de montaje en la industria de electrodomésticos, del automóvil, electrónica y aeroespacial, así como para carpintería.

⚠ ADVERTENCIA



- SE ADJUNTA INFORMACION IMPORTANTE DE SEGURIDAD.
- LEA ESTE MANUAL ANTES DE USAR LA HERRAMIENTA.
- ES RESPONSABILIDAD DE LA EMPRESA ASEGURARSE DE QUE EL OPERARIO ESTE AL TANTO DE LA INFORMACION QUE CONTIENE ESTE MANUAL.
- EL HACER CASO OMISO DE LOS AVISOS SIGUIENTES PODRIA OCASIONAR LESIONES.

PARA PONER LA HERRAMIENTA EN SERVICIO

- Instale, utilice, inspeccione y mantenga siempre este aparato de acuerdo con todas las normas locales y nacionales que sean de aplicación.
- Use siempre aire limpio y seco a una presión máxima de 90 psig (6,2 bar/620 kPa) en la admisión. Una presión superior puede redundar en situaciones peligrosas, entre ellas una velocidad excesiva, rotura, o un par o una fuerza de salida incorrectos.
- Asegúrese de que todas las mangueras y accesorios sean del tamaño correcto y estén bien apretados. Vea Esq. TPD905-2 para un típico arreglo de tuberías.
- Cerciórese de que se haya instalado una válvula de corte de emergencia en la línea de suministro de aire y notifique a los demás de su ubicación.
- No utilizar mangueras de aire y accesorios dañados, desgastados ni deteriorados.
- Manténgase apartado de toda manguera de aire que esté dando latigazos. Apague el compresor de aire antes de acercarse a una manguera de aire que esté dando latigazos.
- Corte siempre el suministro de aire, descargue la presión de aire y desconecte la manguera de suministro de aire antes de instalar, desmontar o ajustar cualquier accesorio de esta herramienta, o antes de realizar cualquier operación de mantenimiento de la misma o de un accesorio.
- No lubrique las herramientas con líquidos inflamables o volátiles tales como queroseno, gasoil o combustible para motores a reacción. Use únicamente los lubricantes recomendados.
- Use solamente los disolventes apropiados para la limpieza de las piezas. Use solamente los disolventes de limpieza que cumplan las normas vigentes de salud y seguridad. Los disolventes de limpieza se deben usar en una zona bien ventilada.
- Mantenga la zona de trabajo limpia, despejada, ventilada e iluminada.
- No saque ninguna etiqueta. Sustituya toda etiqueta dañada.

UTILIZACIÓN DE LA HERRAMIENTA

- Use siempre protección ocular cuando maneje, o realice operaciones de mantenimiento en esta herramienta.
- Use siempre protección para los oídos cuando maneje esta herramienta.
- Utilice siempre el equipo de protección individual que corresponda a la herramienta en uso y al material con el que se trabaja. Ello puede incluir una mascarilla contra el polvo u otro aparato de respiración, gafas de seguridad, tapones de oído, guantes, delantal, zapatos de seguridad, casco y otros artículos.
- Cuando use guantes, asegúrese siempre de que estos no eviten que se suelte el mecanismo de mando.
- Esta herramienta no está diseñada para su utilización en ambientes explosivos, incluidos los que son provocados por la presencia de vapores y polvo, o cerca de materiales inflamables.
- Esta herramienta no está aislada contra descargas eléctricas.

Envíe Todos os Comunicados Para o Distribuidor ou Escritório da Ingersoll-Rand Mais Próximo.
© Ingersoll-Rand Company 2003
Impresso nos E.U.A.



UTILIZACIÓN DE LA HERRAMIENTA (Continuado)

- Evite respirar el polvo y partículas nocivos que se producen al utilizar la herramienta, así como exponerse a ellos:
 - Ciertos tipos de polvo que se producen al lijar, seruchar, rectificar o taladrar y durante otras actividades de la construcción contienen sustancias químicas que son conocidos como causantes de cáncer, defectos de nacimiento y otros daños reproductivos. Algunos ejemplos de estas sustancias químicas:
 - el plomo de las pinturas con base de plomo,
 - la sílice cristalina de ladrillos y hormigón y otros productos asociados con la albañilería, y
 - el arsénico y el cromo que produce la madera sometida a tratamientos químicos.
 - El riesgo a la persona que presenta una exposición de este tipo varía en función de la frecuencia con que se realiza esta clase de trabajo. Para reducir la exposición a estas sustancias químicas: trabaje en una zona bien ventilada y utilice equipo de protección homologado, por ejemplo una mascarilla especialmente diseñada para filtrar partículas microscópicas.
- Tenga en cuenta los peligros enterrados, ocultos o de otro tipo en el entorno de trabajo. Tenga cuidado de no hacer contacto con, ni dañar, cables, conductos, tuberías ni mangueras que puedan contener hilos eléctricos, gases explosivos o líquidos nocivos.
- Mantenga a los demás a una distancia segura de la zona de trabajo, o asegúrese de que utilicen el correspondiente equipo de protección individual.
- Mantenga las manos, la ropa suelta, el cabello largo y las alhajas apartados del extremo de trabajo de la herramienta.
- Las herramientas eléctricas pueden vibrar durante el uso. La vibración, los movimientos repetitivos o las posiciones incómodas pueden dañarle los brazos y manos. En caso de incomodidad, sensación de hormigueo o dolor, deje de usar la herramienta. Consulte con el médico antes de volver a utilizarla.
- Mantenga una postura del cuerpo equilibrada y firme. No estire demasiado los brazos al manejar la herramienta. Anticipe y esté atento a los cambios repentinos en el movimiento, pares de reacción u otras fuerzas durante la puesta en marcha y utilización.
- El movimiento de la herramienta y/o los accesorios puede prolongarse brevemente después de soltarse el mando.
- Para evitar el arranque imprevisto de la herramienta, verifique que esté en la posición de desconexión "off" antes de aplicarle aire a presión, evite tocar el mando al transportarla y suelte el mando mientras se descarga el aire.
- Asegúrese de que las piezas a trabajar estén bien sujetas. Siempre que sea posible, utilice mordazas o un tornillo de banco para sostener la pieza.
- No lleve ni arrastre la herramienta sujetándola por la manguera.
- No utilice herramientas eléctricas cuando esté cansado o bajo la influencia de medicamentos, drogas o alcohol.
- No utilice nunca una herramienta o un accesorio dañado o que no funcione correctamente.
- No modifique la herramienta, los dispositivos de seguridad ni los accesorios.
- No utilice esta herramienta para otros fines que no sean los recomendados.
- Utilice únicamente los accesorios Ingersoll-Rand recomendados.
- Tome nota de la posición del mecanismo inversor antes de hacer funcionar la herramienta para tener en cuenta el sentido de rotación al accionar el mando.
- Utilice únicamente puntas, bocas y adaptadores que estén en buen estado y estén previstos para uso con herramientas eléctricas.
- Las herramientas apoyadas en dispositivos equilibradores de reacción de par tendrán estos dispositivos instalados para absorber la reacción de par de la herramienta.
- Cuando se utilice un dispositivo de suspensión, verifique que esté bien asegurado.
- Manténgase apartado de los puntos donde pueda pillarse los dedos entre la barra de reacción o las empuñaduras auxiliares y cualquier objeto fijo que haya en la zona de trabajo.
- Tras reparar o sustituir piezas, las herramientas dotadas de corte automático o dispositivos de embrague se deberán someter a prueba para verificar que el dispositivo funcione correctamente.
- Ajuste la presión del aire antes de ajustar el embrague al par deseado. Mantenga esta presión durante el uso.
- El muelle de la válvula reguladora hace fuerza contra la tapa de dicha válvula. Tenga cuidado al sacar la tapa de la válvula.

AVISO

El uso de piezas de recambio que no sean las auténticas piezas Ingersoll-Rand podría poner en peligro la seguridad, reducir el rendimiento de la herramienta y aumentar los cuidados de mantenimiento necesarios, así como invalidar toda garantía.

Las reparaciones sólo serán realizadas por personal cualificado y autorizado. Consulte con el centro de servicio Ingersoll-Rand autorizado más próximo.

IDENTIFICACIÓN DE SÍMBOLOS DE AVISO

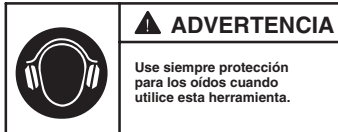
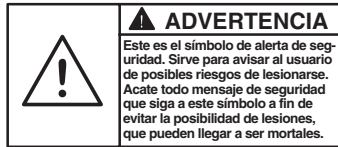

IDENTIFICACIÓN DE SÍMBOLOS EMPLEADOS

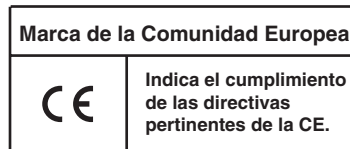

AJUSTES

AJUSTE DE EMBRAGUE



Desconecte el suministro de aire comprimido de la herramienta antes de proceder.

AVISO

La tapa del orificio para ajuste del embrague tiene rosca hacia la izquierda. Gire la tapa hacia la derecha para aflojar o quitarla.

1. Desenrosque la tapa del orificio para ajuste del embrague lo suficiente para que quede expuesto el orificio en la carcasa del embrague.
2. Introduzca una llave exagonal de 1/4" en el portapun-
tas y gire el mecanismo del embrague hasta que quede

visible la zona que tiene una abertura entre las caras de la arandela de la tuerca de ajuste del embrague y de dicha tuerca.

3. Introduzca la punta de un atornillador con punta Philips nº 1 en la abertura y gire el atornillador para ajustar el embrague. Gire el atornillador hacia la derecha para reducir la tensión y el par del muelle del embrague o hacia la izquierda para aumentarlos.

AVISO

Normalmente se obtendrá el mejor ajuste usando la herramienta en trabajo actual e incrementando o disminuyendo el par hasta lograr el ajuste deseado. En cualquier caso, se recomienda hacer el ajuste final por progresión gradual.

LUBRICACION



Ingersoll-Rand No. 10



Engranajes- :
Ingersoll-Rand No. 67
Embrague :
Ingersoll-Rand No. 28

Utilice siempre un lubricador de aire comprimido con estas llaves de impacto. Recomendamos la siguiente unidad de Filtro-Lubricador-Regulador:

Inside USA use FRL unit #C28-04-FKG0-28
Outside USA use FRL unit #C28-C4-FKG0

Cada vez que se desarme la herramienta para realizarle trabajos de mantenimiento o reparación, lubrique el tren de engranajes con grasa Ingersoll-Rand N° 67.

Cada vez que se desarme la herramienta para realizarle trabajos de mantenimiento o reparación, lubrique el conjunto del embrague con grasa Ingersoll-Rand N° 28

INSTALACIÓN

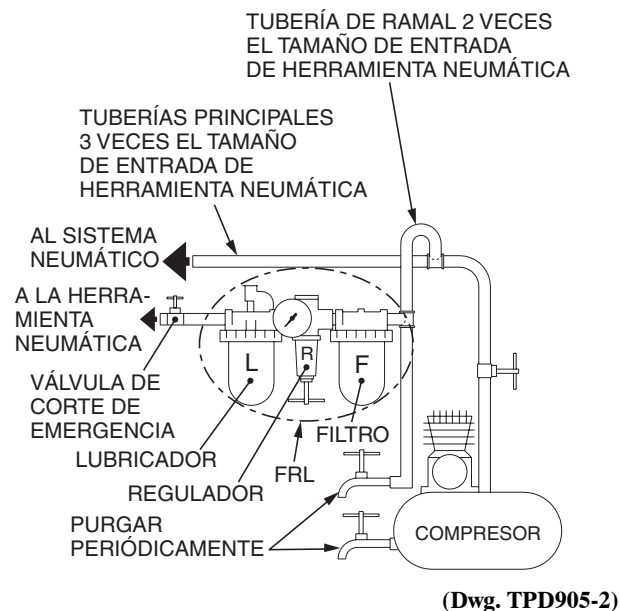

AVISO

GUARDE ESTAS INSTRUCCIONES. NO DESTRUYA.

Una vez vencida la vida útil de herramienta, se recomienda desarmar la herramienta, desengrasarla y separar las piezas de acuerdo con el material del que están fabricadas para reciclarlas.

IDENTIFICACIÓN DE MODELOS

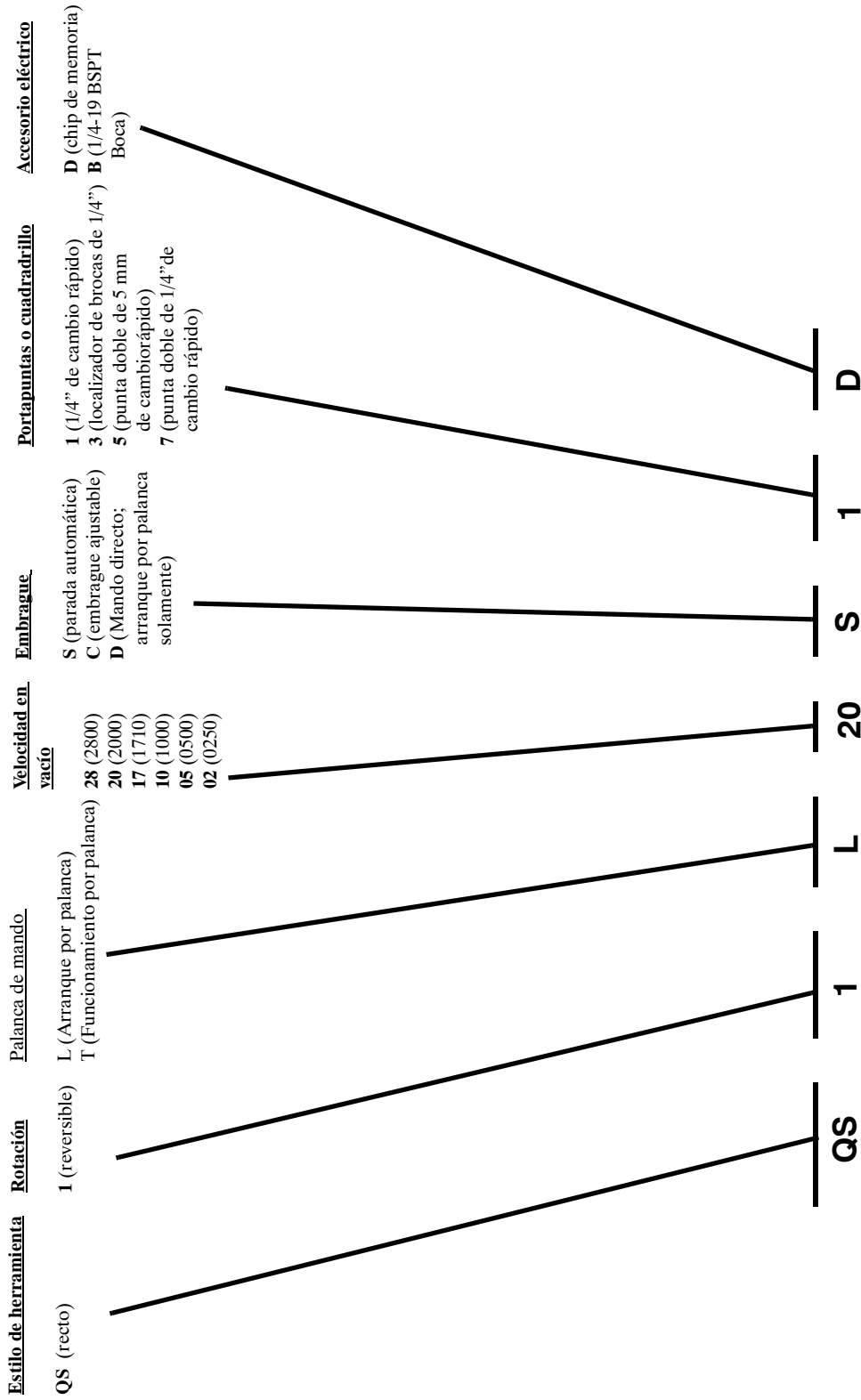

MANUAL DE FUNCIONAMENTO E MANUTENÇÃO PARA AS APARAFUSADORAS EM LINHA DE ALAVANCA DAS SÉRIES QS1L E QS1T

NOTA

As Aparafusadoras em Linha de Alavanca das Séries QS1L e QS1T são concebidas para aplicações de fixação na montagem de automóveis e aparelhos, nas indústrias electrónica e aeroespacial e em carpintaria.

AVISO

- INFORMAÇÃO DE SEGURANÇA IMPORTANTE EM ANEXO.
- LEIA ESTE MANUAL ANTES DE OPERAR A FERRAMENTA.
- É DA RESPONSABILIDADE DO EMPREGADOR COLOCAR A INFORMAÇÃO DESTE MANUAL NAS MÃOS DO OPERADOR.
- O NÃO CUMPRIMENTO DAS SEGUINTE ADVERTÊNCIAS PODE RESULTAR EM FERIMENTOS.



COLOCANDO A FERRAMENTA EM FUNCIONAMENTO

- Instale, opere, inspeccione e faça manutenção neste produto sempre de acordo com todas as normas e regulamentos aplicáveis (locais, estatais, federais, nacionais etc.).
- Utilize sempre ar limpo e seco a uma pressão máxima de 6,2 bar na admissão. Pressão mais alta pode resultar em situações perigosas incluindo velocidade excessiva, ruptura ou binário ou força de saída incorrectos.
- Certifique-se de que todas as mangueiras e acessórios são da dimensão correcta e que estão seguros firmemente. Consulte o Des. TPD905-2 para uma disposição de tubos típica.
- Certifique-se de que foi instalada uma válvula de isolamento de emergência acessível na linha de alimentação de ar e informe os outros sobre a sua localização.
- Não utilize mangueiras de ar e acessórios danificados, puídos ou deteriorados.
- Mantenha-se afastado de mangueiras de ar a chicotear. Desligue o compressor antes de se aproximar de uma mangueira de ar a chicotear.
- Desligue sempre a alimentação de ar, liberte a pressão do ar e desligue a mangueira de alimentação de ar antes de instalar, retirar ou ajustar qualquer acessório desta ferramenta, ou antes de realizar qualquer tipo de manutenção nesta ferramenta ou em qualquer acessório.
- Não lubrifique a ferramenta com líquidos inflamáveis ou voláteis como querosene, gasóleo ou combustível para jactos. Utilize apenas os lubrificantes especificados.
- Utilize apenas solventes de limpeza adequados para limpar as peças. Utilize apenas solventes de limpeza que obedeçam às normas correntes de saúde e segurança no trabalho. Utilize solventes numa área bem ventilada.
- Mantenha a área de trabalho limpa, em ordem, ventilada e bem iluminada.
- Não retire nenhum rótulo. Substitua os rótulos danificados.

USANDO A FERRAMENTA

- Use sempre protecção para os olhos ao operar ou fazer manutenção nesta ferramenta.
- Use sempre protecção auricular ao operar esta ferramenta.
- Utilize sempre equipamento de protecção pessoal apropriado para a ferramenta utilizada e o material de trabalho. Isso pode incluir máscara contra a poeira ou outro aparelho de respiração, óculos de segurança, auriculares, luvas, avental, calçado de segurança, capacete e outro equipamento.
- Quando usar luvas, certifique-se de que as mesmas não impedirão a libertação do mecanismo do regulador.
- Evite expor-se e respirar as poeiras e partículas nocivas criadas pela utilização de ferramentas motorizadas:
Algumas poeiras criadas por operações motorizadas de lixar, serrar, rectificar, perfurar e outras actividades de construção contêm produtos químicos conhecidos por causarem cancro, malformações congénitas e terem efeitos nocivos na reprodução. Alguns exemplos desses produtos químicos são:

USANDO A FERRAMENTA (Continuado)

- chumbo de tintas à base de chumbo,
- sílica cristalina de tijolos e cimento e outros produtos de alvenaria e
- arsénico e crómio de madeira tratada quimicamente

Os riscos dessas exposições varia, dependendo de com que frequência faz esse tipo de trabalho. Para reduzir a sua exposição a esses produtos químicos: trabalhe numa área bem ventilada e com equipamento de segurança aprovado, como as máscaras contra a poeira que são especialmente projectadas para filtrar partículas microscópicas.

- Mantenha terceiros a uma distância segura da sua área de trabalho ou certifique-se de que os mesmos estão a usar equipamento de protecção pessoal.
- Esta ferramenta não é concebida para trabalhar em ambientes explosivos, incluindo os provocados por vapores e poeira ou perto de materiais inflamáveis.
- Esta ferramenta não é isolada contra choque eléctrico.
- Tenha em conta a possível presença de perigos enterrados, ocultos e outros no seu ambiente de trabalho. Não contacte ou danifique cabos, condutas, tubos ou mangueiras que possam conter fios eléctricos, gases explosivos ou líquidos perigosos.
- Mantenha as mãos, roupas soltas, cabelos longos e jóias afastados da extremidade de trabalho da ferramenta.
- As ferramentas mecânicas podem vibrar durante a utilização. Vibração, movimentos repetitivos ou posições desconfortáveis podem ser nocivos às suas mãos e braços. Pare de utilizar qualquer ferramenta se sentir desconforto, sensação de formigueiro ou dor. Procure assistência médica antes de reiniciar a utilização.
- Mantenha o corpo numa posição equilibrada e firme. Não estique o corpo ao operar esta ferramenta. Esteja preparado e alerta para mudanças súbitas no movimento, binários ou forças de reacção durante o arranque e o funcionamento.
- A ferramenta e/ou acessórios podem continuar o movimento por um curto período depois que o regulador é libertado.
- Para evitar o arranque acidental, certifique-se de que a ferramenta está na posição desligada ("off") antes

de aplicar pressão de ar, evite apertar o regulador ao transportar a ferramenta e liberte o regulador durante a perda de ar.

- Certifique-se de que as peças de trabalho estão seguras. Sempre que possível, utilize grampos ou tornos para fixar a peça de trabalho.
- Não transporte ou arraste a ferramenta pela mangueira.
- Não utilize ferramentas mecânicas quando estiver cansado ou sob a influência de drogas, álcool ou medicamentos.
- Nunca utilize uma ferramenta ou acessório avariado ou a funcionar mal.
- Não modifique a ferramenta, os dispositivos de segurança ou os acessórios.
- Não utilize esta ferramenta para fins diferentes dos recomendados.
- Use os acessórios recomendados pela Ingersoll-Rand.
- Note a posição do mecanismo de inversão antes de operar a ferramenta de forma a estar ciente da direcção de rotação ao operar o regulador.
- Utilize apenas pontas, brocas, tomadas e adaptadores que estejam em bom estado e que foram concebidos para utilização com ferramentas mecânicas.
- As ferramentas suportadas em dispositivos de compensação de binário de reacção devem ter estes dispositivos instalados para absorver o binário de reacção da ferramenta.
- Quando for utilizado um dispositivo de elevação, certifique-se de que está preso com segurança.
- Mantenha-se afastado do ponto de aperto entre a barra de reacção ou punhos de apoio e qualquer objecto fixo na área de trabalho.
- Após reparar ou substituir peças, as ferramentas com dispositivos de desligamento automático ou de embraiagem devem ser testadas para confirmar que o dispositivo está a funcionar adequadamente.
- Ajuste a pressão do ar antes de ajustar a embraiagem para o binário desejado. Mantenha esta pressão durante a utilização.
- A tampa da válvula do regulador está sob pressão da mola da válvula do regulador. Tome cuidado ao retirar a tampa da válvula do regulador.

NOTA

O uso de peças de substituição que não sejam genuinamente da Ingersoll-Rand podem resultar em riscos de segurança, diminuição do desempenho da ferramenta, aumento da necessidade de manutenção e pode invalidar todas as garantias.

As reparações devem ser feitas somente por pessoal treinado autorizado. Consulte o Centro de Serviços da Ingersoll-Rand mais próximo.

IDENTIFICAÇÃO DO SÍMBOLO DE AVISO

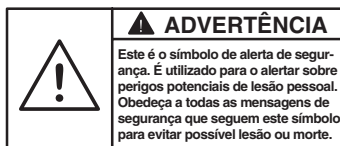

IDENTIFICAÇÃO DO SÍMBOLO DA AGÊNCIA

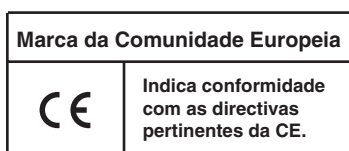

AJUSTES

AJUSTE DA EMBRAIAGEM



Desconecte a alimentação de ar da Ferramenta antes de prosseguir.

NOTA

A tampa do orifício de ajuste da embraiagem tem a rosca à esquerda. Rode a tampa para a direita para desapertar e remover a tampa.

1. Desaperte a tampa do orifício de ajuste da embraiagem o suficiente para expor este orifício na carcaça da embraiagem.
2. Introduza uma chave sextavada de 1/4" no porta-brocas e rode o mecanismo da embraiagem até a área que

tem uma abertura entre as faces da anilha da porca de ajuste da embraiagem e da porca de ajuste da embraiagem ficar visível.

3. Introduza a ponta de uma chave de fendas Phillips N° 1 na abertura e rode a chave de fendas para ajustar a embraiagem. Rode a chave para a direita para reduzir a tensão e o binário da mola da embraiagem e para a esquerda para aumentar a tensão e o binário.

NOTA

O ajuste mais satisfatório é usualmente obtido ao utilizar a ferramenta na aplicação real e aumentando ou diminuindo o torque exercido até que o ajuste desejado seja atingido. Em qualquer caso, é recomendado que o ajuste final seja feito em progressivamente.

LUBRIFICAÇÃO



Ingersoll-Rand No. 10



Engrenagem:
Ingersoll-Rand No. 67
Embraiagem:
Ingersoll-Rand No. 28

Use sempre um lubrificador de ar de linha com estas ferramentas. Nós recomendamos a seguinte Unidade Filtro-Lubrificador-Regulador:

Unidade interna do uso FRL dos EUA # C28-04-FKG0-28
Unidade exterior do uso FRL dos EUA # C28-c4-FKG0

Sempre que a ferramenta for desmontada para manutenção ou reparação, lubrifique o trem de engrenagens com Massa Ingersoll-Rand Nº 67.

Sempre que a ferramenta for desmontada para manutenção ou reparação, lubrifique o conjunto da embraiagem com Massa Ingersoll-Rand Nº 28.

INSTALAÇÃO

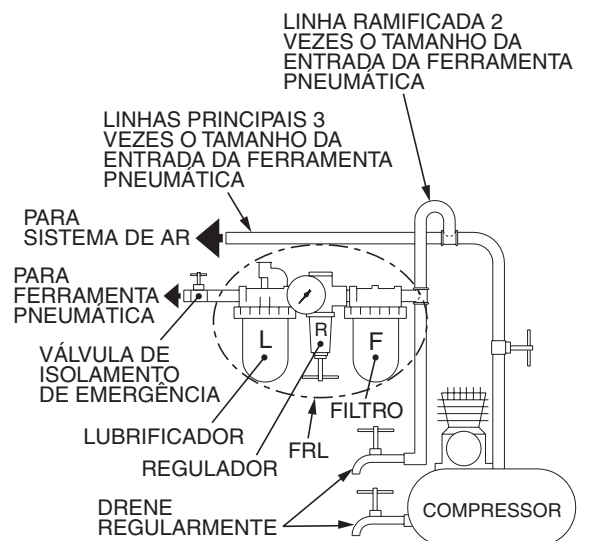

(Dwg. TPD905-2)

NOTA

GUARDE ESTAS INSTRUÇÕES. NÃO AS DESTRUA.

Quando a duração de uma ferramenta expirar, recomenda-se que a mesma seja desmontada, desengraxada e que as peças sejam agrupadas conforme seu material e assim possam ser recicladas.

This Page intentionally left Blank

SERIES QS1L AND QS1T LEVER INLINE MOTOR AND GEARING

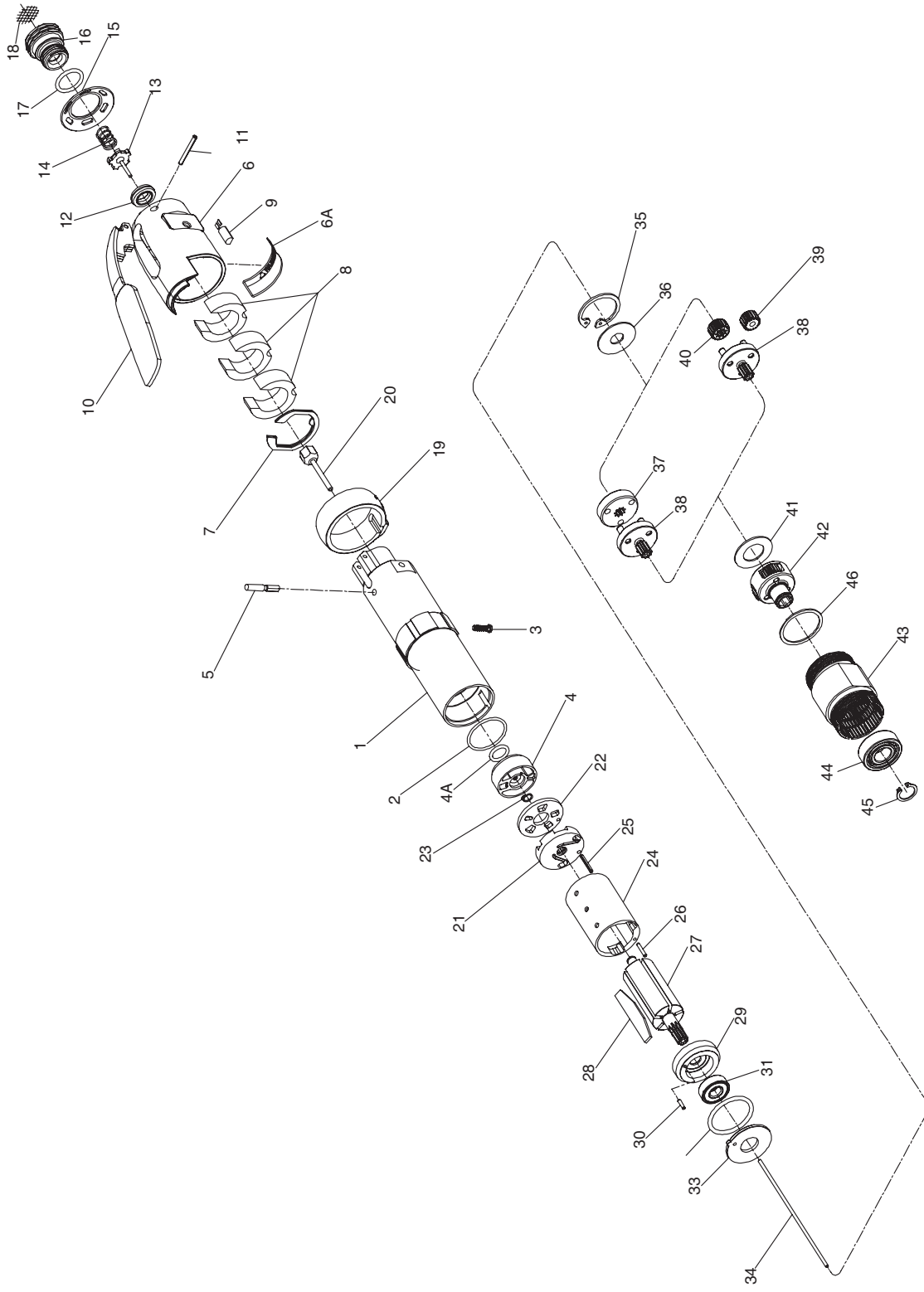

(Dwg. TPA1757-1)

SERIES QS1L AND QS1T LEVER INLINE MOTOR AND GEARING



When Ordering, use applicable Part Number

Item	Parts Description	Part Number	Item	Parts Description	Part Number
1	Motor Housing	TRL-40	22	Rear End Plate Face Plate	TRH-12-2
2	Housing O-ring	TRH-104	23	Rear End Plate Assembly Retainer	8SL-305
3	Housing Screw	TRH-330	24	Cylinder Assembly	TRH-A3
4	Reverse Valve Assembly for Models with an Automatic Shutoff Valve	TRH-A329	25	Cylinder Rear Alignment Pin	TRH-98
	for Models with an Automatic Shutoff Valve	TRH-A329	26	Cylinder Front Alignment Pin	TRH-98-1
4A	Reverse Valve Seal	TRH-A3291		Rotor for Models with an Automatic Shutoff Valve	TRH-53
5	Throttle Plunger	RLA-159		for Models without an Automatic Shutoff Valve	TRD-53
6	Back Cap	TRL-2311	28	Vane Packet (set of 5 Vanes)	TRH-42-5
6A	Warning Label (for direct drive models only)	TRL-99	29	Front End Plate Assembly	TRH-A11
7	Back Cap Gasket	TRL-A283	30	End Plate Alignment Pin	TRH-98-2
8	Muffler Element (3)	TRL-311	31	Front Rotor Bearing	TRH-24
9	Memory Chip (for models with memory chip only)	TRH-800	32	Motor Seal	TRH-211
10	Throttle Lever	TRL-274	33	Motor Clamp Washer	TRH-207
11	Throttle Lever Pin	TRL-98	34	Push Rod (for Models with an Automatic Shutoff Valve)	TRH-425
12	Throttle Valve Seat	TRH-303	35	Gear Retainer	TRH-28
13	Throttle Valve	TRD-A302	36	Gear Head Spacer	TRH-81
14	Throttle Valve Spring	TRL-51	37	Planet Gear Head Drive Plate (for Series QS1L28 and QS1T28)	TRH-17
15	Exhaust Diffuser	TRH-123		Planet Gear Head Assembly (includes gear shafts) for Series QS1L02, QS1T02 QS1L05, QS1T05, QS1L10, QS1T10, QS1L28 and QS1T28	TRH-A2169-16
16	Inlet Bushing Assembly for 1/4-18 NPT thread for 1/4-19 BSPT thread	TRH-A465 TRH-A465-B AF120-290	38	for Series QS1L17, QS1T17, QS1L20C and QS1T20C	TRH-A2169-12
17	Inlet Bushing Seal	TRH-61		for Series QS1L20S, QS1T20S and QS1L20D	TRH-A2169-10
18	Inlet Screen	TRH-273			
19	Reverse Lever	TRH-A435			
20	Automatic Shutoff Valve (for all Models with a Shutoff Clutch and Lever Permit Models with a Cushion Clutch)	TRH-A12-1			
21	Rear End Plate Assembly (includes rear rotor bearing)				

Continued to next page

SERIES QS1L AND QS1T LEVER INLINE MOTOR AND GEARING



When Ordering, use applicable Part Number

Item	Parts Description	Part Number	Item	Parts Description	Part Number
39	Planet Gear (3 for each Gear Head) for Series QS1L02, QS1T02, QS1L05, QS1T05, QS1L10 and QS1T10 for Series QS1L17, QS1T17, QS1L20C and QS1T20C for Series QS1L20S, QS1T20S and QS1T20D	TRH-10-16 TRH-10-12 TRH-10-10	42	Spindle Assembly (includes all spindle gearing) for Series QS1L02, QS1T02, QS1L05, QS1T05, QS1L28 and QS1T28 for Series QS1L10, QS1T10, QS1L17, QS1T17, QS1L20S, QS1T20S and QS1L20D for Series QS1L20C, QS1T20C	TRH-A8-16 TRH-A8-12 TRH-A8-10 TAH-37 TRH-510 I20A4-588 TRH-208 7L-365 LGI-K284
40	Gear Head Pinion for Series QS1L17, QS1T17, QS1L20C and QS1T20C for Series QS1L20S, QS1T20S and QS1L20D	TRH-17-18 TRH-17-21 TRH-82	43 44 45 46 * *	Gear Case Spindle Bearing Spindle Bearing Retaining Ring Spindle Bearing Seat Suspension Bail Piped-Away Exhaust Kit (optional)	
41	Planet Gear Head Spacer				

* Not Illustrated.

This Page intentionally left Blank

SERIES QS1L AND QS1T LEVER INLINE CLUTCHES

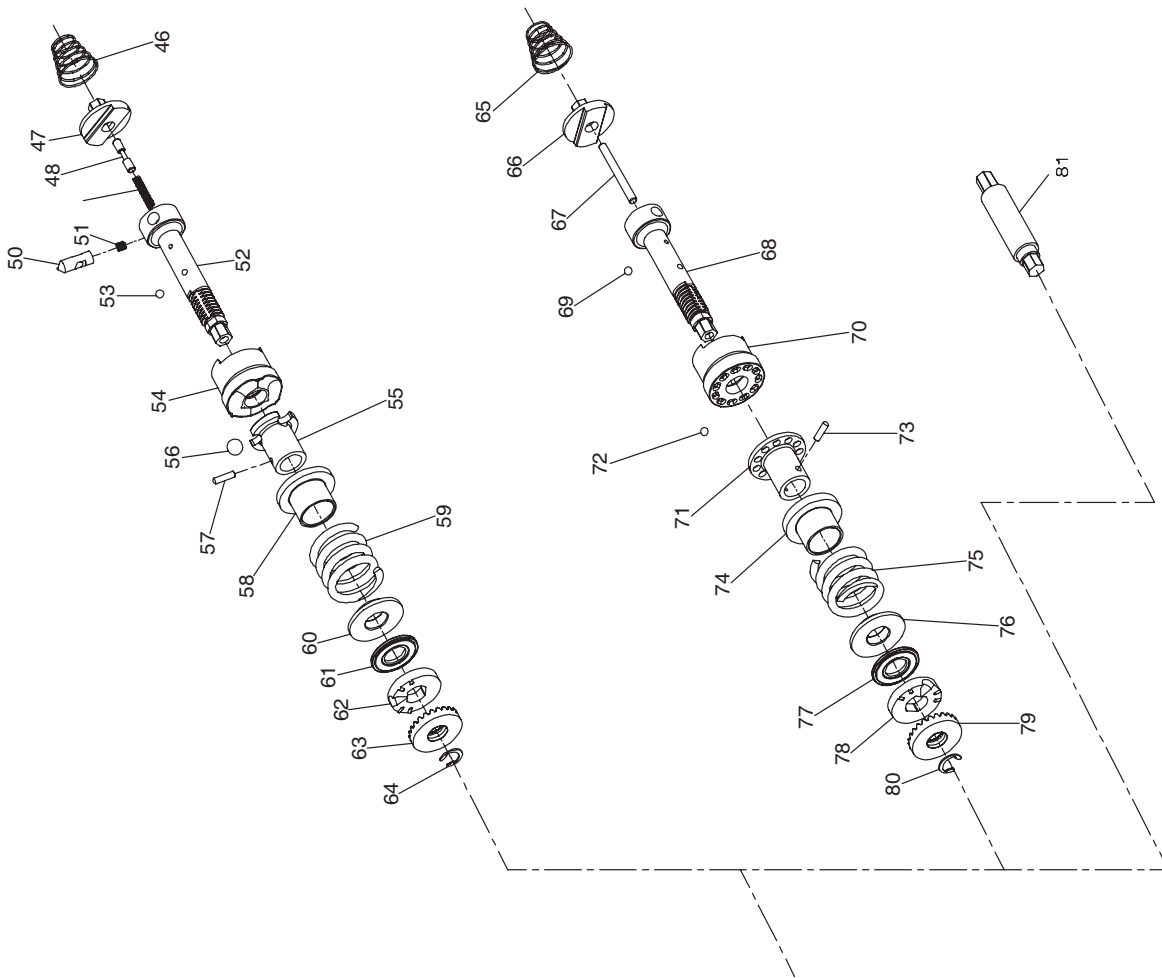

(Dwg. TPA1758)

SERIES QS1L AND QS1T LEVER INLINE CLUTCHES



When Ordering, use applicable Part Number

Item	Parts Description	Part Number	Item	Parts Description	Part Number
46	Automatic Shutoff Clutch Assembly with heavy clutch spring (standard)	TRH-AH579	65	with medium clutch spring	TRH-AM579-C
47	with medium clutch spring	TRH-AM579	66	with light clutch spring	TRH-AL579-C
48	with light clutch spring	TRH-AL579	67	Clutch Return Spring	TRH-405
49	Clutch Return Spring	TRH-405	68	Clutch Input Driver	TRH-103
50	Clutch Input Driver	TRH-103	69	Clutch Pushrod	TRH-236-C
51	Automatic Shutoff Plunger	TRH-408	70	Clutch Shaft	TRH-502
52	Automatic Shutoff Return Spring	TRH-420		Clutch Ball (1/8" diameter) (12)	AV1-255
53	Automatic Shutoff Pin	TRH-704		Cam Jaw	
54	Automatic Shutoff Pin Spring	TRH-407		for Series QS1T02, QS1L02, QS1T05, QS1L05, QS1T10 and QS1L10	TRH-721-C
55	Clutch Shaft	TRH-502		for Series QS1T17, QS1L17, QS1T20, QS1L20, QS1T28 and QS1L28	TRH-722-C
56	Clutch Ball (1/8" diameter) (12)	AV1-255	71	Clutch Cam Ball Driver	TRH-581-C
57	Cam Jaw	TRH-721	72	Clutch Cam Ball (1/8" diameter) (11)	AV1-255
58	Clutch Cam Ball Driver	TRH-581	73	Clutch Cam Ball Driver Retaining Pin	TRH-188
59	Clutch Cam Ball (1/4" diameter) (3)	4U-722	74	Cam Ball Seat	TRH-627-C
60	Clutch Driver Retaining Pin	TRH-188	75	Clutch Spring	
61	Cam Ball Seat	TRH-627		heavy (green)	TRH-H583
62	Clutch Spring			medium (red)	TRH-M583
63	heavy (green)	TRH-H583		light (orange)	TRH-XL583
64	medium (red)	TRH-M583	76	Spring Seat	TRH-623
	light (orange)	TRH-XL583	77	Thrust Bearing	161A32-105
	Spring Seat	TRH-623	78	Clutch Adjusting Nut Washer	TRH-582
	Thrust Bearing	161A32-105	79	Clutch Adjusting Nut	TRH-588
	Clutch Adjusting Nut Washer	TRH-582	80	Clutch Adjusting Nut Stop	3S3-701
	Clutch Adjusting Nut	TRH-588	81	Clutch Shaft (for Models with Direct Drive only)	TRH-786
	Clutch Adjusting Nut Stop	3S3-701			
	Cushion Clutch Assembly				
	with heavy clutch spring (standard)	TRH-AH579-C			

SERIES QS1L AND QS1T LEVER INLINE GRIP AND BIT DRIVERS

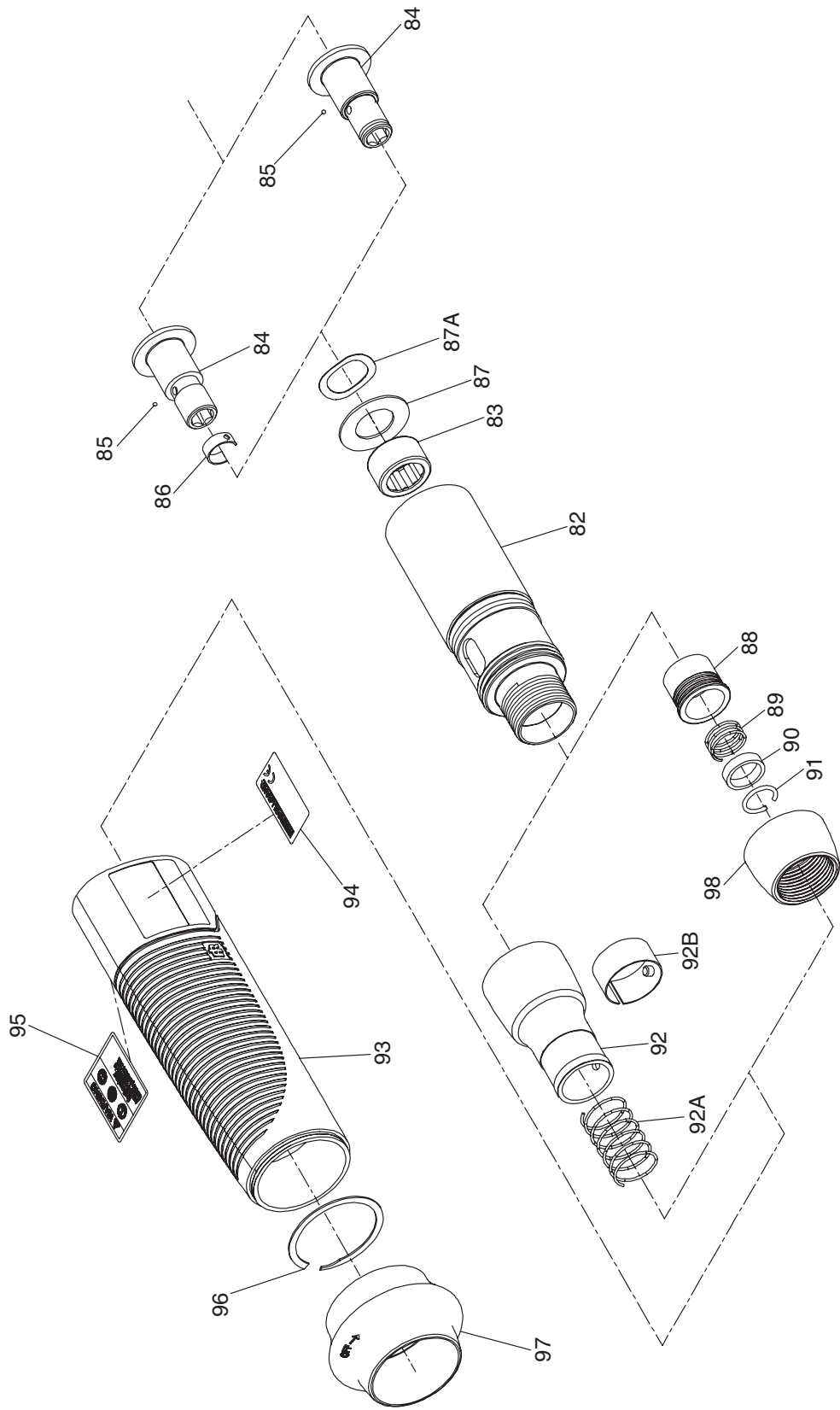

(Dwg. TPA1759-2)

SERIES QS1L AND QS1T LEVER INLINE GRIP AND BIT DRIVERS



When Ordering, use applicable Part Number

Item	Parts Description	Part Number	Item	Parts Description	Part Number
82	Bit Holder Assembly with 1/4" Quick Release Bit Holder (for all Models with Lever Permit)	TRH-A580-PQ4	86	Bit Retaining Spring (for Bit Finder Bit Holders)	TRH-241
83	Bit Holder (for all Models with 1/4" Quick Release Bit Holder (for all Models with Lever Permit)	TRH-A580-NQ4	87	Shutoff Spacer (for all Models with Lever Start only)	TRH-591
84	Bit Holder (for all Models with 1/4" Bit Finder Bit Holder (for all Models with Lever Permit)	TRH-A580-PQ4F	87A	Wave Washer (for all Models with Lever Start only)	TRH-592
	Bit Holder (for all Models with 1/4" Bit Finder Bit Holder (for all Models with Lever Permit)	TRH-A580-NQ4F	88	Bit Retaining Sleeve (for Quick Release Bit Holders)	TRH-930
	Bit Holder (for all Models with 1/4" Double End Quick Release Bit Holder (for all Models with Lever Permit)	TRH-A580-PQ5MD	89	Retaining Sleeve Spring (for Quick Release Bit Holders)	TRH-931
	Bit Holder (for all Models with 1/4" Double End Quick Release Bit Holder (for all Models with Lever Permit)	TRH-A580-NQ5MD	90	Spring Seat (for Quick Release Bit Holders)	TRH-244
	Bit Holder (for all Models with 1/4" Double End Quick Release Bit Holder (for all Models with Lever Permit)	TRH-A580-PQ4D	91	Retaining Ring (for Quick Release Bit Holders)	TRH-853
	Bit Holder (for all Models with 1/4" Double End Quick Release Bit Holder (for all Models with Lever Permit)	TRH-A580-NQ4D	92	Non-Rotating Bit Finder (for Bit Finder Bit Holders)	TRH-873
	Bit Holder (for all Models with 1/4" Double End Quick Release Bit Holder (for all Models with Lever Permit)	TRH-580	92A	Spring (for Bit Finder Bit Holders)	102A60-242
	Bit Holder (for all Models with 1/4" Double End Quick Release Bit Holder (for all Models with Lever Permit)	TRH-105	92B	Finder Retaining Spring (for Bit Finder Bit Holders)	102A60-628
	Clutch Housing		93	Housing Grip	TRH-40-A145
	Clutch Housing Bearing		94	Nameplate	TRH-301
	Bit Holder for 1/4" Quick Release Bit Holder		95	Warning Label	TRH-99
	Bit Holder for 1/4" Bit Finder Bit Holder		96	Grip Retaining Ring	TRH-197
	Bit Holder for 5 mm Double End Quick Release Bit Holder		97	Clutch Adjusting Hole Cover Cover with a flange (standard)	TRH-40-23
	Bit Holder for 1/4" Double End Quick Release Bit Holder		98	Clutch Housing Cap (for Quick Release Holders)	TRH-40-24
85	Bit Retaining Ball for metric Bit Holders	TRH-586-H4	*	Clutch Housing Spanner Wrench	TRH-19
	Bit Retaining Ball for all other Bit Holders	TRH-583-Q4			TRH-478
		TRH-586-5MD			
		TRH-586-Q4D			
		TRH-629-3M			
		R000B-263			

MAINTENANCE

CLUTCH SPRING SELECTION CHART

Tool	Free Speed (rpm)	TORQUE RANGE (Soft Draw)		
		Light Clutch Spring (Orange)	Medium Clutch Spring (Red)	Heavy Clutch Spring (Green)
All Series QS Inline Screwdrivers	2800	1.7 to 9.7 in-lbs. (0.19 to 1.1 Nm)	----- -----	----- -----
	2000	1.7 to 9.7 in-lbs. (0.19 to 1.1 Nm)	7.9 to 22.1 in-lbs. (0.89 to 2.50 Nm)	----- -----
	1710	1.7 to 9.7 in-lbs. (0.19 to 1.1 Nm)	7.9 to 27.3 in-lbs. (0.89 to 3.08 Nm)	----- -----
	1000	1.7 to 9.7 in-lbs. (0.19 to 1.1 Nm)	7.9 to 27.3 in-lbs. (0.89 to 3.08 Nm)	13.3 to 40.0 in-lbs. (1.50 to 4.52 Nm)
	500	1.7 to 9.7 in-lbs. (0.19 to 1.1 Nm)	7.9 to 28.3 in-lbs. (0.89 to 3.20 Nm)	13.3 to 47.8 in-lbs. (1.50 to 5.40 Nm)
	250	1.7 to 9.7 in-lbs. (0.19 to 1.1 Nm)	7.9 to 28.3 in-lbs. (0.89 to 3.20 Nm)	13.3 to 47.8 in-lbs. (1.50 to 5.40 Nm)

WARNING

Always wear eye protection when operating or performing maintenance on this tool.

Always turn off the air supply and disconnect the air supply hose before installing, removing or adjusting any accessory on this tool, or before performing any maintenance on this tool.

LUBRICATION

Each time a Series QS Screwdriver is disassembled for maintenance and repair or replacement of parts, lubricate the tool as follows:

1. Coat all exposed gears with Ingersoll-Rand No. 67 Grease and work some of the Grease into the gearing of the Spindle Assembly (42).
2. Work approximately 6 to 8 cc of Ingersoll-Rand No. 28 Grease into the ball pockets, jaws, adjusting nut lock and shaft threads of the clutch mechanism.
3. Use Ingersoll-Rand No. 10 Oil to lubricate the motor. Inject approximately 1 to 2 cc of oil into the air inlet before attaching the air hose to the tool.

SPEED ADJUSTMENT

In addition to adjustable clutches for controlling torque, Series QS Lever Inline Screwdrivers are furnished with the ability to precisely control speed, within certain ranges. Setting the speed requires a tachometer.

Therefore, the adjustment, although simple, should only be attempted by a competent technician using the proper equipment.

The Back Cap (6) has a small, molded stud on the end face of the Cap nearest the Exhaust Diffuser (15). That stud controls the radial location of the Diffuser which controls the opening size of the exhaust ports. Take an initial reading of the tool speed by applying a tachometer with a convex tip to the inside of the Bit Holder (84). Using the procedure required to activate the motor of your particular model tool, bring the motor to maximum free speed.

After determining the actual velocity, shut off the air supply and disconnect the air line. Use a 3/4" wrench to loosen the Inlet Bushing. The longest slot in the Exhaust Diffuser will contain the molded stud on the Back Cap. Rotate the Diffuser to open the exhaust ports to increase speed or rotate it to restrict the exhaust to reduce speed. Being careful not to allow the Diffuser to damage the molded stud, tighten the Inlet Bushing to 15 ft-lbs. (20 Nm) torque. Connect the air line and restore the air supply and check the velocity again. Determine which direction you need to rotate the Diffuser to obtain the desired speed and then rotate it accordingly. Best results are achieved by using gradual increments and frequent tachometer readings. Be sure to turn off the air supply and disconnect the line when making adjustments.

MAINTENANCE (Continued)

DISASSEMBLY

General Instructions

1. Do not disassemble the tool any further than necessary to replace or repair damaged parts.
2. Whenever grasping a tool or part in a vise, always use leather-covered or copper-covered vice jaws to protect the surface of the part and help prevent distortion. This is particularly true of threaded members and housings.
3. Do not remove any part which is a press fit in or on a subassembly unless the removal of that part is necessary for repairs or replacement.
4. Do not disassemble the tool unless you have a complete set of gaskets and o-rings for replacement.

Disassembly of the Tool

Each Series QS Lever Inline Screwdriver is made using four modules or units which include a motor housing unit, a motor unit, a clutch with bit holder unit and a combined gearing with spindle unit. The tool can be disassembled for repairs to each individual unit without disturbing the other units. To separate the modules, proceed as follows:

NOTICE

The thread in the following step is a left hand thread. Rotate the Bit Finder or Housing Cap clockwise to remove it.

1. **For models with Bit Finder Bit Holders**, unscrew and remove the Non-Rotating Bit Finder (92).
For models with Quick Release Bit Holders, unscrew and remove the Clutch Housing Cap (98). Use a thin blade screwdriver to spiral the Retaining Ring (91) out of the groove in the end of the Bit Holder (84). Being careful not to loose the Bit Retaining Ball (85), slide the Spring Seat (90), Retaining Sleeve Spring (89) and the Bit Retaining Sleeve (88) off the Bit Holder.

NOTICE

The thread in the following step is a left hand thread. Rotate the Cover clockwise to remove it.

2. Unscrew and remove the Clutch Adjusting Hole Cover (97). There are two sets of threads with a non-threaded section between them on the Clutch Housing (82).
3. Using external retaining ring pliers or a thin blade screwdriver, remove the Grip Retaining Ring (96) from the groove in the Clutch Housing.
4. Pull the Housing Grip (93) of the front end of the tool.

NOTICE

The thread in the following step is a left hand thread. Rotate the Clutch Housing clockwise to remove it.

5. Clamp the Inlet Bushing (16) in leather-covered or copper-covered vise jaws and using a 1-1/16" wrench on the flats of the Gear Case (43) and the Clutch Housing Spanner Wrench (Part No. TRH-478) in the clutch housing slot, unscrew and remove the Clutch Housing.
6. Push on the output end of the Bit Holder (85) to remove it from the Clutch Housing (82).
7. **For Models with Lever Start**, slide the Shutoff Spacer (87) and Wave Washer (87A) off the Bit Holder.
8. If the Clutch Housing Bearing (83) is worn and must be replaced, press it from the Clutch Housing.
9. Carefully remove the Clutch Assembly or Clutch Shaft (81), the Clutch Input Driver (47 or 66), the Clutch Return Spring (46 or 65), and the Push Rod (67).
10. Lightly grasp the flats of the Gear Case in leather-covered or copper-covered vise jaws with the Inlet Bushing upward.
11. Place a 1-3/16" open end wrench on the flats of the Back Cap (6) to prevent it from rotating, and use a 3/4" wrench to unscrew and remove the Inlet Bushing.
12. Lift the Exhaust Diffuser (15) off the Back Cap.
13. If the Throttle Valve Spring (14) did not come out of the tool with the Inlet Bushing, use needle nose pliers to remove it and the Throttle Valve (13) from the Motor Housing (1).
14. To remove the Throttle Valve Seat, insert a hooked tool through the central opening of the Seat and pull it from the Motor Housing.
15. Using a 1/16" pilot punch, tap the Throttle Lever Pin (11) out of the Back Cap and remove the Throttle Lever (10).
16. Pull the Throttle Plunger (5) out of the Motor Housing and remove the assembly from the vise.
17. Holding the assembly horizontally, remove the Back Cap, the Memory Chip (9) (if included with the tool), the Back Cap Gasket (7) and the Shutoff Valve (20) (if included with the tool).
18. If the Muffler Elements (8) need to be cleaned or replaced, pull them out of the Back Cap.
19. Grasp the flats at the inlet end of the Motor Housing in leather-covered or copper-covered vise jaws, and using a 1-1/16" wrench on the flats of the Motor Housing, unscrew and separate the Gear Case from the Motor Housing.
20. Set the assembled Gear Case on the workbench.
21. Remove the Motor Clamp Washer (33) and the Motor Seal (32) from the assembled motor in the Housing.
22. Tap the Motor Housing on a wood block to remove the Motor Assembly from the Housing.

Disassembly of the Adjustable Shutoff Clutch

1. Using a thin blade screwdriver, pry the Clutch Adjusting Nut Stop (64) off the end of the Clutch Shaft (52).

MAINTENANCE (Continued)

2. Insert the tip of a #1 Phillips Head Screwdriver into the adjustment opening between the Clutch Adjusting Nut (63) and the Clutch Adjusting Nut Washer (62). Rotate the screwdriver clockwise to thread the Adjustment Nut off the Clutch Shaft.

NOTICE

In the following step, the Clutch Cam Balls will be free to fall from the assembly when the Cam Ball Seat is moved. Make certain the Balls fall into a non-damaging container.

3. Holding the assembly over a small pasteboard box, slide the Adjusting Nut Washer, the Thrust Bearing (61), the Spring Seat (60), the Clutch Spring (59) and the Cam Ball Seat (58) off the Clutch Shaft. Allow the three Clutch Cam Balls (56) to fall into the pasteboard box.
4. The Clutch Cam Ball Driver (55) has a cross hole that is larger on one side than the other. Insert a 1/16" drill shank or piece of wire into the smaller hole and gently push the Clutch Driver Retaining Pin (57) out of the larger hole and out of the Driver and the Clutch Shaft.

NOTICE

In the following step, the Clutch Balls will be free to fall from the assembly when the Cam Jaw is moved along the Clutch Shaft. Make certain the Balls fall into a non-damaging container.

5. Holding the assembly over a small pasteboard box, and using care to drop the twelve Clutch Balls (53) into the box, slide the Clutch Cam Ball Driver and Cam Jaw (54) off the Clutch Shaft. If grease held some of the Balls inside the jaw cavity, remove them.
6. With the large end of the Clutch Shaft downward, depress the Automatic Shutoff Pin (50) with varying amounts of finger pressure while tapping the large end edge of the Clutch Shaft on a piece of wood until the Automatic Shutoff Plunger (48) protrudes slightly from the end of the Shaft. Grasp the Plunger and carefully pull it out of the Clutch Shaft.
7. Remove the Automatic Shutoff Pin and Automatic Shutoff Pin Spring (51) from the Clutch Shaft. The Pin Spring should remain in the pin recess when the Pin is removed. To separate the Spring from the Pin, gently rotate the Spring while pulling it from the recess to avoid elongating the Spring.
8. Using a hooked tool, reach into the opening in the end of the Clutch Shaft and carefully pull the Automatic Shutoff Plunger Return Spring (49) out of the Shaft without elongating the Spring.

Disassembly of the Adjustable Cushion Clutch

1. Using a thin blade screwdriver, pry the Clutch Adjusting Nut Stop (80) off the end of the Clutch Shaft (68).

2. Insert the tip of a #1 Phillips Head Screwdriver into the adjustment opening between the Clutch Adjusting Nut (79) and the Clutch Adjusting Nut Washer (78). Rotate the screwdriver clockwise to thread the Adjustment Nut off the Clutch Shaft.

NOTICE

In the following step, the Clutch Cam Balls will be free to fall from the assembly when the Cam Ball Seat is moved. Make certain the Balls fall into a non-damaging container.

3. Holding the assembly over a small pasteboard box, slide the Adjusting Nut Washer, the Thrust Bearing (77), the Spring Seat (76), the Clutch Spring (75) and the Cam Ball Seat (74) off the Clutch Shaft. Allow the eleven Clutch Cam Balls (72) to fall into the pasteboard box.
4. The Clutch Cam Ball Driver (71) has a cross hole that is larger on one side than the other. Insert a 1/16" drill shank or piece of wire into the smaller hole and gently push the Clutch Driver Retaining Pin (73) out of the larger hole and out of the Driver and the Clutch Shaft.

NOTICE

In the following step, the Clutch Balls will be free to fall from the assembly when the Cam Jaw is moved along the Clutch Shaft. Make certain the Balls fall into a non-damaging container.

5. Holding the assembly over a small pasteboard box, and using care to drop the twelve Clutch Balls (69) into the box, slide the Clutch Cam Ball Driver and Cam Jaw (70) off the Clutch Shaft. If grease held some of the Balls inside the jaw cavity, remove them.

Disassembly of the Gearing

1. Using snap ring pliers, remove the Gear Retainer (35) from the motor end of the Gear Case (43) and remove the Gear Head Spacer (36) as well.
2. **For Series QS1L02, QS1T02, QS1L05, QS1T05, QS1L10 and QS1T10**, lightly rap the motor end of the Gear Case on a wooden work bench top to remove the three Planet Gears (39), the Planet Gear Head Assembly (38) and the Planet Gear Head Spacer (41). **For Series QS1L17, QS1T17, QS1L20 and QS1T20**, lightly rap the motor end of the Gear Case on a wooden work bench top to remove the three Planet Gears (39), The Gear Head Pinion (40), the Planet Gear Head Assembly (38) and the Planet Gear Head Spacer (41). **For Series QS1L28 and QS1T28**, lightly rap the motor end of the Gear Case on a wooden work bench top to remove the Planet Gear Head Drive Plate (37), the

MAINTENANCE (Continued)

- Planet Gear Head Assembly (38) and the Planet Gear Head Spacer (41).
- Using snap ring pliers, remove the Spindle Bearing Retaining Ring (45).
 - Stand the Gear Case on the table of an arbor press with the output spindle upward. Using a rod that neatly fits inside the internal hex of the Spindle (42), press the Spindle Assembly out of the Spindle Bearing (44).

CAUTION

Do not remove the Bearing in the following step unless you have a new replacement available for installation. The Bearing will be damaged by the removal process.

- Invert the Gear Case on the table of an arbor press so that the end face having four notches makes contact with the table. Using a rod against the inner race of the Spindle Bearing, press the Bearing from the Gear Case.
- If the Spindle Bearing Seat (46) must be replaced, use a small, thin blade screwdriver to spiral it out of the groove in the Gear Case.

Disassembly of the Motor

- Using snap ring pliers, remove the Rear End Plate Assembly Retainer (23) from the shaft of the Rotor (27).
- Pull the Rear End Plate Face Plate (22) and Rear End Plate Assembly (21) off the hub of the Rotor.
- Lift the Cylinder (24) from the Rotor.
- Remove the Vanes (28) from the Rotor.
- Support the Front End Plate Assembly (29), as near the rotor body as possible, on the table of an arbor press and press the Rotor from the Front Rotor Bearing (31). Remove the Bearing from the Front End Plate.

Disassembly of the Housing

- Pull the Reverse Lever (19) off the inlet end of the Motor Housing (1).
- Using a #2 Phillips Head Screwdriver, unscrew and remove the Housing Screw (3).
- Insert a 5/16" wooden dowel between 6 and 8 inches long, into the inlet end of the Motor Housing and push the Reverse Valve Assembly (4) out the motor end of the Housing.
- Use a hooked tool to pull the Housing O-ring (2) out of the Motor Housing.

ASSEMBLY

General Instructions

- Always press on the **inner** ring of a ball-type bearing when installing the bearing on a shaft.

- Always press on the **outer** ring of a ball-type bearing when pressing the bearing into a bearing recess.
- Whenever grasping a tool or part in a vise, always use leather-covered or copper-covered vise jaws to protect the surface of the part and help prevent distortion. This is particularly true of threaded members and housings.
- Except for bearings, always clean every part and wipe every part with a thin film of oil before installation.
- Apply o-ring lubricant to all o-rings before final assembly.
- Check every bearing for roughness. If an open bearing must be cleaned, wash it thoroughly in a clean, suitable cleaning solution and dry with a clean cloth. **Sealed or shielded bearings should never be cleaned.** Work grease into every open bearing before installation.

Assembly of the Housing

- Lubricate the Housing O-ring (2) with o-ring lubricant and install it at the bottom of the cylinder bore in the Motor Housing (1).
- Inspect the face and o-ring on the hub of the Reverse Valve Assembly (4) for nicks or damage. Replace the Reverse Valve Assembly if any damage is evident.
- Lubricate the o-ring on the hub of the Reverse Valve Assembly with o-ring lubricant and insert the Assembly, o-ring end leading, into the cylinder bore of the Motor Housing. Push the Assembly toward the bottom of the cylinder bore until it "snaps" into its proper location.
- Rotate the Valve inside the Housing until the threaded hole into the side of the Valve for the Motor Housing Screw (3) aligns with the hole in the Motor Housing.
- Using a #2 Phillips Head Screwdriver, thread the Motor Housing Screw into the Reverse Valve Assembly through the Housing until the underside of the screw head stops against the Housing. Back the Screw out of the Valve between 1/4 and 1/2 turn.
- Align the open end of the slot inside the Reverse Lever (19) with the head of the Housing Screw. From the inlet end of the Housing, slide the Lever onto the Housing, making certain the screw head enters the slot, and move it along the Housing until it stops against the housing shoulder.
- Rotate the Lever to make certain the Valve only has slight resistance.

Assembly of the Motor

- Place the Front End Plate (29) on the splined shaft of the Rotor (27) with the bearing recess away from the rotor body.
- Place the Front Rotor Bearing (31) onto the shaft and using a sleeve or piece of tubing that contacts the inner race of the Bearing, press the Bearing onto the

MAINTENANCE (Continued)

shaft until the Front End Plate nearly contacts the rotor body.

NOTICE

In the following step, the measurement must be made at the end corner of the large rotor body.

- The clearance between the Front End Plate and Rotor is critical. While pressing down with your finger on the outer edge of the Front End Plate on the bearing side, insert a 0.004" (0.1 mm) feeler gauge between the face of the rotor body and the face of the End Plate at a point that is 180 degrees from where the pressure is applied. Refer to Dwg. TPA1740. To increase the gap, support the End Plate and lightly tap the rotor shaft with a plastic hammer; to decrease the gap, press the Bearing farther onto the rotor shaft.

Measurement of Front End Plate Clearance

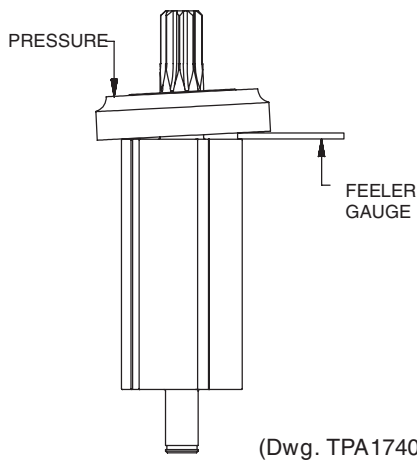

- Wipe each Vane (28) with a light film of Ingersoll-Rand No.10 Oil and place a Vane in each slot in the Rotor.
- One end of the Cylinder Assembly (24) has a notch that breaks the outer wall and end face of the Cylinder. With that end trailing, install the Cylinder Assembly over the Rotor and Vanes against the Front End Plate. Make certain the Cylinder Front Alignment Pin (26) enters the hole in the Front End Plate.
- Install the Rear End Plate Assembly (21), flat face leading, on the rear hub of the Rotor. Make certain the Cylinder Rear Alignment Pin (25) enters the hole in the Rear End Plate.
- Examine the Rear End Plate Face Plate (22) for scratches. If it is scratched, replace it. If it is not, slide it onto the rear hub of the Rotor and onto the Cylinder Rear Alignment Pin against the Rear End Plate. Some pressure may be required to fit the hole in the Plate onto the Alignment Pin.

- Using snap ring pliers, install the Rear End Plate Assembly Retainer (23) in the annular groove on the rear rotor hub to secure the assembly in position.
- Set the assembled motor aside.

Assembly of the Gearing

- Using a small screwdriver, work the Spindle Bearing Seat (46) into the internal groove nearest the notched end of the Gear Case (43).
- Stand the Gear Case, notched end upward, on the table of an arbor press. Using a piece of tubing that contacts the outer race of the Spindle Bearing (44), press a new Bearing into the Gear Case against the Seat.
- Lubricate the gears in the Spindle Assembly (42) with Ingersoll-Rand No. 67 Grease.
- Invert the Gear Case and using another piece of tubing that supports the inner race of the Bearing and clears the output end of the Spindle Assembly, press the Spindle Assembly into the Bearing from the motor end of the Gear Case.
- Using snap ring pliers, install the Spindle Bearing Retaining Ring (45) in the external groove near the driver end of the spindle.
- Lightly lubricate the Planet Gear Head Spacer (41) with Ingersoll-Rand No. 67 Grease and install it in the Gear Case against the Spindle Assembly.
- Lubricate the shafts of the Planet Gear Head Assembly (38) with Ingersoll-Rand No. 67 Grease and install the Gear Head in the Gear Case meshing the spline on the shaft with the gear teeth in the Spindle Assembly.
- For Series QSIL02, QSIT02, QSIL05, QSIT05, QSIL10 and QSIT10**, lubricate the Planet Gears (39) with Ingersoll-Rand No. 67 Grease and install them on the shafts of the Planet Gear Frame Assembly. **For Series QSIL17, QSIT17, QSIL20 and QSIT20**, lubricate the Planet Gears (39) and Gear Head Pinion (40) with Ingersoll-Rand No. 67 Grease and install the Planet Gears on the shafts of the Planet Gear Frame Assembly. Insert the Gear Head Pinion in the center of the Planet Gears making certain the teeth mesh. **For Series QSIL28 and QSIT28**, lubricate the Planet Gear Head Drive Plate (37) with Ingersoll-Rand No. 67 Grease and install it on the shafts of the Planet Gear Frame Assembly.
- Install the Gear Head Spacer (36) against the Gears or Drive Plate and secure the assembly by using snap ring pliers to install the Gear Retainer (35) in the internal groove at the motor end of the Gear Case.

Assembly of the Adjustable Cushion Clutch

- Insert the small end of the Clutch Shaft (68) into the end of the Cam Jaw (70) having the large opening and slide the Shaft about half way into the Jaw.

MAINTENANCE (Continued)

- Drop the twelve Clutch Balls (69) into the Cam Jaw forming a ring around the Clutch Shaft.
- Lay a bead of Ingersoll-Rand No. 28 Grease, approximately 2 to 3 cc, on top of the Clutch Balls and then bring the Clutch Shaft and Cam Jaw together capturing the Balls between them.
- While holding the Shaft and Jaw together, slide the Clutch Cam Ball Driver (71), large end leading, onto the Clutch Shaft until it is against the Cam Jaw.
- Rotate the Driver to align the large hole through one wall of the Driver with the comparable size opening of the cross hole through the Clutch Shaft. Push the Clutch Cam Ball Driver Retaining Pin (73) into the hole to lock the Driver in position on the Clutch Shaft.
- Apply a coating of Ingersoll-Rand No. 28 Grease to each of the eleven Clutch Cam Balls (72).
- Holding the assembled Clutch Shaft with the Clutch Cam Ball Driver upward, insert a lubricated Ball into each of the eleven ball pockets in the Driver.
- Slide the Cam Ball Seat (74), large end leading, onto the Shaft against the Balls. Follow with the Clutch Spring (75), Spring Seat (76), Thrust Bearing (77) and the Clutch Adjusting Nut Washer (78) with the smooth face leading.
- Thread the Clutch Adjusting Nut (79), smooth face trailing, onto the Clutch Shaft.
- Insert the tip of a #1 Phillips Head Screwdriver into the adjustment opening between the Clutch Adjusting Nut and the Clutch Adjusting Nut Washer. Rotate the screwdriver counterclockwise and thread the Adjustment Nut onto the Clutch Shaft until the external groove for the Clutch Adjusting Nut Stop (80) is visible.
- Install the Nut Stop in the groove.

Assembly of the Adjustable Shutoff Clutch

- Hold the Clutch Shaft (52) in your hand with the large end upward.
- Insert the Automatic Shutoff Plunger Return Spring (49) into the central opening in the large end of the Clutch Shaft. Use a 1/8" dowel to push the Spring below the cross hole for the Automatic Shutoff Pin (50).
- Insert the Automatic Shutoff Pin Spring (51) in the end hole of the Automatic Shutoff Pin opposite the pointed end. Rotate the Spring a little to keep it in the hole.
- Drip one or two drops of Ingersoll-Rand No. 10 Oil into the central hole with the Plunger Return Spring.
- Position the Shutoff Pin, Spring leading, in the cross hole on the large end of the Clutch Shaft with the hole in the Shutoff Pin aligned with the central hole containing the Return Spring.
- Push on the pointed end of the Shutoff Pin to depress the Spring while inserting the Automatic Shutoff

Plunger (48) into the central opening with the Return Spring. The smaller center portion of the Shutoff Plunger will allow the Shutoff Pin to spring outward and capture the components within the Clutch Shaft when properly positioned.

- Insert the small end of the Clutch Shaft into the end of the Cam Jaw (54) having the large opening and slide the Shaft about half way into the Jaw.
- Drop the twelve Clutch Balls (53) into the Cam Jaw forming a ring around the Clutch Shaft.
- Lay a bead of Ingersoll-Rand No. 28 Grease, approximately 2 to 3 cc, on top of the Clutch Balls and then bring the Clutch Shaft and Cam Jaw together capturing the Balls between them.
- While holding the Shaft and Jaw together, slide the Clutch Cam Ball Driver (55), large end leading, onto the Clutch Shaft until it is against the Cam Jaw.
- Rotate the Driver to align the large hole through one wall of the Driver with the comparable size opening of the cross hole through the Clutch Shaft. Push the Clutch Cam Ball Driver Retaining Pin (57) into the hole to lock the Driver in position on the Clutch Shaft.
- Apply a coating of Ingersoll-Rand No. 28 Grease to each of the three Clutch Cam Balls (56).
- Holding the assembled Clutch Shaft with the Clutch Cam Ball Driver upward, insert a lubricated Ball into each of the three ball slots in the Driver.
- Slide the Cam Ball Seat (58), large end leading, onto the Shaft against the Balls. Follow with the Clutch Spring (59), Spring Seat (60), Thrust Bearing (61) and the Clutch Adjusting Nut Washer (62) with the smooth face leading.
- Thread the Clutch Adjusting Nut (63), smooth face trailing, onto the Clutch Shaft.
- Insert the tip of a #1 Phillips Head Screwdriver into the adjustment opening between the Clutch Adjusting Nut and the Clutch Adjusting Nut Washer. Rotate the screwdriver counterclockwise and thread the Adjustment Nut onto the Clutch Shaft until the external groove for the Clutch Adjusting Nut Stop (64) is visible.
- Install the Nut Stop in the groove.

Assembly of the Tool

- Lightly grasp the flats at the inlet end of the Motor Housing (1) in leather-covered or copper-covered vise jaws with the motor bore upward.
- Grasp the spline of the Rotor (27) in the assembled motor and after aligning the End Plate Alignment Pin (30) with the internal notch in the motor end of the housing bore, insert the assembled motor into the Motor Housing. Make certain the motor is far enough into the Housing to have the undercut below the internal housing thread visible.

MAINTENANCE (Continued)

3. Lubricate the Motor Seal (32) with o-ring lubricant and install it around the Front End Plate (29) and into the undercut in the Housing.
4. Align the tab of the Motor Clamp Washer (33) with the internal notch in the Housing and install it over the rotor hub and End Plate Alignment Pin against the Motor Seal. Make certain the Pin enters the hole in the Washer and the Washer is flat against the Seal.
5. Apply some Ingersoll-Rand No. 67 Grease to the spline on the rotor shaft.
6. Thread the assembled Gear Case (43), output spindle trailing, into the Motor Housing and using a 1-1/16" wrench, tighten the joint between 15 and 20 ft-lbs. (20 and 27 Nm) torque.
7. **For Models with a Clutch**, place the narrow end of the Clutch Return Spring (46 or 65) in the Gear Case against the inner race of the Spindle Bearing (44).
8. **For Models with Direct Drive**, insert the hex end of the Clutch Shaft (81) that does not have the step, into the hex recess of the Spindle Assembly (42).
For Models with a Clutch, place the hex drive end of the Clutch Input Driver (47 or 66) on the Spring and compress the Spring until the hex on the Driver enters the hex recess in the Spindle Assembly (42). While holding the Driver in position, engage the raised bar on the face of the Driver with the jaw of the Cam Jaw (54 or 70).
9. If the Clutch Housing Bearing (83) was removed, stand the Clutch Housing (82) on the table of an arbor press with the smaller, externally threaded end downward.
10. Using a Needle Bearing Inserting Tool as shown in Dwg. TPD786 with a 0.030" (0.76 mm) thick washer that clears the inner bore and outer edge of the Bearing inserted between the Bearing and stop surface on the tool, press the Bearing into the Clutch Housing. The trailing end of the Bearing must be between 0.025" and 0.035" (0.63 and 0.89 mm) below the face of the bore into which the Bearing is pressed.

Needle Bearing Inserting Tool

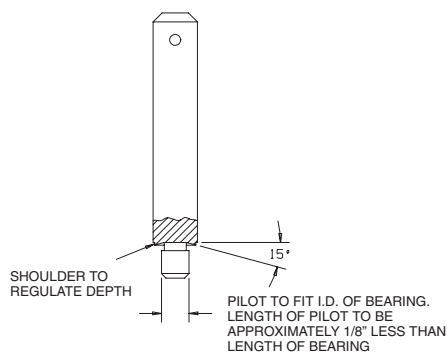

(Dwg. TPD786)

11. **For Models with Lever Start**, slide the Wave Washer (87A) followed by the Shutoff Spacer (87) onto the hub of the Bit Holder (84) and insert the Bit Holder into the large end of the Clutch Housing (82) and push the output end through the Clutch Housing Bearing.
For Models with Lever Permit, insert the Bit Holder (84) into the large end of the Clutch Housing (82) and push the output end through the Clutch Housing Bearing

NOTICE

The following step has parts with a left-hand thread. Rotate the components counterclockwise to tighten them.

12. Install the assembled Clutch Housing over the clutch components and thread it onto the Gear Case. Using a 1-1/16" wrench on the flats of the Gear Case and the Clutch Housing Spanner Washer (Part No. TRH-478) in the clutch housing slot, tighten the joint between 15 and 20 ft-lbs. (20 and 27 Nm) torque.
13. Invert the assembled tool in the vise jaws and lightly grasp the flats on the Gear Case with the inlet end of the tool upward.
14. Insert a 5/8" dowel through the opening in the Back Cap (6), and using the dowel as an alignment device, install the three Muffler Elements (8) in the cavity of the Back Cap. Make certain the notches in the outer-edge of the Elements fit over the memory chip pocket in the bottom of the Cap.
15. If the tool is equipped with a Memory Chip (9), install it (with the leads entering first) in the pocket at the bottom of the Back Cap.
16. Make certain the tab on the inside edge of the Back Cap Gasket (7) is aligned with the pocket for the Memory Chip and install the Gasket, metal face leading, in the recess of the Back Cap against the face with the cavity containing the Muffler Elements.
17. Position the gasket end of the alignment dowel against the inlet hub on the Motor Housing. Align the flats on the Cap with the flats on the Housing. Orient the Back Cap to clear the Reverse Lever (19) and slide the Back Cap Assembly off the alignment dowel and onto the Motor Housing.
18. **For all Models with a Shutoff Clutch and Lever Permit Models with a Cushion Clutch**, install the Push Rod (34) into the central hole in the inlet hub. The Rod will enter the assembled motor and disappear from view when released. Install the Shutoff Valve (20), small end first, in the same opening.
19. Being careful not to damage it, insert the Throttle Valve Seat (12) into the central opening at the inlet end of the Motor Housing at an angle until it clears the threads in the Housing. Using a rod with a flat end and no sharp edges, push the Seat to the bottom of the opening until it seats flush.

MAINTENANCE (Continued)

20. Using needle nose pliers, insert the Throttle Valve (13), long stem leading, into the opening against the Seat. Center the Valve in the Seat.
21. Install the Throttle Valve Spring (14) in the opening so that it encircles the Valve.
22. The Exhaust Diffuser (15) has one slot that is longer than the other five slots. The Back Cap has a short, molded stud projecting from the inlet end. Place the Exhaust Diffuser against the Back Cap with the long slot encircling the molded stud. Rotate the Diffuser counterclockwise until the wall of the slot stops against the stud. The exhaust ports are now in the full open position which will provide maximum free speed.
23. If the Inlet Screen (18) required replacement, use a wooden dowel to carefully push a new one into the Inlet Bushing (16).
24. If the Inlet Bushing Seal (17) is nicked or damaged, carefully install a new one over the threads of the Inlet Bushing.
25. Thread the Inlet Bushing Assembly through the Diffuser and Back Cap into the Motor Housing. Using a 1-3/16" wrench on the flats of the Back Cap to keep it from turning, tighten the Inlet Bushing between 15 and 20 ft-lbs. (20 and 27 Nm) torque.
26. The Throttle Plunger (5) has a lengthwise flat on the outer edge at one end of the Plunger. Insert the Plunger, flat end first, into the cross hole in the Housing. Push on the end of the Plunger to make certain it springs back from contact with the stem of the Throttle Valve.
27. Position the Throttle Lever (10) in the slot in the Back Cap and Motor Housing and using a 1/16" diameter rod, align the holes through the Back Cap, Motor Housing and Throttle Lever. While maintaining alignment, install the Throttle Lever Pin (11) in place of the rod by tapping it through all three pieces.
28. Remove the tool from the vise jaws and install the Housing Grip (93) over the Clutch Housing.
29. Install the Grip Retaining Ring (96) in the external groove on the Clutch Housing ahead of the Grip to retain the Grip on the Housing.
30. **For Models with Quick Release Bit Holders**, place the Bit Retaining Ball (85) in the hole through the wall of the Bit Holder and slide the Bit Retaining Sleeve (88), large end trailing, onto the Bit Holder. Slide the Retaining Sleeve Spring (89) and Spring Seat (90) onto the Bit Holder and secure the components by installing the Retaining Ring (91) in the external groove at the output end of the Bit Holder.

NOTICE

The thread in the following step is a left-hand thread. Rotate the component counterclockwise to tighten it.

31. Thread the Clutch Adjusting Hole Cover (97) onto the Clutch Housing against the Housing Grip and hand tighten it between 2 and 6 ft-lbs. (3 and 8 Nm) torque.

NOTICE

The following step has parts with a left-hand thread. Rotate the components counterclockwise to tighten them.

32. Thread the Non-Rotating Bit Finder (92) or Clutch Housing Cap (98) onto the Clutch Housing and hand tighten it between 2 and 6 ft-lbs. (3 and 8 Nm) torque.

TESTING THE TOOL

Before placing the tool back in service, test the tool in a run down application to determine if adjustments are necessary to satisfactorily perform the operation. Since five interrelated adjustments can affect tool performance, only experience, along with trial and error, can dictate which adjustment or combination of adjustments will provide the desired results.

The Clutch Spring (59 or 75), the clutch adjustment procedure, the exhaust flow, the length of the Push Rod (34) and the length of the Shutoff Valve (20) can individually or collectively have an effect on torque and/or speed. Always try to make adjustments before replacing or attempting to modify components. If adjustments are unable to provide the desired torque, it may be necessary to install a lighter or heavier Clutch Spring.

If the tool ratchets when operated but fails to shutoff, it may be necessary to shorten the Push Rod. Only shorten the Push Rod in small increments. Increments between 0.005" and 0.010" (0.13 and 0.25 mm) are recommended. If the tool stalls and does not shutoff, runs slower than normal or has low power, the Shutoff Valve may require lengthening. To lengthen the Shutoff Valve, grasp the stem between two pieces of rubber or other non-slip, non-marring material and rotate the molded nut counterclockwise. Rotating the nut one half revolution will lengthen the Valve approximately 0.009" (0.23 mm).

Should the stem of the Valve become bent, marred, nicked or damaged in any way during the adjustment process, replace it.

MAINTENANCE (Continued)

TROUBLESHOOTING GUIDE		
Trouble	Probable Cause	Solution
Loss of Power	Low air pressure	Check air supply. For top performance, the air pressure must be 90 psig (6.2 bar/620 kPa) at the inlet.
	Plugged Inlet Bushing Screen	Clean the Inlet Bushing Screen using a clean, suitable cleaning solution. If the Screen cannot be cleaned, replace it.
	Worn or broken Vanes	Replace a complete set of Vanes.
	Worn or broken Cylinder	Replace the Cylinder if it is cracked or if the bore appears wavy or scored.
	Exhaust control restricted	Make certain the Exhaust Diffuser against the Back Cap is in the fully open position.
	Shutoff Valve too short	Lengthen the Shutoff Valve. Refer to “TESTING THE TOOL” on page 37
Motor won't run	Motor Clamp Washer binding	Remove the Gear Case make certain the Washer is flat and the Motor Seal is properly positioned.
	Gears binding	Clean and inspect all gearing. Replace any worn or damaged gearing.
	Push Rod worn	Install a new Push Rod.
Gear Case gets hot	Excessive grease	Clean and inspect Gear Case and gearing parts and lubricate as instructed.
	Worn or damaged parts	Clean and inspect the gear Case and Gearing. Replace worn or broken components.
Inconsistent disengagement of the Adjustable Clutch	Improper lubrication	Remove the Adjustable Clutch mechanism and examine the parts. Lubricate as instructed.
	Wrong Clutch Spring (using Heavy Clutch Spring on light torque application)	Change to Medium or Light Clutch Spring.
Motor stalls before Adjustable Clutch ratchets	Improper Clutch adjustment or improper tool ratio for application	Check Clutch Adjustment and review tool performance vs. requirements.
	Low pressure at the inlet	Check the air supply. For top performance, the air pressure must be 90 psig (6.2bar/620kPa) at the inlet.
	Insufficient grease	Lubricate the Clutch as instructed.
	Improper exhaust control adjustment	Adjust the exhaust flow to obtain the desired speed.
Tool ratchets before shutoff	Push Rod too long	Shorten the push Rod. Refer to “TESTING THE TOOL” on page 37
Tool stalls without shutting off	Shutoff Valve too short	Lengthen the Shutoff Valve. Refer to “TESTING THE TOOL” on page 37
Too runs slower than normal	Shutoff Valve too short	Lengthen the Shutoff Valve. Refer to “TESTING THE TOOL” on page 37

NOTICE

SAVE THESE INSTRUCTIONS. DO NOT DESTROY.

This Page intentionally left Blank

SERVICE CENTERS



For Order Entry and Order Status

Ingersoll-Rand-Company

Distribution Center

P.O. Box 618
510 Hester Drive
White House, TN 37188
Phone: (615) 672-0321
Fax: (615) 672-0801

Technical Support

Ingersoll-Rand
1872 Enterprise Drive
Rochester, MI 48309
Phone: (248) 293-5700
Fax: (248) 293-5800

National Sales Office

Business Development Center
1467 Route 31 South
Annandale, NJ 08801
Phone: (908) 238-7000

Regional Sales Offices

Chicago, IL

888 Industrial Drive
Elmhurst, IL 60126
Phone: (630) 530-3800
Fax: (630) 530-3891

Detroit, MI

1872 Enterprise Drive
Rochester, MI 48309
Phone: (248) 293-5700
Fax: (248) 293-5800

Houston, TX

450 Gears Road
Suite 210
Houston, TX 77067-4516
Phone: (281) 872-6800
Fax: (281) 872-6807

Los Angeles, CA

13107 Lakeland Road
Santa Fe Springs, CA
90670-0525
Phone: (562) 777-0808
Fax: (562) 777-0818

IR Equipment Sales Stores

Arizona

820 N. 17th Avenue
Phoenix, AZ 85007
Phone: (602) 258-6493
Fax: (602) 253-9041

California

12747 Schabarum Ave.
Los Angeles, CA 91706-6802
Phone: (626) 337-4545
Fax: (626) 337-1707

1851 Bell Ave
PO Box 38406
Sacramento, CA 95838
Phone: (916) 641-1994
Fax: (916) 641-1872

1944 Marina Blvd.
San Leandro, CA 94577
Phone: (510) 357-9131
Fax: (510) 483-7287

Maryland

5681 Main Street
PO Box 7464
Elkridge, MD 21075
Phone: (410) 796-3200
Fax: (410) 796-3350

Massachusetts

300 Turnpike Road, Rte. 9
Southboro, MA 01772
Phone: (508) 481-1350
Fax: (508) 481-2014

New Jersey

98 Route 10 West
East Hanover, NJ 07936
Phone: (973) 887-1212
Fax: (973) 887-4658

Pennsylvania

946 Griffin Pond Road
Clarks Summit, PA 18411
Phone: (570) 587-7040
Fax: (570) 586-1962

621 Lowther Road
Lewisberry, PA 17339
Phone: (717) 938-1441
Fax: (717) 938-1496

Tennessee

801 Suncrest Drive
PO Box 8808
Gray, TN 37615
Phone: (423) 477-3114
Fax: (423) 477-2376

Tennessee (Continued)

1500 J. P. Hennessey Drive
LaVergne, TN 37086-3521
Phone: (615) 641-3000
Fax: (615) 641-3040

1500 Harris Road
Knoxville, TN 37924
Phone: (423) 673-0344
Fax: (423) 673-0663

WEB: <http://www.irco.com>

International Sales Offices

Offices and distributors in principal cities throughout the world. Contact the nearest **Ingersoll-Rand** office for the name and address of the distributor in your country or write/fax to:

Ingersoll-Rand Company

1872 Enterprise Drive
Rochester, MI 48309
Phone: (248) 293-5700
Fax: (248) 293-5800

Canada

National Sales Office

Regional Warehouse
Toronto, Ontario
51 Worcester Road
Rexdale, Ontario
M9W 4K2
Phone: (416) 213-4500
Fax: (416) 213-4510
Order Desk
Fax: (416) 213-4506

Regional Sales Offices

Edmonton, Alberta
9720 - 54 Avenue
Edmonton, Alberta
T6E 0A9
Phone: (780) 438-5039
Fax: (780) 439-7382

Montreal, Quebec

3501 St. Charles Blvd.
Suite 104
Kirkland, Quebec
H9H 4S3
Phone: (514) 695-9040
Fax: (514) 695-0963

Texas

2210 McAllister (77092)
Mail: PO Box 3208
Houston, TX 77253
Phone: (713) 68109221
Fax: (713) 681-7448

Wisconsin

12311 W. Silver Spring Drive
Milwaukee, WI 53225
Phone: (414) 461-7810
Fax: (414) 461-4510

British Columbia

1200 Cliveden Avenue
Delta, B. C.
V3M 6G4
Phone: (604) 523-0803
Fax: (604) 523-0801

Latin America Operations

Ingersoll-Rand Company

Production Equipment Group
730 N.W. 107 Avenue
Suite 300, Miami, FL
33172-3107 USA
Phone: (305) 559-0500
Fax: (305) 222-0864

Europe, Middle East and Africa

Ingersoll-Rand Company

Douai Operations
111, avenue Roger Salengro
59450 Sin Le Noble, France
Phone: (33) 3-27-93-08-08
Fax: (33) 3-27-93-08-00

Asia Pacific Operations

Ingersoll-Rand Asia Pacific, Inc.

23/F, 625 King's Road
North Point
Hong Kong
Phone: (852) 2527 0183
Fax: (852) 2529 5976

Russia

Ingersoll-Rand Company

Kuznetsky Most 21/5
Entrance 3
Moscow 103895 Russia
Phone: 7-501-923-91-34
Fax: 7-501-924-46-25