

**OPERATING INSTRUCTIONS**

---

17.1 inch WIDESCREEN TFT-LCD TV

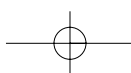

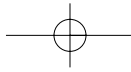

**TL-1700W**





# Introduction

## READ THIS BEFORE OPERATING YOUR UNIT

 <div style="border: 1px solid black; padding: 2px; text-align: center;"> <b>CAUTION</b>                  RISK OF ELECTRIC SHOCK                  DO NOT OPEN             </div> 	 <p>This symbol is intended to alert the user to the presence of uninsulated "dangerous voltage" within the product's enclosure that may be of sufficient magnitude to constitute a risk of electric shock to persons.</p>
<p><b>CAUTION</b> : TO REDUCE THE RISK OF ELECTRIC SHOCK, DO NOT REMOVE COVER (OR BACK). NO USER-SERVICEABLE PARTS INSIDE. REFER SERVICING TO QUALIFIED SERVICE PERSONNEL.</p>	 <p>This symbol is intended to alert the user to the presence of important operating and maintenance (servicing) instructions in the literature accompanying the appliance.</p>

**WARNING : TO REDUCE THE RISK OF FIRE OR ELECTRIC SHOCK, DO NOT EXPOSE THIS APPLIANCE TO RAIN OR MOISTURE.**

<p><b>Note to CATV System Installer :</b>                  This reminder is provided to call the CATV system installer's attention to Article 820-40 of the NEC that provides guidelines for proper grounding and, in particular, specifies that the cable ground shall be connected to the grounding system of the building, as close to the point of cable entry as practical.</p>
<p><b>FCC INFORMATION</b></p> <p>NOTE: THE MANUFACTURER IS NOT RESPONSIBLE FOR ANY RADIO OR TV INTERFERENCE CAUSED BY UNAUTHORIZED MODIFICATIONS TO THIS EQUIPMENT. SUCH MODIFICATIONS COULD VOID THE USER'S AUTHORITY TO OPERATE THE EQUIPMENT.</p> <p>NOTE: This equipment has been tested and found to comply with the limits for a Class B digital device, pursuant to Part 15 of the FCC Rules. These limits are designed to provide reasonable protection against harmful interference in a residential installation. This equipment generates, uses and can radiate radio frequency energy and, if not installed and used in accordance with the instructions, may cause harmful interference to radio communications. However, there is no guarantee that interference will not occur in a particular installation. If this equipment does cause harmful interference to radio or television reception, which can be determined by turning the equipment off and on, the user is encouraged to try to correct the interference by one or more of the following measures:</p> <ul style="list-style-type: none"> <li>• Reorient or relocate the receiving antenna.</li> <li>• Increase the separation between the equipment and receiver.</li> <li>• Connect the equipment into an outlet on a circuit different from that to which the receiver is connected.</li> <li>• Consult the dealer or an experienced radio/TV technician for help.</li> </ul> <p>Caution : Any changes or modifications in construction of this device which are not expressly approved by the party responsible for compliance could void the user's authority to operate the equipment.</p>

FOR YOUR SAFETY		
<b>U.S.A CANADA</b>	<b>120 V</b>	<p>Units shipped to the U.S.A and Canada are designed for operation on 120 V AC only.</p> <p>Safety precaution with use of a polarized AC plug.                      However, some products may be supplied with a nonpolarized plug.</p> <p><b>CAUTION</b> : To prevent electric shock, match wide blade of plug to wide slot, fully insert.</p> <p><b>ATTENTION</b> : Pour éviter chocs électriques, introduire la lame la plus large de la fiche dans la borne correspondante de la prise et pousser jusqu' au fond.</p>

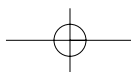

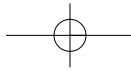

# SAFETY INSTRUCTIONS

1. **Read Instructions** - All the safety and operating instructions should be read before the product is operated.
2. **Retain instructions** - The safety and operating instructions should be retained for future reference.
3. **Heed Warnings** - All warnings on the product and in the operating instructions should be adhered to.
4. **Follow Instructions** - All operating and use instructions should be followed.
5. **Cleaning** - Unplug this product from the wall outlet before cleaning. Do not use liquid cleaners or aerosol cleaners. Use a damp cloth for cleaning.
6. **Attachments** - Do not use attachments not recommended by the product manufacturer as they may cause hazards.
7. **Water and Moisture** - Do not use this product near water - for example, near a bath tub, wash bowl, kitchen sink, or laundry tub; in a wet basement, or near a swimming pool; and the like.
8. **Accessories** - Do not place this product on an unstable cart, stand, tripod, bracket, or table. The product may fall, causing serious injury to a child or adult, and serious damage to the product. Use only with a cart, stand, tripod, bracket, or table recommended by the manufacturer, or sold with the product. Any mounting of the product should follow the manufacturer's instructions, and should use a mounting accessory recommended by the manufacturer.
9. A product and cart combination should be moved with care. Quick stops, excessive force, and uneven surfaces may cause the product and cart combination to overturn.
10. **Ventilation** - Slots and openings in the cabinet are provided for ventilation and to ensure reliable operation of the product and to protect it from overheating, and these openings must not be blocked or covered. The openings should never be blocked by placing the product on a bed, sofa, rug, or other similar surface. This product should not be placed in a built-in installation such as a bookcase or rack unless proper ventilation is provided or the manufacturer's instructions have been adhered to.
11. **Power Sources** - This product should be operated only from the type of power source indicated on the marking label. If you are not sure of the type of power supply to your home, consult your product dealer or local power company. For products intended to operate from battery power, or other sources, refer to the operating instructions.
12. **Grounding or Polarization** - This product may be equipped with a polarized alternating-current line plug (a plug having one blade wider than the other). This plug will fit into the power outlet only one way. This is a safety feature. If you are unable to insert the plug fully into the outlet, try reversing the plug. If the plug should still fail to fit, contact your electrician to replace your obsolete outlet. Do not defeat the safety purpose of the polarized plug.  
Alternate Warnings - This product is equipped with a three-wire grounding-type plug, a plug having a third (grounding) pin. This plug will only fit into a grounding-type power outlet. This is a safety feature. If you are unable to insert the plug into the outlet, contact your electrician to replace your obsolete outlet. Do not defeat the safety purpose of the grounding-type plug.
13. **Power-Cord Protection** - Power-supply cords should be routed so that they are not likely to be walked on or pinched by items placed upon or against them, paying particular attention to cords at plugs, convenience receptacles, and the point where they exit from the product.
14. **Outdoor Antenna Grounding** - If an outside antenna or cable system is connected to the product, be sure the antenna or cable system is grounded so as to provide some protection against voltage surges and built-up static charges. Article 810 of the National Electrical Code, ANSI/NFPA 70, provides information with regard to proper grounding of the mast and supporting structure, grounding of the lead-in wire to an antenna discharge unit, size of grounding conductors, location of antenna-discharge unit,



PORTABLE CART WARNING

connection to grounding electrodes, and requirements for the grounding electrode. See Figure 1.

Figure 1  
Example of antenna grounding as per National Electrical Code, ANSI/NFPA 70

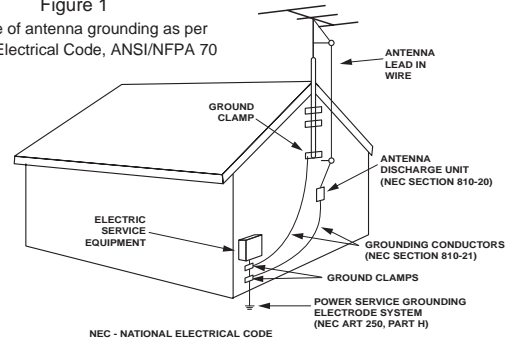

15. **Lightning** - For added protection for this product during a lightning storm, or when it is left unattended and unused for long periods of time, unplug it from the wall outlet and disconnect the antenna or cable system. This will prevent damage to the product due to lightning and power-line surges.
16. **Power Lines** - An outside antenna system should not be located in the vicinity of overhead power lines or other electric light or power circuits, or where it can fall into such power lines or circuits. When installing an outside antenna system, extreme care should be taken to keep from touching such power lines or circuits as contact with them might be fatal.
17. **Overloading** - Do not overload wall outlets, extension cords, or integral convenience receptacles as this can result in a risk of fire or electric shock.
18. **Object and Liquid Entry** - Never push objects of any kind into this product through openings as they may touch dangerous voltage points or short-out parts that could result in a fire or electric shock. Never spill liquid of any kind on the product.
19. **Servicing** - Do not attempt to service this product yourself as opening or removing covers may expose you to dangerous voltage or other hazards. Refer all servicing to qualified service personnel.
20. **Damage Requiring Service** - Unplug this product from the wall outlet and refer servicing to qualified service personnel under the following conditions:
  - a) When the power-supply cord or plug is damaged,
  - b) If liquid has been spilled, or objects have fallen into the product,
  - c) If the product has been exposed to rain or water,
  - d) If the product does not operate normally by following the operating instructions. Adjust only those controls that are covered by the operating instructions as an improper adjustment of other controls may result in damage and will often require extensive work by a qualified technician to restore the product to its normal operation.
  - e) If the product has been dropped or damaged in any way, and
  - f) When the product exhibits a distinct change in performance - this indicates a need for service.
21. **Replacement Parts** - When replacement parts are required, be sure the service technician has used replacement parts specified by the manufacturer or have the same characteristics as the original part. Unauthorized substitutions may result in fire, electric shock, or other hazards.
22. **Safety Check** - Upon completion of any service or repairs to this product, ask the service technician to perform safety checks to determine that the product is in proper operating condition.
23. **Wall or Ceiling Mounting** - The product should be mounted to a wall or ceiling only as recommended by the manufacturer.
24. **Heat** - The product should be situated away from heat sources such as radiators, heat registers, stoves, or other products (including amplifiers) that produce heat.

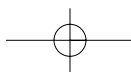

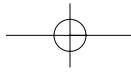

## CONTENTS

<b>Introduction</b>	Read This Before Operating Your Unit   2 Safety Instructions   3
<b>Controls</b>	Front of the TV   5 Back of the TV   6 Remote Control   7
<b>Installations</b>	CONNECTING VHF AND UHF ANTENNAS   8 CONNECTING CABLE TV   9 CONNECTING VCR   11 CONNECTING A S-VHS VCR   13 CONNECTING DVD PLAYER   13 CONNECTING DTV(SET-TOP BOX)   14 CONNECTING POWER DC INPUT   14 INSTALLING BATTERIES IN THE REMOTE CONTROL   15
<b>Operations</b>	TURNING THE POWER ON/OFF   16 VIEWING THE MENU   16 SETTING THE OSD TIMEOUT   17 SELECTING A MENU LANGUAGE   18 SELECTING INPUT SOURCE   19 ADJUSTING THE VOLUME   21 LISTENING WITH HEADPHONES   22 MEMORIZING THE CHANNELS   23 CHANGING CHANNELS   26 CUSTOMIZING THE PICTURE   28 USING AUTOMATIC PICTURE SETTINGS   29 CHANGING THE SCREEN SIZE   29 VIEWING THE CURRENT STATUS   29 CUSTOMIZING THE SOUND   30 SELECTING A SURROUND SOUND   31
<b>Special Features</b>	SELECTING THE BACKGROUND OF MENU   32 FINE TUNNING CHANNELS   32 CHOOSING A MULTI-CHANNEL SOUND (MTS) SOUNDTRACK   33 SETTING THE CLOCK   35 SETTING THE ON/OFF TIMER   36 SETTING THE SLEEP TIMER   39 VIEWING CLOSED CAPTIONS   40 ADJUSTING CLOSED CAPTION SETTINGS   41 BLOCKING THE CONTENTS   43 CHILD LOCK   48 FACTORY RESET   48
<b>PC Display</b>	USING YOUR TV AS A COMPUTER(PC) DISPLAY   49
<b>Troubleshooting</b>	56
<b>Appendix</b>	RETRACTABLE STAND   57 CLEANING AND MAINTAINING YOUR TV   57 USING YOUR TV IN ANOTHER COUNTRY   58
<b>Specification</b>	59

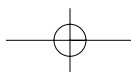

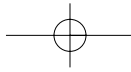

# Controls

## FRONT OF THE TV

The buttons on the front panel control our TV's basic features, including the on-screen menu. To use the more advanced features, you must use the remote control.

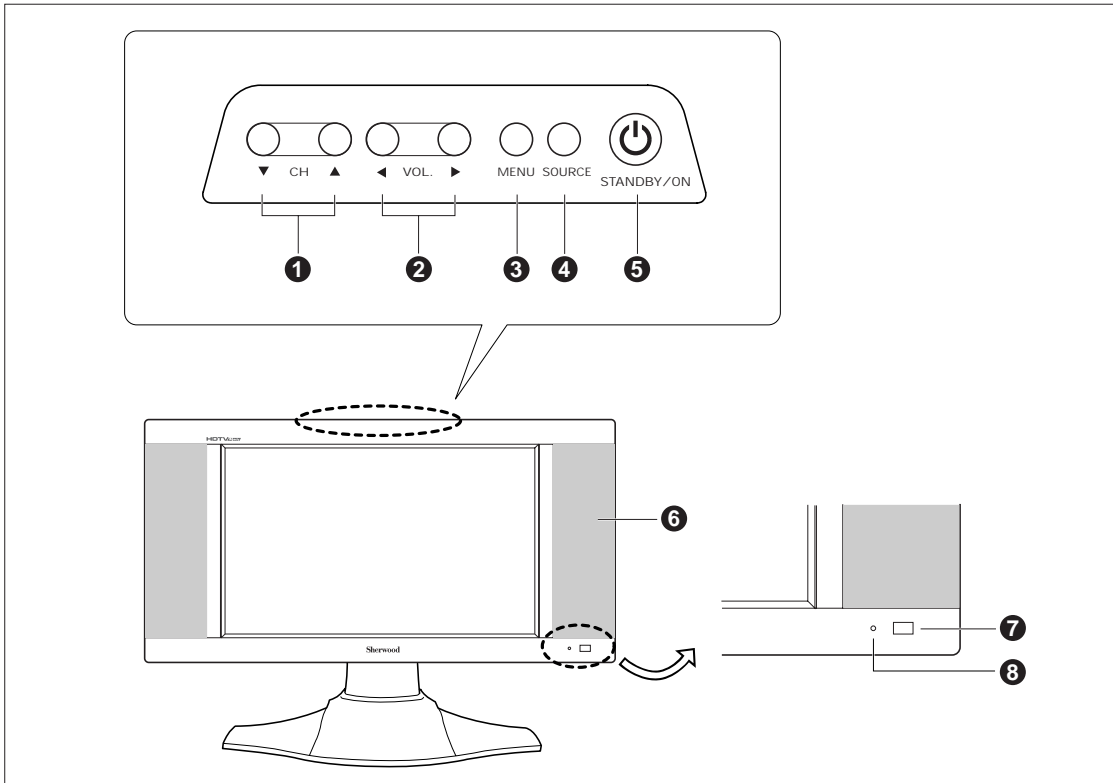

- 1 CHANNEL DOWN/UP (▼/▲)**  
Press to change channels. Also press to select various items on the on-screen menu.
- 2 VOLUME DOWN/UP (◀/▶)**  
Press to increase or decrease the volume. Also press to adjust selected the items on the on-screen menu.
- 3 MENU**  
Press to see an on-screen menu of your TV's features.
- 4 SOURCE**  
Press to select input source.
- 5 STANDBY/ON**  
Press to turn the TV on and off.
- 6 SPEAKER**
- 7 Remote Control Sensor**  
Aim the remote control towards this square on the TV.
- 8 STANDBY indicator**  
Lights up red when you turn the power off.

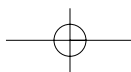

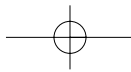

**BACK OF THE TV**

For more information on connecting equipment, see "Installations" on page 8 and "USING YOUR TV AS A COMPUTER(PC) DISPLAY" on page 49.

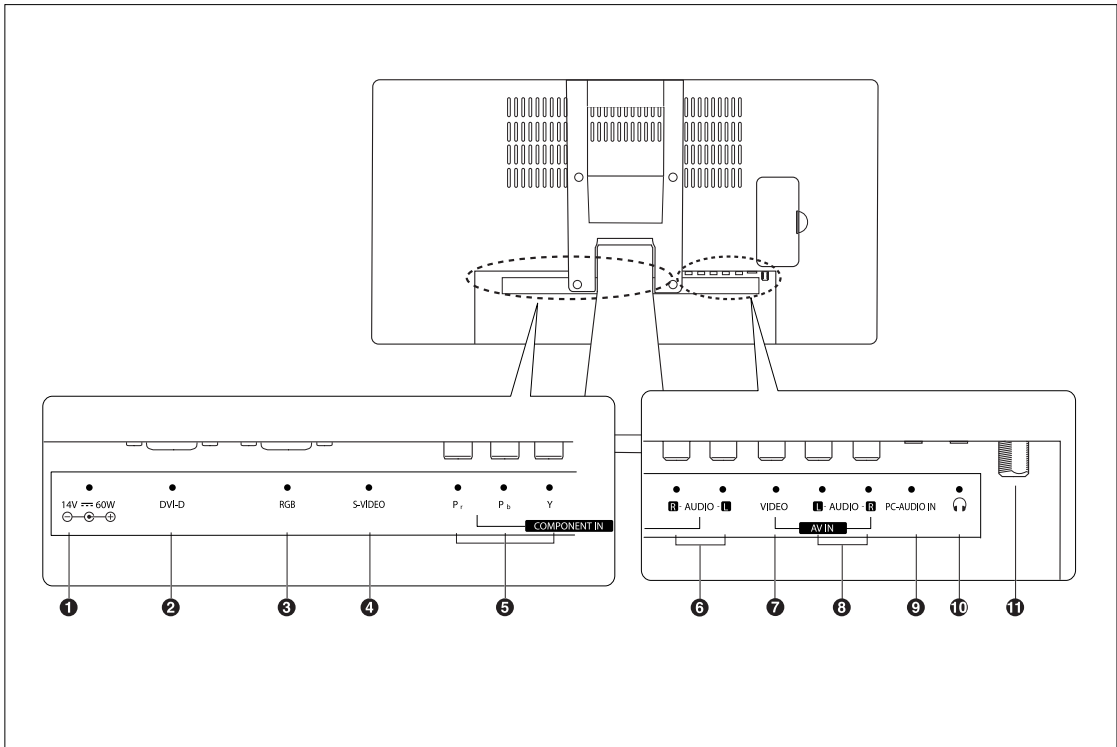

**1 POWER (DC) INPUT**

**2 DVI-D INPUT**

Connect to the DVI-D output port on your PC or set-top box.

**3 RGB INPUT**

Connect to the RGB output port on your PC or set-top box.

**4 S-VIDEO INPUT**

Connect to the S-Video jack of a VCR or camcorder, etc.

**5 COMPONENT VIDEO INPUT**

Connect to the component video jacks of a DVD player or a set-top box.

**6 COMPONENT AUDIO INPUT**

Connect to the audio jacks of a DVD player or a set-top box.

**7 COMPOSITE VIDEO INPUT**

Connect to the composite(normal) video jack of a VCR or camcorder, etc.

**8 AUDIO INPUT**

Connect to the audio jack of a VCR or camcorder, etc.

**9 PC AUDIO INPUT**

Connect to the audio output jacks on your PC or set-top box.

**10 HEADPHONE JACK**

Connect a set of external headphones to this jack for private listening.

**11 ANTENNA INPUT**

Connect to an antenna or a cable TV system.

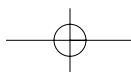

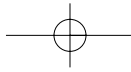

## REMOTE CONTROL

All the functions can be controlled with this remote control unit.  
Some functions can also be adjusted with the buttons on the front panel of the TV.

- 1 POWER ON**  
Turns the TV on.
- 2 NUMBER BUTTONS**  
Press to select channels directly on the TV.
- 3 PRE. CH (Previous Channel)**  
Tunes to the previous channel.
- 4 P.SIZE (Picture Size)**  
Press to change the screen size .
- 5 P.MODE (Picture Mode)**  
Press to select the preferred picture setting.
- 6 MENU/ENTER**  
Displays the main on-screen menu.
- 7 CHANNEL UP/DOWN (+/-)**  
Press CHANNEL + or - to change channels.
- 8 CAPTION**  
Controls the caption decoder.
- 9 CHILD LOCK**  
Press to lock the controlling TV with buttons on the top panel.

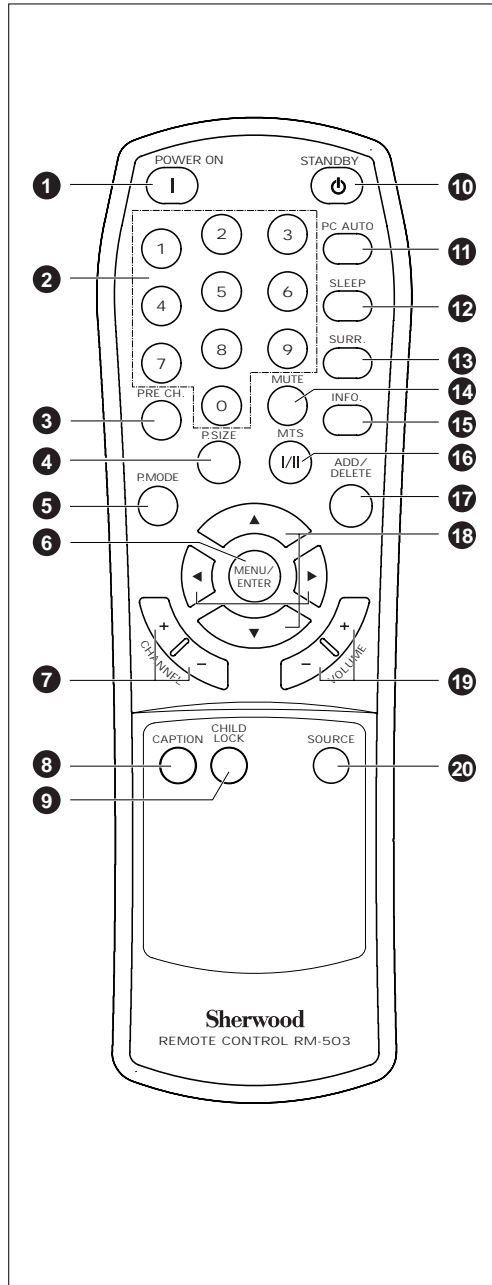

- 10 STANDBY**  
Turns the TV off.
- 11 PC AUTO**  
Press to center the screen automatically in PC mode.
- 12 SLEEP**  
Press to select a preset time interval for automatic shutoff.
- 13 SURROUND**  
Press to enjoy surround sound.
- 14 MUTE**  
Press to temporarily cut off the sound.
- 15 INFO.**  
Press to display current status.
- 16 MTS I/II (Multichannel Television Sound)**  
Press to choose stereo, mono or Second Audio Program(SAP broadcast).
- 17 ADD/DELETE**  
Press to add or delete channels in the TV's memory.
- 18 CURSOR CONTROL (▲, ▼, ◀, ▶)**  
Press to select various items or to adjust the selected item on the on-screen menu.
- 19 VOLUME UP/DOWN (+/-)**  
Press to increase or decrease the volume.
- 20 SOURCE**  
Press to select input signal source.

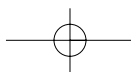

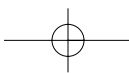

# Installations

## CONNECTING VHF AND UHF ANTENNAS

- Please be certain that TV is unplugged from the AC outlet before making any connections.
- Since different component often have different terminal names, carefully read the operating instructions of the component connected.

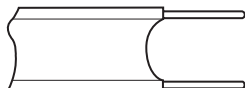

☞ If your antenna has a set of leads that look like this, see "Antennas with 300-ohm Flat Twin Leads" below.

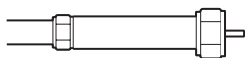

☞ If your antenna has one lead that looks like this, see "Antennas with 75-ohm Round Leads" below.

☞ If you have two antennas, see "Separate VHF and UHF Antennas", on page 9.

### Antennas with 300-ohm Flat Twin Leads

If you are using an off-air antenna antenna (such as a roof antenna or "rabbit ears") that has 300-ohm twin flat leads, follow the directions below.

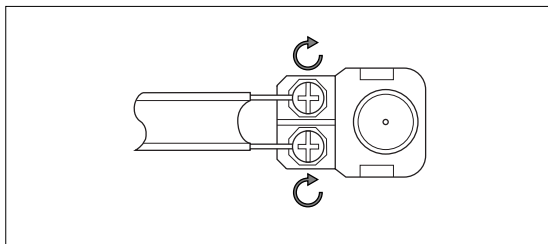

**1** Place the wires from the twin leads under the screws on a 300-75 ohm adaptor (not supplied). Use a screwdriver to tighten the screws.

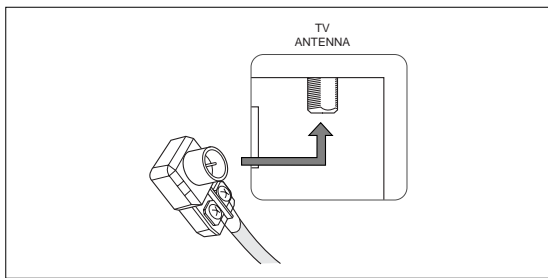

**2** Plug the adaptor into the TV antenna terminal on the rear panel.

### Antennas with 75-ohm Round Leads

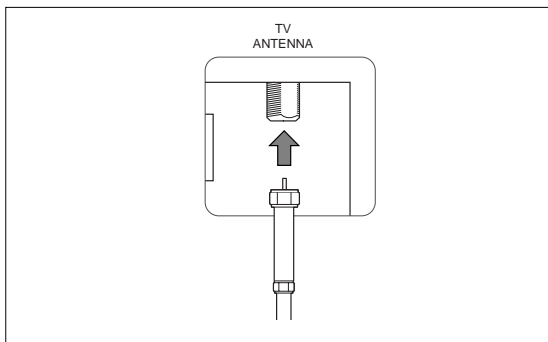

Plug the antenna lead into the TV antenna terminal on the rear panel.

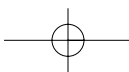



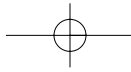

### Separate VHF and UHF Antennas

If you have two separate antennas for your TV (one VHF and one UHF), you must combine the two antenna signals before connecting the antennas to the TV. This procedure requires an optional combiner-adaptor (available at most electronics shops).

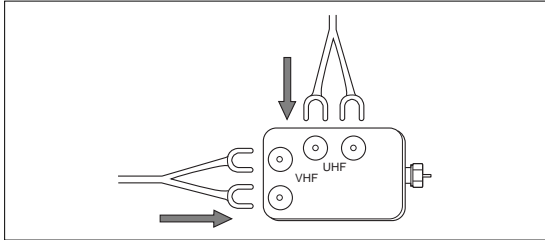

**1** Connect both antenna leads to the combiner.

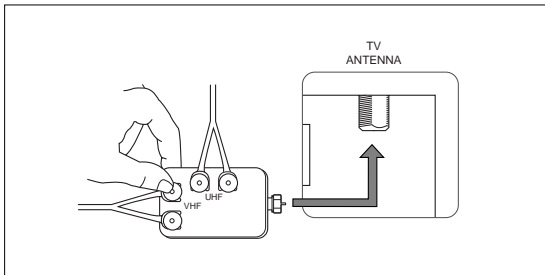

**2** Plug the combiner into the TV antenna terminal on the rear panel.

### CONNECTING CABLE TV

To connect to a cable TV system, follow the instructions below.

#### Cable without a Cable Box

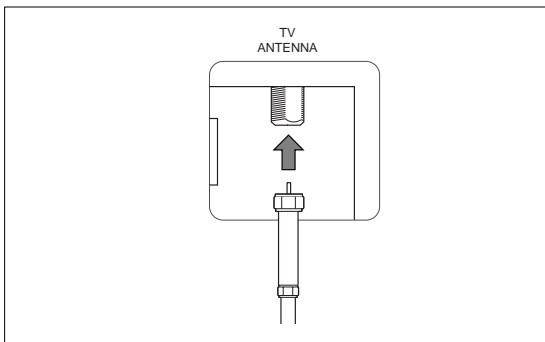

Plug the incoming cable into the TV antenna terminal on the rear panel.

▶ Because this TV is cable-ready, you do not need a cable box to view unscrambled cable channels.

#### Connecting to a Cable Box that Descrambles All Channels

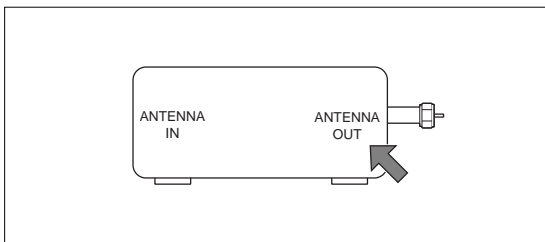

**1** Find the cable that is connected to the ANTENNA OUT terminal on your cable box.

▶ This terminal might be labeled "ANT OUT", "VHF OUT", or simply, "OUT".

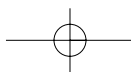

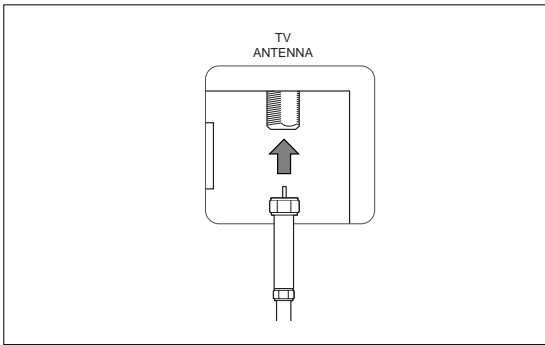
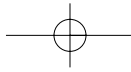

**2** Connect the other end of this cable to the TV antenna terminal on the rear panel.

### Connecting to a Cable Box that Descrambles Some Channels

If your cable box descrambles only some channels (such as premium channels), follow the instructions below. You will need a two-way splitter, an RF(A/B) switch, and four lengths of coaxial cable. (These items are available at most electronics stores.)

**1** Find and disconnect the cable that is connected to the ANTENNA IN terminal on your cable box.  
 ▶ This terminal might be labeled "ANT IN", "VHF IN", or simply "IN".

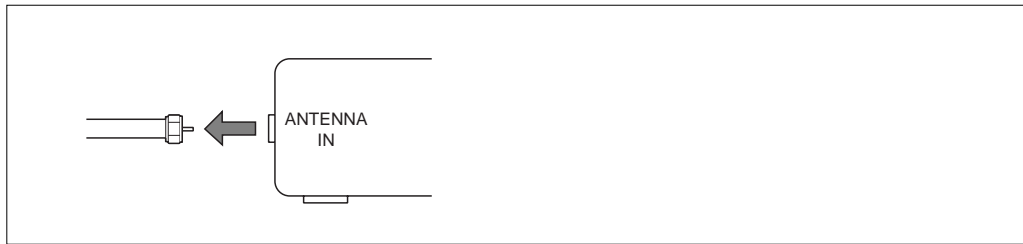

**2** Connect this cable to a two-way splitter.

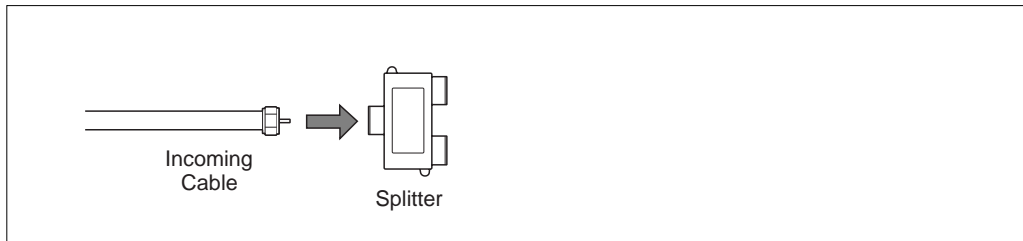

**3** Connect a coaxial cable between an OUTPUT terminal on the splitter and the IN terminal on the cable box.

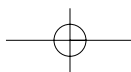
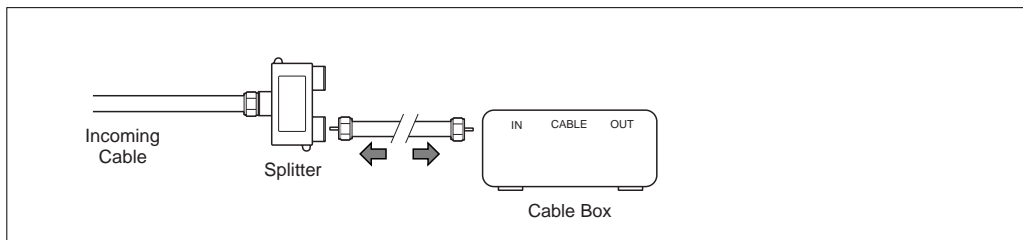

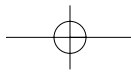

**4**

Connect a coaxial cable between the ANTENNA OUT terminal on the cable box and the B-IN terminal on the A/B switch.

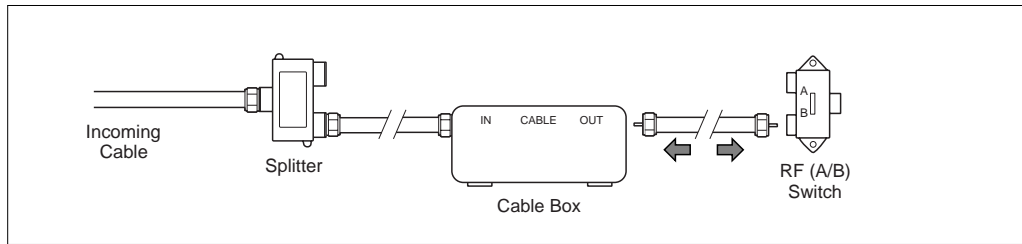

**5**

Connect another cable between the other OUT terminal on the splitter and the A-IN terminal on the RF(A/B) switch.

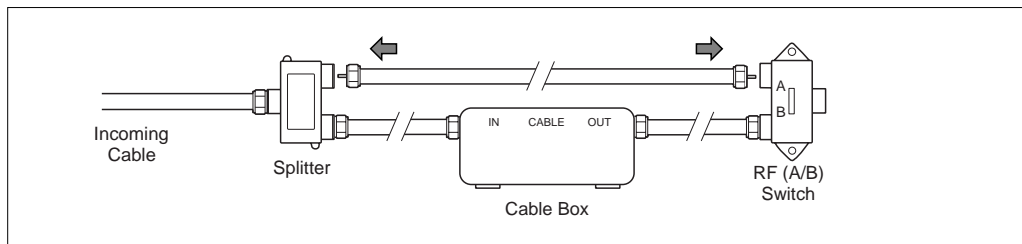

**6**

Connect the last coaxial cable between the OUT terminal on the RF(A/B) switch and the VHF/UHF terminal to the TV antenna terminal on the rear panel.

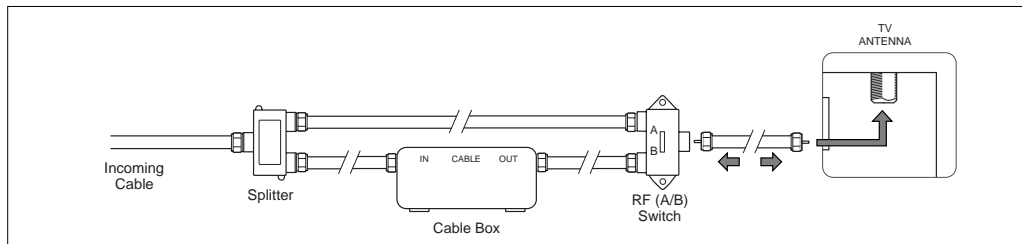

After you've made this connection, set the A/B switch to the "A" position for normal viewing. Set the A/B switch to the "B" position to view scrambled channels. (When you set the A/B switch to "B", you will need to tune your TV to the cable box's output channel, which is usually channel 3 or 4.)

**CONNECTING VCR**

These instructions assume that you have already connected your TV to an antenna or a cable TV system (according to the instructions on pages 8 - 9). Skip step 1 if you have not yet connected to an antenna or a cable system.

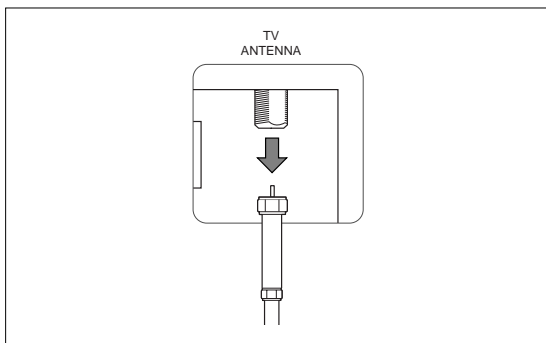

**1**

Unplug the cable or antenna from the rear of the TV.

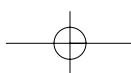

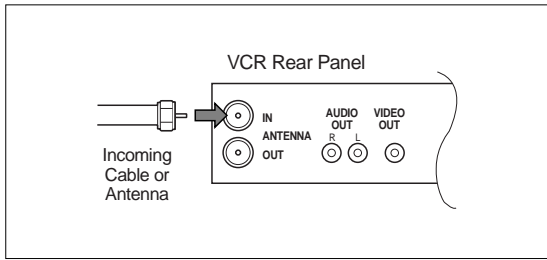
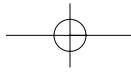

**2**

Connect the cable or antenna to the ANTENNA IN terminal on the rear panel VCR.

**3**

Connect a coaxial cable between the ANTENNA OUT terminal on the VCR and the antenna terminal on the TV.

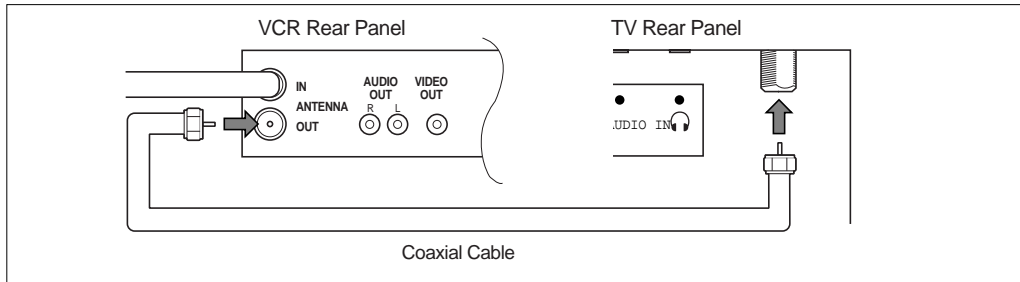

▶ A coaxial cable is usually included with a VCR. (If not, check your local electronics store.)

**4**

- Connect a set of audio cables between the AUDIO OUT jacks on the VCR and the AUDIO L/R jacks on the TV.
- Connect a video cable between the VIDEO OUT jack on the VCR and the COMPOSITE jack on the TV.

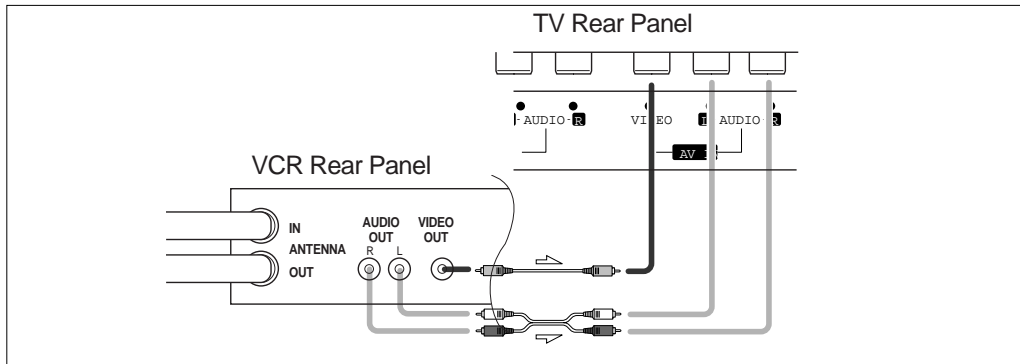

▶ If you have a "mono" (non-stereo) VCR, use the Y-connector (not supplied) to hook up to the left and right audio input jacks of the TV. If your VCR is stereo, you must connect two cables.

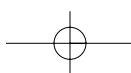

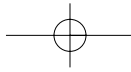

## CONNECTING A S-VHS VCR

Your TV can be connected to an s-video signal from an S-VHS VCR.  
(This connection delivers a better picture as compared to a standard VHS VCR.)

**1**

To begin, follow steps 1-3 in the previous section to connect the antenna or cable to your VCR and your TV.

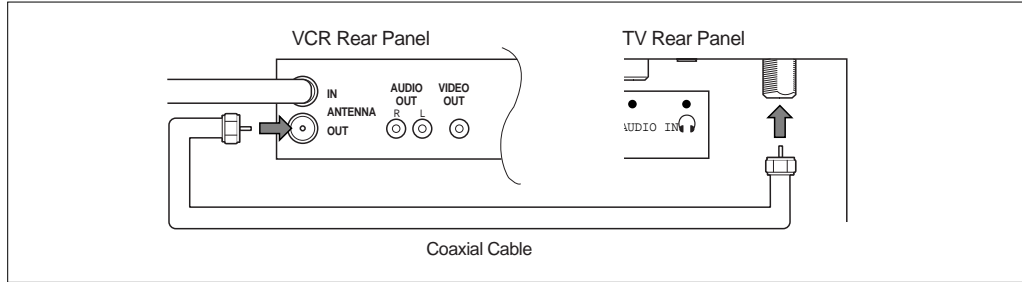

**2**

- Connect a set of audio cables between the AUDIO OUT jacks on the VCR and the AUDIO L/R jacks on the TV.
- Connect a S-Video cable between the S-VIDEO OUT jack on the VCR and the S-VIDEO jack on the TV.

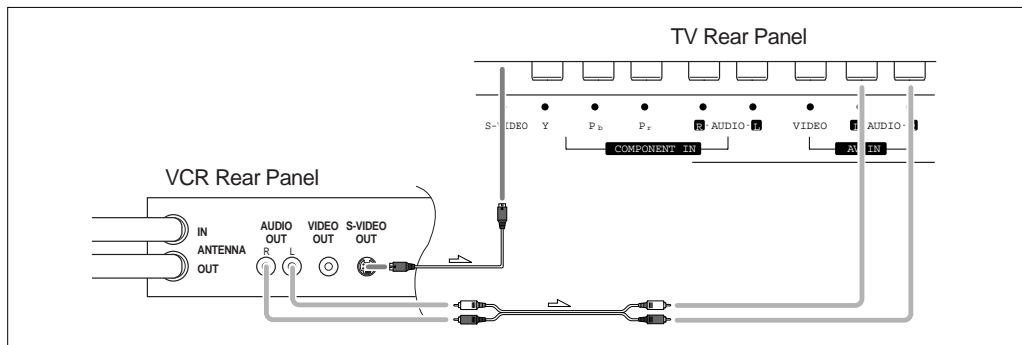

► The S-Video cable is usually included with an S-VHS VCR. (If not, check your local electronics store.)

## CONNECTING DVD PLAYER

- Connect a set of audio cables between the AUDIO L/R jacks on the TV and the AUDIO OUT jacks on the DVD player.
- Connect a video cable between the COMPONENT (P<sub>R</sub>, P<sub>B</sub>, Y) jacks on the TV and the P<sub>R</sub>, P<sub>B</sub>, Y (or C<sub>R</sub>, C<sub>B</sub>, Y) jacks on the DVD player.

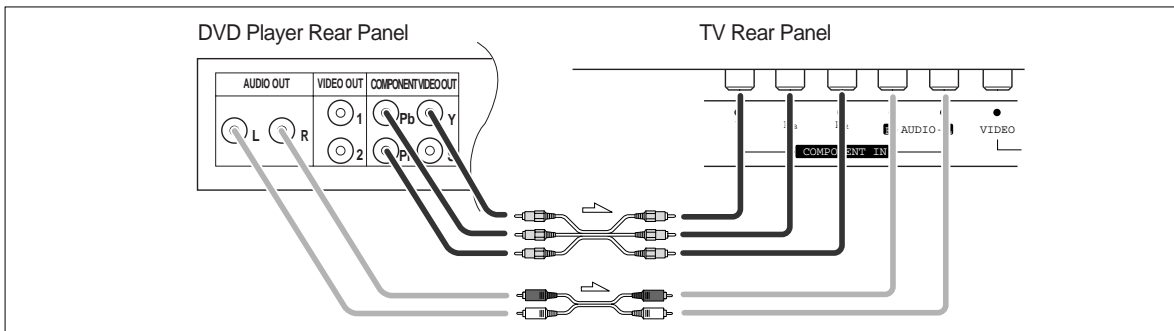

► For an explanation of component video, see your owner's manual of DVD player.

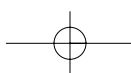

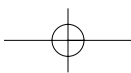

## CONNECTING SET-TOP BOX

The connections for a typical set-top box are shown below.

- Connect a set of audio cable between the AUDIO L/R jacks on the TV and the AUDIO OUT jacks on the set-top box.
- Connect a video cable between the COMPONENT (P<sub>R</sub>, P<sub>B</sub>, Y) jacks on the TV and the P<sub>r</sub>, P<sub>b</sub>, Y jacks on the set-top box.
- If the set-top box has a DVI-D OUT or a VGA OUT, you can connect using a DVI-D cable or a VGA cable. In this case, connect AUDIO OUTS of the set-top box to PC AUDIO IN using a Y-shaped audio cable.

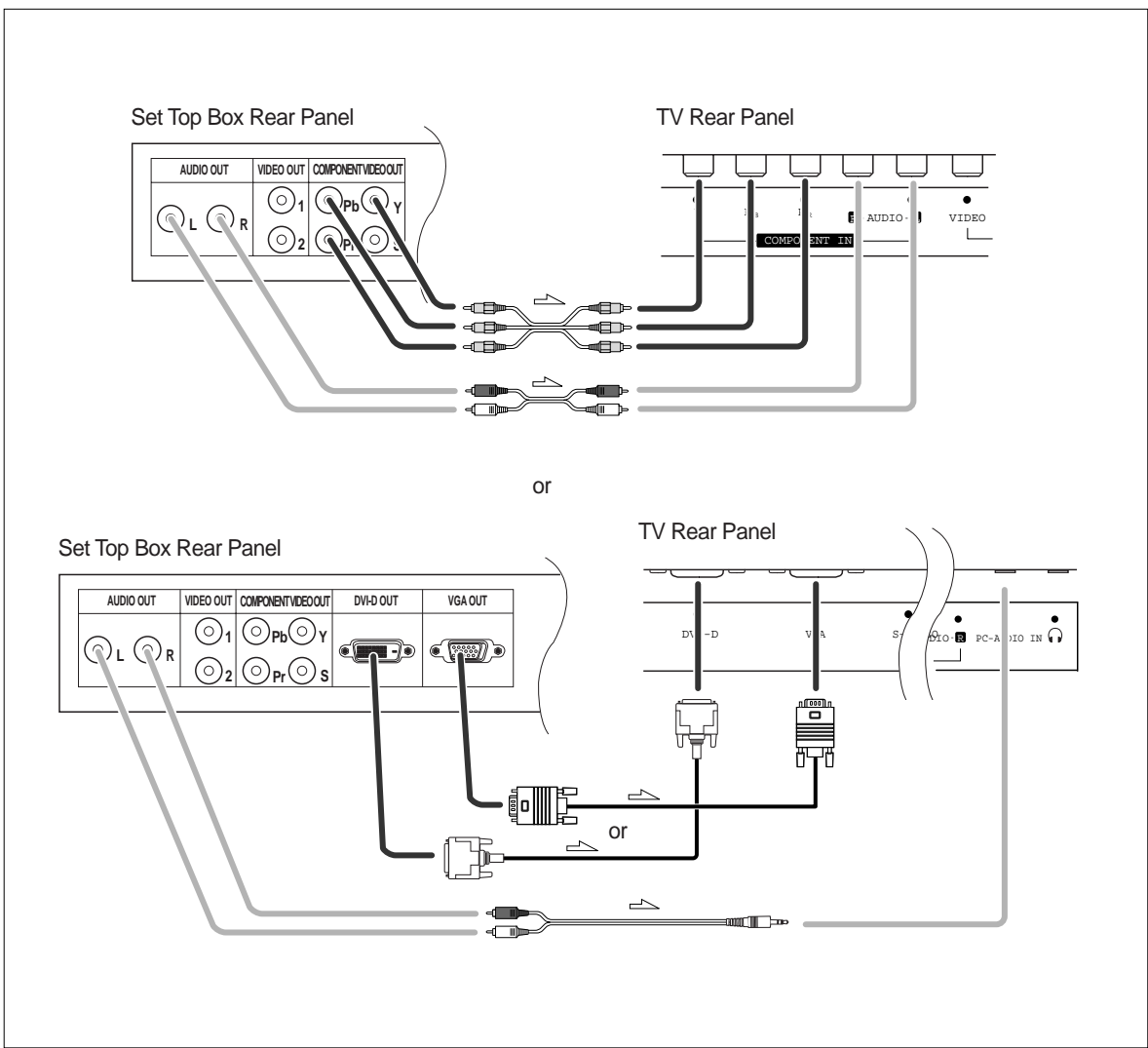

- ▶ For an explanation of video jack, see the owner's manual of set-top box.
- ▶ Connect the desired of different video outs to your TV and select the corresponding input source depending on the video signal to be output from each video out jack to see it, referring to the following table.

video signal	selectable input source	
	COMPONENT 1	COMPONENT 2, VGA, DVI-D
480i	○	×
480p	×	○

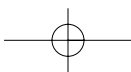

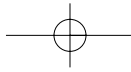

## CONNECTING POWER DC INPUT

- Connect to the power DC input terminal on the TV

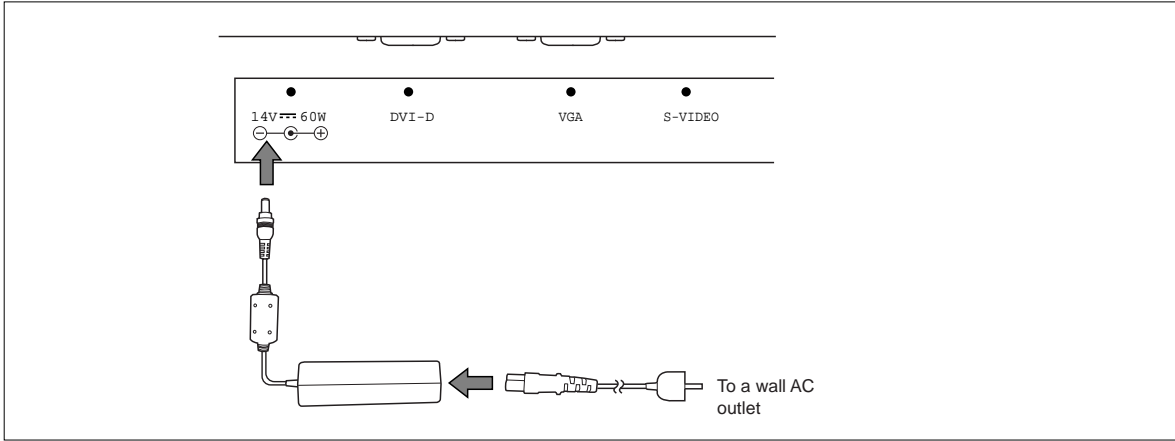

- ▶ Do not use an AC adapter other than the one supplied with this TV. The AC adapter supplied is designed for use with this TV. If other AC adapter is used, this could damage this unit or result in a risk of fire.

## INSTALLING BATTERIES IN THE REMOTE CONTROL

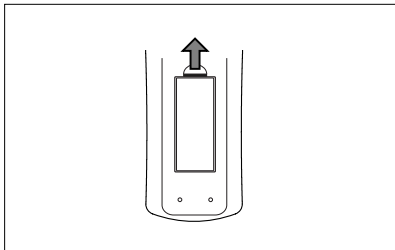

**1**

Pull the battery cover upward in the directions shown by the arrow and remove it.

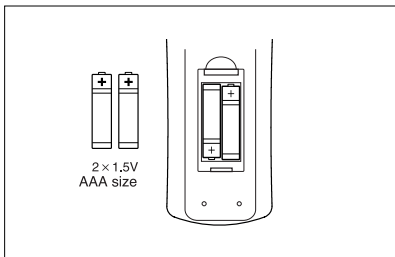

**2**

Insert two batteries (AAA size). Make sure to match the "+" and "-" ends of the batteries with the diagram inside the compartment.

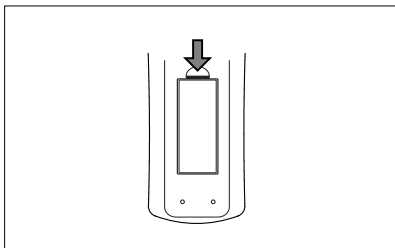

**3**

Replace the battery cover.

- ▶ The remote control can be used up to about 23 feet from the TV.
- ▶ Remove the batteries and store them in a cool, dry place if you won't be using the remote control for a long time.

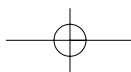

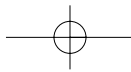

# Operations

## TURNING THE POWER ON/OFF

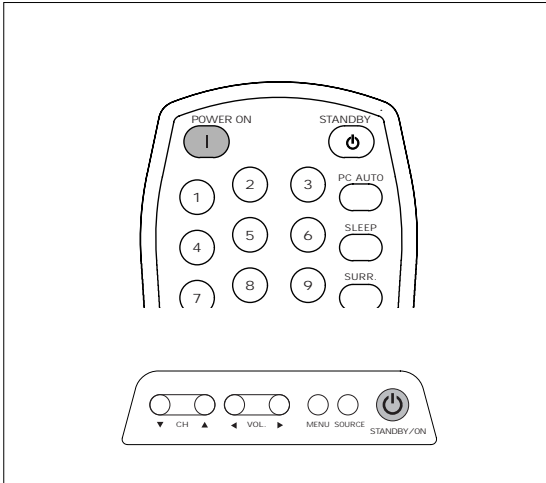

**1**

To turn the power on, press the POWER ON button on the remote control. You can also use the STANDBY/ON button on top of the TV.

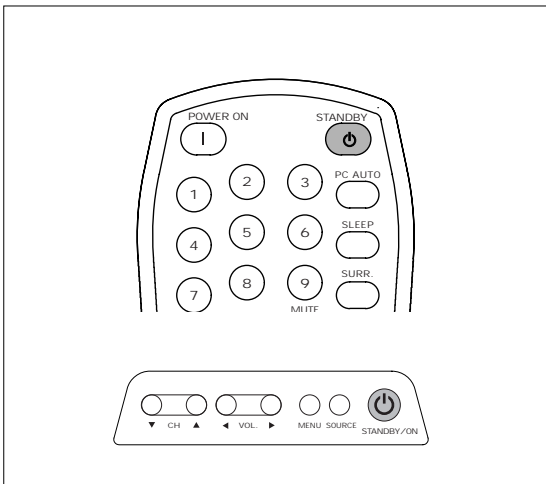

**2**

To turn the power off, press the STANDBY button on the remote control. You can also use the STANDBY/ON button on top of the TV.

In STANDBY mode, the standby indicator on the front panel lights up red.

- ▶ If the electricity fails or the AC input cord is unplugged while the power is on and plugged it again, your TV enters directly into STANDBY mode.
- ▶ When the power operation is in STANDBY mode, the apparatus is still connected on some AC line voltages. Please be sure to unplug the cord when you leave home for, say, a vacation.

## VIEWING THE MENU

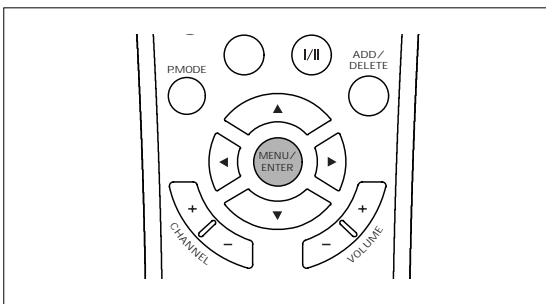

**1**

After turning the power on, press MENU/ENTER button. The main menu appears on the screen. Its left side has 4 icons: Channel, Adjust, Setup, Sound.

- ▶ The on-screen menus disappear from the screen after several seconds. Displaying time can be adjusted in the [Setup]-[osd] menu. See page 17 for details.
- ▶ Depending on input source and some operation status, some menus cannot be selected and the conditions of menu may differ.

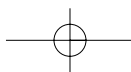



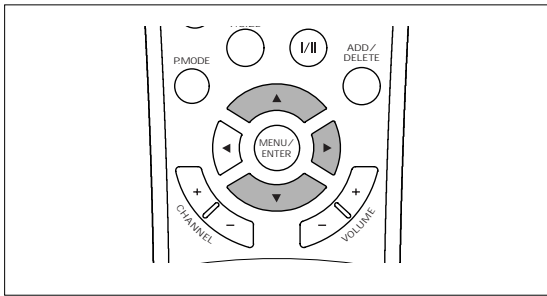
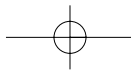

**2**

Use the ▲ or ▼ button to select one of the icons. Then press ► and ▲ or ▼ button to access the icon's sub-menu.

► You can also use the MENU, CH and VOL. buttons on the top panel of the TV to make selections.

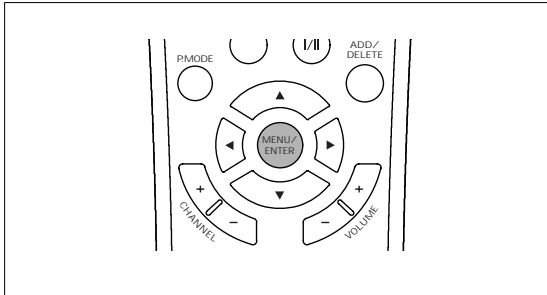

**3**

Press the MENU/ENTER button to exit.

## SETTING THE OSD SETUP

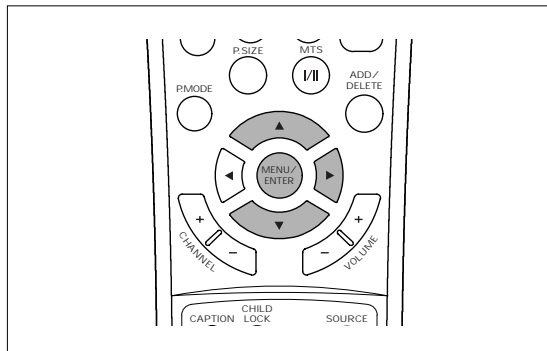

**1**

Press the MENU/ENTER button to display the menu and select [Setup] menu using ▲/▼ buttons. Then press ► button to access its menu.

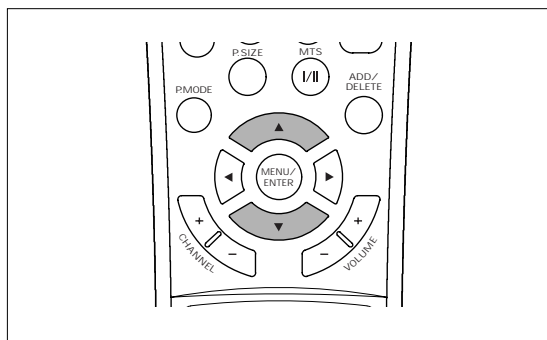

**2**

Press ▲ or ▼ button to select [osd].

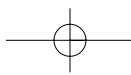

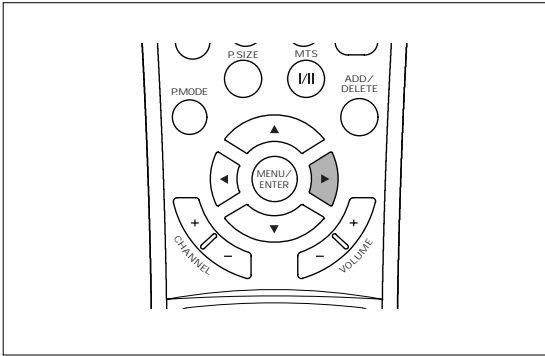
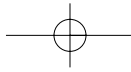

**3** Press ► button to enter osd setup menu.

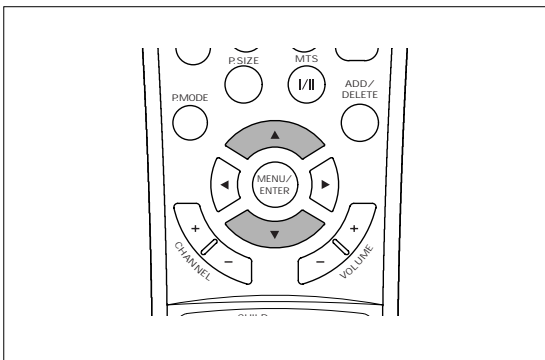

**4** Press ▲ or ▼ and ► button to select the desired item.

Each time the button is pressed, the item will be selected as follows:  
 language : When selecting a osd language of english, french, spanish, italian, german.  
 osd time : When selecting appropriate displaying time within the range of 5-60 seconds.  
 transparency : When adjusting transparency of menu background.  
 osd h pos : When adjusting horizontal of menu.  
 osd v pos : When adjusting vertical of menu.

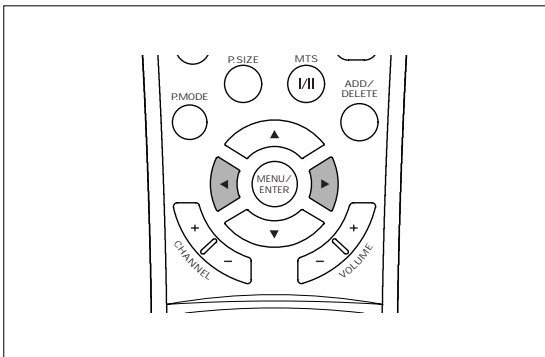

**5** Press ◀ or ▶ button to adjust as desired.  
 To adjust other items as desired, repeat the above steps 4 and 5.

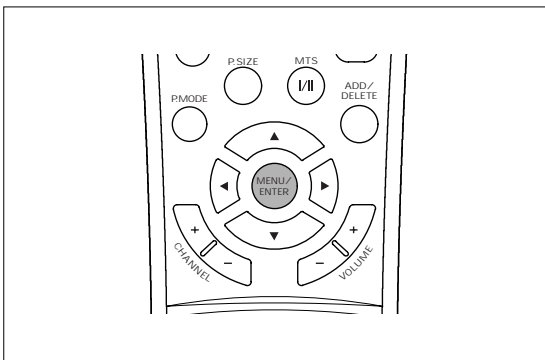

**6** Press the MENU/ENTER button repeatedly to exit.

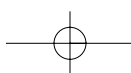

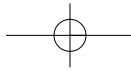

**SELECTING INPUT SOURCE**

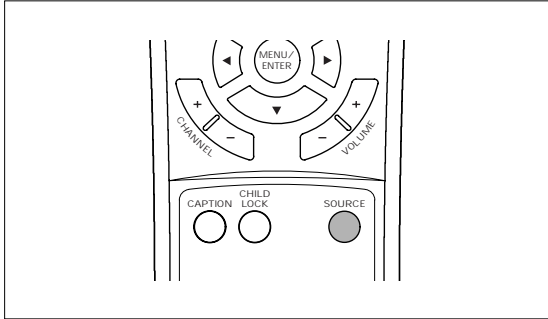

**1**

Press the SOURCE button.  
Then SOURCE SELECT menu is displayed for several seconds.

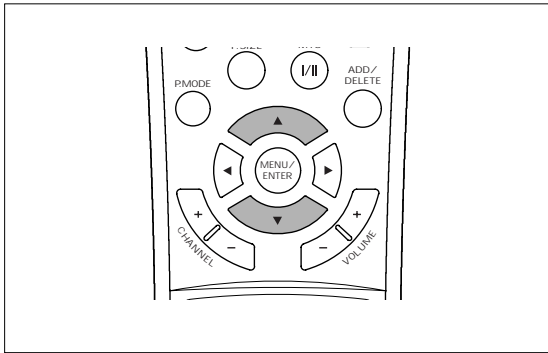

**2**

Press ▲ or ▼ button to select a source among VGA, DVI-D, COMPOSITE, S-VIDEO, COMPONENT 1, COMPONENT 2 and TV.

- Choose "COMPONENT 1" when watching with 480i video signal (conventional interlaced video signal).
- Choose "COMPONENT 2" when watching with 480p video signal (progressively scanned video signal).

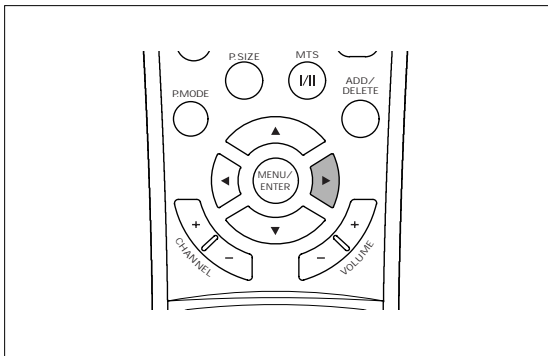

**3**

Press ► button to confirm your selection.

- In case of selecting VGA or DVI-D, refer to "USING YOUR TV AS A COMPUTER(PC) DISPLAY" on page 49.

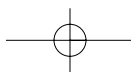

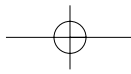

## Selecting a Broadcast Source

When you select the TV mode as input source, you should select the broadcast source.

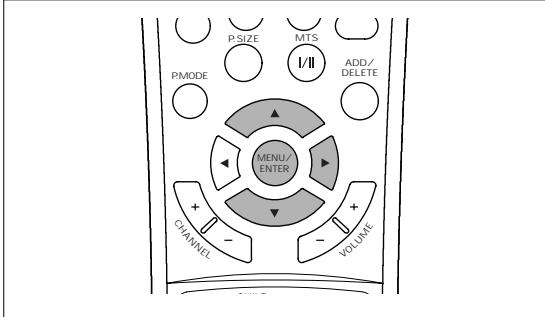

1

Press the MENU/ENTER button to display the menu and select [Channel] menu using ▲/▼ buttons. Then press ► button to access its menu.

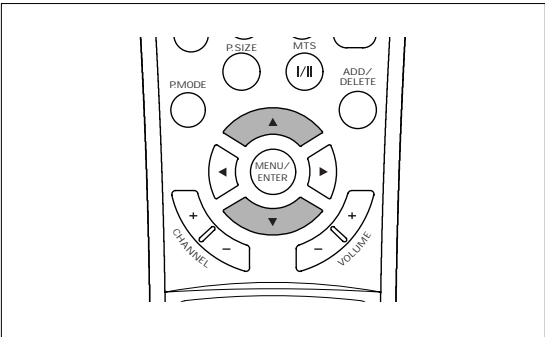

2

Press ▲ or ▼ button to select [source].

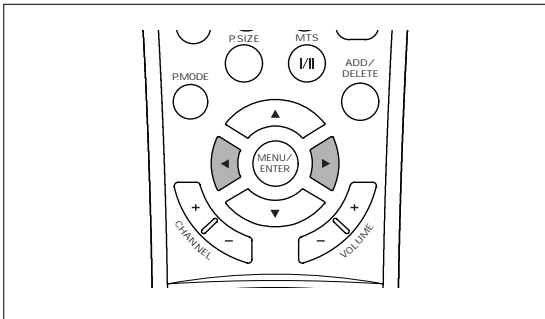

3

Press ◀ or ▶ button to select the “air”(antenna) or “cable”.

- air : when viewing air(antenna) channels
- cable : cable viewing cable channels

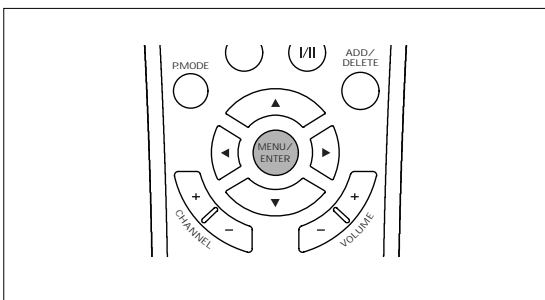

4

Press the MENU/ENTER button repeatedly to exit.

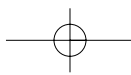

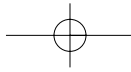

**ADJUSTING THE VOLUME**

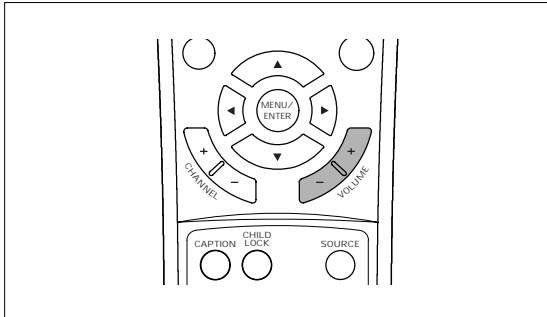

Press the VOLUME + or VOLUME - button to increase or decrease the volume.

**Using Mute**

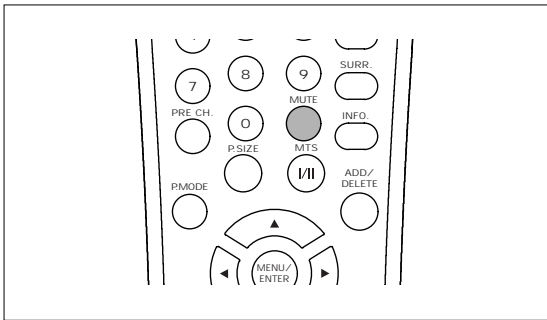

**1**

Press the MUTE button  
Then the sound is cut off and ~~⊗~~ is displayed.

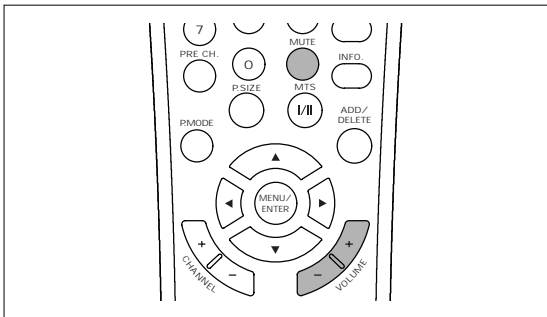

**2**

To turn mute off, press the MUTE button again or VOLUME +/- button, etc.

**LISTENING WITH HEADPHONES**

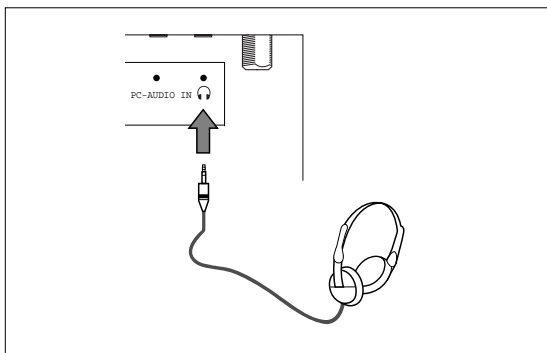

Plug the headphones into the headphone jack on rear of the TV.

No sound is heard from the TV speakers.

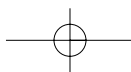

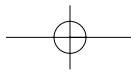

## MEMORIZING THE CHANNELS

Once you have memorized the available channels, you can use the CH +/- buttons to scan the memorized channels. Channels can be tuned with automatic or manual method. Before memorizing channels, first select the broadcast source. (Refer to "Selecting a Broadcast Source" on page 20 )

### Storing Channels in Memory (Automatic Method)

All of the receivable channels can be stored by this method. You would better use this method during installation of your TV.

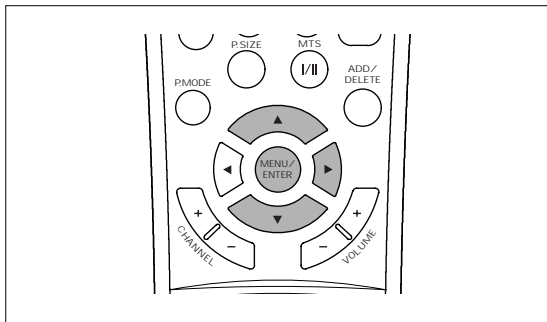

1

Press the MENU/ENTER button to display the menu and select [Channel] menu using ▲/▼ and ► buttons to access the icon's sub-menu.

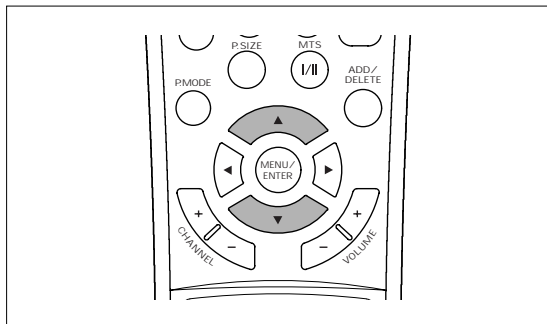

2

Press ▲ or ▼ button to select [auto search].

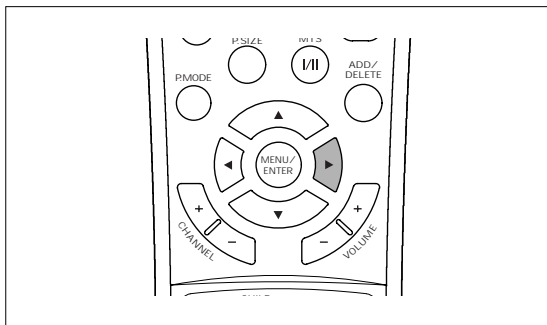

3

Press ► button to begin autotest.

To stop autotest, press the MENU/ENTER button.

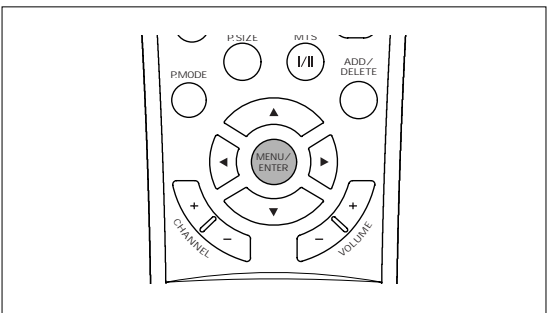

4

Press the MENU/ENTER button repeatedly to exit.

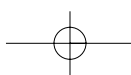

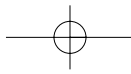

## Adding and Erasing Channels (Manual Method)

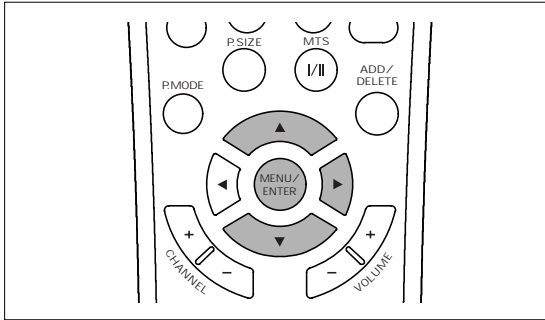

1

Press the MENU/ENTER button to display the menu and select [Channel] menu using ▲/▼ buttons. Then press ► button to access its menu.

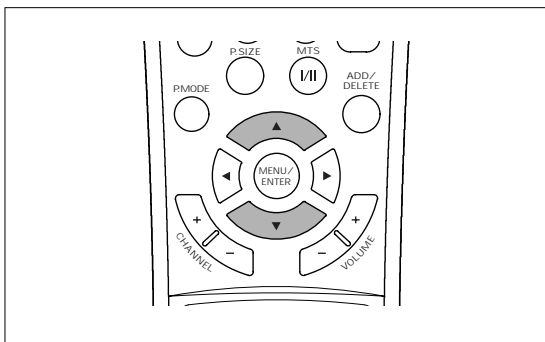

2

Press ▲ or ▼ button to select [channel].

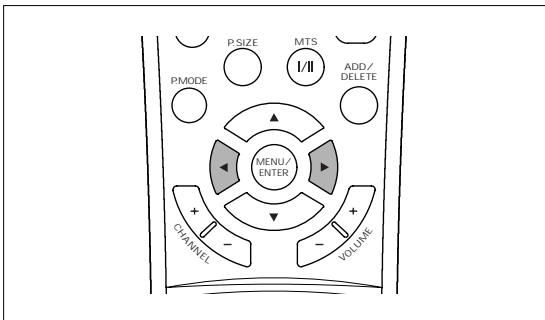

3

Press ◀ or ▶ button to select a channel to be added or erased.

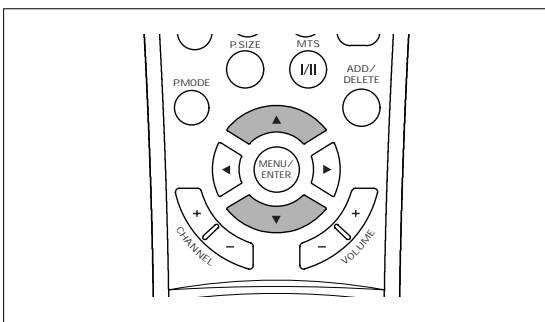

4

Press ▲ or ▼ button to select [edit channel].

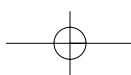

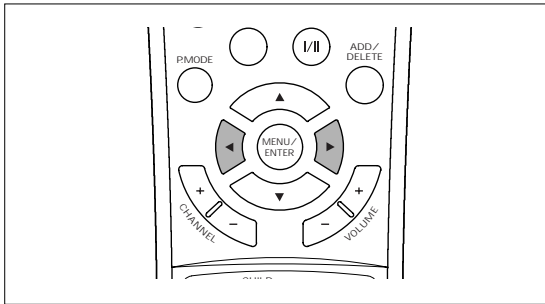
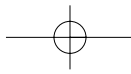

**5**

Press ◀ or ▶ button to select "add" or "delete".

After selecting one of them, the corresponding channel is added or erased.

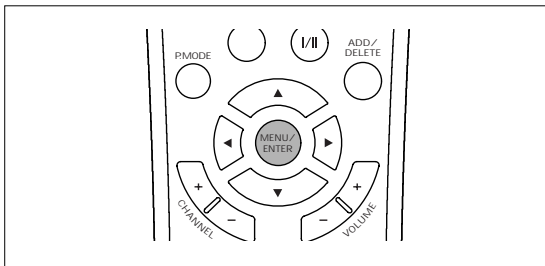

**6**

If you want to add or erase another channel(s), repeat the upper steps 1 to 5. If not, press MENU/ENTER button repeatedly to exit.

▶ You can view any channel (including an erased channel) by using the number buttons on the remote control.

**Quick way**

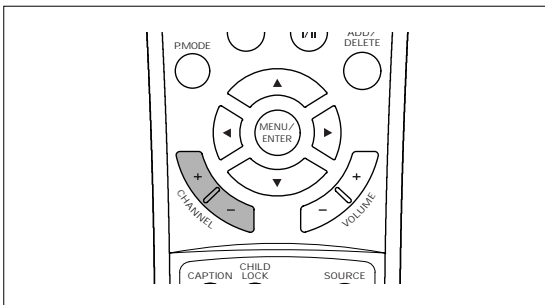

**1**

Select the channel you want to erase by pressing CHANNEL +/- buttons.

▶ You can view any channel (including an erased channel) by using the number buttons on the remote control.

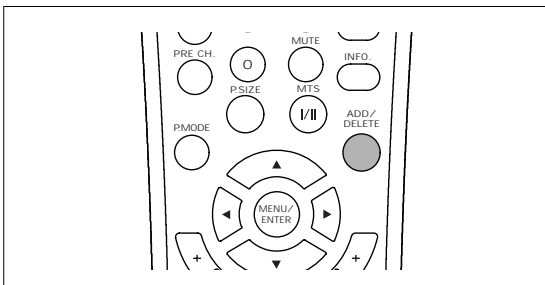

**2**

Press ADD/DELETE button to select "add" or "delete".

**3**

If you want to add or delete another channel(s), repeat the above steps 1 to 2.

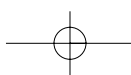



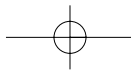

## CHANGING CHANNELS

### Using On-Screen Menu

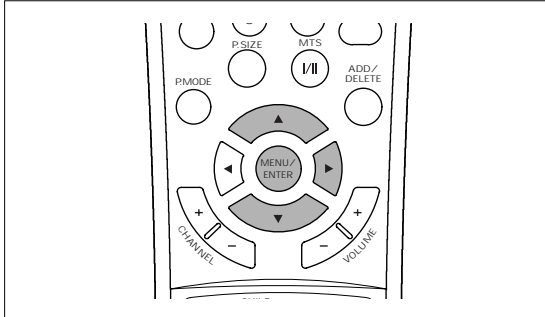

1

Press the MENU/ENTER button to display the menu and select [Channel] menu using ▲/▼ buttons. Then press ► button to access its menu.

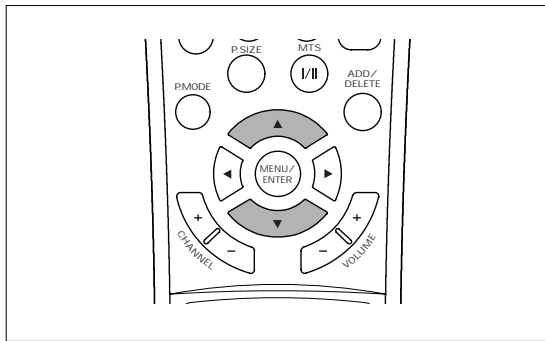

2

Press ▲ or ▼ button to select [channel].

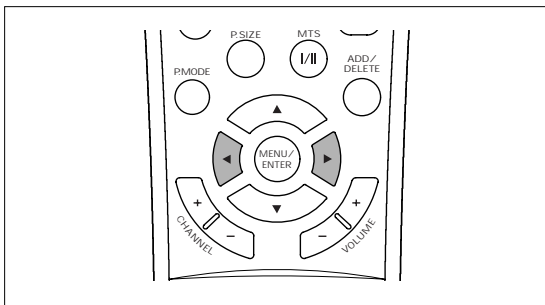

3

Press ◀ or ▶ to change channels.

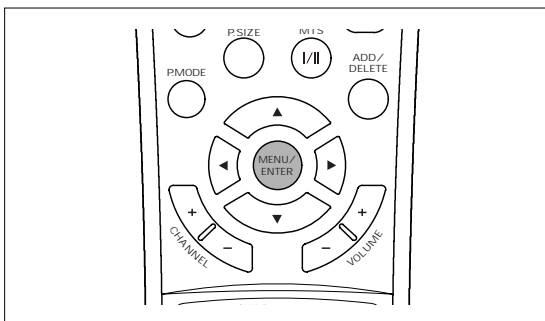

4

Press MENU/ENTER button repeatedly to exit.

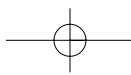

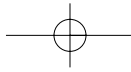

### Using the Channel +/- Buttons

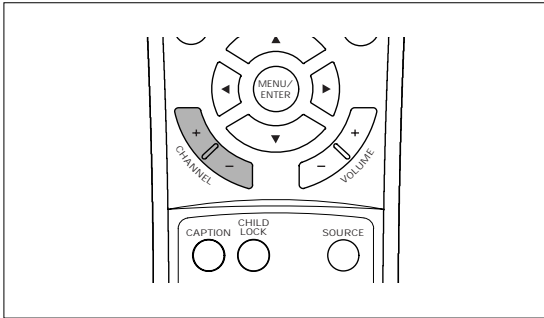

Press the CHANNEL + or CHANNEL - button to change channels.

Whenever you press these buttons, the TV changes channels in sequence. You will see all the channels that have been memorized. You will not see channels that were either erased or not memorized.

### Directly Accessing Channels

Use the number buttons to quickly tune to any channel, even that was erased or not memorized.

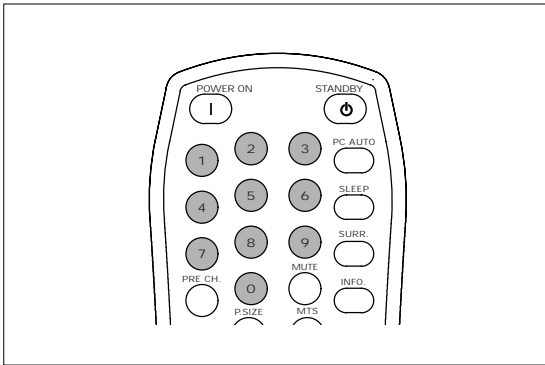

Press the number buttons to go directly to a channel.

For example, to select channel 71, press "7", then "1". The TV will change channels after you press the second number.

You can also change to single-digit channels as follows: for channel 7,  
 just press "7"  
 or "0", then "7"  
 or "0", "0" then "7" (in case of selecting "cable" in [source] menu)

### Selecting the Previous Channel

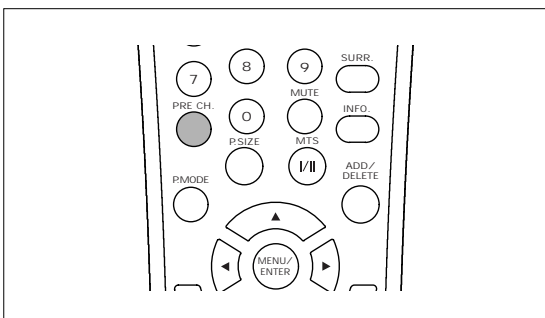

Press the PRE CH. button.  
 The TV will switch to the last channel viewed.

To quickly switch between two channels that are far apart, tune to one channel, then use the number button to select the second channel. Then, use the PRE.CH button to quickly alternate between them.

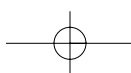

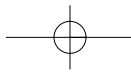

## CUSTOMIZING THE PICTURE

You can adjust the brightness, contrast, tint, color and sharpness according to personal preference (each item can be varied depending on the input source.).

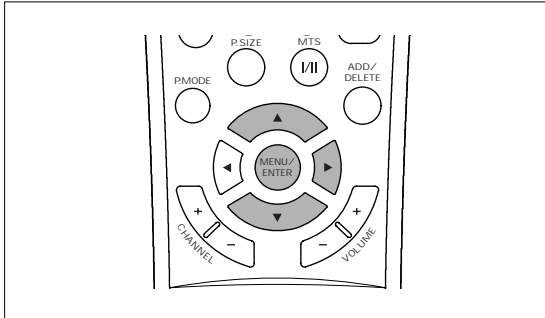

1

Press the MENU/ENTER button to display the menu and select [Adjust] menu using ▲/▼ buttons. Then press ► button to access its menu.

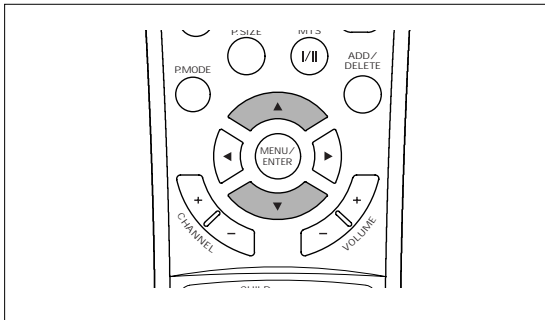

2

Press ▲ or ▼ button to select a particular item.

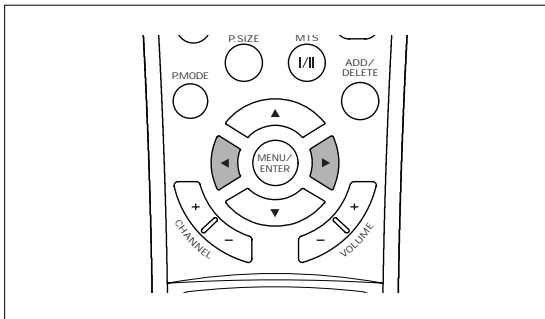

3

Press ◀ or ▶ button to change the value of a particular item. For example, if you select [brightness], pressing ▶ increases it. To adjust other items as desired, repeat the above steps 1 to 3.

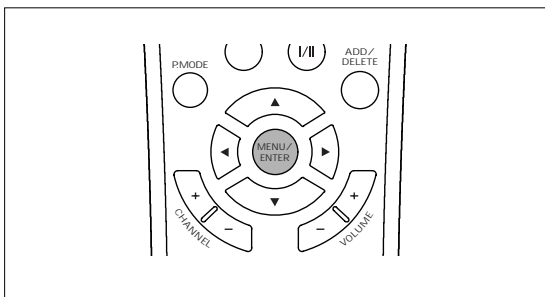

4

Press the MENU/ENTER button repeatedly to exit.

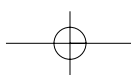

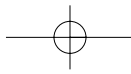

## CHANGING THE SCREEN SIZE

You can select the desired screen size only for input source other than VGA, DVI-D, COMPONENT 2.

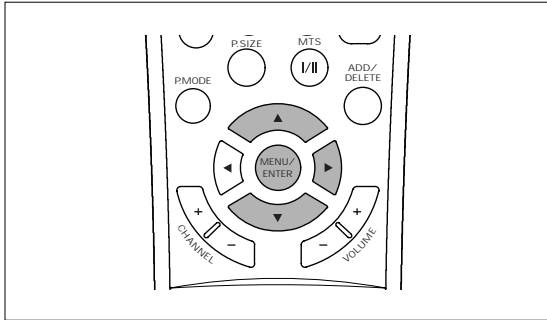

**1** Press the MENU/ENTER button to display the menu and select [Adjust] menu using ▲/▼ buttons. Then press ► button to access its menu.

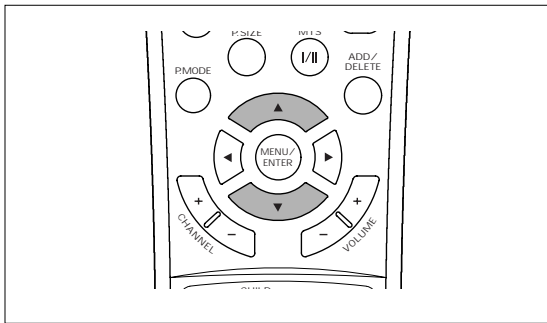

**2** Press ▲ or ▼ button to select [picture size].

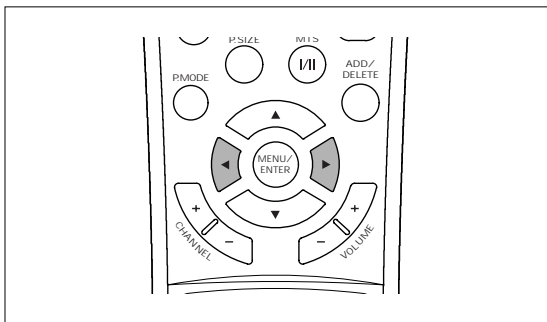

**3** Press ◀ or ▶ button to select one of picture size settings.

- Choose “normal” to set the picture to 4:3 normal mode. This is a standard TV screen size.
- Choose “wide” to set to 16:9 wide mode.
- Choose “fill all” to view 4:3 programs in full screen.
- Choose “anamorphic” to view 2.35:1 anamorphic DVDs in full screen

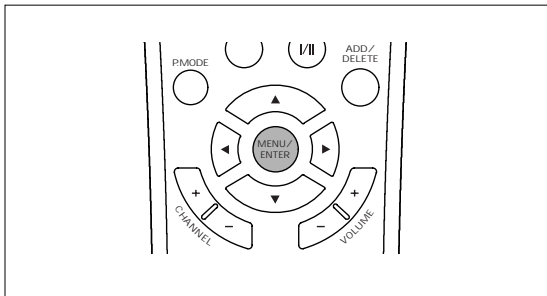

**4** Press the MENU/ENTER button repeatedly to exit.

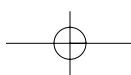

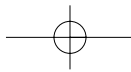

**Quick way**

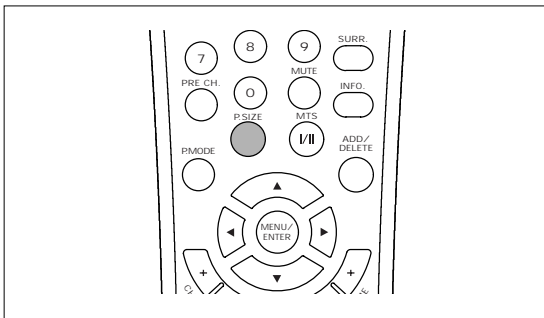

Press the P.SIZE button to select one of the screen size settings.

- Choose "normal" to set the picture to 4:3 normal mode. This is a standard TV screen size.
- Choose "wide" to set to 16:9 wide mode.
- Choose "fill all" to view 4:3 programs in full screen.
- Choose "anamorphic" to view 2.35:1 anamorphic DVDs in full screen

**USING AUTOMATIC PICTURE SETTINGS**

Your TV has three automatic picture settings ("normal", "movie", "bright" and "sharp") that are preset at the factory. You can select the desired picture setting only for input source other than PC ANALOG, PC DIGITAL, COMPONENT 2.

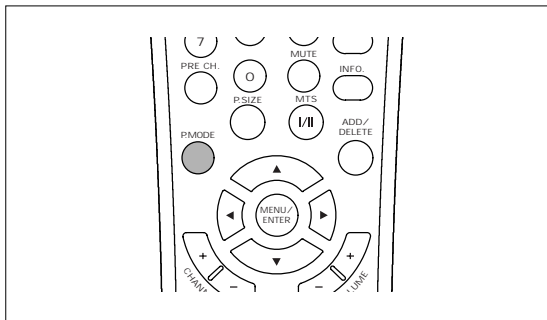

Press the P.MODE button to select one of the picture settings.

- Choose "normal" for normal screen.
- Choose "movie" to enjoy a movie as in a theater.
- Choose "bright" for brighter screen.
- Choose "sharp" for more shaep screen.

**VIEWING THE CURRENT STATUS**

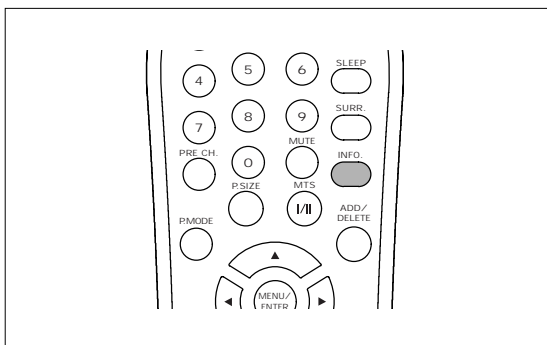

Press the INFO button on the remote control. TV will display the current input source and video signal information, etc.

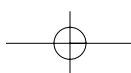

## CUSTOMIZING THE SOUND

The [bass], [treble] and [balance] can be adjusted to suit your personal preference.  
[bass] and [treble] can be selected when the [surround mode] is set to "user". Refer to next page.

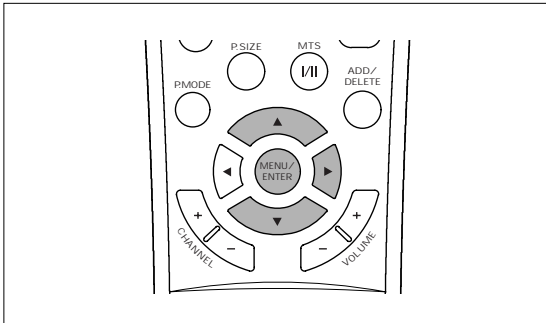

**1**

Press the MENU/ENTER button to display the menu and select [Sound] menu using ▲/▼ buttons.  
Then press ► button to access its menu.

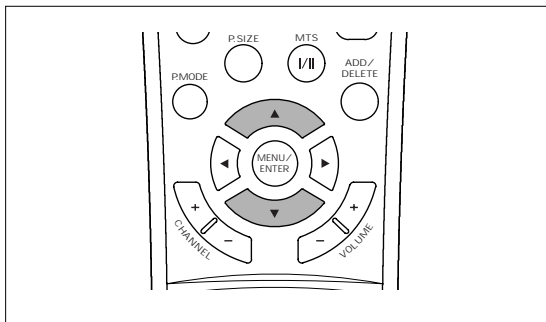

**2**

Press ▲ or ▼ button to select a particular item.

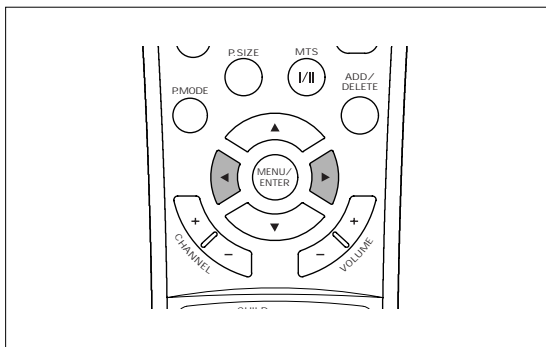

**3**

Press ◀ or ▶ button to change the value of a particular item.  
For example, if you select [treble], pressing ► button increases it.  
To adjust other items as desired, repeat the above steps 1 to 3.

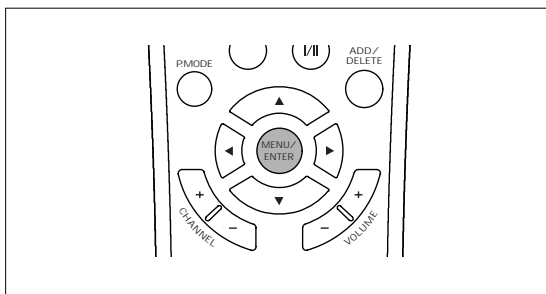

**4**

Press the MENU/ENTER button repeatedly to exit.

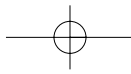

## SELECTING A SURROUND SOUND

Your TV has five automatic sound settings ([standard], [music], [movie], [sports], [news], and [user]) that are preset at the factory. You can select the desired of them.

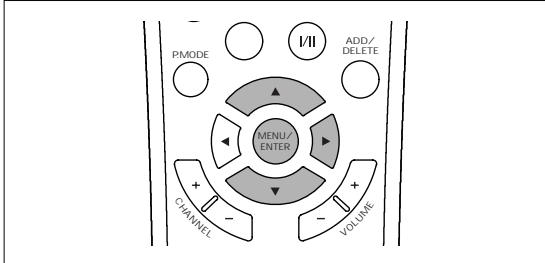

**1**

Press the MENU/ENTER button to display the menu and select [Sound] menu using ▲/▼ buttons. Then press ► button to access its menu.

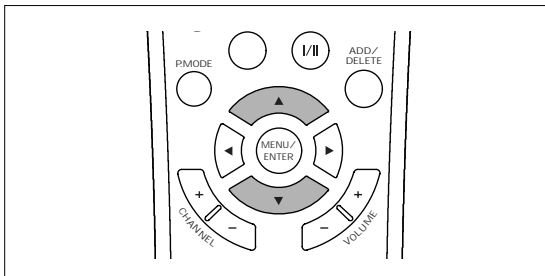

**2**

Press ▲ or ▼ button to select [surround mode].

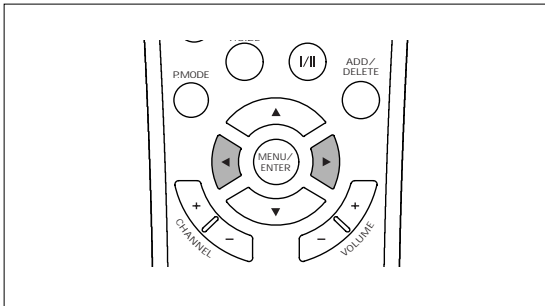

**3**

Press ◀ or ▶ button to select an appropriate surround mode.

- Choose “standard” for the standard factory settings.
- Choose “music” when watching music video or concert.
- Choose “movie” when watching movies.
- Choose “sports” when watching sport games.
- Choose “news” when watching news that is mostly dialogue.
- Choose “user” when adjusting audio items as you want.

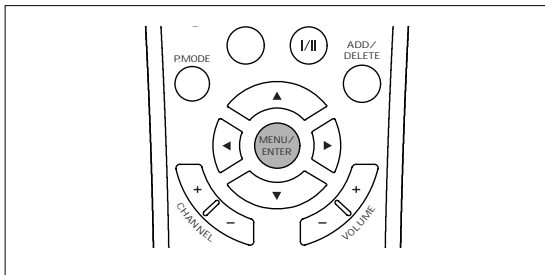

**4**

Press the MENU/ENTER button repeatedly to exit.

### Quick way

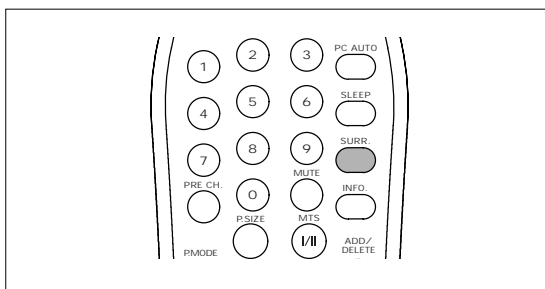

Press the SURR. button.

Each time this button is pressed, the surround mode changes as follows:

standard → music → movie → sports → news  
→ user

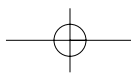

# Special Features

## FINE TUNING CHANNELS

Use fine tuning to manually adjust a particular channel for optimal reception. Generally, fine tuning is only necessary if reception is poor.

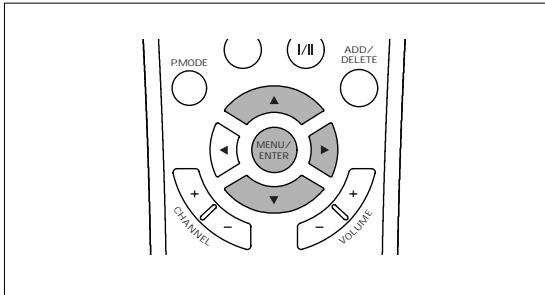

1

Press the MENU/ENTER button to display the menu and select [Channel] menu using ▲/▼ buttons. Then press ► button to access its menu.

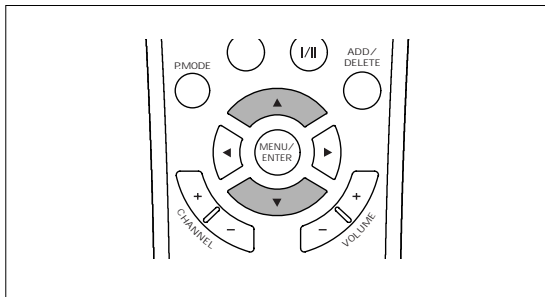

2

Press ▲ or ▼ button to select [fine tune].

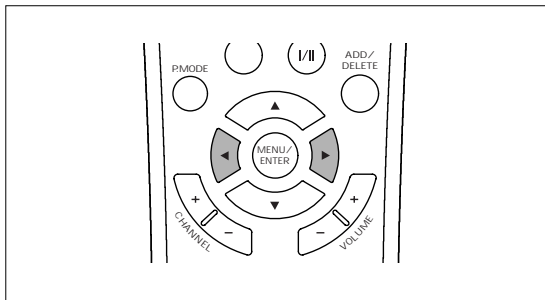

3

Press ◀ or ▶ button to adjust the fine tuning.

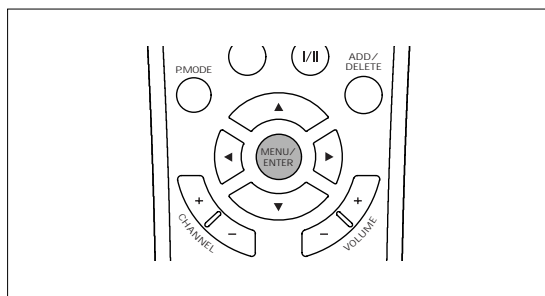

4

Press the MENU/ENTER button repeatedly to exit .



## CHOOSING A MULTI-CHANNEL SOUND (MTS) SOUNDTRACK

Depending on the particular program being broadcast, you can listen to stereo, mono, or a second Audio Program. (SAP audio is usually a foreign-language translation. Sometimes SAP has unrelated information like news and weather.)

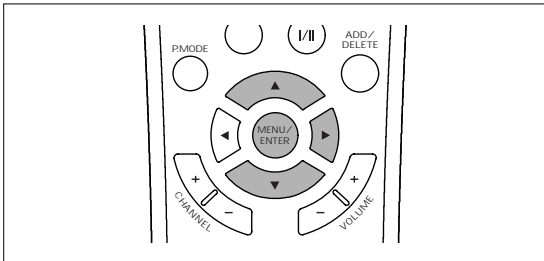

- 1 Press the MENU/ENTER button to display the menu and select [Sound] menu using ▲/▼ buttons. Then press ► button to access its menu.

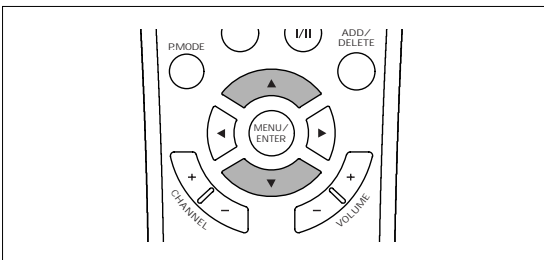

- 2 Press ▲ or ▼ button to select [mts mode].

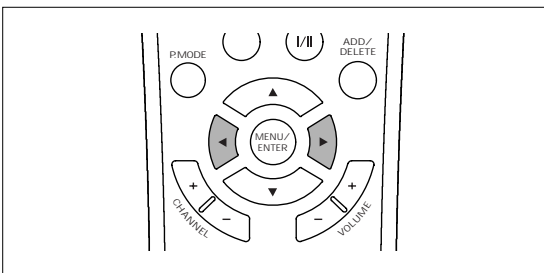

- 3 Press ◀ or ▶ button to select "mono" or "stereo".

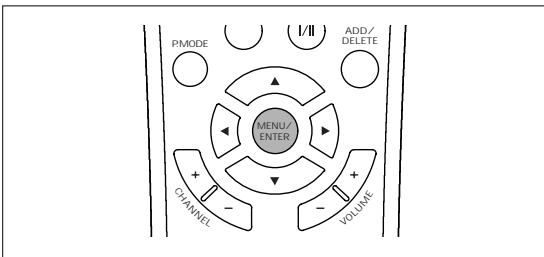

- 4 Press MENU/ENTER button repeatedly to exit.

### Quick way

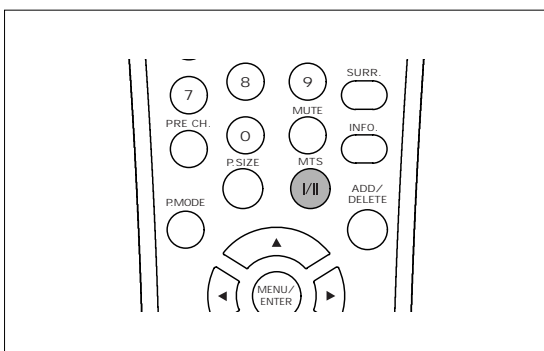

Press the MTS I/II button to select the desired mode.

#### • Mono sound selection

In stereo reception if the stereo signal is weak, you can switch to mono by pressing the MTS I/II button. In mono reception the depth of sound is improved. To switch back to stereo, press the MTS I/II button twice again.

#### • Language selection for dual language broadcast

If a program is received in two languages (dual language), you can switch to DUAL I, DUAL II or DUAL I+II by pressing the MTS I/II button repeatedly.

## SETTING THE CLOCK

Setting the clock is necessary in order to use the timer features of the TV.

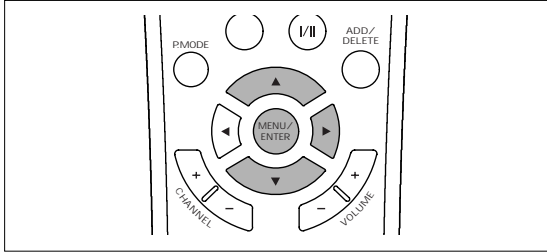

1

Press the MENU/ENTER button to display the menu and select [Setup] menu using ▲/▼ buttons. Then press ► button to access its menu.

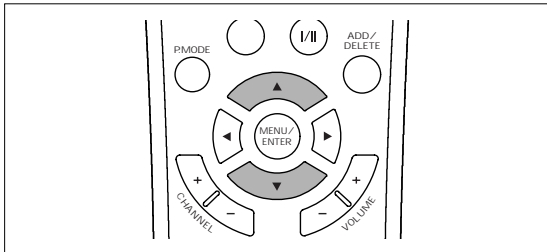

2

Press ▲ or ▼ button to select [time].

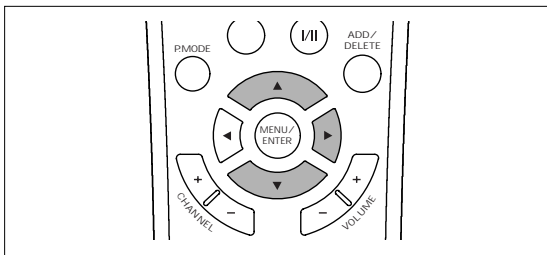

3

Press ► button to enter time setup menu. Then press ▲ or ▼ to select [clock].

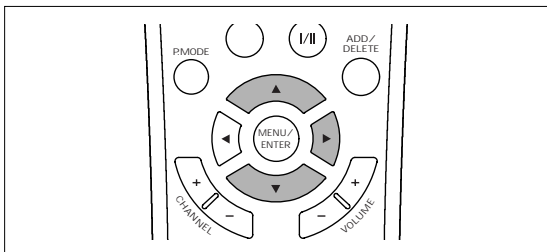

4

Press ► button. Then press ▲ or ▼ repeatedly or hold down either of these buttons until the correct hour appears.

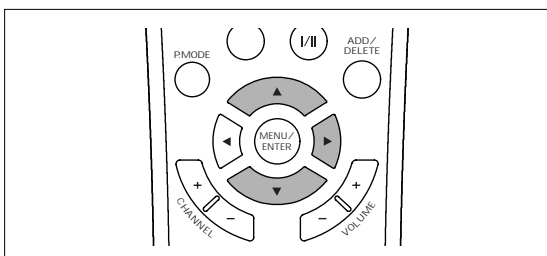

5

After the hour is set, press ► button. Then press ▲ or ▼ repeatedly or hold down either of these buttons until the correct minute appears.

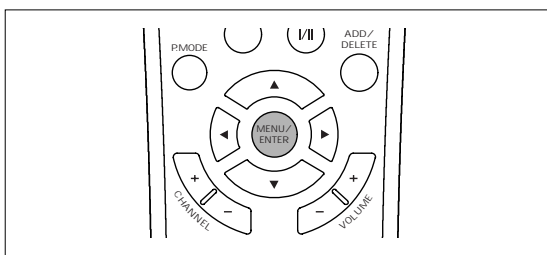

6

After the minutes are set, Press MENU/ENTER button repeatedly to exit.

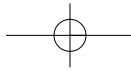

## SETTING THE ON/OFF TIMER

Make sure the clock has been set correctly before setting the timer.

### Setting the On Timer

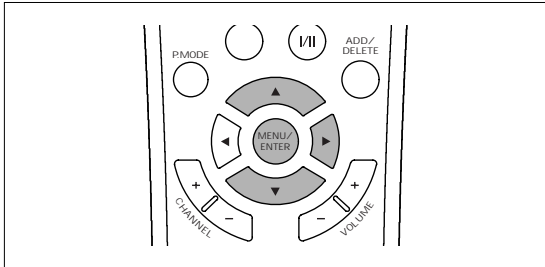

**1**

Press the MENU/ENTER button to display the menu and select [Setup] menu using ▲/▼ buttons. Then press ► button to access its menu.

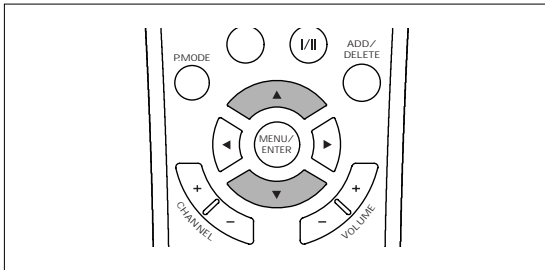

**2**

Press ▲ or ▼ button to select [time].

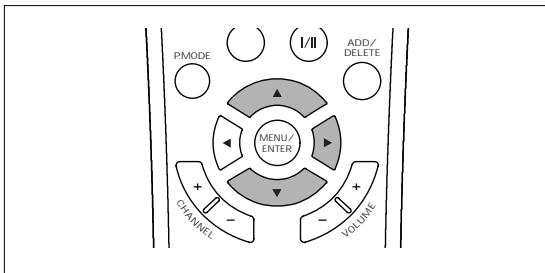

**3**

Press ► button to enter time setup menu. Then press ▲ or ▼ button to select [on time].

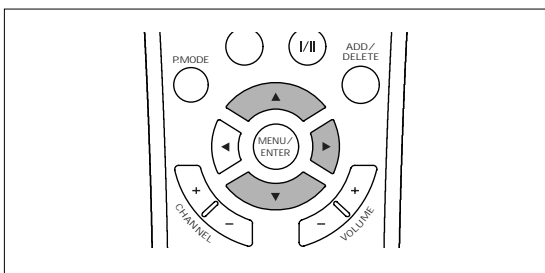

**4**

Press ► button. Then press ▲ or ▼ button repeatedly or hold down either of these buttons until the correct hour appears. (i.e., the hour when the TV will turn on.)

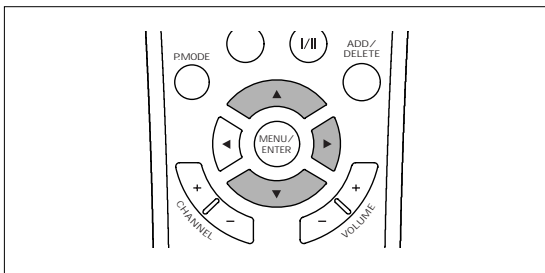

**5**

After the hour is set, press ► button. Then press ▲ or ▼ button repeatedly or hold down either of these buttons until the correct minute appears.

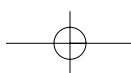

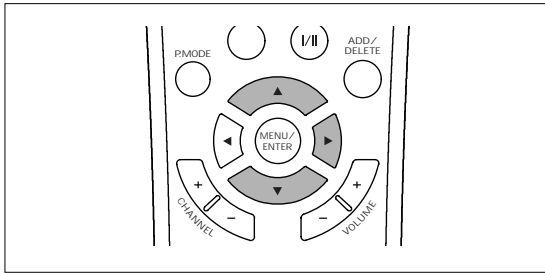
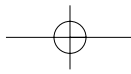

- 6** Press **▶** button.  
Then press **▲** or **▼** to select on or off.
- When off is selected, the on timer is deactivated.

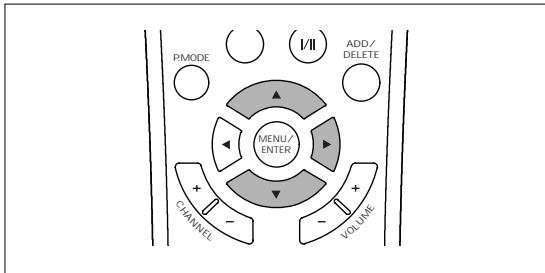

- 7** Press **▶** button to exit from [on time].  
Then press **▲** or **▼** button to select [channel].

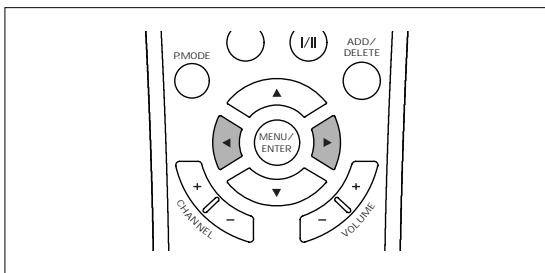

- 8** Then press **◀** or **▶** button repeatedly or hold down either of these buttons until appropriate channel is selected.

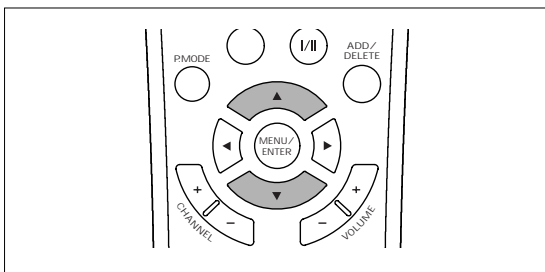

- 9** Press **▲** or **▼** button to select [volume].

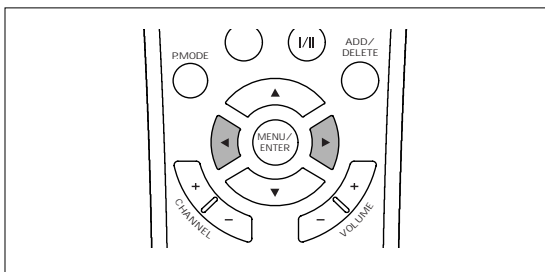

- 10** Then press **◀** or **▶** button repeatedly or hold down either of these buttons until the volume is adjusted as desired.

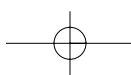

## Setting the Off Timer

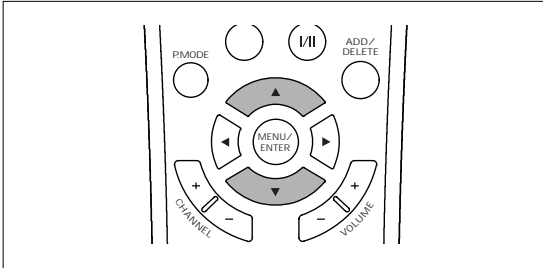

**11** Press ▲ or ▼ button to select [off time].

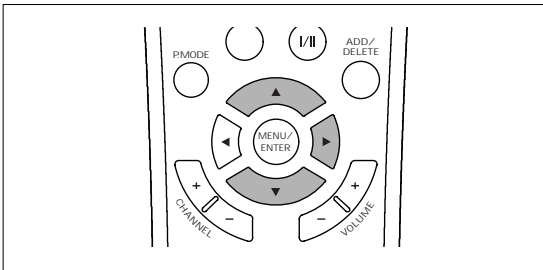

**12** Press ► button.  
Then press ▲ or ▼ button repeatedly or hold down either of these buttons until the correct hour appears.(i.e., the hour when the TV will turn on.)

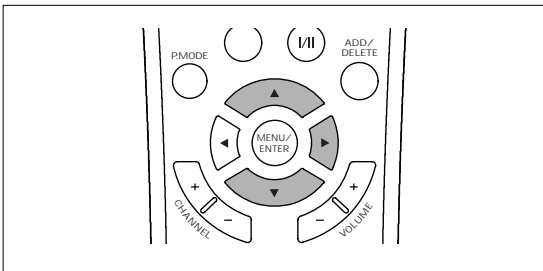

**13** After the hour is set, press ► button.  
Then press ▲ or ▼ button repeatedly or hold down either of these buttons until the correct minute appears.

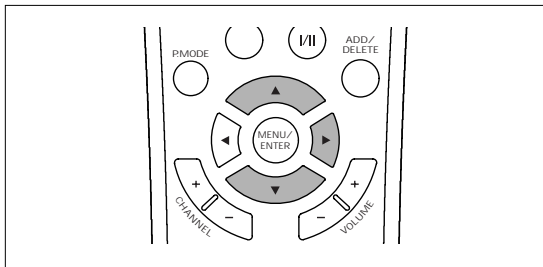

**14** Press ► button.  
Then press ▲ or ▼ to select on or off.  
When off is selected, the on timer is deactivated.

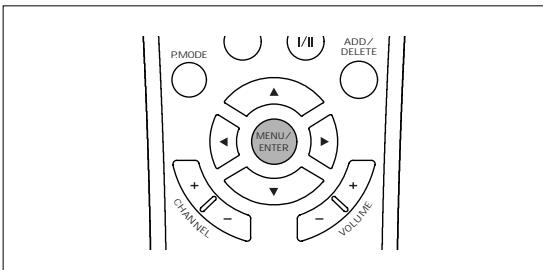

**15** Press MENU/ENTER button repeatedly to exit.

**16** Turn the power off before the on time.  
At the on time, the power is turned on and the timer function is activated automatically.

To operate the timer, you should turn the power off before the on time.

## SETTING THE SLEEP TIMER

The sleep timer automatically shuts off the TV after a preset time (from 10 to 240 minutes).

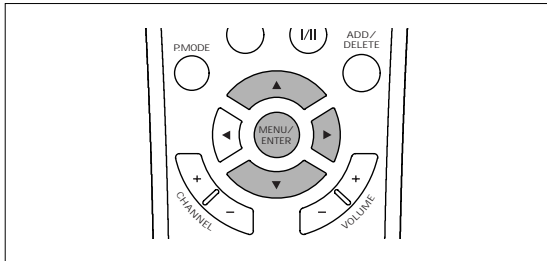

1

Press the MENU/ENTER button to display the menu and select [Setup] menu using ▲/▼ buttons. Then press ► button to access its menu.

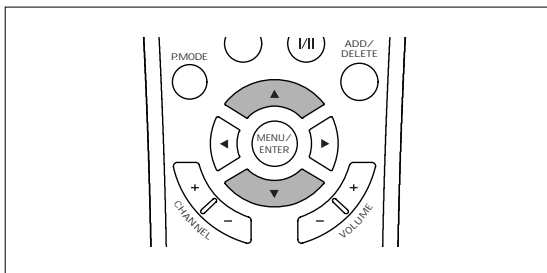

2

Press ▲ or ▼ button to select [time].

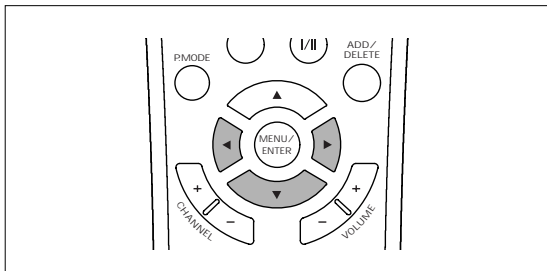

3

Press ► button to enter time setup menu. Then press ▲ or ▼ button to select [sleep timer].

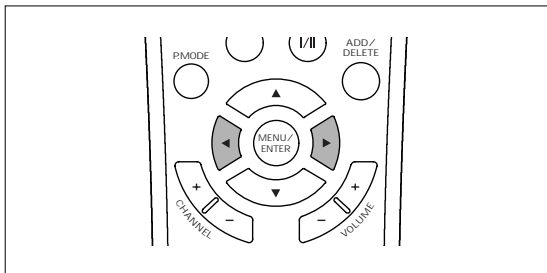

4

Press ◀ or ▶ button until the appropriate time interval appears (any of the preset values from "off" to "240").

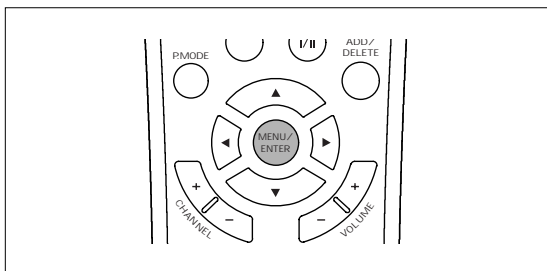

5

Press MENU/ENTER button repeatedly to exit.

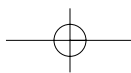

**Quick way**

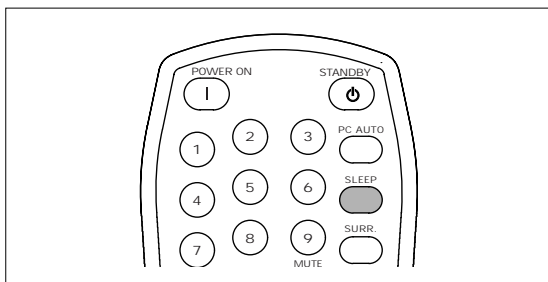

Press the SLEEP button on the remote control repeatedly until the appropriate time interval appears.

After several seconds, the sleep display disappears from the screen, and the time interval is set.

▶ To cancel the sleep timer, press the SLEEP button repeatedly until the "off" is displayed.

**ADJUSTING CLOSED CAPTION SETTINGS**

- This TV is equipped with an internal closed caption decoder. Closed caption is a system which allows conversations, narration, and sound effects in TV programs and home videos to be viewed as captions on the TV screen.
- Not all programs and videos will offer closed captioning.  
Please look for the " **CC** " symbol to ensure that captions will be shown.
- The closed caption broadcasts can be viewed in two modes: caption and text.  
For each mode, two channels are available: cc1 / cc2, t1 / t2.  
The caption mode shows subscripts of dialogs and commentaries of TV dramas and news programs while allowing a clear view of the picture.  
The text mode displays various information over the picture (such as TV program schedules and weather forecasts, etc.) that is independent of the TV programs.

**Viewing Closed Captions**

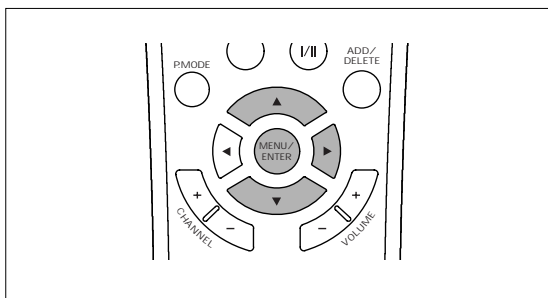

**1** Press the MENU/ENTER button to display the menu and select [Setup] menu using ▲/▼ buttons.  
Then press ► button to access its menu.

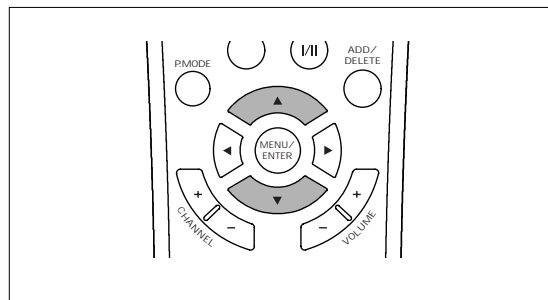

**2** Press ▲ or ▼ button to select [closed caption].

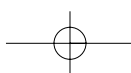

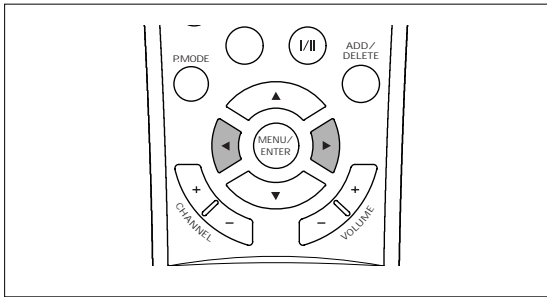
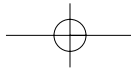

**3** Press ◀ or ▶ button to select viewing mode as follows:  
off ↔ on

- off : Closed caption does not display.
- on : Closed caption displays.

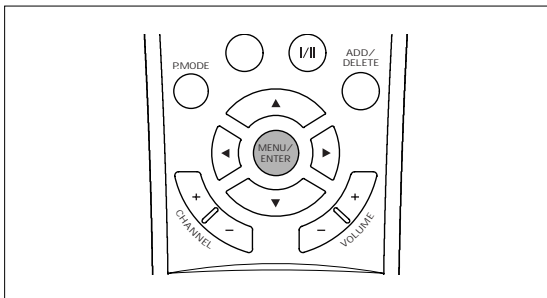

**4** Press MENU/ENTER button repeatedly to exit.

**Quick way**

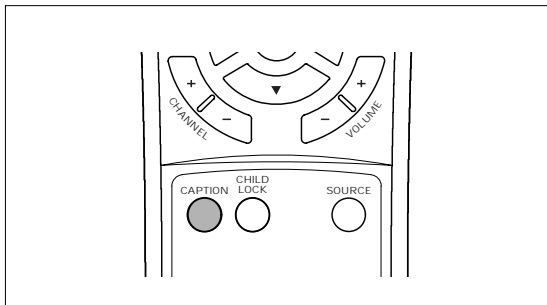

Each time the CAPTION button is pressed, the viewing mode(off / on) is changed.

- ▶ Closed caption may malfunction (white blocks, strange characters, etc.) if signal conditions are poor or if there are problems at the broadcast source. This does not necessarily indicate a problem with your TV.
- ▶ If any button is pressed to call up the on-screen menu while viewing a closed caption broadcast, the closed captions will disappear momentarily.
- ▶ If no text broadcast is being received while viewing in the text mode, the screen may become dark and blank for some programs. Should this occur, switch the closed caption mode to off.

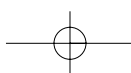



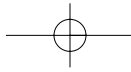

## Selecting the Background of Closed Caption

▶ Only when the closed caption is set to on, you can select the background of closed caption.

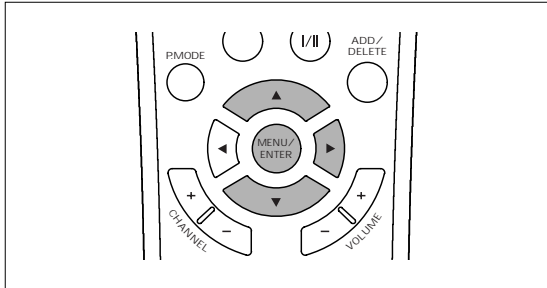

**1** Press the MENU/ENTER button to display the menu and select [setup] - [background] menu using ▲/▼ buttons. Then press ▶ button to access its menu.

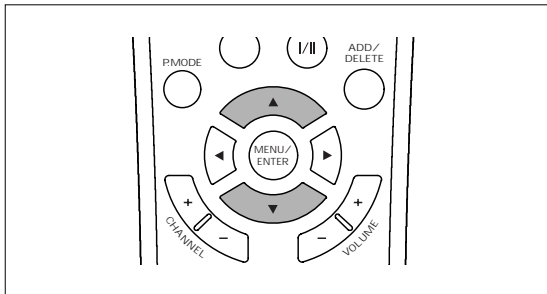

**2** Press ▲ or ▼ button to select [background].

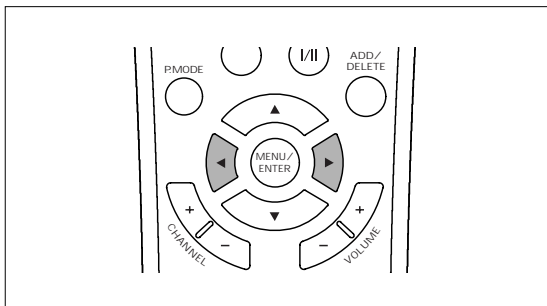

**3** Pressing ◀ or ▶ button changes the caption background as follows:  
opaque ↔ transparent

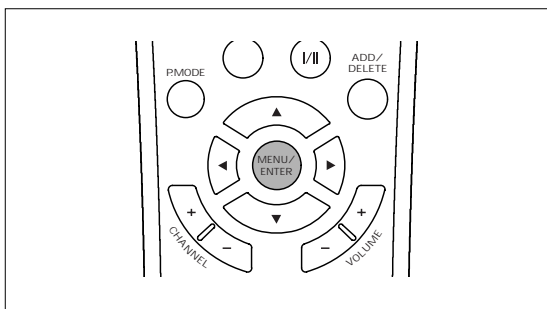

**4** Press MENU/ENTER button repeatedly to exit.

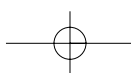

## Selecting the Closed Caption Mode

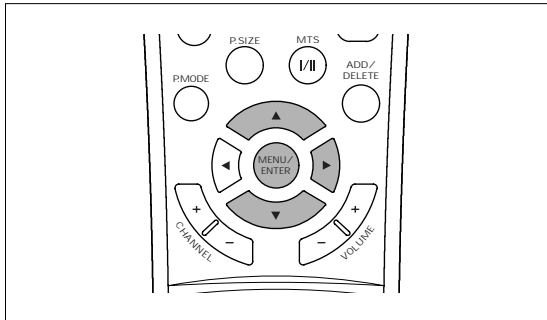

- 1 Press the MENU/ENTER button to display the menu and select [Setup] menu using ▲/▼ buttons. Then press ► button to access its menu.

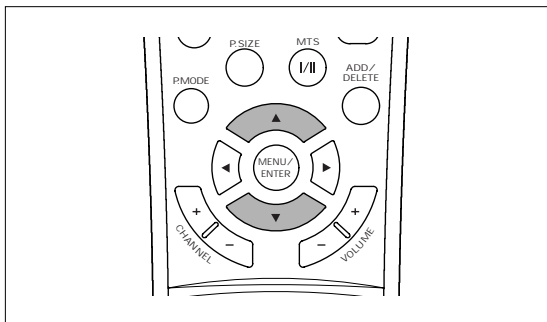

- 2 Press ▲ or ▼ button to select [mode].

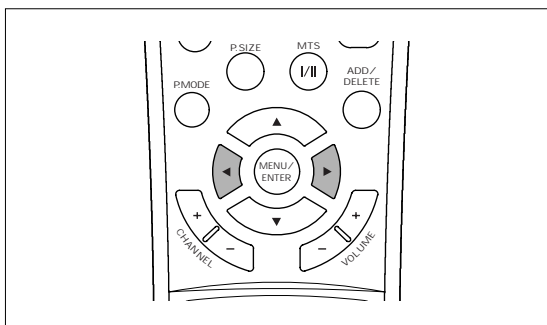

- 3 Pressing ◀ or ▶ button changes the caption mode as follows:  
cc1 ↔ cc2 ↔ text1 ↔ text2 ↔ xds\* ↔ cc1

\*XDS : Extended Data Service.

This service displays "network name", "call letter", "program name", "program length" and "time in show" information, etc.

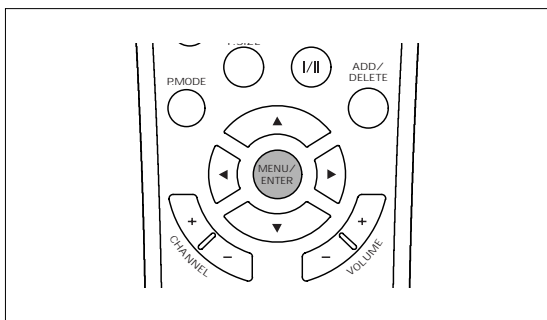

- 4 Press MENU/ENTER button repeatedly to exit.

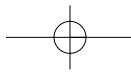

## BLOCKING THE CONTENTS

- The Parental Control function (V-Chip) is used to block TV programs viewing based on the ratings sent by the broadcast station. The default setting is to allow all programs to be viewed. Viewing can be blocked by the type of program and by the categories chosen to be blocked.
- Restriction of TV programs include two ratings that contain information about the program: the MPAA rating and the TV Parental Guidelines. The MPAA rating is restricted by age. TV Parental Guidelines are restricted by age and content.
- To use the Parental Control function, you should first enter a password and set the parental ratings.
- Since a TV program may use either the MPAA ratings or the TV Parental Guidelines, both should be adjusted for completed control.

### ■ MPAA ratings

- G: General audience (no restrictions).
  - PG: Parental guidance suggested.
  - PG-13: PG-13 (Parents strongly cautioned).
  - R: Restricted (Children under 17 should be accompanied by an adult).
  - NC-17: No children under age 17.
  - X: Adults only.
  - NR: No rated.
- ▶ The MPAA rating is only age-based.

### ■ TV Parental Guidelines

TV Parental Guidelines consist of the age-based categories and the content categories as follows.

#### Age-based categories

- Y: Young children.
  - Y7: Children 7 and over.
  - G: General audience.
  - PG: Parental guidance.
  - 14: Viewers 14 and over.
  - MA: Mature audience.
- ▶ These categories consist of two separate groups: "Y" and "Y7"(young children through age7), and "G" through "MA"(everybody else).

#### Content categories

- FV: Fantasy violence.
- D: Sexual suggestive dialog.
- L: Adult language.
- S: Sexual situation.
- V: Violence

## Entering a Password

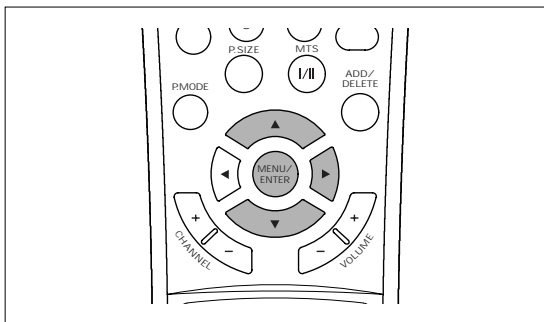

1

Press the MENU/ENTER button to display the menu and select [Setup] menu using ▲/▼ buttons.  
Then press ► button to access its menu.

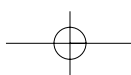

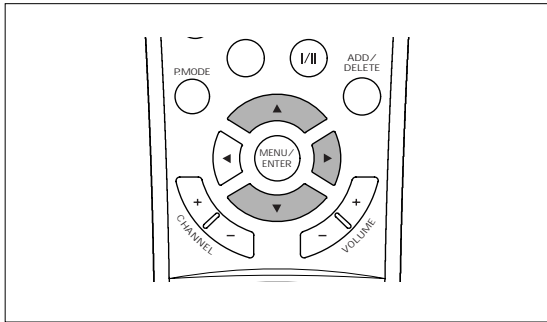
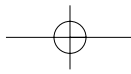

**2** Press ▲ or ▼ button to select [v-chip].  
Then press ► button to enter v-chip setup menu.

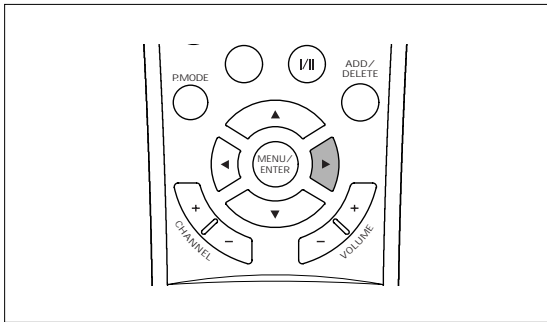

**3** Press ► button to enter [ENTER password] mode.  
Then 4 digit password input menu is displayed for several second.

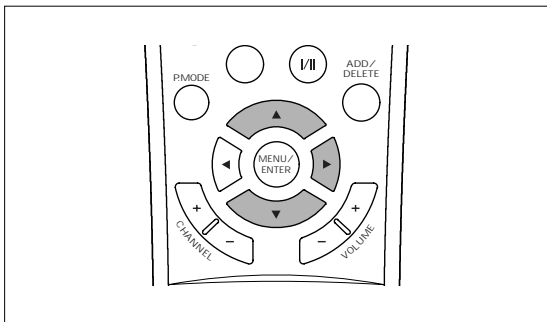

**4** Press ► button to move the cursor to the desired digit and press ▲ or ▼ button to select the desired number (0~9).

Repeat the above step 3 to enter 4 digit password.

When you enter a password first time, enter "0000" as default settings.

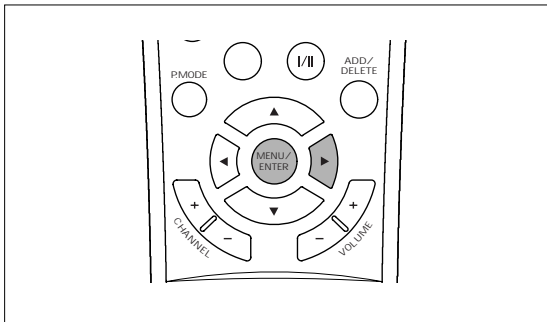

**5** Press ► button to select "enter" and press MENU/ENTER button.

If the incorrect password is entered, the items other than [password input] on the v-chip setup menu cannot be selected.

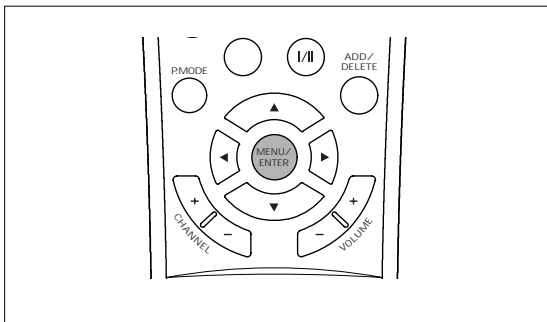

**6** Press MENU/ENTER button repeatedly to exit.

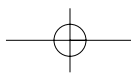

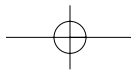

## Changing the Password

Before changing the password, you should enter the old password first, performing the steps 1~ 5 in "Entering A Password" on the previous page.

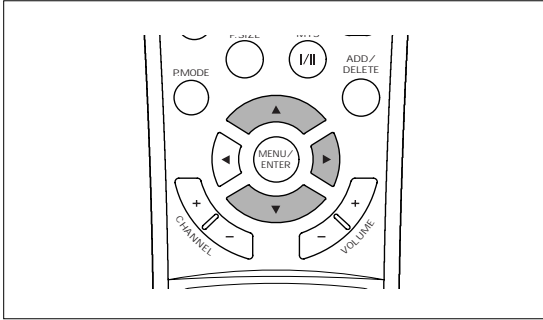

- 1** Press ▲ or ▼ button to select [password change], then press ► button to enter the new password input mode.

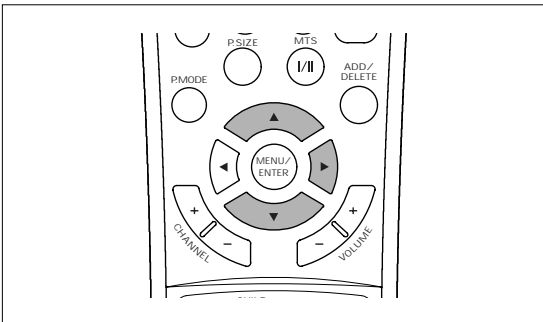

- 2** Press ► button to move the cursor to the desired digit and press ▲ or ▼ button to select the desired number (0~9).

Repeat the above step 2 to enter a new 4 digit password.

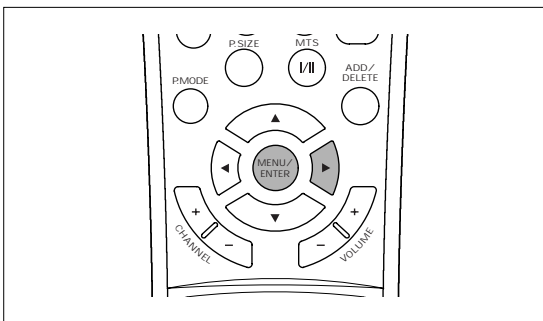

- 3** Press ► button to select "enter" and press MENU/ENTER button.

Once the new password is changed into, do not forget it. If you do not know it, you cannot set the parental ratings. Should this happen, reset all the settings made in the menus and enter "0000" as password. (See "FACTORY RESET" on page 48)

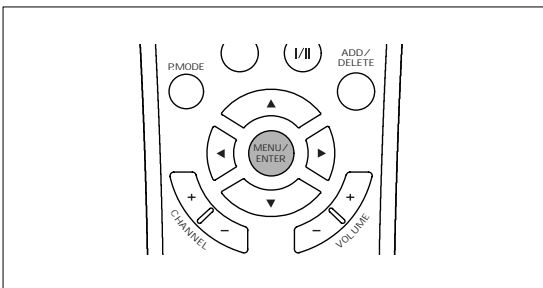

- 4** Press MENU/ENTER button repeatedly to exit.

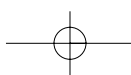

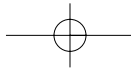

### Setting the Restrictions Using MPAA Ratings

Before setting this restrictions, you should enter the password first, performing the steps 1~ 5 in "Entering A Password" on page 43.

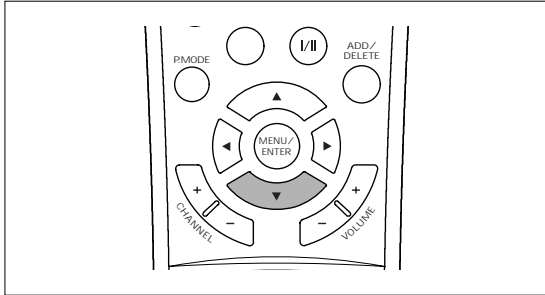

**1** Press ▼ button to select [MPAA level]. Then MPAA level setup menu is displayed for several second.

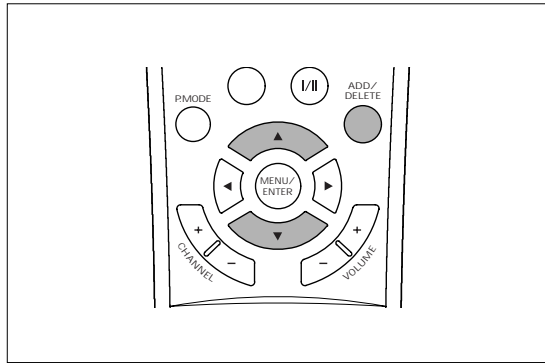

**2** Press ▲ or ▼ button to select a particular MPAA category to be blocked and press the ADD/DELETE button.

- Example 1: If "PG-13" is blocked, this will also automatically block the higher ratings "R", "NC-17", "X" and "NR".
- Example 2: If "R" is blocked, this will also automatically block the higher ratings "NC-17", "X", and "NR".

Each time the ADD/DELETE button is pressed at a category, that category will be blocked or not.

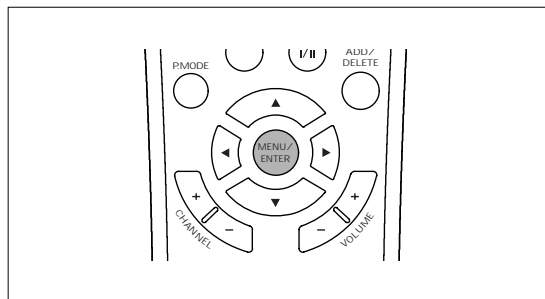

**3** Press the MENU/ENTER button to exit from the MPAA level setup.

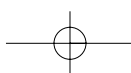

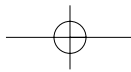

### Setting the Restrictions Using TV Parental Guidelines

Before setting this restrictions, you should enter the password first, performing the steps 1~ 5 in "Entering A Password" on page 43.

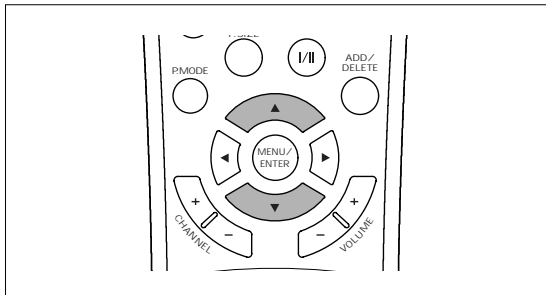

**1** Press ▲ or ▼ button to select [TPG level]. Then TPG level setup mwnu is displayed for several second.

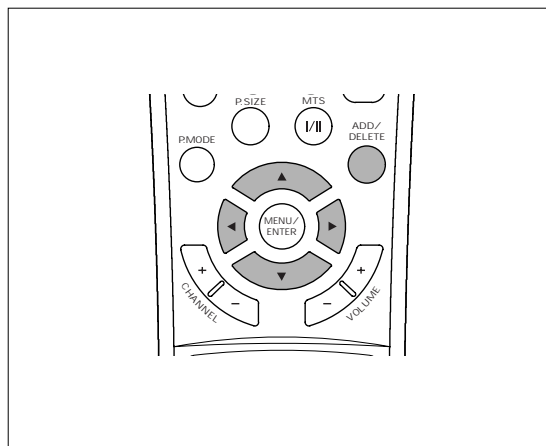

**2** Press ▲/▼ and ◀/▶ buttons to select a particular age-based category to be blocked and press the ADD/DELETE button.

- Example : If "Y7" is blocked, this will also automatically block the higher ratings "G", "PG", "14" and "MA". (The cotent categories ("D", "L", "S", "V") work together similiary.)
- "Y7", "G", "PG", "14" and "MA" have sub ratings as additional options. Do the next step to select the particular content category.

Each time the ADD/DELETE button is pressed at a category, that category will be blocked or not.

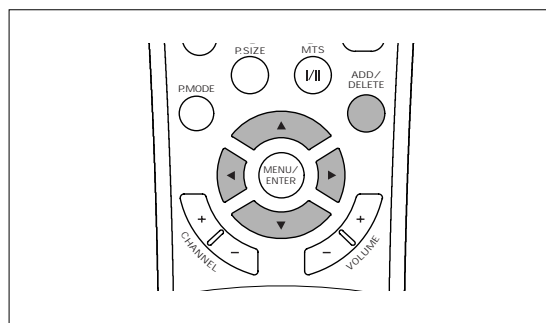

**3** Press ◀/▶ and ▲/▼ buttons to select a particular conten category to be blocked and press the ADD/DELETE button.

- If "L" sub rating in "PG" is blocked, the "L" sub ratings in "14" and "MA" will automatically be blocked.
- Each time the ADD/DELETE button is pressed at a category, that category will be blocked or not.

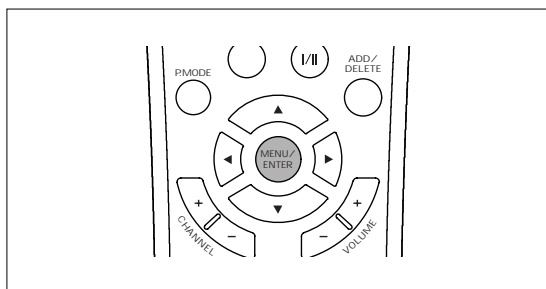

**4** Press the MENU/ENTER button to exit from the TPG level setup mode.

Press the MENU/ENTER button repetedly to exit from the on-screen menu mode.

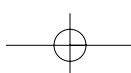

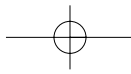

## CHILD LOCK

If you do not want your child(ren) to watch the TV when you're out, we recommend this function.

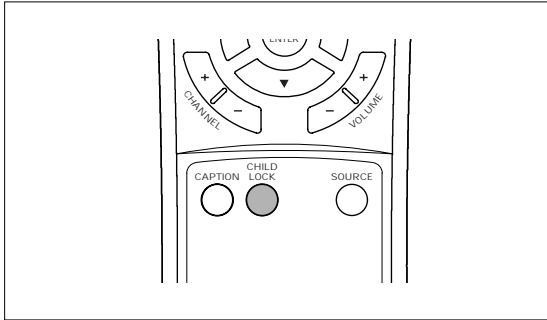

Press the CHILD LOCK button.  
Each time this button is pressed, the mode change as follow:

off ↔ on

- on : This TV cannot be controlled with the buttons of top panel.
- off : This TV can be controlled with both the buttons of top panel and remote control.

## FACTORY RESET

You can reset all the settings made in the menus to the default settings.

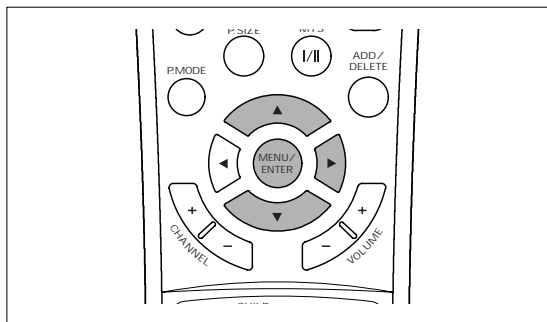

**1**

Press the MENU/ENTER button to display the menu and select [Setup] menu using ▲/▼ buttons.  
Then press ► button to access its menu.

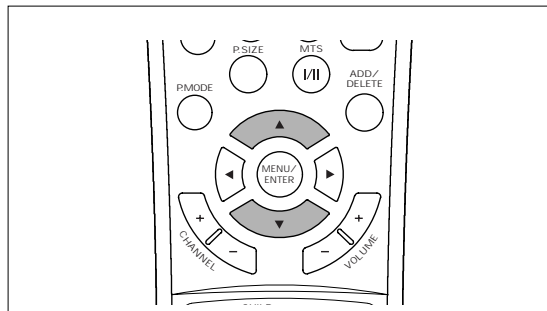

**2**

Press ▲ or ▼ button to select [factory reset].

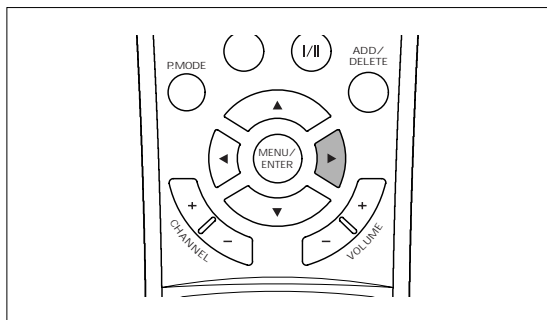

**3**

Press ► button to start resetting.

- Some settings such as MPAA level, TPG level etc. cannot be reset to the default settings.

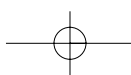



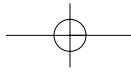

# PC Display

## USING YOUR TV AS A COMPUTER (PC) DISPLAY

### How to Connect Your PC to the TV

#### ■ PC video connection

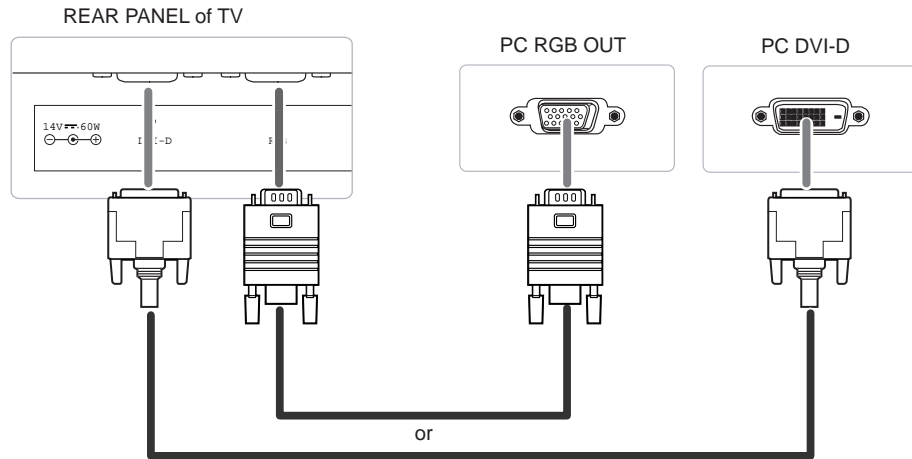

#### ■ PC audio connection

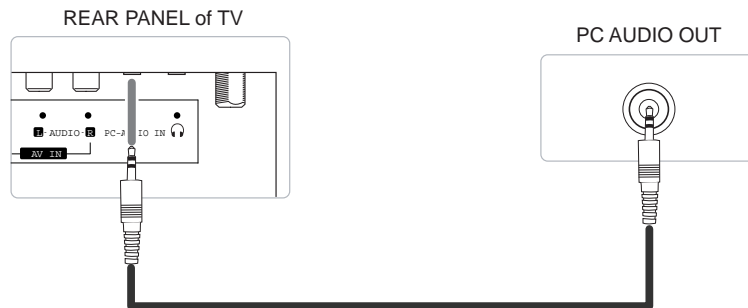

### Selecting the PC Signal Input

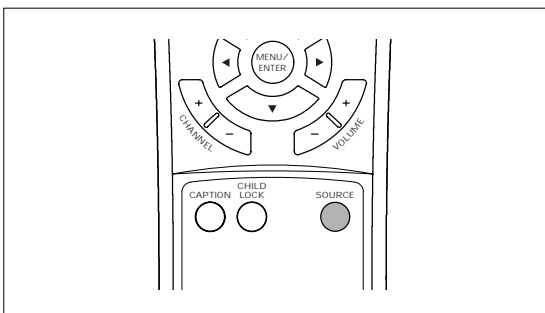

1

Press the SOURCE button. Then SOURCE SELECT mnu is displayed for several second.

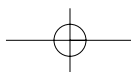

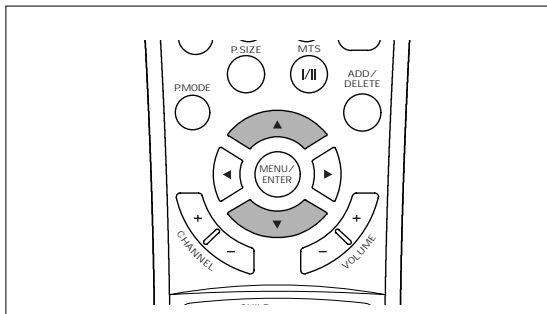
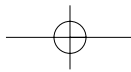

**2** Press ▲ or ▼ button to select either PC ANALOG or PC DIGITAL depending on whether the connection between TV and PC is VGA connection or DVI-D connection.

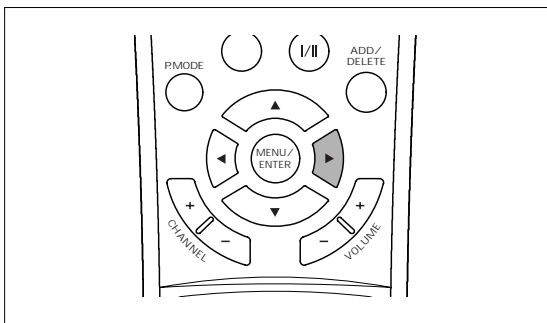

**3** Press ► button to confirm your selection.

### How to Set up Your PC Display

Your PC display must be set as supportable format of this unit. The displayable monitor specification is shown below:

Mode	Resolution	Vertical Frequency(Hz)	Horizontal Frequency (KHz)
VGA	640 X 480	60	31.4
	640 X 480	66	35
	640 X 480	72	37.9
	640 X 480	75	37.5
SVGA (MAC)	800 X 600	56	35.1
	800 X 600	60	37.8
	800 X 600	72	48
XGA	832 X 624	75	49.7
	1024 X 768	60	48.3
	1024 X 768	70	56.4
WXGA	1024 X 768	75	60
	1280 X 768	60	47.7
SXGA	1280X1024	60	64

- ▶ If possible, use 1280 X 768 @ 60Hz video mode to obtain the best image quality for your LCD monitor. If used under the other resolutions, some scaled or processed pictures may appear on the screen.
- ▶ If the message "out of range" appears on the screen, adjust the PC as in the left table.
- ▶ 1280X768 @ 60 Hz video mode may not be displayed well at certain video card.

### Customizing the Picture

You can adjust the brightness and contrast according to personal preference when PC ANALOG is selected as input source. However, you can adjust only the brightness when PC DIGITAL is selected. Perform the step 1 to 4 in "CUSTOMIZING THE PICTURE" procedure on page 28.

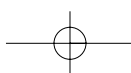

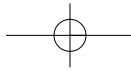

## Changing the Screen Position

You can adjust the h position and v position only when PC ANALOG is selected as input source.

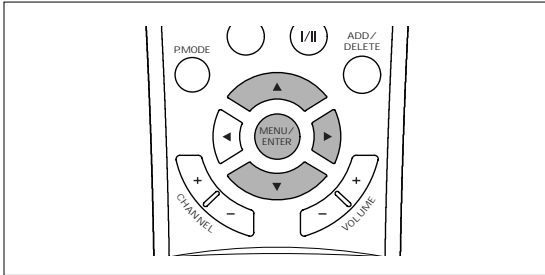

- 1 Press the MENU/ENTER button to display the menu and select [Adjust] menu using ▲/▼ buttons. Then press ► button to access its menu.

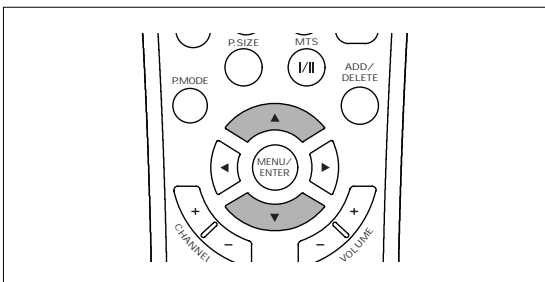

- 2 Press ▲ or ▼ button to select [h position] or [v position].

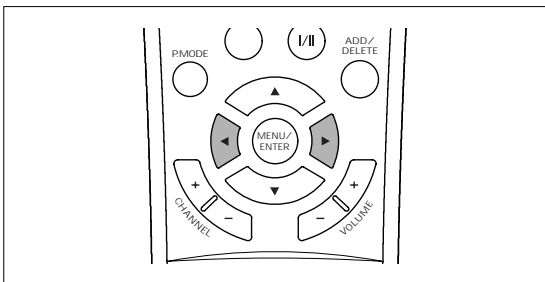

- 3 Press ◀ or ▶ button to adjust the position. To adjust the other position as desired, repeat the above step 1 to 3.

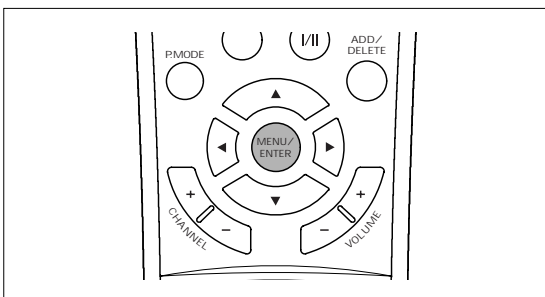

- 4 Press MENU/ENTER button repeatedly to exit.

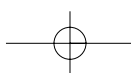

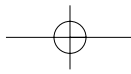

## Adjusting the Screen Quality

The purpose of picture quality adjustment is to remove or reduce picture noise.

After the noise has been reduced, re-adjust the picture so that it is aligned on the center of screen.

See "Aligning the Picture on the Center of Screen" on page 53.

You can adjust the phase and frequency only when PC ANALOG is selected as input source.

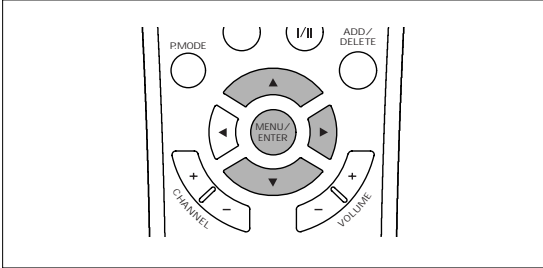

- 1** Press the MENU/ENTER button to display the menu and select [Adjust] menu using ▲/▼ buttons. Then press ► button to access its menu.

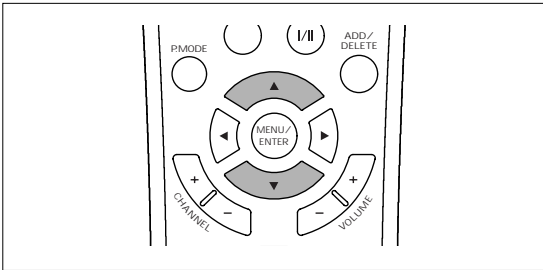

- 2** Press ▲ or ▼ button to select [phase] for horizontal stripes or [frequency] for vertical ones.

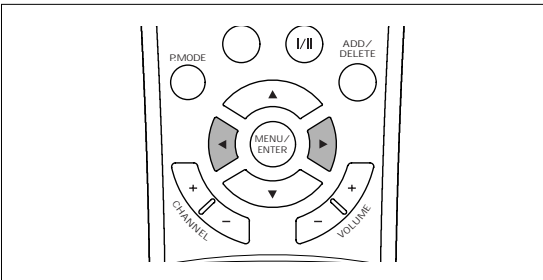

- 3** Press ◀ or ▶ button to adjust the selected item.  
To adjust the other position as desired, repeat the above step 1 to 3.

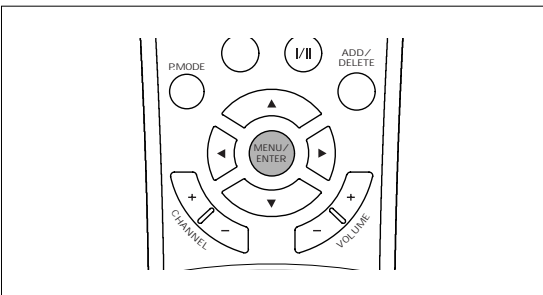

- 4** Press MENU/ENTER button repeatedly to exit.

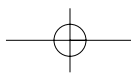

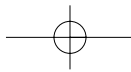

**Aligning the Picture on the Center of Screen**

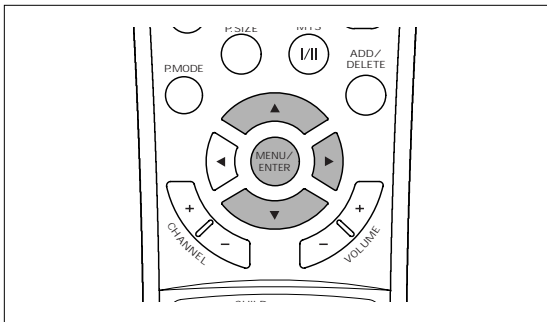

**1** Press the MENU/ENTER button to display the menu and select [Adjust] menu using ▲/▼ buttons. Then press ► button to access its menu.

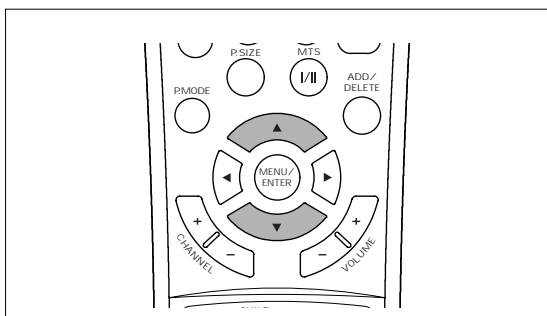

**2** Press ▲ or ▼ button to select [auto adjustment].

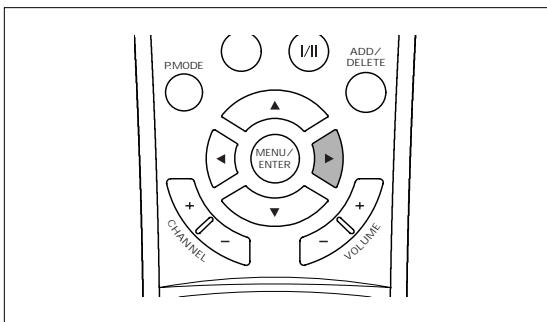

**3** Press ► button to start auto adjustment. The picture is automatically centered on the screen.

**Quick way**

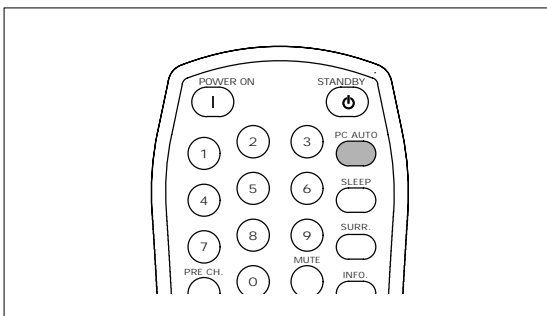

Press PC AUTO button. The picture is automatically centered on the screen.

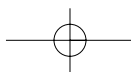

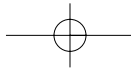

## Selecting the Color Tone

Your TV has three automatic color settings("cool", "normal", "warm" and "user").  
That are preset at the factory.  
You can select the desired of them.

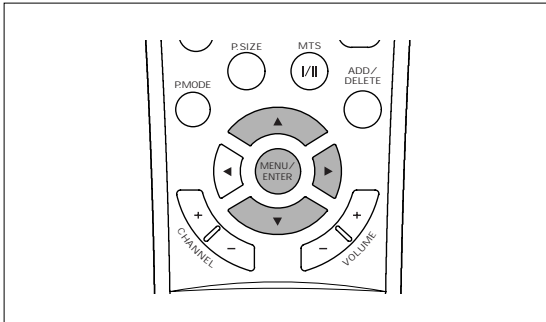

- 1** Press the MENU/ENTER button to display the menu and select [Color] menu using ▲/▼ buttons.  
Then press ► button to access its menu.

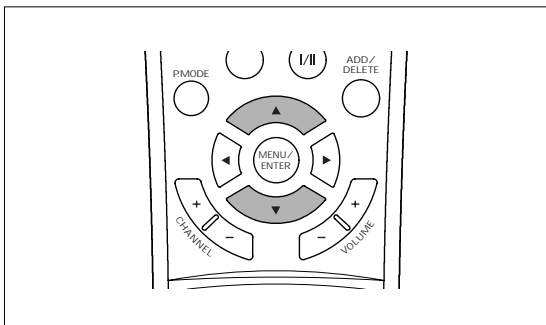

- 2** Press ▲ or ▼ button to select [color temp.].

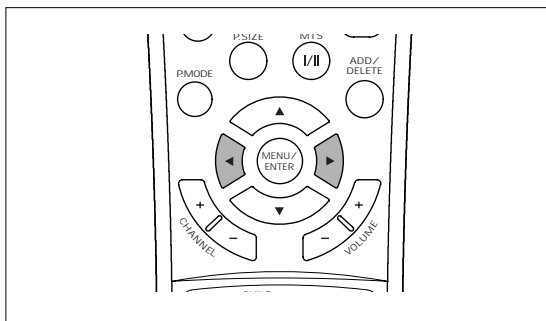

- 2** Press ◀ or ▶ button to select one of the automatic color settings.
- Choose "cool" to emphasize clear blues.
  - Choose "normal" for standard picture.
  - Choose "warm" to emphasize mild greens.
  - Choose "user" to adjust the color tone settings as desired.

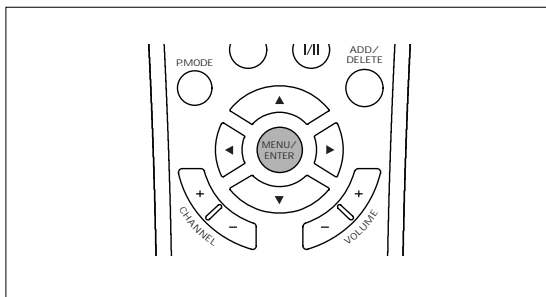

- 3** Press the MENU/ENTER button repeatedly to exit.

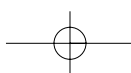

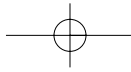

## Customizing the Color Tone

You can adjust the red, blue and green according to personal preference. These can be selected when the [color temp.] is set to "user". Refer to previous page.

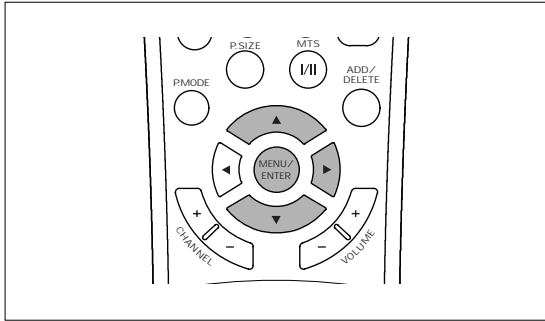

- 1** Press the MENU/ENTER button to display the menu and select [Color] menu using ▲/▼ and ► buttons. Then press ► button to access its menu.

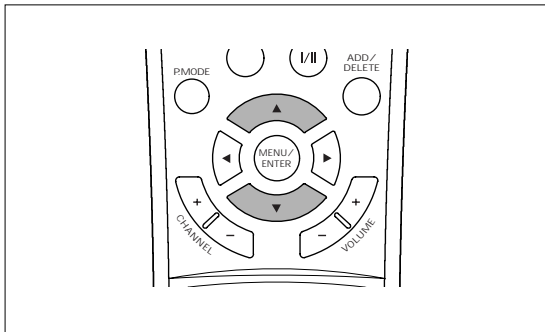

- 2** Press ▲ or ▼ button to select a particular item.

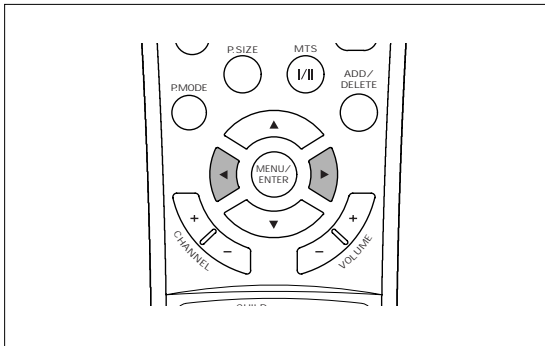

- 3** Press ◀ or ▶ button to adjust the selected item. For example, if you select [red], pressing ◀ or ▶ button increases/decreases it. To adjust the other position as desired, repeat the above step 1 to 3.

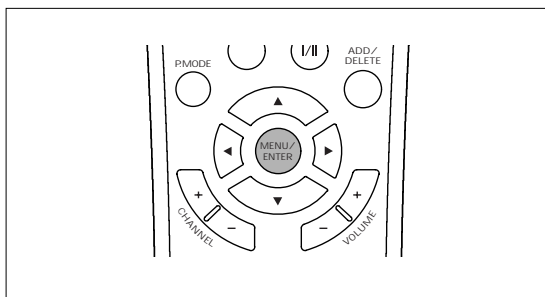

- 4** Press the MENU/ENTER button repeatedly to exit.

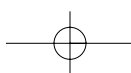

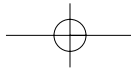

## Troubleshooting

If the TV seems to have a problem, first try this list of possible problems and solutions.

If none of these troubleshooting tips apply, call your nearest service center.

Problem	Possible Solution
Poor picture	Try another channel. Adjust the antenna. Check all wire connections.
Poor sound quality	Try another channel. Adjust the antenna.
No picture or sound	Try another channel. Press some buttons related to audio/video . Make sure the TV is plugged in. Check the antenna connections. Ensure that the signal cable is firmly connected to the PC or video sources. Ensure that the PC or video sources are turned on.
No color, wrong colors or tints	Make sure the program is broadcasted in color. Adjust the related settings in [Adjust] menu. If the set is moved or turned in a different direction, the power should be OFF for at least 30 minutes. Adjust antenna.
Picture rolls vertically.	Check all wire connections.
The TV operates erratically.	Unplug the TV for 30 seconds, then try operating it again.
The TV won't turn on.	Make sure the wall outlet is working.
Blurred or snowy picture, distorted sound	Check the direction, location and connections of your aerial. This interference is often due to the use of an indoor aerial.
Remote control malfunctions	Replace the remote control batteries. Aim correctly to remote sensor. Check the battery terminals.
"out of range" message	Check the maximum resolution and the frequency of the display.
The image is too light or too dark	Adjust the brightness and contrast. Adjust the fine tuning.
Horizontal bars appear to flicker, jitter or shimmer on the image	Adjust the fine tuning.
Vertical bars appear to flicker, jitter or shimmer on the image	The TV is using its power management system. Move the computer's mouse or press a key on the keyboard.
Image is not centered on the screen	Adjust the horizontal and vertical position.

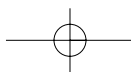



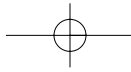

## Appendix

### RETRACTABLE STAND

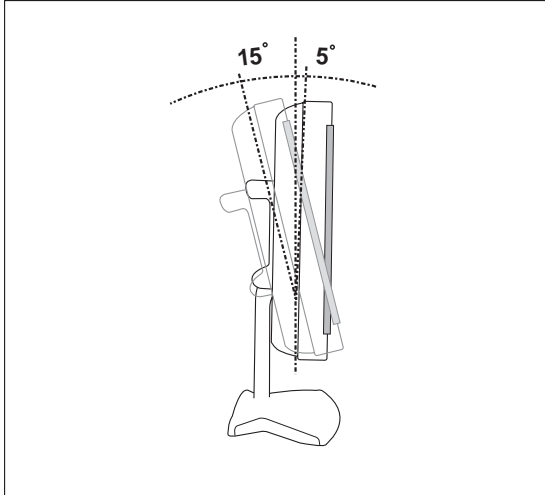

▶ The maximum tilt angle is 15 degrees in the backward direction. Please do not tilt the TV outside the specified range. Using excessive force to tilt the TV may cause permanent damage to the mechanical part of the stand.

▶ Do not use the stand other than the one attached. If other stand is used, this can cause the TV to fall, resulting in serious personal injuries as well as damage to the TV.

### CLEANING AND MAINTAINING YOUR TV

With proper care, your TV unit will give you many years of service. Please follow these guidelines to get the maximum performance from your TV.

#### Placement

- Do not place the TV near extremely hot, cold, humid or dusty places.
- Do not place the TV near appliances with electric motors that create magnetic fields, such as vacuum cleaners.
- Keep the ventilation openings clear; do not place the TV on a soft surface, such as cloth or paper.
- Place the TV in a vertical position only.

#### Liquids

- Do not handle liquids near or on the TV.  
Liquids that spill into it can cause serious damage.

#### Cabinet

- Never open the cabinet or touch the parts inside.
- Wipe your TV with a clean, dry cloth. Never use water, cleaning fluids, wax, or chemicals.
- Do not put heavy objects on top of the cabinet.

#### Temperature

- If your TV is suddenly moved from a cold to a warm place, unplug the power cord, and allow at least two hours for moisture that may have formed inside the unit to dry completely.

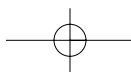

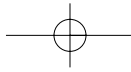

## LCD

- The LCD panel used in this product is made of glass. Therefore, it can break when the product is dropped or applied with impact. Be careful not to be injured by broken glass pieces in case the LCD panel breaks.
- The LCD panel is a very high technology product with thin film transistors, giving you fine picture details.  
Occasionally, a few non-active pixels may appear on the screen as a fixed point of blue, green or red. Please note that this does not affect the performance of your product.

## NOTES

- This product incorporates copyright protection technology that is protected by U.S. patents and other intellectual property rights. Use of this copyright protection technology must be authorized by Macrovision, and is intended for home and other limited viewing uses only unless otherwise authorized by Macrovision. Reverse engineering or disassembly is prohibited.
- CONSUMERS SHOULD NOTE THAT NOT ALL HIGH DEFINITION TELEVISION SETS ARE FULLY COMPATIBLE WITH THIS PRODUCT AND MAY CAUSE ARTIFACTS TO BE DISPLAYED IN THE PICTURE. IN CASE OF 525 PROGRESSIVE SCAN PICTURE PROBLEMS, IT IS RECOMMENDED THAT THE USER SWITCH THE CONNECTION TO THE 'STANDARD DEFINITION' OUTPUT. IF THERE ARE QUESTIONS REGARDING OUR TV SET COMPATIBILITY WITH THIS MODEL 525p DVD PLAYER, PLEASE CONTACT OUT CUSTOMER SERVICE CENTER.
- This device is a Class B digital apparatus which can be used in residential and industrial areas. Class B devices are registered for electromagnetic waves, and suitable for any area as well as home. Class A devices are suitable for office use. Class B devices have fewer electromagnetic wave emissions.

### USING YOUR TV IN ANOTHER COUNTRY

If you plan to take your TV with you to a foreign country, please be aware of the different television systems that are in use around the world. A TV designed for one system may not work properly with another system due to differences in the TV channel frequencies.

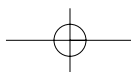

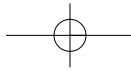

## Specifications

Panel	Display Size	17.1"(434.38 mm, diagonal)	
	Actual Display Size	372.48(H) X 223.488(V) mm	
	Pixel Size	0.291 X 0.291 mm	
	viewing Angle	88 / 88 / 88 / 88 (L / R / U / D)	
Frequency	Horizontal	30 ~ 64 KHz	
	Vertical	50 ~ 85 Hz	
Display Color		16.777.216 colors	
Display Resolution	Optimum Mode	1280 X 768 @ 60	
	Maximum Mode	1280 X 1024 @ 60 Hz	
Sync.		H/V Separate, TTL, SOG (Sync On Green)	
Color system		NTSC	
Video Ins	Antenna	75ohms unbalance, F-type	
	Composite	CVBS	
	S-Video	S-VHS	
	Component(1/2)	Y / Pb / Pr , ( 480i / 480p )	
	VGA	Analog R / G / B	
	DVI-D	Digital R / G / B	
Audio Ins/Out	Audio Ins	RCA Jack , Red(R) / White(L) , 0.3Vrms	
	PC-Audio In	Stereo mini jack , 0.3Vrms	
	Headphone Out	Stereo mini jack , 10mV Output	
Audio Amplifier		Max. 4.2W output	
Power Supply	Input	AC 100 ~240 V, 1.8 ~ 0.9 A (50/60 Hz)	
	Output	DC 14V / 4.5 A	
Power	Maximum	63 W	
Consumption	Power Saving	< 10 W	
Dimensions/ Weight	Unit(WxDxH): TV body	22.06 X 2.6 X 11.43 inch / 15.44 lbs (560 X 66 X 290 mm / 7 Kg)	
	With stand	22.06 X 7.87 X 14.8 inch / 24.26 lbs (560 X 200 X 376 mm / 11 Kg)	
Environmental Considerations	Operating Temperature	32° F to 122° F (0° C to 50° C)	
	Operating Humidity	10 % to 90 %	
	Storage Temperature	-4° F to 140° F (-20° C to 60° C)	
	Storage Humidity	10 % to 90 %	

※ Design and specifications are subject to change without notice for improvements.

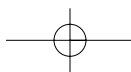

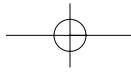

17.1 inch WIDESCREEN TFT-LCD TV  
**TL-1700W**

