

SA2100UG001

SA 2100



User Guide

Version: Draft



12 December, 2013

General

TERMS OF USE OF NEW MATERIALS - PLEASE READ CAREFULLY

From time to time, Novatel Wireless, in its sole discretion, may make available for download on its website (www.novatelwireless.com), or may transmit via mail or email, updates or upgrades to, or new releases of, the firmware, software or documentation for its products (collectively, 'New Materials'). Use of such New Materials is subject to the terms and conditions set forth below, and may be subject to additional terms and conditions as set forth in Novatel Wireless's Technical Support Policy (posted on its website) and/or any written agreement between the user and Novatel Wireless.

All New Materials are provided AS IS. Novatel Wireless makes no warranty or representation with respect to the merchantability, suitability, functionality, accuracy or completeness of any such New Materials. The user of such New Materials assumes all risk (known or unknown) of such use. Novatel Wireless reserves all rights in such New Materials. The user shall have only a revocable and limited license to use such New Materials in connection with the products for which they are intended. Distribution or modification of any New Materials without Novatel Wireless's consent is strictly prohibited.

IN NO EVENT WILL NOVATEL WIRELESS BE RESPONSIBLE FOR ANY INCIDENTAL, INDIRECT, CONSEQUENTIAL OR SPECIAL DAMAGES AS A RESULT OF THE USE OF ANY NEW MATERIALS. NOVATEL WIRELESS 'S MAXIMUM LIABILITY FOR ANY CLAIM BASED ON THE NEW MATERIALS SHALL NOT EXCEED FIFTY U.S. DOLLARS (\$50).

Version Verification

Please ensure you have the latest version of this document by downloading it from www.novatelwireless.com

Copyright

© 2013 Novatel Wireless. All rights reserved. Complying with all applicable copyright laws is the responsibility of the user. Without limiting the rights under copyright, no part of this document may be reproduced, stored in or introduced into a retrieval system, or transmitted in any form or by any means (electronic, mechanical, photocopying, recording or otherwise), or for any purpose, without the express written permission of Novatel Wireless.

Novatel Wireless and the Novatel Wireless logo are either registered trademarks or trademarks of Novatel Wireless, Inc. in the United States.

251 Renner Pkwy

Richardson, TX 75080 USA

Phone: (972) 633-4400

Fax: (972) 633-4444

Email: info@nvtl.com

www.novatelwireless.com

Warranty Information

This warranty applies to (a) products sold directly by Novatel Wireless M2M, unless a different warranty is specified in a written agreement between Novatel Wireless M2M and the purchaser; and (b) products sold to end users through a distributor authorized by Novatel Wireless M2M, but only where the authorized distributor does not provide a separate warranty on such products, and Novatel Wireless M2M has agreed to provide this warranty to such end users. If you purchased the product from an authorized distributor, please check whether this warranty from Novatel Wireless M2M, or a separate warranty from the distributor, applies to your purchase. This warranty does not apply to any (i) accessories or batteries for the products; or (ii) demonstration samples or prototypes of the products. Unless otherwise provided in a written agreement between Novatel Wireless M2M and the purchaser, all such accessories, batteries, samples or prototypes are provided by Novatel Wireless M2M AS IS without any warranty of any kind.

Novatel Wireless M2M warrants to the original purchaser of the product from Novatel Wireless M2M or its authorized distributor (as applicable) that, for a period of one (1) year from the date of shipment of the product from Novatel Wireless M2M, the product hardware will be substantially free from defects in material or workmanship under normal operation, and the product firmware will perform substantially in accordance with the product documentation provided by Novatel Wireless M2M. Novatel Wireless M2M does not warrant that (a) the product hardware or firmware will meet the purchaser's requirements; (b) the operation of the product hardware or firmware will be uninterrupted or error-free; or (c) the product, when integrated in, or combined with, other products or software not supplied by Novatel Wireless M2M, will continue to perform substantially in accordance with the product documentation. This limited warranty is for the benefit of the original purchaser, and is not transferable.

During the warranty period, Novatel Wireless M2M, at its expense and in its sole discretion, will repair the product, or replace the product with a corresponding or equivalent product, if it is determined to have a covered defect, provided that the purchaser first notifies Novatel Wireless M2M (directly or through its authorized distributor from which the product was purchased) of any such defect, furnishes Novatel Wireless M2M with a proof of purchase (if required), requests and obtains a return merchandise authorization (RMA) number from Novatel Wireless M2M, and returns the product under that RMA to Novatel Wireless M2M (or, at Novatel Wireless M2M's option, to its authorized distributor), with the shipping charges being prepaid by purchaser. If, upon reasonable examination of the returned product, Novatel Wireless M2M does not substantiate the defect claimed by purchaser, or determines that the defect is not covered under this limited warranty, Novatel Wireless M2M will not be required to repair or replace the product, but may instead reship the product to the purchaser (or, at Novatel Wireless M2M's option, to its authorized distributor where the product can be made available to purchaser), in which case the purchaser shall be responsible for paying Novatel

Wireless M2M's cost for reshipping the product to purchaser (or to Novatel Wireless M2M's authorized distributor), and Novatel Wireless M2M's usual charges for unpacking, testing, and repacking the product for reshipment to purchaser (or to Novatel Wireless M2M's authorized distributor). Purchaser shall bear the risk of loss or damage in transit to any product returned by purchaser to Novatel Wireless M2M, or any returned product not found to be defective or covered under this warranty, and reshipped by Novatel Wireless M2M to purchaser (or to Novatel Wireless M2M's authorized distributor). In the event Novatel Wireless M2M repairs or replaces a defective product covered by this limited warranty, the repaired or replacement product will be covered under this limited warranty for the remainder of the original warranty period on the defective product, or a period of ninety (90) days, whichever is longer. If Novatel Wireless M2M is unable to repair or replace a defective product covered by this limited warranty, Novatel Wireless M2M will provide to purchaser a credit or a refund (at Novatel Wireless M2M's option) of the original purchase price (excluding taxes and shipping charges). Any returned and replaced product, or any product for which Novatel Wireless M2M has furnished a credit or a refund, becomes the property of Novatel Wireless M2M.

Novatel Wireless M2M shall not have any obligation to provide any firmware bug fixes, upgrades or new releases except as may be necessary to correct any covered defect of which purchaser notifies Novatel Wireless M2M in writing during the warranty period. Novatel Wireless M2M, from time to time and in its sole discretion, may make available for download on its website (www.novatelwireless.com), or may provide via email, certain firmware bug fixes, upgrades or new releases for the product. Download and use of any such bug fixes, upgrades or new releases is subject to all of the applicable terms and conditions of Novatel Wireless M2M's technical support policy as posted and updated on its website. Novatel Wireless M2M shall have no obligation under this limited warranty for (a) normal wear and tear; (b) the cost of procurement of substitute products; or (c) any defect that is (i) discovered by purchaser during the warranty period but for which purchaser does not request an RMA number from Novatel Wireless M2M, as required above, until after the end of the warranty period, (ii) caused by any accident, misuse, abuse, improper installation, handling or testing, or unauthorized repair or modification of the product, (iii) caused by use of any materials not supplied by Novatel Wireless M2M, or by use of the product other than in accordance with its documentation, or (iv) the result of electrostatic discharge, electrical surge, fire, flood or similar causes. The purchaser (or its customers, as applicable) shall be solely responsible for the proper configuration, testing and verification of the Novatel Wireless M2M product prior to deployment in the field, and for ensuring that any end user product or system into which the Novatel Wireless M2M product is integrated or incorporated operates as intended and meets the requirements of purchaser (or its customers). Novatel Wireless M2M shall have no responsibility whatsoever for the integration, configuration, testing, verification, installation, upgrade, support or maintenance of any such end user product or system, or for any liabilities, damages, costs or expenses associated therewith.

NOVATEL WIRELESS'S SOLE RESPONSIBILITY AND PURCHASER'S SOLE REMEDY UNDER THIS LIMITED WARRANTY SHALL BE FOR NOVATEL WIRELESS TO REPAIR OR REPLACE THE PRODUCT (OR IF REPAIR OR REPLACEMENT IS NOT POSSIBLE, PROVIDE A CREDIT OR REFUND OF THE PURCHASE PRICE) AS PROVIDED ABOVE. NOVATEL WIRELESS EXPRESSLY DISCLAIMS ALL OTHER WARRANTIES OF ANY KIND, EXPRESS OR IMPLIED, INCLUDING WITHOUT LIMITATION ANY IMPLIED WARRANTIES OF NON-INFRINGEMENT, MERCHANTABILITY, SATISFACTORY PERFORMANCE AND FITNESS FOR A PARTICULAR PURPOSE. IN NO EVENT SHALL NOVATEL WIRELESS BE LIABLE FOR ANY INDIRECT, SPECIAL, EXEMPLARY, INCIDENTAL OR CONSEQUENTIAL DAMAGES (INCLUDING WITHOUT LIMITATION LOSS OR INTERRUPTION OF USE, DATA, REVENUES OR PROFITS) RESULTING FROM A BREACH OF THIS WARRANTY OR BASED ON ANY OTHER LEGAL THEORY, EVEN IF NOVATEL WIRELESS HAS BEEN ADVISED OF THE POSSIBILITY OR LIKELIHOOD OF SUCH DAMAGES.

Some jurisdictions may require a longer warranty period than specified above and, accordingly, for products sold in those jurisdictions the applicable warranty period shall be extended as required under the laws of those jurisdictions. Furthermore, some jurisdictions may not allow the disclaimer of implied warranties or the exclusion or limitation of incidental or consequential damages, so the above disclaimer, limitation or exclusion may not apply to products sold in those jurisdictions. This limited warranty gives the purchaser specific legal rights and the purchaser may have other legal rights that vary from jurisdiction to jurisdiction. This limited warranty shall be governed by the laws of the State of Texas, United States of America, without regard to conflict of laws principles. This limited warranty shall not be governed in any respect by the United Nations Convention on Contracts for the International Sale of Goods.

Regulatory Compliance

The following agency approvals have been obtained for each model type.

| Model | CE Mark | FCC | Industry Canada |
|-----------|---------|-----|-----------------|
| SA 2100 | Yes | Yes | Yes |
| SA 2100-V | No | Yes | No |

CE MARKING

This device has been tested to and conforms to the essential regulatory requirements of the European Union R&TTE directive 1999/5/EC. The device also conforms to the European Union's restrictions on use of Certain Hazardous Substances in Electrical and Electronic Equipment Directive, 2002/95/EC (commonly called "RoHS") and amendments and 2011/65/EU (commonly called RoHS Recast"). This device has attained CE Marking.

FEDERAL COMMUNICATIONS COMMISSION NOTICE (FCC - UNITED STATES) and INDUSTRY CANADA (IC) NOTICE

Electronic devices, including computers and wireless modems, generate RF energy incidental to their intended function and are therefore subject to FCC rules and regulations.

This equipment has been tested to, and found to be within the acceptable limits for a Class B digital device, pursuant to part 15 of the FCC Rules. These limits are designed to provide reasonable protection against harmful interference when the equipment is operated in a residential environment.

This equipment generates radio frequency energy and is designed for use in accordance with the manufacturer's user manual. However, there is no guarantee that interference will not occur in any particular installation. If this equipment causes harmful interference to radio or television reception, which can be determined by turning the equipment off and on, you are encouraged to try to correct the interference by one or more of the following measures.

- Reorient or relocate the receiving antenna.
- Increase the separation between the equipment and the receiver.
- Connect the equipment into an outlet on a circuit different from that to which the receiver is connected.
- Consult the dealer or an experienced radio/television technician for help.

This device complies with Part 15 of the Federal Communications Commission (FCC) Rules and Industry Canada license-exempt RSS standard(s). Operation is subject to the following two conditions:

1. This device may not cause harmful interference.
2. This device must accept any interference received, including interference that may cause undesired operation.

CAN ICES-3 (B)/NMB-3(B)

WARNING: DO NOT ATTEMPT TO SERVICE THE WIRELESS COMMUNICATION DEVICE YOURSELF. SUCH ACTION MAY VOID THE WARRANTY. THE SA 2100 MODEM IS FACTORY TUNED. NO CUSTOMER CALIBRATION OR TUNING IS REQUIRED. CONTACT NOVATEL WIRELESS, INC. TECHNICAL SUPPORT FOR INFORMATION ABOUT SERVICING YOUR WIRELESS COMMUNICATION DEVICE.

FCC IC CAUTION: Any changes or modification not expressly approved by the party responsible for compliance could void the user's authority to operate this equipment.

MODIFICATIONS: The FCC and IC requires that you be notified that any changes or modifications made to this device that are not expressly approved by Novatel Wireless may void your authority to operate the equipment.

NOTE: The Radio Frequency (RF) emitter installed in your modem must not be located or operated in conjunction with any other antenna or transmitter, unless specifically authorized by Novatel Wireless Technologies.

This device is not for consumer use.

RF EXPOSURE CONTENT

This device is authorized for use in mobile applications after installation. At least 20 cm (8 in) of separation between the router and the user's body must be maintained at all times.

The separation distance is required to meet FCC and IC rules. Failure to install this device according to these instructions will void the FCC and IC acceptance.



External Antenna Instructions

Important instructions: read before installation

Should an external antenna be required, these instructions must be followed. The following installation practices are required to comply with FCC and IC rules on RF exposure. Failure to follow these guidelines can result in operations that exceed RF Exposure limits.

- Maintain a minimum distance of at least 20 cm (8 in) from all persons regardless of how the antenna is mounted (stand assembly or wall mount).
- Connect the antennae to the modem using the supplied cable only – do not use a different cable. Use the full length of the cable to position the antenna as far from the modem and generally populated areas as possible.

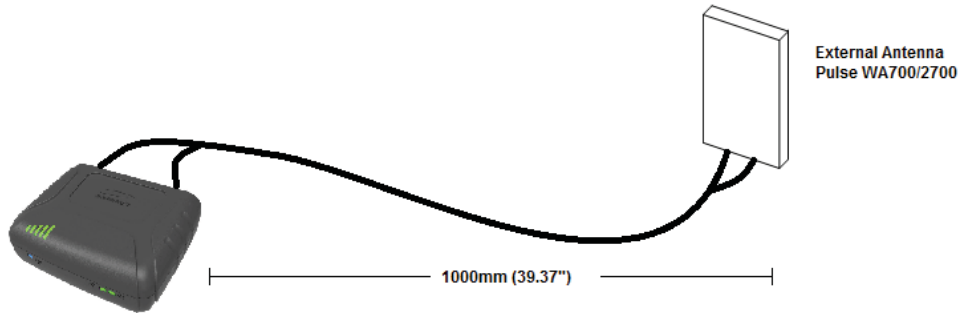

- For wall or pole mount installations position the antennae as far away from the base unit as permitted by the antenna cable. Ensure at least 20 cm (8 in) separation from the antenna element and the public.

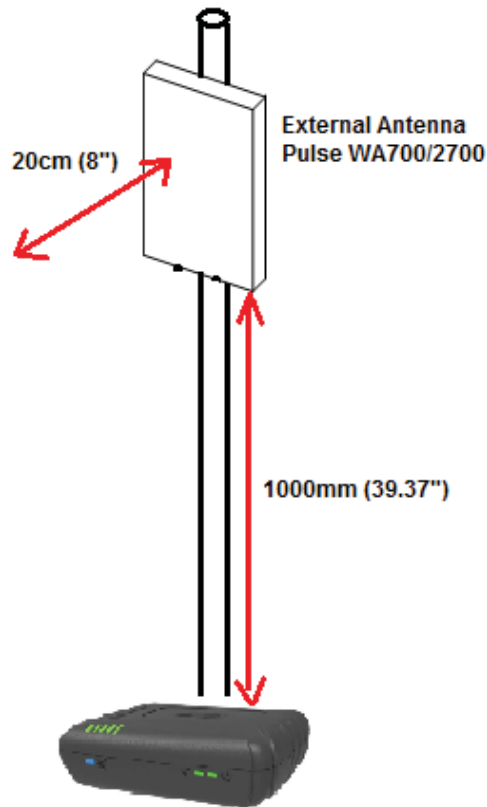

- This antenna must not be located close to any other antennae or devices.
- Use only the following approved antenna types and cable assembly
 - Pulse (Part No.: WA700/2700SMA) Antenna (The gain of the antenna (including cable loss) will not exceed the following:

| Frequency | Maximum Antenna Gain (dBi) |
|-------------|----------------------------|
| 704 - 787 | 3.5 |
| 824 - 849 | 4.0 |
| 1710-1755 | 3.5 |
| 1850 - 1910 | 2.0 |

- The antenna is shipped with both a suction cup and clip for mounting.
 - Use only the supporting cable to connect the antenna to the SA 2100.
 - Never use an antenna from another vendor or another source.
- For any questions regarding the safe operation of this device please contact Novatel Wireless at www.novatelwireless.com.

Battery Information And Safety Requirements

NOTE: Failure to comply with all of the following precautions could:

- Cause personal injury or property damage
- Cause abnormal chemical reactions which would make the battery overheat, smoke, distort, leak, or catch on fire
- Destroy internal protections built into the battery
- Shorten battery life
- Reduce battery performance

Precautions

- Read this entire manual and the label on the exterior of the battery.
- Keep the battery away from sources of excessive heat such as fire, stoves, or direct sunlight.
- Keep the battery away from sources of high voltage or static discharge.
- Do not use or store the battery with other batteries or where it could touch metal.
- Do not put the battery into a microwave oven.
- Do not allow the battery to be crushed.
- Keep the battery away from children.
- Do not drop the battery.
- Do not allow anything to touch any of the battery contacts
- Do not connect two or more of the contacts.
- Do not disassemble, destroy, or attempt reassembly of the battery.
- Do not place or leave the battery in a damp or wet environment.
- Do not allow water to touch the battery.
- Do not wrap the battery with conductive material.
- Properly dispose of the battery.
- Do not incinerate or burn the battery.
- Do not leave or discard the battery where it could get wet or become submerged in water.
- Do not damage the battery.
- Do not weld or solder anything to the battery, the attached wires, or the connector.
- Do not use this battery in any device other than supplied.
- Use of this battery in other devices could result in unsafe conditions.
- Risk of explosion if battery is replaced by an incorrect type.
- Do not touch a leaking battery or materials that may have leaked from a battery. Do not allow it to touch your skin or clothes. If touched, immediately rinse affected areas thoroughly with water. Leaked materials may cause skin irritation. Seek medical attention if irritation persists. If it contacts your eyes, do not rub your eyes. Rinse the eyes thoroughly with water, and see a doctor immediately.

Documentation Conventions

Notes



This is a note, it indicates important features or instructions.

Warnings



This is a warning, it indicates a situation that might result in loss of data, hardware damage, or personal injury.

Hyperlinks

Blue text indicates an active, clickable link (e.g., <http://www.novatelwireless.com>).

Monospace Font

Indicates source code, command line entries, and code embedded in text. Example

Monospace

Boldface

Indicates an on-screen menu, option, window title, or other element that you should locate, select, or click.

Enter / 

Indicates an instruction to press the Enter key. Maybe labeled as Enter, Return, or New Line on your keyboard.

Table of Contents

- 1 Getting Started 1**
- Device Overview 2
- System Requirements 2
- Components 2
- Router 2
- Label 3
- LEDs 3
- Connectors 4
- Reset Button 6
- Caring For Your Device 6
- Technical Specifications 8
- General 8
- Radio Technology (WWAN) -SA 2100 8
- Radio Technology (WWAN) -SA 2100-V 9
- Environmental 9
- Components 9
- Device Management 10
- Document References 10
- Certifications 10
- Accessories 10
- 2 Using The Device 12**
- SIM Card 13
- Positioning Your Router 13
- Powering The Device 14
- Connecting To The SA 2100 Router 14
- Connecting Via USB 14

| | |
|--|-----------|
| Connecting Via Wi-Fi | 14 |
| Driver Installation | 14 |
| Cable Installation | 18 |
| Installing The Antenna | 18 |
| Installing The Power Cable | 19 |
| Mounting The Device | 19 |
| Mounting Bracket | 19 |
| Double-Sided Tape | 20 |
| Vehicle Mounting | 20 |
| 3 Using The Web User Interface | 21 |
| Logging In | 22 |
| Home | 23 |
| Connected Devices | 25 |
| Connected Devices List | 26 |
| Blocking And Unblocking Devices | 27 |
| Data Usage | 28 |
| Data Usage Settings | 28 |
| Settings | 29 |
| Settings Page > Hotspot Settings Tab | 30 |
| Wi-Fi | 30 |
| Basic Settings | 31 |
| Advanced Settings | 31 |
| Settings Page - Device Settings Tab | 32 |
| Settings Page > Device Settings Tab > Preferences | 32 |
| Settings Page > Device Settings > Admin Password | 33 |
| Settings Page > Device Settings > Backup And Restore | 34 |
| Settings Page - Mobile Settings | 35 |
| Settings Page > Mobile Settings > Mobile | 36 |

| | |
|---|----|
| Settings Page > Mobile Settings > APN | 37 |
| Settings Page > Mobile Settings > Network Selection | 38 |
| Settings Page > Mobile Settings > Manual DNS | 40 |
| Settings Page > Mobile Settings > SIM Lock | 41 |
| Settings Page - Advanced Settings | 43 |
| Settings Page > Advanced Settings > Firewall | 43 |
| Settings Page > Advanced Settings > MAC Filter | 45 |
| Settings Page > Advanced Settings > LAN | 46 |
| Settings Page > Advanced Settings > Port Filtering | 48 |
| Settings Page > Advanced Settings > Port Forwarding | 49 |
| Messages | 51 |
| GPS | 52 |
| Using GPS | 53 |
| Current Location | 54 |
| GPS Over Wi-Fi (NMEA) | 54 |
| Customer Support | 54 |
| About | 55 |
| About Page - Current Status Tab | 56 |
| Internet Status | 56 |
| Wi-Fi Hotspot | 57 |
| Operations | 57 |
| About Page - Device Info Tab | 57 |
| About Page - Diagnostics Tab | 60 |
| Modem | 61 |
| HSPA Status - SA 2100 | 61 |
| CDMA Status - SA 2100-V | 62 |
| 4G LTE Status | 62 |
| About Page - Logs Tab | 64 |
| Settings | 64 |

| | |
|--|-----------|
| Log Data | 65 |
| Buttons | 65 |
| About Page - Software Update Tab | 66 |
| Current Software | 66 |
| Last Update | 67 |
| Update History | 67 |
| 4 Accessories | 68 |
| Antenna | 69 |
| Backup Battery | 71 |
| Power Cable | 71 |
| Power Supply | 72 |
| USB Cable Part | 73 |
| Ordering Accessories | 73 |

1

Getting Started

Device Overview

LEDs

Connectors

Reset Button

Caring For Your Device

Technical Specifications

Device Overview

The SA2100 Cellular Router allows you to set up a network and provides both wired and wireless connectivity.

This device is intended for professional installation and not for consumer use.

System Requirements

- A computer or computing device supporting Wi-Fi 802.11 b/g/n
- Internet browser software: i.e., Microsoft Internet Explorer 8.0 or higher, Firefox, Safari, Opera, Chrome, etc.

Components

Router



Figure 1-1 SA 2100

Label

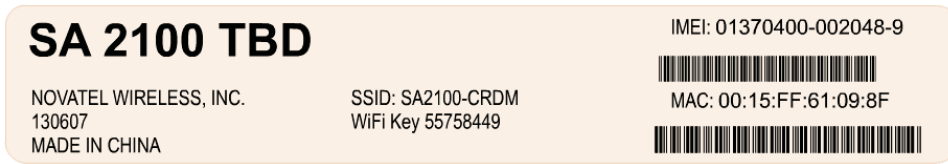

Figure 1-2 Device Label

The label on the rear part of the router displays the following information:

- MAC Address
- IMEI or ESN Number
- SSID (Factory preset, unique to each device)
- WiFi Key (Factory preset, unique to each device)

LEDs



The SA 2100 router has LEDs that verify status, signal, and connectivity.



Figure 1-3

The following table describes each LED:

| Symbol | LED | Color | State | Description |
|---|--------|-------|-----------------------------------|--|
|  | Power: | Green | On | Normal operation (External or Battery Power) ** Note When operating on Battery power all other LEDs are OFF. The LED blinks slowly, once every 5 secs when running on the battery. |
| | | | Blinking 1 sec On 2 sec Off | During device Reset or Power-up sequence |

| Symbol | LED | Color | State | Description |
|---|---------------------------------|--------|-----------------------------------|--|
|  | WiFi: | Green | Off | WiFi not enabled or No Wi-Fi connected devices or device is powered from Battery |
| | | | On | External Power - Wi-Fi devices Attached but no Wi-Fi traffic |
| | | | Blinking 1 sec On 1 sec Off | Wi-Fi traffic |
|  | WAN - LTE | Green | ON | Attached (LTE) - no traffic |
| | | | Blinking 1 sec On 1 sec Off | PDP Activity |
| | WAN - 4G/3G | Blue | ON | Attached (4G/3G) - no traffic |
| | | | Blinking 1 sec On 1 sec Off | PDP Activity |
| | WAN - 2G | Orange | ON | Attached (2G) - no traffic |
| | | | Blinking 1 sec On 1 sec Off | PDP Activity |
|  | Cellular 5-bar signal strength: | Green | Off | No SIM/No Signal/Operating from battery |
| | | | On | Active only when external power is present. |



Note that while the SA 2100 is operating on battery power, the Power LED is the only LED that operates.

Connectors

The SA 2100 router has the following connectors:

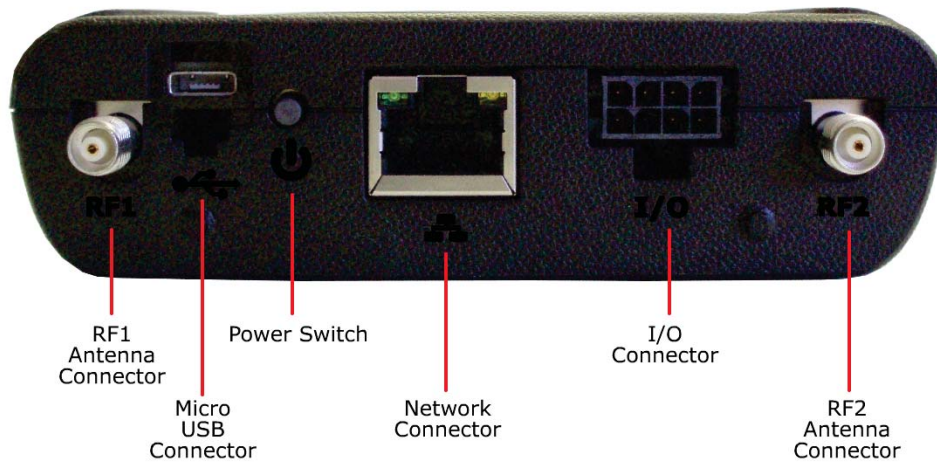





Figure 1-4 Router Connections

- RF1** Cellular antenna connector RF1 (Primary)
-  Micro USB Port
-  Graceful shutdown button
-  Ethernet port
- I/O** 8 Pin IO connector (Includes power)
- RF2** Cellular antenna connector RF2 (Diversity)

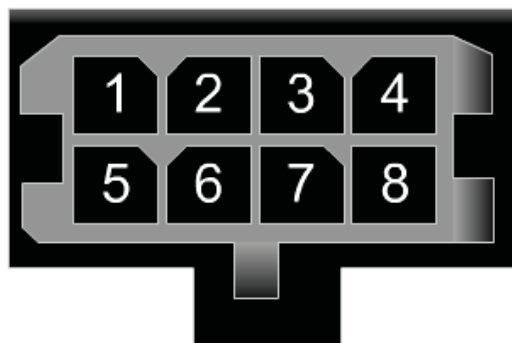

Figure 1-5 8 Pin IO connector

For Pin Out descriptions refer to the ["Power Cable" on page 71](#)

Reset Button

The Reset Button is inside the battery compartment.

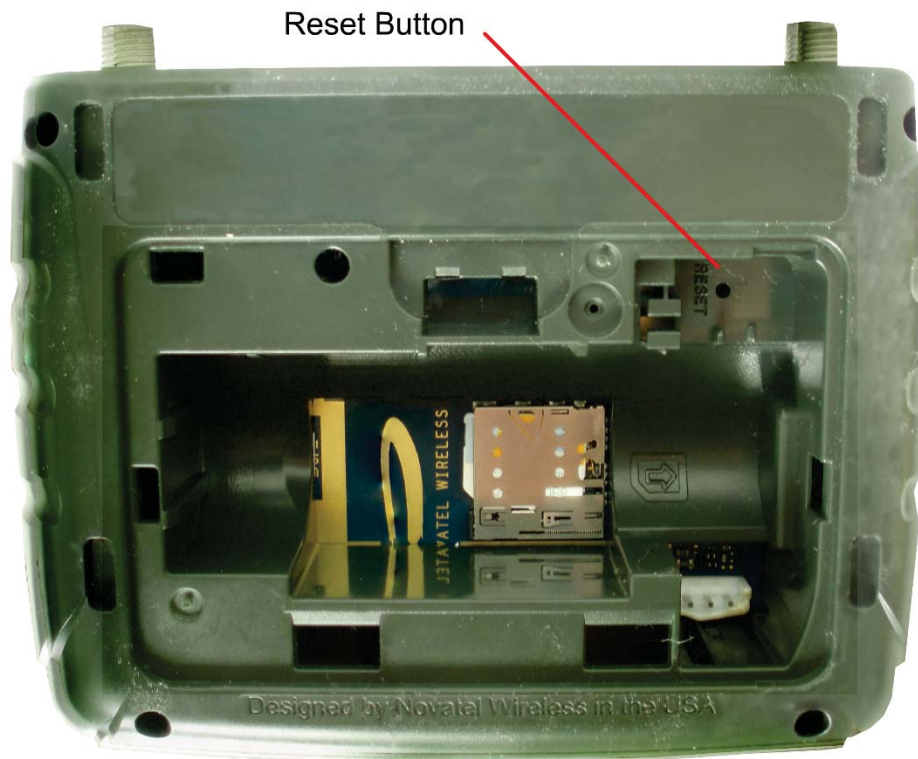

Figure 1-6 Reset Button

In the corner of the battery compartment the Reset button is a small hole about 1.5mm in diameter, with the word “RESET” below it.

We recommend that you use a paperclip to push the Reset button if a device reset is required.

Caring For Your Device

You must handle the SA 2100 router carefully to ensure it functions properly.

We recommend the following guidelines:

- Place the router in an area free from liquids, dust, and extreme temperatures.
- Store the router back in its box when not in use.
- Do not block any ventilation openings by applying adhesives or labels to the router as this might cause the device to overheat or it might interfere with the antenna.
- Clean only with a clean, dry cloth.

- Route the cord so that it is not easily damaged by someone walking on it, or by items

- sitting on or against it.
- Route the cord so that it is not easily damaged by someone walking on it, or by items sitting on or against it.
- Avoid dropping or shaking the router.
- Avoid moving the router when it is powered on.

Technical Specifications

General

| | |
|--------------------|---|
| Model: | SA 2100 / SA 2100-V |
| Weight: | 220g |
| Dimensions: | 107 x 81 x 30 mm |
| Wireless Network: | Wi-Fi 802.11 b/g/n, 10 clients, pre-configurable security: WPA/WPA2 |
| Wired: | 1 Ethernet Port (RJ45 Connector) |
| Battery: | 10-hour continuous (optimal) |
| Input Power Range: | 9 - 32 VDC (Molex Connector); 12V or 24V vehicle ready |

Radio Technology (WWAN) -SA 2100

| | |
|---|--------------------------|
| FREQUENCY | |
| 4G LTE: | 750/850/AWS/1900 MHz |
| 3G UMTS/HSPA/HSPA+: | 850/900/AWS/1900/2100MHz |
| 2G GPRS/EDGE: | 850/900/1800/1900 MHz |
| BANDS | |
| LTE: | B2, B4, B5, B17 |
| WCDMA: | B1, B2, B4, B5, B8 |
| GSM: | B8, B9, B13, B14 |
| DATA SPEED | |
| LTE: | 100 Mbps |
| DC-DSPA+: | 42 Mbps |
| HSPA+: | 21 Mbps |
| ROUTING | |
| DHCP server, DNS, static or dynamic IP address, port filtering, port forwarding | |
| SECURITY | |
| NAT, SPI Firewall, VPN pass-through, IPSec VPN, MAC access control | |

Radio Technology (WWAN) -SA 2100-V

| FREQUENCY | |
|---------------|--------------|
| 4G LTE: | 700/1700 MHz |
| 3G CDMA 2000: | 850/1900 MHz |

| BANDS | |
|-------|----------|
| LTE: | B4, B13 |
| CDMA: | BC0, BC1 |

| DATA SPEED | |
|------------|----------|
| LTE: | 100 Mbps |
| CDMA: | 3.1 Mbps |

| ROUTING | |
|---|--|
| DHCP server, DNS, static or dynamic IP address, port filtering, port forwarding | |

| SECURITY | |
|--|--|
| NAT, SPI Firewall, VPN pass-through, IPSec VPN, MAC access control | |

Environmental

| | |
|------------------------|---|
| Operating Temperature: | -30°C to 70°C (external power) -20°C to 60°C (battery) |
| Storage Temperature: | -40°C to 85°C (external power) -40°C to 60°C (battery) |
| Humidity: | Up to 95% non-condensing |

Components

| | |
|----------------------------|--|
| Built-In Wi-Fi (2.4 GHz): | Up to 10 endpoints |
| Network Selection Switch: | 4G/3G |
| SIM: | 1 slot for micro-SIM card (Inside Battery Compartment) |
| Internal Cellular Antenna: | (primary + diversity) |
| External Cellular Antenna: | (primary + diversity) Automatically switches between internal and external; SMA Connector |
| Internal Wi-Fi Antenna: | 2.4 GHz |
| Internal GPS Antenna: | 1575 MHz |
| Micro USB on-the-go: | latched |
| Digital Outputs: | 2 |
| Digital output (latched) | 1 |

| | |
|----------------------------------|-------------|
| User-controlled I/O | 2 |
| 1-Wire Interface | Yes |
| LEDs: | |
| Power | Green |
| Wi-Fi | Green |
| Network Indicator for 4G, 3G, 2G | Multi-Color |
| 5-bar Signal Strength | Green |

Device Management

| | |
|-------------------------|--|
| Production Environment: | Cloud-Based |
| Testing Environment: | Cloud-based; 90-day free access with engineering support |
| Bulk Provisioning | Over-the-Air or local |
| Firmware Upgrade: | FOTA or local |

Document References

| | |
|---|--------------|
| SA 2100 AT Command Set | SA2100AT001 |
| FOTA Application Note | ENF0000AN002 |
| API Reference | ENF0000CB001 |
| Access the Novatel Wireless M2M Test Server | ENF0000AN014 |
| 1-Wire Interface Application Note | ENF0000AN018 |

Certifications

| | SA 2100 | SA 2100-V |
|-----------------|---------|-----------|
| FCC: | Yes | Yes |
| CE: | Yes | No |
| IC: | Yes | No |
| PTCRB: | Yes | No |
| GCF: | Yes | No |
| Wi-Fi Alliance: | Yes | Yes |
| eMark: | Yes | No |
| Safety: | Yes | Yes |
| AT&T: | Yes | No |
| Verizon: | No | Yes |

Accessories

| | |
|-----------------------|--|
| Lithium Battery | Rechargeable 3.7 V 2900 mAh 1073 Wh Li-ion battery |
| Mounting Accessories: | Mounting bracket, Velcro tape, tie-wrap, bolts, adhesive |

| | |
|-------------------------------|---|
| Mounting Bracket | |
| Mounting Bracket (in-vehicle) | |
| Mounting Options: | Wall, ceiling, floor, vehicle, existing structure, flat surface |
| Power Adapter | Molex, AC |
| Power Cable | Molex, DC |
| USB Cable | Latched |
| External Cellular Antenna | SMA |

2

Using The Device

SIM Card

Positioning Your Router

Powering the Device

Connecting to the SA 2100 Router

Driver Installation

Cable Installation

Mounting the Device

SIM Card

Insert the SIM card into the SIM card slot located inside the battery compartment. Remove the battery to uncover the SIM card holder.

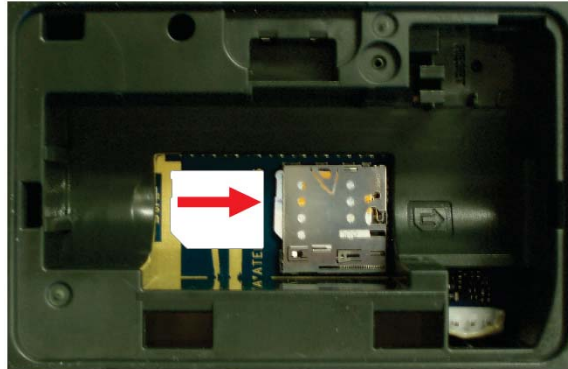

Figure 2-1 SA 2100 Battery Compartment

You should hear a "click" when the SIM card is in place.

Positioning Your Router

The router allows you to access your network almost anywhere within a given operating range. However, this range depends on where you place your router. The placement of furniture, the thickness of walls, and the number of walls a signal must travel through can limit this range.

For best results, place your router:

- Away from interference such as microwaves, ceiling fans, security systems, or cordless phones
- Away from large containers of glass or concrete (fish tanks, mirrors, brick or concrete walls)
- Away from large metal surfaces (cook tops, metal doors, aluminum studs, appliances)
- Close to a window but out of the way of direct sunlight (great for 4G reception)
- Close to an AC outlet and near Ethernet computer cables
- In an elevated location
- In line-of-sight to wireless devices
- Near the computers or other devices that communicate with the router
- On an upper floor (if applicable)

When using multiple points of access, use different radio frequency channels for adjacent access points. We recommend leaving 5 spaces between channels (1 and 6, or 3 and 8).

Powering The Device

When the power adapter is connected, the SA 2100 powers up automatically. It takes approximately two minutes for the device to power up and register on the cellular network.

Connecting To The SA 2100 Router

Users can connect to the SA 2100 router either via USB cable or Wi-Fi connection.

Connecting Via USB

To connect via USB, perform the following steps:

1. Install the USB and network adapter drivers using the driver installation executable file provided by Novatel Wireless. (Detailed instructions for installing these drivers are provided in the Driver Installation section of this document.)
2. Ensure the SA 2100 router is powered on.
3. Connect the router to a USB port on the computer using a micro-USB cable.

Connecting Via Wi-Fi

To connect via Wi-Fi, perform the following steps:

1. Ensure the SA 2100 router is powered on.
2. Connect to the router using the SSID and WPA key information provided on the label.

Driver Installation

These instructions illustrate how to correctly install the drivers in Windows 7 using the Novatel Wireless M2M Driver Setup Utility.

1. Run the Novatel Wireless M2M Driver Setup Utility by double-clicking the **Novatel Wireless Factory Driver Installer** executable file.



The Novatel Wireless Factory Driver Installer Welcome window opens.

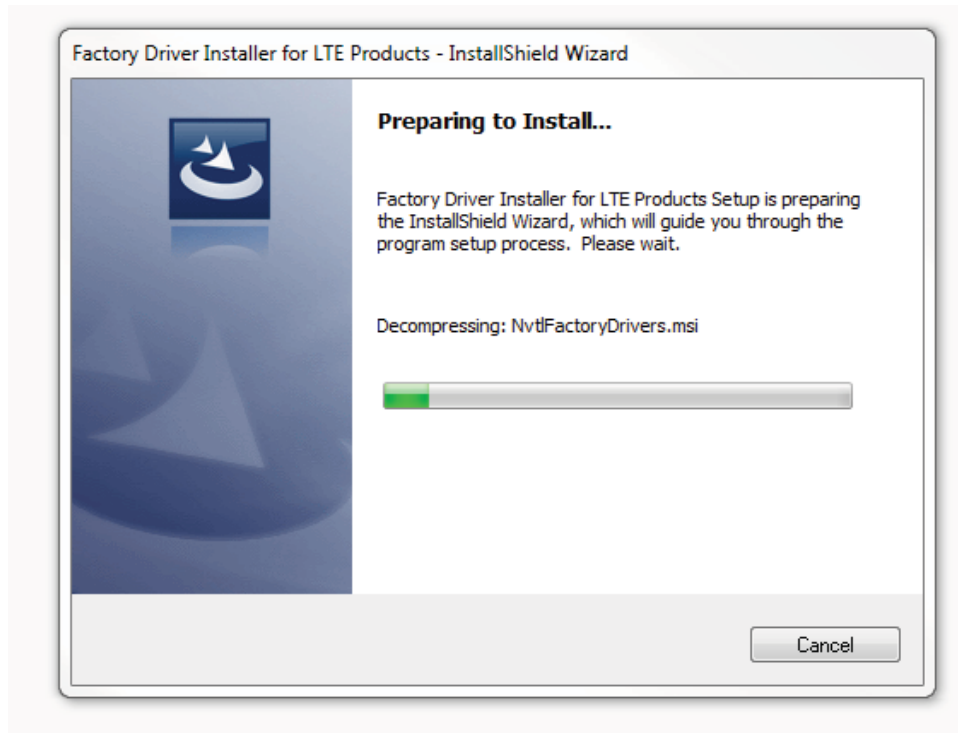

Figure 2-2 Factory Driver Installer for LTE Products

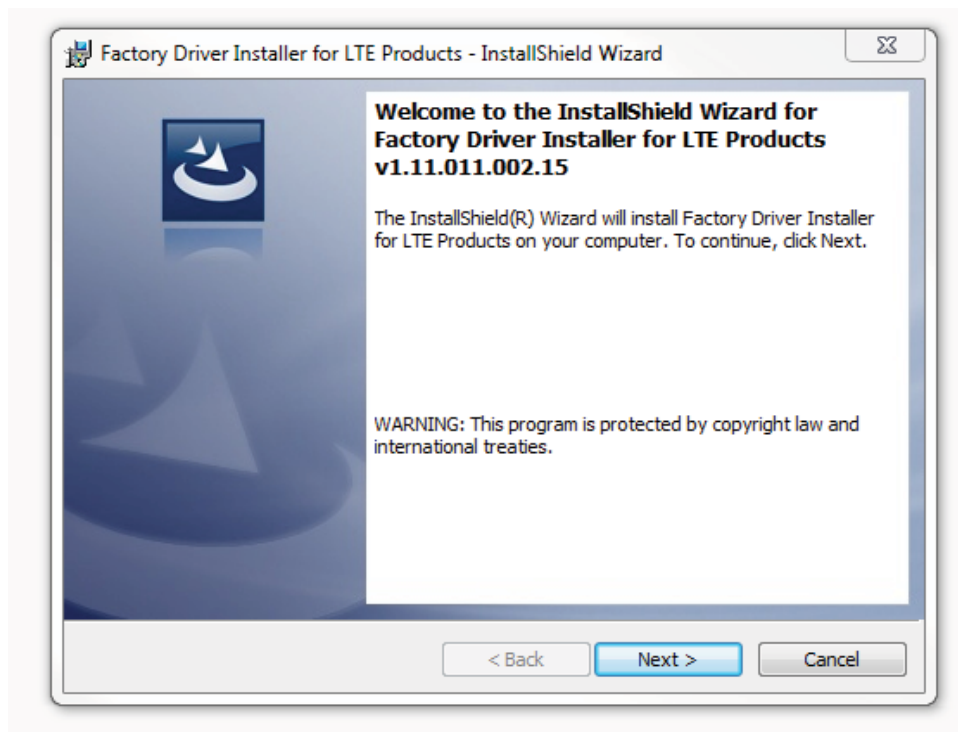

Figure 2-3 Driver Installer Welcome Screen

2. Click **Next**.

The Novatel Wireless Factory Driver Installer License Agreement Window opens.

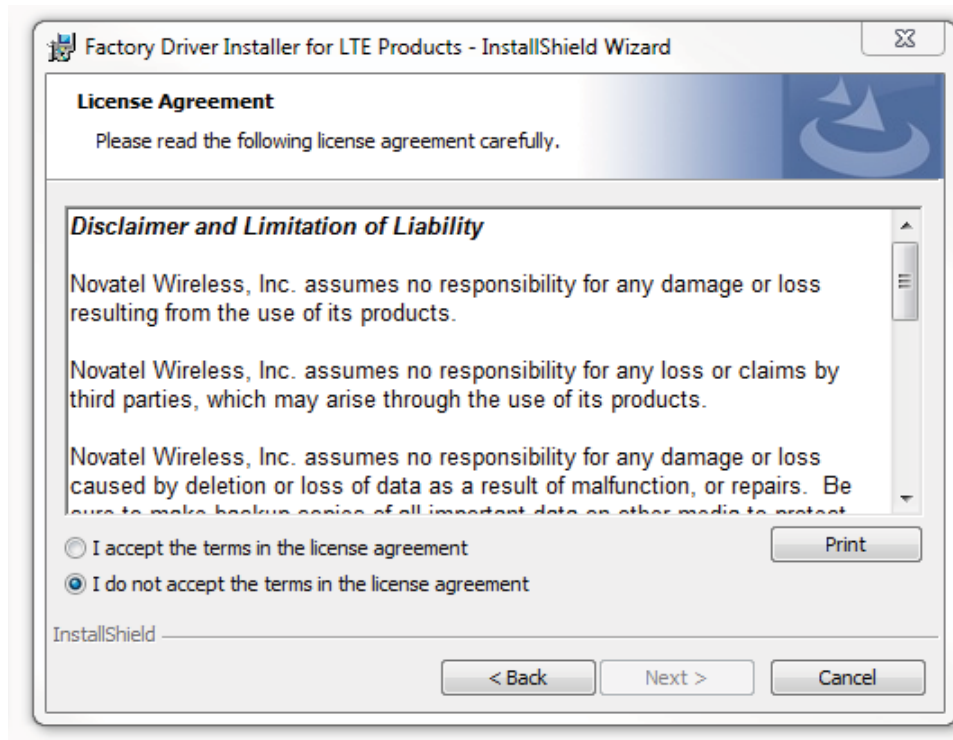

Figure 2-4 Driver Installer License Agreement

3. Once you have read, and if you agree to the terms, select the **I accept the terms in the license agreement** radio button.
4. Click **Next**.

The Ready to Install the Program window will open.

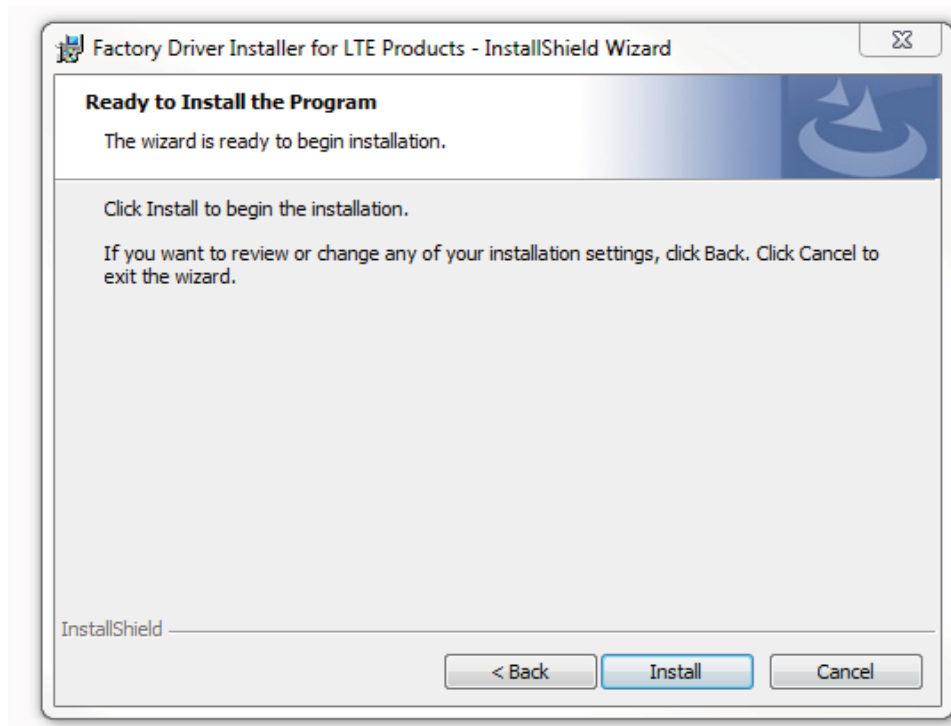

Figure 2-5 Driver Installer Ready to Install screen

5. Click **Install**.

The Installation Progress window will open.

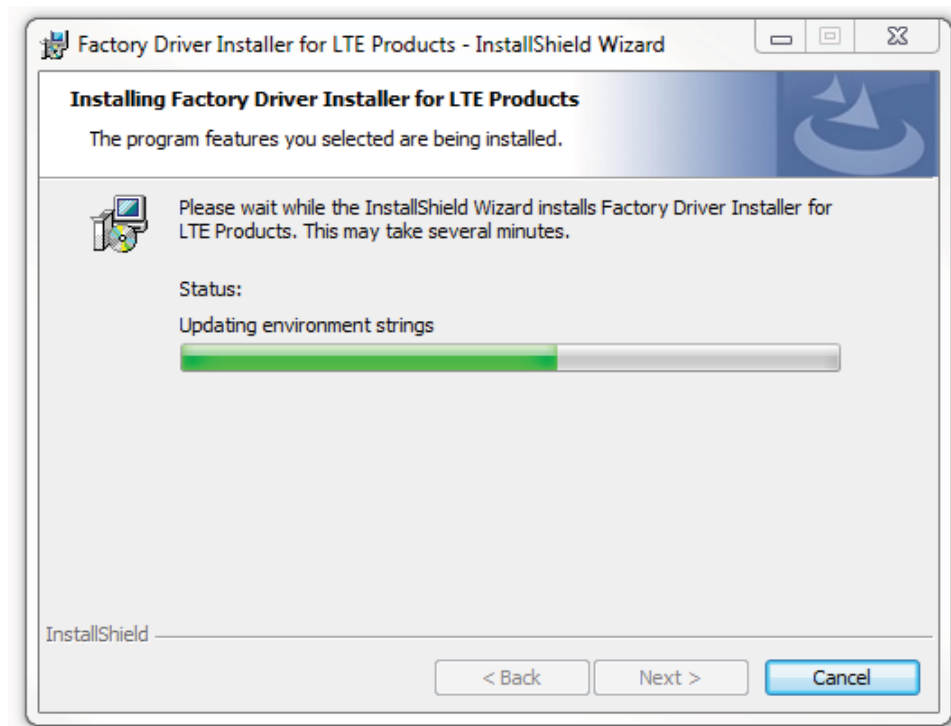

Figure 2-6 Installing screen

Once the installer has successfully installed the driver, the Installation Complete window will open.

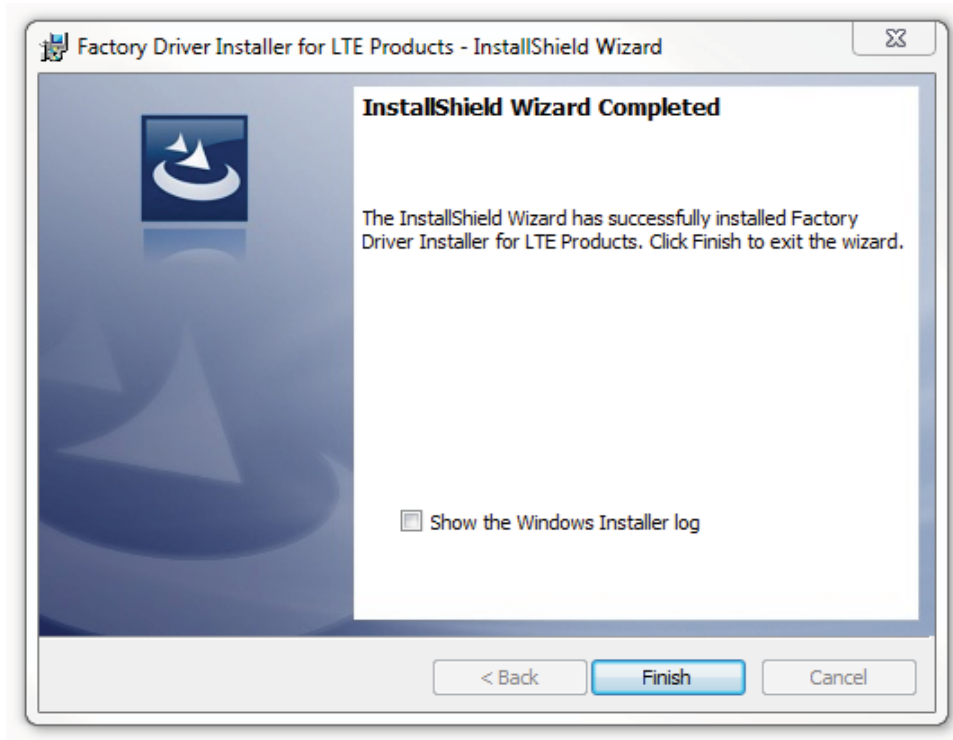

Figure 2-7 Installation Completed screen

6. Click **Finish**.

Cable Installation

Installing The Antenna

Connect the antennas to the device before mounting the device.

At least 20 cm (8 in) of separation between the router and the user's body must be maintained at all times.

Connect the antennae to the modem using the recommended cable only.

Installing The Power Cable

Connect the power cable to the device before mounting the device.

Connect a 12V or 24V vehicle ready power supply to the device. Pin-5 of the Molex connector.

The voltage must be within the 9 - 32 VDC range. See ["Technical Specifications" on page 8](#)

Connect the device (Pin-4) to the vehicle ground.

Mounting The Device

Mounting Bracket

To mount the device using the Mounting Bracket, use the accessory SKU # 21915042

While performing these steps, do not apply excessive force to the retention legs or snap feature prior to inserting the device as this may deform the mounting bracket.



Figure 2-8 SA 2100 Mounting Bracket

1. Secure the mounting bracket to the desired mounting surface using one of the following methods:
 - Two (2) # 6 screws
 - Double-sided tape
2. Insert the device into the mounting bracket as shown in the figure above. The device should be inserted with the battery compartment down. Take care to position the device so that the top of the device has the best unobstructed path to the sky.

Double-Sided Tape

If securing the device using double-sided tape or a method not described in this manual, note the following precautions:

- Excessive force in the middle of the device may cause damage to the device.
- If using rigid mounting hardware, apply pressure only to the ends of the device. Limit the mounting pressure only to the amount needed to secure the device.

Vehicle Mounting

Follow the steps and guidelines in this section if you are Mounting the SA 2100 in a Vehicle.

Novatel Wireless recommends the SA 2100 vehicle installation should be carried out by a qualified automotive electronic accessory technician.

Always mount the device with the battery compartment facing downward..

Ground should be connected first. Failure to connect ground to the SA 2100 before connecting auxiliary devices may result in damage to the attached I/O device.



To ensure proper accelerometer operation, you must securely mount the SA 2100. Mounting the device to cable runs or other structures that may allow the device's orientation to shift may cause inaccurate results to be reported by the accelerometer.

For optimal performance, note the following mounting precautions/guidelines:

- Choose a location where metal or cable bundles will not shield the device.
- Avoid possible interference by mounting the device away from radio or speaker wires.

We suggest you mount your device in one of the following locations:

- Above the air vents
- Above the instrument cluster
- Above the glove box

Do not mount the device in the following locations:

- Engine bay
- Near or in the path of a vehicle's airbag

3

Using The Web User Interface

Logging In
Home
Connected Devices
Data Usage
Settings
Messages
GPS
Customer Support
About

Logging In

To log in to your SA 2100 Web Interface, open your Internet browser and navigate to 192.168.1.1. or http://my.sa2100/

The browser will display the SA 2100 Home Page.

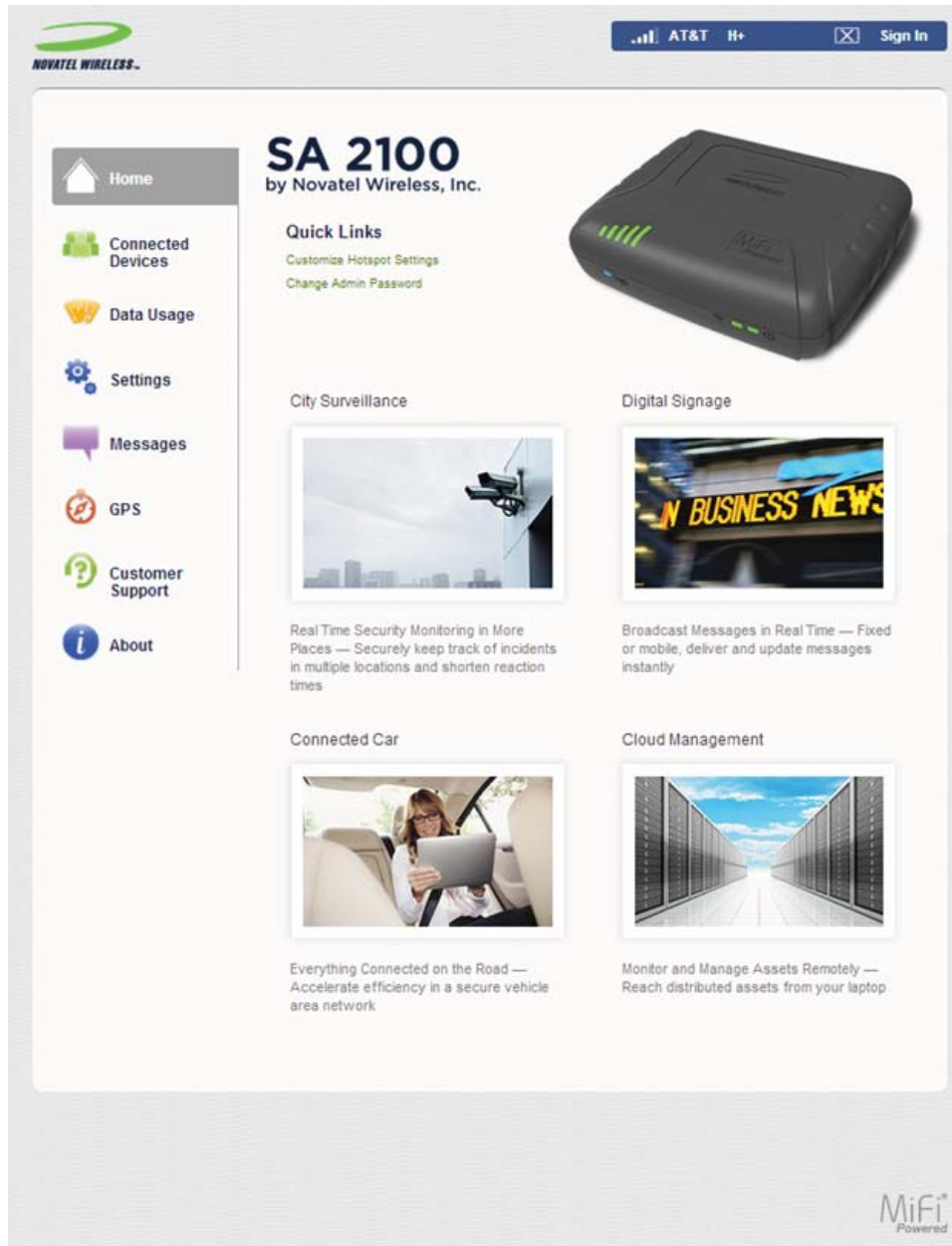

Figure 3-1 SA 2100 Home Page

You must enter the Administrator password to proceed beyond the Home Page. To enter the password, either click the **Sign In** link in the top right corner of the page, or simply click any of the quick links or navigation tabs and the SA 2100 Sign In page will be displayed as shown in the following figure.



Figure 3-2 SA 2100 Sign In Page

Enter your Administrator password and click **Sign in**.



The default Administrator password is "admin" (without the quotation marks).

Home

The Home Page of the SA 2100 Web User Interface can be found by selecting the **Home** tab.

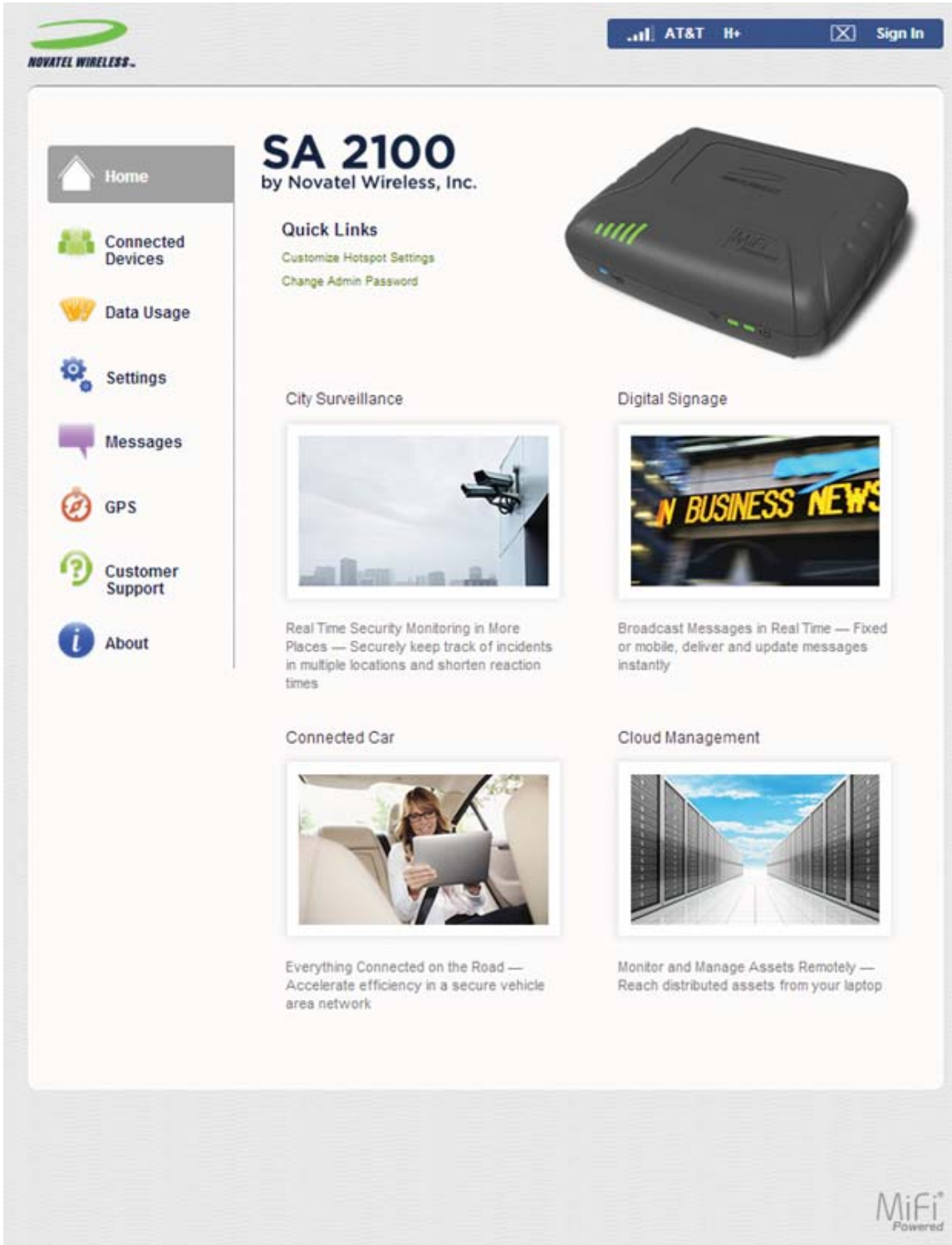

Figure 3-3 Home Page

The left side of the screen displays navigation tabs for Home, Connected Devices, Data Usage, Settings, Messages, GPS, Customer Support, and About.

The SA 2100 Home page has Quick Links for the following:

- Customize Hotspot Settings
- Change SA 2100 Administrator Password

The Quick Links are shortcuts to the most commonly used settings. Details of these settings are discussed in the Settings section of this document.

Connected Devices

The Connected Devices page displays details of each device connected to, or blocked from this SA 2100 device, including any computer connected via a USB connection. You can also edit the name and type for connected devices, and add or remove connected devices from the Blocked Devices list.

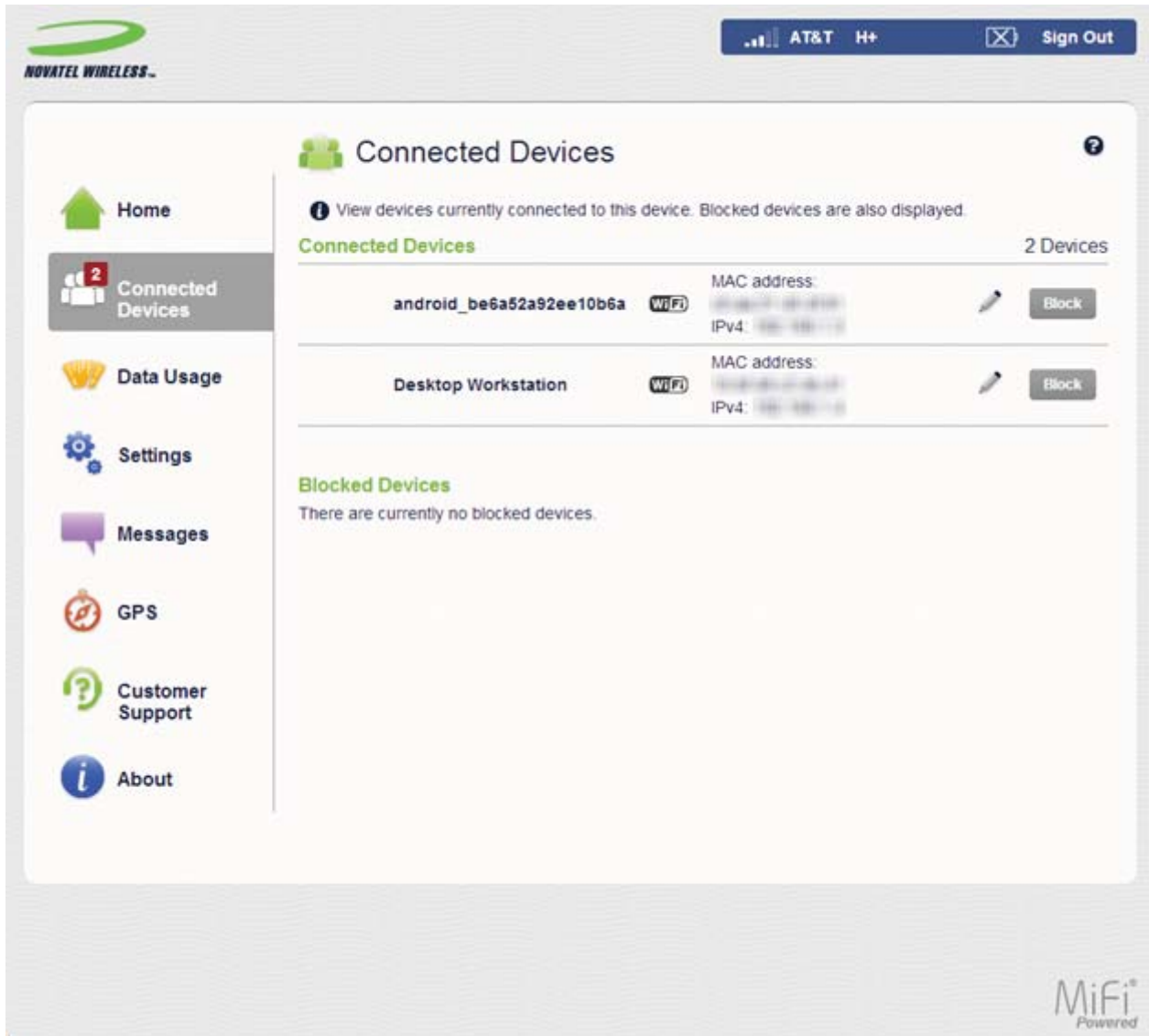

Figure 3-4 Connected Devices Page

Connected Devices List

The following information is displayed for each connected device:

Type

The first column indicates the type of connected device. You can use the **Edit** option to set or change the type.

If the type has not been set, no icon is displayed. Once you set the device type, an appropriate icon is displayed.

Name

Normally, this is the hostname of the connected device, as set on the connected device. If you have used this interface to assign a name to a connected device, the assigned name displays in place of the hostname. In rare cases, the hostname may be unavailable.

You can use the **Edit** option to change the name of any connected device.

Connection Type

An icon indicates the network connection type for each connected device

MAC Address

The MAC Address is a unique network identifier for this connected device.

IP Address

The IP address of the connected device.

Link-Local

If supported and used, the IPv6 address (Link-Local address) of the connected device is displayed.

Blocking And Unblocking Devices

Block Button

Clicking the **Block** button disconnects the connected device and prevents it from reconnecting. The blocked device then appears in the Blocked list. This option is available for use with each connected device, except for your own device, and any device connected via USB.

Blocked Devices

This is a list of devices that you have blocked. Note that since these devices are not currently connected, and are blocked from connecting, they do not have an IP address. Instead, they are identified by their name and MAC address.

Unblock Button

Clicking the **Unblock** button unblocks a previously blocked device, freeing it to connect again. The unblocked device is deleted from the Blocked List, and will reappear in the Connected Devices list when it connects.

Data Usage

The Data Usage screen displays your current data usage. You can also reset the data counter and cycle start date, and select the desired data usage monthly limit. Alerts will be generated to warn you that data usage is approaching or has reached the alert level specified on this page.

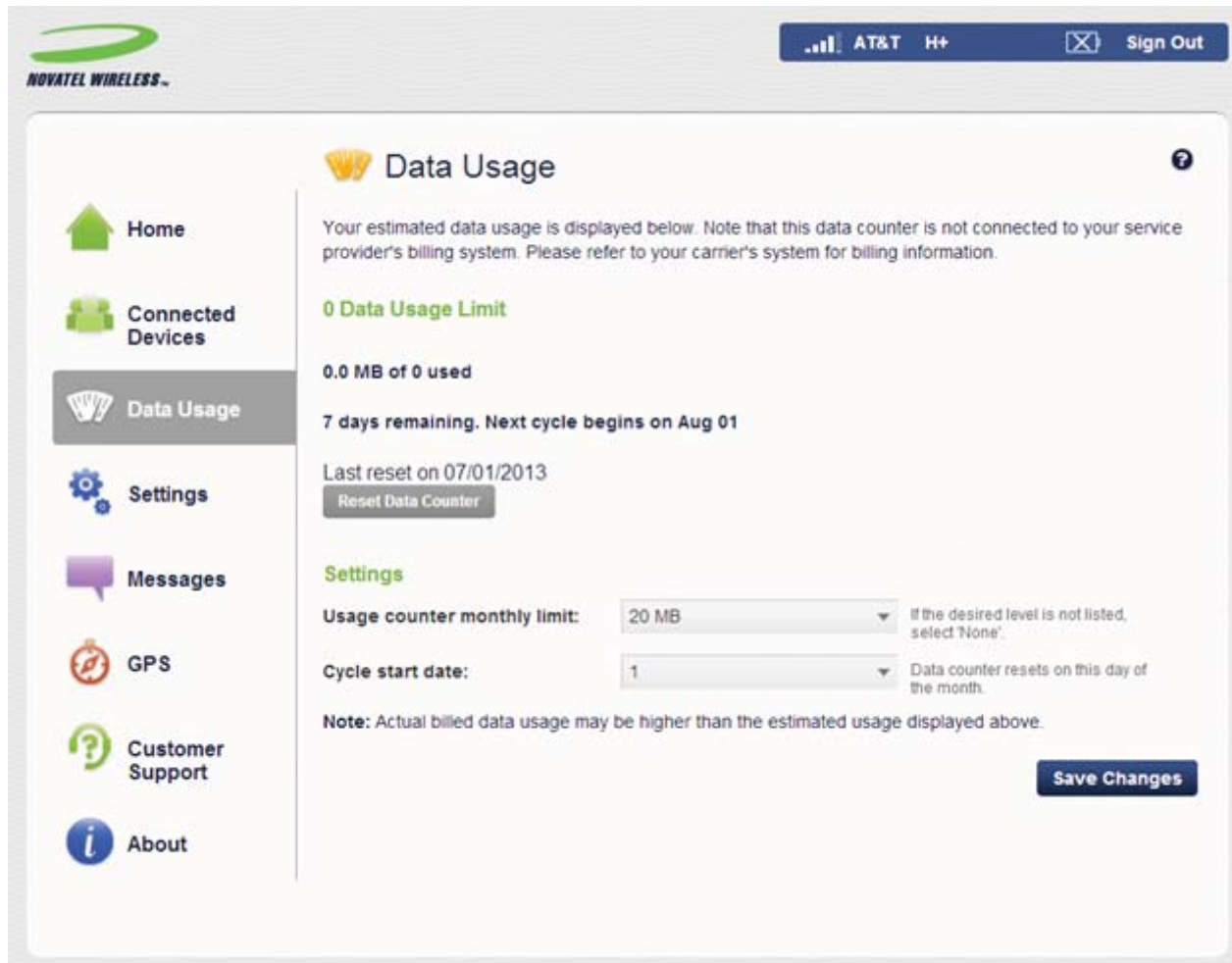

Figure 3-5 Data Usage Page

Reset

You can use the **Reset Data Counter** button to restart the data counter and set the last reset date to today's date.

Data Usage Settings

Usage Counter Monthly Limit

Select the desired option. If the desired option is not available, select 'None'. In this case, data usage will be recorded and displayed, but cannot be compared to a monthly limit.

Cycle Start Date

Select the day of the month when you wish the data counter to reset to zero.

Settings

The settings of your SA 2100 can be found on the **Settings** page.

There are four settings tabs: Hotspot Settings, Device Settings, Mobile Settings, and Advanced Settings.

Settings Page > Hotspot Settings Tab

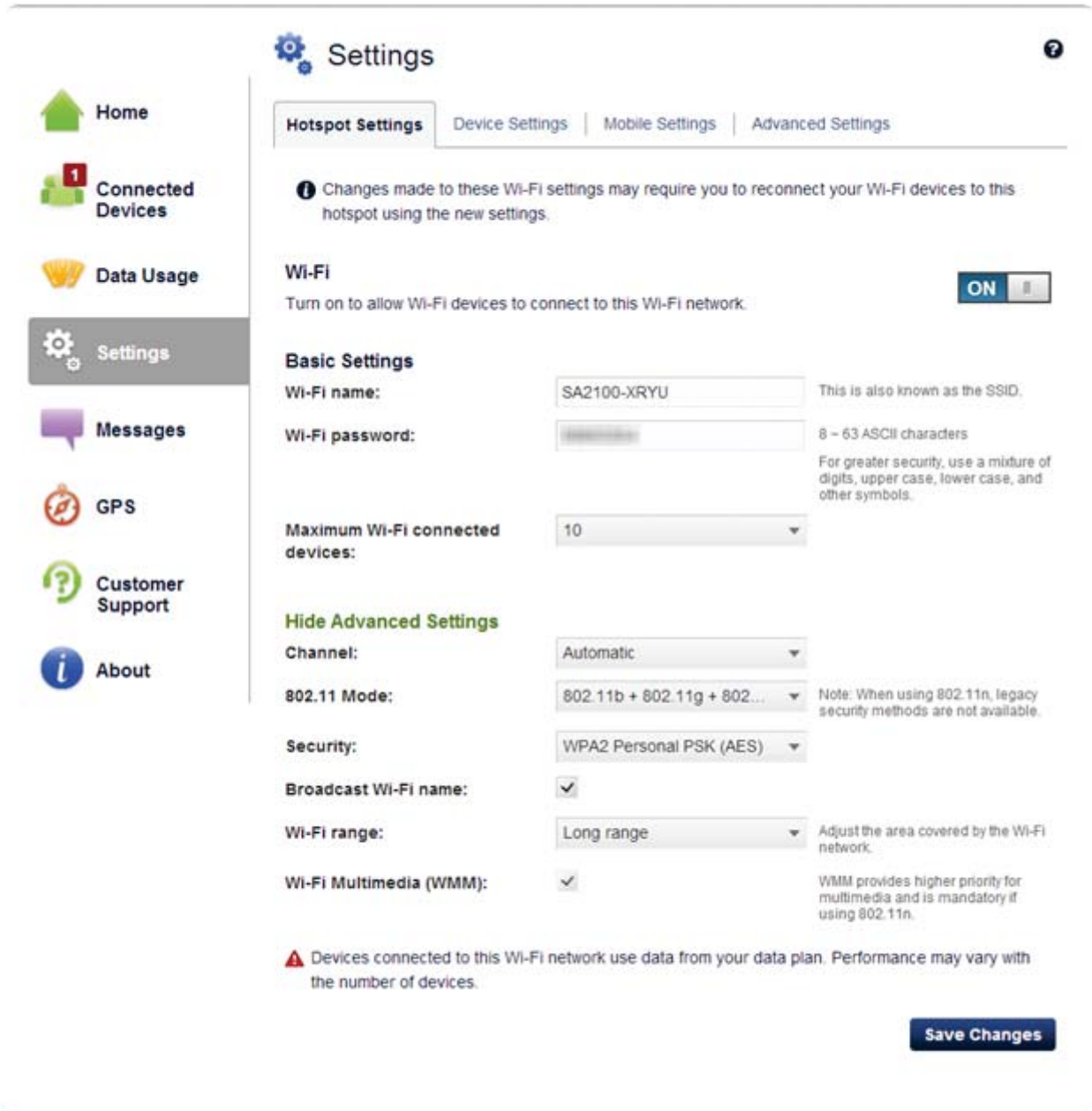

Figure 3-6 Settings Page - Hotspot Settings (Advanced Settings Shown)

The Hotspot Settings Tab contains the following information:

Wi-Fi

Click this ON/OFF control to enable or disable the Wi-Fi hotspot.

Basic Settings

All Wi-Fi connected devices must use these Wi-Fi settings. If you change these settings, existing connected devices may lose their connection.

Wi-Fi name: This sets the network name or SSID for the Wi-Fi network created by this device. Enter a suitable name. The name can be up to 32 characters long.

Wi-Fi password: If a setting other than Open was selected in the Security field, a Wi-Fi password is required. Enter the Wi-Fi password in this field. An on-page hint indicates the password requirements for the current security option.

Maximum Wi-Fi connected devices: Specify how many devices can simultaneously connect to this device (Maximum of 10).

Advanced Settings

By default, the advanced settings are hidden. Click the **Show Advanced Settings** link to display the advanced settings. When the advanced settings are displayed, you can click the **Hide Advanced Settings** link to hide them.

Channel: This should be left on Automatic unless you need to choose a particular channel for your environment.

802.11 Mode: Use this setting to change the Wi-Fi mode, if required. If all of your connected devices support 802.11n, selecting the option "802.11n only" will provide the best performance. In other cases, it is recommended that you leave this setting at its default value.

Security: Select the desired option for Wi-Fi security. WPA2 is the latest and most secure method, and should be used if possible.



None allows other people to monitor your Wi-Fi traffic and use your data plan to access the Internet. If at all possible, using None should be avoided. Using WPA2 is strongly recommended, as this is the most secure method supported.

Broadcast Wi-Fi name: If this setting is enabled, this Wi-Fi network appears in the list of available Wi-Fi networks on your connected devices. If disabled, this network will be invisible.

Wi-Fi range: Use this option to determine the strength of the Wi-Fi signal, and hence the size of the Wi-Fi network.



If running on the battery, the longer range or higher power option will deplete the battery more quickly.

Wi-Fi Multimedia (WMM): This setting should normally be enabled to assist throughput. It must be enabled if you are using 802.11n.

Settings Page - Device Settings Tab

Under Device Settings you have three categories of settings:

- Preferences
- Web Interface Password
- Backup and Restore

Settings Page > Device Settings Tab > Preferences

The screenshot shows the Novatel Wireless web interface. At the top left is the Novatel Wireless logo. At the top right, there is a status bar showing signal strength, AT&T H+, and a Sign Out button. The main content area is titled 'Settings' and has a gear icon. Below the title are four tabs: Hotspot Settings, Device Settings (selected), Mobile Settings, and Advanced Settings. Under the Device Settings tab, there are three sub-sections: Preferences (selected), Admin Password, and Backup and Restore. The Preferences section is divided into Device Preferences and User Preferences. Under Device Preferences, there is a 'Delayed shutdown:' label and a dropdown menu set to 'Never', with a note: 'Shut the device down when running on battery.' Under User Preferences, there are five dropdown menus: 'Language:' set to 'English', 'Date format:' set to 'mm/dd/yyyy', 'Time:' set to '12 Hour', 'Distance:' set to 'Feet', and 'Number format:' set to '3,234.00'. A 'Save Changes' button is located at the bottom right of the settings area. On the left side of the page, there is a navigation menu with icons and labels for Home, Connected Devices, Data Usage, Settings (highlighted), Messages, GPS, Customer Support, and About.

Figure 3-7 Settings Page - Device Settings - Preferences

Device Preferences

Delayed Shutdown: When powered by the battery, select the length of time after which the device shuts down when no network devices are connected. To prevent automatic shutdown, select "Never".

User Preferences

- **Language:** Select the desired language option.
- **Date Format:** Specify the format in which the date is displayed on this Web-based interface.
- **Time:** Specify the format in which the time is displayed on this Web-based interface.
- **Distance:** Select the option used for the GPS altitude and accuracy.
- **Number Format:** Specify how decimal numbers are displayed. Period (.) or Comma (,) can be selected for use as the decimal point.

Settings Page > Device Settings > Admin Password

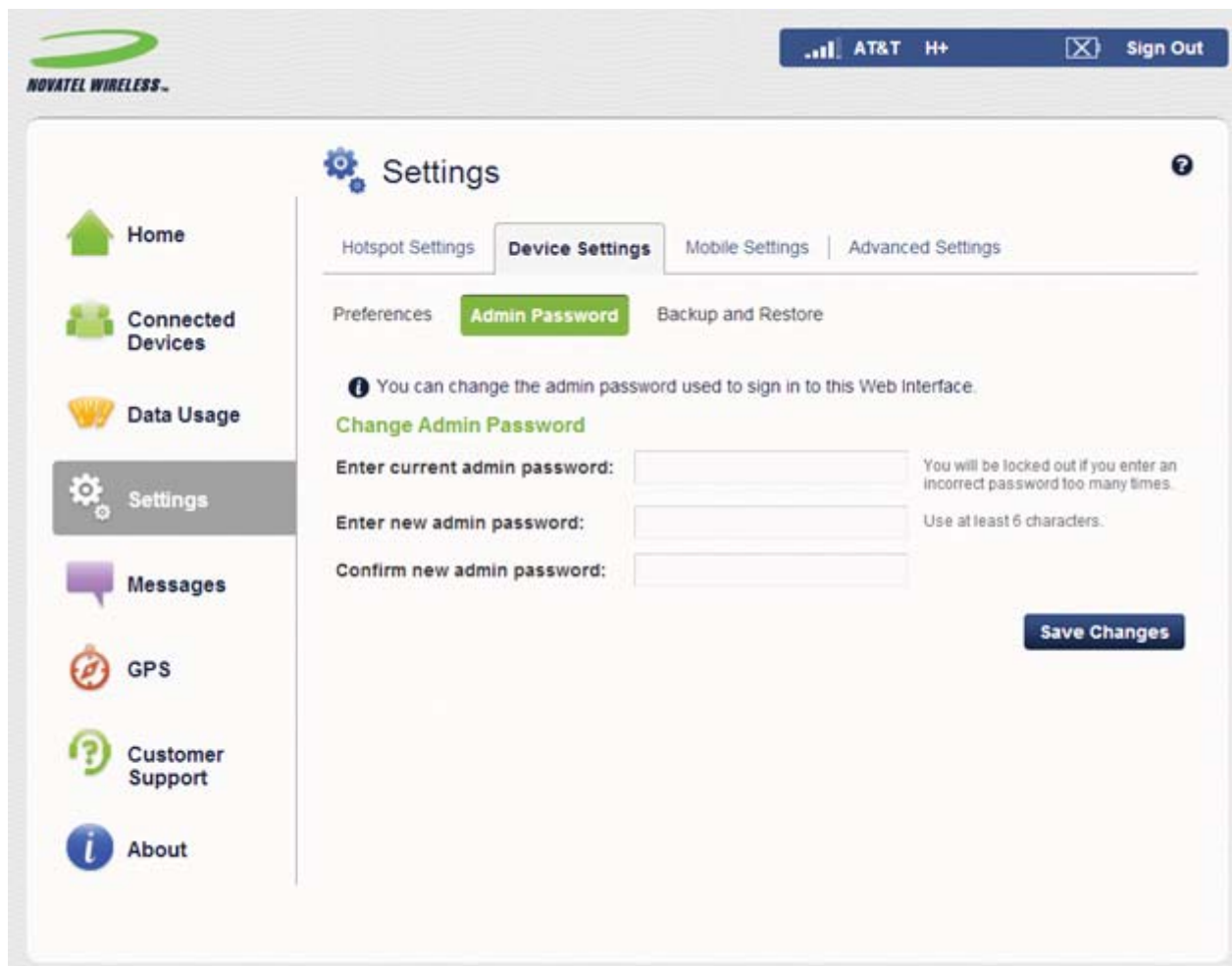

Figure 3-8 Settings Page - Device Settings - Admin Password

Change Admin Password

- **Enter current admin password:** Enter the current password in this field. Note that if you enter an incorrect value too many times, you will be locked out of this Web Interface.
- **Enter new admin password:** Enter the new password, using only letters, numbers, and standard punctuation symbols. The password must be at least 6 characters long.
- **Confirm new admin password:** Re-enter the new password in this field.

Settings Page > Device Settings > Backup And Restore

The screenshot shows the Novatel Wireless web interface. At the top, there is a status bar with signal strength, AT&T H+, and a Sign Out button. The main header includes the Novatel Wireless logo and a 'Settings' title with a gear icon and a help icon. Below the header, there are tabs for 'Hotspot Settings', 'Device Settings' (which is selected), 'Mobile Settings', and 'Advanced Settings'. Under 'Device Settings', there are sub-tabs for 'Preferences', 'Admin Password', and 'Backup and Restore' (which is highlighted in green). The 'Backup and Restore' section contains an information icon and text: 'Back up your device settings and preferences to your computer. Please note that the backup file will only work with this particular device.' Below this is a 'Backup' section with the instruction 'Save your device settings to your computer.' It features an 'Admin password:' label, an empty text input field, and a warning: 'You will be locked out if you enter an incorrect password too many times.' A 'Back Up Now' button is positioned below the input field. The 'Restore' section follows, with the instruction 'Restore settings from a previously saved backup file.' It also has an 'Admin password:' label, an empty text input field, and the same warning. Below the password field is a 'Select a file:' label, a 'No file selected' button, and a 'Choose File' button. A 'Restore Now' button is located below these elements. At the bottom of the section is a 'Restore to Factory Defaults' section with the instruction 'Restore all settings to the factory defaults.' and a 'Restore Factory Defaults' button. On the left side of the page, there is a vertical navigation menu with icons and labels for 'Home', 'Connected Devices', 'Data Usage', 'Settings' (highlighted), 'Messages', 'GPS', 'Customer Support', and 'About'.

Figure 3-9 Settings Page - Device Settings - Backup and Restore

Use this feature to back up (download) a copy of the configuration settings from this device to a file on your computer, or restore (upload) a previously-saved configuration file. This configuration file contains all settings for the device, router, and system functions. It does not contain any settings or data for the 4G modem.

Note that you can only restore a file to the same device it came from.

This screen also provides the ability to reset all settings to the factory default values.

Backup

Admin Password: Enter the current password in this field to save the device settings to your computer.

Back Up Now: Click this button to download a copy of the current configuration file to your computer. If your browser prompts you to save the file, you can rename it if desired.

Restore

Admin Password: Enter the current password in this field to restore the settings from a previously saved backup file.

Select a file: Select the configuration file you previously downloaded from this SA 2100 device to your computer.

Restore Now: After selecting a configuration file, click this button to begin the file upload. After uploading, the configuration file is immediately applied, and the device is restarted.



Uploading a configuration file changes ALL of the existing settings to match the configuration file that you are uploading. This may change the current Wi-Fi settings, disrupting all existing connections to the SA 2100, including this web browser session.

Restore To Factory Defaults

Click the **Restore Factory Defaults** button to reset all settings to their factory default values. This causes a restart, and may change the current Wi-Fi settings, breaking all existing connections to the device, including the web browser session.

Settings Page - Mobile Settings

The following five categories are available under the Mobile Settings tab:

- Mobile
- APN
- Network Selection
- Manual DNS
- SIM Lock

Settings Page > Mobile Settings > Mobile

These settings affect the connection to the mobile network.

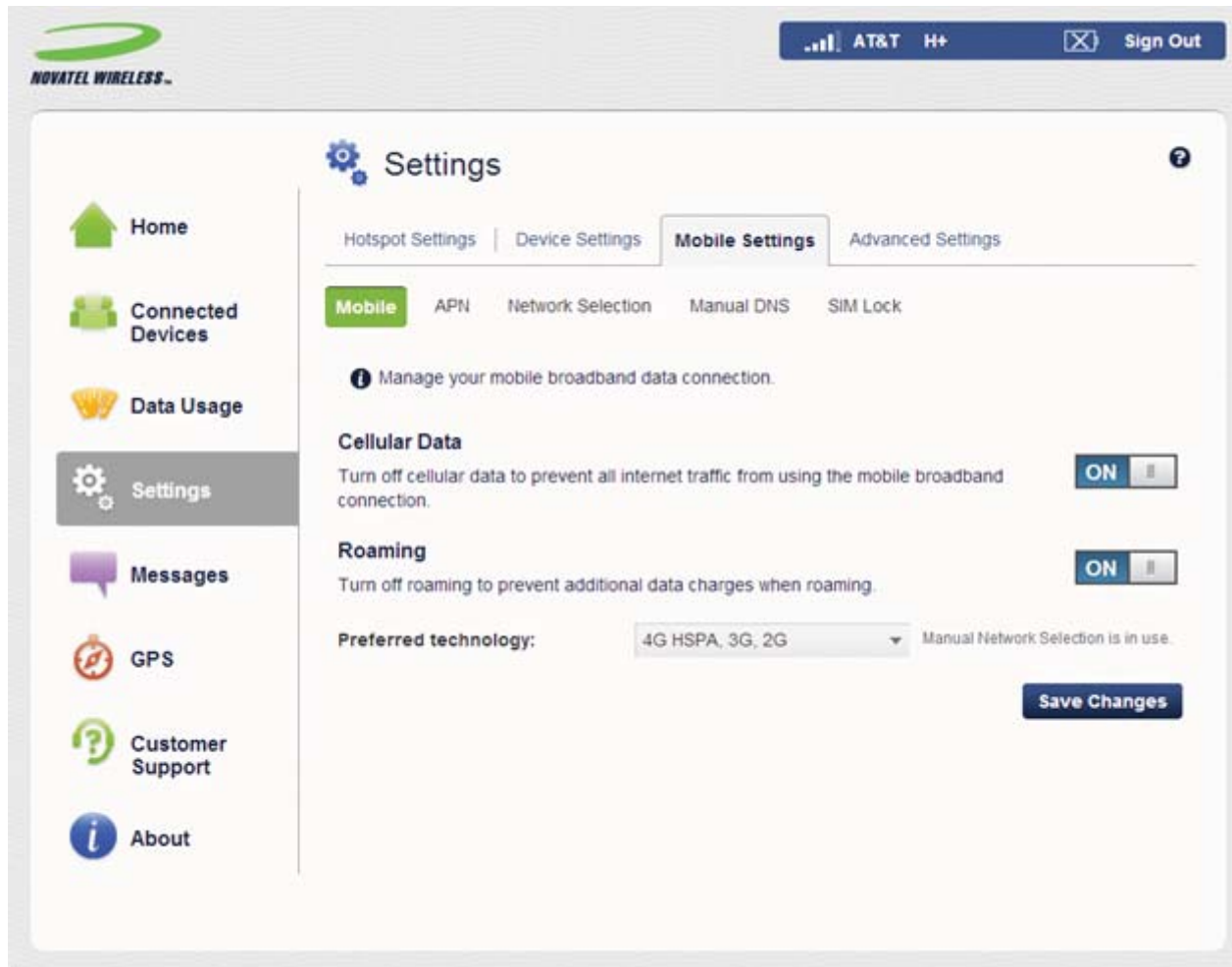

Figure 3-10 Settings Page - Mobile Settings - Mobile

Cellular Data: You can use this setting when necessary to turn off cellular data and prevent access to the mobile network. This prevents connected devices from connecting to the Internet and using your mobile data plan. For normal operation, this setting must be left on.

Roaming: You can enable this setting as necessary to access roaming networks. Additional data usage charges may apply while roaming.

Preferred Technology: The default value is "Automatic". The SA 2100 device will select the best available technology. If desired, you can change this to limit the network technologies that will be used.

Settings Page > Mobile Settings > APN

The APN settings should be configured when installing the SIM. The device will not be able to establish a WAN (cellular) internet connection until the APN settings have been configured.

Some devices ship with a preconfigured SIM installed. If a preconfigured SIM is installed, you should not change the APN unless you have a corporate account (with your own APN) or if you change the SIM.

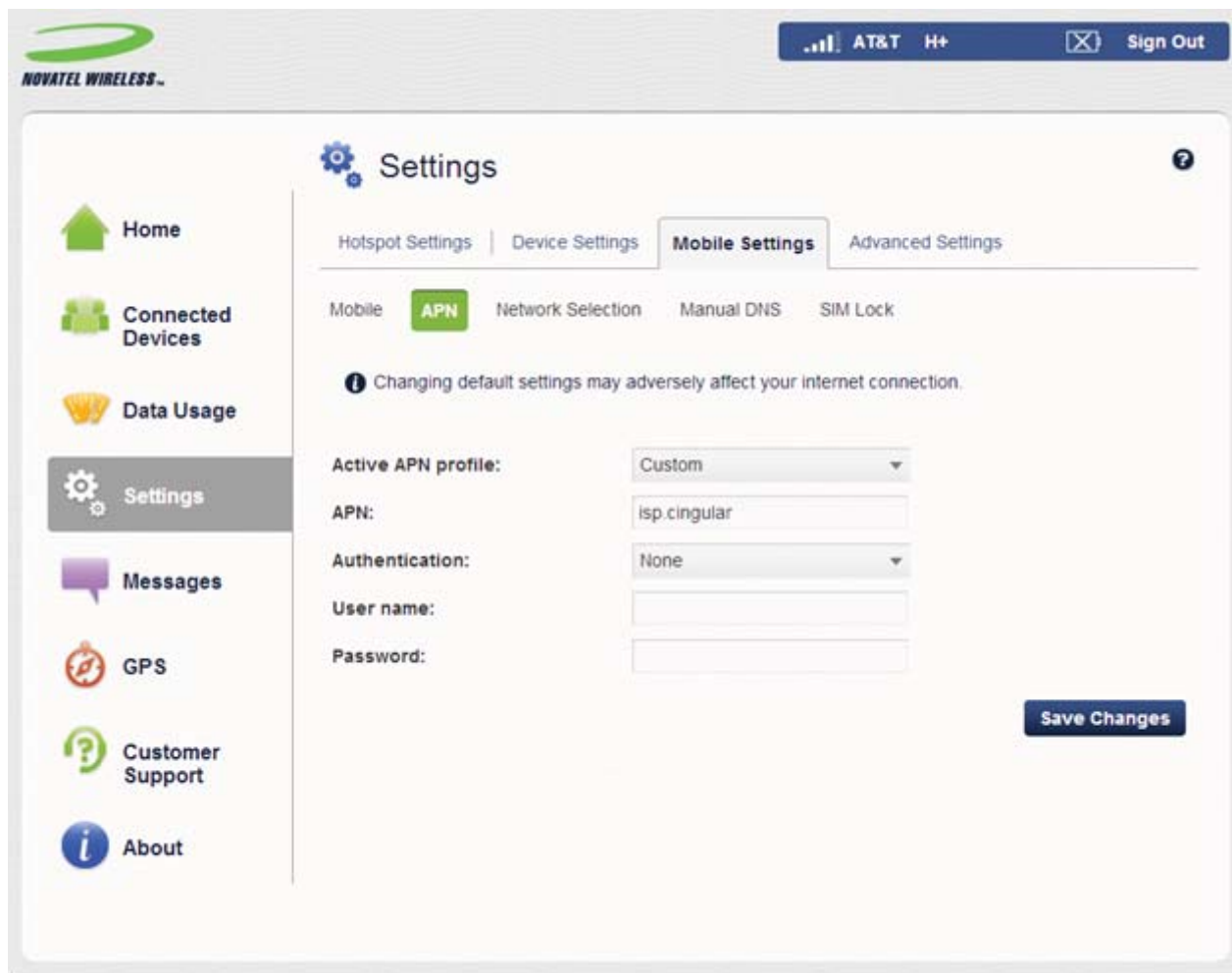

Figure 3-11 Settings Page - Mobile Settings - APN

APN Settings

Active APN Profile: Multiple APN profiles are available. The "Default" profile cannot be edited. If you need to change the APN, select another APN option, and then provide the required data below. This information is available from your network service provider.

APN: The APN associated with the selected profile.

Authentication: Select the option specified by your service provider.

- None
- PAP
- CHAP

Username: If the Authentication is None, this can be left blank. Otherwise, enter the username specified by your service provider.

Password: If the Authentication is None, this can be left blank. Otherwise, enter the password specified by your service provider.

Settings Page > Mobile Settings > Network Selection

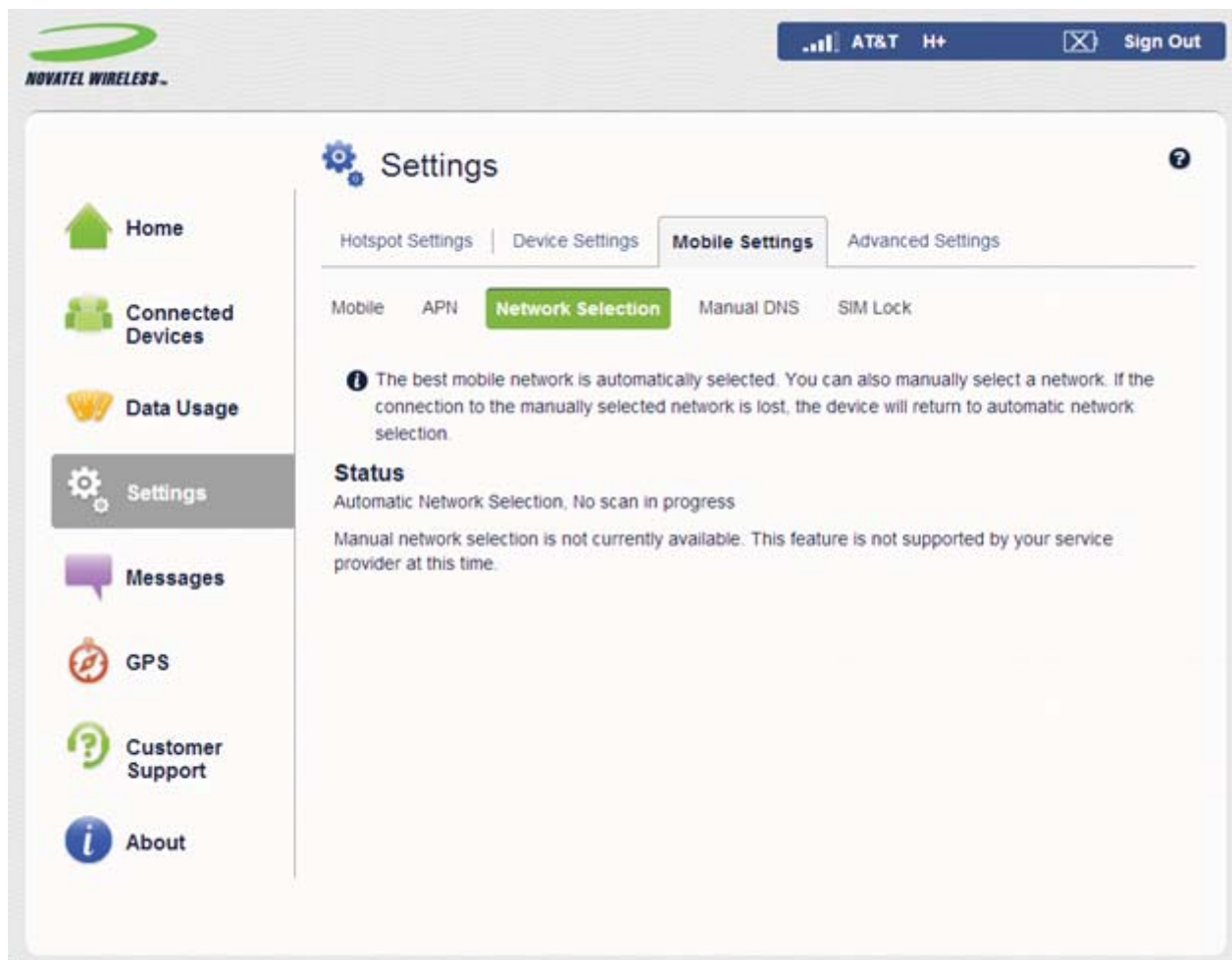

This device automatically selects the optimal mobile network. In most cases, you can also select a network manually (Manual Network Selection). This feature is only useful if multiple networks are available. If this setting is enabled, the device connects only to the specified network.

Status

This section indicates if Automatic or Manual Network Selection is in use. If Manual Network Selection is in use, the specified network is also displayed. Note that in some cases, your network service may not allow Manual Network Selection.

Operation

Scan for Networks: If Manual Network Selection is possible, this button is available. Click this button if you wish to manually select a network. The modem then scans for all available networks. This scan may take up to two minutes.



If this button is not displayed, then Manual Network Selection is not available in your current location, using your current network.

Network List All available networks are displayed in the Network List once a network scan has been completed. You can then perform one of the following operations:

- **Cancel** - Use this option to retain Automatic network selection.
- **Refresh** - Use this to scan again if the desired network is not listed. You may need to change your location to improve the signal.
- **Select a network** - Use this option to enable Manual Network Selection with the specified network.

Revert to Automatic: If Manual Network Selection is in use, this button is visible. Click this button to change from Manual to Automatic network selection.

Settings Page > Mobile Settings > Manual DNS

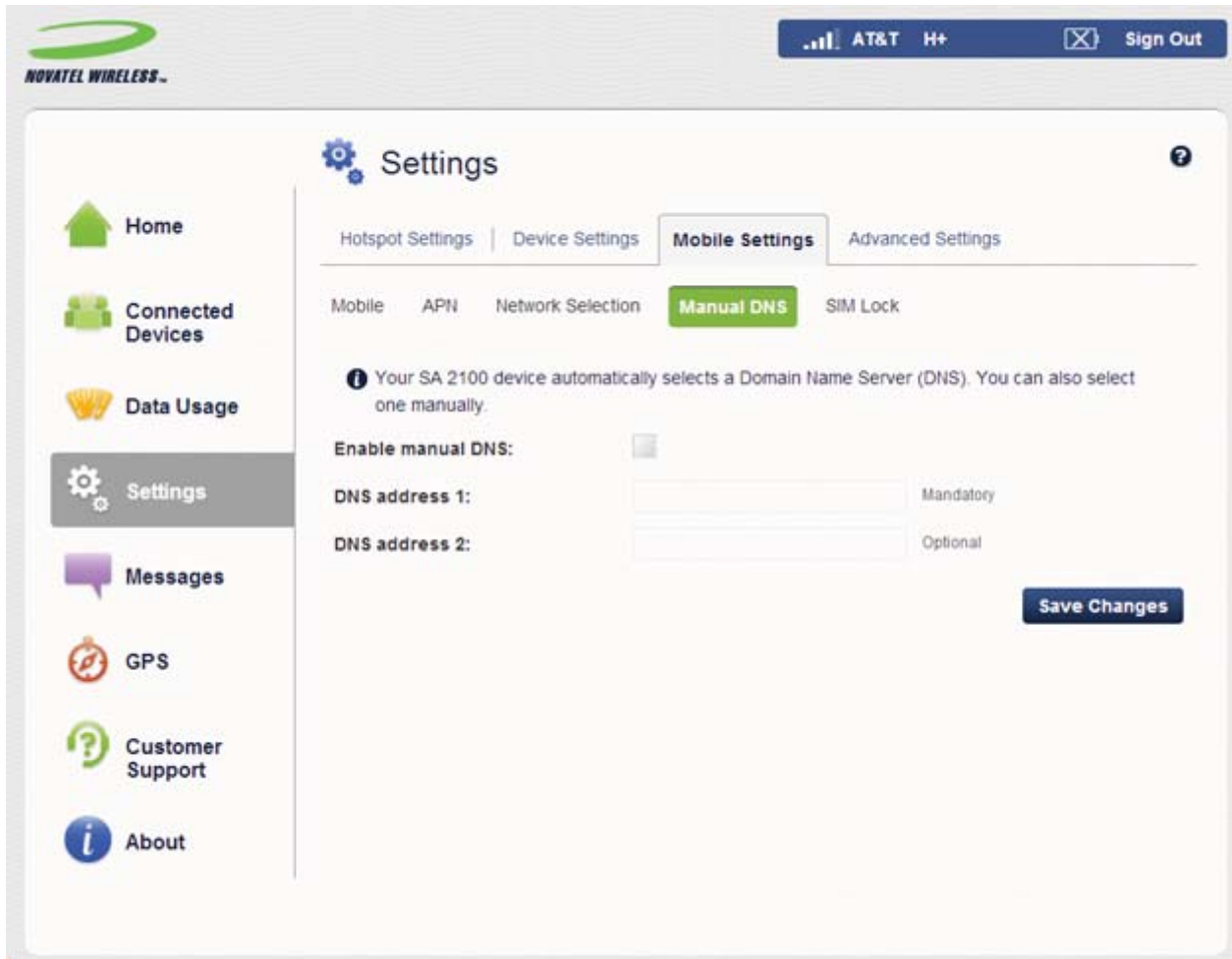

Figure 3-13 Settings Page - Mobile Settings - Manual DNS

The DNS address is usually provided automatically by the network. This page allows you to manually specify a DNS, if required.

Settings

Enable Manual DNS: Use this setting to enable or disable the Manual DNS feature. If enabled, provide the following data.

DNS 1 address: Enter the IP address of the desired primary DNS. This address is required if the Manual DNS feature is enabled.

DNS 2 address: Enter the IP address of the desired secondary (backup) DNS. This address is optional and may be left blank if desired.

Settings Page > Mobile Settings > SIM Lock

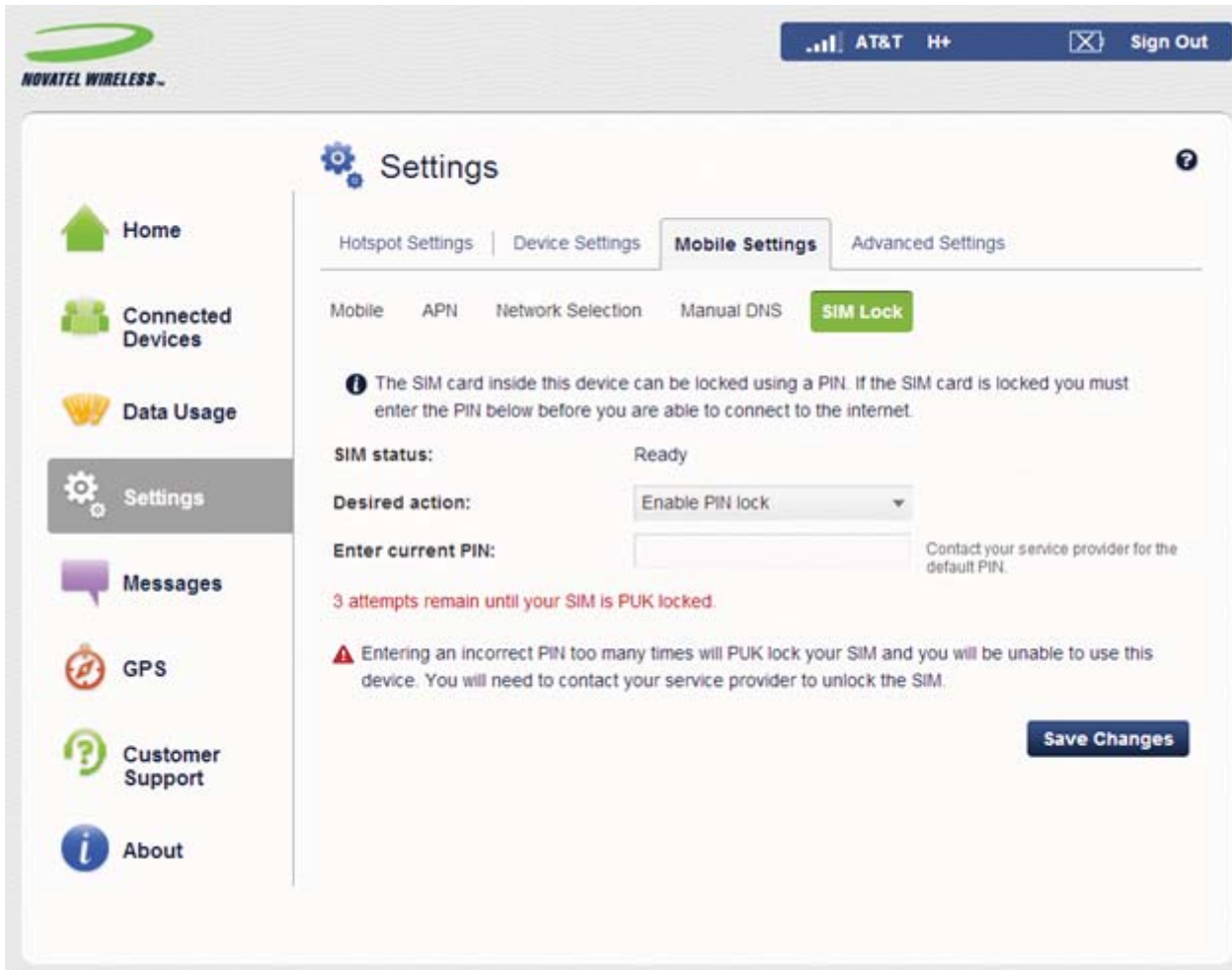

Figure 3-14 Settings Page - Mobile Settings - SIM Lock

The SIM card inside your SA 2100 device can be locked using a PIN. If the SIM card is locked, you must enter the PIN before connecting to the mobile network. Once entered, the PIN is remembered until the next shutdown.

In addition to enabling you to enter the SIM PIN when needed, this page also allows you to unlock your SIM or change the SIM PIN. Generally, you need to provide the existing PIN in order to change the SIM.

SIM status: The field indicates the current status of the SIM card. Possible values are:

- Ready - This is the normal state. The SIM PIN is not used.
- PIN Locked - The SIM PIN must be entered before you can use the mobile network.
- PUK Locked - The PUK for the SIM must be entered in order to continue. The PUK can be obtained from your service provider.
- Unlocked - The SIM PIN is needed, but has already been entered.
- No SIM - No SIM was detected. If you do have a SIM, check that it is inserted correctly.
- Invalid SIM - A SIM was detected, but it is not usable in this device.
- SIM Error - A SIM was detected, but it did not respond as expected and cannot be used.

SIM Operations

The actions available depend on the current SIM status. If multiple operations are possible, a "Desired action" select list is visible. Use this to choose the desired operation.

PIN Lock: If the SIM is currently PIN locked, you are prompted to enter the PIN. Note that if an incorrect PIN is entered too many times, the SIM becomes PUK locked. An on-page counter indicates how many incorrect entries will cause PUK lock. Once PUK locked, the PUK must then be obtained from your service provider.

PUK Lock: If the SIM is currently PUK locked, the only operation possible is to enter the PUK. Note that if an incorrect PUK is entered too many times, the SIM becomes permanently unusable. An on-page counter indicates how many entry attempts remain.

Enable PIN Lock: This sets the SIM so that entry of a PIN is required upon startup to connect to the mobile network. To perform this operation, you must enter the current PIN.

Disable PIN Lock: You can use this setting to disable a previously enabled PIN lock. It reverses the PIN lock, so that entry of a PIN is no longer required to connect to the mobile network. To perform this operation, you must enter the current PIN.

Change PIN: To change the existing PIN, select this option and then enter the required data:

1. Current PIN
2. New PIN
3. Confirm new PIN



For most SIMs, the new PIN must consist of 4 digits.

The default value is often 0000 or 1111.

Settings Page - Advanced Settings

The following five setting categories are available under the Advanced Settings tab: Firewall, MAC Filter, LAN, Port Filtering, and Port Forwarding.

Settings Page > Advanced Settings > Firewall

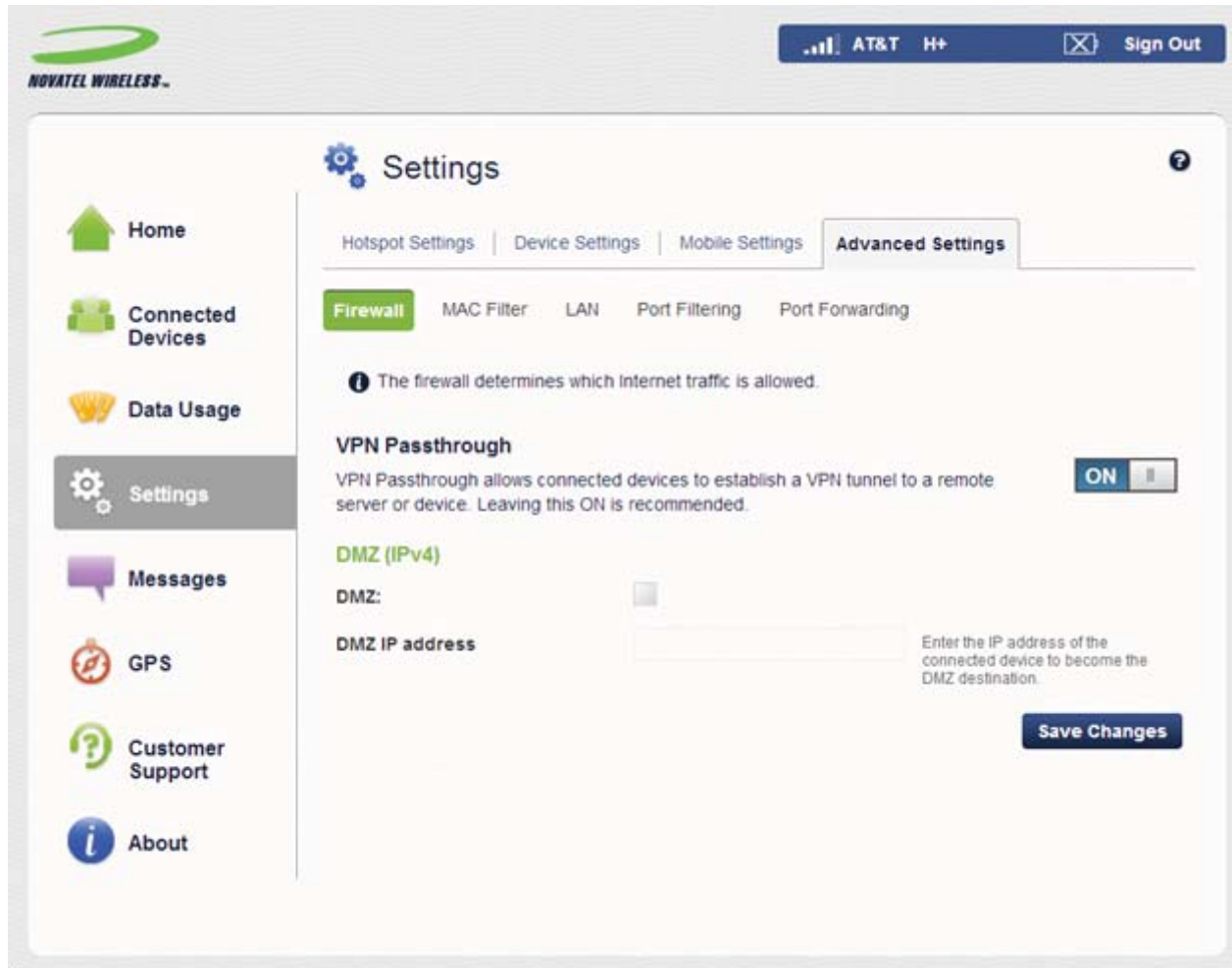

Figure 3-15 Settings Page - Advanced Settings - Firewall

A firewall protects your connected devices against malicious incoming traffic from the Internet. The firewall cannot be disabled, but the following settings are available.

Settings

VPN Passthrough This feature allows VPN client software on connected devices to connect through this device to remote VPN servers. Normally, this option should be left enabled.

IPv6 Transparent Mode If your device and service provider support IPv6, this option will be available.

Normally, the firewall will block incoming IPv6 connection requests intended for an IPv6-enabled connected device.

If you wish to allow these incoming connection requests to reach the intended connected device, enable this setting.

DMZ (IPv4)

If enabled, then the connected device specified as the DMZ IP address (DMZ destination) will receive all traffic which would otherwise be blocked by the firewall. This may assist some troublesome network applications to function properly, but the DMZ device should have its own firewall to protect itself against malicious traffic.

DMZ checkbox Use this to enable and disable this feature as needed. Generally, DMZ should be disabled unless absolutely necessary.

DMZ IP Address Enter the IP address of the connected device you wish to become the DMZ device (DMZ destination) into this field. You can check the IP address of each connected device on the connected devices screen.

Settings Page > Advanced Settings > MAC Filter

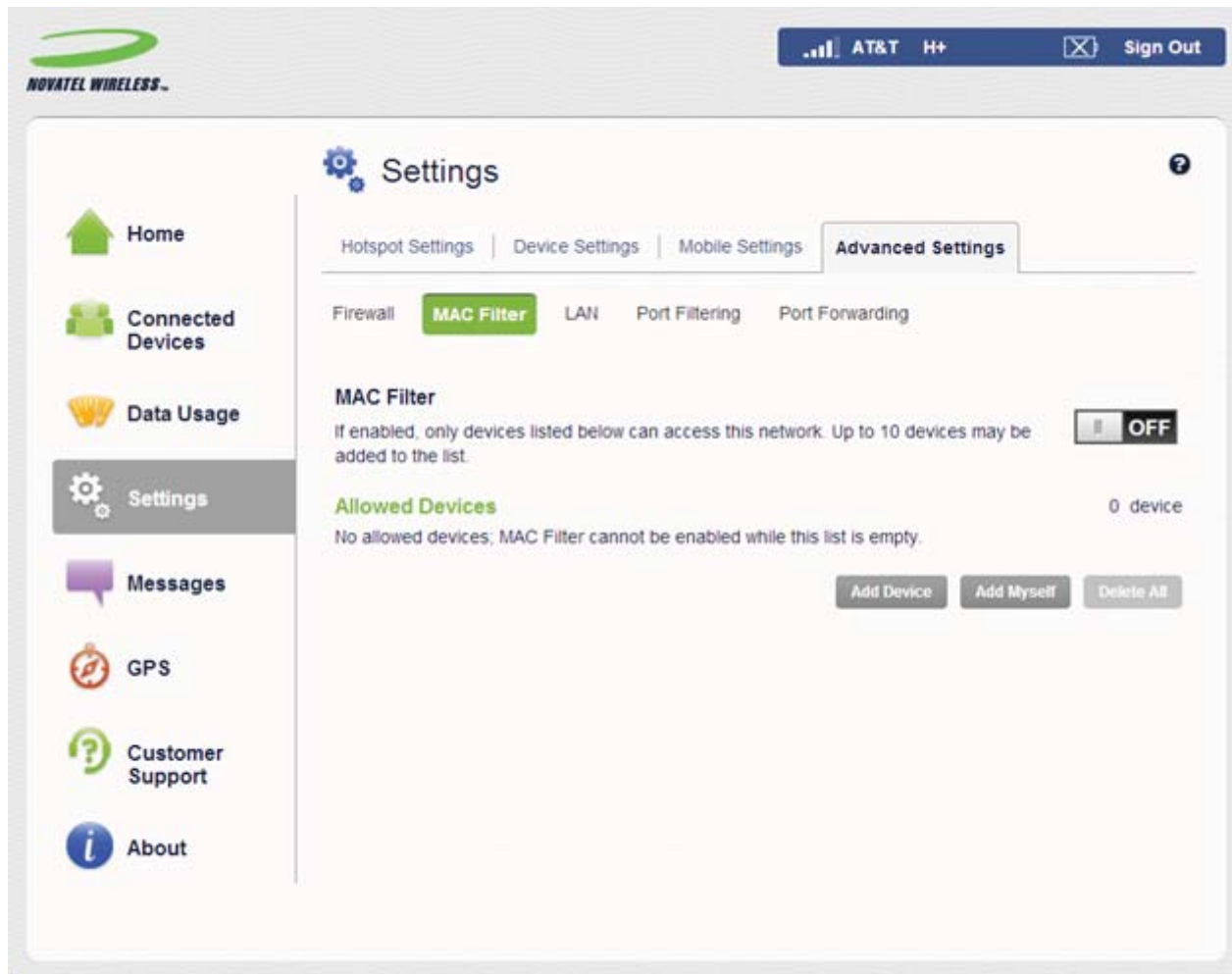

Figure 3-16 Settings Page - Advanced Settings - MAC Filter

If the MAC Filter feature is enabled it will prevent access to this network by any device which is included in the "Allowed Devices" list. The filter applies to both Wi-Fi and Ethernet connections. For a computer, Wi-Fi and Ethernet interfaces are listed separately, so one interface could be allowed while the other is not.

ON/OFF: Use this control to enable or disable the MAC Filter as needed. Before enabling it, you need to ensure the "Allowed Devices" list is not empty. Note that when enabling the MAC Filter, any Connected Device which is not in the "Allowed Devices" list will immediately be disconnected.

Allowed Devices: All allowed devices are listed here. Any device can be edited (change name or type) or be deleted from the list.

Operations

Add Device: Use this button to add a new device to the "Allowed Devices" list.

Add Myself: Click this button to add your own device (the device being used to view this screen) to the "Allowed Devices" list.

Delete All: This button can be used to delete all devices from the "Allowed Devices" list, leaving it empty. This will disconnect all current devices and prevent re-connection if the MAC Filter is enabled, this operation is only possible while the MAC Filter is OFF.

Settings Page > Advanced Settings > LAN

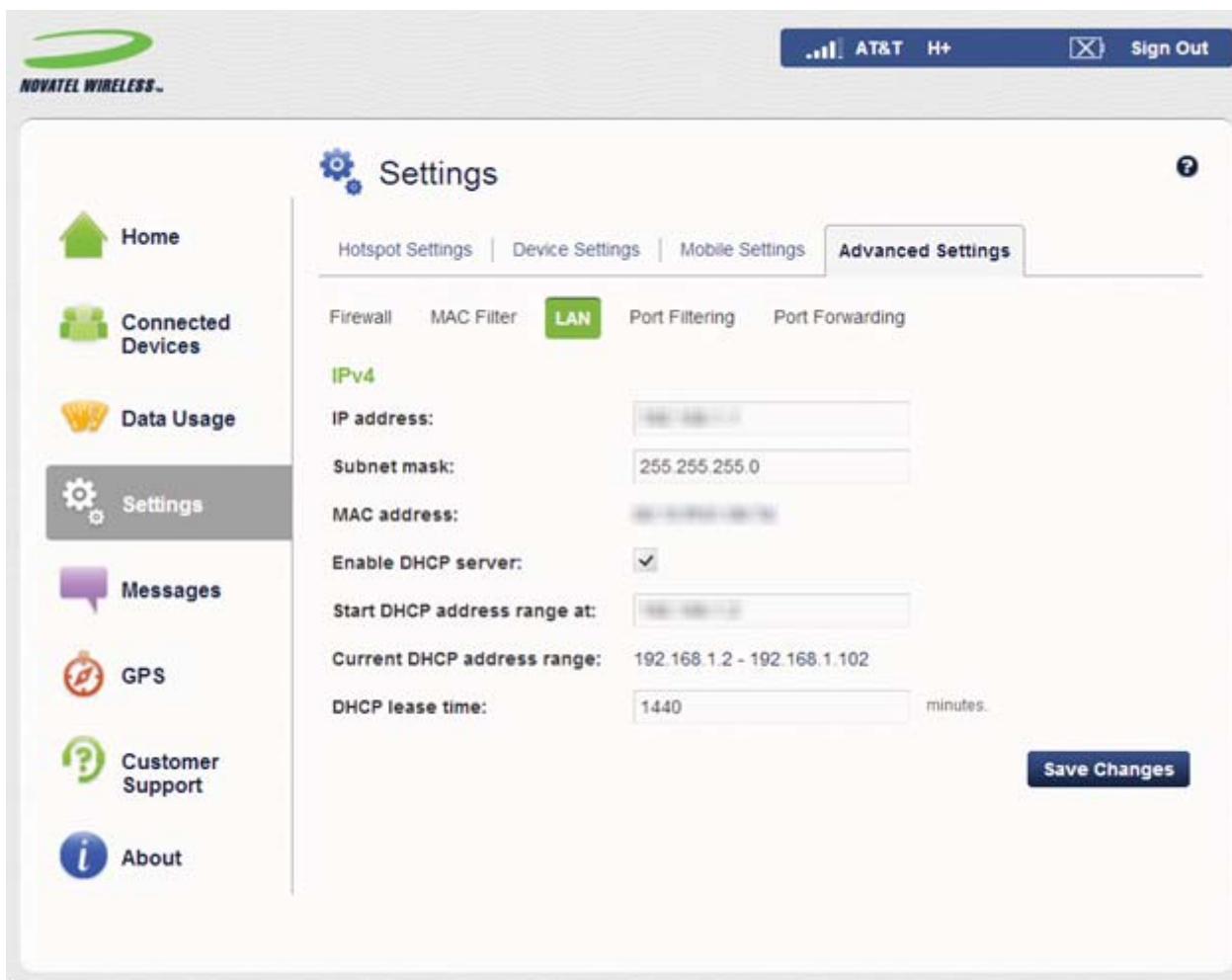

Figure 3-17 Settings Page - Advanced Settings - LAN (IPv4 shown)

These settings apply to your local network or LAN. For this device, the LAN consists of this device and all connected devices (including the USB connected device, if it exists).

IPv4

IP address: The IP address for this device, as seen from the local network. Normally, you can use the default value.

Subnet mask: The default value 255.255.255.0 is standard for small (class "C") networks. If you change the LAN IP Address, ensure you use the correct Subnet Mask.

MAC address: The MAC address is a unique network identifier, assigned when a network device is manufactured. This read-only field displays the MAC Address for the Wi-Fi and USB interfaces on this device.

Enable DHCP server: Normally, this should be left enabled. The DHCP server allocates an IP address to each connected device. If the DHCP Server was disabled, then each connected device would need to be assigned a fixed IP address.

Start DHCP address range at: If you wish to change the IP address range used by the DHCP server, you can do so by changing this value. This option is for expert users only.

DHCP address range: This indicates the range of IP addresses which may be allocated to connected devices. If using a fixed IP address on a connected device, you should use an IP address that is outside this range.

DHCP lease time: This field determines how often connected devices must renew the IP address assigned to them by the DHCP server. Normally, this can be left at the default value, but if you have special requirements you can change this value.

IPv6

If your device and your service provider support IPv6, this section will be visible.

Enable IPv6: If some of your connected devices support IPv6, this setting should be enabled. IPv6-enabled connected devices will then be able to make IPv6 connections to the Internet.

Link-Local address: This is the IPv6 address of this device. The Link-Local address is used for IPv6 communication between devices on the same network.

Settings Page > Advanced Settings > Port Filtering

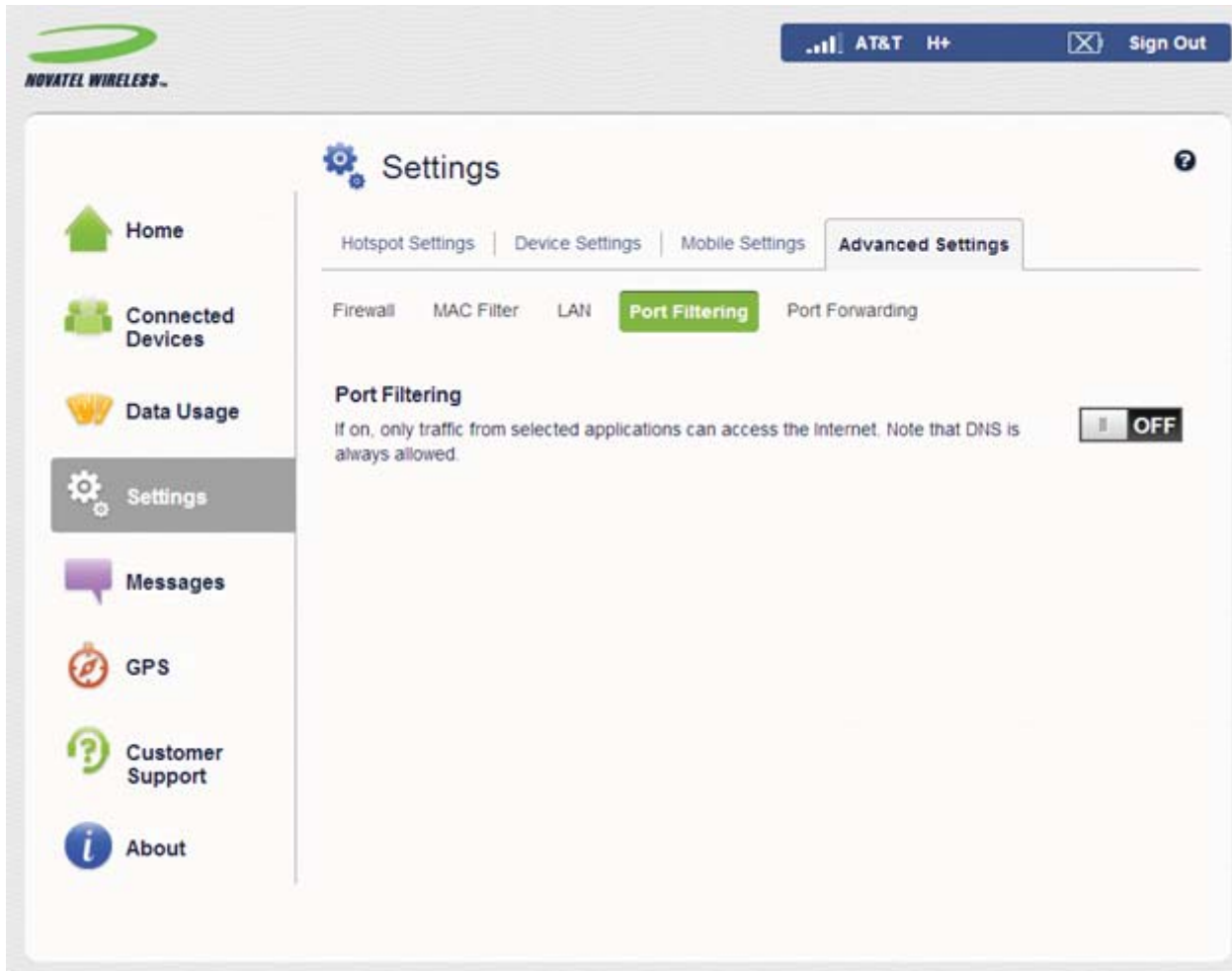

Figure 3-18 Settings Page - Advanced Settings - Port Filtering

Use the Port Filtering feature as needed to block outgoing Internet traffic. If this setting is enabled, only traffic from the selected applications can access the Internet. Traffic is identified by port numbers. Some applications are pre-defined. You can define additional applications, but you need to know details of the traffic used and generated by the applications you wish to define.

Applications

Enable/Disable Checkbox: Use these check boxes to enable access to the Internet for each application. While the Port Filtering feature is enabled, traffic from selected applications can access the Internet. Otherwise, the traffic is blocked.

Settings Page > Advanced Settings > Port Forwarding

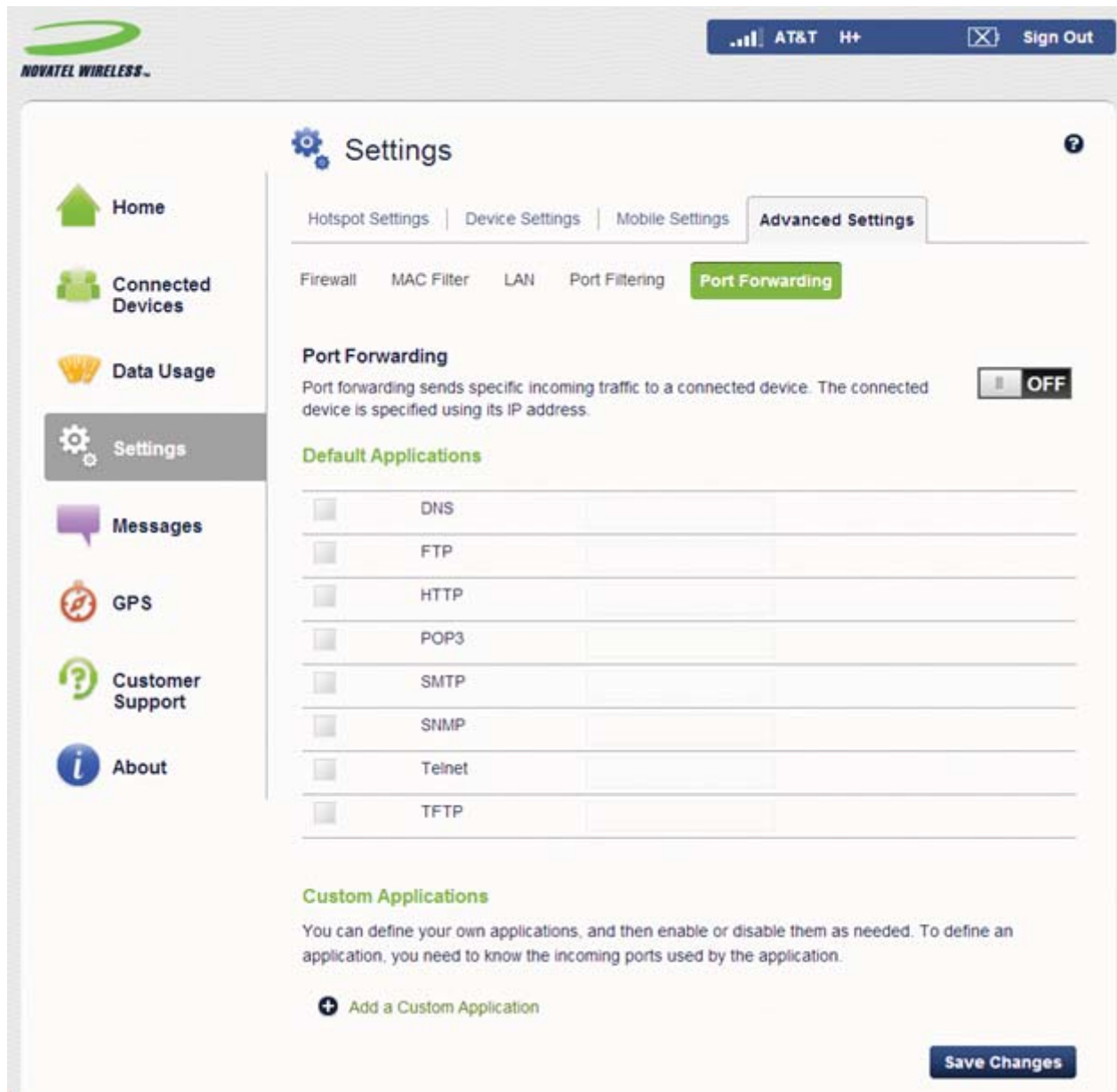

Figure 3-19 Settings Page - Advanced Settings - Port Forwarding

The Port Forwarding feature allows incoming traffic from the Internet to be forwarded to a particular computer or device on your Wi-Fi network. Normally, the built-in firewall blocks incoming traffic from the Internet. Use Port Forwarding to allow Internet users to access any server you are running on your computer, such as a Web, FTP, or E-mail server. For some online games, Port Forwarding must be used in order for the games to function correctly.



Note that use of Port Forwarding creates a security risk and should be disabled when not required.



Some Mobile Wireless Networks provide you with an IP address on their own network rather than an Internet IP address. In this case, Port Forwarding cannot be used because Internet users cannot reach your IP address.

Port Forwarding Applications

Enable/Disable Checkbox: A number of common server applications are listed. To use any of these applications, follow this procedure:

1. Install the application on a computer which is connected to this device's Wi-Fi network.
2. On the computer, check its IP address for the Wi-Fi network. Alternatively, you can check the computer's IP address on the Connected Devices screen.
3. On this screen, enter the computer's IP Address in the Connected Device IP Address field beside the application.
4. Enable this application on this screen by selecting its checkbox.
5. Save your changes.
6. On the Current Status screen, make a note of the Internet IP address of this device.
7. Ask users on the Internet to connect to the Internet IP address of this device. These connection requests will be forwarded to the IP address specified in step 3.

Custom Applications

This feature allows you to define your own applications. Once defined, these applications can be enabled and disabled in the same way as pre-defined applications. To define an application, you need to know the ports and protocol (TCP, UDP) used by the application for incoming traffic. To start, click the **Add Custom Application** button, then provide the following data.



Note that any changes to a Custom Application are not saved until the "Save Changes" button is clicked to save the entire page contents.

Enable/Disable Checkbox: Use this to enable an application after you have defined it.

Application Name: Enter a suitable name for the application you are defining.

Port Range: Each application has its own port range. Enter the beginning and end of the port range for each application.

- For a single port, enter the port number in both the Begin Port and End Port fields.
- For a port range, enter the beginning of the range in the Begin Port field and the end of the range in the End Port field.

Protocol: For each port range, select the protocol (TCP or UDP) used by that port range.

Connected Device IP Address: Enter the IP address of the connected device which will receive this traffic.

Delete: Use this checkbox to delete a custom application.

Messages

These SMS messages are normally from your service provider. You should not attempt to reply, and therefore no reply feature is provided.

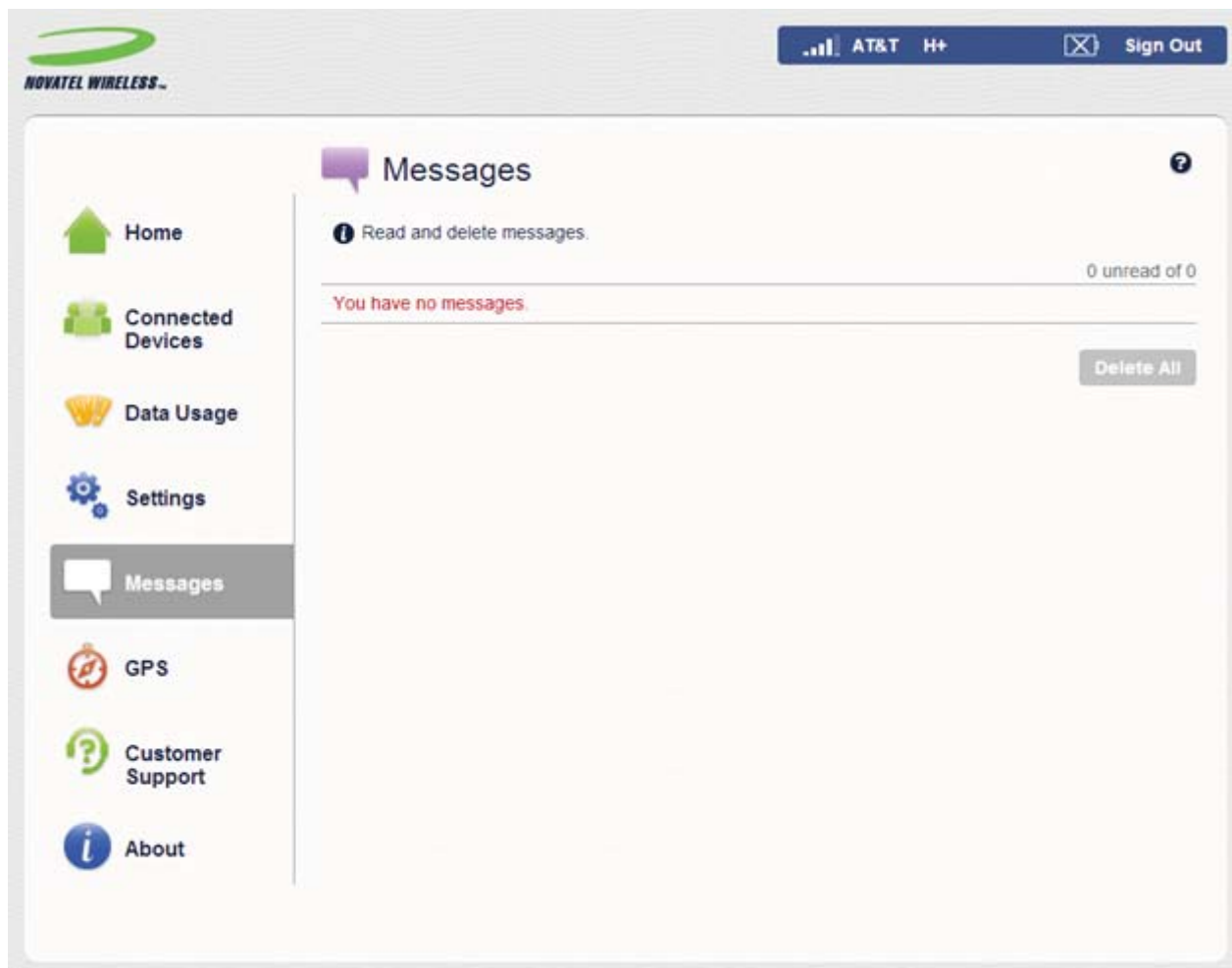

Figure 3-20 Messages Page

Message Counters

Two counters at the top of the screen indicate the total number of messages, and the number of unread (new) messages.

Note that all messages are set to "read" once they are displayed on this screen.

Message List

All messages are listed in order of the date received. Unread (new) messages are indicated by an icon. Messages are automatically marked as "read" once they are displayed on this page, so the next time the page is accessed, they will no longer be shown as unread.

Delete Button

Each message has an individual "Delete" icon. Click to delete individual messages.

Delete All Messages

This button is at the end of the message list. Use it as needed to delete all messages.

GPS

This device incorporates a GPS receiver. The GPS receiver can determine your current location and share this location information with connected devices.

GPS

The GPS receiver can determine your current location. This location can be provided to connected devices by using the GPS over Wi-Fi feature below.

GPS
Turn On to activate the SA 2100's location services. By enabling GPS you are accepting the terms and conditions of the GPS Policy. **ON**

Current Location:

Latitude: 32.9965 Altitude: 691 ft
Longitude: -96.7142 Accuracy: 62 ft

GPS over Wi-Fi (NMEA)

Enable GPS over Wi-Fi: Installing GPS over Wi-Fi drivers on each computer is required.

Port number: Normally, the default value should be used

[Download GPS over Wi-Fi Drivers](#) [Save Changes](#)

Figure 3-21 GPS Page (Shown with GPS Turned ON)

Using GPS

Enable GPS

Use this ON/OFF control to enable or disable the GPS feature.

GPS Status

If the GPS receiver has not yet obtained a fix (location), a Searching status appears. Once a fix has been obtained, the following Current Location information is displayed, and a Google map appears to visually indicate the current location.

Current Location

Latitude

The latitude for the last location fix.

Longitude

The longitude for the last location fix.

Altitude

The altitude for the last location fix.

Accuracy

This is a measure of the accuracy of the horizontal position obtained by the GPS receiver.

GPS Over Wi-Fi (NMEA)

Enable GPS over Wi-Fi

NMEA is a standard method of providing a GPS data stream in Windows and other computing platforms. If this check box is selected, when connected via a USB cable, a NMEA (serial) port is available to applications that can use a NMEA stream. To use this feature, drivers must be installed on your computer. Use the [Download](#) link at the bottom of the page to download and install these drivers.

Port Number

This is the port number used by the driver software on your computer to establish a connection to this device and obtain the GPS data. Unless there is a good reason to do so, you should not change the port number.

Download GPS over Wi-Fi Drivers

Use this to access the download page for the available drivers. These drivers are needed to use the GPS over the Wi-Fi feature.

Customer Support

The Customer Support Details of your SA 2100 are found on the Customer Support page in the user interface.

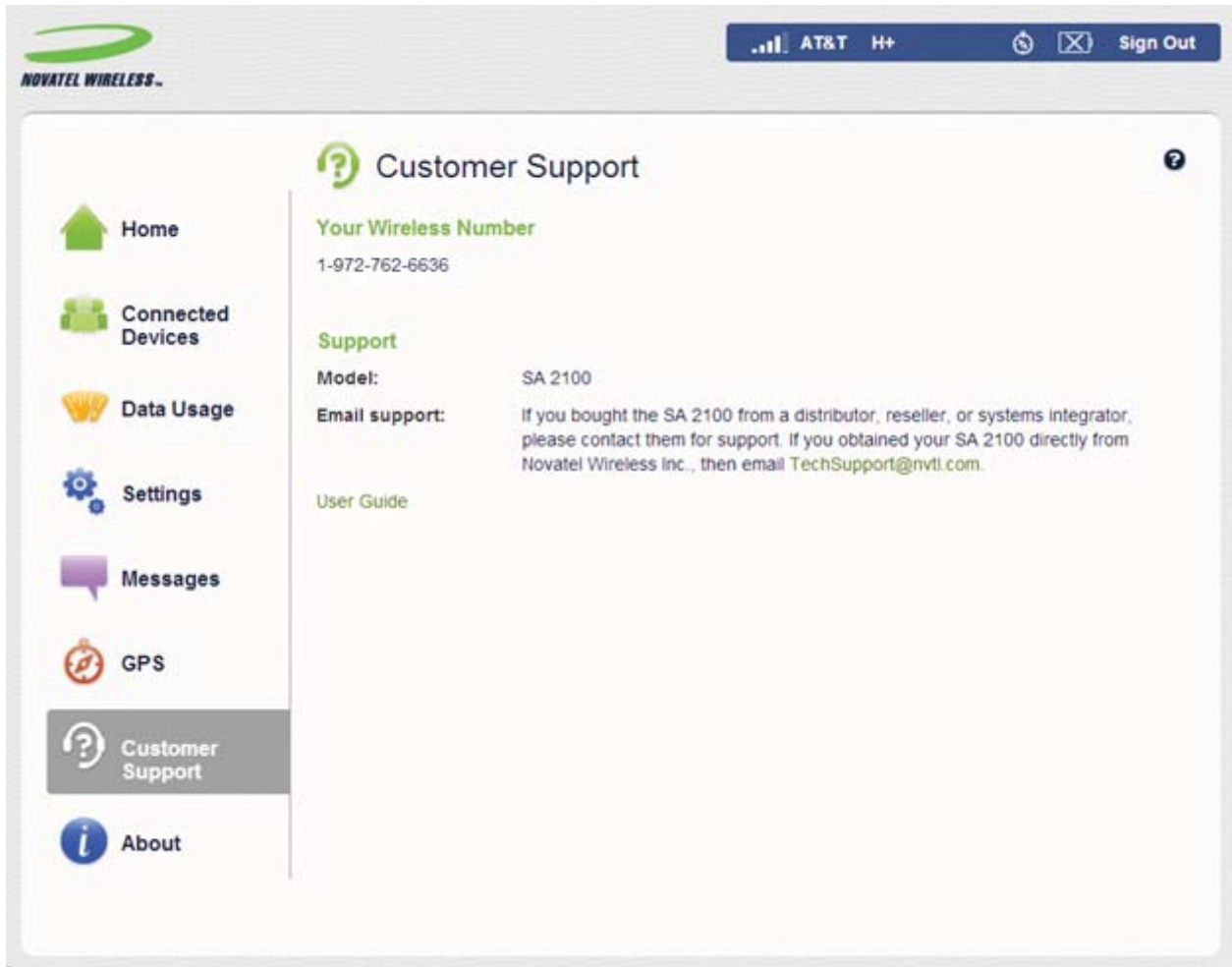

Figure 3-22 Customer Support Page

Your Wireless Number

This is the phone number for this device. The support staff may ask for this number.

Support

Use this information to access the user guide, to obtain additional information, or support.

About

The About page contains information about your SA 2100 router. The information is presented on 5 tabs: Current Status, Device Info, Diagnostics, Logs, and Software Update.

About Page - Current Status Tab

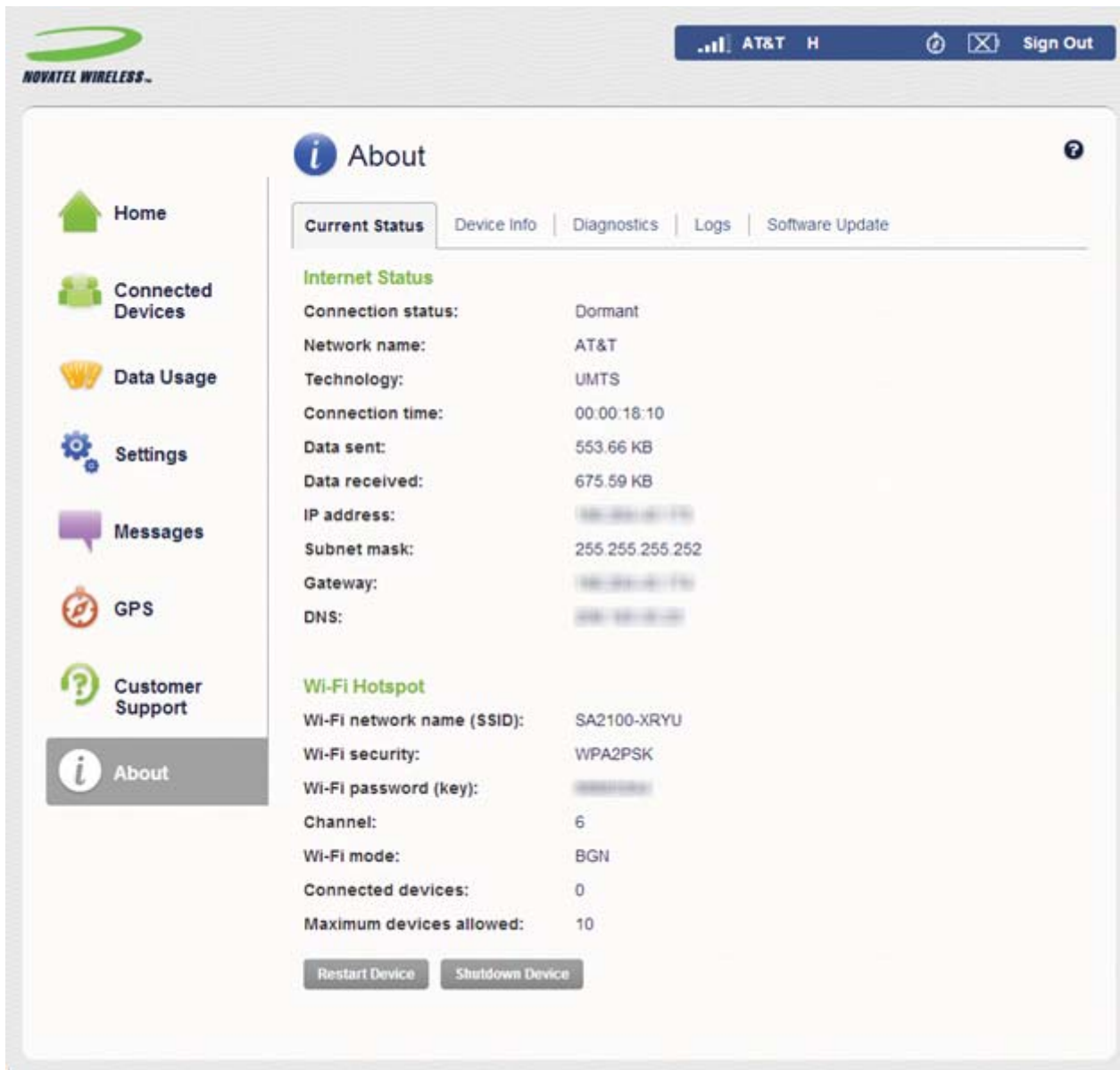

Figure 3-23 About Page - Current Status Tab

The Current Status Tab displays status information for the device.

Internet Status

Connection Status: This displays the connection status for the Internet connection and indicates if an error condition exists.

Network Name: The name of the network to which this device is currently connected.

Technology: The network technology used for the current connection. LTE is the fastest available technology.

Connection Time: The period of time that has elapsed since the connection was established for the current Internet session.

Data Sent: The amount of data transmitted for the current Internet session. This counter starts from zero when the connection is established.

Data Received: The amount of data received for the current Internet session. This counter starts from zero when the connection is established.

IP Address: The Internet IP address assigned to this device.

Subnet Mask: The network mask associated with the IP address above.

Gateway: The gateway IP address associated with the IP address above.

DNS: The Domain Name Server currently used by this device.

Wi-Fi Hotspot

Wi-Fi Network Name (SSID): The name of the Wi-Fi network.

Wi-Fi Security: The current setting for Wi-Fi security.

Wi-Fi Password (Key): The current password value.

Channel: The Wi-Fi channel currently in use. If the channel setting is Automatic, this displays the automatically selected channel.

Wi-Fi Mode: The 802.11 mode in use.

Connected Devices: The number of currently connected devices. For details, use the Connected Devices menu option.

Maximum Devices Allowed: This is the maximum number of devices that can connect to this SA 2100 device at any time.

Operations

Restart: Click this button to restart the device. All Internet connections and Wi-Fi connections will be lost during the restart.

Shutdown: Click this button to shut down the device. All existing connections will be lost.

About Page - Device Info Tab

The Device Information tab contains information about the SA 2100 router.

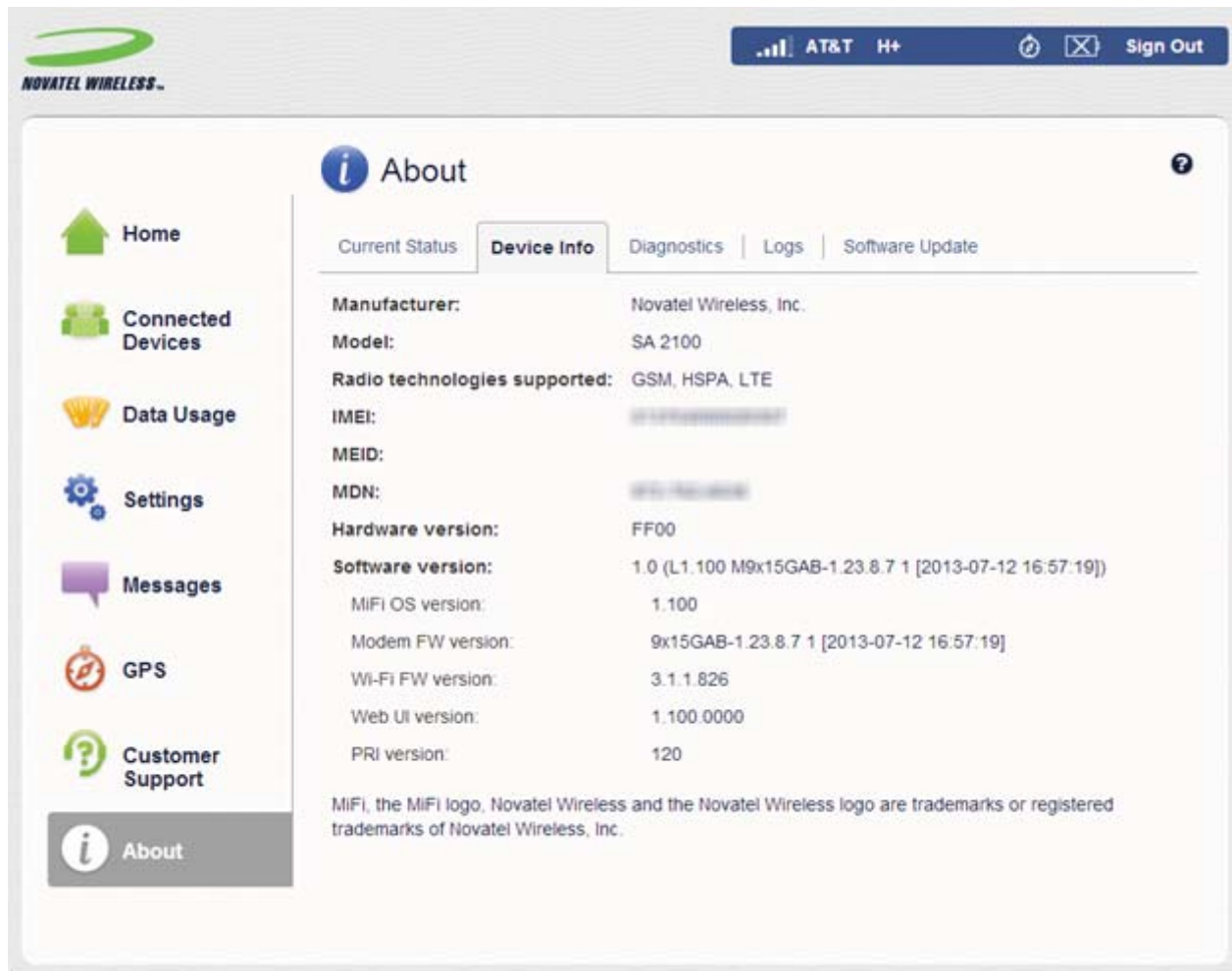

Figure 3-24 About Page - Device Info Tab

Manufacturer: The manufacturer of this device.

Model: The official model name and number for this device.

Radio technologies supported: This lists the different radio technologies supported by this device. Note that this list refers to this device, and not to the mobile network.

IMEI: The IMEI (International Mobile Equipment Identity) for this device. The IMEI is a 15 or 17 digit code used to uniquely identify an individual mobile station on a LTE network. The IMEI does not change when the SIM is changed.

MDN: This is the phone number assigned to this device. It will change when the SIM is changed.

Software Version: The version of currently installed software. This is the main version number; the following version information relates to various software components.

OS version: This is the version number for the OS (Operating System) and its components.

Modem FW version: For the 4G Modem component, this is the version of the firmware (software) currently installed.

Wi-Fi FW version: For the Wi-Fi component, this is the version of the firmware (software) currently installed.

Web UI version: The version number for the SA 2100 Web Interface.

PRI version: The configuration version currently applied to this device.

About Page - Diagnostics Tab

This page contains information about the SA 2100 and the available networks. Use it as needed for troubleshooting; it is not required for normal operation.

The screenshot displays the 'About' page on a Novatel Wireless device, specifically the 'Diagnostics' tab. The top status bar shows 'AT&T H+' and a 'Sign Out' button. The page title is 'About' with an information icon. Below the title are tabs for 'Current Status', 'Device info', 'Diagnostics', 'Logs', and 'Software Update'. A note states: 'This detailed information is used only for troubleshooting and technical support.' The page is divided into three sections: 'Modem', 'HSPA Status', and '4G LTE Status'. The 'Modem' section lists various identifiers and versions. The 'HSPA Status' section shows the device is available on the AT&T network. The '4G LTE Status' section shows it is not available.

| Section | Property | Value |
|---------------|------------------------|--|
| Modem | Phone number (MDN): | 1-972-... |
| | IMEI: | ... |
| | IMEISV: | ... |
| | MEID: | ... |
| | IMSI: | ... |
| | Modem FW version: | 9x15GAB-1.23.8.7.1 [2013-07-12 16:57:19] |
| | SIM status: | Ready |
| HSPA Status | Status: | Available |
| | Network operator: | AT&T |
| | Technology: | HSPA PLUS |
| | Network ID: | 310410 |
| | Cell ID: | 20001 |
| | RSSI: | -85 dbM |
| | Roaming: | None |
| 4G LTE Status | Status: | Not available |
| | Network operator: | |
| | Signal strength(RSRP): | |
| | SNR(RSRQ): | |

Figure 3-25 About Page - Diagnostics Tab

Modem

Phone number (MDN): Although this device does not support voice calls, it has a normal phone number, which is displayed here.

IMEI: The IMEI (International Mobile Equipment Identity) for this device is a 15 or 17 digit code used to uniquely identify an individual mobile station on a LTE network. The IMEI does not change when the SIM is changed.

IMEISV: This field combines the IMEI with an approval number for this type of device.

IMSI: The IMSI (International Mobile Subscriber Identity) is a unique identification associated with all GSM, UMTS, and LTE mobile subscribers. It is stored in the SIM, and only changes if the SIM is changed.

Modem FW Version: The version of the firmware (software) currently installed in the 4G modem.

SIM Status: This indicates the status of the SIM card. If the SIM card is missing, or this field indicates some form of SIM error, connection to the mobile network is not possible.

ICCID: This unique ID number is assigned to the SIM card. It does not display if there is no SIM card, or if a SIM error condition exists.

HSPA Status - SA 2100

Status: HSPA/GSM refers to 4G HSPA and all preceding technologies. For the HSPA network, the following states are supported:

- Disabled - access to GSM/WCDMA/HSPA networks is disabled.
- Not available - no GSM/WCDMA/HSPA network has been detected.
- Available - a GSM/WCDMA/HSPA network has been detected.

The following data items are only provided if the HSPA network is available.

Network operator: This is the name of the HSPA network.

Technology: The current technology in use for the GSM/WCDMA/HSPA network. Possible values, from slowest to faster, are:

- GPRS
- EDGE
- UMTS
- HSDPA
- HSUPA
- HSPA+
- HSPA+ DC

Network ID: The name and/or ID of the GSM/WCDMA/HSPA network.

Cell ID: This value identifies the cell tower currently in use.

RSSI: This indicates the RSSI for the GSM/WCDMA/HSPA signal. RSSI is a measure of signal strength in decibels, relative to one milliwatt. It is always negative because mobile radio devices are much less powerful than one milliwatt. Higher values indicate a stronger signal, so -50dBm is a stronger signal than -70dBm.

Roaming: This indicates if the current connection is a roaming connection.

CDMA Status - SA 2100-V

Status: CDMA refers to CDMA 2000 and all preceding technologies.

- Disabled - access to CDMA networks is disabled.
- Not available - no CDMA network has been detected.
- Available - a CDMA network has been detected.

The following data items are only provided if the CDMA network is available.

Network operator: This is the name of the CDMA network.

Technology: The current technology in use for the CDMA network.

Network ID: The name and/or ID of the CDMA network.

Cell ID: This value identifies the cell tower currently in use.

RSSI: This indicates the RSSI for the CDMA signal. RSSI is a measure of signal strength in decibels, relative to one milliwatt. It is always negative because mobile radio devices are much less powerful than one milliwatt. Higher values indicate a stronger signal, so -50dBm is a stronger signal than -70dBm.

Roaming: This indicates if the current connection is a roaming connection.

4G LTE Status

Network operator: This is the name of the LTE network.

Status: For the LTE network, the possible status values are:

- Disabled - access to LTE networks is disabled.
- Not available - no LTE network has been detected.
- Available - LTE is enabled, and a LTE network has been detected.

The following data items are only provided if the 4G LTE network is available.

Signal strength: This indicates the strength of the LTE signal, measured in dBm. Higher values indicate a stronger signal, so -80 dBm is a stronger signal than -90 dBm. Note that LTE signal strength is typically lower than 3G signal strength.

SNR: SNR is a measure of signal quality. Higher numbers indicate a better signal.

Roaming: This indicates if the current connection is a roaming connection.

About Page - Logs Tab

The Log information is useful for troubleshooting, but is not required for normal operation.

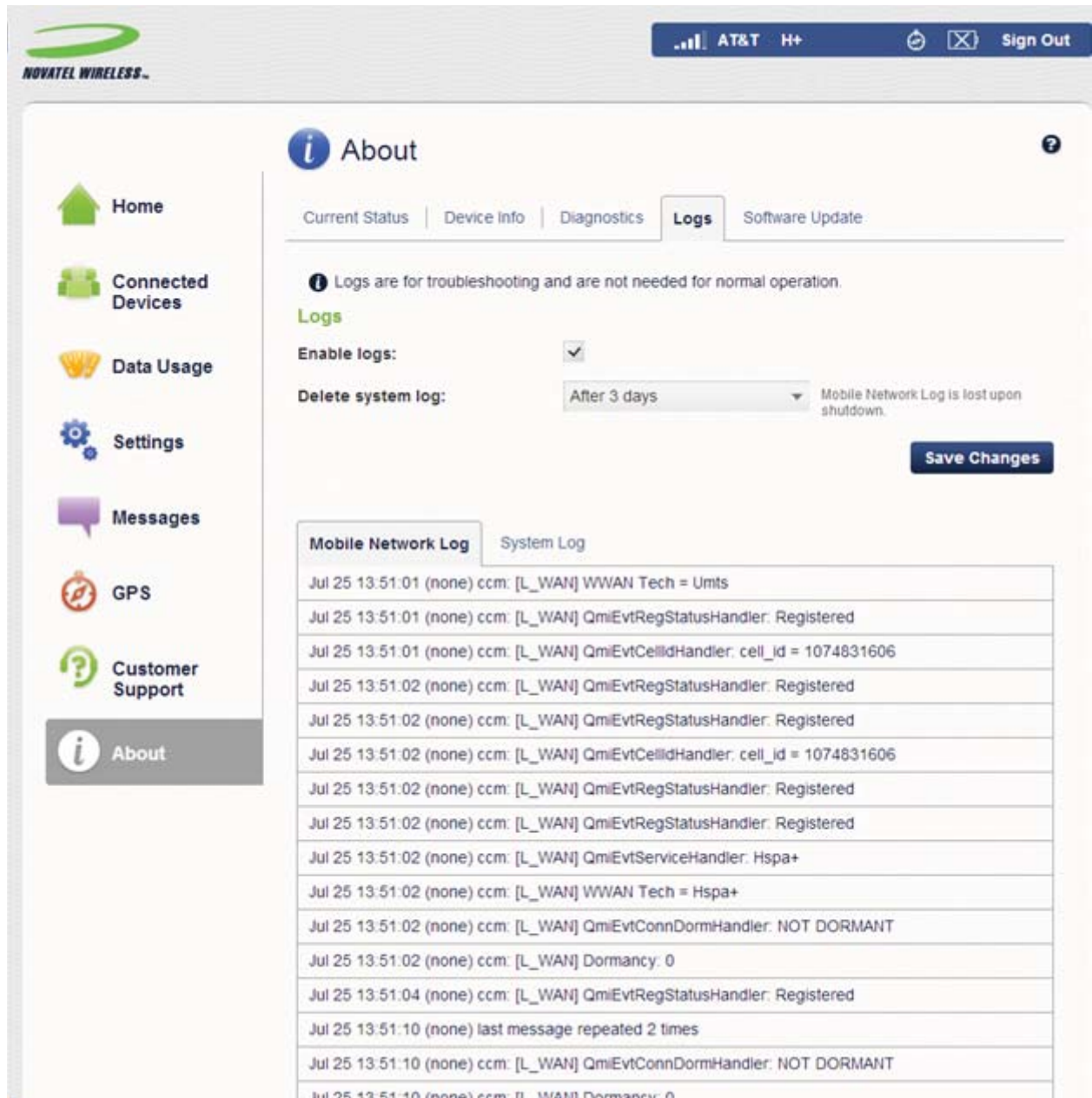

Figure 3-26 About Page - Logs Tab

Settings

Enable logs: Enable the Logs as needed.

Delete System Log: This setting determines for how long the system log data is retained. Select the desired option.

Note that if the log is full, the oldest data is deleted, regardless of this setting.

Log Data

The provided tabs allow you to select the type of Log Data to view.

Mobile Network Log: This log contains data regarding connections to the mobile network.

System Log: This log records events (other than mobile data connections) which occurred on this device.

Buttons

Refresh: Click to update the log data that is displayed.

Clear Logs: Clicking this button will delete all existing log data. This makes new data easier to read.

About Page - Software Update Tab

Software updates are delivered automatically over the mobile network. This page allows you to monitor these updates.

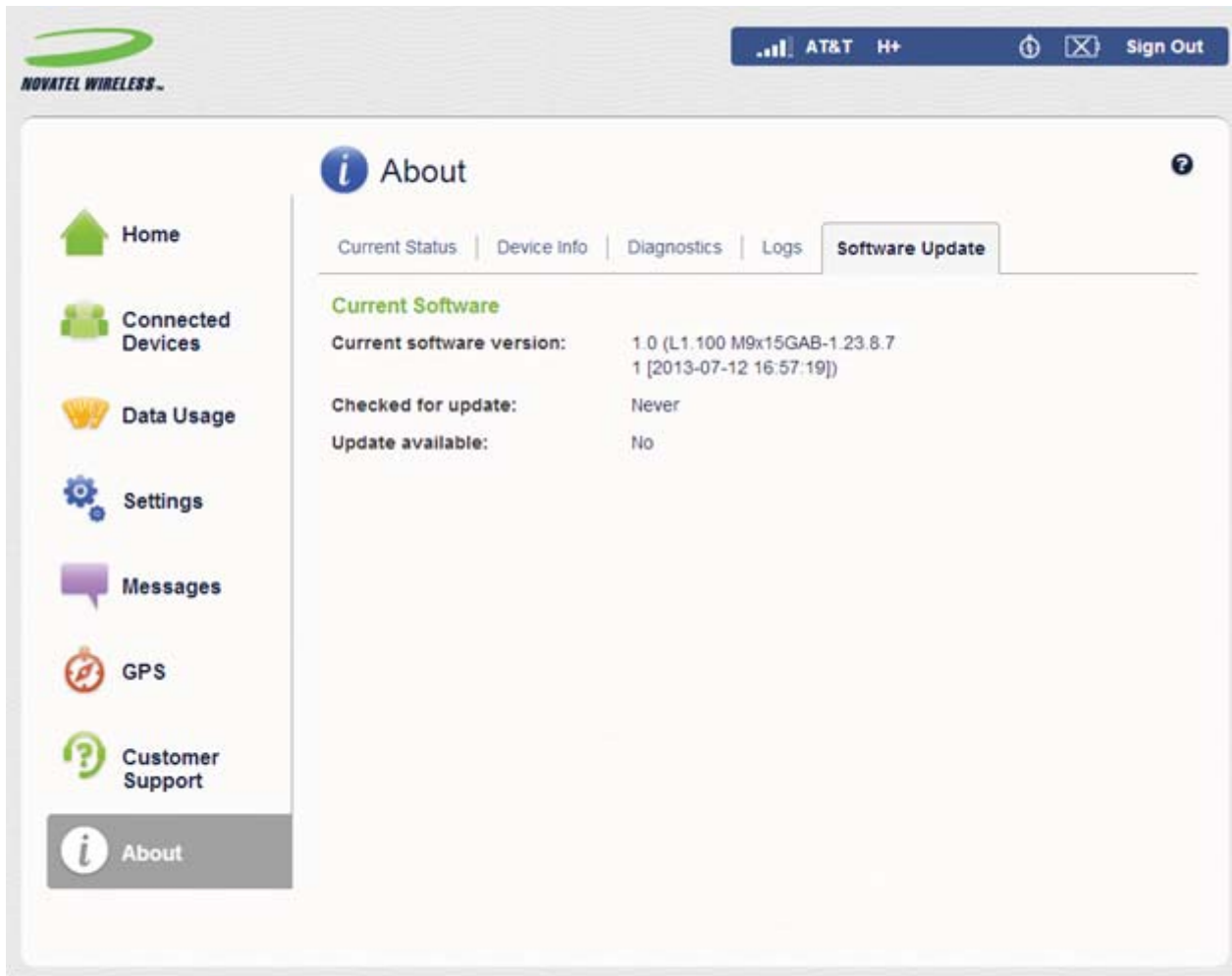

Figure 3-27 About Page - Software Update Tab

The following information is provided on the Software Update tab:

Current Software

Current Software Version: This field indicates the version of the software currently installed on this device.

Checked for update: This device automatically checks for updates; this field indicates when the last check was performed.

Update available: This indicates if an update is available. If an update is available, it is automatically downloaded and installed.

Last Update

This panel displays the details of the last update installed on this SA 2100 device. If no updates have been installed, this panel is blank.

Update History

The Update History panel displays the details of all updates that have been downloaded and installed to this SA 2100 device. If no updates have been installed, this panel is blank.

4

Accessories

Antenna

Backup Battery

Power Cable

Power Supply

USB Cable Part

Ordering Accessories

Antenna

Should an external antenna be required, these instructions must be followed. The following installation practices are required to comply with FCC rules on RF exposure. Failure to follow these guidelines can result in operations that exceed RF Exposure limits.

Maintain a minimum distance of at least 20 cm (8 in) from all persons regardless of how the antenna is mounted (stand assembly or wall mount).

Connect the antennae to the modem using the supplied cable only – do not use a different cable. Use the full length of the cable to position the antenna as far from the modem and generally populated areas as possible.

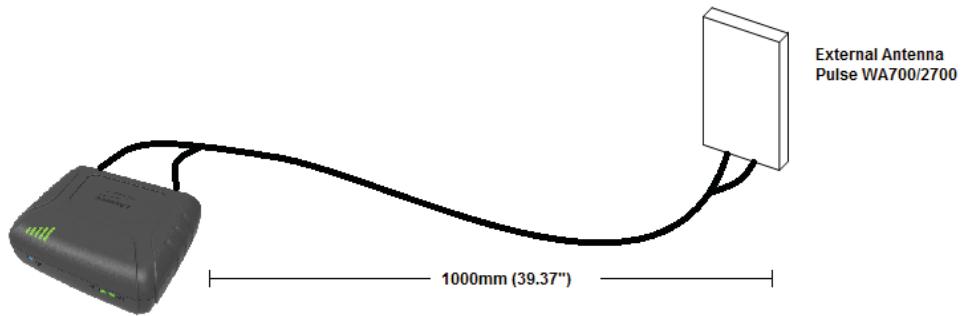

Figure 4-1 Connected Antenna

- For wall or pole mount installations position the antennae as far away from the base unit as permitted by the antenna cable. Ensure at least 20 cm (8 in) separation from the antenna element and the public.

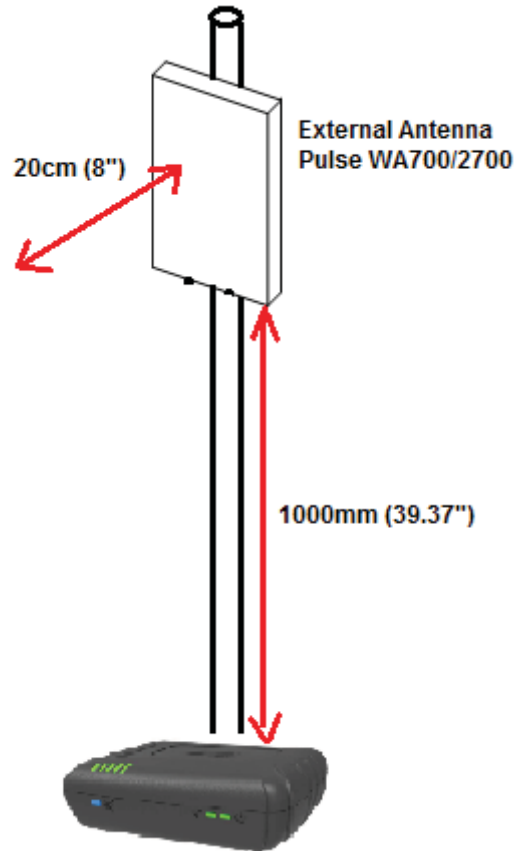

Figure 4-2 SA 2100 Antenna

- This antenna must not be located close to any other antennae or devices.
- Use only the following approved antenna types and cable assembly
 - Pulse (Part No.: WA700/2700SMA) Antenna (The gain of the antenna (including cable loss) will not exceed the following:

| Frequency | Maximum Antenna Gain (dBi) |
|-------------|----------------------------|
| 704 - 787 | 3.5 |
| 824 - 849 | 4.0 |
| 1710-1755 | 3.5 |
| 1850 - 1910 | 2.0 |

- The antenna is shipped with both a suction cup and clip for mounting.
 - Use only the supporting cable to connect the antenna to the SA 2100.
 - Never use an antenna from another vendor or another source.
- For any questions regarding the safe operation of this device please contact Novatel Wireless at www.novatelwireless.com.

Backup Battery

The Backup Battery is a rechargeable 3.7V 2900 mAh 1073Wh Li-ion Battery.



Figure 4-3 Backup Battery

The backup battery is charged when the power adapter is connected to the device. The backup battery does not charge via USB cable.

Power Cable

The Power Cable has an 8 pin Molex connector that supplies power to the SA 2100.

The Black Wire goes to the chassis ground.

The Red Wire goes to a 12V or 24V vehicle ready power supply.



Figure 4-4 Power Cable

8 Pin Molex Connector

| Pin # | Function |
|--------|---|
| Pin -1 | User Controlled Input1 (For the SA 2100's in-vehicle deployment, this pin is intended for ignition sense.) |
| Pin -2 | User Controlled Input2 |
| Pin -3 | 1-Wire |
| Pin -4 | GND |
| Pin -5 | Supply Voltage |
| Pin -6 | User Controlled IO1 |
| Pin -7 | User Controlled IO2 |
| Pin -8 | User Controlled Output |

Power Supply

The Power Adapter has an 8 pin Molex connector that supplies power to the SA 2100.

Input:

- 100-240v
- 50/60 Hz

0.45A

Output:

- 12V
- 1.5A



Figure 4-5 Power Adapter

USB Cable Part

An industry standard Micro USB (not included) is required only if communication through the Com port is required.



Figure 4-6 Micro USB Cable

Ordering Accessories

The following table shows the available accessories (and their SKU) for the SA 2100. To order an accessory contact your Novatel Wireless sales representative.

| Accessoy | SKU |
|------------------------------|----------------|
| USB | .01019886. |
| USB (latched) | .60715094. |
| mounting | .21915041. |
| mounting (vehicle) | .21915042. |
| power cable | .60715093. |
| power adapter NA(-30 TO 70C) | .40123113.01. |
| power adapter EU(-30 TO 70C) | .40123113.01. |
| battery | .40115130-001. |