

User Guide

32" 1080p LED TV

INSIGNIA™

NS-32E440A13



Contents

CHILD SAFETY	1
Important Safety Instructions	2
WARNING	2
CAUTION	3
Introduction	4
INlink	4
Installing the stand or wall-mount bracket	4
Installing the stand	4
Installing a wall-mount bracket	4
TV components	5
Package contents	5
TV front controls	5
Back	6
Remote control	7
Making connections	8
What connection should I use?	8
Connecting power	9
Connecting a cable or satellite box	9
Connecting an antenna or cable TV (no box)	12
Connecting a DVD or Blu-ray player	13
Connecting a VCR	15
Connecting a camcorder or game console	15
Connecting a computer	16
Connecting a USB flash drive	17
Connecting headphones	17
Connecting a basic home theater system	18
Connecting a home theater system with multiple devices	19
Using the remote control	19
Installing remote control batteries	19
Aiming the remote control	19
Turning on your TV for the first time	20
Understanding the basics	22
Turning your TV on or off	22

- [Selecting the video input source](#) 22
- [On-screen menu overview](#) 22
- [Navigating the menus](#) 23
- [Selecting a channel](#) 23
- [Adjusting the volume](#) 23
- [Viewing channel information](#) 24
- [Viewing system information](#) 24
- [Adjusting the picture](#) 24
 - [Adjusting the TV picture](#) 24
 - [Adjusting the computer image](#) 25
 - [Adjusting component video settings](#) 26
 - [Setting the power on picture mode](#) 26
 - [Displaying a banner at power on](#) 27
- [Adjusting the sound](#) 27
 - [Adjusting sound settings](#) 27
 - [Playing TV audio only](#) 28
- [Changing channel settings](#) 29
 - [Automatically scanning for channels](#) 29
 - [Hiding channels](#) 30
 - [Setting up a favorite channel list](#) 31
 - [Viewing a favorite channel](#) 31
 - [Adding or changing a channel label](#) 31
 - [Checking the digital signal strength](#) 32
- [Setting parental controls](#) 33
 - [Setting or changing the password](#) 33
 - [Locking control buttons](#) 34
 - [Blocking unrated TV](#) 34
 - [Setting parental control levels](#) 35
 - [Downloading rating information](#) 37
- [Using closed captioning](#) 37
 - [Turning closed captioning on or off](#) 37
 - [Selecting the analog closed captioning mode](#) 38
 - [Customizing digital closed captioning styles](#) 38
- [Adjusting time settings](#) 39
 - [Setting the clock](#) 39
 - [Setting the sleep timer](#) 40
- [Adjusting menu settings](#) 41
 - [Selecting the menu language](#) 41
 - [Labeling an input source](#) 41
 - [Restoring settings to the defaults](#) 42

Using INlink	43
Turning INlink on or off	43
Turning Device Auto Power Off on or off	43
Turning TV Auto Power On on or off	44
Displaying a list of INlink-compatible (HDMI CEC) devices	44
Using a USB flash drive	45
Switching to USB mode	45
Browsing photos	45
Viewing favorite photos	46
Viewing photos in a slideshow	46
Customizing slideshow settings	46
Maintaining	47
Cleaning the TV cabinet	47
Cleaning the TV screen	47
Troubleshooting	47
Video and audio	47
Remote control	49
General	49
Specifications	50
Programming universal remote controls	51
Programming a different universal remote control	51
Common universal remote control codes	51
Legal notices	52
One-year limited warranty - Insignia Televisions	53
Definitions:	53
How long does the coverage last?	53
What does this warranty cover?	53
How to obtain warranty service?	53
Where is the warranty valid?	53
What does the warranty not cover?	53

CHILD SAFETY

It makes a difference how and where you use your flat panel display

As you enjoy your new product, keep these safety tips in mind

The issue

The home theater entertainment experience is a growing trend, and larger TVs are popular purchases. However, TVs are not always supported on the proper stands or installed according to the manufacturer's recommendations. We and the consumer electronics industry are committed to making home entertainment enjoyable and safe.

TVs that are inappropriately placed on dressers, bookcases, shelves, desks, speakers, chests, or carts may fall over and cause injury.

Tune into safety

- One size of TV stand does **not** fit all. Use only a TV stand rated for the weight of your TV.
- Carefully read and understand all enclosed instructions for proper use of this product.
- Don't let children climb on or play with entertainment system furniture and TVs.
- Don't place TVs on furniture that can easily be used as steps, such as a crate or chest of drawers.
- Remember that children can become excited while watching a program, especially on a "larger-than-life" TV. Make sure that you place or install the TV where it cannot be pushed, pulled over, or knocked down.
- Make sure that you route all cords and cables so that they cannot be pulled or grabbed by curious children.



Wall mounting

If you decide to wall mount your TV, always remember:

- One size of wall mount does **not** fit all. Use only a wall mount rated for the weight of your TV and that has been recommended by this TV manufacturer, listed in this manual, or otherwise listed by an independent laboratory as suitable for your TV.
- Follow all instructions supplied by the TV and wall mount manufacturers.
- If you have any doubts about your ability to safely wall mount your TV, get help from a professional installer.
- Make sure that the wall where you are mounting the TV is appropriate. Some wall mounts are not designed to be mounted to walls backed with steel studs or cinder blocks. If you are unsure, ask a professional installer.

TVs can be heavy. At least two people are required for safe wall mount installation.



Important Safety Instructions



This symbol indicates that dangerous voltage constituting a risk of electric shock is present within your TV. This label is located on the back of your TV.



This symbol indicates that there are important operating and maintenance instructions in the literature accompanying your TV.

- 1 Read these instructions.
- 2 Keep these instructions.
- 3 Heed all warnings.
- 4 Follow all instructions.
- 5 Do not use this apparatus near water.
- 6 Clean only with dry cloth.
- 7 Do not block any ventilation openings. Install in accordance with the manufacturer's instructions.
- 8 Do not install near any heat sources such as radiators, heat registers, stoves, or other apparatus (including amplifiers) that produce heat.
- 9 Do not defeat the safety purpose of the polarized or grounding-type plug. A polarized plug has two blades with one wider than the other. A grounding type plug has two blades and a third grounding prong. The wide blade or the third prong are provided for your safety. If the provided plug does not fit into your outlet, consult an electrician for replacement of the obsolete outlet.
- 10 Protect the power cord from being walked on or pinched particularly at plugs, convenience receptacles, and the point where they exit from the apparatus.
- 11 Only use attachments/accessories specified by the manufacturer.
- 12 Use only with the cart, stand, tripod, bracket, or table specified by the manufacturer, or sold with the apparatus. When a cart is used, use caution when moving the cart/apparatus combination to avoid injury from tip-over.  S3125A
- 13 Unplug this apparatus during lightning storms or when unused for long periods of time.
- 14 Refer all servicing to qualified service personnel. Servicing is required when the apparatus has been damaged in any way, such as power-supply cord or plug is damaged, liquid has been spilled or objects have fallen into the apparatus, the apparatus has been exposed to rain or moisture, does not operate normally, or has been dropped.

- 15 The *wall plug* is the disconnecting device. The plug must remain readily operable.
- 16 An apparatus with three-prong, grounding-type plug is a Class I apparatus which needs to be grounded to prevent possible electric shock. Make sure that you connect the Class I apparatus to a grounding-type, three-prong outlet.
- 17 Remote control batteries should not be exposed to excessive heat such as sunshine, fire, or the like.
- 18 The apparatus should not be exposed to dripping or splashing and no objects filled with liquids, such as vases, should be placed on the apparatus.

WARNING

Electric shock hazard

To reduce the risk of fire or electric shock, do not remove any cover or expose the device to rain or moisture. No user-serviceable parts are inside. Refer servicing to qualified service technicians.

Lightning

For added protection for your device receiver during a lightning storm, or when it is left unattended and unused for long periods of time, unplug it from the power outlet and disconnect any antenna or cable system. This helps prevent property damage and personal injury from lightning and power line surges.

Power lines

An outside antenna system should not be located in the vicinity of overhead power lines or other electric light or power circuits, or where it can fall into such power lines or circuits. When installing an outside antenna system, extreme care should be taken to keep from touching such power lines or circuits as contact with them might be fatal.

Handling the LCD panel

- Your TV's screen is made of glass. Do not drop your TV or hit, jolt, or press hard against the LCD panel. If the screen breaks, be careful of broken glass.
- If the LCD panel is broken, make absolutely sure that you do not touch the liquid in the panel. This may cause skin inflammation.
- If the liquid gets in your mouth, immediately gargle, rinse, and consult with your doctor. Also, if the liquid gets in your eyes or touches your skin, consult with your doctor after rinsing for at least 15 minutes or longer in clean water.

Replacement parts

When replacement parts are required, make sure that the service technician uses replacement parts specified by the manufacturer that have the same characteristics as the original part. Unauthorized substitutions may result in fire, electric shock, personal injury, or other hazards.

Safety check

After completing any service or repair to this device, ask the service technician to perform routine safety checks to determine that your TV is in correct operating condition.

Power source

Operate your TV only from the type of power source indicated on the marking label. If you are not sure of the type of power supplied to your home, consult an electrician or your local power company.

Servicing

These servicing instructions are for use by qualified service personnel only. To reduce the risk of electric shock, do not perform any servicing other than that contained in the operating instructions unless you are qualified to do so.

CAUTION

Damage requiring service

Unplug this TV from the power outlet and refer servicing to qualified service personnel under the following conditions:

- When the power supply cord or plug is damaged or frayed.
- If liquid has been spilled or objects have fallen into your TV.
- If your TV has been exposed to rain or water.
- If your TV does not operate normally by following the operating instructions. Adjust only those controls that are covered by the operating instructions because incorrect adjustment of other controls may result in damage and will often require extensive work by a qualified technician to restore your TV to its normal operation.
- If your TV has been dropped or damaged in any way.
- When your TV exhibits a distinct change in performance.

Outdoor antenna grounding

If an outside antenna or cable system is connected to your TV, make sure that the antenna or cable system is grounded to provide some protection against voltage surges and built-up static charges. Article 810 of the National Electrical Code, ANSI/NFPA No. 70, provides information with respect to correct grounding of the mast and supporting structure, grounding of the lead-in wire to an antenna discharge unit, size of grounding conductors, location of the antenna-discharge unit, connection to grounding electrodes, and requirements for the grounding electrode.

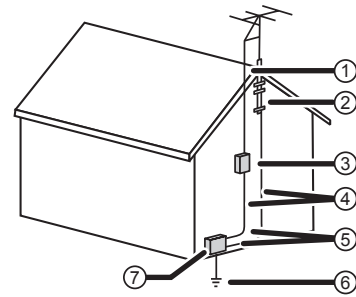

- ① Antenna lead-in wire
- ② Grounding clamp
- ③ Antenna discharge unit
- ④ Grounding conductors
- ⑤ Ground clamps
- ⑥ Power service grounding electrode system
- ⑦ Electric service equipment

Note to CATV system installer

Article 820 of the National Electrical Code, ANSI/NFPA No. 40 provides guidance for correct grounding. Specifically, it states that the cable ground must be connected to the grounding system of the building as close to the point of cable entry as practical.

Condensation

Moisture will form on the TV if the TV is brought from cool surroundings into a warm room or if the temperature of the room rises suddenly. When this happens, the TV's performance may be impaired. To prevent this, let the TV stand in its new surroundings for about an hour before switching it on, or make sure that the room temperature rises gradually.

Condensation may also form during the summer if the TV is exposed to the breeze from an air conditioner. In such cases, change the location of the TV.

Mobile telephone warning

To avoid interference with your TV picture and sound, operating problems, or even damage, keep your cordless and cellular telephones away from the TV.

End of life directives

Your TV contains tin-lead solder and a fluorescent lamp containing a small amount of mercury. Disposal of these materials may be regulated for environmental reasons. Your TV also contains material that can be recycled and reused. For disposal or recycling information, contact your local authorities to find a recycler in your area.

Non-active pixels

The LCD panel contains almost 3 million thin film transistors, which provide exceptionally sharp video quality. Occasionally, a few non-active pixels may appear on the screen as a fixed blue, green, or red point. These non-active pixels do not adversely affect the performance of your TV, and are not considered defects.

Insignia 32" 1080p LED TV

Introduction

Congratulations on your purchase of a high-quality Insignia product. Your NS-32E440A13 represents the state of the art in LED TV design and is designed for reliable and trouble-free performance.

INlink

Enjoy the benefit of having HDMI CEC compatible products plug and play! No setup is needed! CEC technology lets different components discover and communicate with each other. (See page 43 for instructions on how to use INlink.)

Installing the stand or wall-mount bracket

Notes

- If you plan to wall-mount your TV, do not install the stand.
- Store the stand and stand screws in case you decide to use the stand in the future.

Installing the stand

To install the stand:

- 1 Carefully place your TV screen face-down on a cushioned, clean surface to protect the screen from damages and scratches.
- 2 Secure the column to the screen with the four short screws (provided).

Screw type	Screw length	# of screws
M4	10 mm	4

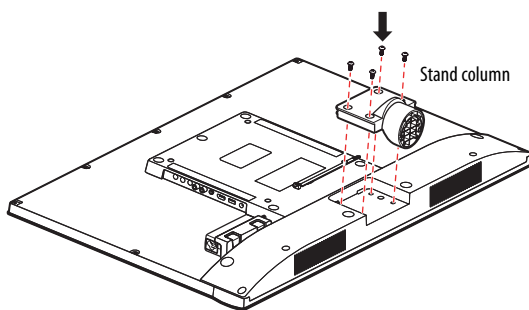

- 3 Secure the base to the stand column using the four long screws (provided).

Screw type	Screw length	# of screws
M4	20 mm	4

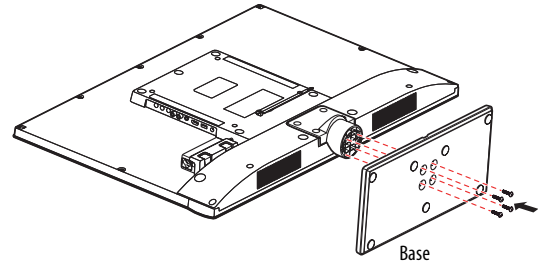

Installing a wall-mount bracket

Warning

This TV is intended to be supported by a UL Listed wall mount bracket with suitable weight/load. (See "Miscellaneous" on page 50.)

To attach your TV to a wall-mount bracket:

- 1 Carefully place your TV screen face-down on a cushioned, clean surface to protect the screen from damages and scratches.
- 2 If the stand is attached, remove the four screws that secure the base to the stand column, then remove the base. Remove the four screws that secure the stand column to the TV screen, then remove the stand column.

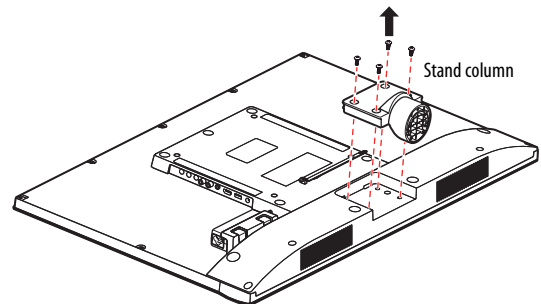
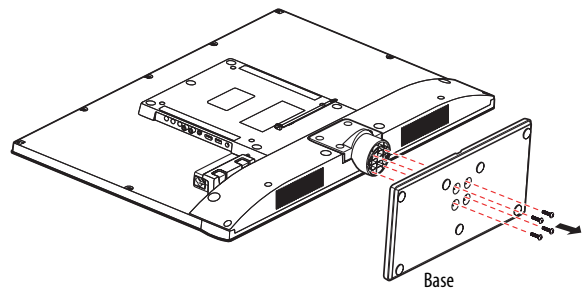

- Attach the wall-mount bracket to your TV using the mounting holes on the back of your TV. See the instructions that came with the wall-mount bracket for information about how to correctly hang your TV.

Note

- The length of the wall-mount screws vary depending on the wall-mount bracket you purchased. See the instructions that came with the wall-mount bracket for screw lengths.
- The mounting holes on the back of your TV take type M6 screws.

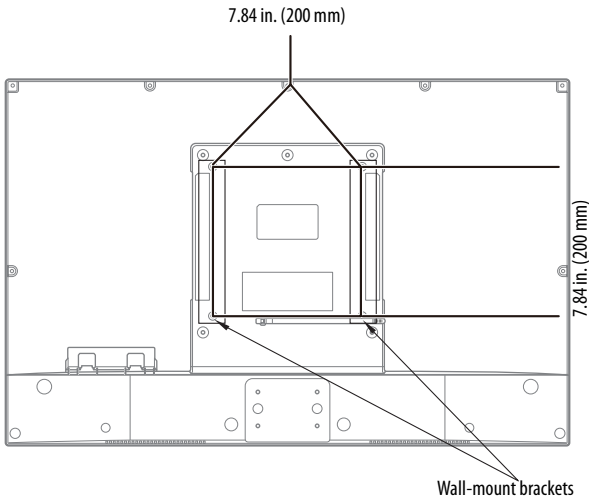

TV front controls

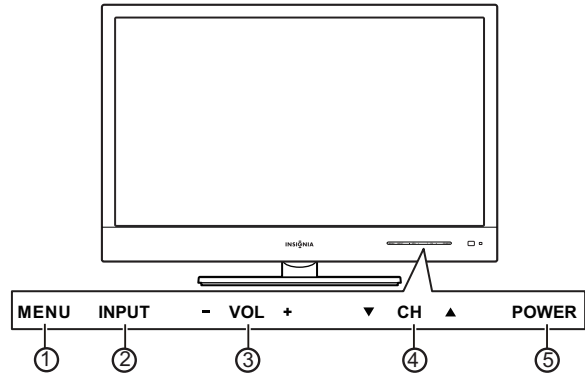

#	Item	Description
①	MENU	Press to open the on-screen menu. For more information, see "Navigating the menus" on page 23.
②	INPUT	Press to open the <i>INPUT SOURCE</i> list, then press INPUT or press CH ▲ or CH ▼ to select a video input source. After the video input source you want is highlighted, the video input source will change after three seconds. For more information, see "Selecting the video input source" on page 22. In menu mode, press to confirm selections.
③	VOL+/VOL-	Press to increase or decrease the volume.
④	CH ▲/CH ▼	Press to go to the next or previous channel in the channel list. For more information, see "Selecting a channel" on page 23.
⑤	⏻ /POWER	Press to turn your TV on or off (standby mode). When your TV is off, power still flows through it. To completely disconnect power, unplug the power cord.

TV components

Package contents

- Remote control and batteries (2 AAA)
- Stand column, base, and screws (8)
- Quick Setup Guide*
- IMPORTANT INFORMATION**

Back

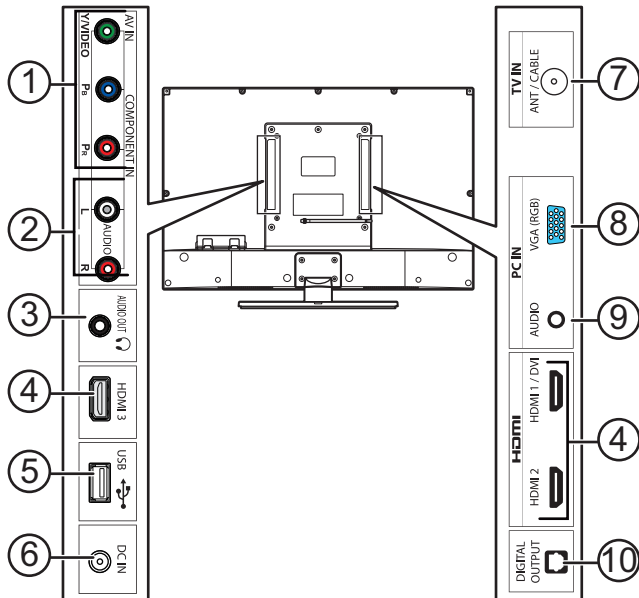

#	Item	Description
		The COMPONENT IN Y jack is the same as the AV IN jack. You can connect a component video device to the COMPONENT IN Y/Pb/Pr JACKS or composite video device to the COMPONENT IN Y (AV IN) jack.
①	COMPONENT IN Y/Pb/Pr OR AV IN	Connect the video for a component video device to these jacks. For more information, see " Using component video (better) " on page 10 or 14. OR Connect the video for a composite video device to the AV IN jack. For more information, see " Using composite video (good) " on page 11 or 14.
②	L/R AUDIO	The component video jacks (COMPONENT IN Y/Pb/Pr) share these audio jacks with the composite video jack (AV IN). Connect the audio for a component video device to these jacks. For more information, see " Using component video (better) " on page 10 or 14. OR Connect the audio for a composite video device to these jacks. For more information, see " Using composite video (good) " on page 11 or 14.
③	Ω/AUDIO OUT	Connect headphones, an analog audio amplifier, a home theater system, or a sound bar to this jack. For more information, see " Using analog audio " on page 18.
④	HDMI 1/DVI HDMI2 HDMI3	Connect HDMI devices to these jacks. For more information see " Using HDMI (best) " on page 9 or 13. Connect the video for a DVI device to the HDMI 1/DVI jack. For more information, see " Using DVI (same as HDMI but requires a sound connection) " on page 10 or 13.
⑤	USB	Connect a USB flash drive to this jack to view compatible JPEG picture files. For more information, see " Connecting a USB flash drive " on page 17 and " Using a USB flash drive " on page 45.
⑥	DC IN	Connect the AC adapter to this jack and the power cord to the AC adapter. For more information, see " Connecting power " on page 9.
⑦	TV IN ANT./CABLE	Connect an antenna or cable TV to this jack. For more information, see " Connecting an antenna or cable TV (no box) " on page 12.
⑧	PC IN VGA (RGB)	Connect the video for a computer to this jack. For more information, see " Connecting a computer " on page 16.
⑨	PC IN AUDIO	Connect the audio for a computer to this jack. For more information, see " Connecting a computer " on page 16. OR Connect the audio for a DVI device to the this jack. For more information, see " Using DVI (same as HDMI but requires a sound connection) " on page 10 or page 13.
⑩	DIGITAL OUTPUT (optical)	Connect a digital audio amplifier or home theater system to this jack to listen to TV audio through the amplifier speakers. For more information, see " Using digital audio " on page 18.

Remote control

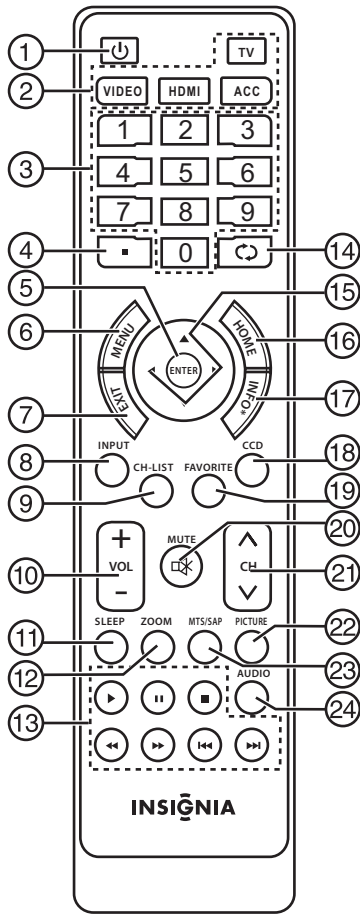







#	Button	Description
12	ZOOM	Press to change how the picture looks on the screen (aspect ratio). For more information, see "Aspect ratio options" on page 25.
13	INLink Controls	Press to control INLink-compatible (HDMI CEC) devices. For more information, see "Using INLink" on page 43.
14	(return)	In TV mode, press to return to the previous channel.
15	▲ ▼ ◀ ▶	Press to navigate in on-screen menus and to adjust settings.
16	HOME	Press to open the on-screen menu.
17	INFO	Press to display TV status information, such as the channel number, channel name (if available), or signal source. For more information, see "Viewing channel information" on page 24.
18	CCD	Press to turn closed captioning on or off. You can select CC Off , CC On , or CC on When Mute . For more information, see "Turning closed captioning on or off" on page 37.
19	FAVORITE	Press to open the <i>Favorite</i> channel list. For more information, see "Setting up a favorite channel list" on page 31 and "Viewing a favorite channel" on page 31.
20	🔇 /MUTE	Press to mute the sound. Press again to restore the sound.
21	CH ▲ /CH ▼	Press to change TV channels. For more information, see "Selecting a channel" on page 23.
22	PICTURE	Press to select the picture mode. You can select Vivid , Standard , Theater , Energy Savings , or Custom . For more information, see "Picture Mode" in "Adjusting the TV picture" on page 24.
23	MTS/SAP	Press to select the audio mode for an analog program. You can select: <ul style="list-style-type: none"> • MONO—Select this option if there is noise or static on weak stereo broadcasts. • STEREO—Select this option for programs broadcast in stereo. • SAP—Select this option to listen to a secondary audio program, if available.
24	AUDIO	Press to select the sound mode. You can select Standard , Theater , Music , News , or Custom . For more information, see "Sound Mode" in "Adjusting sound settings" on page 27.

#	Button	Description
1	⏻ (power)	Press to turn your TV on or off (standby mode). When your TV is off, power still flows through it. To disconnect power, unplug the power cord.
2	Quick Launch Inputs	TV —Press to select your TV as the input source. VIDEO —Press to select the device connected to the COMPONENT IN jacks or AV IN jack. HDMI —Press one or more times to select the device connected to the HDMI 1 , HDMI 2 or HDMI 3 jack. ACC —No function.
3	Numbers	Press to enter channel numbers and the parental control password.
4	●	Press to enter a digital sub-channel number. For more information, see "Selecting a channel" on page 23.
5	ENTER	Press to confirm selections or changes.
6	MENU	Press to open the on-screen menu.
7	EXIT	Press to close the on-screen menu.
8	INPUT	Press to open the <i>INPUT SOURCE</i> list, press ▲ or ▼ on the remote control to select the video input source, then press ENTER . For more information, see "Selecting the video input source" on page 22.
9	CH-LIST	Press to open the channel list.
10	VOL+/-	Press to increase or decrease the volume.
11	SLEEP	Press to set the sleep timer. You can select Off , 5 , 10 , 15 , 30 , 60 , 90 , 120 , 180 , or 240 minutes. For more information, see "Setting the sleep timer" on page 40.

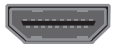
Making connections

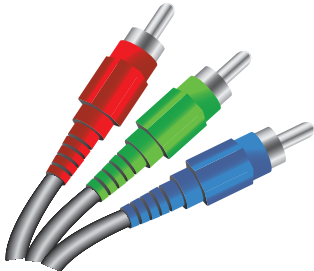
What connection should I use?

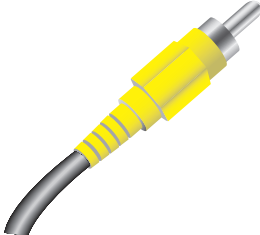
Your TV has several connection types for connecting devices to your TV. For the best video quality, you should connect a device to the best available connection. Use the following tables to identify cables:

Connection type and jack	Video quality	Cable connector
 <p>HDMI video/audio</p>	<p>Best (use this if your devices have HDMI)</p>	
 <p>Component video (requires an audio connection)</p>	<p>Better than composite or coaxial</p>	
 <p>Composite video (requires an audio connection)</p>	<p>Better than coaxial</p>	
 <p>Coaxial video/audio</p>	<p>Good</p>	

Connection type and jack	Cable connectors
--------------------------	------------------

Optical digital audio (SPDIF)



Analog audio

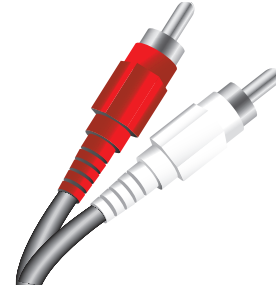

VGA (computer) video and audio

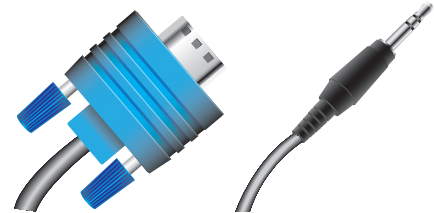
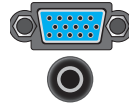

You can use the **HDMI 1/DVI** jack on your TV to connect a DVI device to your TV. You need to attach an HDMI-to-DVI adapter to the end of the HDMI cable that connects to the DVI device.

Cautions

- Check the jacks for position and type before making any connections.
- Loose connections can result in image or color problems. Make sure that all connections are tight and secure.
- The external audio/video equipment shown may be different from your equipment. If you have questions, refer to the documentation that came with your equipment.
- Always unplug the power cord when connecting external equipment.

Connecting power

To connect the power:

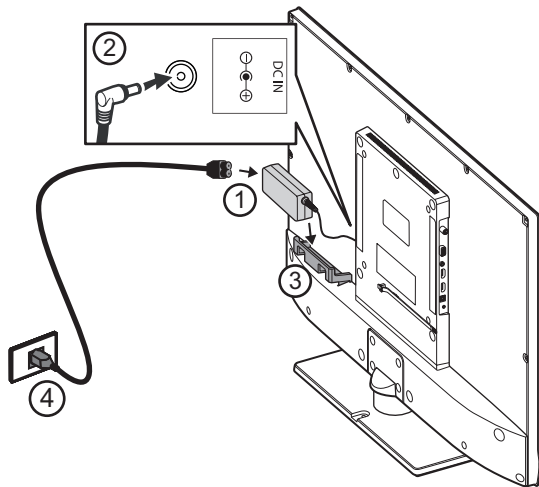

- 1 Plug the power cord into the AC adapter.
- 2 Plug the AC adapter into the **DC IN** jack on your TV.
- 3 Slide the AC adapter into the bracket on the back of your TV.
- 4 Plug the power cord into a power outlet.

Cautions

- Your TV should only be operated from the power source indicated on the label.
- Always unplug the AC power cord from the power outlet when you will not be using your TV for an extended period of time.

Connecting a cable or satellite box

Many cable or satellite TV boxes have more than one connection type. To get the best video, you should use the best connection type available. For more information, see "[What connection should I use?](#)" on page 8.

Using HDMI (best)

To connect a cable or satellite box using HDMI:

- 1 Make sure that your TV's power cord is unplugged, and all connected equipment is turned off.
- 2 Connect the incoming cable from the cable wall jack to the cable-in jack on the cable or satellite box.
- 3 Connect an HDMI cable (not provided) to one of the **HDMI** jacks on the side of your TV and to the **HDMI OUT** jack on the cable or satellite box.

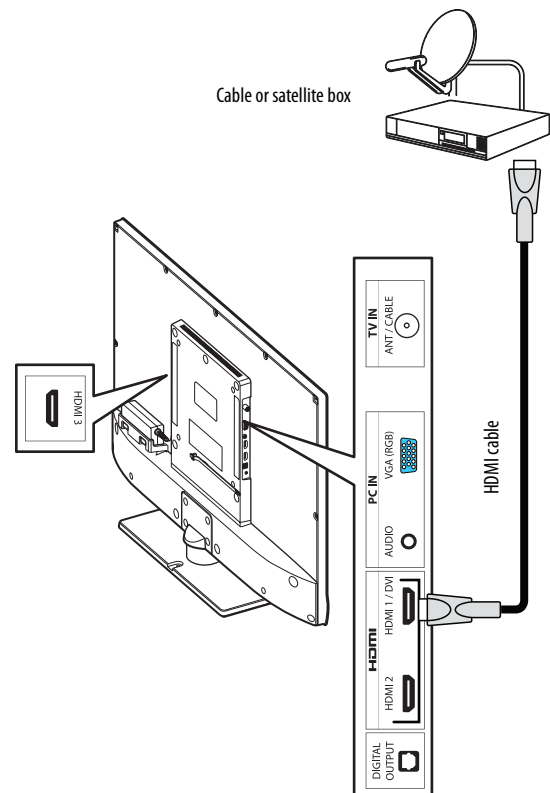

- 4 Plug your TV's power cord into a power outlet, turn on your TV, then turn on the cable or satellite box.
- 5 Go through the Setup Wizard on page 20.

Note

An HDMI cable carries both audio and video. You do not need to use any audio cables.

Using DVI (same as HDMI but requires a sound connection)

Note

You must use the **HDMI 1/DVI** jack to connect a cable or satellite box using DVI. If you use another **HDMI** jack, you will not hear sound from the TV speakers.

To connect a cable or satellite box using DVI:

- 1 Make sure that your TV's power cord is unplugged, and all connected equipment is turned off.
- 2 Connect the incoming cable from the cable wall jack to the cable-in jack on the cable or satellite box.
- 3 Connect an HDMI-DVI adapter (not provided) to one end of an HDMI cable (not provided), then connect the adapter to the **DVI OUT** jack on the cable or satellite box.
- 4 Connect the other end of the cable to the **HDMI 1/DVI** jack on the side of your TV.

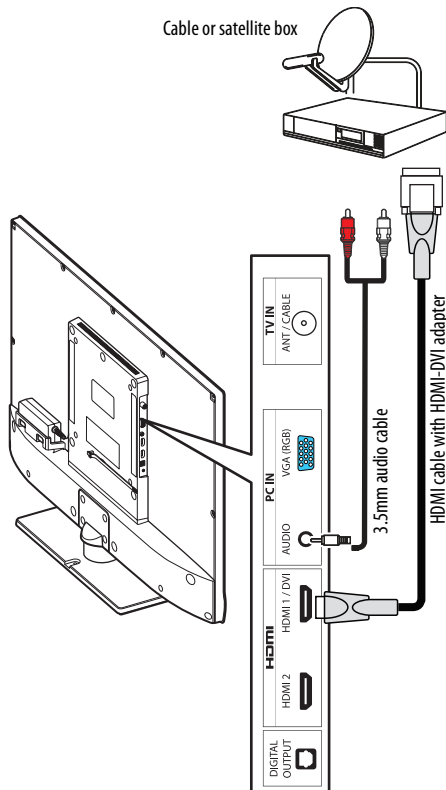

- 5 Connect a 3.5mm audio cable (not provided) to the **AUDIO** jack on the side of your TV and to the **AUDIO OUT** jacks on the cable or satellite box.

Note

When you connect the audio using the **AUDIO** jack, the audio output is analog.

- 6 Plug your TV's power cord into a power outlet, turn on your TV, then turn on the cable or satellite box.
- 7 Go through the Setup Wizard on page [20](#).

Using component video (better)

To connect a cable or satellite box using component video:

- 1 Make sure that your TV's power cord is unplugged, and all connected equipment is turned off.
- 2 Connect the incoming cable from the cable wall jack to the cable-in jack on the cable or satellite box.
- 3 Connect a component video cable (not provided) to the **COMPONENT IN Y/Pb/Pr** video jacks on the side of your TV and the component video out jacks on the cable or satellite box.

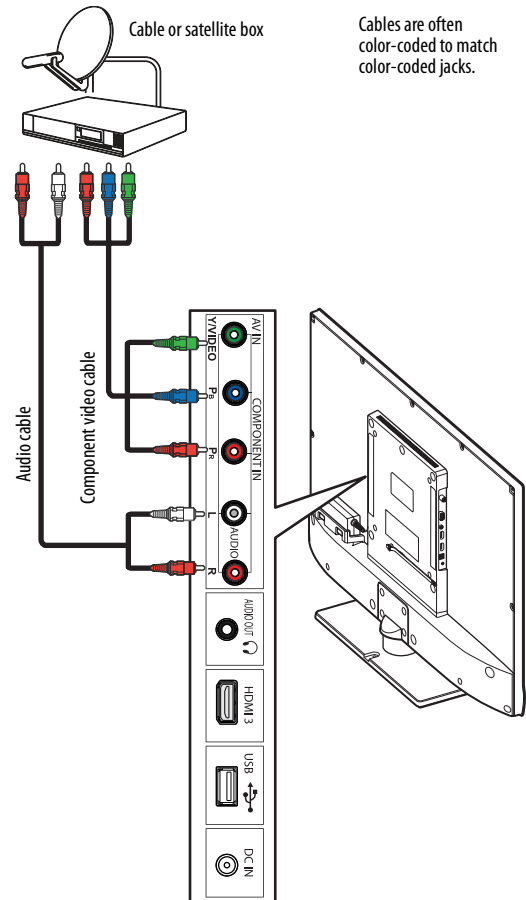

Cables are often color-coded to match color-coded jacks.

- 4 Connect an audio cable (not provided) to the **L/R AUDIO** jacks on the side of your TV and to the audio out jacks on the cable or satellite TV box.

Note

- The **COMPONENT IN** video jacks share the audio jacks with the **AV IN Y** video jack.
- When you connect the audio using the **L/R AUDIO** jacks, the audio output is analog.

- 5 Plug your TV's power cord into a power outlet, turn on your TV, then turn on the cable or satellite box.
- 6 Go through the Setup Wizard on page [20](#).

Using composite video (good)

To connect a cable or satellite box using composite video:

- 1 Make sure that your TV's power cord is unplugged, and all connected equipment is turned off.
- 2 Connect the incoming cable from the cable wall jack to the cable-in jack on the cable or satellite box.
- 3 Connect an A/V cable (not provided) to the **AV IN Y** jack and **L/R AUDIO** jacks on the side of your TV and to the composite video and audio out jacks on the cable or satellite box.

Note

- The **AV IN Y** video jack shares the audio jacks with the **COMPONENT IN** video jacks.
- When you connect the audio using the **L/R AUDIO** jacks, the audio output is analog.

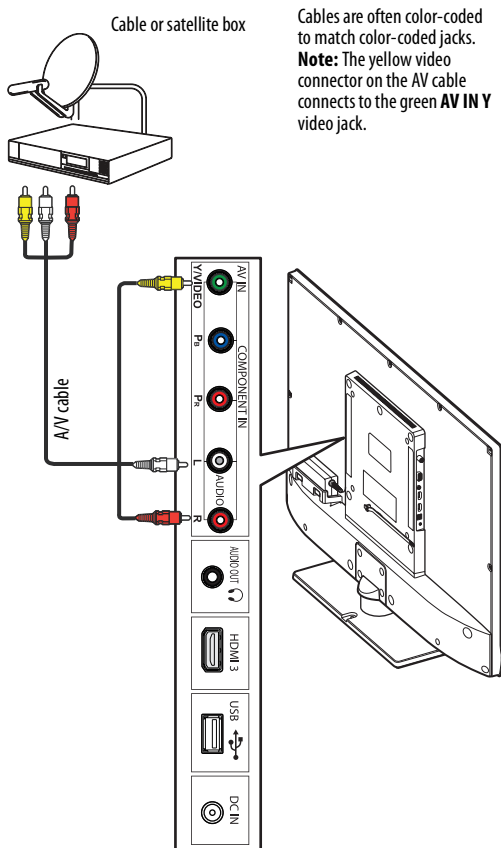

- 4 Plug your TV's power cord into a power outlet, turn on your TV, then turn on the cable or satellite box.
- 5 Go through the Setup Wizard on page [20](#).

Using coaxial (good)

To connect a cable or satellite box using coaxial:

- 1 Make sure that your TV's power cord is unplugged, and all connected equipment is turned off.
- 2 Connect the incoming cable from the cable wall jack to the cable-in jack on the cable or satellite box.
- 3 Connect a coaxial cable (not provided) to the **TV IN ANT/CABLE** jack on the side of your TV and to the coaxial out jack on the cable or satellite box.

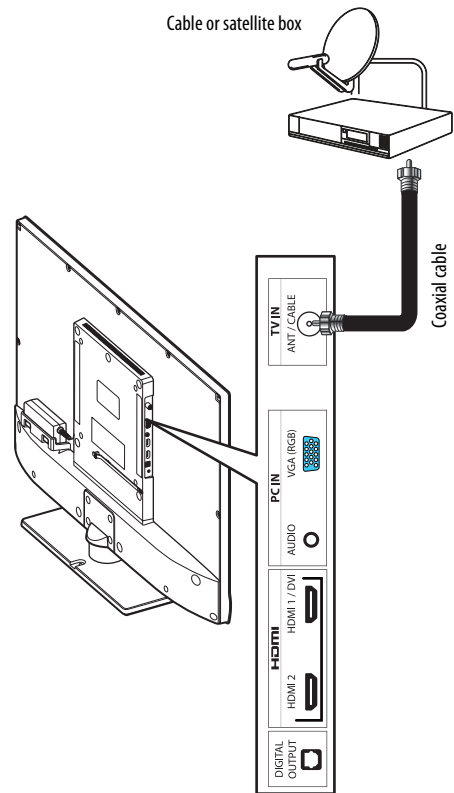

- 4 Plug your TV's power cord into a power outlet, turn on your TV, then turn on the cable or satellite box.
- 5 Go through the Setup Wizard on page [20](#).

Notes

- Use a coaxial cable to eliminate interference and noise from radio waves.
- Do not bundle the coaxial cable with the power cord or other cables.

Connecting an antenna or cable TV (no box)

To connect an antenna or cable TV (no box):

- 1 Make sure that your TV's power cord is unplugged, and all connected equipment is turned off.
- 2 Connect a coaxial cable to the **TV IN ANT/CABLE** jack on the side of your TV and to the antenna or cable TV wall jack.

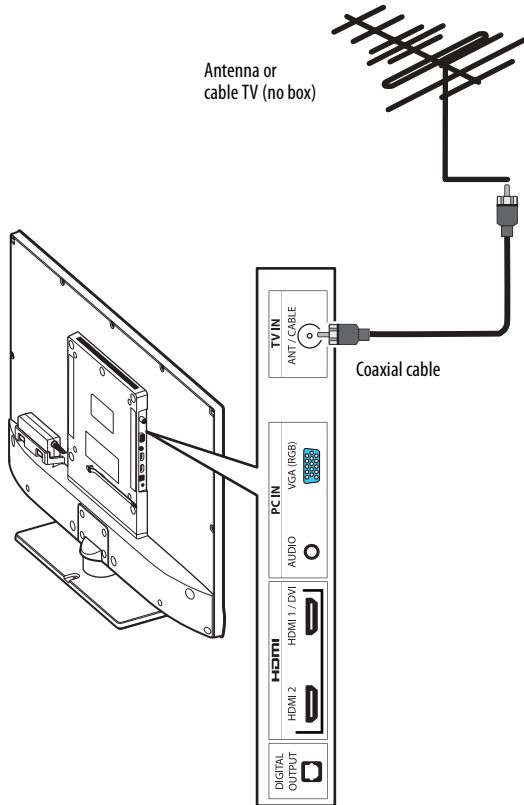

- 3 Plug your TV's power cord into a power outlet, then turn on your TV.
- 4 Go through the Setup Wizard on page [20](#).

Notes

- Use a coaxial cable to eliminate interference and noise from radio waves.
- Do not bundle the coaxial cable with the power cord or other cables.
- If the antenna is not installed correctly, contact qualified service personnel to correct the problem.
- If the signal level for a channel is weak, the picture may be distorted. Adjust the antenna or use a highly directional outdoor or set-top antenna with a built-in amplifier.
- If the picture quality is good on some channels and poor on others, the problem may be caused by a poor or weak signal from the broadcaster or cable TV provider.
- If you connect to cable or satellite TV without a set-top box and experience poor picture quality, you may need to install a set-top box to improve signal reception and picture quality. Contact your cable or satellite TV provider about upgrading to a set-top box.
- Many high-definition (HD) channels upscale standard-definition (SD) content. The picture displayed on your TV is still displayed as SD, thus the picture quality will not be as clear or crisp as it would be if the content was originally recorded in HD.

Connecting a DVD or Blu-ray player

Using HDMI (best)

To connect a DVD or Blu-ray player using HDMI:

- 1 Make sure that your TV's power cord is unplugged and the DVD or Blu-ray player is turned off.
- 2 Connect an HDMI cable (not provided) to one of the **HDMI** jacks on the side of your TV and to the **HDMI OUT** jack on the DVD or Blu-ray player.

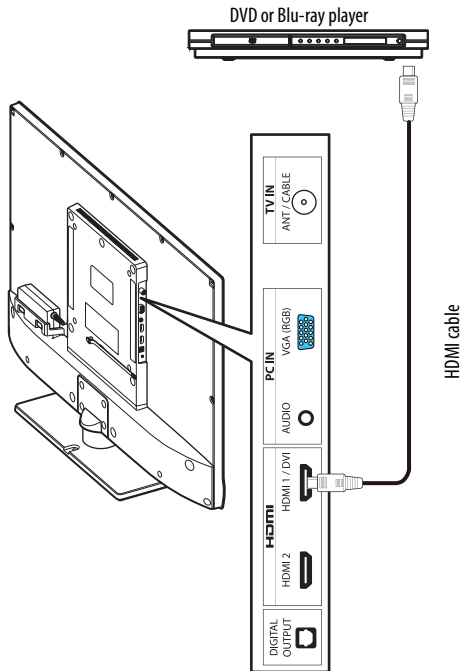

- 3 Plug your TV's power cord into a power outlet, then turn on your TV.
- 4 Turn on the DVD or Blu-ray player, then set it to the correct output mode. For more information, see the documentation that came with the player.
- 5 Press **INPUT** to open the *INPUT SOURCE* list.
- 6 Press **▲** or **▼** to highlight **HDMI1**, **HDMI2**, or **HDMI3**, then press **ENTER**.

Note

You can also press **HDMI** repeatedly to select the DVD or Blu-ray player.

Using DVI (same as HDMI but requires a sound connection)

Note

You must use the **HDMI 1/DVI** jack to connect a DVD or Blu-ray player using DVI. If you use another **HDMI** jack, you will not hear sound from the TV speakers.

To connect a DVD or Blu-ray player using DVI:

- 1 Make sure that your TV's power cord is unplugged and the DVD or Blu-ray player is turned off.
- 2 Connect an HDMI-DVI adapter (not provided) to one end of an HDMI cable (not provided), then connect the adapter to the **DVI OUT** jack on the DVD or Blu-ray player.
- 3 Connect the other end of the cable to the **HDMI 1/DVI** jack on the side of your TV.

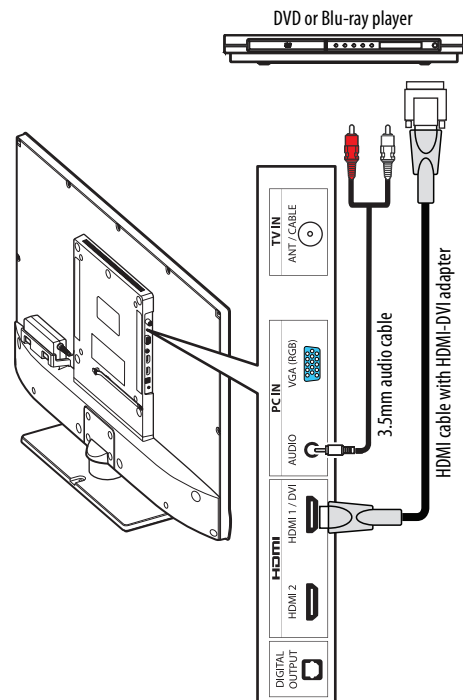

- 4 Connect a 3.5mm audio cable (not provided) to the **AUDIO** jack on the side your TV and to the **AUDIO OUT** jacks on the DVD or Blu-ray player.
- 5 Plug your TV's power cord into a power outlet, then turn on your TV.
- 6 Turn on the DVD or Blu-ray player, then set it to the correct output mode. For more information, see the documentation that came with the player.
- 7 Press **INPUT** to open the *INPUT SOURCE* list.
- 8 Press **▲** or **▼** to select **HDMI 1**, then press **ENTER**.

Note

You can also press **HDMI** repeatedly to select the DVD or Blu-ray player.

Using component video (better)

To connect a DVD or Blu-ray player using component video:

- 1 Make sure that your TV's power cord is unplugged and the DVD or Blu-ray player is turned off.
- 2 Connect a component video cable (not provided) to the **COMPONENT IN Y/PB/PR** jacks on the side of your TV and to the **COMPONENT OUT** jacks on the component video device.

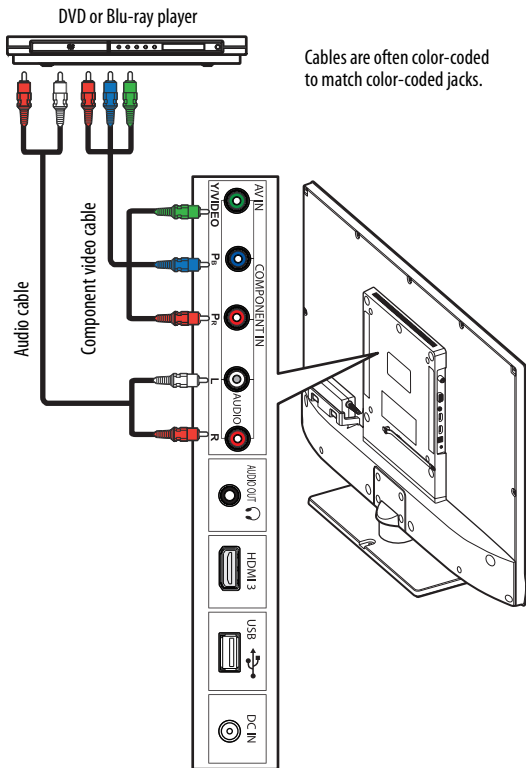

- 3 Connect an audio cable to the **L/R AUDIO** jacks on the side of your TV and to the **L/R AUDIO OUT** jacks on the DVD or Blu-ray player.

Notes

- The **COMPONENT IN** video jacks share the audio jacks with the **AV IN Y** video jack.
- When you connect the audio using the **L/R AUDIO** jacks, the audio output is analog.

- 4 Plug your TV's power cord into a power outlet, then turn on your TV.
- 5 Turn on the DVD or Blu-ray player, then set it to the correct output mode. For more information, see the documentation that came with the player.
- 6 Press **INPUT** to open the *INPUT SOURCE* list.
- 7 Press **▲** or **▼** to select **AV**, then press **ENTER**.

Note

You can also press **VIDEO** to select the DVD or Blu-ray player.

Using composite video (good)

To connect a DVD or Blu-ray player using composite video:

- 1 Make sure that your TV's power cord is unplugged and the DVD or Blu-ray player is turned off.
- 2 Connect an AV cable (not provided) to the **AV IN Y** video jack and **L/R AUDIO** jacks on the side of your TV and to the **AV OUT** jacks on the DVD or Blu-ray player.

Note

- The **AV IN Y** video jack shares the audio jacks with the **COMPONENT IN** video jacks.
- When you connect the audio using the **L/R AUDIO** jacks, the audio output is analog.

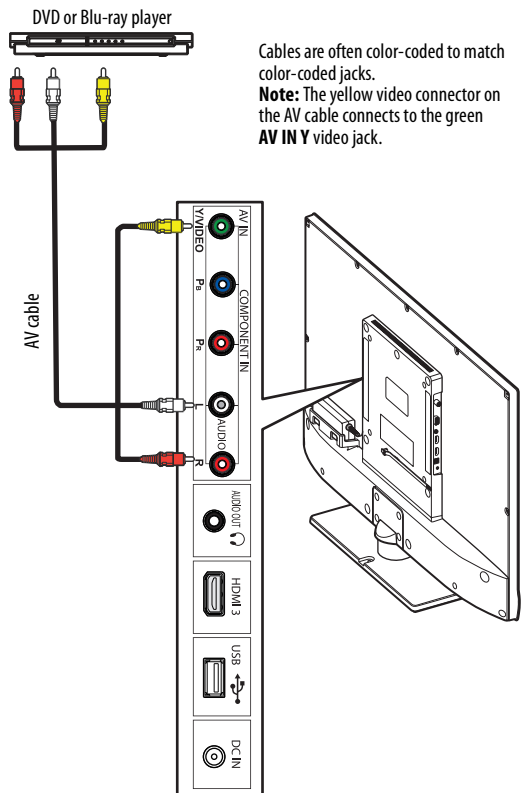

- 3 Plug your TV's power cord into a power outlet, then turn on your TV.
- 4 Turn on the DVD or Blu-ray player, then set it to the correct output mode. For more information, see the documentation that came with the player.
- 5 Press **INPUT** to open the *INPUT SOURCE* list.
- 6 Press **▲** or **▼** to select **AV**, then press **ENTER**.

Notes

You can also press **VIDEO** to select the DVD or Blu-ray player.

Connecting a VCR

To connect a VCR:

- 1 Make sure that your TV's power cord is unplugged and the VCR is turned off.
- 2 Connect an AV cable (not provided) to the **AV IN Y** video and **L/R AUDIO** jacks on the side of your TV and to the **AV OUT** jacks on the VCR.

Note

- The **AV IN Y** video jack shares the audio jacks with the **COMPONENT IN** video jacks.
- When you connect the audio using the **L/R AUDIO** jacks, the audio output is analog.

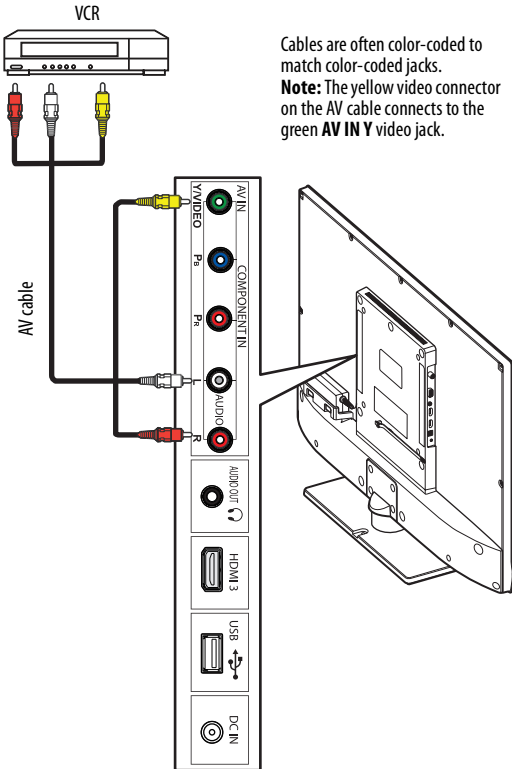

- 3 Plug your TV's power cord into a power outlet, then turn on your TV and the VCR.
- 4 Press **INPUT** to open the *INPUT SOURCE* list.
- 5 Press **▲** or **▼** to select **AV**, then press **ENTER**.

Note

You can also press **VIDEO** to select the VCR.

- 6 Insert a videotape in the VCR, then press **PLAY** on the VCR.

Connecting a camcorder or game console

Note

If your camcorder or game console has an HDMI connection, we recommend that you use the HDMI connection to get the best quality possible.

To connect a camcorder or game console:

- 1 Make sure that your TV's power cord is unplugged and the camcorder or game console is turned off.
- 2 Connect an AV cable (not provided) to the **AV IN Y** video jack and **L/R AUDIO** jacks on the side of your TV and to the **AV OUT** jacks on the camcorder or game console.

Note

- The **AV IN Y** video jack shares the **L/R AUDIO** jacks with the **COMPONENT IN** video jacks.
- When you connect the audio using the **L/R AUDIO** jacks, the audio output is analog.

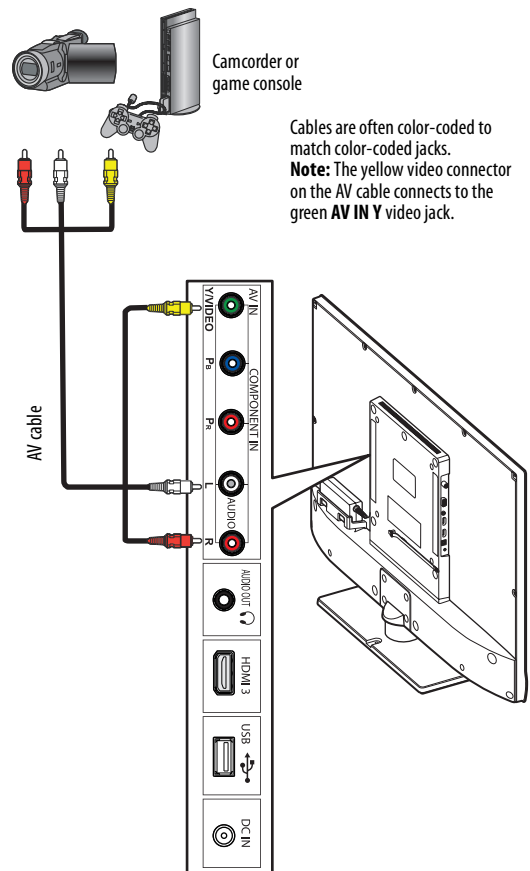

- 3 Plug your TV's power cord into a power outlet, turn on your TV.
- 4 Turn on the camcorder or game console, then set it to the correct output mode. For more information, see the documentation that came with the camcorder or game console.
- 5 Press **INPUT** to open the *INPUT SOURCE* list.
- 6 Press **▲** or **▼** to select **AV**, then press **ENTER**.

Notes

You can also press **VIDEO** to select the camcorder or game console.

Connecting a computer

Using VGA

To connect a computer using VGA:

- 1 Make sure that your TV's power cord is unplugged and the computer is turned off.
- 2 Connect a VGA cable (not provided) to the **VGA (RGB)** jack on the side of your TV and to the **VGA** jack on the computer.

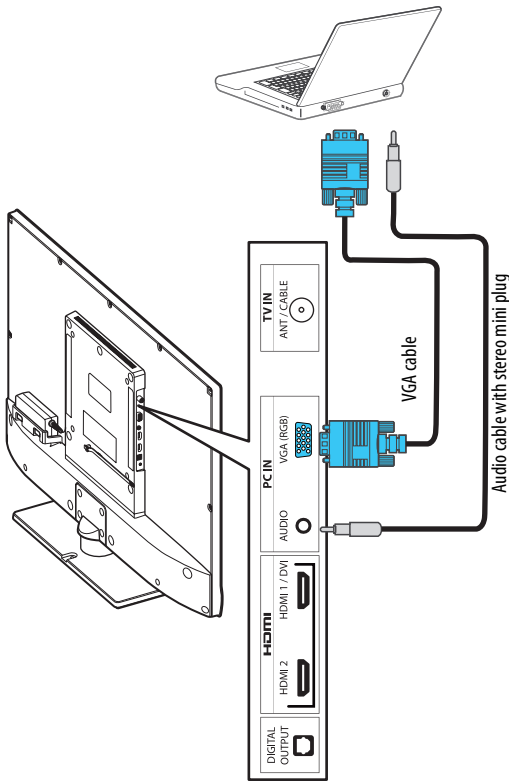

- 3 Connect an audio cable with a stereo mini plug (not included) to the **AUDIO** jack on the side of your TV and to the **AUDIO OUT** jack on the computer.
- 4 Plug your TV's power cord into a power outlet, turn on your TV and the computer.
- 5 Press **INPUT** to open the **INPUT SOURCE** list.
- 6 Press **▲** or **▼** to select **VGA**, then press **ENTER**.
- 7 Adjust the display properties on the computer, if necessary.

Using HDMI

To connect a computer using HDMI:

- 1 Make sure that your TV's power cord is unplugged and the computer is turned off.
- 2 Connect an HDMI cable (not provided) to one of the **HDMI** jacks on the side of your TV and to the **HDMI OUT** jack on the computer.

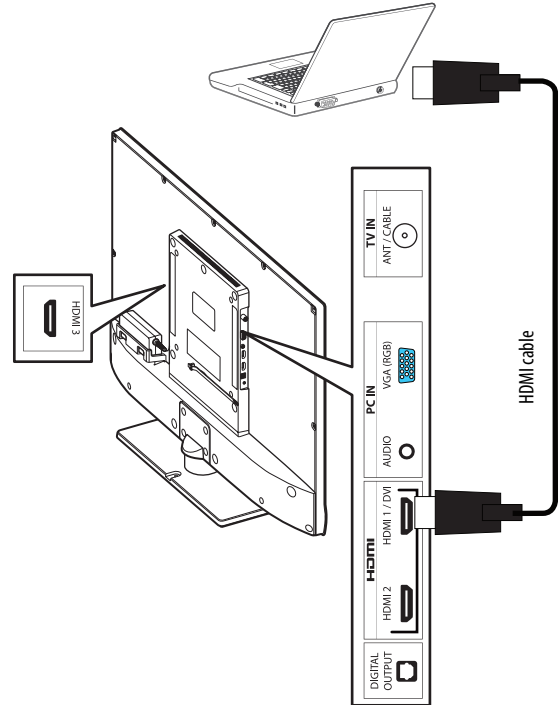

- 3 Plug your TV's power cord into a power outlet, then turn on your TV and the computer.
- 4 Press **INPUT** to open the **INPUT SOURCE** list.
- 5 Press **▲** or **▼** to highlight **HDMI1**, **HDMI2**, or **HDMI3**, then press **ENTER**.

Note

You can also press **HDMI** repeatedly to select the computer.

- 6 Adjust the display properties on the computer, if necessary.

Connecting a USB flash drive

To connect a USB flash drive:

- 1 Plug a USB flash drive into the **USB** port on the side of your TV.

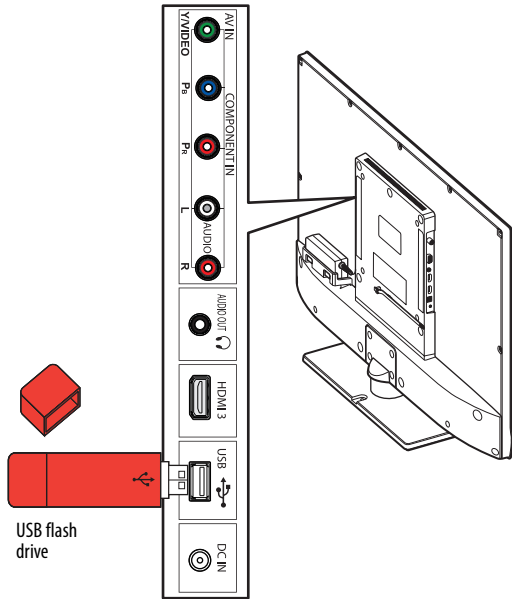

Caution
Do not remove the USB flash drive or turn off the TV while using the USB flash drive. You may lose data or damage the USB flash drive.

- 2 Turn on your TV.
- 3 Press **INPUT** to open the *INPUT SOURCE* list.
- 4 Press **▲** or **▼** to select **USB**, then press **ENTER**.

Note
The **Photos** viewer only supports JPEG format images (with ".jpg" file extensions) and not all JPEG files are compatible with your TV. For more information, see "[Using a USB flash drive](#)" on page 45.

Connecting headphones

The TV speakers are muted when headphones are attached.

Warning
Loud noise can damage your hearing. When using headphones, use the lowest volume setting on your headphones that still lets you hear the sound.

To connect headphones:

- Connect the headphones to the **Ω/AUDIO OUT** jack on the side of your TV.

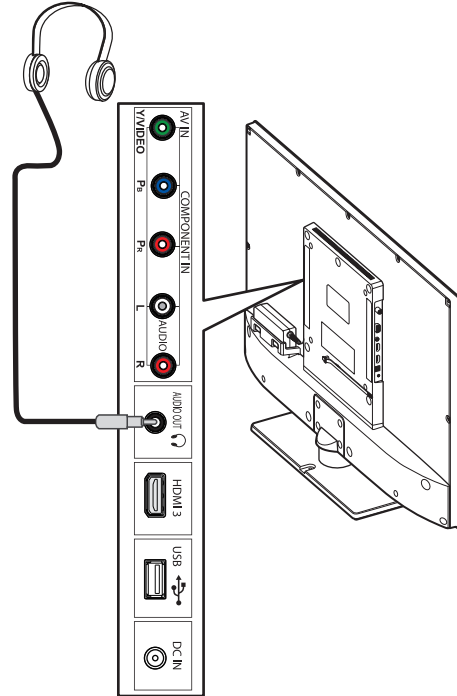

Note
You can also connect an amplifier, home theater system, or sound bar to the **Ω/AUDIO OUT** jack. If you want to connect an amplifier, home theater system, or sound bar, you need to disconnect the headphones.

Connecting a basic home theater system

Using digital audio

To connect a basic home theater system using digital audio:

- 1 Make sure that your TV's power cord is unplugged and the home theater system is turned off.
- 2 Connect a digital optical audio cable (not provided) to the **DIGITAL OUTPUT** jack on the side of your TV and to the optical **AUDIO IN** jack on the digital home theater system.

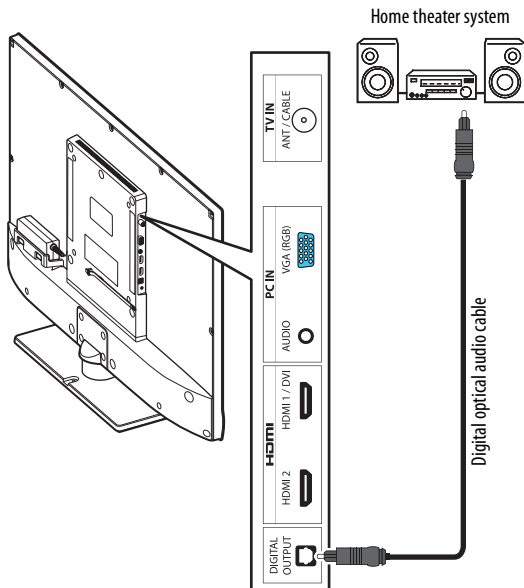

Using analog audio

To connect a home theater system using analog audio:

- 1 Make sure that your TV's power cord is unplugged and the home theater system is turned off.
- 2 Connect a 3.5mm audio cable (not provided) to the **AUDIO OUT** jack on the side of your TV and to the **AUDIO IN** jacks on the analog home theater system.

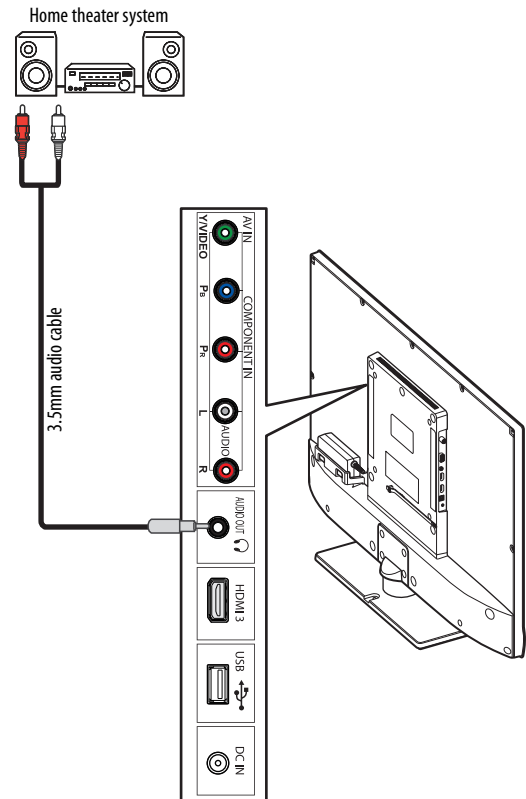

Note

You can connect headphones, an amplifier, a home theater system, or a sound bar to the **AUDIO OUT** jack. If you want to use headphones, you need to disconnect the amplifier, home theater system, or sound bar.

Connecting a home theater system with multiple devices

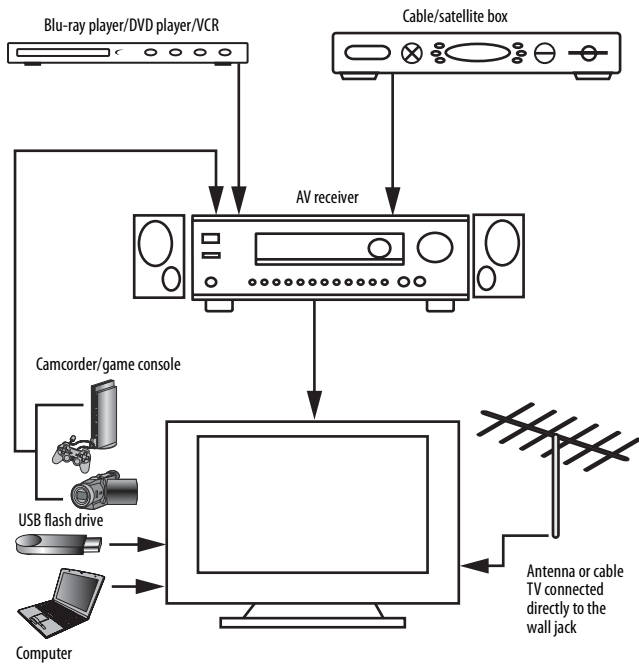

The connections you make depend on the video and audio jacks available on your devices. Refer to the documentation that came with your devices for connection information.

Just remember to use the best connection types available for the best picture and sound. For information about connection types, see [“What connection should I use?”](#) on page 8.

- 2 Insert two AAA batteries into the battery compartment. Make sure that you match the + and – symbols on the batteries with the + and – symbols in the battery compartment.

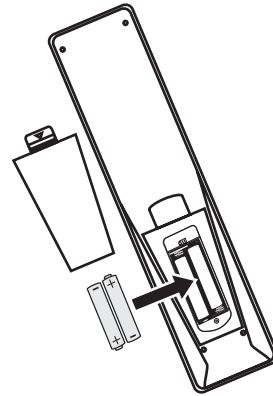

- 3 Replace the battery compartment cover.

Cautions

- Batteries should not be exposed to excessive heat, such as sunshine, heat registers, or fire.
- Battery chemicals can cause a rash. If the batteries leak, clean the battery compartment with a cloth. If chemicals touch your skin, wash immediately.
- Make sure that batteries are disposed of correctly. Do not burn or incinerate.

Notes

- Do not mix batteries of different types.
- Do not mix old and new batteries.
- Remove batteries when the charge is depleted.
- If the remote control is not going to be used for an extended period of time, remove the batteries.

Using the remote control

Installing remote control batteries

To install remote control batteries:

- 1 While pressing the release latch on the back of the remote control, lift the battery compartment cover off the remote control.

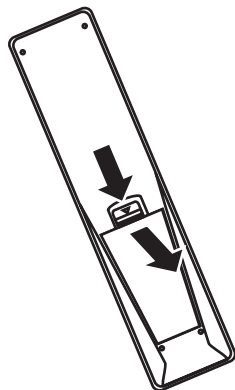

Aiming the remote control

To aim the remote control:

- Point the remote control towards the remote sensor on the front of your TV.

Turning on your TV for the first time

The first time you turn on your TV, the Setup Wizard opens. The Setup Wizard guides you through setting up basic settings including the menu language, time setting, picture mode, TV signal source, and the channel list.

To set up your TV:

- 1 Make sure that you have:
 - Installed the remote control batteries. (See page 19 for details.)
 - Connected an antenna, cable TV, or satellite TV. (See page 9 through 12 for details.)
 - Connected the power cord. (See page 9 for details.)
- 2 Press (power) to turn on your TV. The *Choose Your Menu Language* screen opens.



- 3 Press or to highlight the language you want, then press **ENTER**. The *Choose Your Time Setting* screen opens.

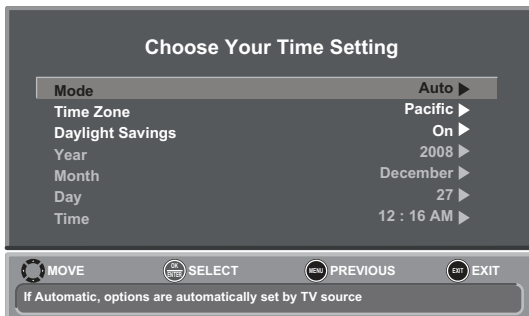

- 4 Press or to highlight **Mode**, then press or to select **Manual** (to set the date and time manually) or **Auto** (to set the date and time automatically from a TV signal source based on the time zone you select).

Note

If you select **Auto**, the displayed time will be incorrect until your TV gets the correct time from a TV signal source.

- 5 Press or to highlight **Time Zone**, then press or to select your time zone. You can select **Eastern, Central, Mountain, Pacific, Alaska, Hawaii, Atlantic, or Newfoundland**.
- 6 Press or to highlight **Daylight Savings**, then press or to select **On** (if your viewing area observes Daylight Savings Time) or **Off** (if your viewing area does not observe Daylight Savings Time).
- 7 If you selected **Manual** for **Mode**, set the date by pressing or to highlight **Year, Month, or Day**, then pressing or to adjust the setting.
- 8 If you selected **Manual** for **Mode**, set the time by pressing or to highlight **Time**, then pressing or to select the hour, minute, or AM/PM field. Press or to adjust the setting.
- 9 Press **ENTER**. The *Choose Your Picture Mode* screen opens.

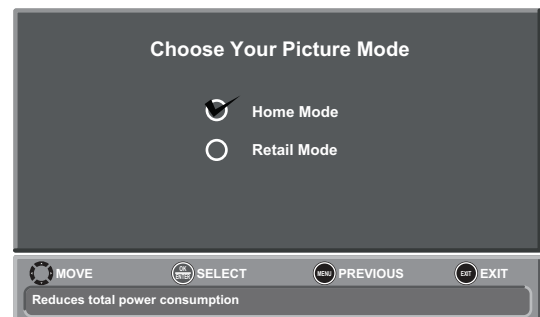

- 10 Press or to highlight **Home Mode** or **Retail Mode**, then press **ENTER**.

If you selected **Retail Mode**, the message "If you select Retail Mode, then Energy savings is not realized" appears. Select **Yes** to continue using **Retail Mode**, or select **No** to change your selection, then press **ENTER**.

The *Choose Your TV Source* screen opens.

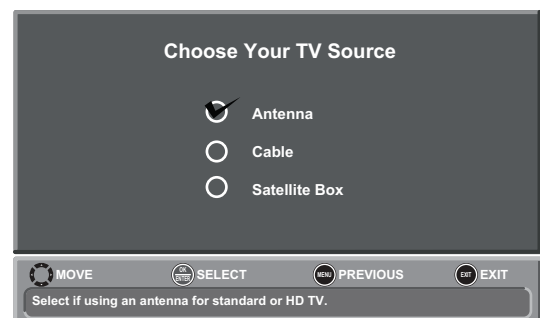

11 Press **▲** or **▼** to highlight **Antenna, Cable,** or **Satellite Box**, then press **ENTER**.

A If you select **Antenna**, your TV scans for available channels. The scan may take several minutes.

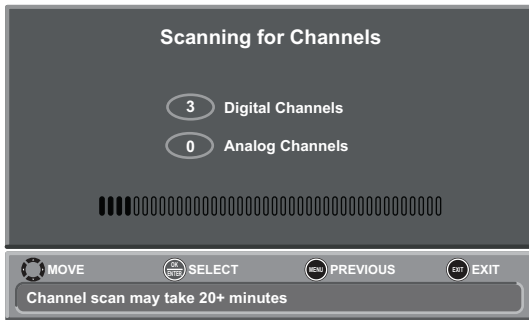

During scanning, your TV searches for digital channels first. When the digital channel search is complete, a message appears asking if you want to search for analog channels. Select **Yes** to continue searching for analog channels, or select **No** to stop searching for channels.

Note

You can press **EXIT** to stop the auto channel search, but you will need to run the auto channel search again to create a channel list.

B If you select **Cable**, a message asks if you have a cable box.

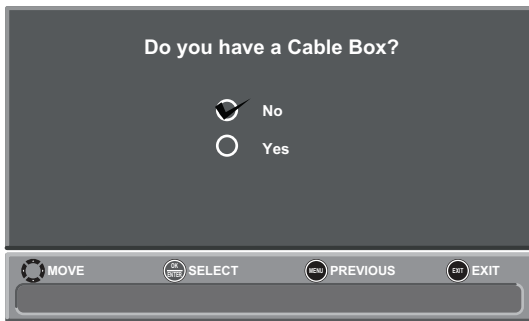

- Select **No**, then press **ENTER** if no cable box is connected. Your TV scans for available channels. The scan may take several minutes.

Note

You can press **EXIT** to stop the auto channel search, but you will need to run the auto channel search again to create a channel list.

- Select **Yes**, then press **ENTER** if a cable box is connected. A message asks how you connected the cable box to your TV.

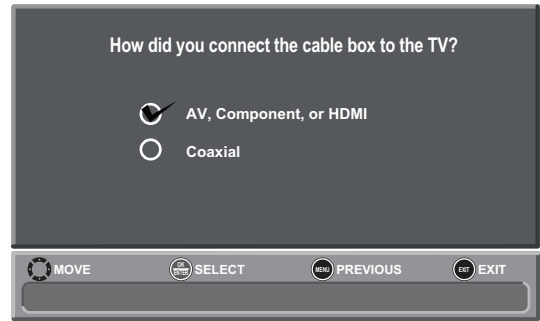

- Select **AV, Component, or HDMI**, then press **ENTER** if you connected a cable box to your TV using one of these cables. Read the message, then press **ENTER** to close the wizard.
- Select **Coaxial**, then press **ENTER** if you connected a cable box to your TV using a coaxial cable. Read the message, then press **ENTER** to start the channel scan.

Note

You can press **EXIT** to stop the auto channel search, but you will need to run the auto channel search again to create a channel list.

C If you select **Satellite Box**, a message asks how you connected the satellite box to your TV.

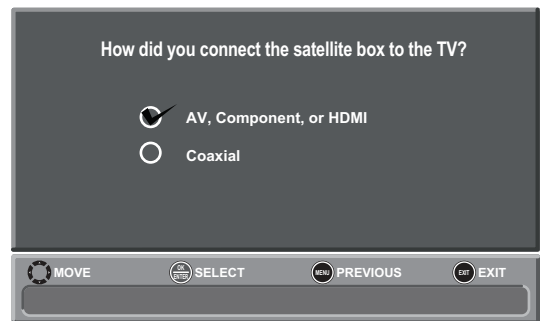

- Select **AV, Component, or HDMI**, then press **ENTER** if you connected a satellite box to your TV using one of these cables. Read the message, then press **ENTER** to close the wizard.
- Select **Coaxial**, then press **ENTER** if you connected a satellite box to your TV using a coaxial cable. Read the message, then press **ENTER** to start the channel scan.

Note

You can press **EXIT** to stop the auto channel search, but you will need to run the auto channel search again to create a channel list.

- 12 To watch TV, press **INPUT**, press **▲** or **▼** to highlight the video input source for your TV in the *INPUT SOURCE* list, then press **ENTER**.
 - If your TV is connected to an antenna, cable TV (no box), or cable or satellite TV box using a coaxial cable, select **TV**.
 - If your TV is connected to a cable or satellite box using an HDMI cable or HDMI cable with a DVI adapter, select **HDMI1**, **HDMI2**, or **HDMI3**.
 - If your TV is connected to a cable or satellite box using a component video cable, select **AV**.
 - If your TV is connected to a cable or satellite box using a composite video cable, select **AV**.

- 2 Press **▲** or **▼** to select a video input source, then press **ENTER**.

Note

Component and composite video devices share the video and audio jacks. When a device is connected, your TV detects the type of connection. If a composite device is connected, **AV** appears in the *INPUT SOURCE* list. If a component device is connected, **Component** appears in the *INPUT SOURCE* list.

You can also press a Quick Launch Input button to select the video input source.

- Press **TV** to select **TV** (if your TV is connected to an antenna, cable TV (no box), or cable or satellite TV using a coaxial cable).
- Press **VIDEO** to select component or composite input.
- Press **HDMI** one or more times to cycle between the HDMI inputs.

Understanding the basics

Turning your TV on or off

To turn your TV on or off:

- 1 Make sure that the power cord is connected to a power outlet.
- 2 Press **⏻** (power) to turn on your TV. The power indicator turns off.
- 3 Press **⏻** (power) again to turn off your TV. Your TV enters standby mode, and the power indicator LED turns red.

Warning

When your TV is in standby mode, it is still receiving power. To completely disconnect power, unplug the power cord.

Note

If your TV does not receive an input signal for several minutes, it automatically goes into standby mode.

On-screen menu overview

Notes

- Depending on the signal source selected, you may see different options on your screen. The following menus are shown in TV mode (except the *Photos* menu).
- Menu items that are not selectable are grayed out.
- Menus in this manual are described in TV mode, unless otherwise indicated.
- The screens shown in this manual are for explanation purposes and may vary from the actual screens on your TV.

Selecting the video input source

To select the video input source:

- 1 Turn on your TV, then press **INPUT**. The *INPUT SOURCE* list opens.

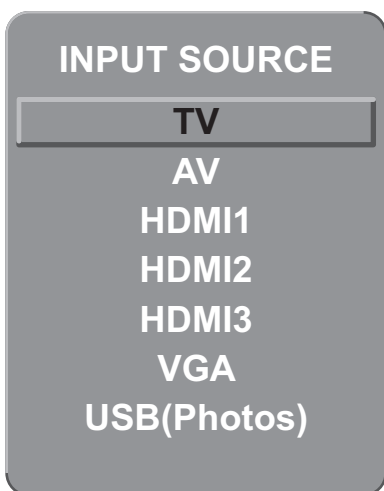

PICTURE menu (TV mode)

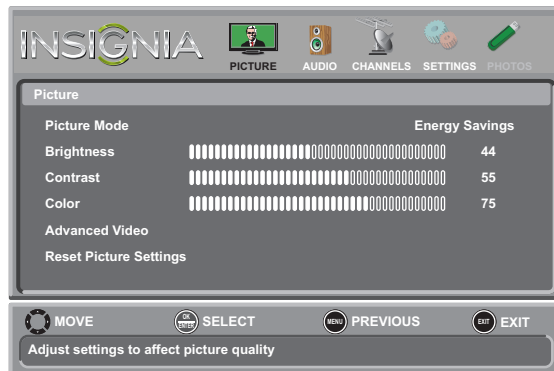

AUDIO menu (TV mode)

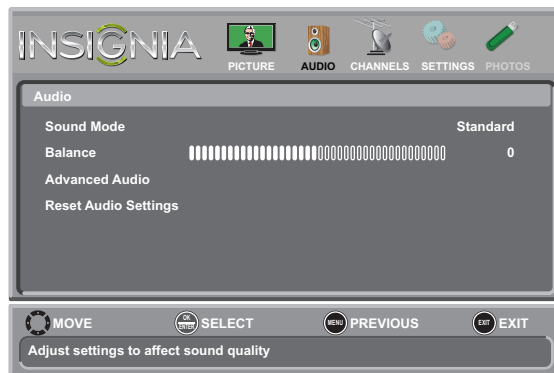

CHANNELS menu (TV mode)

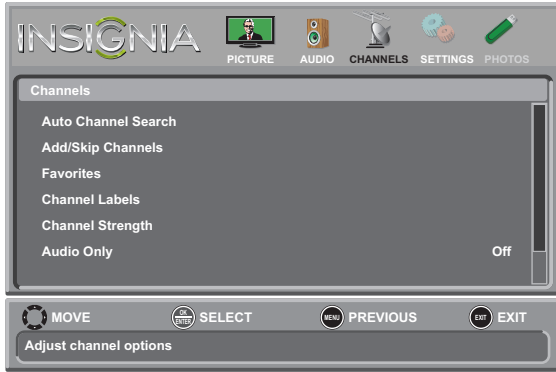

SETTINGS menu (TV mode)



PHOTOS menu (USB mode)



Navigating the menus

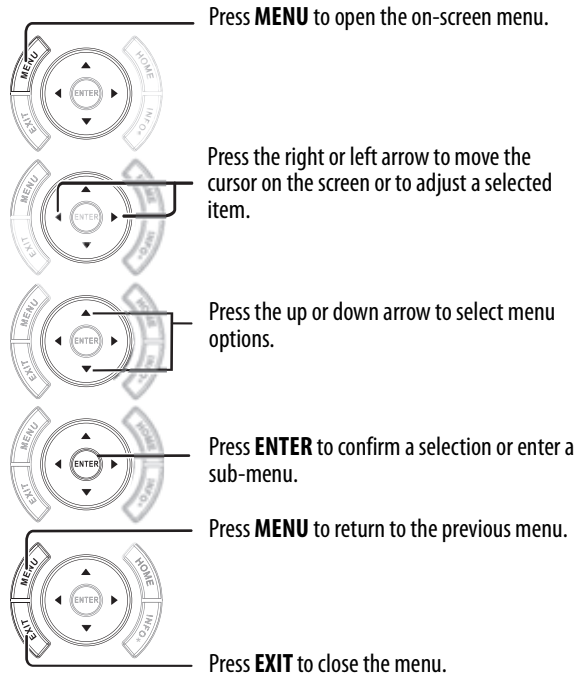

Selecting a channel

To select a channel:

- Press **CH**▲ or **CH**▼ to go to the next or previous channel on the memorized channel list.
- Press the number buttons to enter the analog or main digital channel number you want, then wait for the channel to change or press **ENTER** to immediately change the channel.
- To select a digital sub-channel, press the number buttons to select the main digital channel, press ● (dot), then press the number button for the sub-channel. Wait for the channel to change, or press **ENTER** to immediately change the channel. For example, to tune to channel 5.1, press **5**, ● (dot), then **1**.

Note

Button presses must be within three seconds of each other.

- Press ○ to go to the last viewed channel.
- Press **CH-LIST** to open the channel list, press ▲ or ▼ to highlight a channel, then press **ENTER**. Hidden channels are grayed and cannot be selected. See "[Hiding channels](#)" on page 30.
- Press **FAVORITE** to open the favorite channel list, press ▲ or ▼ to highlight a channel, then press **ENTER**.

Note

If a list has more than one page, press ▲ OR ▼ to scroll through the pages.

Adjusting the volume

To adjust the volume:

- Press **VOL+** or **VOL-** to increase or decrease the volume.
- Press **MUTE** to turn off the sound. Press **MUTE** again to turn the sound back on.

Viewing channel information

To view channel information:

- Press **INFO** to view an information banner. The information banner shows the current program information such as channel number, video input source, and resolution.
 - Digital channel information—Displays the channel number, station name, channel label, broadcast program name, TV rating, signal type, channel strength, resolution, mute status, current time, and current program start and end times.
 - Analog channel information—Displays channel number, current time, channel label (if present), signal type, and mute status.

Viewing system information

To view system information:

- 1 Press **MENU**. The on-screen menu opens.

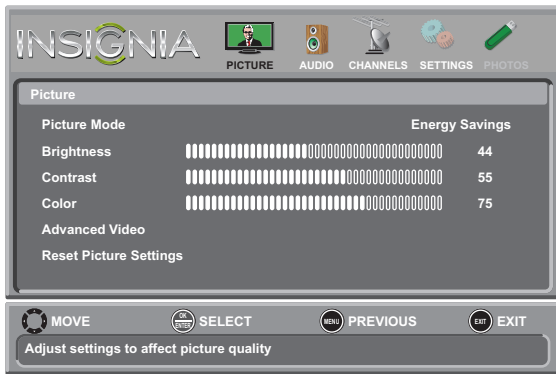

- 2 Press **◀** or **▶** to highlight **SETTINGS**, then press **▼** or **ENTER**. The *Settings* menu opens.



- 3 Press **▲** or **▼** to highlight **System Info**, then press **ENTER**. Information about the TV/DVD combo software version is displayed.
- 4 Press **MENU** to return to the previous menu, or press **EXIT** to close the menu.

Adjusting the picture

Adjusting the TV picture

To adjust the TV picture:

- 1 Press **MENU**. The on-screen menu opens with the *Picture* menu displayed.

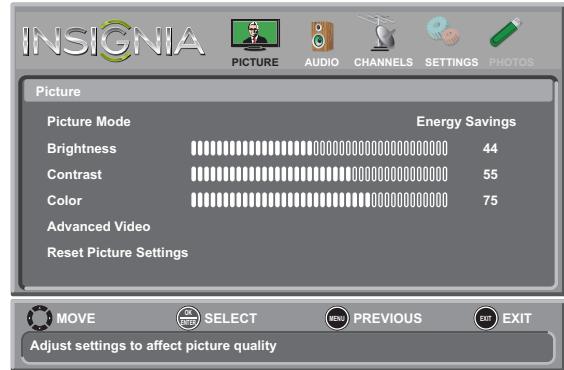

- 2 Press **▼** or **ENTER** to access the menu.
- 3 Press **▲** or **▼** to highlight an option, then press **ENTER** to access the option. You can select:
 - **Picture Mode**—Selects the picture mode. You can select:
 - **Vivid**—(a bright and vivid picture). Significantly increases the contrast, brightness, and sharpness. This selection is good for video games, animation, and in bright light environments.
 - **Standard**—(a standard picture). Moderately increases the contrast, brightness, and sharpness. This selection is good for standard TV broadcasts.
 - **Theater**—(a finely detailed picture). Adjusts the brightness and contrast and lowers the sharpness for a more realistic picture. This selection is good for watching the highest quality video such as Blu-ray Discs, DVDs, and HDTV.
 - **Energy Savings**—(the backlight brightness is decreased). Your TV has a backlight that provides light for displaying a picture. By reducing the amount of light, your TV uses less energy.
 - **Custom**—(customized picture). Lets you manually adjust picture settings such as brightness, contrast, and sharpness.

Note

You can also press **PICTURE** to select the picture mode.

- **Brightness**—Adjusts the brightness of the dark areas of the picture.
- **Contrast**—Adjusts the brightness of the light areas of the picture.
- **Color**—Adjusts the color intensity of the picture. A low setting may make the color look faded. A high setting may make the color look artificial.

- **Advanced Video**—Opens the *Picture-Advanced Video* menu where you can adjust additional video options.

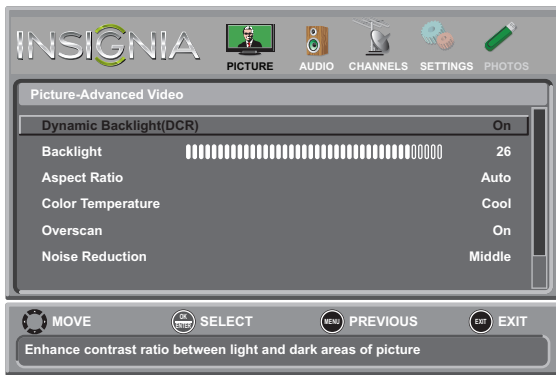

- **Dynamic Backlight (DCR)**—Enhances the contrast ratio between light and dark areas of the picture. You can select **On** or **Off**.
- **Backlight**—Sets the overall brilliance of the screen. When **Dynamic Backlight (DCR)** is turned on, you cannot change the **Backlight** setting.
- **Aspect Ratio**—Selects the aspect ratio of the picture.

- **Color Temperature**—Selects the color temperature. You can select **Cool** (to enhance the blues), **Normal**, or **Warm** (to enhance the reds).
 - **Overscan**—Adjusts the picture's reproduction rate. You can select **On** or **Off**.
 - **Noise Reduction**—Selects the noise reduction mode to reduce picture noise (snow). You can select **Low**, **Middle**, **High**, or **Off**.
 - **Tint**—Adjusts the color balance of the picture. Use this control to make skin tones look more natural.
 - **Sharpness**—Adjusts the color detail of images. If you set this control too high, dark images may appear with light or white edges.
 - **Adaptive Contrast**—Automatically adjusts picture detail and brightness. You can select **On** or **Off**.
 - **Reset Picture Settings**—Resets all picture settings to factory mode.
- 4 Press **◀** or **▶** to adjust the option, or press **▲** or **▼** to select a setting.
 - 5 Press **MENU** to return to the previous menu, or press **EXIT** to close the menu.

Aspect ratio options	Example
----------------------	---------

Normal:
Displays the original 4:3 aspect ratio with vertical black bars on the left and right of the image.



Zoom:
Expands the image to fill the screen. The top and bottom of the image may be cropped.



Wide:
Use this option to view content recorded in a 16:9 (wide-screen) aspect ratio.



Cinema:
Stretches the image at the edges, but keeps a clear image in the center.



Auto:
Automatically adjusts the image based on the screen size and the TV program.
Note: **Auto** is only available when **Auto Zoom** in the **CHANNELS** menu is set to **On**.



Note
You can also press **ZOOM** to select the aspect ratio.

Adjusting the computer image

To adjust the computer image:

- 1 Make sure that your TV is in VGA mode. For more information, see "[Selecting the video input source](#)" on page 22.
- 2 Press **MENU**. The on-screen menu opens.

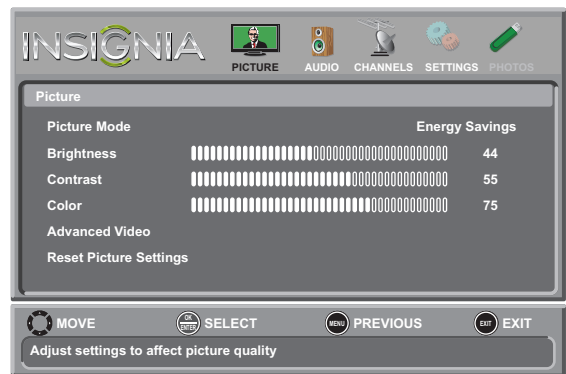

- 3 Press **◀** or **▶** to highlight **SETTINGS**, then press **ENTER**. The *Settings* menu opens.



- 4 Press **▲** or **▼** to highlight **Computer Settings**, then press **ENTER**. The *Settings-Computer Settings* menu opens.



- 5 Press **▲** or **▼** to highlight an option, then press **ENTER** to access the option. You can select:
 - **Auto Adjust**—Automatically adjusts the image settings such as position and phase.
 - **H. Position**—Moves the image right or left.
 - **V. Position**—Moves the image up or down.
 - **Clock**—Adjusts the sample frequency.
 - **Phase**—Adjusts the focus of stable images.
 - **Reset Computer Settings**—Resets all computer settings to factory mode.
- 6 Press **◀** or **▶** to adjust the option, or press **▲** or **▼** to select a setting.
- 7 Press **MENU** to return to the previous menu, or press **EXIT** to close the menu.

Adjusting component video settings

You can adjust the horizontal distortion that may occur when watching video from a component video device.

To adjust component video settings:

- 1 Make sure you have a device connected to the **Y/Pb/Pr** (component video) jacks on the side of your TV.
- 2 Press **VIDEO** to select the component video device.
- 3 Press **MENU**. The on-screen menu opens.

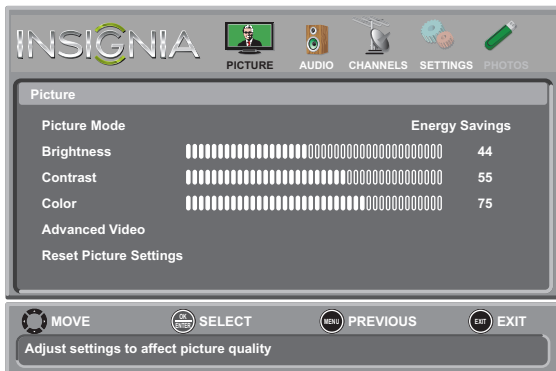

- 4 Press **◀** or **▶** to highlight **SETTINGS**, then press **▼** or **ENTER**. The *Settings* menu opens.



- 5 Press **▲** or **▼** to highlight **Component Settings**, then press **ENTER**.
- 6 Press **▲** or **▼** to highlight an option, then press **ENTER** to access the option. You can select:
 - **Phase**—Minimizes horizontal distortion.
 - **Reset Component Settings**—Resets all component video settings to factory mode.
- 7 Press **◀** or **▶** to adjust the option, or press **▲** or **▼** to select a setting.
- 8 Press **MENU** to return to the previous menu, or press **EXIT** to close the menu.

Setting the power on picture mode

You can set the picture mode your TV uses when you turn it on.

To set the power on picture mode:

- 1 Press **MENU**. The on-screen menu opens.

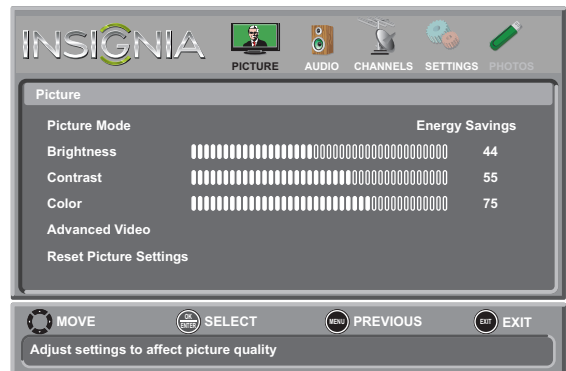

- 2 Press **◀** or **▶** to highlight **SETTINGS**, then press **▼** or **ENTER**. The *Settings* menu opens.



- 3 Press **▲** or **▼** to highlight **Reset to Default**, then press **ENTER**. The *Settings-Reset to Default* menu opens.
- 4 Press **▲** or **▼** to highlight **Power on in Vivid Mode**, then press **ENTER**.
- 5 Press **▲** or **▼** to highlight **On** (when you turn on your TV, it will be in **Vivid** picture mode) or **Off** (when you turn on your TV, it will be in the picture mode it was in before you reset to defaults), then press **ENTER**.
- 6 Press **MENU** to return to the previous menu, or press **EXIT** to close the menu.

Displaying a banner at power on

If the picture mode is set to **Retail Mode**, your TV can display a retail banner when you turn your TV on.

Note

The picture mode is set during the first time setup. For more information, see ["Turning on your TV for the first time"](#) on page 20.

To display a banner at power on:

- 1 Press **MENU**. The on-screen menu opens.

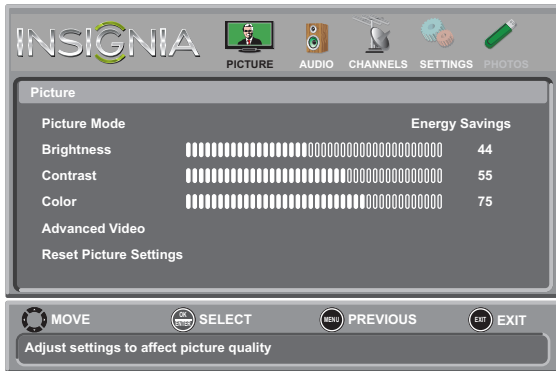

- 2 Press **◀** or **▶** to highlight **SETTINGS**, then press **▼** or **ENTER**. The *Settings* menu opens.



- 3 Press **▲** or **▼** to highlight **Reset to Default**, then press **ENTER**. The *Settings-Reset to Default* menu opens.
- 4 Press **▲** or **▼** to highlight **Retail Banner**, then press **ENTER**.
- 5 Press **▲** or **▼** to select **On** (displays an electronic banner on the screen) or **Off** (does not display an electronic banner), then press **ENTER**.

- 6 Press **MENU** to return to the previous menu, or press **EXIT** to close the menu.

Adjusting the sound

Adjusting sound settings

To adjust sound settings:

- 1 Press **MENU**. The on-screen menu opens.

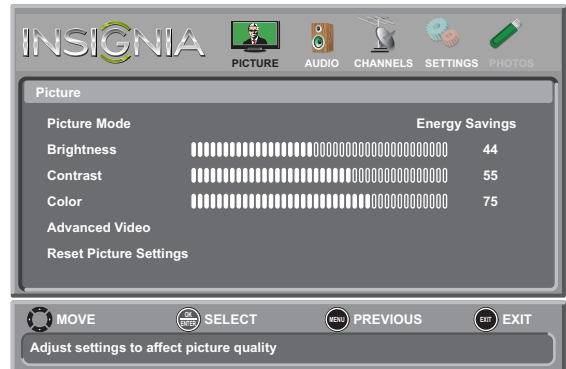

- 2 Press **◀** or **▶** to highlight **AUDIO**, then press **▼** or **ENTER**. The *Audio* menu opens.



- 3 Press **▲** or **▼** to highlight an option, then press **ENTER** to access the option. You can select:
 - **Sound Mode**—Selects the sound mode. You can select:
 - **Standard**—Balances treble and bass. This setting is good for watching standard TV broadcasts.
 - **Theater**—Moderately decrease treble and bass. This setting is for good for watching Blu-ray discs, DVDs, and HDTV.
 - **Music**—Increases the treble and bass. This setting is good for listening to music.
 - **News**—Moderately decrease treble and bass. This setting is for good for watching news broadcasts.
 - **Custom**—Lets you manually adjust sound settings.
 - **Balance**—Adjusts the balance between the left and right audio channels.

- **Advanced Audio**—Opens the *AUDIO-Advanced Audio* menu where you can adjust additional audio options.



- **Bass**—Adjusts the low sounds.
- **Treble**—Adjusts the high sounds.
- **TV Speakers**—Selects where to play TV audio. You can select **On** (default setting) to play audio through TV speakers, or select **Off** to play audio through the speakers on an external audio system.
- **Digital Audio/SPDIF**—Sends digital audio to an external audio system. You can select **PCM** (to output audio in 2-channel stereo), or **RAW** (to pass through the original digital audio sound).
- **MTS/SAP**—(Analog channels only) Selects the audio mode. You can select:
 - **Mono**—Select this option if there is noise or static on weak stereo broadcasts.
 - **Stereo**—Select this option for programs broadcast in stereo.
 - **SAP**—Select this option to listen to a secondary audio program, if available.

Note

You can also press **MTS/SAP** one or more times to select the audio mode.

- **Audio Language**—(Digital channels only) Selects an alternate audio language, if available.
 - **Reset Audio Settings**—Reset all audio settings to factory defaults.
- 4 Press **◀** or **▶** to adjust the option, or press **▲** or **▼** to select a setting.
 - 5 Press **MENU** to return to the previous menu, or press **EXIT** to close the menu.

Playing TV audio only

You can turn off the picture on your TV and listen to the program audio only.

To play TV audio only:

- 1 Press **MENU**. The on-screen menu opens.

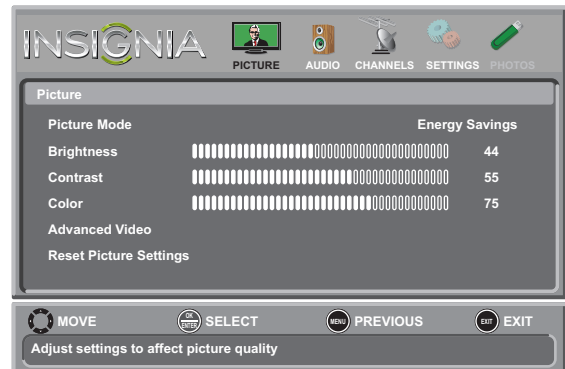

- 2 Press **◀** or **▶** to highlight **CHANNELS**, then press **▼** or **ENTER**. The *Channels* menu opens.



- 3 Press **▲** or **▼** to highlight **Audio Only**, then press **ENTER**.
- 4 Press **▲** or **▼** to select **On**.
- 5 Press **MENU** to return to the previous menu, or press **EXIT** to close the menu.

Notes

- **Audio Only** works only when the input source is TV, and your TV is receiving a broadcast signal.
- To exit audio only mode, press any button. When you exit audio only mode, the **Audio Only** option is automatically reset to **Off**.

Changing channel settings

Automatically scanning for channels

When you scan for channels, your TV searches for channels with signals and stores the channel information in the channel list. When you press **CH** \wedge or **CH** \vee , your TV goes to the next or previous channel in the channel list.

If the TV signal source changes, for example you change from an outdoor antenna to cable TV (no box), you need to scan for channels.

To automatically scan for channels:

- 1 Press **MENU**. The on-screen menu opens.

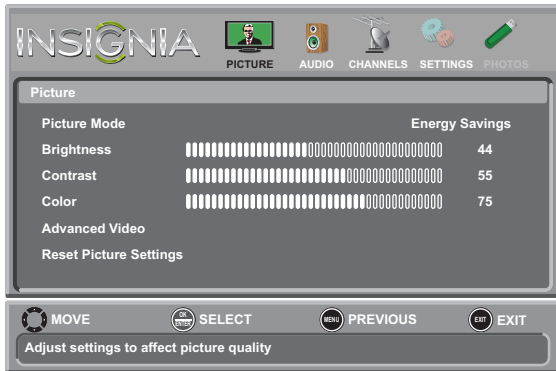

- 2 Press \leftarrow or \rightarrow to highlight **CHANNELS**, then press \blacktriangledown or **ENTER**. The *Channels* menu opens.

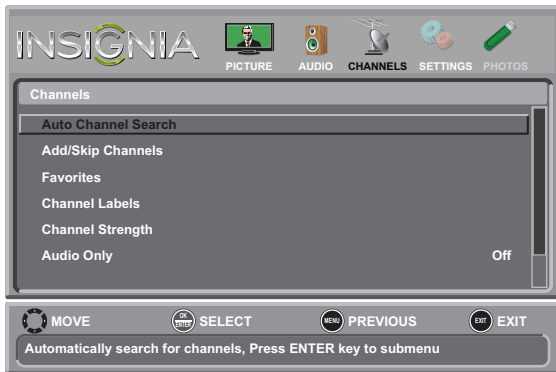

- 3 Press \blacktriangle or \blacktriangledown to highlight **Auto Channel Search**, then press **ENTER**. The *Channels-Auto Channel Search* screen opens.

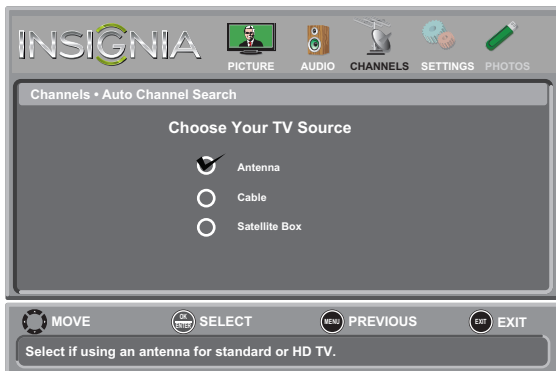

- 4 Press \blacktriangle or \blacktriangledown to highlight **Antenna**, **Cable**, or **Satellite Box**, then press **ENTER**.

- A If you select **Antenna**, your TV scans for available channels. The scan may take several minutes.

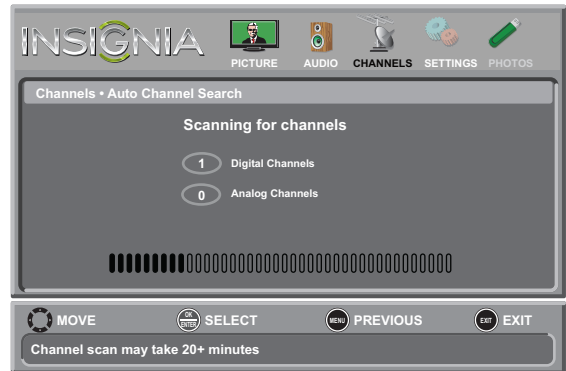

During scanning, your TV searches for digital channels first. When the digital channel search is complete, a message appears asking if you want to search for analog channels. Select **Yes** to continue searching for analog channels, or select **No** to stop searching for channels.

Note

You can press **EXIT** to stop the auto channel search, but you will need to run the auto channel search again to create a channel list.

- B If you select **Cable**, a message asks if you have a cable box.

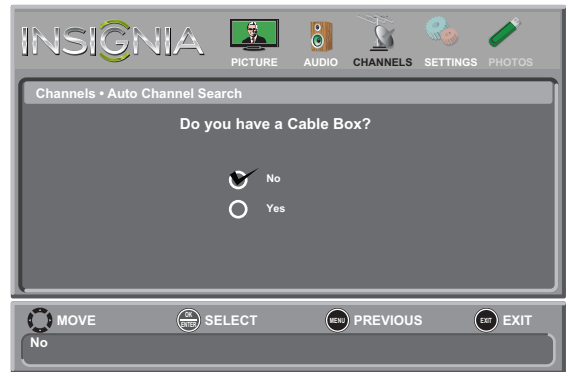

- Select **No**, then press **ENTER** if no cable box is connected. Your TV scans for available channels. The scan may take several minutes.

Note

You can press **EXIT** to stop the auto channel search, but you will need to run the auto channel search again to create a channel list.

- Select **Yes**, then press **ENTER** if a cable box is connected. A message asks how you connected the cable box to your TV.

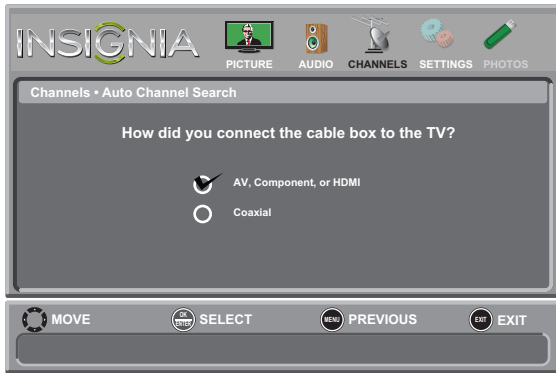

- Select **AV, Component, or HDMI**, then press **ENTER** if you connected a cable box to your TV using one of these cables. Read the message, then press **ENTER** to close the wizard.
- Select **Coaxial**, then press **ENTER** if you connected a cable box to your TV using a coaxial cable. Read the message, then press **ENTER** to start the channel scan.

Note

You can press **EXIT** to stop the auto channel search, but you will need to run the auto channel search again to create a channel list.

- C** If you select **Satellite Box**, a message asks how you connected the satellite box to your TV.



- Select **AV, Component, or HDMI**, then press **ENTER** if you connected a satellite box to your TV using one of these cables. Read the message, then press **ENTER** to close the wizard.
- Select **Coaxial**, then press **ENTER** if you connected a satellite box to your TV using a coaxial cable. Read the message, then press **ENTER** to start the channel scan.

Note

You can press **EXIT** to stop the auto channel search, but you will need to run the auto channel search again to create a channel list.

Hiding channels

You can hide channels in the channel list. When you press **CH**▲ or **CH**▼, your TV skips the hidden channels. You can still tune to a hidden channel by pressing the number buttons for the channel.

To hide channels:

- 1 Press **MENU**. The on-screen menu opens.

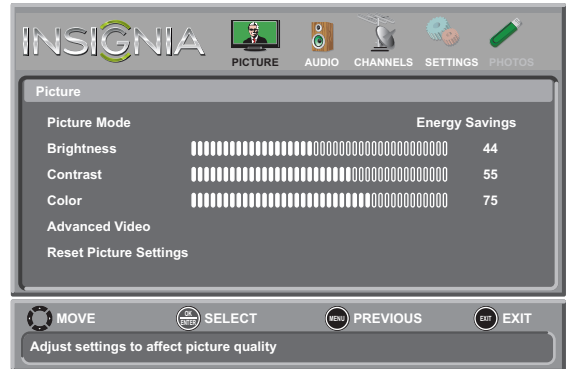

- 2 Press **◀** or **▶** to highlight **CHANNELS**, then press **▼** or **ENTER**. The *Channels* menu opens.

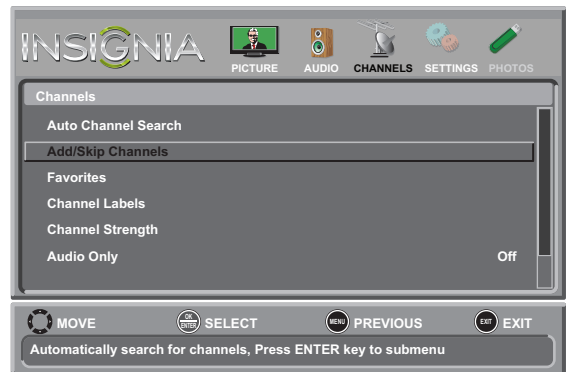

- 3 Press **▲** or **▼** to highlight **Add/Skip Channels**, then press **ENTER**. The *Channels-Add/Skip Channels* screen opens.



- Press **▲ ▼ ◀ ▶** to highlight the channel you want to hide, then press **ENTER**. The check mark disappears.

Notes

- A channel with a check mark is not hidden. A channel with no check mark is hidden.
- If the list has more than one page, press **▲** or **▼** to scroll through the pages.

- Press **MENU** to return to the previous menu, or press **EXIT** to close the menu.

Setting up a favorite channel list

You can create a favorite channel list so you can quickly browse through your favorite channels by pressing **FAVORITE**, then selecting a channel from the favorite channel list.

To set up a favorite channel list:

- Press **MENU**. The on-screen menu opens.

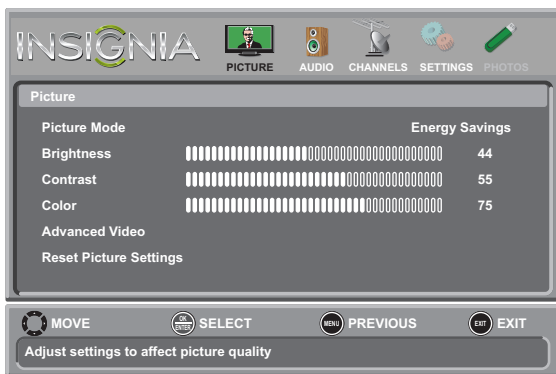

- Press **◀** or **▶** to highlight **CHANNELS**, then press **▼** or **ENTER**. The *Channels* menu opens.

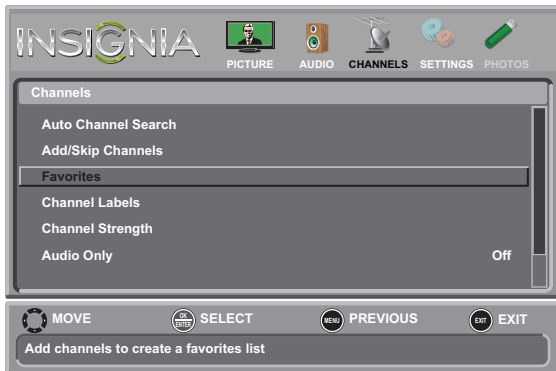

- Press **▲** or **▼** to highlight **Favorites**, then press **ENTER**. The *Channels-Favorites* screen opens.



- Press **▲ ▼ ◀ ▶** to highlight the channel you want to add to the favorites list, then press **ENTER**. A check mark appears next to the channel.

Notes

- To remove a channel from the favorites list, highlight the channel, then press **ENTER**. The check mark disappears and the channel is removed from the list.
- If the list has more than one page, press **▲** or **▼** to scroll through the pages.

- Press **MENU** to return to the previous menu, or press **EXIT** to close the menu.

Viewing a favorite channel

To view a favorite channel:

- Press **FAVORITE**. The favorite channel list opens.
- Press **▲** or **▼** to highlight a channel, then press **ENTER**.

Adding or changing a channel label

If a channel is not already labeled, you can label the channel to make it easier to identify. You can also relabel a channel that is already labeled.

To add or change a channel label:

- Press **MENU**. The on-screen menu opens.

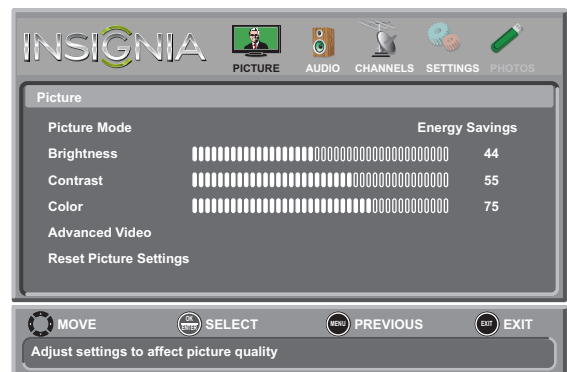

- Press **◀** or **▶** to highlight **CHANNELS**, then press **▼** or **ENTER**. The *Channels* menu opens.



- Press **▲** or **▼** to highlight **Channel Labels**, then press **ENTER**. The *Channels-Channel Labels* screen opens with the channel number field highlighted.



- Press **▲** or **▼** to select the channel you want to label, then press **▶** to move to the channel label field.



- Press **▲** or **▼** to select a character, then press **◀** or **▶** to move to the previous or next character position. Repeat this step to enter additional characters. You can enter as many as 11 characters.
- When you have completed the label, press **MENU**.
- Press **EXIT** to close the menu.

Checking the digital signal strength

You can check the digital signal strength to determine if you need to adjust your antenna or digital cable input. The higher the signal strength, the less likely you are to experience picture degradation.

To check the digital signal strength:

- Press **MENU**. The on-screen menu opens.

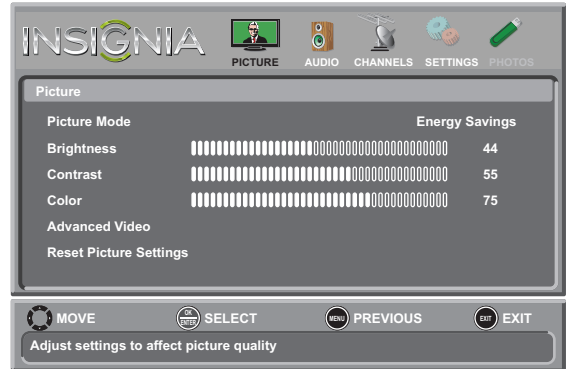

- Press **◀** or **▶** to highlight **CHANNELS**, then press **▼** or **ENTER**. The *Channels* menu opens.



- Press **▲** or **▼** to highlight **Channel Strength**, then press **ENTER**. The signal strength meter is displayed.



- Press **MENU** to return to the previous menu, or press **EXIT** to close the menu.

Setting parental controls

Setting or changing the password

Parental controls let you prevent your children from watching inappropriate material on TV. When set, parental controls read the rating of the program (with some exceptions, such as news and sports) and deny access to programs that exceed the ratings level you select. To watch programs that exceed the selected rating, you must enter a password.

To set or change the password:

- 1 Press **MENU**. The on-screen menu opens.

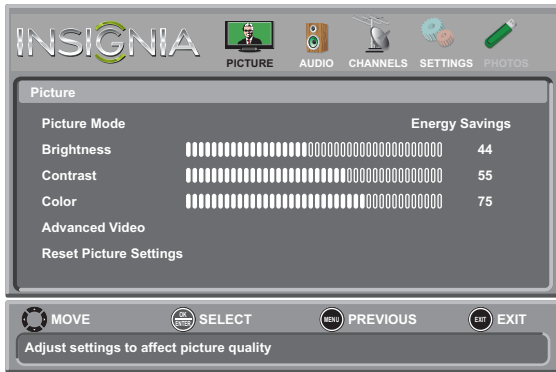

- 2 Press **◀** or **▶** to highlight **SETTINGS**, then press **▼** or **ENTER**. The *Settings* menu opens with **Parental Controls** highlighted.



- 3 Press **ENTER**. The *Enter Password* screen opens.



- 4 Press the number buttons to enter the four-digit password. The default password is **0000**. You should change the password to a number you can remember. The *Settings-Parental Controls* menu opens.



- 5 Press **▲** or **▼** to highlight **Change Password**, then press **ENTER**. The *Settings-Parental Controls-Change Password* screen opens.



- 6 Press the number buttons to enter a password, then enter the password again.

Note

If you forget your password, enter **9999**.

- 7 Press **MENU** to return to the previous menu, or press **EXIT** to close the menu.

Locking control buttons

When the button lock is turned **On**, the buttons on your TV are locked, and you can only operate your TV using the remote control.

To lock control buttons:

- 1 Press **MENU**. The on-screen menu opens.

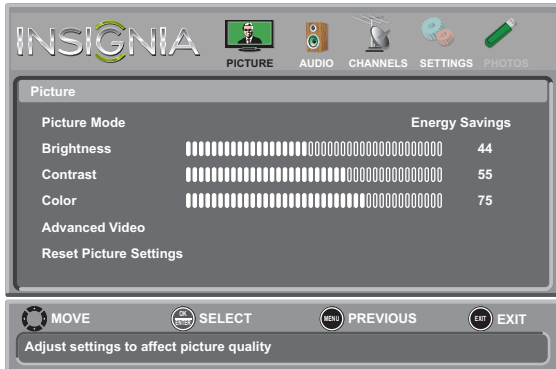

- 2 Press **◀** or **▶** to highlight **SETTINGS**, then press **▼** or **ENTER**. The *Settings* menu opens with **Parental Controls** highlighted.



- 3 Press **ENTER**. The *Enter Password* screen opens.



- 4 Press the number buttons to enter the four-digit password. The *Settings-Parental Controls* menu opens with **Button Lock** highlighted.



- 5 Press **ENTER**.
- 6 Press **▲** or **▼** to select **On** (locks the buttons) or **Off** (unlocks the buttons).
- 7 Press **MENU** to return to the previous menu, or press **EXIT** to close the menu.

Blocking unrated TV

To block unrated TV:

- 1 Press **MENU**. The on-screen menu opens.

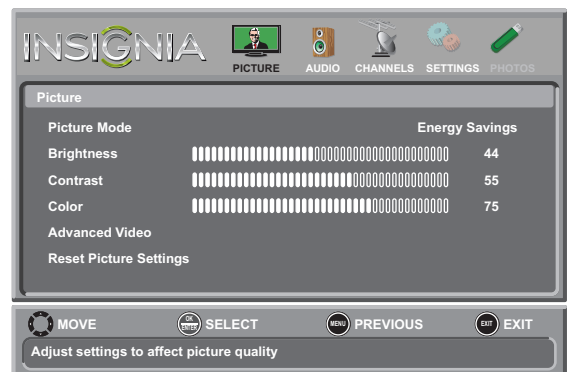

- 2 Press **◀** or **▶** to highlight **SETTINGS**, then press **▼** or **ENTER**. The *Settings* menu opens with **Parental Controls** highlighted.



3 Press **ENTER**. The *Enter Password* screen opens.

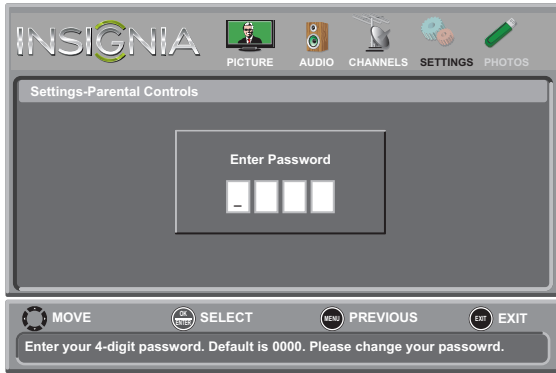

4 Press the number buttons to enter the four-digit password. The *Settings-Parental Controls* menu opens.



- 5 Press **▲** or **▼** to highlight **Block Unrated TV**, then press **ENTER**.
- 6 Press **▲** or **▼** to select **On** (to block unrated TV) or **Off** (to unblock unrated TV).
- 7 Press **MENU** to return to the previous menu, or press **EXIT** to close the menu.

Setting parental control levels

You can set parental controls for the U.S. and Canada.

U.S. rating levels

U.S. TV ratings	
NONE	Not rated
TV-Y	All children
TV-Y7	Suitable for children 7 and older
TV-G	General audiences
TV-PG	Parental guidance suggested
TV-14	Parental guidance strongly suggested
TV-MA	Mature audiences only

Some of the age-based TV Parental Guidelines ratings also have content-based ratings.

U.S. TV content ratings	
All	All ratings are blocked
FV	Fantasy violence
L	Strong language
S	Sexual situations
V	Violence
D	Suggestive dialog

U.S. movie (MPAA) ratings	
None	Movie not rated
G	General audiences
PG	Parental guidance suggested
PG-13	Suitable for children 13 and older
R	Parental guidance suggested for children under 17
NC-17	Not suitable for children under 17
X	Adults only

Canadian rating levels

Canadian English ratings	
E	Exempt programming
C	Suitable for all children
C8+	Suitable for children 8 and older
G	General audiences
PG	Parental guidance suggested
14+	Suitable for children 14 and older
18+	Adult only

Canadian French ratings	
E	Exempt programming
G	General audiences
8ans+	Suitable for children 8 and older
13ans+	Suitable for children 13 and older
16ans+	Suitable for children 16 and older
18ans+	Adult only

To set parental control levels:

1 Press **MENU**. The on-screen menu opens.

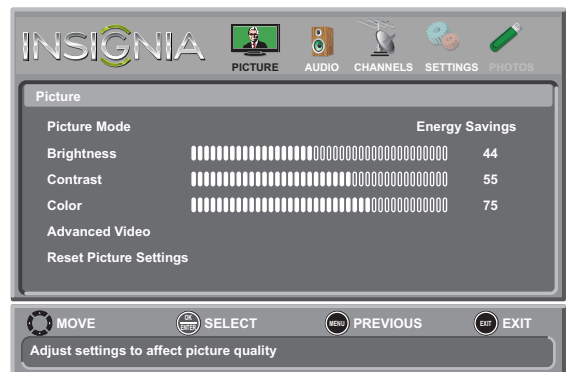

- Press **◀** or **▶** to highlight **SETTINGS**, then press **▼** or **ENTER**. The *Settings* menu opens with **Parental Controls** highlighted.

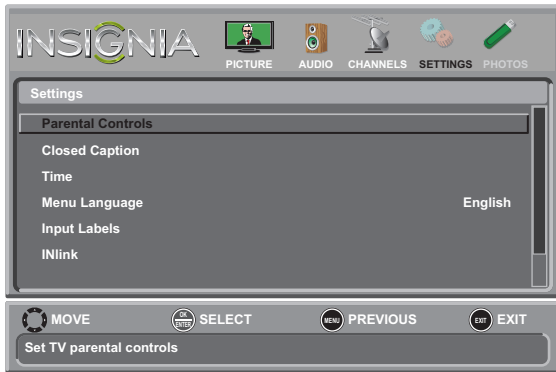

- Press **ENTER**. The *Enter Password* screen opens.



- Press the number buttons to enter the four-digit password. The *Settings-Parental Controls* menu opens.



- Press **▲** or **▼** to highlight **USA Parental Locks**, then press **ENTER**. (To set Canadian ratings, select **Canadian Parental Locks**.)

USA Parental Locks

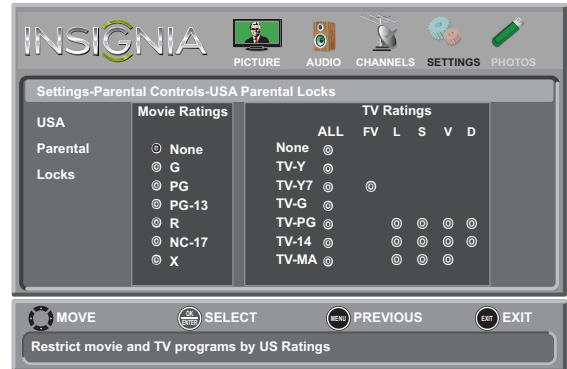

Canadian Parental Locks



- Press **◀** or **▶** to highlight:
 - Movie Ratings** or **TV Ratings** for USA ratings.
 - English Rating** or **French Rating** for Canadian ratings.
- Press **▲** or **▼** to select the rating. If a rating has sub-ratings, press **◀** or **▶** to highlight a sub-rating.

Note

When you block a rating, that rating and all higher ratings are blocked.

- Press **ENTER** to confirm. A lock symbol appears when a rating is blocked.
- Press **MENU** to return to the previous menu, or press **EXIT** to close the menu.

Downloading rating information

You can download rating information to use when setting parental controls.

To download rating information:

- 1 Press **MENU**. The on-screen menu opens.

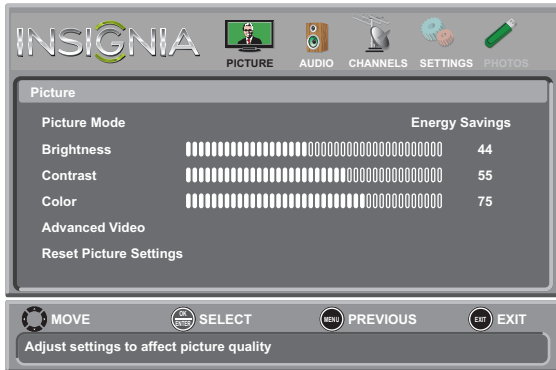

- 2 Press **◀** or **▶** to highlight **SETTINGS**, then press **▼** or **ENTER**. The *Settings* menu opens with **Parental Controls** highlighted.

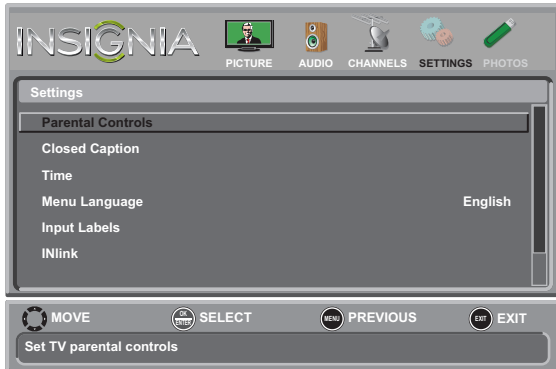

- 3 Press **ENTER**. The *Enter Password* screen opens.



- 4 Press the number buttons to enter the four-digit password. The *Settings-Parental Controls* menu opens.



- 5 Press **▲** or **▼** to highlight **RRT5**, then press **ENTER**.

If the program is broadcast with RRT5 rating information, the information is downloaded automatically and can be used for parental controls.

- 6 Press **MENU** to return to the previous menu, or press **EXIT** to close the menu.

Using closed captioning

Turning closed captioning on or off

To turn closed captioning on or off:

- 1 Press **MENU**. The on-screen menu opens.

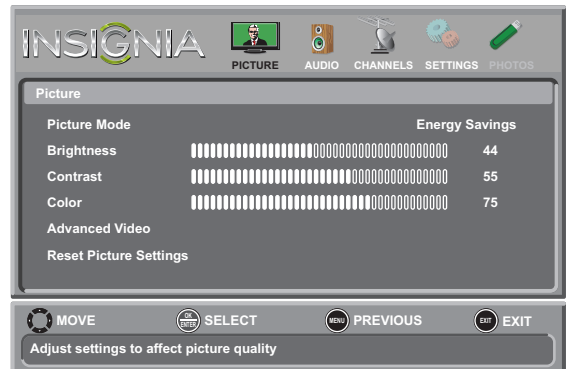

- 2 Press **◀** or **▶** to highlight **SETTINGS**, then press **▼** or **ENTER**. The *Settings* menu opens.



- Press **▲** or **▼** to highlight **Closed Caption**, then press **ENTER**. The *Settings-Closed Caption* menu opens.



- Press **▲** or **▼** to highlight **Closed Caption**, then press **ENTER**. The *Settings-Closed Caption* menu opens.



- Press **▲** or **▼** to highlight **CC Mode**, then press **ENTER**.
- Press **▲** or **▼** to select **CC Off** (turns off closed captioning), **CC On** (turns on closed captioning), or **CC On When Mute** (turns on closed captioning when the sound is muted).
- Press **MENU** to return to the previous menu, or press **EXIT** to close the menu.

Note

You can also press **CCD** to turn closed captioning on or off.

- Press **▲** or **▼** to highlight **Analog Caption**, then press **ENTER**. A menu opens.

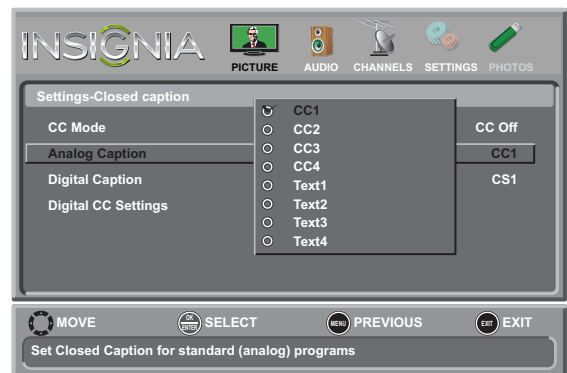

Selecting the analog closed captioning mode

To select the analog closed captioning mode:

- Press **MENU**. The on-screen menu opens.

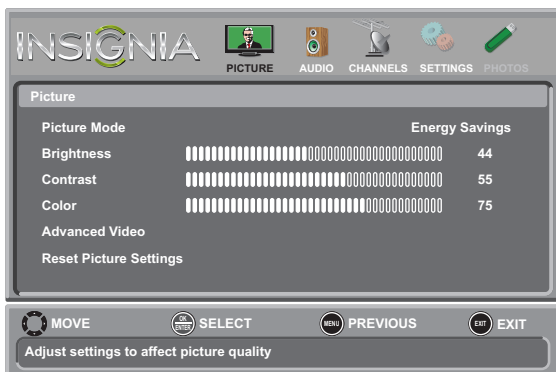

- Press **◀** or **▶** to highlight **SETTINGS**, then press **▼** or **ENTER**. The *Settings* menu opens.



- Press **▲** or **▼** to select an analog caption setting. You can select:
 - CC1** through **CC4**—Closed captioning appears in a small banner across the bottom of the screen. **CC1** is usually the “printed” version of the audio. **CC2** through **CC4** display content provided by the broadcaster.
 - Text1** through **Text4**—Closed captioning covers half or all of the screen. **Text1** through **Text4** display content provided by the broadcaster.

- Press **MENU** to return to the previous menu, or press **EXIT** to close the menu.

Customizing digital closed captioning styles

To customize digital closed captioning styles:

- Press **MENU**. The on-screen menu opens.

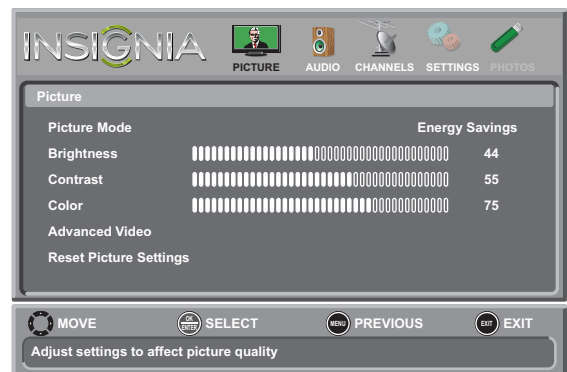

- Press **◀** or **▶** to highlight **SETTINGS**, then press **▼** or **ENTER**. The *Settings* menu opens.



- Press **▲** or **▼** to highlight **Closed Caption**, then press **ENTER**. The *Settings-Closed Caption* menu opens.



- Press **▲** or **▼** to highlight **Digital Caption**, then press **ENTER**. A menu opens.
- Press **▲** or **▼** to highlight a digital caption setting, then press **ENTER**. You can select **CS1** through **CS6** and **CC1** through **CC4**.
- Press **MENU** to return to the previous menu.

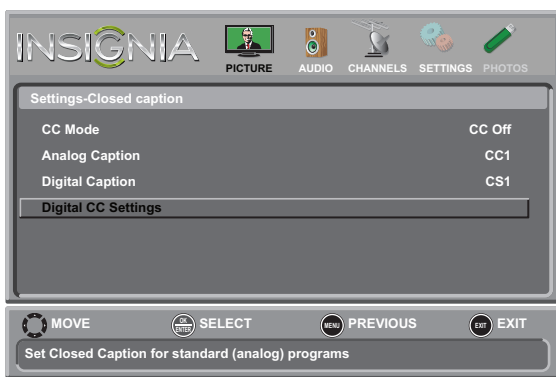

- Press **▲** or **▼** to highlight **Digital CC Settings**, then press **ENTER**. The *Settings-Closed Caption-Digital CC Settings* menu opens with **Style** highlighted.

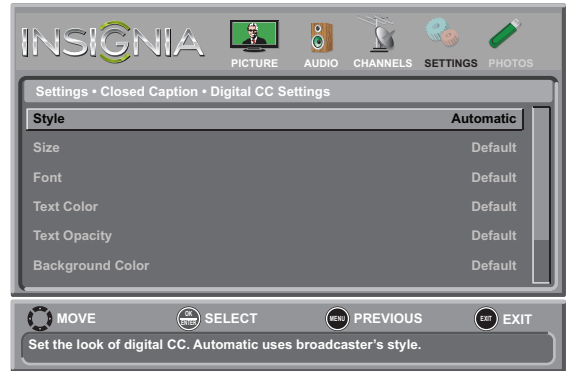

- Press **ENTER**, then press **◀** or **▶** to select **Custom**.
- Press **▲** or **▼** to highlight an option, then press **ENTER**. You can select:
 - Size**—Selects the font size.
 - Font**—Selects the font style.
 - Text Color**—Selects the color for the words.
 - Text Opacity**—Selects the opacity level for the words.
 - Background Color**—Selects the color for the background.
 - Background Opacity**—Selects the opacity level for the background.
 - Edge Effect**—Selects the edge style.
 - Edge Color**—Selects the edge color.
- Press **MENU** to return to the previous menu, or press **EXIT** to close the menu.

Adjusting time settings

Setting the clock

To set the clock:

- Press **MENU**. The on-screen menu opens.

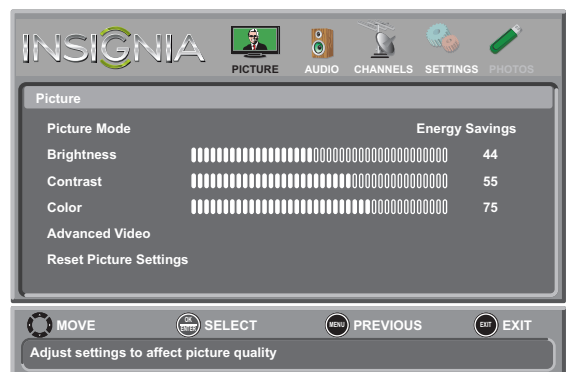

- Press **◀** or **▶** to highlight **SETTINGS**, then press **▼** or **ENTER**. The *Settings* menu opens.



- Press **▲** or **▼** to highlight **Time**, then press **ENTER**. The *Settings-Time* menu opens with **Date/Time** highlighted.

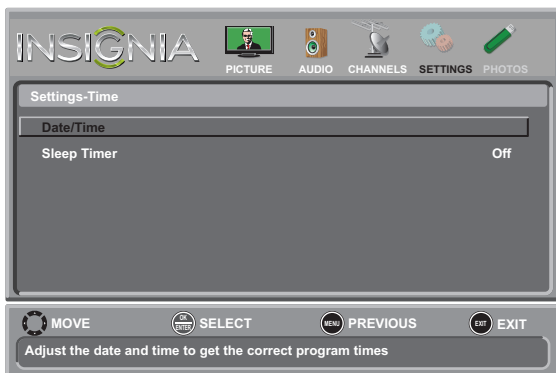

- Press **ENTER**. The *Settings-Time-Date/Time* menu opens with **Auto Sync** highlighted.

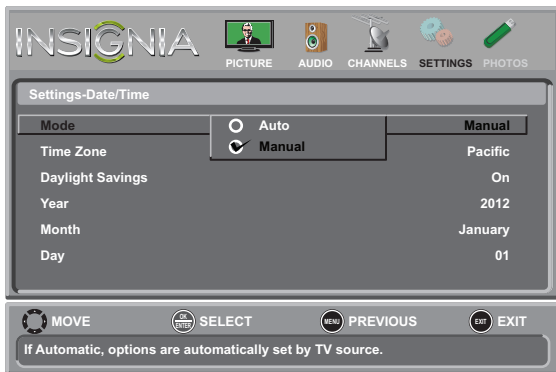

- Press **ENTER**, then press **▲** or **▼** to highlight **Manual** (to set the options manually) or **Auto** (the options are automatically set by the TV signal source).
- Press **ENTER** to close the menu.
- Press **▲** or **▼** to highlight **Time Zone**, then press **ENTER**. The *Time-Time Zone* menu opens.
- Press **▲** or **▼** to select your time zone, then press **ENTER**. You can select **Atlantic, Eastern, Central, Mountain, Pacific, Alaska, Hawaii, or Newfoundland**.

- Press **ENTER** to close the menu.
- If your viewing area observes daylight savings time, press **▲** or **▼** to highlight **Daylight Savings**, then press **ENTER**.
- Press **▲** or **▼** to select **On** or **Off**, then press **ENTER** to close the menu.
- If you selected **Manual** for **Mode**:
 - Press **▲** or **▼** to highlight **Year, Month, or Day**, then press **◀** or **▶** to adjust the setting, then press **ENTER**.
 - Press **▲** or **▼** to highlight **Time**, press **◀** or **▶** to highlight the hour, minute, or AM/PM field, then press **▲** or **▼** to adjust the setting. When you are finished, press **ENTER**.
- Press **MENU** to return to the previous menu, or press **EXIT** to close the menu.

Setting the sleep timer

You can specify the amount of time before your TV automatically turns off.

To set the sleep timer:

- Press **MENU**. The on-screen menu opens.

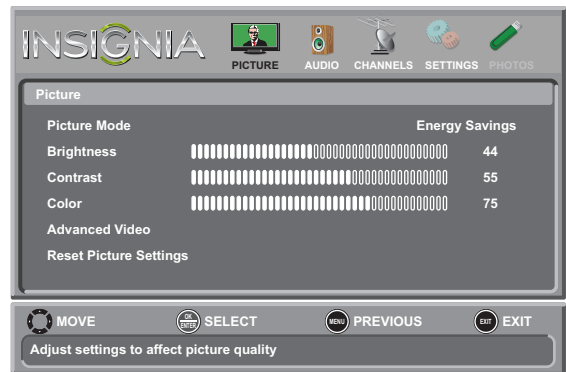

- Press **◀** or **▶** to highlight **SETTINGS**, then press **▼** or **ENTER**. The *Settings* menu opens.



- 3 Press **▲** or **▼** to highlight **Time**, then press **ENTER**. The *Settings-Time* menu opens.



- 2 Press **◀** or **▶** to highlight **SETTINGS**, then press **▼** or **ENTER**. The *Settings* menu opens.



- 4 Press **▲** or **▼** to highlight **Sleep Timer**, then press **ENTER**. A menu opens.
- 5 Press **▲** or **▼** to select the amount of time before your TV turns off automatically. You can select **Off, 5, 10, 15, 30, 60, 90, 120, 180, or 240** minutes.
To turn off the sleep timer, select **Off**.
- 6 Press **MENU** to return to the previous menu, or press **EXIT** to close the menu.

Note
You can also press **SLEEP** to set the sleep timer.

- 3 Press **▲** or **▼** to highlight **Menu Language**, then press **ENTER**. A menu opens.



Adjusting menu settings

Selecting the menu language

To select the menu language:

- 1 Press **MENU**. The on-screen menu opens.

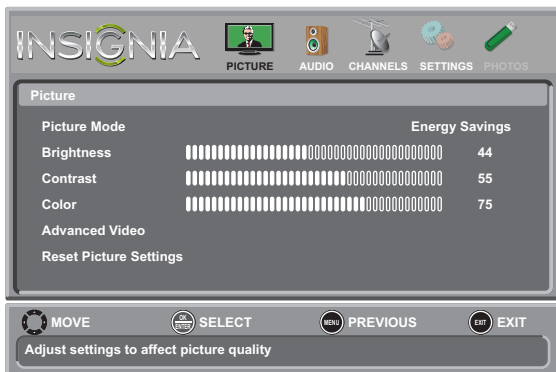

- 4 Press **▲** or **▼** to highlight a language, then press **ENTER**. You can select **English, Français, or Español**.
- 5 Press **MENU** to return to the previous menu, or press **EXIT** to close the menu.

Labeling an input source

You can add a label to an input source to make it easier to identify.

To label an input source:

- 1 Press **MENU**. The on-screen menu opens.

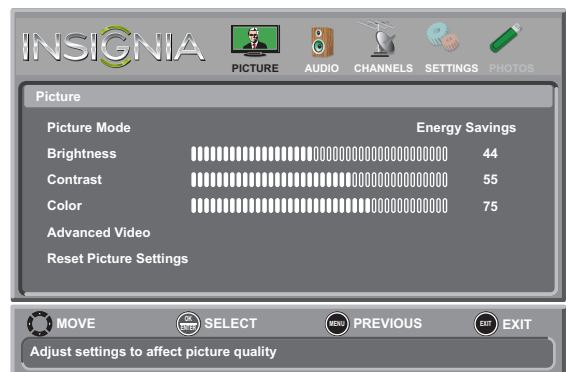

- Press **◀** or **▶** to highlight **SETTINGS**, then press **▼** or **ENTER**. The *Settings* menu opens.



- Press **▲** or **▼** to highlight **Input Labels**, then press **ENTER**. The *Settings-Input Labels* screen opens with the input source field highlighted.



- Press **▲** or **▼** to select the input source you want to label, then press **▶** to move to the custom label field.



- Press **▲** or **▼** to select a character, then press **◀** or **▶** to move to the previous or next character position. Repeat this step to enter additional characters. You can enter as many as 11 characters.
- When you have completed the label, press **ENTER**.
- Press **MENU** to return to the previous menu or press **EXIT** to close the menu. The next time you press **INPUT**, your label appears in the *INPUT SOURCE* list.

Restoring settings to the defaults

When you restore default settings, all the settings you have customized (except the password and parental rating) are reset.

To restore settings to the defaults:

- Press **MENU**. The on-screen menu opens.

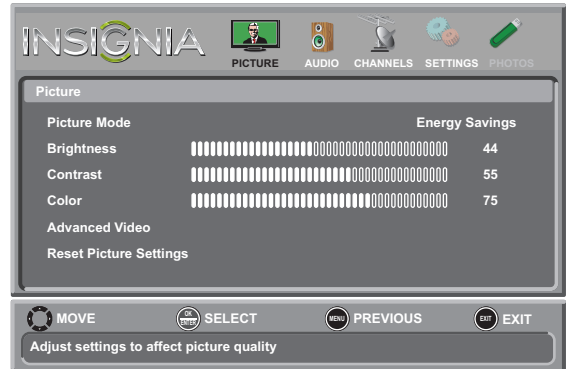

- Press **◀** or **▶** to highlight **SETTINGS**, then press **▼** or **ENTER**. The *Settings* menu opens.



- Press **▲** or **▼** to highlight **Reset to Default**, then press **ENTER**. The *Settings-Reset to Default* menu opens.

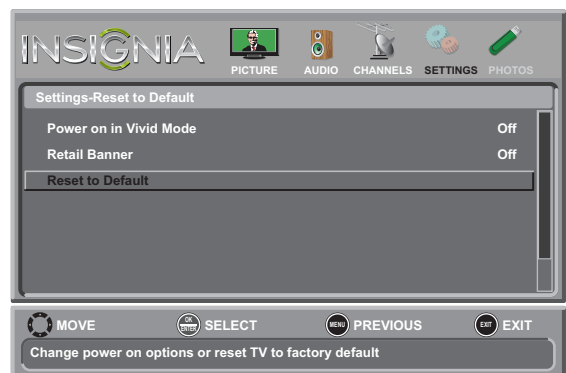

- Press **▲** or **▼** to highlight **Reset to Default**, then press **ENTER**. A confirmation message opens.
- Press **◀** or **▶** to select **Yes** (to reset) or **No** (to not reset), then press **ENTER**.
- Press **MENU** to return to the previous menu, or press **EXIT** to close the menu.

Using INlink

INlink lets you control HDMI CEC-compatible devices connected to the HDMI jacks on your TV using the remote control that came with your TV. To use INlink, you must set the **INlink Control** setting on the *Settings-INlink* menu to **On**.

Note

- HDMI cables must be used to connect HDMI CEC-compatible devices to your TV.
- The connected device's HDMI CEC feature must be turned on.
- If you connect an HDMI device that is not HDMI CEC-compatible, all the **INlink Control** features do not work.
- Depending on the connected HDMI device, the **INlink Control** feature may not work.

Turning INlink on or off

To turn INlink on or off:

- 1 Press **MENU**. The on-screen menu opens.

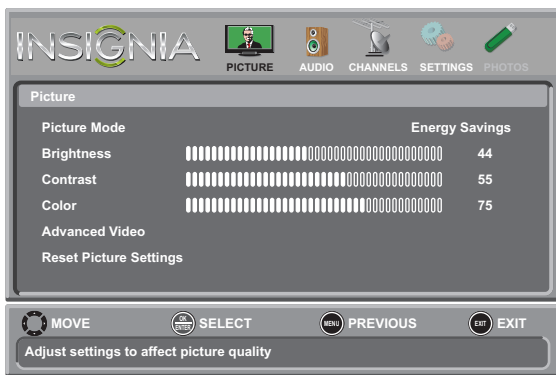

- 2 Press **◀** or **▶** to highlight **SETTINGS**, then press **▼** or **ENTER**. The *Settings* menu opens.



- 3 Press **▲** or **▼** to highlight **INlink**, then press **ENTER**. The *Settings-INlink* menu opens.

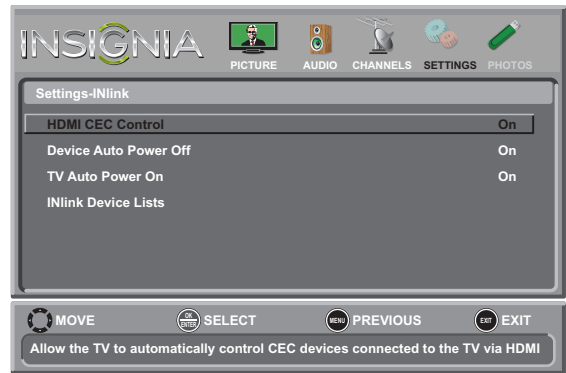

- 4 Press **▲** or **▼** to highlight **HDMI CEC Control**, then press **ENTER**.
- 5 Press **▲** or **▼** to highlight **On** or **Off**, then press **ENTER**.
- 6 Press **MENU** to return to the previous menu, or press **EXIT** to close the menu.

Turning Device Auto Power Off on or off

When INlink is turned on, **Device Auto Power Off** turns off HDMI CEC devices when you turn off your TV.

To turn Device Auto Power Off on or off:

- 1 Press **MENU**. The on-screen menu opens.

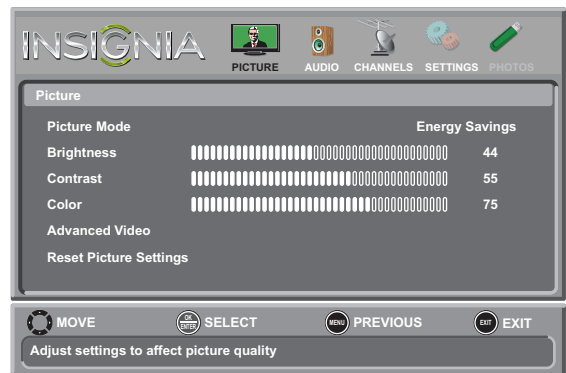

- 2 Press **◀** or **▶** to highlight **SETTINGS**, then press **▼** or **ENTER**. The *Settings* menu opens.



- 3 Press **▲** or **▼** to highlight **INlink**, then press **ENTER**. The *Settings-INlink* menu opens.

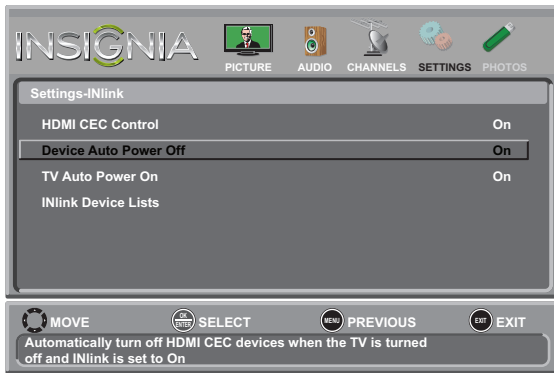

- 4 Press **▲** or **▼** to highlight **Device Auto Power Off**, then press **ENTER**.
- 5 Press **▲** or **▼** to highlight **On** (turns off the connected devices when you turn off your TV) or **Off** (does not turn off the connected devices when you turn off your TV), then press **ENTER**.
- 6 Press **MENU** to return to the previous menu, or press **EXIT** to close the menu.

- 3 Press **▲** or **▼** to highlight **INlink**, then press **ENTER**. The *Settings-INlink* menu opens.

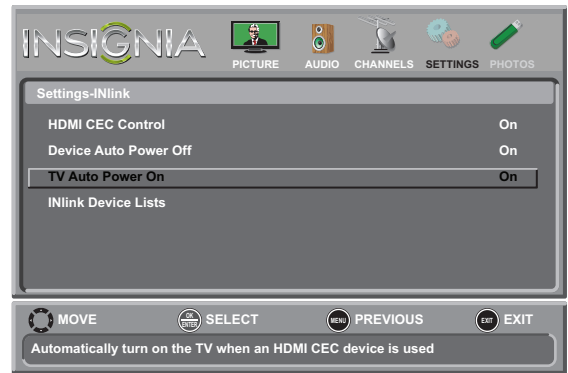

- 4 Press **▲** or **▼** to highlight **TV Auto Power On**, then press **ENTER**.
- 5 Press **▲** or **▼** to highlight **On** (turns on your TV when you turn on the connected device) or **Off** (does not turn on your TV when you turn on the connected device), then press **ENTER**.
- 6 Press **MENU** to return to the previous menu, or press **EXIT** to close the menu.

Turning TV Auto Power On on or off

When INlink is turned on and you turn on an HDMI CEC device, **TV Auto Power On** turns on your TV automatically.

To turn TV Auto Power On on or off:

- 1 Press **MENU**. The on-screen menu opens.

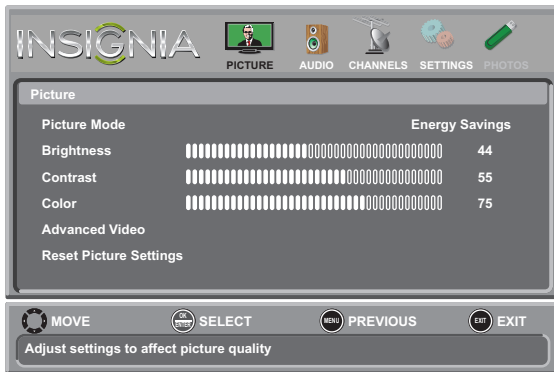

- 2 Press **◀** or **▶** to highlight **SETTINGS**, then press **▼** or **ENTER**. The *Settings* menu opens.



Displaying a list of INlink-compatible (HDMI CEC) devices

You can display a list of HDMI CEC devices that are connected to your TV.

To display a list of INlink-compatible (HDMI CEC) devices:

- 1 Press **MENU**. The on-screen menu opens.

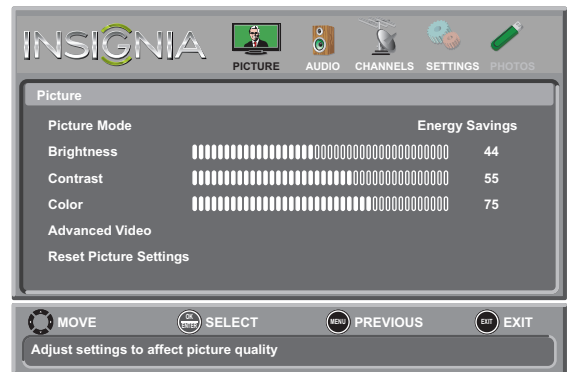

- 2 Press **◀** or **▶** to highlight **SETTINGS**, then press **▼** or **ENTER**. The *Settings* menu opens.



- Press **▲** or **▼** to highlight **INlink**, then press **ENTER**. The *Settings-INlink* menu opens.



- Press **▲** or **▼** to highlight **INlink Device Lists**, then press **ENTER**. A list of the HDMI CEC-compatible devices you have connected appears.
- Press **MENU** to return to the previous menu, or press **EXIT** to close the menu.

Using a USB flash drive

You can connect a USB flash drive to your TV to view compatible JPEG pictures.

Notes

- Never remove the USB flash drive or turn off your TV while viewing JPEG pictures.
- The JPEG picture viewer only supports JPEG format images (with ".jpg" file extensions) and not all JPEG files are compatible with your TV.

Switching to USB mode

To switch to USB mode:

- Make sure that you have connected the USB flash drive to the USB port on your TV.
- Press **INPUT**. The *INPUT SOURCE* list opens.
- Press **▲** or **▼** to highlight **USB(Photos)**, then press **ENTER**.

Note

To exit USB mode, press **INPUT** to open the *INPUT SOURCE* list, then select another input source, or press a Quick Launch Input button.

Browsing photos

To browse photos:

- Switch to USB mode. See "[Switching to USB mode](#)" on page 45. The on-screen menu opens with the *Photos* menu selected.

Note

You can also press **MENU** to open the *PHOTO* menu.



- Press **▲** or **▼** to highlight **Browse Photos**, then press **ENTER**. The screen displays folder names and photo files stored on the USB flash drive in a thumbnail index with the first photo or folder highlighted. A control bar appears at the bottom of the screen.

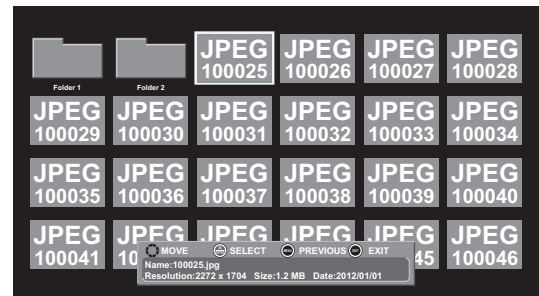

- To navigate the thumbnail index screen, press:
 - ▲ ▼ ◀ ▶** to browse through the files and folders.
 - ENTER** to view a highlighted photo full-screen or open a highlighted folder.
 - MENU** to open the *PHOTO* menu.
 - FAVORITE** to add or remove a photo from the favorite photo list. A heart appears on a photo that has been added to the favorite photo list.

When a photo is displayed full-screen, a control bar appears at the bottom of the photo. The file name, picture resolution, size, and date are displayed on the bottom of the control bar. If you do not press a button within 10 seconds, the control bar closes. Press any button to open the control bar again.

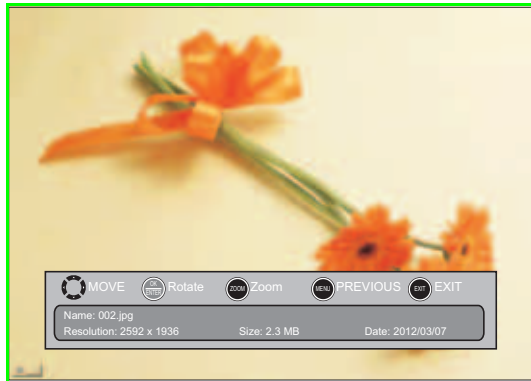

- To navigate on the photo screen, press:
 - ◀ or ▲ to go to the previous photo.
 - ▶ or ▼ to go to the next photo.
 - ENTER** to rotate the photo clockwise.
 - ZOOM** one or more times to enlarge the image by 1x, 2x, or 4x or select **Fill** (to fill the screen). You can press ▲ ▼ ◀ or ▶ to pan the photo.
 - EXIT** to return to the thumbnail index.
 - MENU** to return to the *Photos* menu.

Viewing favorite photos

After you created your favorite photo list, you can browse among your favorite photos quickly.

To view favorite photos:

- Switch to USB mode. See "[Switching to USB mode](#)" on page 45. The on-screen menu opens with the *Photos* menu selected.

Note

You can also press **MENU** to open the *Photos* menu.



- Press ▲ or ▼ to highlight **Favorite Photos**, then press **ENTER**. A thumbnail index of your favorite photos opens with a control bar at the bottom of the screen.

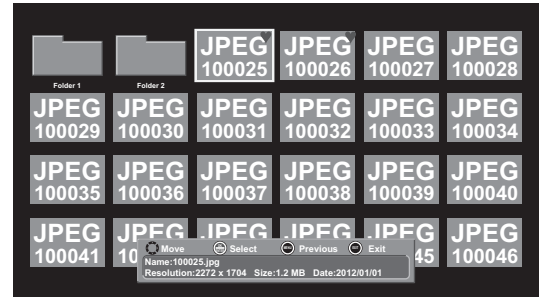

You select photos and navigate on the photo screen in the same way you do when you are browsing through photos. For more information, see "[Browsing photos](#)" on page 45.

Viewing photos in a slideshow

You can view your photos in a slideshow.

To view photos in a slideshow:

- Switch to USB mode. See "[Switching to USB mode](#)" on page 45. The on-screen menu opens with the *Photos* menu selected.

Note

You can also press **MENU** to open the *Photos* menu.



- Press ▲ or ▼ to highlight **View Slideshow**, then press **ENTER**. A slideshow starts with the first photo in the current folder.
- To control the slideshow, press:
 - ENTER** to pause or start the slideshow.
 - EXIT** to exit the slideshow and return to thumbnail index.
 - MENU** to go to the *PHOTO* menu.

Customizing slideshow settings

You can customize the slideshow settings, including **Repeat**, **Shuffle**, **Speed**, and **Transition**.

To customize slideshow settings:

- 1 Switch to USB mode. See [“Switching to USB mode”](#) on page 45. The on-screen menu opens with the *Photos* menu selected.

Note

You can also press **MENU** to open the *Photos* menu.



- 2 Press **▲** or **▼** to highlight **Settings**, then press **ENTER**. The *Photos-Settings* menu opens.

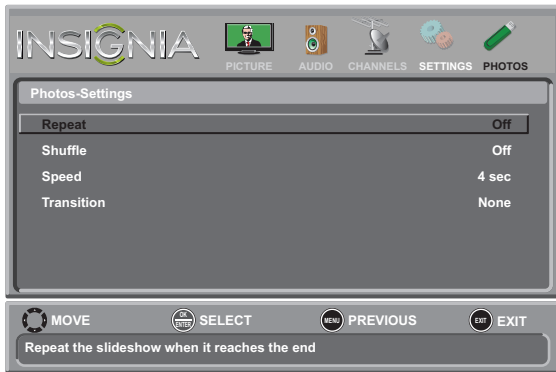

- 3 Press **▲** or **▼** to highlight an option, then press **ENTER**. You can select:
 - **Repeat**—Repeats the slideshow when it reaches the end. You can select **On** or **Off**.
 - **Shuffle**—Displays the slideshow photos in random order. You can select **On** or **Off**.
 - **Speed**—Sets the amount of time a photo is displayed before the slideshow moves to the next photo. You can select **4 Sec**, **6 Sec**, or **8 Sec**.
 - **Transition**—Selects the way photos transition when moving to the next file in the slideshow. You can select:
 - **None**—No transition effect.
 - **Fade to Black**—Fades the screen to black between photos.
 - **Vertical Wipe**—Wipes the screen from top to bottom between photos.
 - **Horizontal Wipe**—Wipes the screen from left to right between photos.
 - **Random**—Randomly selects a transition effect.
- 4 Press **EXIT** to close the menu.

Maintaining

- Do not use your TV in areas that are too hot or too cold, because the cabinet may warp or the screen may malfunction. Your TV works best in temperatures that are comfortable to you.
- Storage temperatures are 32° to 122°F (0° to 50°C).
- Working temperatures are 41° to 104°F (5° to 40°C).
- Do not place your TV in direct sunlight or near a heat source.

Cleaning the TV cabinet

Clean the cabinet with a soft, lint-free cloth. If the cabinet is especially dirty, moisten a soft, lint-free cloth in a weak detergent solution, squeeze the excess moisture from the cloth, then wipe the cabinet with the cloth. Use a clean cloth to dry the cabinet.

Cleaning the TV screen

Clean the screen with a soft, lint-free cloth.

Troubleshooting

Warning

Do not try to repair your TV yourself. Contact authorized service personnel.

Video and audio

Problem	Solution
Picture does not fill the screen. There are black bars around the picture.	<ul style="list-style-type: none"> • Change the aspect ratio. An increasing amount of digital TV and movies are presented in wide screen (16:9). See “Aspect ratio options” on page 25.
No picture (screen is not lit) and no sound.	<ul style="list-style-type: none"> • Press ⏻ on the TV or the remote control. • Make sure that the Audio Only option is set to Off. See “Playing TV audio only” on page 28. • Make sure that the video cables are connected securely to your TV. • Adjust the contrast and brightness. See “Adjusting the TV picture” on page 24. • Make sure that the power cord is plugged in. • Make sure that the correct video input source is selected. See “Selecting the video input source” on page 22. • Try another channel. The station may be experiencing problems. • Make sure that the incoming signal is compatible. • Make sure that the antenna or cable TV is connected correctly and securely. See “Connecting a cable or satellite box” on page 9 or “Connecting an antenna or cable TV (no box)” on page 12. • Check the closed caption settings. Some TEXT modes can block the screen.

Problem	Solution
Dark, poor, or no picture (screen is lit), but sound is good.	<ul style="list-style-type: none"> Try another channel. The station may be experiencing problems. Make sure that the antenna or cable TV is connected correctly and securely. See "Connecting a cable or satellite box" on page 9 or "Connecting an antenna or cable TV (no box)" on page 12. Adjust the brightness. See "Adjusting the TV picture" on page 24. Make sure that the correct picture mode is selected. See "Adjusting the TV picture" on page 24. If you are using an antenna, the digital channel signal may be low. To check the digital channel signal strength, see "Checking the digital signal strength" on page 32. If you are using an antenna and the signal strength is low, adjust the antenna or use a highly directional outdoor antenna or set-top antenna with a built-in amplifier. Make sure that the video cables are connected securely to your TV. The video cable(s) you are using may be bad. Try a new set. Try another channel. The station may be experiencing problems.
No color, dark picture, or color is not correct.	<ul style="list-style-type: none"> Try another channel. The station may be experiencing problems. Adjust the color settings. See "Adjusting the TV picture" on page 24. Make sure that the video cables are connected correctly and securely to your TV. Make sure that the antenna or cable TV is connected correctly and securely. See "Connecting a cable or satellite box" on page 9 or "Connecting an antenna or cable TV (no box)" on page 12. If you are using an antenna, the digital channel signal may be low. To check the digital channel signal strength, see "Checking the digital signal strength" on page 32. If you are using an antenna and the signal strength is low, adjust the antenna or use a highly directional outdoor antenna or set-top antenna with a built-in amplifier.
Only snow (noise) appears on the screen.	<ul style="list-style-type: none"> Try another channel. The station may be experiencing problems. Make sure that the antenna or cable TV is connected correctly and securely. See "Connecting a cable or satellite box" on page 9 or "Connecting an antenna or cable TV (no box)" on page 12. If you are using an antenna, the digital channel signal may be low. To check the digital channel signal strength, see "Checking the digital signal strength" on page 32. If you are using an antenna and the signal strength is low, adjust the antenna or use a highly directional outdoor antenna or set-top antenna with a built-in amplifier.
Picture quality is good on some channels and poor on others. Sound is good.	<ul style="list-style-type: none"> The problem may be caused by a poor or weak signal from the broadcaster or cable TV provider. If you connect to cable or satellite TV without a set-top box and experience poor picture quality, you may need to install a set-top box to improve signal reception and picture quality. Contact your cable or satellite TV provider about upgrading to a set-top box.

Problem	Solution
Dotted lines or stripes appear on the screen.	<ul style="list-style-type: none"> Make sure that the antenna or cable TV is connected correctly and securely. See "Connecting a cable or satellite box" on page 9 or "Connecting an antenna or cable TV (no box)" on page 12. If you are using an antenna, the digital channel signal may be low. To check the digital channel signal strength, see "Checking the digital signal strength" on page 32. If you are using an antenna and the signal strength is low, adjust the antenna or use a highly directional outdoor antenna or set-top antenna with a built-in amplifier. Make sure that the video cables are connected securely to your TV. The video cable(s) you are using may be bad. Try a new set. Other devices (for example, a surround sound receiver, external speakers, fans, or hair dryers) may be interfering with your TV. Try turning off one device at a time to determine which device is causing interference. After you have determined which device is causing interference, move it further from the TV to eliminate the interference.
Double images.	<ul style="list-style-type: none"> Use a highly directional outdoor antenna, cable TV, or satellite TV.
The picture has a few bright or dark spots.	<ul style="list-style-type: none"> A few bright or dark spots on an LCD screen is normal. It does not affect the operation of your TV.
Good picture, but no sound.	<ul style="list-style-type: none"> Increase the volume. Make sure that the sound is not muted. Make sure you do not have headphones connected. When headphones are connected, no sound comes from the TV speakers. Make sure that the correct audio mode is selected. Make sure that the audio cables are connected correctly and securely to your TV. Make sure that the antenna or cable TV is connected correctly and securely. See "Connecting a cable or satellite box" on page 9 or "Connecting an antenna or cable TV (no box)" on page 12. If you are using an antenna, the digital channel signal may be low. To check the digital channel signal strength, see "Checking the digital signal strength" on page 32. The audio cable(s) you are using may be bad. Try a new set.
Poor picture.	<ul style="list-style-type: none"> Make sure that the room is not too bright. Light reflecting off the screen can make the picture difficult to see. If an S-VHS camera or a camcorder is connected while another connected device is turned on, the picture may be poor. Turn off one or more devices.
Good sound but poor color.	<ul style="list-style-type: none"> Adjust the contrast, color, and brightness settings. See "Adjusting the TV picture" on page 24.
Audio noise.	<ul style="list-style-type: none"> Other devices (for example, a surround sound receiver, external speakers, fans, or hair dryers) may be interfering with your TV. Try turning off one device at a time to determine which device is causing interference. After you have determined which device is causing interference, move it further from the TV to eliminate the interference.

Problem	Solution
No output from one of the speakers.	<ul style="list-style-type: none"> Adjust the audio balance. See "Adjusting sound settings" on page 27. Make sure that the audio cables are connected correctly and securely to your TV.
After images appear.	<ul style="list-style-type: none"> Do not display a still image, such as a logo, game, or computer image, for an extended period of time. This can cause a permanent after-image to be burned into the screen. This type of damage is not covered by your warranty.

Remote control

Problem	Solution
Remote control does not work.	<ul style="list-style-type: none"> Make sure that the power cord is correctly connected to your TV and a power outlet. Make sure that there are no obstructions between the remote control and the remote control sensor on the front of the TV. Point the remote control directly at the remote control sensor on your TV. For the location of the remote control sensor, see "Aiming the remote control" on page 19. The supplied batteries are wrapped tightly in clear plastic. Make sure that you have removed this plastic from the batteries. Make sure that the batteries are installed correctly. See "Installing remote control batteries" on page 19. Replace dead batteries with new batteries. See "Installing remote control batteries" on page 19.
Trouble programming your existing universal remote control.	<ul style="list-style-type: none"> See instructions and a table of common codes in "Programming a different universal remote control" on page 51. Codes are subject to change. For up-to-date codes, go to www.insigniaproducts.com/remotecodes. Replace dead batteries with new batteries. See "Installing remote control batteries" on page 19. Refer to the User Guide that accompanied your universal remote control and contact the manufacturer if problems persist.

General

Problem	Solution
No power.	<ul style="list-style-type: none"> Make sure that the power cord is correctly connected to your TV and a power outlet. Unplug the power cord, wait 60 seconds, then plug the cord back in and turn on your TV. Other devices (for example, a surround sound receiver, external speakers, fans, or hair dryers) may be interfering with your TV. Try turning off one device at a time to determine which device is causing interference. After you have determined which device is causing interference, move it further from the TV to eliminate the interference.
"No signal" error message is displayed.	<ul style="list-style-type: none"> Press INPUT and make sure that you have selected the correct input for the device or service you are trying to use. If you are using a cable or satellite box, use the remote that came with that box to change channels. Make sure that you have the correct input selected to view channels from the cable or satellite box.

Problem	Solution
After Auto Channel Search, there are no channels.	<ul style="list-style-type: none"> Reception can vary by channel depending on the broadcast power level of a given station. Contact your cable or satellite TV provider. Make sure the antenna or cable/satellite TV is connected securely to your TV. Try replacing the cable between the antenna/cable or cable/satellite box and your TV.
One or more channels do not display.	<ul style="list-style-type: none"> Make sure that the channels are not blocked. See "Setting parental control levels" on page 35. Make sure that the channels are not hidden. The channel may have been deleted from the channel list. You can tune to the channel by pressing the number buttons or you can add the channel back to the channel list. See "Hiding channels" on page 30. If you are using a cable or satellite box, use the remote that came with that box to change channels. Make sure that you have the correct input selected to view channels from the cable or satellite box. If you are using an antenna, the digital channel signal may be low. To check the digital channel signal strength, see "Checking the digital signal strength" on page 32.
Password is lost.	<ul style="list-style-type: none"> Enter 9999 to access parental controls, then set a new password. See "Setting or changing the password" on page 33.
Some settings cannot be accessed.	<ul style="list-style-type: none"> If a setting is grayed, the setting is not available in the current video input mode.
TV cabinet creaks.	<ul style="list-style-type: none"> When the TV is in use, the temperature rises naturally and may cause the cabinet to expand or contract which can cause a creaking noise. This is not a malfunction.
Control buttons do not work.	<ul style="list-style-type: none"> Make sure that the Button Lock option is set to Off. See "Locking control buttons" on page 34. Unplug the power cord, wait a few seconds, then plug the cord back in and turn on your TV.
TV keeps turning off.	<ul style="list-style-type: none"> Make sure that the sleep timer is not turned on. See "Setting the sleep timer" on page 40.

Note: If the problem is not solved by using these troubleshooting instructions, turn off your TV, then turn it on again.

Specifications

Specifications are subject to change without notice.

Dimensions and weight

Without stand	29.65 × 19.27 × 2.38 in. (75.30 × 48.95 × 6.05cm) 15.78 lbs. (7.16 kg)
With stand	29.65 × 21.05 × 7.24 in. (75.30 × 53.46 × 18.41cm) 17.33 lbs. (8.04 kg)

Screen

Screen size measured diagonally	31.5 in.
Display type	LED
Panel 60 Hz vs. 120 Hz	60Hz
Display resolution	1080p
Panel resolution	1920 (H) × 1080 (V)
Aspect ratio	16:9
Contrast ratio (typical)–panel	3000:1
Dynamic contrast ratio–list value	80000:1
Brightness (center typical) cd/m ²	310 nits
Comb filter	3d y/c digital
Response time	6.5 ms
Horizontal viewing angle	178
Vertical viewing angle	178

Display resolutions

HDMI 1.3	1080p, 1080i, 720p, 480p, 480i
Component video	1080i, 720p, 480p, 480i

Tuner

Analog	NTSC
Digital	ATSC, 8-VSB, Clear-QAM

Inputs

HDMI/DVI	1 (right side)/2 (left side) E-EDID compliant HDCP compliant
Component video	1 (right side)
Composite video	1 (right side)
Shared audio (component and composite)	Yes
S-Video	No
PC/VGA	1 (left side)
3.5mm PC audio input	1 (left side)
USB	1 (right side) Supports JPEG and firmware upgrade
Coaxial cable	1 (left side)

Outputs

Video	No
Analog audio/Headphone	1 (right side)
Digital audio	1 optical (left side)
WiFi	No
Ethernet	No
Headphone	No

Audio

Speakers	Number: 2 Watts per channel: 5W
----------	------------------------------------

Power

Power consumption	On: 65W Standby: <1W
Power input	19V DC

Miscellaneous

OSD languages	English, French, Spanish (all models)
INlink	Yes
Game Mode	No
ENERGY STAR qualified	No
Internet connectable	No
TV base screws	Stand column to TV screen: M4 type (10 mm length) (4 pcs) Base to stand column: M4 type (20 mm length) (4 pcs)
V-Chip (version 2.0)	Yes
Sleep timer	Yes
Channel labeling	Yes
VESA mount (mm) (horizontal × vertical)	200 × 200

Note

The length of the wall-mount screws vary depending on the wall-mount bracket you purchased. See the instructions that came with the wall-mount bracket for screw lengths.

Programming universal remote controls

Programming a different universal remote control

You can operate your Insignia TV with a new or existing universal remote control.

To program a different universal remote control:

- 1 See the table in "Common universal remote control codes" on page 51 for common codes. If you have problems programming your remote or need a different remote control code, visit www.insigniaproducts.com/remotecodes for the latest remote control code information.
- 2 Follow your universal remote control's instructions to enter the TV code you found in Step 1.

Tips

- If your universal remote control has a code search feature, run a code search to identify a code that matches your TV. See your universal remote control's instructions for details.
- If your universal remote control has a "Learn" feature, you can manually program it using the Insignia TV remote to "teach" the commands one at a time. See your universal remote control's instructions for details.

For additional help and information:

- Visit: <http://www.insigniaproducts.com/remotecodes>
- Call technical support for the universal remote control or cable/satellite company of the remote/set-top box you are trying to program.
- Call the Insignia Customer Care Center 1-877-467-4289.

Common universal remote control codes

The following is a list of the most common remote control codes. Codes for other remote controls are available online at: <http://www.insigniaproducts.com/remotecodes> or check with your cable or satellite TV provider for the remote control code.

Insignia TV codes for universal remote controls (for all Insignia TVs manufactured after Jan. 1, 2007)

Universal remote control makes and models	
One for All	0054
Phillips	0198, 0490
RCA	135
Sony	068, 069, 078, 096, 100, 164, 168, 229, 026

Set-top box makes and models	
Cablevision	068, 069, 078, 096, 100, 164, 168, 229, 026
Charter	2002, 1204, 1423, 1517, 0171, 1963, 0463, 1463, 0842, 1326, 167, 415, 424, 450, 456, 461, 507, 523, 567, 577, 586
Comcast	10171, 11204, 11326, 11463, 11517, 11641, 11780, 11785, 11892, 11963, 12002
Cox	1326, 1463
DirectTV	10171, 11204, 11326, 11517, 11564, 11641, 11963, 12002
Dish Network	720
Time Warner	400, 450, 461, 456, 10463, 1463, 0463
TiVo	0091
Verizon	0198, 0490

Tips

- The brand name is often visible on the front of the universal remote control, and the model number is often visible on the back.
- If your universal remote control isn't listed on the chart, refer to your universal remote control's instructions and try codes for the brands Orion, Emerson, Memorex, Sansui, Sylvania, or Zenith. You may need to try several codes before finding a match.

Legal notices

FCC Part 15

This device complies with Part 15 of the FCC Rules. Operation of this product is subject to the following two conditions: (1) this device may not cause harmful interference, and (2) this device must accept any interference received, including interference that may cause undesired operation.

This equipment has been tested and found to comply within the limits for a class B digital device, pursuant to Part 15 of the FCC Rules. These limits are designed to provide reasonable protection against harmful interference in a residential installation. This equipment generates, uses, and can radiate radio frequency energy and, if not installed and used in accordance with the instructions, may cause harmful interference to radio communications. However, there is no guarantee that interference will not occur in a particular installation. If this equipment does cause harmful interference to radio or television reception, which can be determined by turning the equipment off and on, the user is encouraged to try to correct the interference by one or more of the following measures:

- Reorient or relocate the receiving antenna.
- Increase the separation between the equipment and receiver.
- Connect the equipment into an outlet on a circuit different from that to which the receiver is connected.
- Consult the dealer or an experienced radio/TV technician for help.

FCC warning

Changes or modifications not expressly approved by the party responsible for compliance with the FCC Rules could void the user's authority to operate this equipment.

Cables

Connections to this device must be made with shielded cables with metallic RF/EMI connector hoods to maintain compliance with FCC Rules and Regulations.

Canada ICES-003 statement

This Class B digital apparatus complies with Canadian ICES-003. Standard Television Receiving Apparatus — Appareil de réception télévision ordinaire, Canada BETS-7 / NTMR-7

Dolby License Notice and Trademark Acknowledgement



Manufactured under license from Dolby Laboratories. Dolby and the double-D symbol are trademarks of Dolby Laboratories.

HDMI



HDMI, the HDMI logo, and High-Definition Multimedia Interface are trademarks or registered trademarks of HDMI Licensing LLC.

One-year limited warranty - Insignia Televisions

Definitions:

Insignia Products ("Insignia") warrants to you, the original purchaser of this new Insignia-branded television ("Product"), that the Product shall be free of defects in the original manufacturer of the material or workmanship for a period of one (1) year from the date of your purchase of the Product ("Warranty Period"). For this warranty to apply, your Product must be purchased in the United States or Canada from a Best Buy or Future Shop authorized dealer of Insignia brand products only that are packaged with this warranty statement.

How long does the coverage last?

The Warranty Period lasts for 1 year (365 days) from the date you purchased the Product. Your purchase date is printed on the receipt you received with the Product.

What does this warranty cover?

During the Warranty Period, if the original manufacture of the material or workmanship of the Product is determined to be defective by an authorized Insignia repair center or store personnel, Insignia will (at its sole option): (1) repair the Product with new or rebuilt parts; or (2) replace the Product at no charge with new or rebuilt comparable products or parts. Products and parts replaced under this warranty become the property of Insignia and are not returned to you. If service of Products or parts are required after the Warranty Period expires, you must pay all labor and parts charges. This warranty lasts as long as you own your Insignia Product during the Warranty Period. Warranty coverage terminates if you sell or otherwise transfer the Product.

How to obtain warranty service?

If you purchased the Product at a Best Buy or Future Shop retail store location and your television Product has a screen size of less than 42 inches, please take your original receipt and the Product to any Best Buy or Future Shop store. Make sure that you place the Product in its original packaging or packaging that provides the same amount of protection as the original packaging. If you purchased the Product from a Best Buy or Future Shop online web site, mail your original receipt and the Product to the address listed on the web site. Make sure that you put the Product in its original packaging or packaging that provides the same amount of protection as the original packaging.

To obtain in-home warranty service for a television with a screen 42 inches or larger, in the United States call 1-888-BESTBUY, Canada call 1-866-BESTBUY for Future Shop call 1-800-663-2275. Call agents will diagnose and correct the issue over the phone or will have a Insignia-approved repair technician dispatched to your home.

Where is the warranty valid?

This warranty is valid only in the United States and Canada at Best Buy or Future Shop branded retail stores or websites to the original purchaser of the product in the county where the original purchase was made.

What does the warranty not cover?

This warranty does not cover:

- Customer instruction/education
- Installation
- Set up adjustments
- Cosmetic damage
- Damage due to acts of God, such as power surges
- Accident(s)
- Misuse
- Abuse
- Negligence
- Commercial purposes/use, including but not limited to use in a place of business or in communal areas of a multiple dwelling condominium or apartment complex, or otherwise used in a place of other than a private home.
- Modification of any part of the Product, including the antenna
- Plasma display panel damaged by static (non-moving) images applied for lengthy periods (burn-in).
- Damage due to incorrect operation or maintenance

- Connection to an incorrect voltage or power supply
- Attempted repair by any person not authorized by Insignia to service the Product
- Products sold "as is" or "with all faults"
- Consumables, including but not limited to batteries (i.e. AA, AAA, C etc.)
- Products where the factory applied serial number has been altered or removed
- Loss or Theft of this product or any part of the product
- Up to three (3) pixel failures (dots that are dark or incorrectly illuminated) grouped in an area smaller than one tenth (1/10) of the display size or up to five (5) pixel failures throughout the display. (Pixel based displays may contain a limited number of pixels that may not function normally.)
- Failures or Damage caused by any contact including but not limited to liquids, gels or pastes.

REPAIR REPLACEMENT AS PROVIDED UNDER THIS WARRANTY IS YOUR EXCLUSIVE REMEDY FOR BREACH OF WARRANTY. INSIGNIA SHALL NOT BE LIABLE FOR ANY INCIDENTAL OR CONSEQUENTIAL DAMAGES FOR THE BREACH OF ANY EXPRESS OR IMPLIED WARRANTY ON THIS PRODUCT, INCLUDING, BUT NOT LIMITED TO, LOST DATA, LOSS OF USE OF YOUR PRODUCT, LOST BUSINESS OR LOST PROFITS. INSIGNIA PRODUCTS MAKES NO OTHER EXPRESS WARRANTIES WITH RESPECT TO THE PRODUCT, ALL EXPRESS AND IMPLIED WARRANTIES FOR THE PRODUCT, INCLUDING, BUT NOT LIMITED TO, ANY IMPLIED WARRANTIES OF AND CONDITIONS OF MERCHANTABILITY AND FITNESS FOR A PARTICULAR PURPOSE, ARE LIMITED IN DURATION TO THE WARRANTY PERIOD SET FORTH ABOVE AND NO WARRANTIES, WHETHER EXPRESS OR IMPLIED, WILL APPLY AFTER THE WARRANTY PERIOD. SOME STATES, PROVINCES AND JURISDICTIONS DO NOT ALLOW LIMITATIONS ON HOW LONG AN IMPLIED WARRANTY LASTS, SO THE ABOVE LIMITATION MAY NOT APPLY TO YOU. THIS WARRANTY GIVES YOU SPECIFIC LEGAL RIGHTS, AND YOU MAY ALSO HAVE OTHER RIGHTS, WHICH VARY FROM STATE TO STATE OR PROVINCE TO PROVINCE.

Contact Insignia:

For customer service please call 1-877-467-4289

www.insigniaproducts.com

Distributed by Best Buy Purchasing, LLC

7601 Penn Avenue South, Richfield, Minnesota, U.S.A.
55423-3645

© 2012 BBY Solutions, Inc.

All rights reserved. INSIGNIA is a trademark of BBY Solutions, Inc. Registered in some countries. All other products and brand names are trademarks of their respective owners.

INSIGNIA™

www.insigniaproducts.com (877) 467-4289

Distributed by Best Buy Purchasing, LLC
7601 Penn Avenue South, Richfield, MN 55423-3645 USA
© 2012 BBY Solutions, Inc.

All rights reserved. INSIGNIA is a trademark of BBY Solutions, Inc. Registered in some countries.
All other products and brand names are trademarks of their respective owners.

ENGLISH
11-1333