

QUICK SETUP GUIDE

40" LED TV
NS-40D40SNA14

Thank you

for purchasing this state-of-the-art Insignia television. We hope you enjoy the quality and reliability of this television for years to come.



1 START HERE

How do I attach the stand to my TV? (not for wall mounting)

You'll need: A Phillips screwdriver and a soft surface to lay the TV on.

A Carefully place your TV face-down on a cushioned, clean surface to protect the screen from damages and scratches.

B Secure the stand column to your TV with the six provided 16 mm screws (the shorter screws).

C Secure the TV stand to the stand column with the five provided 18 mm screws (the longer screws).

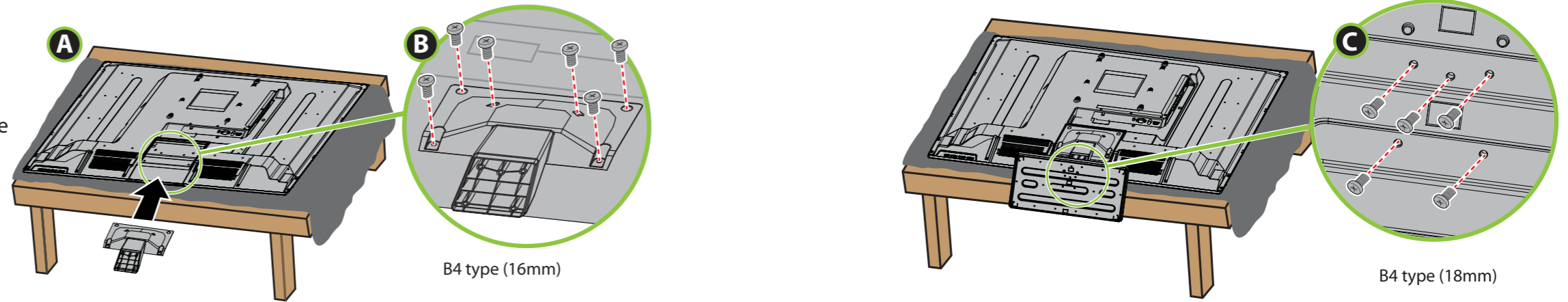

- OR -

How do I prepare my TV for wall mounting?

(not for use with a TV stand)

You'll need: A soft surface to lay the TV on.

A Carefully place your TV face-down on a cushioned, clean surface to protect the screen from damages and scratches.

B See the instructions that came with your wall mount for more information about how to correctly mount your TV.

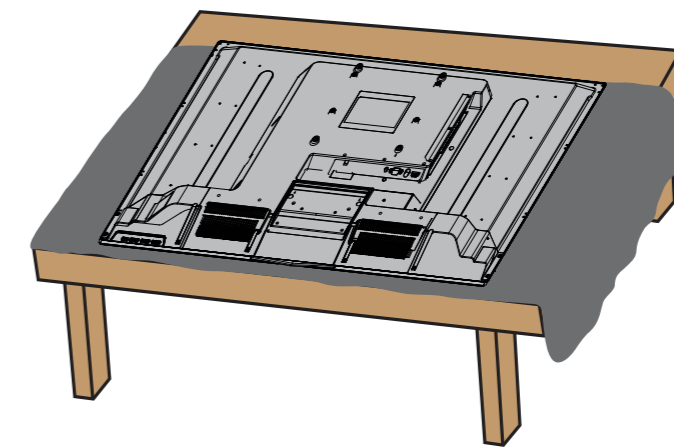

STOP!

Do not plug your power cable in until all other devices have been connected.

Included accessories

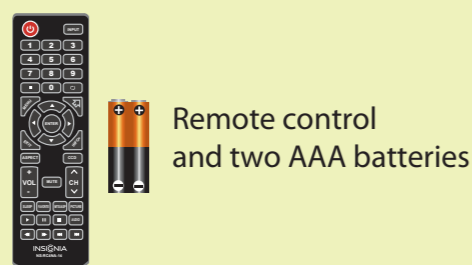

Remote control and two AAA batteries

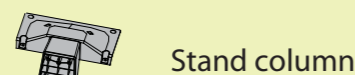

Stand column

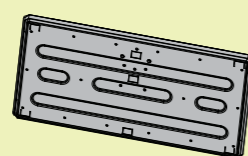

TV stand

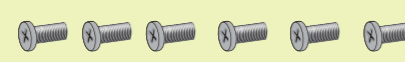

B4 type (16mm length)
(6 pcs.)



B4 type (18mm length)
(5 pcs.)

Which cables do you have?

Your TV has several different jacks for connecting devices. For the best video quality, use the best available connection. Use the cables that came with your devices.

VIDEO QUALITY	JACK TYPE	CABLE CONNECTOR
BEST	HDMI video/audio	
BETTER	Component video and analog audio	
GOOD	Composite video and analog audio	
GOOD	Coaxial video/audio	

Note: You can use the **HDMI 1/DVI (ARC)** jack to connect a DVI device to your TV. Attach an HDMI-to-DVI adapter to the end of the HDMI cable. The adapter connects to the DVI device's jack.

Features

Front view

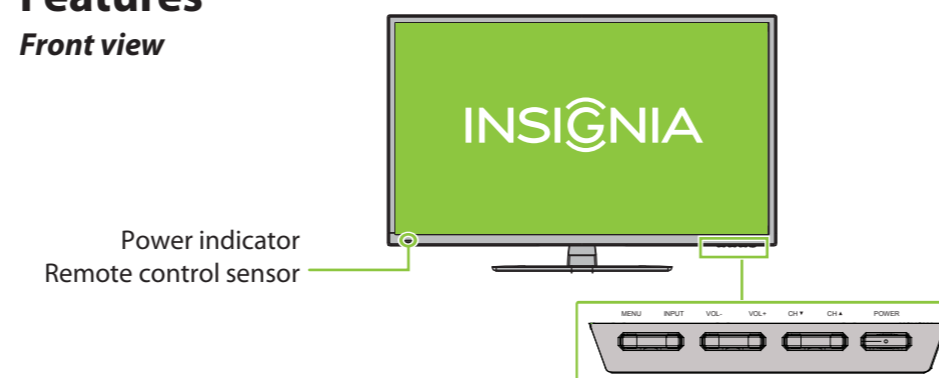

Back view

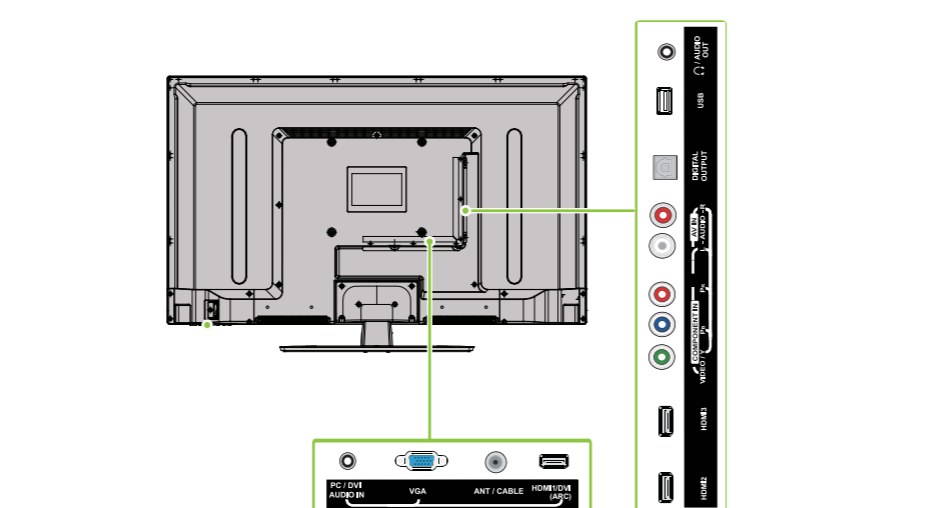

Note: Images may not necessarily represent the exact design of your television.

2 MAKING CONNECTIONS

How do I watch TV (cable or satellite receiver) or connect a device such as a DVD or Blu-ray Disc player, game console, or camcorder?

Using an HDMI cable (BEST)

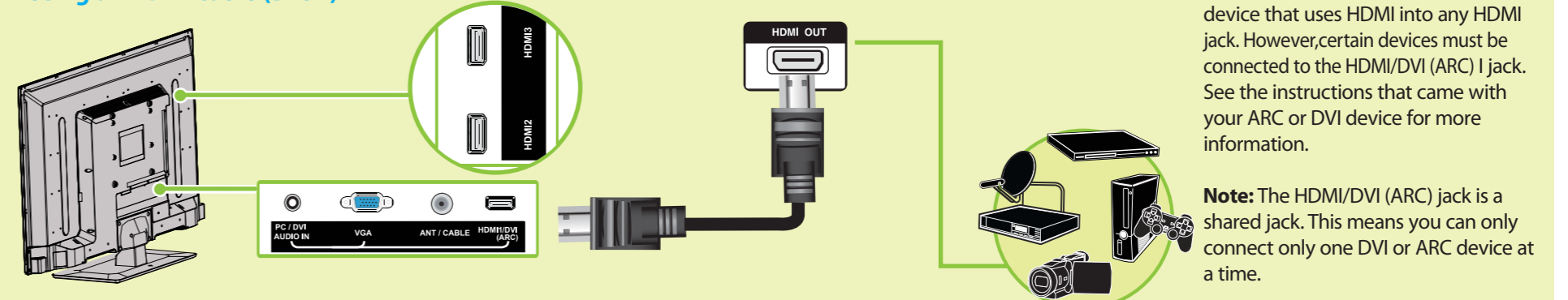

Multipurpose jacks: You can plug any device that uses HDMI into any HDMI jack. However, certain devices must be connected to the HDMI/DVI (ARC) I jack. See the instructions that came with your ARC or DVI device for more information.

Note: The HDMI/DVI (ARC) jack is a shared jack. This means you can only connect only one DVI or ARC device at a time.

Using component cables (BETTER)

- OR -

Using an AV cable (GOOD)

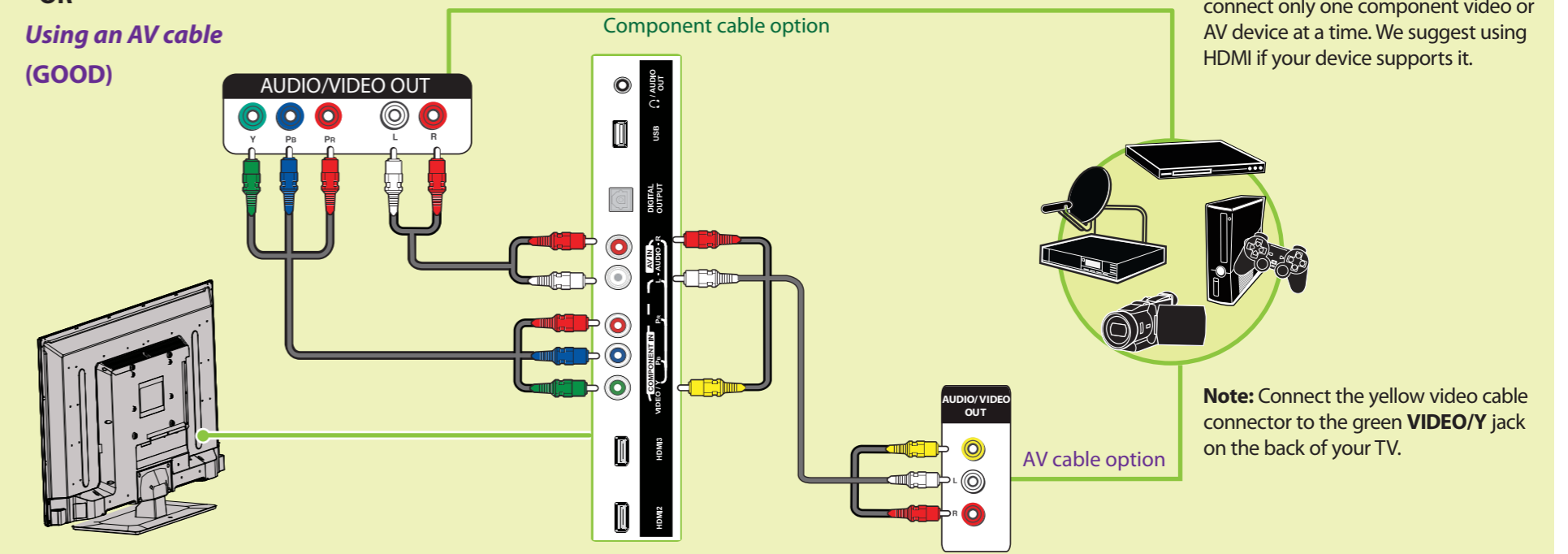

Note: The component video and AV jacks are shared. This means you can connect only one component video or AV device at a time. We suggest using HDMI if your device supports it.

Note: Connect the yellow video cable connector to the green VIDEO/Y jack on the back of your TV.

How do I connect my TV to an antenna or cable wall jack?

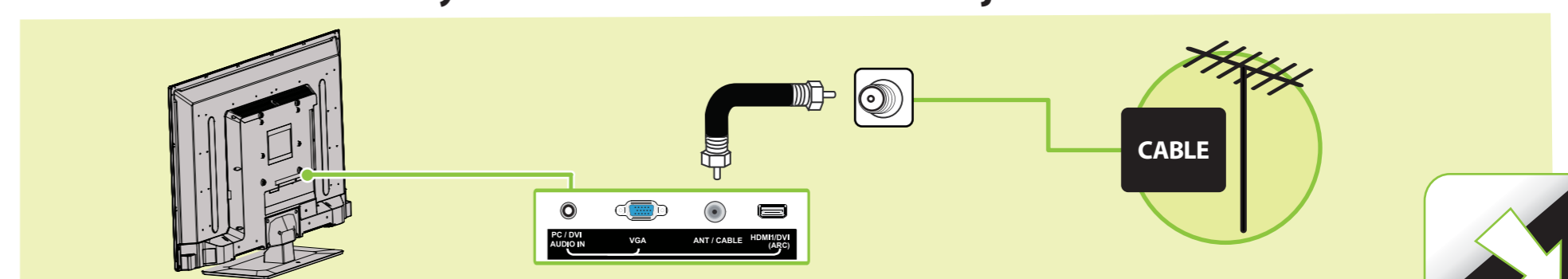

OVER

FIND YOUR USER GUIDE ONLINE!

We are going green so a copy of your User Guide is not provided in the box but is available online.

Go to www.insigniaproducts.com, then click **Support & Service**. Enter your model number in the box under **Manual, Firmware, Drivers & Product Information**, then click ▶.



3 CONNECTING AUDIO DEVICES

How do I connect my TV to external speakers?

Using digital audio

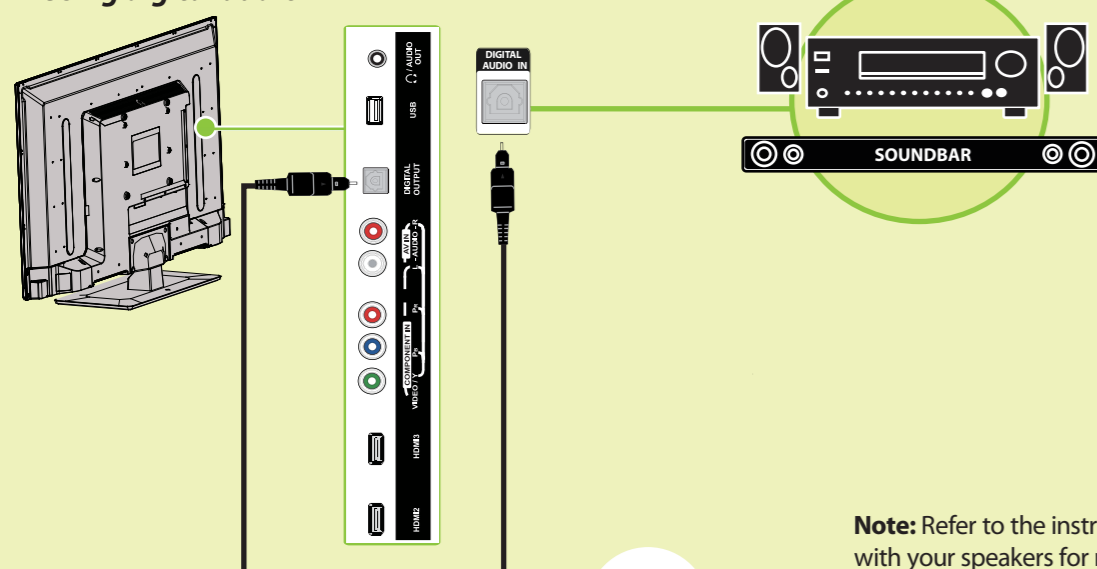

Note: Refer to the instructions that came with your speakers for more information.

- OR -

Using analog audio

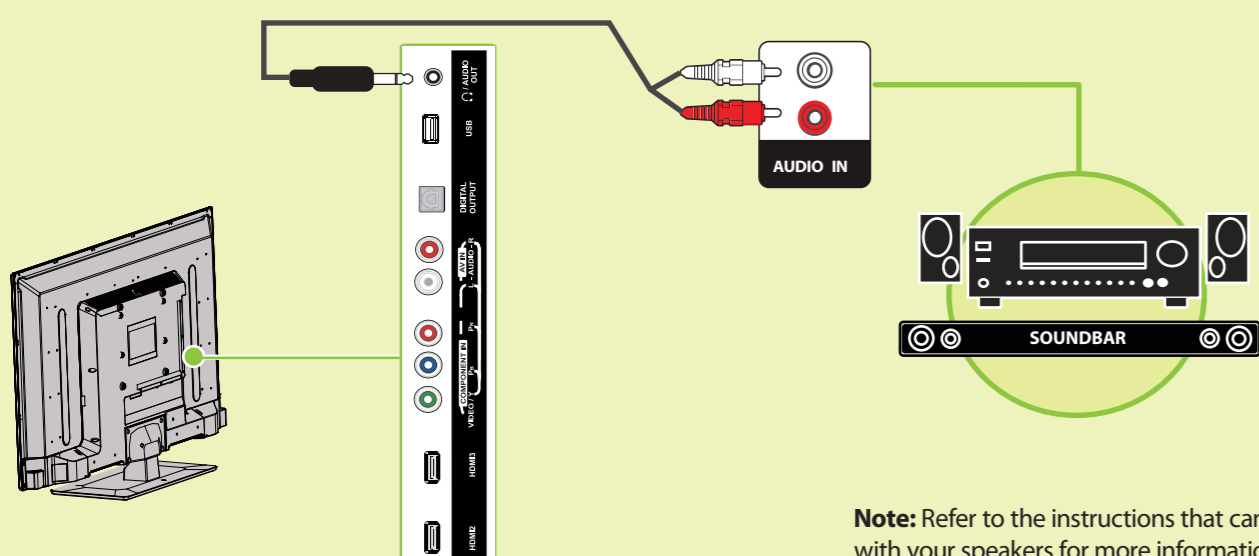

Note: Refer to the instructions that came with your speakers for more information.

Using your remote control

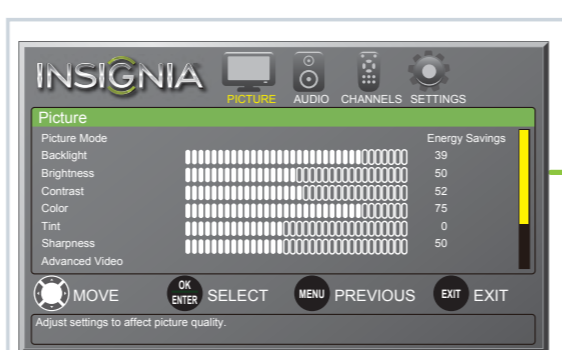
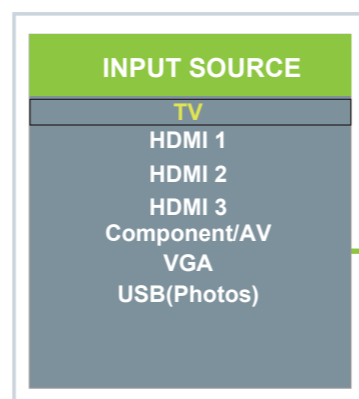

What are my screen-size options?

- NORMAL:** Original aspect ratio is preserved. Black bars are present if content is not widescreen (16:9).
- ZOOM:** Expands the image to fill the screen. The top and bottom of the image may be cropped.
- WIDE:** Displays content recorded in a 16:9 (wide-screen) aspect ratio.
- CINEMA:** Stretches the image at the edges, but keeps a clear image in the center.
- AUTO:** Automatically adjusts the image based on the screen size and the TV program. Select this option if you are uncertain which aspect ratio to choose.
Note: Auto is only available when Auto Zoom in the Channels menu is set to On.

- Power:** Turns your TV on or off.
- INPUT:** Opens the INPUT SOURCE list.
- Numbers (1-9, 0):** Enter channel numbers and parental control password.
- 0:** Enters a digital sub-channel number (for example 4.1).
- ENTER:** Confirms selections or opens a sub-menu.
- MENU:** Opens the on-screen menu.
- EXIT:** Closes the on-screen menu.
- ASPECT:** Changes how the picture is displayed on the screen.
- VOLUME (+/-):** Changes the volume.
- SLEEP:** Sets the sleep timer.
- FAVORITE:** Opens the Favorite Channel List.
- INlink Controls:** Control HDMI-CEC devices connected to your TV.
- RECALL:** Returns to the previous channel.
- Arrows:** Navigate in on-screen menus.
- HOME:** Opens the on-screen menu.
- INFO*:** Opens a TV status banner.
- CCD:** Turns closed captioning on or off.
- MUTE:** Mutes the sound.
- Channel (CH +/-):** Changes the TV channels.
- MTS/SAP:** Analog TV – Cycles through mono, stereo, and secondary audio for analog programs. Digital TV – Selects the audio language for the current channel.
- PICTURE:** Selects the picture mode.
- AUDIO:** Selects the audio mode.

4 TURNING ON MY TV

When can I turn on my TV?

The best time to turn on your TV is after you have attached the TV stand or wall-mounted your TV and connected all devices.

1 Plug the AC power cord into a power outlet.

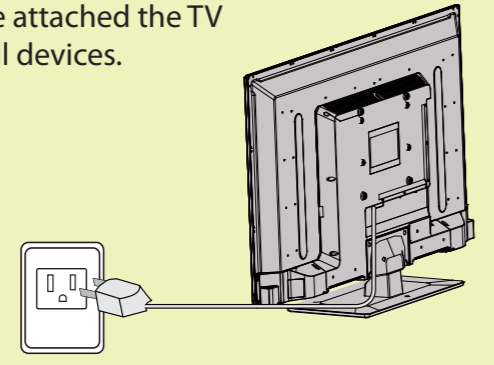

2 Install the remote control batteries.

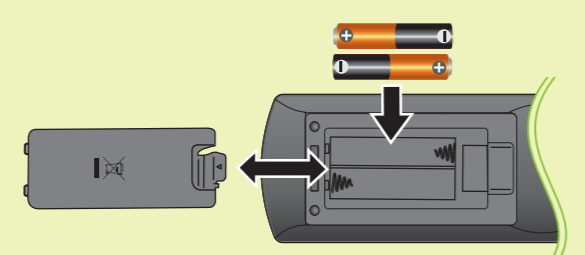

3 Press (power) on your remote control.

4 Follow the on-screen instructions.



I already have a universal remote control. How do I make it control this TV?

If you already have a universal remote control that you would like to program to work with your TV and don't want to use the included Insignia remote control, see the table for common codes.

UNIVERSAL REMOTE TV CODES	
CABLE BOX, SATELLITE BOX, OR OTHER SET-TOP BOX	
Cablevision	068, 069, 078, 096, 100, 164, 168, 229, 026
Charter	2002, 1204, 1423, 1517, 0171, 1963, 0463, 1463, 0842, 1326, 167, 415, 424, 450, 456, 461, 507, 523, 567, 577, 586
Comcast	10171, 11204, 11326, 11463, 11517, 11641, 11780, 11785, 11892, 11963, 12002
Cox	1326, 1463
Direct TV	10171, 11204, 11326, 11517, 11564, 11641, 11963, 12002
Dish Network	720
Time Warner	400, 450, 461, 456, 10463, 1463, 0463
Tivo	0091
Verizon	0198, 0490
UNIVERSAL REMOTE CONTROLS	
One for All	0054
Philips	0198, 0490
RCA	135
Sony	068, 069, 078, 096



For an up-to-date list of codes for other cable providers and universal remote brands, scan this QR code or visit www.insigniaproducts.com/remotecodes

One-year limited warranty
Visit www.insigniaproducts.com for details.

Need additional help?
See your online *User Guide!* This comprehensive guide includes everything from basic how-to steps to more advanced features. A copy of your *User Guide* is not provided in the box but is available online. Go to www.insigniaproducts.com, then click **Support & Service**. Enter your model number in the box under **Manual, Firmware, Drivers & Product Information**, then click ▶. Check out our **online community forum** at www.insigniaproducts.com for helpful information from other Insignia TV owners.

We're here for you
www.insigniaproducts.com
For customer service, call:
877-467-4289
(U.S./Canada markets)

INSIGNIA is a registered trademark of BBY Solutions, Inc. Registered in some countries. Distributed by Best Buy Purchasing, LLC, 7601 Penn Ave South, Richfield, MN 55423 U.S.A.

©2013 BBY Solutions, Inc. All Rights Reserved
1-877-467-4289
www.insigniaproducts.com