

User Guide



Radio with Universal iPod® Dock

NS-B3113B

Insignia NS-B3113B Radio with Universal iPod® Dock

Contents

Introduction	3
Safety information	3
Features	5
Setting up your radio.....	8
Using your radio	9
Troubleshooting	12
Maintaining.....	13
Specifications.....	13
Legal notices.....	13
90-day limited warranty	15

Introduction

Congratulations on your purchase of a high-quality Insignia product. Your NS-B3113B represents the state of the art in radio design and is designed for reliable and trouble-free performance.

Safety information

Warning



The lightning flash with arrowhead symbol within an equilateral triangle is intended to alert the user to the presence of uninsulated dangerous voltage within your receiver's enclosure that may be of sufficient magnitude to constitute a risk of electric shock.



The exclamation point within an equilateral triangle is intended to alert the user to the presence of important operating and maintenance (servicing) instructions in the literature accompanying your radio.

Warning: Risk of electric shock. Do not open.



- 1) Read these instructions.
- 2) Keep these instructions.
- 3) Heed all warnings.
- 4) Follow all instructions.
- 5) Do not use this apparatus near water.
- 6) Clean only with a dry cloth.
- 7) Do not block any ventilation openings. Install in accordance with the manufacture's instructions.
- 8) Do not install near any heat source, such as radiators, heat registers, stoves, or other apparatus (including amplifiers) that produce heat.
- 9) Do not defeat the safety feature of the polarized or grounding-type plug. A polarized plug has two blades and a third grounding prong. The wide blade or the third prong are provided for your safety. If the provided plug does not fit into your outlet. Consult an electrician for replacement of the obsolete outlet.
- 10) Protect the power cord from being walked on or pinched, particularly at plugs, convenience receptacles, and the point where they exit the radio.
- 11) Only use attachments/accessories specified by the manufacturer.
- 12) Unplug this radio during lightning storms or when unused for long periods of time.

13) Refer all servicing to qualified service personal. Servicing is required when the radio has been damaged in any way, such as the power cord or plug is damaged, liquid has been spilled or objects have fallen into the radio, the radio has been exposed to rain or moisture, does not operate normally, or has been dropped.

14) Do not expose your radio to dripping or splashing liquids, and no objects filled with liquids should be placed on it.

15) Excessive sound pressure from earphones and headphones can cause hearing loss.

16) The batteries should not be exposed to excessive heat, such as sunshine, fire, or similar heat sources. Replace batteries only with the same or equivalent type.

17) The wall plug is the disconnecting device. The plug must remain readily operable.

Note

Read the rating labels on the bottom of the system for power input and other safety information.

Features

Package contents

- Radio
- AC power cord
- User Guide

Front view

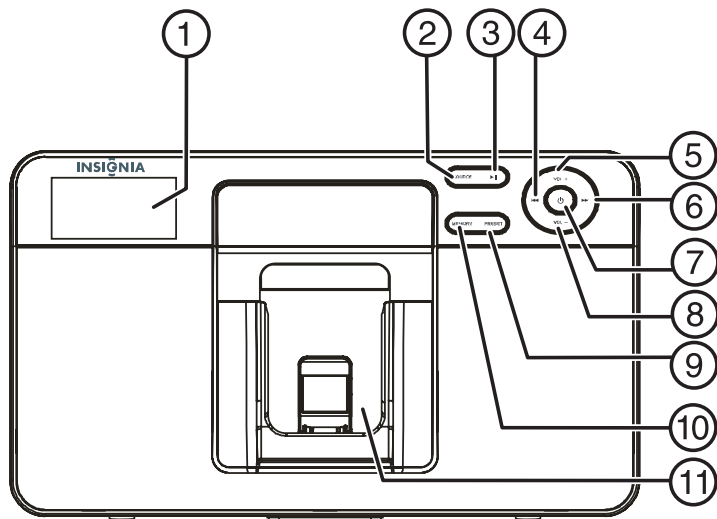

#	Feature	Description
1	LCD display	Provides information about the radio functions.
2	SOURCE button	When the radio is on, repeatedly press to cycle through AM, FM, and Aux in.
3	PLAY/PAUSE ► button	Press to begin playback on your iPod®. Press again to pause playback.
4	TUNING/SKIP (down) ◀◀ button	In radio mode, press to tune to a lower frequency station. In iPod mode, press to skip to the previous track.
5	VOLUME + button	Press to increase the volume.
6	TUNING/SKIP (up) ▶▶ button	In radio mode, press to tune to a higher frequency station. In iPod mode, press to skip to the next track.
7	⏻ (power on/off) button	Press to turn on the power. Press again to go to standby mode.
8	VOLUME – button	Press to decrease the volume.
9	PRESET button	In radio mode, press repeatedly to select a preset station.
10	MEMORY button	Press to save radio station presets (10 AM and 10 FM).
11	iPod® dock	Place your iPod into this dock to play it through the radio.

Back view

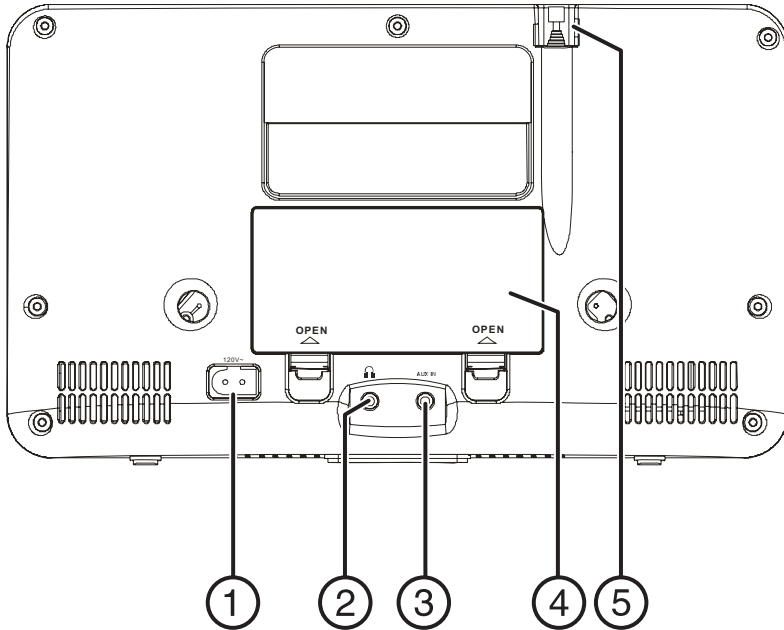

#	Feature	Description
1	AC input socket	Plug the AC power cord into this socket.
2	Headphone jack	Plug the cord from your headphones into this jack.
3	AUX IN jack	Connect a cable from an external audio source to this jack to hear the sound through your radio.
4	Battery compartment	Insert four "C" batteries (not included), checking that the polarity (+ and -) matches the drawing inside the battery compartment. We recommend alkaline batteries for longer life.
5	Antenna	FM antenna to improve FM reception.

LCD display

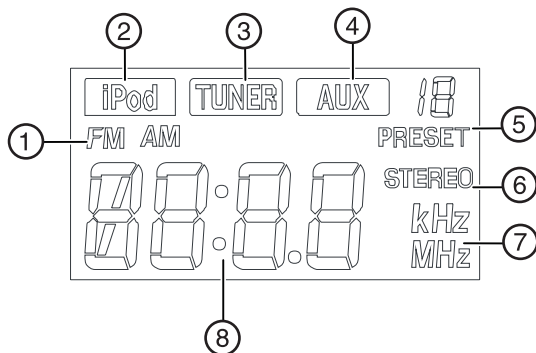

#	Feature	Description
1	AM/FM indicator	Lights to show which radio band is selected.
2	iPod indicator	Lights when the iPod is selected as the sound source.
3	Tuner indicator	Lights when the radio tuner is selected as the sound source.
4	Aux indicator	Lights when an external source (Aux) is selected as the sound source.
5	Preset indicator	Lights to indicate the present station.
6	Stereo indicator	Lights when a stereo radio station is selected.
7	kHz/MHz indicator	Lights to show the radio band selected.
8	Tuner display	Shows the current radio frequency selected.

Setting up your radio

Installing the backup batteries

The radio uses a backup battery system to provide continuous operation in the event of a power failure. If the backup batteries have been installed and a power failure occurs or the AC cord is accidentally disconnected, the display will shut off, but the presets and settings will be temporarily maintained.

Make sure the AC cord is connected. Otherwise all settings may be lost during battery replacement.

To install the backup batteries:

- 1 Open the battery compartment cover located on the back of your radio.

- 2 Insert four “C” batteries (not included), checking that the polarity (+ and -) matches the drawing inside the battery compartment. We recommend alkaline batteries for longer life.
- 3 Close the battery compartment cover.

Warning

- Do not recharge, short, disassemble, or heat the batteries, or dispose of in a fire.
- Dispose of batteries in the proper manner, according to federal, state, and local regulations.
- Remove the batteries when the charge is depleted.
- Battery chemicals can cause a rash. If the batteries leak, clean the battery compartment with a cloth. If chemicals touch your skin, wash immediately.
- Do not mix different types of batteries.
- Do not try to recharge non-rechargeable batteries.

Making connections

Connecting the AC power cord

Make sure that the AC power outlet matches the AC power specifications (120V, 60 Hz) of the radio prior to plugging it in.

To connect the AC power:



- Plug the AC power cord into an AC power outlet.

Using your radio

Before using your radio, make sure all connections are secure, then plug the AC power cord into your radio and an AC power outlet.







Turning your radio on and off

To turn your radio on and off:

- 1 Press the  (power on/off) button. Your radio turns on.
- 2 Press the  (power on/off) button again to switch your radio to standby mode.

Playing the radio



To play the radio:

- 1 Press the  (power on/off) button to turn on your radio.
- 2 Remove a docked iPod, if necessary.
 - Press the **SOURCE** button repeatedly to select the **AM** or **FM** band.
 - If you are listening to FM, uncoil and extend the FM antenna on the back of your radio and move it around to improve reception.
-OR-
 - If you are listening to AM, turn the radio slightly to improve reception.
 - Press **TUNING/SKIP**  or **TUNING/SKIP**  to tune the radio to a lower or higher frequency.
 - Press the **VOLUME +** or **VOLUME –** buttons to increase or decrease the volume. Adjust the volume to a comfortable level.
 - Press and hold **TUNING/SKIP**  or **TUNING/SKIP**  for more than one second to scan to a higher or lower frequency. The radio automatically scans to the next station.
- 3 Press the  (power on/off) button to turn off your radio.

Using radio station presets

Your radio can store 10 AM and 10 FM station presets.

To store radio station presets:

- 1 Press the  (power on/off) button to turn on your radio.
- 2 Remove a docked iPod, if necessary.
- 3 Press the **SOURCE** button repeatedly to select the **AM** or **FM** band.
- 4 Press **TUNING/SKIP**  or **TUNING/SKIP**  to tune the radio to a desired station.
- 5 Press the **MEMORY** button.
- 6 Press the **PRESET** button repeatedly to select the desired preset number.
- 7 Press the **MEMORY** button again to store the preset number for the station.
- 8 Repeat steps 3 to 6 to store as many as 10 AM presets and 10 FM presets.

Recalling radio station presets

To recall radio station presets:

- 1 Press the  (power on/off) button to turn on your radio.
- 2 Remove a docked iPod, if necessary.
- 3 Press the **SOURCE** button repeatedly to select the **AM** or **FM** band.
- 4 Press the **PRESET** button repeatedly to select the preset station you want.

Listening to an external sound source

You can listen to an external sound source, such as a CD, MD, or non-docking iPod®, on your radio.

To listen to an external sound source:

- 1 Make sure that your radio is turned off.
- 2 Connect the external sound source to the **AUX IN** jack on the back of your radio using a stereo mini plug cord (not supplied).
- 3 Press the  (power on/off) button to turn on your radio.
- 4 Remove a docked iPod, if necessary.
- 5 Press the **SOURCE** button repeatedly until "AUX" appears on the display.
- 6 Start playback on the external sound source, then adjust the volume to a comfortable level. Control playback on the external audio device.



Listening to your iPod

To listen to your iPod:

- 1 Insert your iPod into the dock on the front of your radio. The radio will automatically turn on. If you dock an iPod that is playing, you will hear the music through your radio.

Note

If the music is playing too softly, the radio may not detect the iPod. If that happens, press **PLAY/PAUSE**  twice to begin playback.

- 2 When the iPod is docked and in standby mode, press the **PLAY/PAUSE**  button on the radio to play it. The iPod icon will appear on the radio LCD display, showing iPod mode.
 - Press the **PLAY/PAUSE**  button again to pause play. Press it again to resume play.
 - Press the **VOLUME +** or **-** button on the radio to adjust the volume.

- Press **TUNING/SKIP** ◀◀ or **TUNING/SKIP** ▶▶ to go to the next or previous track. Press and hold while track is playing for high speed forward or reverse music search of the current track.
- 3 To turn off the unit, press the ⏻ (power on/off) button. The iPod will continue charging while in the dock.

Troubleshooting

Problem	Cause/Solution
No power	<ul style="list-style-type: none"> • Make sure that the AC power cord is fully inserted into the AC power outlet. • Make sure that the AC power outlet is working.
No sound from the speakers	<ul style="list-style-type: none"> • Make sure that the volume level is set correctly. • Make sure that you have selected the correct mode. • Make sure that the volume level is set correctly on the external sound source or iPod.
Static or noise when playing the radio	<ul style="list-style-type: none"> • Make sure that the station is tuned correctly and that the station has a good signal. • Try another station. • If you are playing an AM station, rotate the radio to improve the reception. • If you are playing an FM station, extend the antenna wire to improve the reception.
The radio gets warm after extended play	<ul style="list-style-type: none"> • This is normal.
The sound is distorted	<ul style="list-style-type: none"> • Make sure that the volume level is not set too high. • Make sure that the material on the sound source is not distorted. Try a different external sound source.
Your iPod does not dock correctly	<ul style="list-style-type: none"> • You are trying to install the iPod incorrectly. Remove the iPod from the dock and check for an obstruction, then try to reseat it.
Your iPod does not respond to the radio	<ul style="list-style-type: none"> • The iPod is not docked correctly. Remove it, then try reseating it. • Your iPod software is outdated. Update your iPod software on http://www.apple.com/ipod/download. • Your iPod is locked up. Make sure your iPod is working correctly before installing it in the radio. Refer to your iPod manual for details. • You are using a first or second generation iPod. The radio cannot control these devices.
Your iPod does not charge	<ul style="list-style-type: none"> • The iPod is not docked correctly. Remove it, then try reseating it. • Your iPod is locked up. Make sure your iPod is working correctly before installing it in the radio. Refer to your iPod manual for details.
No sound from an external sound source	<ul style="list-style-type: none"> • Make sure the external device is connected correctly and the radio is in AUX mode.

Maintaining

Cleaning your radio

To clean your radio, follow these guidelines:

- Use a dry, soft, clean cloth to clean the exterior of your radio.

Specifications

Specifications are subject to change without notice.

Power requirement	AC: 120V, 60 Hz DC: 6 V "C" cell batteries x 4
Power consumption	18 Watts
Dimensions	12.2 x 7.08 x 4.2 inches (310 x 180 x 107 mm)
Tuning range	AM: 530-1710 KHz FM: 87.5 - 107.9 MHz
Speakers	2 Watts per channel 4 ohms impedance
AUX input sensitivity	500 mV

Legal notices

FCC Part 15

This device complies with Part 15 of the FCC Rules. Operation of this product is subject to the following two conditions: (1) this device may not cause harmful interference, and (2) this device must accept any interference received, including interference that may cause undesired operation.

This equipment has been tested and found to comply within the limits for a class B digital device, pursuant to Part 15 of the FCC Rules. These limits are designed to provide reasonable protection against harmful interference in a residential installation. This equipment generates, uses, and can radiate radio frequency energy and, if not installed and used in accordance with the instructions, may cause harmful interference to radio communications. However, there is no guarantee that interference will not occur in a particular installation. If this equipment does cause harmful interference to radio or television reception, which can be determined by turning the equipment off and on, the user is encouraged to try to correct the interference by one or more of the following measures:

- Reorient or relocate the receiving antenna.
- Increase the separation between the equipment and receiver.
- Connect the equipment into an outlet on a circuit different from that to which the receiver is connected.
- Consult the dealer or an experienced technician for help.

FCC warning

Changes or modifications not expressly approved by the party responsible for compliance with the FCC Rules could void the user's authority to operate this equipment.

ICES-003 Class B Notice

This Class B digital apparatus complies with Canadian ICES-003.

Cet appareil numérique de la classe B est conforme à la norme NMB-003 du Canada.

90-day limited warranty

Insignia Products ("Insignia") warrants to you, the original purchaser of this new **NS-B3113B** ("Product"), that the Product shall be free of defects in the original manufacture of the material or workmanship for a period of 90 days from the date of your purchase of the Product ("Warranty Period"). This Product must be purchased from an authorized dealer of Insignia brand products and packaged with this warranty statement. This warranty does not cover refurbished Product. If you notify Insignia during the Warranty Period of a defect covered by this warranty that requires service, terms of this warranty apply.

How long does the coverage last?

The Warranty Period lasts for 90 days from the date you purchased the Product. The purchase date is printed on the receipt you received with the Product.

What does this warranty cover?

During the Warranty Period, if the original manufacture of the material or workmanship of the Product is determined to be defective by an authorized Insignia repair center or store personnel, Insignia will (at its sole option): (1) repair the Product with new or rebuilt parts; or (2) replace the Product at no charge with new or rebuilt comparable products or parts. Products and parts replaced under this warranty become the property of Insignia and are not returned to you. If service of Products or parts are required after the Warranty Period expires, you must pay all labor and parts charges. This warranty lasts as long as you own your Insignia Product during the Warranty Period. Warranty coverage terminates if you sell or otherwise transfer the Product.

How to obtain warranty service?

If you purchased the Product at a retail store location, take your original receipt and the Product to the store you purchased it from. Make sure that you place the Product in its original packaging or packaging that provides the same amount of protection as the original packaging. If you purchased the Product from an online web site, mail your original receipt and the Product to the address listed on the web site. Make sure that you put the Product in its original packaging or packaging that provides the same amount of protection as the original packaging.

To obtain in-home warranty service for a television with a screen 30 inches or larger, call 1-888-BESTBUY. Call agents will diagnose and correct the issue over the phone or will have an Insignia-approved repair person dispatched to your home.

Where is the warranty valid?

This warranty is valid only to the original purchaser of the product in the United States, Canada, and Mexico.

What does the warranty not cover?

This warranty does not cover:

- Customer instruction
- Installation
- Set up adjustments
- Cosmetic damage
- Damage due to acts of God, such as lightning strikes
- Accident
- Misuse
- Abuse
- Negligence
- Commercial use
- Modification of any part of the Product, including the antenna

- Plasma display panel damaged by static (non-moving) images applied for lengthy periods (burn-in).

This warranty also does not cover:

- Damage due to incorrect operation or maintenance
- Connection to an incorrect voltage supply
- Attempted repair by anyone other than a facility authorized by Insignia to service the Product
- Products sold as is or with all faults
- Consumables, such as fuses or batteries
- Products where the factory applied serial number has been altered or removed

REPAIR REPLACEMENT AS PROVIDED UNDER THIS WARRANTY IS YOUR EXCLUSIVE REMEDY. INSIGNIA SHALL NOT BE LIABLE FOR ANY INCIDENTAL OR CONSEQUENTIAL DAMAGES FOR THE BREACH OF ANY EXPRESS OR IMPLIED WARRANTY ON THIS PRODUCT, INCLUDING, BUT NOT LIMITED TO, LOST DATA, LOSS OF USE OF YOUR PRODUCT, LOST BUSINESS OR LOST PROFITS. INSIGNIA PRODUCTS MAKES NO OTHER EXPRESS WARRANTIES WITH RESPECT TO THE PRODUCT, ALL EXPRESS AND IMPLIED WARRANTIES FOR THE PRODUCT, INCLUDING, BUT NOT LIMITED TO, ANY IMPLIED WARRANTIES OF AND CONDITIONS OF MERCHANTABILITY AND FITNESS FOR A PARTICULAR PURPOSE, ARE LIMITED IN DURATION TO THE WARRANTY PERIOD SET FORTH ABOVE AND NO WARRANTIES, WHETHER EXPRESS OR IMPLIED, WILL APPLY AFTER THE WARRANTY PERIOD. SOME STATES, PROVINCES AND JURISDICTIONS DO NOT ALLOW LIMITATIONS ON HOW LONG AN IMPLIED WARRANTY LASTS, SO THE ABOVE LIMITATION MAY NOT APPLY TO YOU. THIS WARRANTY GIVES YOU SPECIFIC LEGAL RIGHTS, AND YOU MAY ALSO HAVE OTHER RIGHTS, WHICH VARY FROM STATE TO STATE OR PROVINCE TO PROVINCE.

Contact Insignia:

For customer service please call 1-877-467-4289
www.insigniaproducts.com

Distributed by Best Buy Purchasing, LLC
7601 Penn Avenue South, Richfield, Minnesota, U.S.A. 55423-3645
© 2010 BBY Solutions, Inc.

All rights reserved. INSIGNIA is a trademark of BBY Solutions, Inc. Registered in some countries. All other products and brand names are trademarks of their respective owners.



www.insigniaproducts.com (877) 467-4289

Distributed by Best Buy Purchasing, LLC
7601 Penn Avenue South, Richfield, MN USA 55423-3645

© 2010 BBY Solutions, Inc.

All rights reserved. INSIGNIA is a trademark of BBY Solutions, Inc.

Registered in some countries.

All other products and brand names are trademarks of their respective owners.

ENGLISH
10-0137