

# INSIGNIA™

32" 720p LED HDTV

## QUICK SETUP GUIDE

NS-32E321A13

### Thank You

for purchasing this fine Insignia television. We hope you enjoy the quality and reliability of this product for years to come.

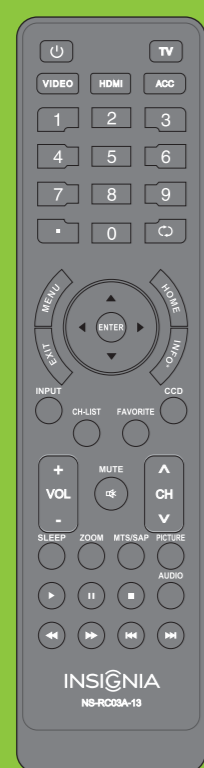

Remote control and 2 AAA batteries

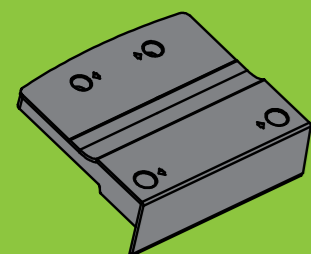

Flat stand cover

Q4 type (25 mm length) (4 pcs)



TV stand and 4 screws

### WE ARE GOING GREEN!

A copy of your *User Guide* is not provided in the box but is available online. Go to [www.insigniaproducts.com](http://www.insigniaproducts.com), click **Support & Service**, enter your model number in the *Product Search* field, then click **Search**.



### Front features

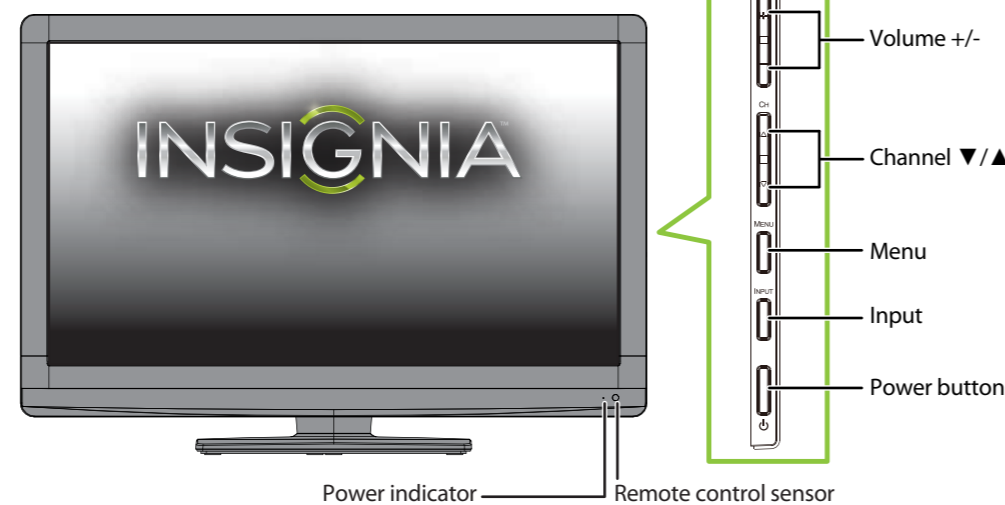

### Installing the stand

- Carefully place your TV face-down on a cushioned, clean surface to protect the screen from damages and scratches.
- Secure the stand to the TV with the four provided screws.

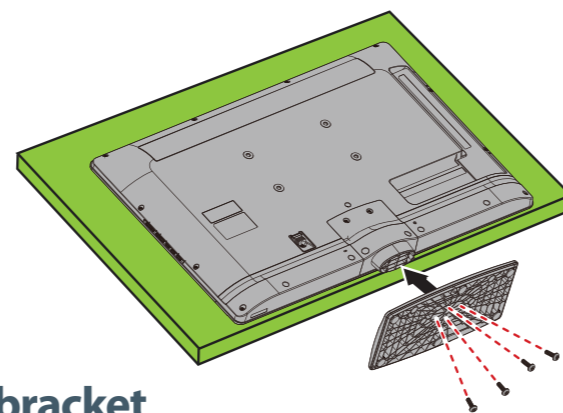

### Installing a wall-mount bracket

- Carefully place your TV face-down on a cushioned, clean surface to protect the screen from damages and scratches.
- Remove the four screws that secure the stand column to the TV, then remove the stand column.
- Secure the flat stand cover to the back of your TV using the four screws you just removed.
- Attach the wall-mount bracket to your TV using the mounting holes on the back of your TV. See the instructions that came with the wall-mount bracket for information about how to correctly hang your TV.

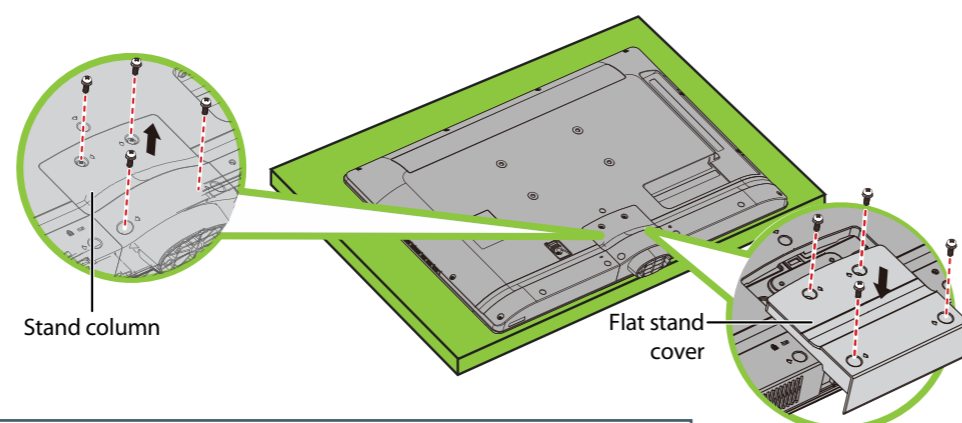

### Warning

This apparatus is intended to be supported by a UL Listed wall mount bracket.

### Identifying cables

Your TV has several connection types for connecting devices. For the best video quality, connect a device to the best available connection.

Connection type	Video quality	Cable connector
HDMI video/audio	Best	
OR		
Component video and analog audio	Better	
OR		
Composite video and analog audio	Good	

You can use the HDMI 1/DVI jack to connect a DVI device to your TV. You need to attach an HDMI-to-DVI adapter to the end of the HDMI cable that connects to the DVI device's jack.

### Connecting a DVD or Blu-ray player, cable box, satellite receiver, camcorder, or game station

Using an HDMI cable (best)

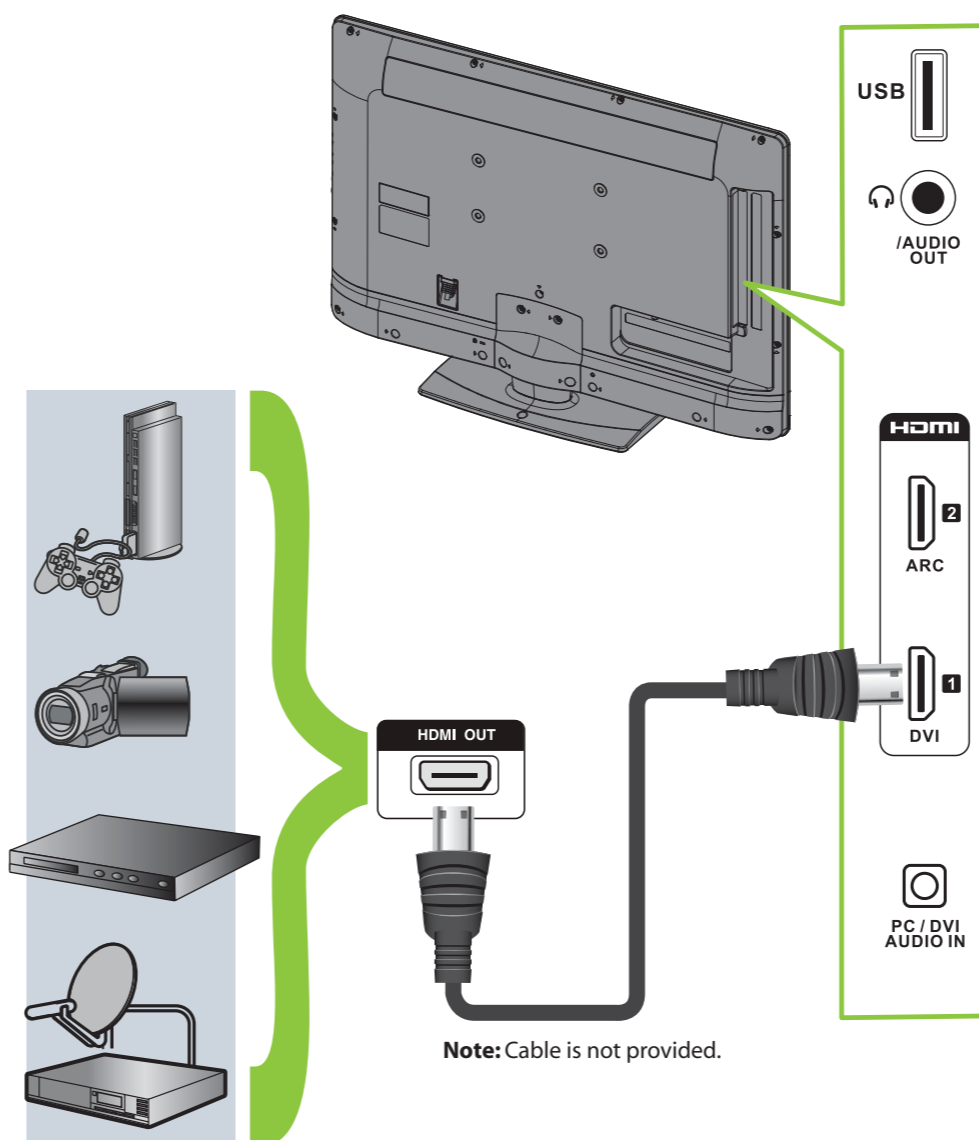

Note: Cable is not provided.

### Using component cables (better)

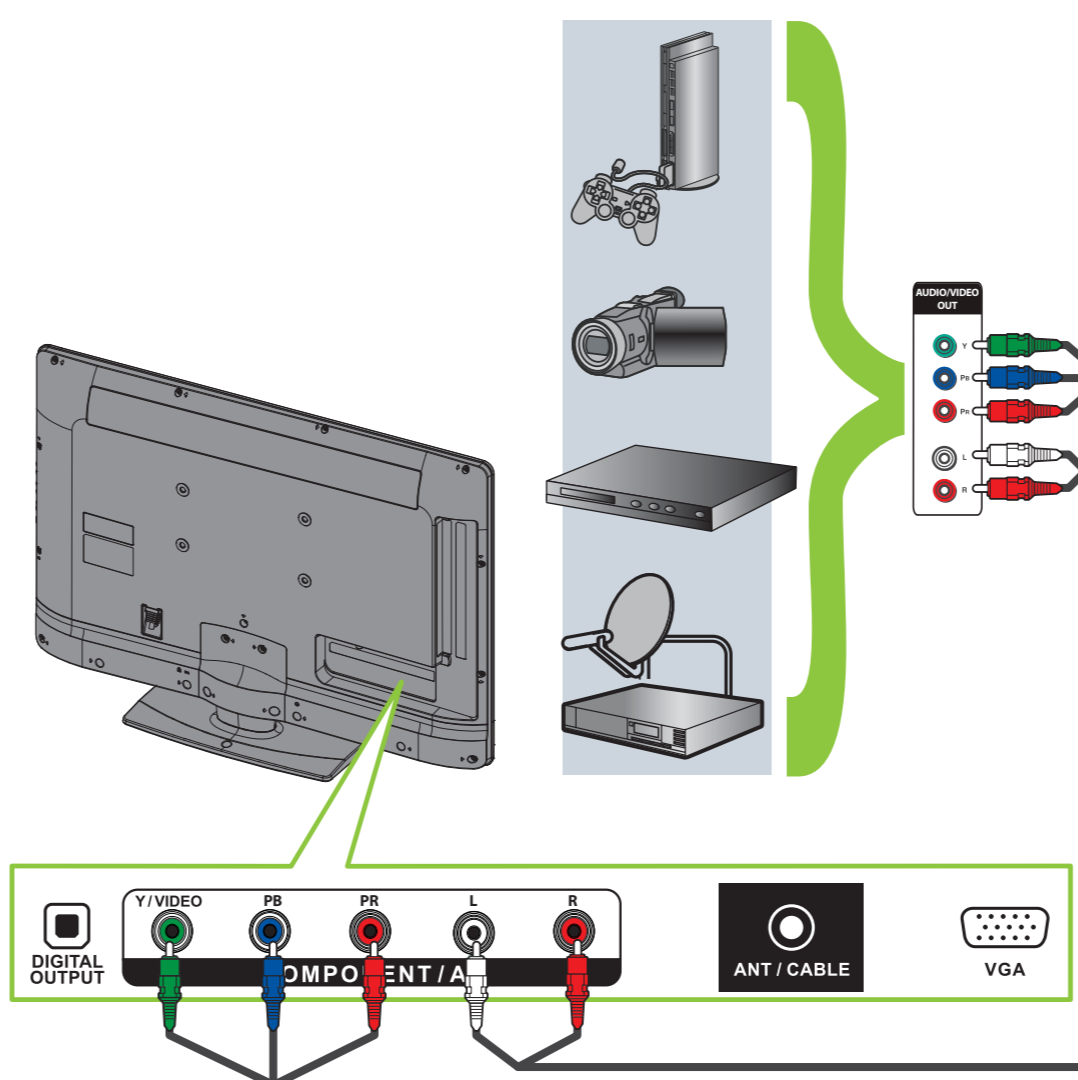

Note: Cable is not provided.

### Using composite cables (good)

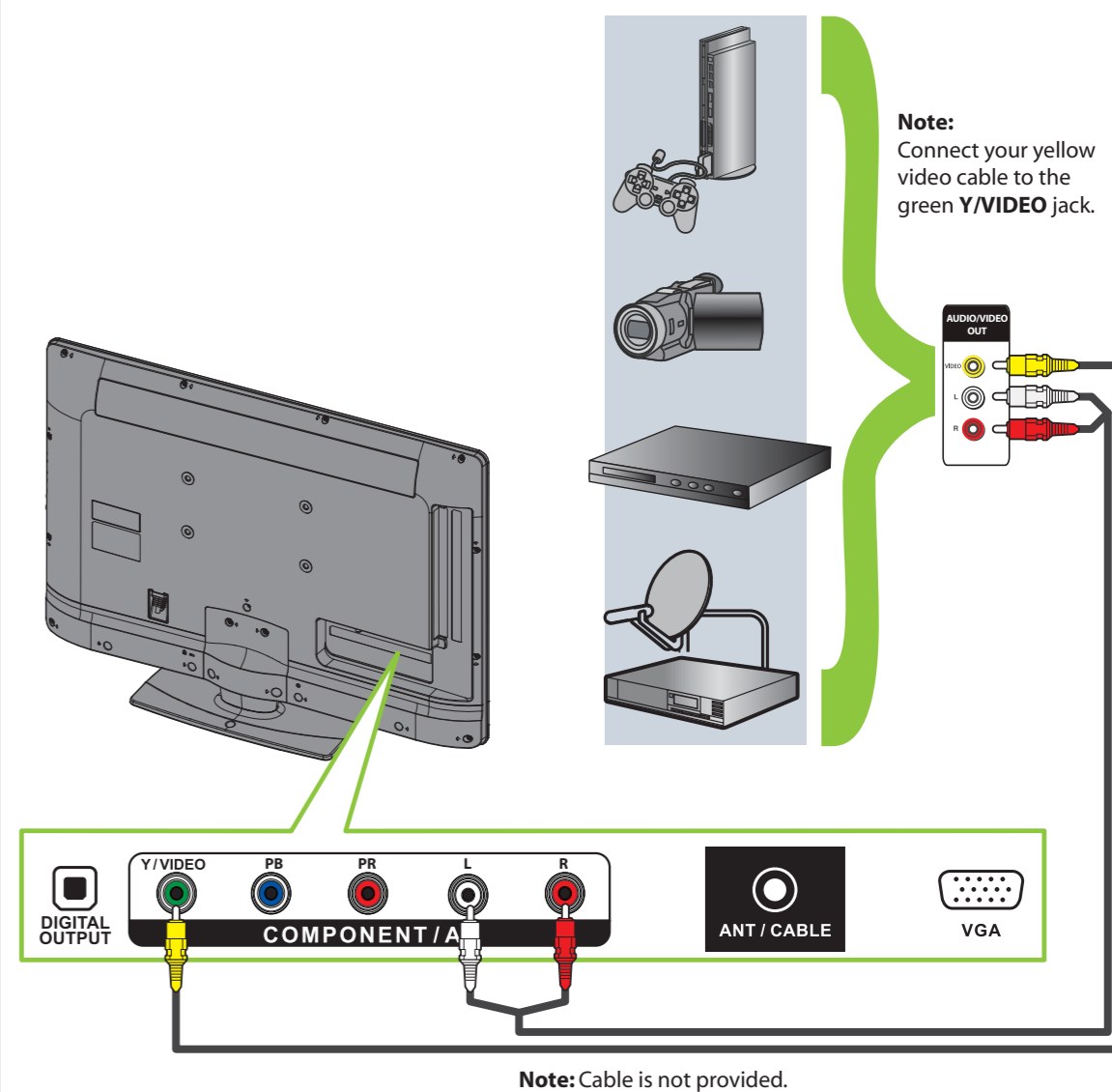

Note: Connect your yellow video cable to the green Y/VIDEO jack.

Note: Cable is not provided.

### Connecting to an antenna/cable wall jack

Connect a coaxial cable (not included) to the ANT/CABLE IN jack on the back of your TV and to the Antenna/Cable wall jack.

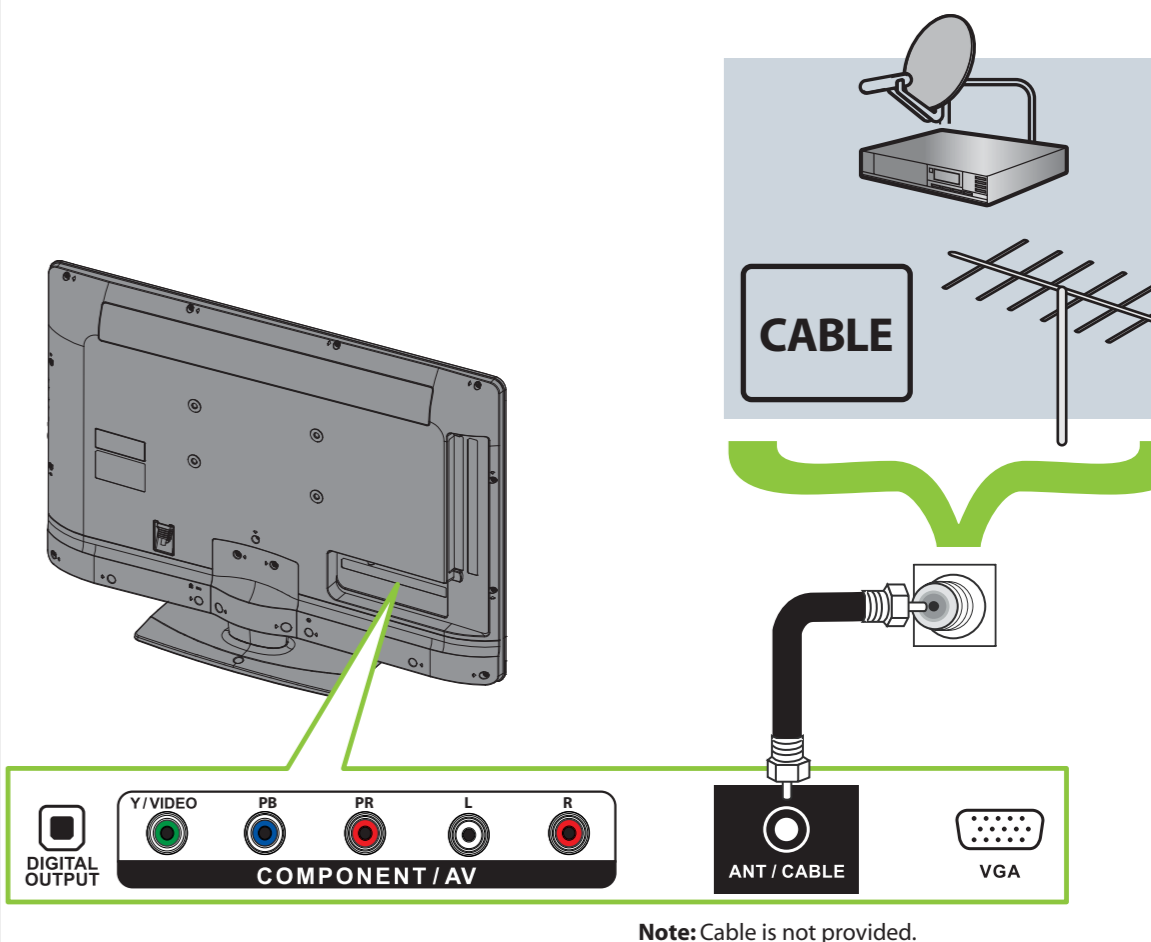

Note: Cable is not provided.

### Connecting a Home Theater System

Using Digital audio

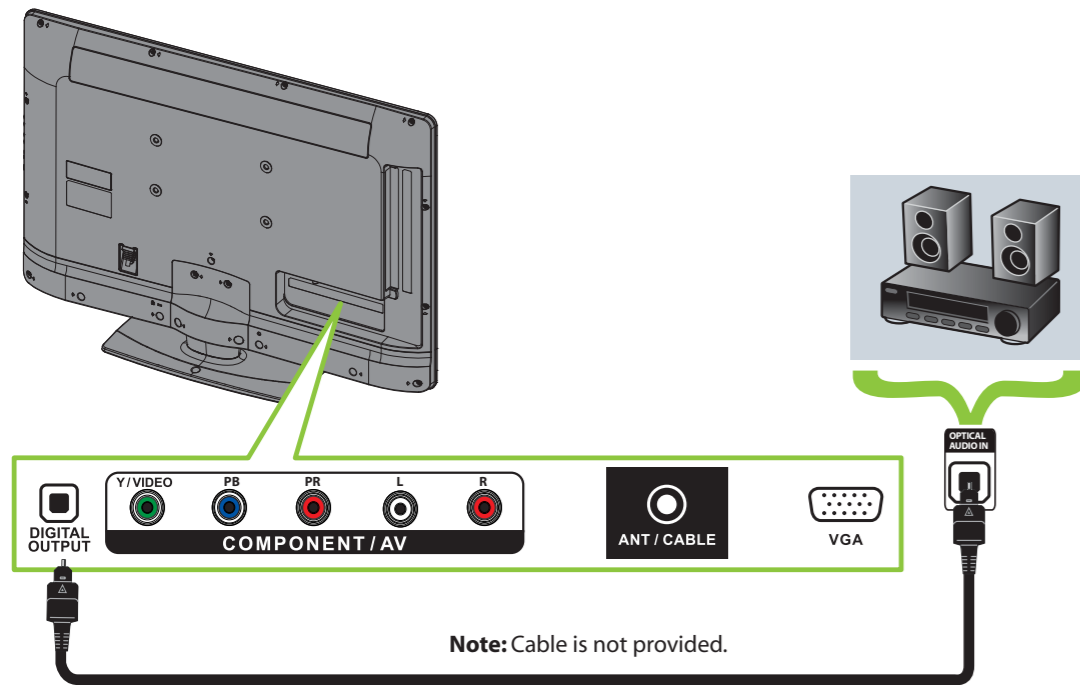

Using Analog audio

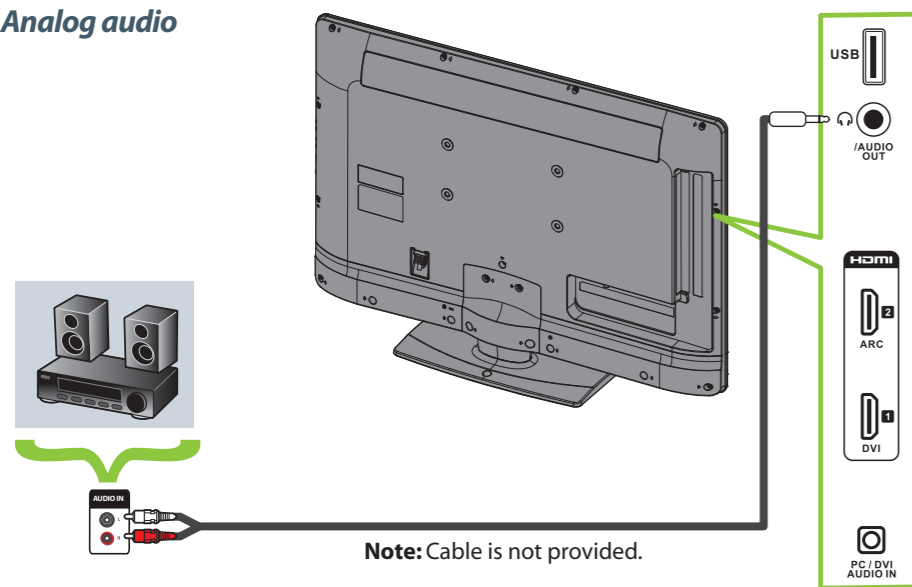

### Setting up and using your remote control

- 1 Press the release button on the back of the remote control to remove the battery compartment cover.
- 2 Insert two AAA batteries into the battery compartment. Make sure that the + and - symbols on the batteries match the + and - symbols in the battery compartment.
- 3 Replace the cover.

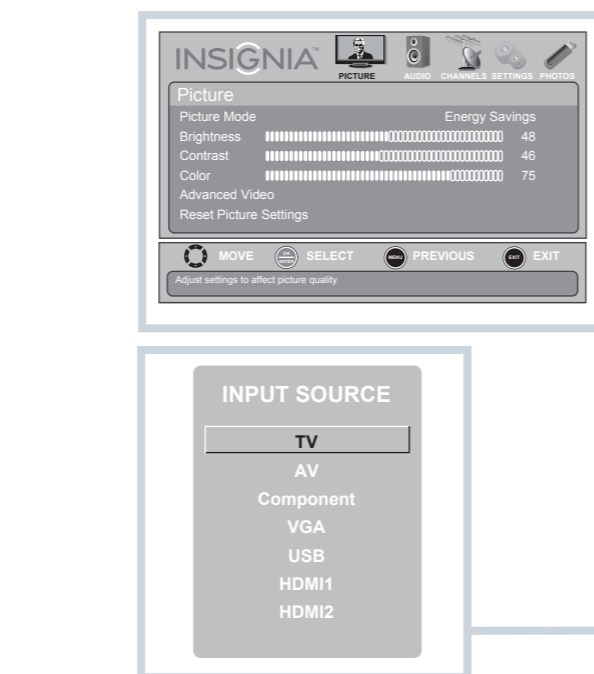
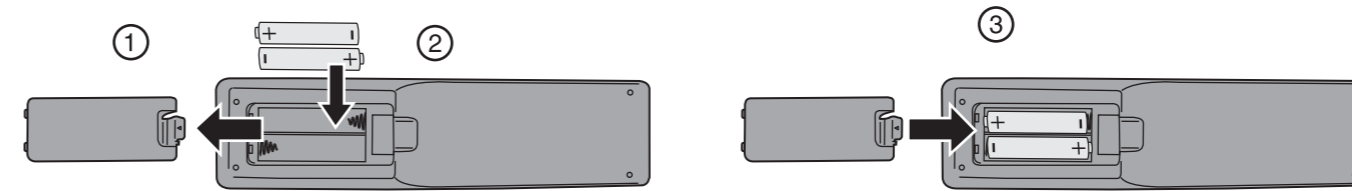

#### Aspect ratio options

- Normal:** Displays the original 4:3 aspect ratio with black bars vertical on the left and right hand side of the screen.
- Zoom:** Expands the image to fill the screen. The top and bottom of the image may be cropped.
- Wide:** Use this option to view content recorded in a 16:9 (wide-screen) aspect ratio.
- Cinema:** Stretches the image at the edges, but keeps a clear image in the center.
- Auto:** Automatically adjusts the image based on the screen size and the TV program. **Note:** Auto is only available when **Auto Zoom** in the **CHANNELS** menu must be set to **On**.

- Power:** Turns your TV on or off.
- Quick Launch Inputs:** Selects another video source connected to your TV.
- Numbers:** Enter channel numbers. Enter a digital sub-channel number (e.g. 4.1).
- ENTER:** Confirms selections or changes.
- MENU:** Opens the on-screen menu.
- EXIT:** Closes the on-screen menu.
- INPUT:** Opens the Input Source list.
- CH-LIST:** Opens the channel list.
- Volume:** Changes the volume.
- SLEEP:** Sets the sleep timer.
- ZOOM:** Changes how the picture displays on the screen.
- RECALL:** Returns to the previous channel.
- Arrows:** Navigates in on-screen menus.
- HOME:** Opens the on-screen menu.
- INFO\*:** Opens a TV status banner.
- CCD:** Turns closed captioning on or off.
- FAVORITE:** Opens the Favorite Channel List.
- MUTE:** Mutes the sound.
- Channel:** Changes the TV channels.
- PICTURE:** Selects the video modes.
- MTS/SAP:** Cycles through mono, stereo, and secondary audio for analog programs.
- AUDIO:** Selects the audio modes.
- Media Controls:** Control HDMI-CEC devices connected to your TV.

### Programming your remote control

To program your universal remote control to work with your new Insignia TV, see the table for common codes. If you have problems programming your remote or need a different remote control code, visit [www.insigniaproducts.com](http://www.insigniaproducts.com) for the latest remote control code information.

Universal remote TV codes												
Universal remote controls				Cable/Satellite/Set-top box								
Philips	RCA	One for All	Sony	Comcast	DirectTV	Dish Network	Time Warner		Cox	Charter	Verizon	Cablevision
0198, 0490	135	0054	068, 069, 078, 096, 100, 164, 168, 229, 026	10171, 11204, 11326, 11517, 11641, 11780, 11892, 11963, 12002	10171, 11204, 11326, 11517, 11564, 11641, 11963, 12002	720	450, 461, 456	1326	2002, 1204, 1423, 1517, 0171, 1963, 0463, 0842, 1326, 167, 415, 424, 450, 456, 461, 507, 523, 567, 577, 586	0198, 0490	068, 069, 078, 096, 100, 164, 168, 229, 026	0091

### Turning on your TV for the first time

- 1 Connect your TV to a power outlet, then press **Power**. The **Choose Your Menu Language** screen opens.
- 2 Press **▲** or **▼** to highlight a language, then press **ENTER**. The **Choose Your Time Setting** screen opens with **Mode** highlighted.
- 3 Press **◀** or **▶** to select **Auto** or **Manual**, then press **ENTER**. If you select **Auto**, the date and time are set automatically from a digital TV signal. If you select **Manual**, you can manually set the date and time. Press **ENTER**.
- 4 Press **▲** or **▼** to highlight **Home Mode** or **Retail Mode**, then press **ENTER**. If you select Retail Mode, a message asks you to confirm your selection. Select **Yes** or **No**. **Retail Mode** is not an energy-saving mode.
- 5 Press **▲** or **▼** to highlight **Antenna**, **Cable**, or **Satellite Box**, then press **ENTER**.
  - A. If you select **Antenna**, your TV scans for available channels. The scan may take several minutes.
  - B. If you select **Cable**, a message asks if you have a cable box.
    - Select **No** if no cable box is connected. Your TV scans for available channels. The scan may take several minutes.
    - Select **Yes** if a cable box is connected. A message asks how you connected the cable box to your TV.
    - Select **AV**, **Component**, or **HDMI** if you connected a cable box to your TV using one of these cables. Read the message, then press **ENTER** to close the wizard.
    - Select **Coaxial** if you connected a cable box to your TV using a coaxial cable. Read the message, then press **ENTER** to start the channel scan (VHF channels only).
  - C. If you select **Satellite Box**, a message asks how you connected the satellite box to your TV.
    - Select **AV**, **Component**, or **HDMI** if you connected a satellite box to your TV using one of these cables. Read the message, then press **ENTER** to close the wizard.
    - Select **Coaxial** if you connected a satellite box to your TV using a coaxial cable. Read the message, then press **ENTER** to start the channel scan (VHF channels only).

### Connecting a home theater system with multiple devices

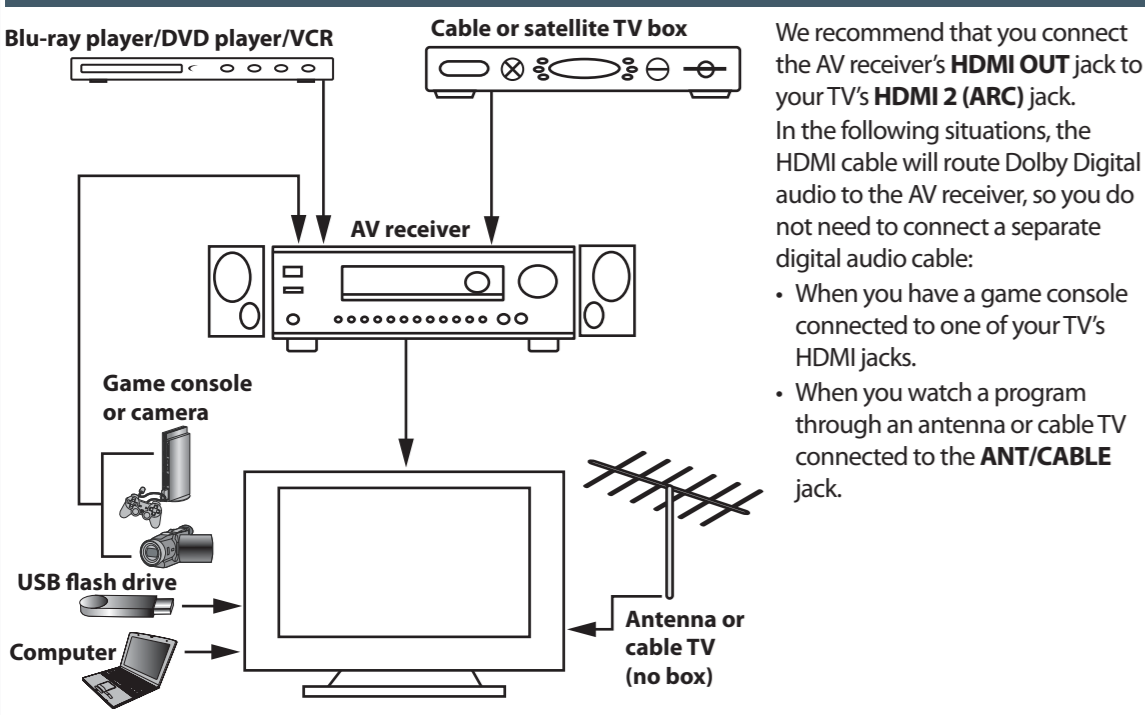

### Connecting power

Plug the AC power cord into a power outlet.

#### Note

The AC power cord is attached on the back of the TV when shipped, and cannot be pulled out from the TV.

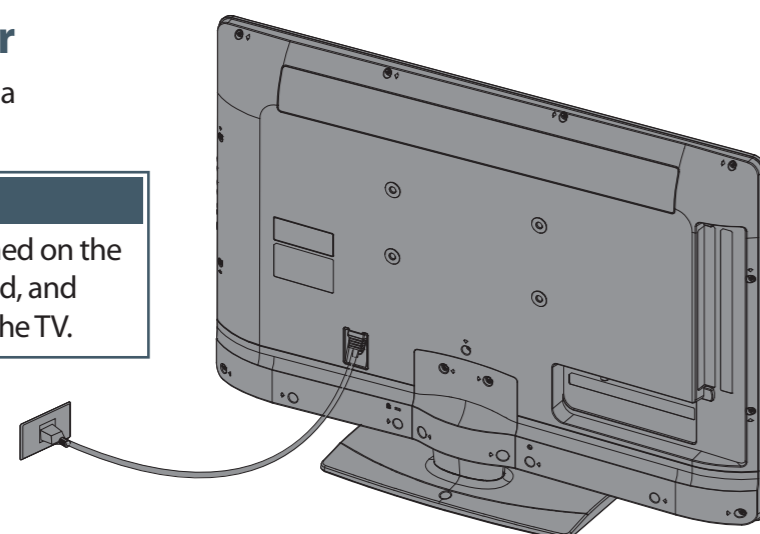

### One-year limited warranty

Visit [www.insigniaproducts.com](http://www.insigniaproducts.com) for details.

### Need additional help?

See your **Online User Guide**! This comprehensive guide includes everything from basic how-to steps to more advanced features. A copy of your **User Guide** is not provided in the box but is available online. Go to [www.insigniaproducts.com](http://www.insigniaproducts.com), click **Support & Service**, enter your model number in the **Product Search** field, then click **Search**.

Check out our online **community forum** at [www.insigniaproducts.com](http://www.insigniaproducts.com) for helpful information from other Insignia TV owners.

### We're here for you

[www.insigniaproducts.com](http://www.insigniaproducts.com)

For customer service, call:

**877-467-4289 (U.S./Canada markets)**

Distributed by Best Buy Purchasing, LLC  
7601 Penn Avenue South, Richfield, MN USA 55423-3645

© 2012 BBY Solutions, Inc.

All rights reserved. INSIGNIA is a trademark of BBY Solutions, Inc. Registered in some countries. All other products and brand names are trademarks of their respective owners.

### WE ARE GOING GREEN!

A copy of your **User Guide** is not provided in the box but is available online. Go to [www.insigniaproducts.com](http://www.insigniaproducts.com), click **Support & Service**, enter your model number in the **Product Search** field, then click **Search**.

