

AV Receiver

DTR-30.6

Advanced Manual

Integra

Contents

AM/FM Radio Receiving Function	2	Remote Controller Buttons	14	Satellite Receiver/Cable Receiver Operation	46
Tuning into a Radio Station	2	Icons Displayed during Playback	14	CD Player Operation	46
Registering an AM/FM Radio Station	2	Using the Listening Modes	15	Cassette Tape Deck Operation	47
Using RDS (Australian model)	3	Selecting Listening Mode	15	To Operate CEC-compatible Components	47
Playing Content from a USB Storage Device	4	Contents of Listening Modes	16	Advanced Speaker Connection	48
Listening to Internet Radio	5	Checking the Input Format	18	Bi-Amping	48
About Internet Radio	5	Advanced Settings	19	Connecting a Power Amplifier	48
Tuneln	5	How to Set	19	Connecting and Operating Onkyo RI Components	49
Pandora®—Getting Started (U.S., Australia and New Zealand only)	6	1.Input/Output Assign	20	About RI Function	49
SiriusXM Internet Radio (North American only)	7	2.Speaker Setup	23	RI Connection and Setting	49
Slacker Personal Radio (North American only)	8	3.Audio Adjust	25	iPod/iPhone Operation	50
Registering Other Internet Radios	9	4.Source Setup	27	Control Function between the Unit and External Component	51
DLNA Music Streaming	11	5.Listening Mode Preset	30	Firmware Update	52
About DLNA	11	6.Miscellaneous	31	About Firmware Update	52
Configuring the Windows Media Player	11	7.Hardware Setup	37	Updating the Firmware via Network	52
DLNA Playback	11	8.Remote Controller Setup	42	Updating the Firmware via USB	53
Controlling Remote Playback from a PC	12	9.Lock Setup	42	Troubleshooting	55
Music Streaming from a Shared Folder	12	Operating Other Components Using Remote Controller	43	Reference Information	62
About Shared Folder	12	Functions of Remote Mode Buttons	43		
Setting PC	13	Programming Remote Control Codes	43		
Playing from a Shared Folder	13	TV Operation	44		
Using Remote Controller for Playing Music Files	14	Blu-ray Disc Player/DVD Player/DVD Recorder Operation	45		
About the Remote Controller	14	VCR/PVR Operation	45		

AM/FM Radio Receiving Function

Tuning into a Radio Station

■ Tuning into stations automatically

1. Press Tuner on the main unit several times to select either "AM" or "FM".

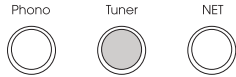

2. Press Tuning Mode so that the "AUTO" indicator on the display stays lit.

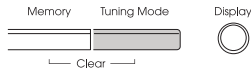

3. Press Tuning ▲ ▼ to start automatic tuning.

- Searching automatically stops when a station is found. When tuned into a radio station, the "▶TUNED◀" indicator on the display lights. When tuned into an FM radio station, the "FM STEREO" indicator lights.
- No sound is output while the "▶TUNED◀" indicator is off.

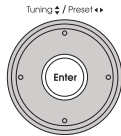

When the signal from an FM radio station is weak: Radio wave may be weak depending on the building structure and environmental conditions. In that case, manually tune into the radio station of your choice by referring to the next section.

■ Tuning into stations manually

1. Press Tuner on the main unit several times to select either "AM" or "FM".

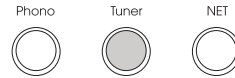

2. Press Tuning Mode so that the "AUTO" indicator on the display goes off.

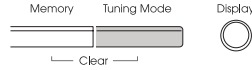

3. Press Tuning ▲ ▼ to select the desired radio station.

- The frequency changes by 1 step each time you press the button. The frequency changes continuously if the button is held down and stops when the button is released. Tune by looking at the display.

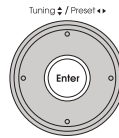

To return the display to "AUTO": Press Tuning Mode on the main unit again. The unit is automatically tuned into an FM radio station. Normally "AUTO" should be displayed.

■ Tuning into stations by frequency

It allows you to directly enter the frequency of the radio station you want to listen to.

1. Press Tuner on the remote controller several times to select either "AM" or "FM".

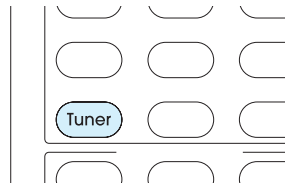

AM/FM Radio Receiving Function

2. Press D.TUN.

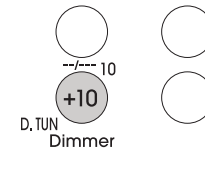

3. Using the number buttons, enter the frequency of the radio station within 8 seconds.

- To enter 87.5 (FM), for example, press 8, 7, 5, or 8, 7, 5, 0. If you entered a wrong number, you can enter a correct one after 8 seconds.

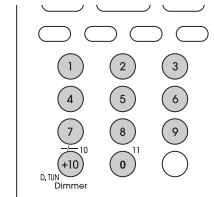

Registering an AM/FM Radio Station

It allows you to register up to 40 of your favorite AM/FM radio stations. Registering radio stations in advance allows you to tune into your radio station of choice directly.

■ Registering a Station

1. Tune into the AM/FM radio station you want to register.
2. Press Memory on the main unit so that the preset number on the display flashes.

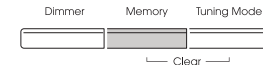

3. Press Preset ◀ ▶ several times to select a number between 1 and 40 while the preset number is flashing (about 8 seconds).

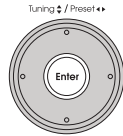

4. Press Memory again to register the station.
 - When the station is registered, the preset number stops flashing.
 - Repeat this procedure for all of your favorite AM/FM radio stations.

■ Selecting a Preset Radio Station

1. Press CH +/- on the remote controller to select a preset number.
 - Alternatively you can press Preset ◀ ▶ on the main unit. You can also select by directly entering the preset number with the number buttons on the remote controller.

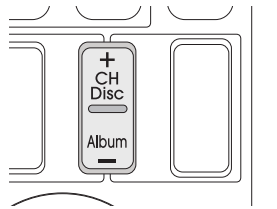

■ Deleting a Preset Radio Station

1. Press CH +/- on the remote controller to select the preset number to delete.

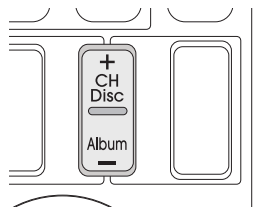

2. Press and hold Memory on the main unit and press Tuning Mode to delete the preset number.
 - When deleted, the number on the display goes off.

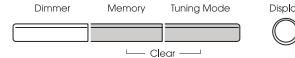

Using RDS (Australian model)

RDS stands for Radio Data System and is a method of transmitting data in FM radio signals.

- RDS works only in areas where RDS broadcasts are available.
- In some cases, the text information appeared on the display is not identical to the content transmitted by the RDS station. Furthermore, unexpected characters may be displayed when the unit receives unsupported characters. However, this is not a malfunction.
- If the signal from an RDS station is weak, the RDS data may be displayed continuously or not at all.

PS (Program Service): Tuning into a radio station distributing Program Service information displays the radio station name. Pressing DISPLAY displays the frequency for 3 seconds.

RT (Radio Text): Tuning into a radio station transmitting Radio Text information displays text on the display of the unit.

PTY (Program Type): Allows you to search for RDS stations by program type.

TP (Traffic Program): Allows you to search for radio stations transmitting traffic information.

■ Displaying Radio Text (RT)

1. Press RT/PTY/TP on the main unit once.
 - The Radio Text (RT) is displayed scrolling across the display. "No Text Data" is displayed when no text information is available.



■ Searching by Type (PTY)

1. Press RT/PTY/TP on the main unit twice.
 - The current program type appears on the display.



2. Press Preset ◀ ▶ to select the type of program to search for.

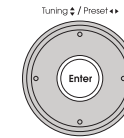

- The following RDS station types are displayed:
 - None
 - News (News reports)
 - Affairs (Current affairs)
 - Info (Information)
 - Sport
 - Educate (Education)
 - Drama
 - Culture
 - Science (Science and technology)
 - Varied
 - Pop M (Pop music)
 - Rock M (Rock music)
 - Easy M (Middle of the road music)
 - Light M (Light classics)
 - Classics (Serious classics)
 - Other M (Other music)
 - Weather
 - Finance
 - Children (Children's programmes)
 - Social (Social affairs)
 - Religion
 - Phone In
 - Travel
 - Leisure
 - Jazz (Jazz music)
 - Country (Country music)
 - Nation M (National music)

- Oldies (Oldies music)
- Folk M (Folk music)
- Document (Documentary)

3. Press Enter to search the radio stations of the selected type.

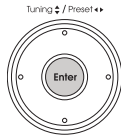

4. When such a radio station is found, the indication on the display flashes. Then, press Enter again.
 - If no stations are found, the message "Not Found" is displayed.

■ Listening to Traffic Information (TP)

1. Press RT/PTY/TP on the main unit three times.
 - "[TP]" will be displayed if traffic information is transmitted by the radio station you are tuned in.
 - "TP" only is displayed if no traffic information is available.

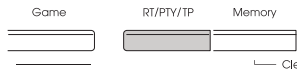

2. Press Enter to search a radio station distributing traffic information.

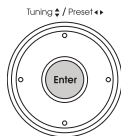

3. When such a radio station is found, the indication on the display flashes. Then, press Enter again.
 - "Not Found" is displayed if no radio station distributing traffic information is found.

Playing Content from a USB Storage Device

● **Operation:** You can set up by viewing the guidance displayed on the TV screen. To display the guidance, you need to make HDMI connection between the unit and TV. Select the item with the cursor buttons of the remote controller and press Enter to confirm your selection. To return to the previous screen, press Return.

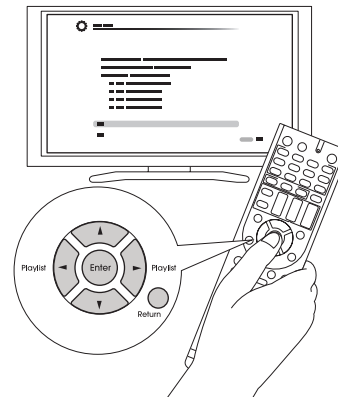

■ Playing Back

1. Press USB on the remote controller to select "USB".

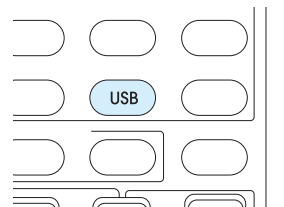

2. Plug your USB storage device with the music files into the USB port of the unit so that "USB" lights on the display.
 - If the "USB" indicator flashes, check whether the USB storage device is plugged in properly.
 - Do not unplug the USB storage device while "Connecting..." is appeared on the display. This may cause data corruption or malfunction.

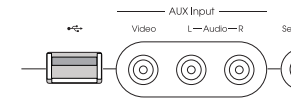

3. Press Enter.
 - The list of folders and music files on the USB storage device is displayed. Select the folder with the cursors and press Enter to confirm your selection.
4. With the cursors, select the music file to play, and then press Enter or ► to start playback.

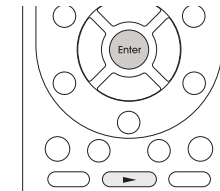

Listening to Internet Radio

About Internet Radio

Internet radio, also called net radio, web radio or streaming radio, is an audio service accessible at the websites of service providers who distribute music and audio programs in digital format. There are numerous websites all over the world, from terrestrial station, special station to personal website that provide such a service.

The unit comes preset with Internet radio stations (*) such as TuneIn for you to enjoy these services, just by connecting the unit to the Internet.

* Network services or contents may become unavailable if the service provider terminates its service.

TuneIn

With more than 70,000 radio stations and 2 million on-demand programs registered, TuneIn is a service where you can enjoy music, sports and news from all over the world.

● **Operation:** You can set up by viewing the guidance displayed on the TV screen. To display the guidance, you need to make HDMI connection between the unit and TV. Select the item with the cursor buttons of the remote controller and press Enter to confirm your selection. To return to the previous screen, press Return.

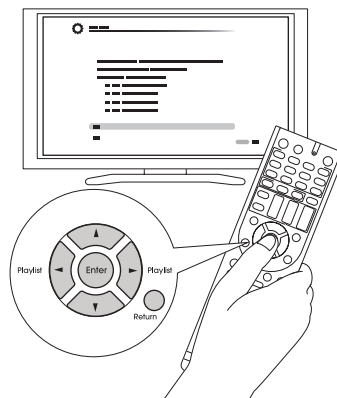

■ Playing Back

1. Press NET on the remote controller to display NET TOP screen.
 - The "NET" indicator on the display stays lit.
 - Alternatively you can select "Network Service" in the Home menu.

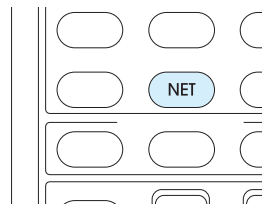

2. Select "TuneIn" with the cursors and press Enter to display the TuneIn top screen.
3. With the cursors, select a radio station or program and press Enter to start playing.

■ Regarding the TuneIn Menu

To display the TuneIn menu, press Menu while playing a radio station, or select "Go to Menu" and press Enter. Selecting the corresponding menu item with the cursors and pressing Enter allows you to perform the following operations:

Add to My Presets: Registers radio stations and programs in your "My Presets" within TuneIn. This allows you to play registered radio stations and programs with a simple operation. ("My Presets" is not displayed if it is empty.)

Remove from My Presets: Deletes a radio station or program from your "My Presets" within TuneIn.

Report a problem: Reports a problem or interactively solves a problem related to TuneIn.

View Schedule: Displays the radio station or program schedule.

Clear recents: Clears all radio stations and programs from the "Recents" within TuneIn. (This menu is displayed only when a radio station or program inside the "Recents" is being played.)

Add to My Favorites: Registers radio stations and programs in "My Favorites" of "Network Service". This allows you to play registered radio stations and programs with a simple operation.

■ Regarding the TuneIn Account

Creating an account on the TuneIn website (tunein.com) and logging in it from the unit allows you to automatically add radio stations and programs to your "My Presets" on the unit as you save them on the website.

To display a radio station registered in "My Presets", you must log into TuneIn from the unit. To log in, select "Login" - "I have a TuneIn account" in the "TuneIn" top list on the unit, and then enter your user name and password.

- If you associate the device on My Page within the TuneIn website using the registration code obtained by selecting "Login" - "Login with a registration code" on the unit, you can log in without entering the user name and password.

Pandora®—Getting Started (U.S., Australia and New Zealand only)

Pandora is a free, personalized Internet radio service that plays the music you know and helps you discover music you'll love.

● **Operation:** You can set up by viewing the guidance displayed on the TV screen. To display the guidance, you need to make HDMI connection between the unit and TV. Select the item with the cursor buttons of the remote controller and press Enter to confirm your selection. To return to the previous screen, press Return.

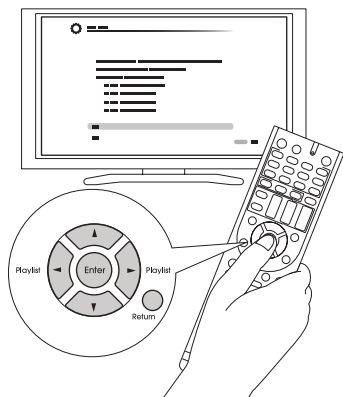

■ Playing Back

1. Press NET on the remote controller to display NET TOP screen.
 - The "NET" indicator on the display stays lit. To display NET TOP screen, you can alternatively press Home, select Network Service on the displayed Home menu, and then press Enter.

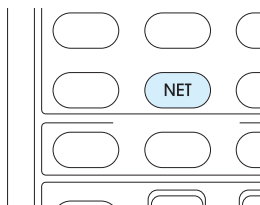

2. Select "Pandora" with the cursors, and then press Enter.
3. Use ▲/▼ to select "I have a Pandora Account" or "I'm new to Pandora" and then press Enter.

If you are new to Pandora select "I'm new to Pandora". You will see an activation code on your TV screen. Please write down this code. Go to an Internet connected computer and point your browser to www.pandora.com/onkyo. Enter your activation code and then follow the instructions to create your Pandora account and your personalized Pandora stations. You can create your stations by entering your favorite tracks and artists when prompted. After you have created your account and stations you can return to your Integra/Onkyo AV receiver and press Enter to begin listening to your personalized Pandora.

If you have an existing Pandora account, you can add your Pandora account to your Integra/Onkyo receiver by selecting "I have a Pandora Account" and logging in with your email and password.

 - If you want to use multiple user accounts, see "Using Multiple Accounts". Login can be made from the "Users" screen.
4. To play a station, use ▲/▼ to select the station from your station list, and then press Enter. Playback starts and the playback screen appears.

■ Create a New Station

Enter the name of a track, artist, or genre and Pandora will create a unique radio station for you based on the musical qualities of that track, artist, or genre.

I like this track: Give a track "thumbs-up" and Pandora will play more music like it.

I don't like this track: Give a track "thumbs-down" and Pandora will ban that track from the current station.

Why is this track playing?: Discover some of the musical attributes that Pandora uses to create your personal radio stations.

I'm tired of this track: If you are tired of a track, you can put the track to sleep and Pandora will not play it for one month.

Create station from this artist: Creates a radio station from this artist.

Create station from this track: Creates a radio station from this track.

Delete this station: This will permanently delete a station from your Pandora account. All of your thumbs feedback will be lost should you choose to re-create the station with the same track or artist.

Rename this station: Lets you rename the current radio station.

Bookmark this artist: Pandora will bookmark your favorite artist for your profile on www.pandora.com.

Bookmark this track: Pandora will bookmark the current track and allow you to buy them all from Amazon or iTunes in one step!

Add to My Favorites: Adds a station to My Favorites list.

PANDORA

PANDORA, the PANDORA logo, and the Pandora trade dress are trademarks or registered trademarks of Pandora Media, Inc. Used with permission.

SiriusXM Internet Radio (North American only)

If you want to listen to the service, you must subscribe. To subscribe go to www.siriusxm.com/internetradio with your computer. When you subscribe, you will be provided with a username and password which has to be entered into the AV receiver. To use SiriusXM Internet Radio, you must have your AV receiver connected to the Internet. Using the remote control, follow these steps:

● **Operation:** You can set up by viewing the guidance displayed on the TV screen. To display the guidance, you need to make HDMI connection between the unit and TV. Select the item with the cursor buttons of the remote controller and press Enter to confirm your selection. To return to the previous screen, press Return.

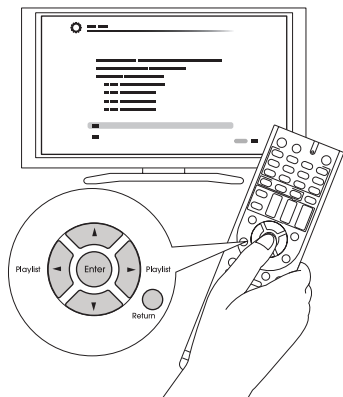

■ Playing Back

1. Press NET on the remote controller to display NET TOP screen.
 - The "NET" indicator on the display stays lit. To display the NET TOP screen, you can alternatively press Home, select "Network Service" on the displayed Home menu, and then press Enter.

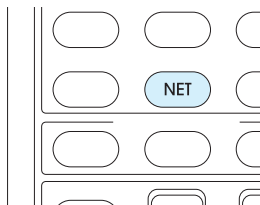

2. Select "SiriusXM Internet Radio" with the cursors, and then press Enter.
3. Select "Sign In", and then press Enter. If you have an existing SIRIUS account, you can sign in by selecting "Sign In". Enter your user name and password in the next keyboard screen, or in Web Setup. If you don't know your username or password, call Sirius XM at (888) 539-7474 for assistance.
 - If you want to use multiple user accounts, see "Using Multiple Accounts". Login can be made from the "Users" screen.

Using the keyboard screen

- ① Use ▲/▼/◀/▶ and Enter to enter your user name and password.
 - ② Select "OK".
 - ③ Press Enter. The "Confirm your entries" screen appears.
 - ④ Press Enter. "Please wait..." appears and then "SiriusXM Internet Radio" screen appears which displays the category available for selection.
4. Use ▲/▼ to select the category and then press Enter.
 - The channel list screen for the selected category appears.

5. Use ▲/▼ to select the desired channel and then press Enter.
 - The playback screen for the selected channel appears and you can listen to SiriusXM Internet Radio. You can control the tracks with the buttons on the remote control.
Enabled buttons: ▶, ■, ◀◀, ▶▶

Add to My Favorites: Adds a channel to My Favorites list.

Add to Presets: Adds the currently playing station to presets list.

Delete from Presets: Deletes the currently playing station from presets list.



SiriusXM Internet Radio subscriptions are sold separately and are governed by the Sirius Terms and Conditions (see www.sirius.com). Be sure to read this agreement before you purchase your subscription. Sirius, XM and all related marks and logos are trademarks of Sirius XM Radio Inc. and its subsidiaries. All rights reserved.

Slacker Personal Radio (North American only)

● **Operation:** You can set up by viewing the guidance displayed on the TV screen. To display the guidance, you need to make HDMI connection between the unit and TV. Select the item with the cursor buttons of the remote controller and press Enter to confirm your selection. To return to the previous screen, press Return.

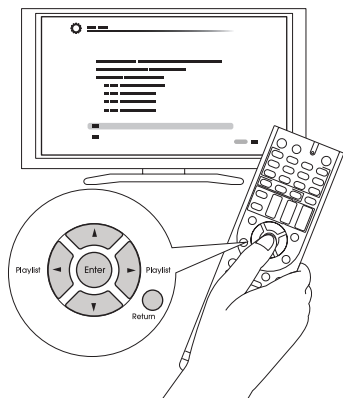

■ Playing Back

1. Press NET on the remote controller to display NET TOP screen.
 - The "NET" indicator on the display stays lit. To display the NET TOP screen, you can alternatively press Home, select "Network Service" on the displayed Home menu, and then press Enter.

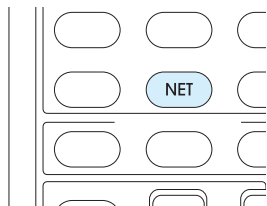

2. Select "Slacker Personal Radio" with the cursors, and then press Enter.

3. If you do not have an account, create one on the Slacker website (www.slacker.com) with your computer. If you already have a Slacker account, select "Sign in to your account" and then press Enter. The keyboard screen appears. You can enter information from the remote control or the keys on the main unit.
4. If there are no mistakes in the information you have entered, use ▲/▼/◀/▶ to select "OK" then press Enter. An account information confirmation screen appears.
5. If you do not have an account, select "Access without Sign In" and press Enter to use a restricted version of the service. Note that use will be restricted.
 - If you want to use multiple user accounts, see "Using Multiple Accounts". Login can be made from the "Users" screen.
6. Use ▲/▼ to select a menu item and then press Enter.
 - To sign out, use ▲/▼ to select "Sign out" from this screen and then press Enter.
7. Use ▲/▼ to select a station and then press Enter or ▶ to start playback from the station. The playback screen appears.
8. You can control the tracks with the buttons on the remote control.
Enabled buttons: ▶, ||, ■, ▶▶

Rate Song as Favorite: Stores information to server, making it more likely that the song will be played again.

Ban Song: Stores information to server, making it less likely that the song will be played again.

Ban Artist: Stores information to server, making it less likely that the songs from this artist will be played again.

Mark Favorite: Adds the currently playing station to your favorites.

Unmark Favorite: Deletes the currently playing station from your favorites.

Add song to Library: Adds the currently playing track to your library.

Delete song from Library: Deletes the currently playing track from your library.

Add to My Favorites: Adds a station or song to My Favorites list.

Using Multiple Accounts: The AV receiver supports multiple user accounts, which means you can freely switch between several logins. After registering user accounts, login is performed from the "Users" screen.

Press Menu while the Users screen is displayed. "Add new user", "Remove this user" menu appear. You can either store a new user account, or delete an existing one.

- Some of the services don't allow the use of multiple user accounts.
- You can store up to 10 user accounts.
- To switch between accounts you must first log out from the current account, and log in again on the "Users" screen.

Registering Other Internet Radios

To listen to other Internet radio program, register the program in the "My Favorites" list on the NET TOP screen as described below. The unit supports Internet radio stations stored in the following formats: PLS (URL ending in .pls), M3U (URL ending in .m3u) and RSS (URL ending in rss/rd/ xml).

- You can register up to 40 Internet radio stations.
- Depending on the data type and file format for playback, you may not be able to play an Internet radio station even when its format is PLS, M3U or Podcast (RSS).
- Available services may vary depending on your area of residence.

● **Operation:** You can set up by viewing the guidance displayed on the TV screen. To display the guidance, you need to make HDMI connection between the unit and TV. Select the item with the cursor buttons of the remote controller and press Enter to confirm your selection. To return to the previous screen, press Return.

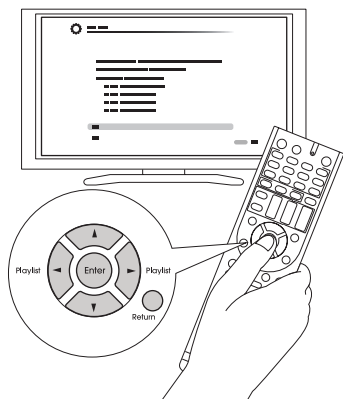

Registering a Station

Before starting the procedure: The name and URL of the radio station that you want to add are required for registration. Check them before starting the procedure.

1. Press NET on the remote controller to display NET TOP screen.
 - The "NET" indicator on the display stays lit.

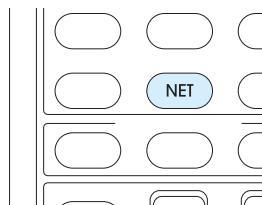

2. Select "My Favorites" with the cursors and press Enter to display the "My Favorites" list screen.
3. Select a blank area of "My Favorites" with the cursors, and press Menu to display the menu screen.

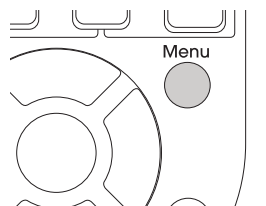

4. Select "Create new station" with the cursors and press Enter to display the keyboard screen.
5. Enter the name and URL of the radio station to add.
 - Select "Shift" and press Enter to toggle between upper and lower case. Select "←" or "→" and press Enter to move the cursor to the selected direction. Select "Back Space" and press Enter to delete the character at the left of the cursor position.

Registering a Station with PC

Before starting the procedure: The name and URL of the radio station that you want to add are required for registration. Check them before starting the procedure.

1. Press RCV on the remote controller.
 - Always press RCV first to change the remote controller to Receiver mode (the mode to operate this unit) since its mode may be changed to operate another component.

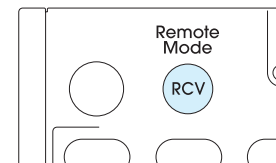

2. Press Home to display the Home menu.

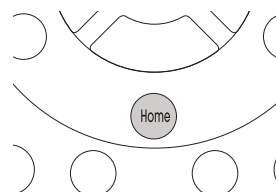

3. Select "Setup" with the cursors and then press Enter.
4. With the cursors, select "7.Hardware Setup" - "Network" - "IP Address" to display the IP address.
 - Write down the IP address since you will need it later.
5. Open the Internet browser on your PC or smartphone and enter the IP address of the unit in the URL field. When using Internet Explorer, you can alternatively select "Open" in the "File" menu to enter the IP address.
 - Information of the unit is displayed on the browser. ("WEB Setup")
6. Click "My Favorites" tab, then enter the name and URL of the Internet radio station.
7. Click "Save" to register the entered Internet radio station in "My Favorites".

To rename the registered radio station: While the radio station is being played or when it is selected from the "My Favorites" list, press Menu to display the menu screen. Select "Rename this station" with the cursors and press Enter to display the keyboard screen. Rename the station as desired.

- Radio stations can be renamed also from "WEB Setup".

■ Playing a Registered Radio Station

1. Press NET on the remote controller to display NET TOP screen.
 - The "NET" indicator on the display stays lit.

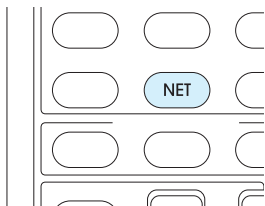

2. Select "My Favorites" with the cursors and press Enter to display the registered Internet radio stations.
3. Select a radio station with the cursors and press Enter to start playing.

■ Deleting a Registered Radio Station

1. Press NET on the remote controller to display NET TOP screen.
 - The "NET" indicator on the display stays lit.

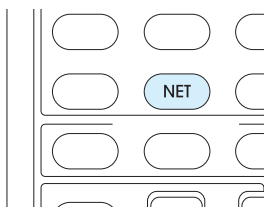

2. Select "My Favorites" with the cursors and press Enter to display the registered Internet radio stations.

3. Select the radio station with the cursors to delete and press Menu to display the menu screen.
 - You can also display the menu screen by pressing Menu while the radio station is being played.

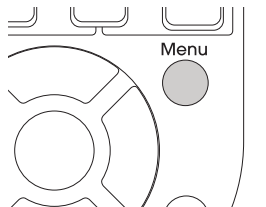

4. Select "Delete from My Favorites" with the cursors and then press Enter.
 - Radio stations can be deleted also from "WEB Setup".

DLNA Music Streaming

About DLNA

Digital Living Network Alliance (DLNA) can be referred to as a technology standard or the industry group to develop the technology standard to interconnect and use AV components, PCs and other devices in a home network (more precisely the technology standard is called the DLNA guidelines).

The unit allows you to use DLNA to play music files stored on a PC or a hard disk connected to your home network (NAS device). Make sure the unit and PC or NAS device are connected to the same router.

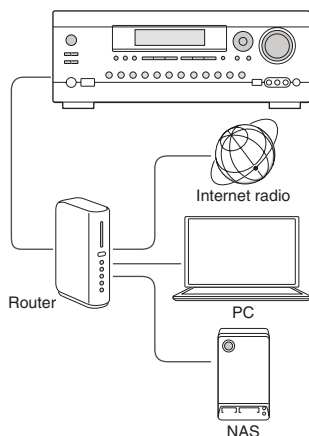

- To play a music file with DLNA, you need a NAS device or the like with DLNA server functions and a DLNA player (software) to stream the music. You can also stream music files using a PC installed with Windows Media Player 11 or 12 as they are equipped with both DLNA server and player functions. To enable streaming, you must first configure the Windows Media Player 11 or Windows Media Player 12.

- With Windows Media Player 12 Remote Playback function, you can stream music files stored on your PC to the unit by operating the PC.

Configuring the Windows Media Player

Windows Media Player 11

- Turn on your PC and start Windows Media Player 11.
- In the "Library" menu, select "Media Sharing" to display a dialog box.
- Select the "Share my media" check box, and then click "OK" to display the compatible devices.
- Select this unit, and then click "Allow".
 - When it is clicked, the corresponding icon is checked.
- Click "OK" to close the dialog.

Windows Media Player 12

- Turn on your PC and start Windows Media Player 12.
- In the "Stream" menu, select "Turn on media streaming" to display a dialog box.
 - If media streaming is already turned on, select "More streaming options..." in the "Stream" menu to list players in the network, and then go to step 4.
- Click "Turn on media streaming" to list players in the network.
- Select this unit in "Media streaming options" and check that it is set to "Allow".
- Click "OK" to close the dialog.

DLNA Playback

Operation: You can set up by viewing the guidance displayed on the TV screen. To display the guidance, you need to make HDMI connection between the unit and TV. Select the item with the cursor buttons of the remote controller and press Enter to confirm your selection. To return to the previous screen, press Return.

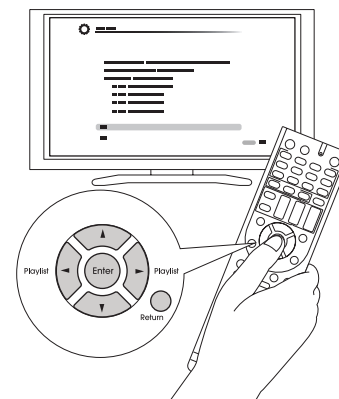

Playing Back

- Start the server (Windows Media Player 11, Windows Media Player 12, or NAS device) containing the music files to play.
- Press NET on the remote controller to display NET TOP screen.
 - The "NET" indicator on the display stays lit. If the "NET" indicator flashes, the unit is not properly connected to the network. When using a wired LAN connection, check the Ethernet cable connection, and when using a wireless LAN connection, check whether the "Wi-Fi" indicator on the left side of the unit stays lit.

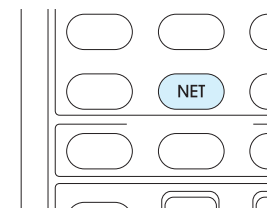

- Select "DLNA" with the cursors and press Enter.
- Select the target server with the cursors and press Enter to display the items list screen.
 - Searching does not work in servers that do not support search functions.

- The unit cannot access pictures and videos stored on servers.
 - Contents stored on the server may not be displayed depending on the server sharing settings.
- With the cursors, select the music file to play, and then press Enter or  to start playback.
 - If "No Item" is displayed, check whether the network is properly connected.

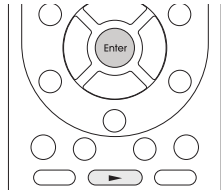

Controlling Remote Playback from a PC

You can use this unit to play music files stored on your PC by operating the PC inside your home network. The unit supports remote playback with Windows Media Player 12. To use the remote playback function with Windows Media Player 12, Windows Media Player 12 must be configured in advance.

- Using a DLNA-compatible controller (such as an Android application), you can select a music file stored on Windows Media Player 12 and stream to this unit by operating the controller. For information on how to remotely play using the controller, refer to the controller's instruction manual.

Setting PC

- Turn on your PC and start Windows Media Player 12.
- In the "Stream" menu, select "Turn on media streaming" to display a dialog box.
 - If media streaming is already turned on, select "More streaming options..." in the "Stream" menu to list players in the network, and then go to step 4.
- Click "Turn on media streaming" to list players in the network.

- Select this unit in "Media streaming options" and check that it is set to "Allow".
- Click "OK" to close the dialog box.
- Open the "Stream" menu and check that "Allow remote control of my Player..." is checked.

Remote playback

- Turn on the power of the unit.
- Turn on your PC and start Windows Media Player 12.
- Select and right-click the music file to play with Windows Media Player 12.
 - To remotely play a music file on another server, open the target server from "Other Libraries" and select the music file to play.
- Select this unit in "Play to" to open the "Play to" window of Windows Media Player 12 and start playback on the unit.
 - Operations during remote playback are possible from the "Play to" window on the PC. The playback screen is displayed on the TV connected to the HDMI output of the unit. If your PC is running on Windows 8, click "Play to", and then select this unit.
- Adjust the volume using the volume bar on the "Play to" window.
 - Sometimes, the volume displayed on the remote playback window may differ from that appeared on the display of the unit.
 - When the volume is adjusted from the unit, the value is not reflected in the "Play to" window.
 - This unit cannot play music files remotely in the following conditions.
 - It is using a network service.
 - It is playing a music file on a USB storage device.
 - "Agree" was not selected in the DISCLAIMER screen that was displayed when the NET input was selected on the unit for the first time.

Music Streaming from a Shared Folder

About Shared Folder

A shared folder is configured in a network device such as a PC or NAS (hard disk connected to your home network) for access from other users.

You can play music files in a shared folder on your PC or NAS connected to the same home network as that of the unit. To play music files in a shared folder, you must first configure Windows 8 or Windows 7. Make sure the unit and PC or NAS device are connected to the same router.

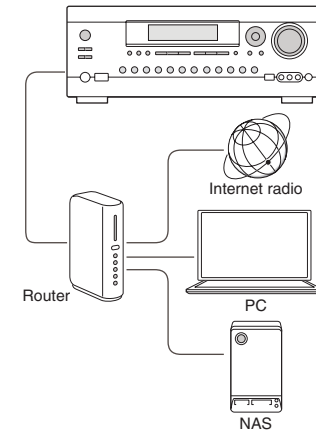

- The sharing options must be configured and a shared folder created on the PC in advance.
- For information on how to configure the NAS device and create a shared folder, refer to the NAS device's instruction manual.

Setting PC

■ Configuring the Sharing Options

1. Select "Choose Home group and Sharing Options" on the "Control Panel".
 - If the menu is not displayed, check whether "View by" is set to "Category".
2. Select "Change advanced sharing settings".
3. Check whether the following radio buttons are selected in "Home or Work":
 - "Enable network discovery"
 - "Turn on file and printer sharing"
 - "Turn on sharing so anyone with network access can read and write files in the Public folders"
 - "Turn off password protected sharing"
4. Select "Save Changes" and click "OK" on the dialog box.

■ Creating a Shared Folder

1. Select and right-click the folder to share.
2. Select "Properties".
3. Select "Advanced Sharing" on the "Sharing" tab.
4. Select "Share this folder" check box and click "OK".
5. Select "Share" for "Network File and Folder Sharing".
6. Select "Everyone" from the pull-down menu. Click "Add", and then "Share".
 - To set user name and password to a shared folder, set "Permissions" in "Advanced Sharing" on the "Sharing" tab.
 - Check whether a workgroup is set.

Playing from a Shared Folder

- **Operation:** You can set up by viewing the guidance displayed on the TV screen. To display the guidance, you need to make HDMI connection between the unit and TV. Select the item with the cursor buttons of the remote controller and press Enter to confirm your selection. To return to the previous screen, press Return.

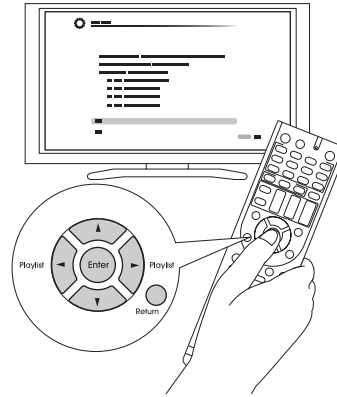

■ Playing Back

1. Press NET on the remote controller to display NET TOP screen.
 - The "NET" indicator on the display stays lit. If the "NET" indicator flashes, the unit is not properly connected to the network. When using a wired LAN connection, check the Ethernet cable connection, and when using a wireless LAN connection, check whether the "Wi-Fi" indicator on the left side of the unit is lit.

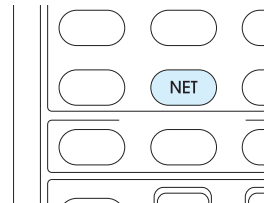

2. Select "Home Media" with the cursors and then press Enter.
3. Select the target server with the cursors and then press Enter.
 - You can check the server name of your PC from the PC properties.
4. Select the target shared folder with the cursors and then press Enter.
5. If a username and password is required, enter the necessary login information.
 - The login information is the account information set at the time of creating the shared folder.
 - Once entered, the login information will be remembered from the next time onward.
6. With the cursors, select the music file to play, and then press Enter or ► to start playback.

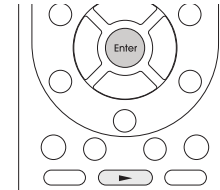

Using Remote Controller for Playing Music Files

About the Remote Controller

The remote controller of this unit allows you to play music files stored on USB storage devices, Internet radio, PCs and NAS devices on your home network, as well as on Bluetooth-enabled devices. It also allows you to view information of the music file being played and perform various other operations.

- Available buttons may vary depending on the service and device to play.
- Some buttons cannot be used with Bluetooth-enabled devices. Furthermore, the Bluetooth-enabled devices must support the AVRCP profile. Some devices may not be operated, even when they support AVRCP profile.

Remote Controller Buttons

1. Press Input Selector (PC, NET, USB or Bluetooth) appropriate for the input source on the remote controller.

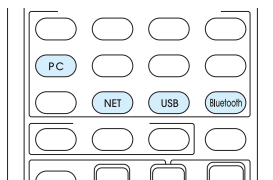

2. Operate the remote controller by referring to the name and function of each of the buttons below.

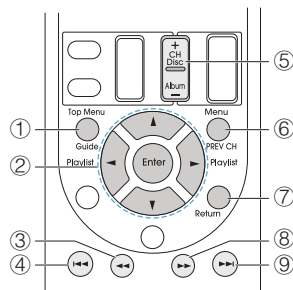

- 1 **Top Menu:** This button displays the top menu for each media or server.
- 2 **▲/▼, Enter:** These buttons navigate through items and activate the selected item.
◀▶: These buttons allow you to navigate to another page when the list is broken across several pages.
- 3 **◀◀:** This button fast-reverses the current track. This button is not operable from 10 seconds before the playback ends.
- 4 **◀◀◀:** This button plays the current track from the beginning. Pressing this button twice plays the previous track.
- 5 **CH +/- button:** Moves the cursor on the Internet radio stations list in "My Favorites".
- 6 **Menu:** This button displays the menu of each Internet radio service.
- 7 **Return:** This button returns to the previous screen.
- 8 **▶▶▶:** This button fast-forwards the current track. This button is not operable from 10 seconds before the playback ends.
- 9 **▶▶▶▶:** This button plays the next track.

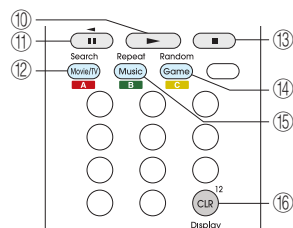

- 10 **▶:** This button starts the playback.

Using Remote Controller for Playing Music Files

- 11 **||:** This button pauses the playback.
- 12 **Search:** This button toggles between the playback screen and list screen during playback.
- 13 **■:** This button stops the playback.
- 14 **Random:** This button performs random playback.
- 15 **Repeat:** This button replays the track (or tracks). Pressing this button repeatedly cycles through the repeat modes.
- 16 **Display:** This button changes the displayed track information during playback. Pressing this button when the list screen is displayed toggles the screen to playback.

- Bluetooth-enabled devices: Usable buttons are ▶, ◀◀, ◀, ||, ▶▶, ▶▶▶▶, and ■.

Icons Displayed during Playback

Icons are displayed on the display during music file playback. The meaning of each icon is as follows:

📁: Folder

🎵: Track

▶: Play

⏸: Pause

⏩: Fast-forward

⏮: Fast-reverse

👤: Artist

📀: Album

🎵: Repeat One Track

📁: Repeat within a folder

🎵: Repeat

🎲: Shuffle

Using the Listening Modes

Selecting Listening Mode

The listening modes allow you to select the best sound effect for your input source.

1. Press RCV on the remote controller.
 - Always press RCV first to change the remote controller to Receiver mode (the mode to operate this unit) since its mode may be changed to operate another component.

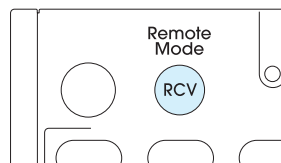

2. Press one of the following buttons depending on your choice from among the four listening modes.
 - Pressing a button changes the listening mode to that chosen. Set the listening mode of your choice by listening to the actual sound.

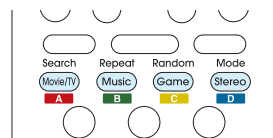

For details on the types and difference of listening modes, see "Contents of Listening Modes".

■ MOVIE/TV button

You can select a mode suitable for movies and TV programs.

- Selectable listening modes:
 - All Ch Stereo
 - Direct
 - Dolby D
 - Dolby D+
 - Dolby EX/Dolby D EX
 - Dolby TrueHD
 - DSD
 - DTS
 - DTS 96/24
 - DTS Express
 - DTS-HD HR
 - DTS-HD MSTR
 - ES Discrete
 - ES Matrix
 - Full Mono
 - Mono
 - Multichannel
 - Neo:6
 - Neo:6 Cinema
 - PLII Movie
 - PLIIx Movie/PLII Movie
 - PLIIz Height
 - T-D
 - TV Logic

■ MUSIC button

You can select a mode suitable for music.

- Selectable listening modes:
 - All Ch Stereo
 - Direct
 - Dolby D
 - Dolby D+
 - Dolby EX/Dolby D EX
 - Dolby TrueHD
 - DSD
 - DTS
 - DTS 96/24
 - DTS Express
 - DTS-HD HR

- DTS-HD MSTR
- ES Discrete
- ES Matrix
- Full Mono
- Multichannel
- Neo:6
- Neo:6 Music
- Orchestra
- PLII Music
- PLIIx Music/PLII Music
- PLIIz Height
- Stereo
- Studio-Mix
- Unplugged

■ GAME button

You can select a mode suitable for games.

- Selectable listening modes:
 - All Ch Stereo
 - Direct
 - Dolby D
 - Dolby D+
 - Dolby EX/Dolby D EX
 - Dolby TrueHD
 - DSD
 - DTS
 - DTS 96/24
 - DTS Express
 - DTS-HD HR
 - DTS-HD MSTR
 - ES Discrete
 - ES Matrix
 - Full Mono
 - Neo:6
 - Game-Action
 - Game-Rock
 - Game-RPG
 - Game-Sports
 - Multichannel
 - PLII Game
 - PLIIx Game/PLII Game
 - PLIIz Height
 - T-D

■ STEREO button

You can select a listening mode for stereo and all channel stereo sources.

- Selectable listening modes:
 - All Ch Stereo
 - Stereo

Contents of Listening Modes

Selectable listening modes will differ depending on the number of input source channels and the actual speaker configuration. Listening modes available when headphones are connected are: Mono, Direct, and Stereo.

Lists in alphabetic order (A-Z)

■ All Ch Stereo

Ideal for background music, this mode fills the entire listening area with stereo sound from the front, surround, and surround back speakers.

- Input source: MONO, STEREO, 5.1 ch, 7.1 ch
- Speaker configuration: 3.1 ch, 5.1 ch, 7.1 ch

■ Direct

In this mode, audio from the input source is output as-is. For example, if a 2 ch source from a music CD is input, the output will be stereo, or if Dolby Digital signal is input, the sound field will be controlled in accordance with the number of channels present.

- Input source: MONO, STEREO, 5.1 ch, 7.1 ch
- Speaker configuration: 2.1 ch, 3.1 ch, 5.1 ch, 7.1 ch

■ Dolby D (Dolby Digital)

This mode is for use with Dolby Digital sources. The audio from the input source is output as-is, without surround sound processing.

- Input source: 5.1 ch
- Speaker configuration: 3.1 ch, 5.1 ch, 7.1 ch
- This listening mode can be selected only if your Blu-ray Disc/DVD player is digitally connected to the unit or the player's output setting is bitstream.

■ Dolby D + (Dolby Digital Plus)

This mode is for use with Dolby Digital Plus sources. The audio from the input source is output as-is, without surround sound processing.

- Input source: 5.1 ch, 7.1 ch
- Speaker configuration: 3.1 ch, 5.1 ch, 7.1 ch
- This listening mode can be selected only if your Blu-ray Disc/DVD player is digitally connected to the unit or the player's output setting is bitstream.
- When playing back 5.1 ch sources from Blu-ray Discs, Dolby Digital is automatically applied.

■ Dolby EX/Dolby D EX

This mode expands any 5.1 ch music or movie source for 6.1/7.1 ch playback that can give an effect of surround back speaker. It is suitable for the Dolby EX soundtrack containing the matrix-encoded surround back channel. Adding the surround back effect to 5.1 ch source will improve spatial representation by creating a moving sound effect of 360-degree surround sound or overhead sound and giving a realistic experience.

- Input source: 5.1 ch
- Speaker configuration: 7.1 ch surround back
- This listening mode can be selected only if your Blu-ray Disc/DVD player is digitally connected to the unit or the player's output setting is bitstream.

■ Dolby Pro Logic II/Dolby Pro Logic II

This mode expands any 2 ch source for 7.1-ch playback. It provides a very natural and seamless surround-sound experience, keeping the sound clear.

- In case of 5.1 ch without surround back speaker, the mode becomes Dolby Pro LogicII instead of Dolby Pro Logic IIx.
- **PLIIx Movie/PLII Movie:** Use this mode with any 2 ch movie.
- **PLIIx Music/PLII Music:** Use this mode with any 2 ch music source.
- **PLIIx Game/PLII Game:** Use this mode with any 2 ch game source.
- Input source: STEREO, 5.1 ch (PLIIx Movie and PLIIx Music only)

- Speaker configuration: 3.1 ch, 5.1 ch, 7.1 ch, 7.1 ch surround back (PLIIx Movie and PLIIx Music only)

■ Dolby TrueHD

This mode is for use with Dolby TrueHD sources. The audio from the input source is output as-is, without surround sound processing.

- Input source: 7.1 ch
- Speaker configuration: 3.1 ch, 5.1 ch, 7.1 ch
- This listening mode can be selected only if your Blu-ray Disc/DVD player is digitally connected to the unit or the player's output setting is bitstream.

■ DSD

This mode is for use with DSD sources. The audio from the input source is output as-is, without surround sound processing.

- Input source: 5.1 ch
- Speaker configuration: 3.1 ch, 5.1 ch, 7.1 ch
- This unit supports DSD signals input through HDMI IN. However, depending on the connected player, better sound is possible when output from the PCM output of the player. In that case, configure the player for PCM output.
- This listening mode can be selected only if your Blu-ray Disc/DVD player is digitally connected to the unit or the player's output setting is bitstream.

■ DTS

This mode is for use with DTS sources. The audio from the input source is output as-is, without surround sound processing.

- Input source: 5.1 ch
- Speaker configuration: 3.1 ch, 5.1 ch, 7.1 ch
- This listening mode can be selected only if your Blu-ray Disc/DVD player is digitally connected to the unit or the player's output setting is bitstream.

■ DTS 96/24

This mode is for use with DTS 96/24 sources. The audio from the input source is output as-is, without surround sound processing. With 96 kHz sampling rate and 24-bit resolution, it provides superior fidelity.

- Input source: 5.1 ch
- Speaker configuration: 3.1 ch, 5.1 ch, 7.1 ch
- Depending on the settings, this listening mode becomes DTS.
- This listening mode can be selected only if your Blu-ray Disc/DVD player is digitally connected to the unit or the player's output setting is bitstream.

■ DTS Express

This mode is for use with DTS Express sources. The audio from the input source is output as-is, without surround sound processing.

- Input source: 5.1 ch
- Speaker configuration: 3.1 ch, 5.1 ch, 7.1 ch
- This listening mode can be selected only if your Blu-ray Disc/DVD player is digitally connected to the unit or the player's output setting is bitstream.

■ DTS-HD HR (DTS-HD High Resolution Audio)

This mode is for use with DTS-HD High Resolution Audio sources. The audio from the input source is output as-is, without surround sound processing.

- Input source: 5.1 ch, 7.1 ch
- Speaker configuration: 3.1 ch, 5.1 ch, 7.1 ch
- This listening mode can be selected only if your Blu-ray Disc/DVD player is digitally connected to the unit or the player's output setting is bitstream.

■ DTS-HD MSTR (DTS-HD Master Audio)

This mode is for use with DTS-HD Master Audio sources. The audio from the input source is output as-is, without surround sound processing.

- Input source: 5.1 ch, 7.1 ch
- Speaker configuration: 3.1 ch, 5.1 ch, 7.1 ch
- This listening mode can be selected only if your Blu-ray Disc/DVD player is digitally connected to the unit or the player's output setting is bitstream.

■ DTS Neo:6

This mode expands any 2 ch source for 5.1 ch multichannel surround playback. It offers full-bandwidth on all channels, with great independence between the channels. There are two variants for this mode: one ideal for movies and another

ideal for music.

- **Neo:6 Cinema:** Use this mode with any 2 ch movie (e.g., TV, DVD, VHS).
- **Neo:6 Music:** Use this mode with any 2 ch music source (e.g., CD, radio, cassette, TV, DVD, VHS).
- **Neo:6:** Use this mode to expand any 5.1 ch music source for 6.1 ch or 7.1 ch playback using Neo:6.
- Input source: STEREO (Neo:6 Cinema and Neo:6 Music only), 5.1 ch (Neo:6 only)
- Speaker configuration: 3.1 ch, 5.1 ch, 7.1 ch (Neo:6 Cinema and Neo:6 Music only), 7.1 ch surround back (Neo:6 only)

■ ES Discrete (DTS-ES Discrete)

This mode is for use with DTS-ES Discrete sources and enables 6.1 ch or 7.1 ch playback using surround back channel. Completely discrete seven channels will improve spatial imaging and enable 360-degree sound localization producing a sound crossing between the surround channels.

- Input source: 6.1 ch
- Speaker configuration: 7.1 ch surround back
- This listening mode can be selected only if your Blu-ray Disc/DVD player is digitally connected to the unit or the player's output setting is bitstream.
- Use on the DVD with DTS-ES logo, particularly on the software containing DTS-ES Matrix soundtrack.
- Playback becomes DTS if no surround back speaker is connected.

■ ES Matrix (DTS-ES Matrix)

This mode is for use with DTS-ES Matrix soundtrack and enables 6.1 ch or 7.1 ch playback using matrix-encoded back channel.

- Input source: 6.1 ch
- Speaker configuration: 7.1 ch surround back
- This listening mode can be selected only if your Blu-ray Disc/DVD player is digitally connected to the unit or the player's output setting is bitstream.
- Use on the CD, DVD or LD with DTS-ES logo, particularly on the software containing DTS-ES Matrix soundtrack.
- Playback becomes DTS if no surround back speaker is connected.

■ Full Mono

In this mode, all speakers output the same sound in mono, so the sound you hear is the same regardless of where you are within the listening room.

- Input source: MONO, STEREO, 5.1 ch, 7.1 ch
- Speaker configuration: 3.1 ch, 5.1 ch, 7.1 ch

■ Game-Action

In this mode, sound localization is distinct with emphasis on bass.

- Input source: MONO, STEREO, 5.1 ch, 7.1 ch
- Speaker configuration: 5.1 ch, 7.1 ch

■ Game-Rock

In this mode, sound pressure is emphasized to heighten live feel.

- Input source: MONO, STEREO, 5.1 ch, 7.1 ch
- Speaker configuration: 5.1 ch, 7.1 ch

■ Game-RPG

In this mode, the sound has a dramatic feel with a similar atmosphere to Orchestra mode.

- Input source: MONO, STEREO, 5.1 ch, 7.1 ch
- Speaker configuration: 5.1 ch, 7.1 ch

■ Game-Sports

Suitable for audio source with much reverberation.

- Input source: MONO, STEREO, 5.1 ch, 7.1 ch
- Speaker configuration: 5.1 ch, 7.1 ch

■ Mono

Use this mode when watching an old movie with a mono soundtrack, or use it to separately reproduce soundtracks in two different languages recorded in the left and right channels of some movies. It is also suitable for DVDs or other sources containing multiplexed audio.

- Input source: MONO, STEREO, 5.1 ch, 7.1 ch
- Speaker configuration: 2.1 ch, 3.1 ch, 5.1 ch, 7.1 ch

■ Multichannel

This mode is for use with PCM multichannel sources. The audio from the input source is output as-is, without

surround sound processing.

- Input source: 5.1 ch, 7.1 ch
- Speaker configuration: 3.1 ch, 5.1 ch, 7.1 ch

■ Orchestra

Suitable for classical or operatic music, This mode emphasizes the surround channels in order to widen the stereo image, and simulates the natural reverberation of a large hall.

- Input source: MONO, STEREO, 5.1 ch, 7.1 ch
- Speaker configuration: 5.1 ch, 7.1 ch

■ PLIIz Height (Dolby Pro Logic IIz Height)

This mode allows you to effectively use the existing programs when height speakers are connected. It is suitable for various kinds of sources including movie, music and especially games.

- Input source: STEREO, 5.1 ch, 7.1 ch
- Speaker configuration: 7.1 ch height

■ Stereo

In this mode, sound is output from the front left and right speakers and subwoofer.

- Input source: MONO, STEREO, 5.1 ch, 7.1 ch
- Speaker configuration: 2.1 ch, 3.1 ch, 5.1 ch, 7.1 ch

■ Studio-Mix

Suitable for rock or pop music, Listening to music in this mode creates a lively sound field with a powerful acoustic image, like being at a club or rock concert.

- Input source: MONO, STEREO, 5.1 ch, 7.1 ch
- Speaker configuration: 5.1 ch, 7.1 ch

■ T-D (Theater-Dimensional)

In this mode, you can enjoy a virtual playback of multichannel surround sound even with only two or three speakers. This works by controlling how sounds reach the listener's left and right ears.

- Input source: MONO, STEREO, 5.1 ch, 7.1 ch
- Speaker configuration: 2.1 ch, 3.1 ch, 5.1 ch, 7.1 ch
- Good results may not be possible if there is too much reverb, so we recommend that you use this mode in an environment with little or no natural reverb.

■ TV Logic

Suitable for TV shows produced in a TV studio, This mode enhances the surround effects to the entire sound to give clarity to voices and create a realistic acoustic image.

- Input source: MONO, STEREO, 5.1 ch, 7.1 ch
- Speaker configuration: 5.1 ch, 7.1 ch

■ Unplugged

Suitable for acoustic instruments, vocals and jazz, This mode emphasizes the front stereo image, giving the impression of being right in front of the stage.

- Input source: MONO, STEREO, 5.1 ch, 7.1 ch
- Speaker configuration: 5.1 ch, 7.1 ch

Checking the Input Format

You can check the audio format of the input signals. While audio from the player is being input, press Display on the remote controller several times to switch the information shown on the main unit display. If "Dolby D 5.1" is displayed in Signal format, the Dolby Digital 5.1 ch signals are being input.

Dolby D 5.1

Advanced Settings

How to Set

The unit allows you to configure advanced settings, such as to remap the input and input selector, or configure various speaker settings in order to provide even better experience. Make the settings in "Setup" of the Home menu.

● **Operation:** You can set up by viewing the guidance displayed on the TV screen. To display the guidance, you need to make HDMI connection between the unit and TV. Select the item with the cursor buttons of the remote controller and press Enter to confirm your selection. To return to the previous screen, press Return. To return to the Home menu, press Home.

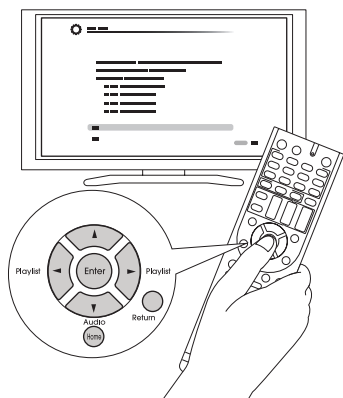

■ Operation

1. Press RCV on the remote controller.
 - Always press RCV first to change the remote controller to Receiver mode (the mode to operate this unit) since its mode may be changed to operate another component.

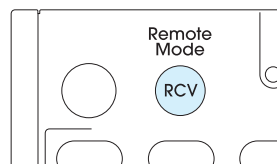

2. Press Home to display the Home menu.

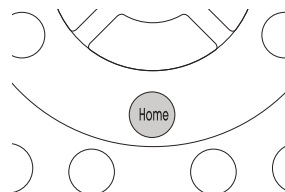

3. Select "Setup" with the ◀/▶ cursors and press Enter.

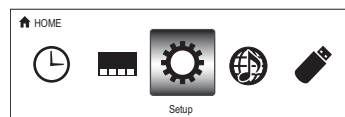

4. Press ▲/▼ to select the desired menu, and then press Enter.

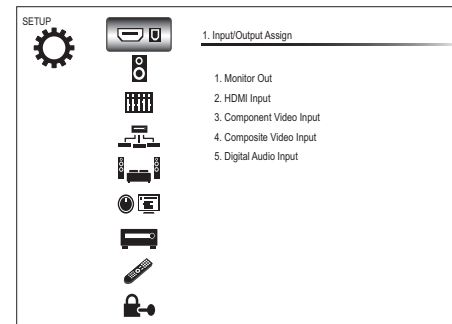

5. With the ▲/▼/◀/▶ cursors, select the desired item to configure the settings.
 - When "Enter" is displayed on the setting item, press Enter.

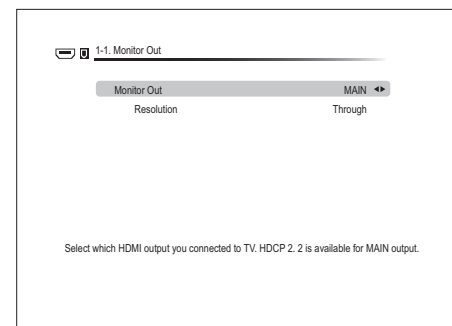

To save changes and finish the setting: Press Home to exit.

1.Input/Output Assign

Monitor Out

The video input signals input to the unit will be converted when they are output from the HDMI OUT jack to the TV so that their resolution can match that of the TV used.

Setting Item	Default Value	Setting Details
Monitor Out	MAIN	<p>Select the HDMI jack to be connected with the TV.</p> <p>"MAIN": When connecting the TV to the HDMI OUT MAIN jack</p> <p>"SUB": When connecting the TV to the HDMI OUT SUB jack</p> <ul style="list-style-type: none"> The resolution of the input signal does not change when output through HDMI OUT SUB jack. <p>"MAIN+SUB": When connecting to both the MAIN and SUB jacks</p> <ul style="list-style-type: none"> Video signals input to the composite video input jack or the COMPONENT VIDEO input jacks will be upconverted to HDMI signals and then output from the HDMI output jack. If "MAIN+SUB" is selected <ul style="list-style-type: none"> Only "Through" or "Auto" can be selected in "Resolution". The resolution of the input signal does not change when output through HDMI OUT SUB jack. HDCP2.2 protected video from HDMI OUT SUB will not be displayed.

Setting Item	Default Value	Setting Details
Resolution	Through	<p>Specify the output resolution of the HDMI OUT jacks. The image resolution of the unit will be converted so that it can match the resolution supported by the TV used.</p> <p>"Through": The output resolution will be the same as that of the input signals.</p> <p>"Auto": The resolution will automatically be converted according to the resolution supported by the TV.</p> <p>"480p (480p/576p)", "720p", "1680x720p", "1080i", "1080p", "2560x1080p": Select the desired resolution.</p> <p>"4K": About four times as high resolution as 1080p (3840x2160 or 4096x2160 pixels depending on the resolution supported by the connected TV)</p> <p>"Source": The output resolution will be that specified in "Picture Adjust" - "Resolution" in the "4.Source Setup" section.</p> <ul style="list-style-type: none"> If "1080p" is selected, 1080p/24 input signals will be output with an unchanged resolution. If the selected resolution is not supported by the monitor, the video is displayed in the same resolution as the input signal. If "4K" is selected, video signals may not be output to some types of TV. For details, see "Regarding the Video Resolution" in "Troubleshooting". If "Monitor Out" is set to "SUB", this setting will be set to "Through". Press Enter if you output signals from the HDMI OUT MAIN jack and check the video on the TV while making this setting. Press Return if no video is displayed. (except when "NET", "USB" or "BLUETOOTH" is selected)

HDMI Input

It is possible to change assignment of input selector buttons and the HDMI IN jacks.

Setting Item	Default Value	Setting Details
BD/DVD	HDMI 1	"HDMI 1" to "HDMI 6": Desired HDMI IN jack can be assigned to BD/DVD button. If you do not assign a jack, select "-----". To select an HDMI IN jack already assigned to another input selector, change its setting to "-----" first.
CBL/SAT	HDMI 2	"HDMI 1" to "HDMI 6": Desired HDMI IN jack can be assigned to CBL/SAT button. If you do not assign a jack, select "-----". To select an HDMI IN jack already assigned to another input selector, change its setting to "-----" first.
STB/DVR	HDMI 3 (HDCP2.2)	"HDMI 1" to "HDMI 6": Desired HDMI IN jack can be assigned to STB/DVR button. If you do not assign a jack, select "-----". To select an HDMI IN jack already assigned to another input selector, change its setting to "-----" first.
GAME	HDMI 4	"HDMI 1" to "HDMI 6": Desired HDMI IN jack can be assigned to GAME button. If you do not assign a jack, select "-----". To select an HDMI IN jack already assigned to another input selector, change its setting to "-----" first.
PC	HDMI 5	"HDMI 1" to "HDMI 6": Desired HDMI IN jack can be assigned to PC button. If you do not assign a jack, select "-----". To select an HDMI IN jack already assigned to another input selector, change its setting to "-----" first.
AUX	Front/MHL	The setting cannot be changed.
TV/CD	-----	"HDMI 1" to "HDMI 6": Desired HDMI IN jack can be assigned to TV/CD button. If you do not assign a jack, select "-----". To select an HDMI IN jack already assigned to another input selector, change its setting to "-----" first.
PHONO	-----	"HDMI 1" to "HDMI 6": Desired HDMI IN jack can be assigned to PHONO button. If you do not assign a jack, select "-----". To select an HDMI IN jack already assigned to another input selector, change its setting to "-----" first.

Component Video Input

CBL/SAT button is assigned to COMPONENT VIDEO IN jack as factory default setting. This assignment can be changed if necessary. If you do not assign a jack, select "-----".

Setting Item	Default Value	Setting Details
BD/DVD	-----	"COMPONENT": COMPONENT VIDEO IN jack is assigned to BD/DVD button.
CBL/SAT	COMPONENT	"COMPONENT": COMPONENT VIDEO IN jack is assigned to CBL/SAT button.
STB/DVR	-----	"COMPONENT": COMPONENT VIDEO IN jack is assigned to STB/DVR button.
GAME	-----	"COMPONENT": COMPONENT VIDEO IN jack is assigned to GAME button.
PC	-----	"COMPONENT": COMPONENT VIDEO IN jack is assigned to PC button.
AUX	-----	"COMPONENT": COMPONENT VIDEO IN jack is assigned to AUX button.
TV/CD	-----	"COMPONENT": COMPONENT VIDEO IN jack is assigned to TV/CD button.
PHONO	-----	"COMPONENT": COMPONENT VIDEO IN jack is assigned to PHONO button.

- When you convert video signals input to the COMPONENT VIDEO IN jacks and output them from the HDMI OUT jack, set the output resolution of the player to 480i. If the input has 480p or higher resolution, an error message will appear.
- When "Monitor Out" is set to "SUB", the 480i/576i component signals only will be output with an unchanged resolution. Video will not be displayed if the TV does not support the resolution.
- When "Monitor Out" is set to "MAIN" or "MAIN+SUB" and "Resolution" is set to "Through", the 480i/576i component signals will be output with their resolution unchanged. So, TV sets not supporting these resolutions will not be able to display video.

Composite Video Input

It is possible to change assignment of input selector buttons and the COMPOSITE VIDEO IN V1 to 3 jacks.

Setting Item	Default Value	Setting Details
BD/DVD	-----	"VIDEO 1" to "VIDEO 3": Desired COMPOSITE VIDEO IN jack can be assigned to BD/DVD button. If you do not assign a jack, select "-----".
CBL/SAT	VIDEO 1	"VIDEO 1" to "VIDEO 3": Desired COMPOSITE VIDEO IN jack can be assigned to CBL/SAT button. If you do not assign a jack, select "-----".
STB/DVR	VIDEO 2	"VIDEO 1" to "VIDEO 3": Desired COMPOSITE VIDEO IN jack can be assigned to STB/DVR button. If you do not assign a jack, select "-----".
GAME	VIDEO 3	"VIDEO 1" to "VIDEO 3": Desired COMPOSITE VIDEO IN jack can be assigned to GAME button. If you do not assign a jack, select "-----".
PC	-----	"VIDEO 1" to "VIDEO 3": Desired COMPOSITE VIDEO IN jack can be assigned to PC button. If you do not assign a jack, select "-----".
AUX	Front	The setting cannot be changed.
TV/CD	-----	"VIDEO 1" to "VIDEO 3": Desired COMPOSITE VIDEO IN jack can be assigned to TV/CD button. If you do not assign a jack, select "-----".
PHONO	-----	"VIDEO 1" to "VIDEO 3": Desired COMPOSITE VIDEO IN jack can be assigned to PHONO button. If you do not assign a jack, select "-----".

- When "Monitor Out" is set to "SUB", the 480i/576i composite signals only will be output with an unchanged resolution. Video will not be displayed if the TV does not support the resolution.
- When "Monitor Out" is set to "MAIN" or "MAIN+SUB" and "Resolution" is set to "Through", the 480i/576i composite signals will be output with their resolution unchanged. So, TV sets not supporting these resolutions will not be able to display video.

Digital Audio Input

It is possible to change assignment of input selector buttons and the DIGITAL IN COAXIAL 1 to 2/OPTICAL jacks.

Setting Item	Default Value	Setting Details
BD/DVD	COAXIAL 1	"COAXIAL 1", "COAXIAL 2", "OPTICAL": Desired DIGITAL IN jack can be assigned to BD/DVD button. If you do not assign a jack, select "-----".
CBL/SAT	COAXIAL 2	"COAXIAL 1", "COAXIAL 2", "OPTICAL": Desired DIGITAL IN jack can be assigned to CBL/SAT button. If you do not assign a jack, select "-----".
STB/DVR	-----	"COAXIAL 1", "COAXIAL 2", "OPTICAL": Desired DIGITAL IN jack can be assigned to STB/DVR button. If you do not assign a jack, select "-----".
GAME	-----	"COAXIAL 1", "COAXIAL 2", "OPTICAL": Desired DIGITAL IN jack can be assigned to GAME button. If you do not assign a jack, select "-----".
PC	-----	"COAXIAL 1", "COAXIAL 2", "OPTICAL": Desired DIGITAL IN jack can be assigned to PC button. If you do not assign a jack, select "-----".
AUX	-----	"COAXIAL 1", "COAXIAL 2", "OPTICAL": Desired DIGITAL IN jack can be assigned to AUX button. If you do not assign a jack, select "-----".
TV/CD	OPTICAL	"COAXIAL 1", "COAXIAL 2", "OPTICAL": Desired DIGITAL IN jack can be assigned to TV/CD button. If you do not assign a jack, select "-----".
PHONO	-----	"COAXIAL 1", "COAXIAL 2", "OPTICAL": Desired DIGITAL IN jack can be assigned to PHONO button. If you do not assign a jack, select "-----".

- Supported sampling rates for PCM signals (stereo, mono) from a digital input are 32/44.1/48/88.2/96 kHz/16, 20, 24 bit.

2. Speaker Setup

Allows you to change the speaker configuration such as presence or not of subwoofer, crossover frequency, and so on. Settings are automatically configured if you use the Automatic Speaker Setup.

Furthermore, this setting cannot be selected if headphones are connected or audio is output from the speakers of the TV.

Speaker Settings

Change the impedance of the connected speakers, the type of front speaker connection, and other speaker settings.

Setting Item	Default Value	Setting Details
Speaker Impedance (Australian model)	6ohms	Set the impedance of the connected speakers. "4ohms": When any of the connected speakers have 4 Ω or more to less than 6 Ω impedance "6ohms": When the connected speakers all have 6 Ω or more impedance
Front Speakers Type	Normal	Select the type of front speaker connection. "Normal": When front speakers are connected in a normal manner "Bi-Amp": When front speakers are bi-amp connected
Powered Zone 2	No	Set presence of speaker terminal connection of Zone 2. "Yes": When speakers are connected to ZONE 2 speaker terminals "No": When speakers are not connected to ZONE 2 speaker terminals <ul style="list-style-type: none"> If "Front Speakers Type" is set to "Bi-Amp", this setting will be set to "No".

- For impedance, check the indications on the back of the speakers or their instruction manual.

Speaker Configuration

Allows you to change the speaker configuration such as presence or not of each speaker, crossover frequency, and so on. Settings are automatically configured if you use the Automatic Speaker Setup. Audio will not be output while you are making this setting.

Setting Item	Default Value	Setting Details
Subwoofer	Yes	Set whether a subwoofer is connected or not. "Yes": When subwoofer is connected "No": When subwoofer is not connected
Front	100Hz	Select the crossover frequency from "40Hz" to "200Hz" to start outputting bass frequencies for each channel. "Full Band": Full band will be output. "None": When no compatible speaker is connected <ul style="list-style-type: none"> "Front" will be fixed to "Full Band" if "Subwoofer" is set to "No", and the bass frequencies of the other channels will be output from the front speakers. To make the settings, refer to the instruction manual of the speakers used.
Center	100Hz	Select the crossover frequency from "40Hz" to "200Hz" to start outputting bass frequencies for each channel. "Full Band": Full band will be output. "None": When no compatible speaker is connected <ul style="list-style-type: none"> This setting cannot be set to "Full Band" unless "Front" is set to "Full Band".
Surround	100Hz	Select the crossover frequency from "40Hz" to "200Hz" to start outputting bass frequencies for each channel. "Full Band": Full band will be output. "None": When no compatible speaker is connected <ul style="list-style-type: none"> This setting cannot be set to "Full Band" unless "Front" is set to "Full Band".

Setting Item	Default Value	Setting Details
Back	100Hz	<p>Select the crossover frequency from "40Hz" to "200Hz" to start outputting bass frequencies for each channel.</p> <p>"Full Band": Full band will be output.</p> <p>"None": When no compatible speaker is connected</p> <ul style="list-style-type: none"> In the following cases, the setting will be set to "None": <ul style="list-style-type: none"> "Surround" is set to "None". "Front Speakers Type" is set to "Bi-Amp". "Powered Zone 2" is set to "Yes" and also Zone2 is set to on. "Full Band" cannot be set unless "Surround" is set to "Full Band".
Back Channel	2ch	<p>Select the number of channels of the connected surround back speaker.</p> <p>"1ch": When one speaker is connected (Connect to the BACK or HEIGHT L terminal)</p> <p>"2ch": When two speakers are connected</p> <ul style="list-style-type: none"> The setting cannot be changed if "Back" is set to "None".
Height	None	<p>Select the crossover frequency from "40Hz" to "200Hz" to start outputting bass frequencies for each channel.</p> <p>"Full Band": Full band will be output.</p> <p>"None": When no compatible speaker is connected</p> <ul style="list-style-type: none"> In the following cases, the setting will be set to "None": <ul style="list-style-type: none"> "Surround" is set to "None". "Front Speakers Type" is set to "Bi-Amp". "Powered Zone 2" is set to "Yes" and also Zone2 is set to on. "Full Band" cannot be set unless "Front" is set to "Full Band".
LPF of LFE	120Hz	<p>Set the low-pass filter for LFE (low-frequency effect) signals in order to pass lower frequency signals than the set value and thus cancel unwanted noises. The low-pass filter will be effective only on sources with LFE channel.</p> <p>Set a frequency from "80Hz", "90Hz", "100Hz" and "120Hz".</p> <p>"Off": Do not use this function</p>

Setting Item	Default Value	Setting Details
Double Bass	----	<p>Boost bass output by feeding bass sounds from the front left and right, and center speakers to the subwoofer.</p> <p>"On": Bass output will be boosted.</p> <p>"Off": Bass output will not be boosted.</p> <ul style="list-style-type: none"> The setting will not automatically be configured even if you performed the automatic speaker setup. If "Subwoofer" is set to "No" or if "Front" is set to other than "Full Band", the setting will be fixed to "----".

Speaker Distance

Set the distance from each speaker to the listening position. Settings are automatically configured if you use the automatic speaker setup.

Setting Item	Default Value	Setting Details
Unit	feet/meters	<p>Specify the unit of distance for configuring settings.</p> <p>"feet": When setting in feet (0.1 ft to 30.0 ft, in increments of 0.1 ft)</p> <p>"meters": When setting in meters (0.03 m to 9.00 m, in increments of 0.03 m)</p>
Front Left	12.0 ft/3.60 m	Specify the distance between each speaker and the listening position.
Center	12.0 ft/3.60 m	Specify the distance between each speaker and the listening position.
Front Right	12.0 ft/3.60 m	Specify the distance between each speaker and the listening position.
Surround Right	7.0 ft/2.10 m	Specify the distance between each speaker and the listening position.
Back Right	7.0 ft/2.10 m	Specify the distance between each speaker and the listening position.
Back Left	7.0 ft/2.10 m	Specify the distance between each speaker and the listening position.
Surround Left	7.0 ft/2.10 m	Specify the distance between each speaker and the listening position.

Setting Item	Default Value	Setting Details
Subwoofer	12.0 ft/3.60 m	Specify the distance between each speaker and the listening position.
Height Left	9.0 ft/2.70 m	Specify the distance between each speaker and the listening position.
Height Right	9.0 ft/2.70 m	Specify the distance between each speaker and the listening position.

- When the speaker is set to "No" or "None" in "Speaker Configuration", the settings for "Speaker Distance" cannot be changed.
- Default values vary depending on the regions.

Level Calibration

Adjust the level of each speaker with the built-in test tone. Settings are automatically configured if you use the Automatic Speaker Setup.

Setting Item	Default Value	Setting Details
Front Left	0 dB	Select a value between "-12 dB" to "+12 dB". A test tone will be output each time you change the value. Select the desired level.
Center	0 dB	Select a value between "-12 dB" to "+12 dB". A test tone will be output each time you change the value. Select the desired level.
Front Right	0 dB	Select a value between "-12 dB" to "+12 dB". A test tone will be output each time you change the value. Select the desired level.
Surround Right	0 dB	Select a value between "-12 dB" to "+12 dB". A test tone will be output each time you change the value. Select the desired level.
Back Right	0 dB	Select a value between "-12 dB" to "+12 dB". A test tone will be output each time you change the value. Select the desired level.
Back Left	0 dB	Select a value between "-12 dB" to "+12 dB". A test tone will be output each time you change the value. Select the desired level.
Surround Left	0 dB	Select a value between "-12 dB" to "+12 dB". A test tone will be output each time you change the value. Select the desired level.

Setting Item	Default Value	Setting Details
Subwoofer	0 dB	Select a value between "-15 dB" to "+12 dB". A test tone will be output each time you change the value. Select the desired level.
Height Left	0 dB	Select a value between "-12 dB" to "+12 dB". A test tone will be output each time you change the value. Select the desired level.
Height Right	0 dB	Select a value between "-12 dB" to "+12 dB". A test tone will be output each time you change the value. Select the desired level.

- In the following cases, the settings for "Level Calibration" cannot be changed:
 - The speaker is set to "No" or "None" in "Speaker Configuration".
 - Mute (MUTING) is set.

3.Audio Adjust

Configure various settings related to sound, such as settings for listening to multiplex audio or multilingual TV broadcasts and sound field settings for listening modes.

Multiplex/Mono

Setting Item	Default Value	Setting Details
Multiplex Input Channel	Main	Set the audio channel or language to be output when playing multiplex audio or multilingual TV broadcasts etc. "Main": Main channel only "Sub": Sub channel only "Main/Sub": Main and sub channels will be output at the same time. <ul style="list-style-type: none"> • If multiplex audio is being played, "1+1" will be displayed when Display on the main unit is pressed.
Mono Input Channel	Left+Right	Set the input channel to use for playing any 2 ch digital source such as Dolby Digital, or 2-ch analog/PCM source in the Mono listening mode. "Left": Left channel only "Right": Right channel only "Left+Right": Left and right channels

Dolby

Make the settings for Dolby listening mode.

Setting Item	Default Value	Setting Details
PLIIx Music (2ch Input) Panorama	Off	Adjust the sound field setting for playing any 2 ch digital source such as Dolby Digital or 2 ch analog/PCM source in the Dolby Pro logic II Music listening mode. Select the width of sound field. "On": Width of sound field will be increased. "Off": Default value
PLIIx Music (2ch Input) Dimension	0	Adjust the sound field setting for playing any 2 ch digital source such as Dolby Digital or 2 ch analog/PCM source in the Dolby Pro logic II Music listening mode. Select the depth of sound field. "-3" to "+3": The sound field shifts forward as the set value becomes smaller than "0" and backward if the set value become larger than "0".
PLIIx Music (2ch Input) Center Width	3	Configure the setting to use for playing any 2 ch digital source such as Dolby Digital, or 2-ch analog/PCM source in the Dolby Pro logic II Music listening mode. Adjust the width of the sound from the center speaker). "0" to "7": The smaller the setting value is, the more concentrated in the center speaker is the sound, while the larger the setting value is, the more distributed to the front left and right speakers is the sound of the center speaker.
PLIIz Height Gain	Mid	Adjust the output level of the height speakers in the Dolby Pro Logic IIz Height listening mode. The output of the height speakers will be enhanced in the order of "Low", "Mid" (Middle), "High": "Low", "Mid" and "High". • The setting cannot be changed if "Height" is set to "None" in "Speaker Configuration".

Setting Item	Default Value	Setting Details
Dolby EX Dolby EX	Manual	The Dolby Digital EX listening mode will automatically be selected when Dolby EX signals are input. "Auto": Use this function "Manual": Select the desired listening mode • The setting cannot be changed if "Back" is set to "None" in "Speaker Configuration".
Loudness Management	On	Enable the Late Night function that allows you to enjoy surround sound of Dolby TrueHD playback even in low volume. "On": Use this function "Off": Do not use this function

- Depending on the setting of "Back" in "Speaker Configuration", the display will be changed. "PLIIx" will be displayed as "PLIIx/PLII".

DTS

Make the settings for DTS Neo:6 Music listening mode.

Setting Item	Default Value	Setting Details
Neo:6 Music Center Image	2	Adjust the width of the sound field of the front channel when playing in the DTS Neo:6 Music listening mode. "0" to "5": Selecting a smaller value brings the sound field of the front channel to the center while selecting a larger value spreads the sound field of the front channel to left and right.

Theater-Dimensional

Make the settings for Theater-Dimensional mode.

Setting Item	Default Value	Setting Details
Listening Angle	Wide	Set the angle of the front left and right speakers relative to the listening position when playing in the Theater-Dimensional listening mode. "Narrow": Less than 30° "Wide": Greater than 30°

- Values recommended for "Listening Angle" are: 20° when "Narrow" is selected and 40° when "Wide" is selected.

4.Source Setup

Adjust the volume level difference among the multiple devices connected to this unit, rename an input selector, or adjust the image quality. The setting can be separately set to each input selector button. When you select a desired input to check the video or audio, start playback of the connected device.

AccuEQ Room Calibration

Setting Item	Default Value	Setting Details
AccuEQ Room Calibration	Off	Enable/disable the sound field set in automatic speaker setup "On": Enable this function "Off": Disable this function In the following cases, the setting cannot be changed: – Automatic speaker setup is not performed. – Headphones are connected.

IntelliVolume

Setting Item	Default Value	Setting Details
IntelliVolume	0 dB	Adjust the volume level difference between the devices connected to the unit. Select a value between "-12 dB" to "+12 dB". Set a negative value if the volume of the target device is larger than the others and a positive value if smaller. • This function is not effective in Zone 2.

Name Edit

Set an easy name to each input. The set name will be shown on the main unit display.

Setting Item	Default Value	Setting Details
Name	Input name	<ol style="list-style-type: none"> Select a character or symbol with the cursors and press Enter. Repeat it to input 10 or less characters. "Shift": Switches between upper and lower cases. (Pressing +10 on the remote controller also toggles between upper and lower cases.) "←" "→": Moves the cursor to the arrow direction. "Back Space": Removes a character on the left of the cursor. "Space": Puts a space. <ul style="list-style-type: none"> Pressing CLR on the remote controller will remove all the input characters. After inputting, select "OK" with the cursors and press Enter. The input name will be saved.

- To name a preset radio station, press Tuner on the remote controller, select AM/FM and select the preset number.
- It cannot be set if the input is "NET", "USB" or "BLUETOOTH".

Picture Adjust

Adjust the image quality. (Possible only when the video player is connected to the HDMI OUT MAIN jack) If you adjust it by checking the video, press Enter. Press Return to return the screen to the previous status.

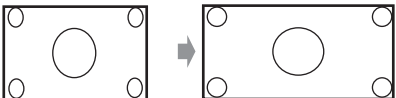
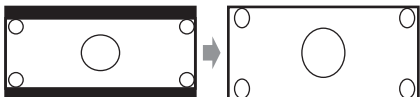
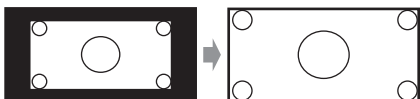
Setting Item	Default Value	Setting Details
Wide Mode	Auto	<p>Set the aspect ratio.</p> <p>"Auto": The aspect ratio will automatically be set according to the input signals and the monitor output setting.</p> <p>"4:3":</p>  <p>"Full":</p>  <p>"Zoom":</p>  <p>"Wide Zoom":</p>  <ul style="list-style-type: none"> When a 3D or 4K video source is input, this setting is set to "Full". Furthermore, for some resolutions, this setting may be disabled and set to "Full".

Setting Item	Default Value	Setting Details
Picture Mode	Custom	<p>An appropriate image quality setting for cinema or game can be selected. You can also adjust each item to obtain your favorite image quality.</p> <p>"Custom": The items from "Game Mode" to "Blue Contrast" can be adjusted as desired.</p> <p>"ISF Day": Select when the room is bright.</p> <p>"ISF Night": Select when the room is dark.</p> <p>"Cinema": When the video source is cinema</p> <p>"Game": When the video source is game</p> <p>"Standard": The resolution will be changed but the image quality will not be adjusted.</p> <p>"Bypass": Both the resolution and image quality will not be adjusted.</p> <ul style="list-style-type: none"> If you select "Bypass", the on-screen display function will be disabled. <p>The receiver has been designed to incorporate setup and calibration standards established by the Imaging Science Foundation (ISF). The ISF has developed carefully crafted, industry-recognized standards for optimal video performance and has implemented a training program for technicians and installers to use these standards to obtain optimal picture quality from the receiver. Accordingly, Onkyo recommends that setup and calibration be performed by an ISF Certified installation technician.</p>
Game Mode	Off	<p>Change to the setting suitable for game. Also correct the delay of video signals of the game console if any.</p> <p>"On": Use this function</p> <p>"Off": Do not use this function</p> <ul style="list-style-type: none"> If you select "On", the delay will be corrected but the image quality will be lower. The setting will be fixed to "Off" if "Resolution" is set to "4K".
Film Mode	Auto	<p>Change to the setting suitable for film.</p> <p>"Auto": Image processing suitable for film will be executed.</p> <p>"Video": "Film Mode" will not be applied and the input signals will be processed as video source.</p>

Setting Item	Default Value	Setting Details
Edge Enhancement	Off	Adjust the sharpness of the outline of image. Select from "Off", "Low", "Mid" (Middle), and "High". <ul style="list-style-type: none"> The setting will be fixed to "Off" if "Game Mode" is set to "On". When the horizontal resolution of the output video is 2,000 TV lines or more, this setting is set to "Off".
Noise Reduction	Off	Reduces the noise of the screen. Select from "Off", "Low", "Mid" (Middle), and "High". <ul style="list-style-type: none"> The setting will be fixed to "Off" if "Game Mode" is set to "On".
Resolution	Through	Adjust the output resolution of the HDMI OUT jacks. The image resolution of the unit will be converted so that it can match the resolution supported by the TV used. "Through": The output resolution will be the same as that of the input signals. "Auto": The resolution will automatically be converted to the resolution supported by the TV. "480p (480p/576p)", "720p", "1680×720p", "1080i", "1080p", "2560×1080p": Select the desired resolution. "4K": About four times as high resolution as 1080p (3840×2160 or 4096×2160 pixels depending on the resolution supported by the connected TV) <ul style="list-style-type: none"> The setting can be selected only when "Source" is selected in "1.Input/Output Assign" - "Monitor Out" - "Resolution". If "4K" is selected, video signals may not be output to some types of TV. For details, see "Regarding the Video Resolution" in "Troubleshooting".
Brightness	0	Adjust brightness of the screen. Select a value between "-50" to "+50".
Contrast	0	Adjust contrast of the screen. Select a value between "-50" to "+50".
Hue	0	Correct hue of the screen. Select a value between "-50" to "+50".

Setting Item	Default Value	Setting Details
Saturation	0	Adjust saturation of the screen. Select a value between "-50" to "+50".
Color Temperature	Normal	Set color temperature of the screen. Select from "Warm", "Normal" and "Cool".
Gamma	0	Adjust the relative relation between the R (red), G (green) and B (blue) data signals of the input image and those of the output image. Select a value between "-3" to "+3".
Red Brightness	0	Adjust the brightness of red of the screen. Select a value between "-50" to "+50".
Red Contrast	0	Adjust the contrast of red of the screen. Select a value between "-50" to "+50".
Green Brightness	0	Adjust the brightness of green of the screen. Select a value between "-50" to "+50".
Green Contrast	0	Adjust the contrast of green of the screen. Select a value between "-50" to "+50".
Blue Brightness	0	Adjust the brightness of blue of the screen. Select a value between "-50" to "+50".
Blue Contrast	0	Adjust the contrast of blue of the screen. Select a value between "-50" to "+50".

- In the following cases, the settings for "Picture Adjust" cannot be changed:
 - "NET", "USB" or "BLUETOOTH" is selected.
 - "Monitor Out" is set to "SUB".
- Press CLR on the remote controller if you return all the settings from "Game Mode" through "Blue Contrast" to their default value.

Audio Selector

Make the audio input setting. The setting can be separately set to each input selector button. Select the input selector to configure.

Setting Item	Default Value	Setting Details
Audio Selector	—	<p>Allows you to select prior input source.</p> <p>"ARC": When giving priority to input signal from ARC compatible TV.</p> <ul style="list-style-type: none"> The setting can be selected only when "Audio Return Channel" is set to "Auto" and also the "TV/CD" input is selected. <p>"HDMI": When giving priority to input signal from HDMI jacks</p> <ul style="list-style-type: none"> The setting can be selected only when the input is assigned to the HDMI IN jack in the "HDMI Input" setting. <p>"COAXIAL (Coaxial input)": When giving priority to input signal from DIGITAL IN COAXIAL jacks.</p> <ul style="list-style-type: none"> The setting can be selected only when the input is assigned to the COAXIAL jack in the "Digital Audio Input" setting. <p>"OPTICAL (Optical input)": When giving priority to input signal from DIGITAL IN OPTICAL jacks.</p> <ul style="list-style-type: none"> The setting can be selected only when the input is assigned to the OPTICAL jack in the "Digital Audio Input" setting. <p>"Analog": To always output analog audio independently of the input signal</p>
Fixed Mode	Off	<p>Specify an input signal when "HDMI", "COAXIAL (Coaxial input)", or "OPTICAL (Optical input)" is selected for "Audio Selector". Set this item if noise is produced, or truncation occurs at the beginning of a track that follows a gap when playing PCM or DTS sources.</p> <p>"Off": To play an analog signal when there is no digital signal.</p> <p>"PCM": To fix the input source to PCM.</p> <p>"DTS": To fix the input source to DTS (except for DTS-HD).</p> <ul style="list-style-type: none"> Changing "Audio Selector" changes the setting to "Off".

- The setting cannot be changed when "TUNER", "NET", "USB", or "BLUETOOTH" input is selected.

5.Listening Mode Preset

You can preset your favorite listening mode to each input. (For example, you can always apply straight decode to the Dolby TrueHD source of Blu-ray Disc to play it in unchanged sound field.)

Select the input, signal type and listening mode.

Although it is possible to select the listening mode during playback, the selected mode will be reset when the unit enters standby mode.

Setting Item	Default Value	Setting Details
Analog/PCM	All Ch Stereo	Set the listening mode for playing PCM signals of CD and analog signals of record and cassette tape.
Mono/Multiplex Source	Full Mono	Set the listening mode for playing Dolby Digital, AAC and other digital signals recorded in monaural or multiplex audio.
2ch Source	PLIIX Movie	Set the listening mode for playing Dolby Digital and other digital signals recorded in 2 channels.
Dolby D/Dolby D Plus/TrueHD	Straight Decode	Set the listening mode for playing Dolby Digital, Dolby Digital Plus and Dolby TrueHD signals.
DTS/DTS-ES/DTS-HD	Straight Decode	Set the listening mode for playing digital audio signals in DTS and DTS-HD High Resolution formats. Select the listening mode specified for Blu-ray or such other DTS-HD Master Audio source.
Other Multich Source	Straight Decode	Set the listening mode for playing DSD signals of AAC, DVD-Audio and Super Audio CD that are input from HDMI IN jack.

- Available listening modes vary depending on the input signal.
- Setting "Last Valid" will always select the last selected mode.
- Only "Analog" can be set to the "TUNER" input.
- "Digital" and "TrueHD" can be set to the "NET" and "USB" inputs.
- Only "Digital" can be set to the "BLUETOOTH" input.

6. Miscellaneous

Volume Setup

Make the detailed volume setting of the unit.

Setting Item	Default Value	Setting Details
Maximum Volume	Off	Set the maximum value to avoid too high volume. Select a value from "Off", "30" to "79".
Power On Volume	Last	Set the volume level of when the power is turned on. Select a value from "Last" (Volume level before entering standby mode), "Min", "1" to "79" and "Max". <ul style="list-style-type: none"> You cannot set a higher value than that of "Maximum Volume".
Headphone Level	0 dB	Adjust the volume level difference between speakers and headphones. Select a value between "-12 dB" to "+12 dB".

OSD Setup

Make the setting of on-screen display function that can display the setting menu screen, volume operation screen and the like on the TV.

Setting Item	Default Value	Setting Details
On Screen Display	On	Set whether or not to display the operation screen on the TV. "On": The operation screen will be displayed on the TV. "Off": The operation screen will not be displayed on the TV. <ul style="list-style-type: none"> The operation screen may not be displayed depending on the input signal even if "On" is selected. If the operation screen is not displayed, change the resolution of the connected device.
Language	English	Select the on-screen display language.
Screen Saver	3min	Set the time to start the screen saver. Select a value from "3min", "5min", "10min" and "Off".

12V Trigger A Setup

You can enable power link operation when you connect the unit and the external devices equipped with 12V trigger input jack. When the desired input is selected, power link operation will be activated with a control signal of maximum 12 V/150 mA output from the 12V trigger output jack.

Setting Item	Default Value	Setting Details
Delay	0 sec	Set after how many seconds the 12V trigger output will occur in response to the unit's operation. As some devices cause a large current when they turn on, delay the output if such devices are connected. Select a value between "0 sec" to "3 sec".
BD/DVD	Main	Set the 12V trigger output setting to each input. Setting should be made for each 12V TRIGGER OUT jack. "Off": No output "Main": Will be output when selected as input source of main room playback "Zone2": Will be output when selected as input source of Zone 2 playback "Main/Zone2": Will be output when selected as input source of main room or Zone 2 playback
CBL/SAT	Main	Set the 12V trigger output setting to each input. Setting should be made for each 12V TRIGGER OUT jack. "Off": No output "Main": Will be output when selected as input source of main room playback "Zone2": Will be output when selected as input source of Zone 2 playback "Main/Zone2": Will be output when selected as input source of main room or Zone 2 playback

Setting Item	Default Value	Setting Details
STB/DVR	Main	Set the 12V trigger output setting to each input. Setting should be made for each 12V TRIGGER OUT jack. "Off": No output "Main": Will be output when selected as input source of main room playback "Zone2": Will be output when selected as input source of Zone 2 playback "Main/Zone2": Will be output when selected as input source of main room or Zone 2 playback
GAME	Main	Set the 12V trigger output setting to each input. Setting should be made for each 12V TRIGGER OUT jack. "Off": No output "Main": Will be output when selected as input source of main room playback "Zone2": Will be output when selected as input source of Zone 2 playback "Main/Zone2": Will be output when selected as input source of main room or Zone 2 playback
PC	Main	Set the 12V trigger output setting to each input. Setting should be made for each 12V TRIGGER OUT jack. "Off": No output "Main": Will be output when selected as input source of main room playback "Zone2": Will be output when selected as input source of Zone 2 playback "Main/Zone2": Will be output when selected as input source of main room or Zone 2 playback
AUX	Main	Set the 12V trigger output setting to each input. Setting should be made for each 12V TRIGGER OUT jack. "Off": No output "Main": Will be output when selected as input source of main room playback "Zone2": Will be output when selected as input source of Zone 2 playback "Main/Zone2": Will be output when selected as input source of main room or Zone 2 playback

Setting Item	Default Value	Setting Details
TV/CD	Main	Set the 12V trigger output setting to each input. Setting should be made for each 12V TRIGGER OUT jack. "Off": No output "Main": Will be output when selected as input source of main room playback "Zone2": Will be output when selected as input source of Zone 2 playback "Main/Zone2": Will be output when selected as input source of main room or Zone 2 playback
PHONO	Main	Set the 12V trigger output setting to each input. Setting should be made for each 12V TRIGGER OUT jack. "Off": No output "Main": Will be output when selected as input source of main room playback "Zone2": Will be output when selected as input source of Zone 2 playback "Main/Zone2": Will be output when selected as input source of main room or Zone 2 playback
TUNER	Main	Set the 12V trigger output setting to each input. Setting should be made for each 12V TRIGGER OUT jack. "Off": No output "Main": Will be output when selected as input source of main room playback "Zone2": Will be output when selected as input source of Zone 2 playback "Main/Zone2": Will be output when selected as input source of main room or Zone 2 playback
NET	Main	Set the 12V trigger output setting to each input. Setting should be made for each 12V TRIGGER OUT jack. "Off": No output "Main": Will be output when selected as input source of main room playback "Zone2": Will be output when selected as input source of Zone 2 playback "Main/Zone2": Will be output when selected as input source of main room or Zone 2 playback

Setting Item	Default Value	Setting Details
USB	Main	Set the 12V trigger output setting to each input. Setting should be made for each 12V TRIGGER OUT jack. "Off": No output "Main": Will be output when selected as input source of main room playback "Zone2": Will be output when selected as input source of Zone 2 playback "Main/Zone2": Will be output when selected as input source of main room or Zone 2 playback
BLUETOOTH	Main	Set the 12V trigger output setting to each input. Setting should be made for each 12V TRIGGER OUT jack. "Off": No output "Main": Will be output when selected as input source of main room playback "Zone2": Will be output when selected as input source of Zone 2 playback "Main/Zone2": Will be output when selected as input source of main room or Zone 2 playback

12V Trigger B Setup

You can enable power link operation when you connect the unit and the external devices equipped with 12V trigger input jack. When the desired input is selected, power link operation will be activated with a control signal of maximum 12 V/25 mA output from the 12V trigger output jack.

Setting Item	Default Value	Setting Details
Delay	1 sec	Set after how many seconds the 12V trigger output will occur in response to the unit's operation. As some devices cause a large current when they turn on, delay the output if such devices are connected. Select a value between "0 sec" to "3 sec".

Setting Item	Default Value	Setting Details
BD/DVD	Main/Zone2	Set the 12V trigger output setting to each input. Setting should be made for each 12V TRIGGER OUT jack. "Off": No output "Main": Will be output when selected as input source of main room playback "Zone2": Will be output when selected as input source of Zone 2 playback "Main/Zone2": Will be output when selected as input source of main room or Zone 2 playback
CBL/SAT	Main/Zone2	Set the 12V trigger output setting to each input. Setting should be made for each 12V TRIGGER OUT jack. "Off": No output "Main": Will be output when selected as input source of main room playback "Zone2": Will be output when selected as input source of Zone 2 playback "Main/Zone2": Will be output when selected as input source of main room or Zone 2 playback
STB/DVR	Main/Zone2	Set the 12V trigger output setting to each input. Setting should be made for each 12V TRIGGER OUT jack. "Off": No output "Main": Will be output when selected as input source of main room playback "Zone2": Will be output when selected as input source of Zone 2 playback "Main/Zone2": Will be output when selected as input source of main room or Zone 2 playback
GAME	Main/Zone2	Set the 12V trigger output setting to each input. Setting should be made for each 12V TRIGGER OUT jack. "Off": No output "Main": Will be output when selected as input source of main room playback "Zone2": Will be output when selected as input source of Zone 2 playback "Main/Zone2": Will be output when selected as input source of main room or Zone 2 playback

Setting Item	Default Value	Setting Details
PC	Main/Zone2	Set the 12V trigger output setting to each input. Setting should be made for each 12V TRIGGER OUT jack. "Off": No output "Main": Will be output when selected as input source of main room playback "Zone2": Will be output when selected as input source of Zone 2 playback "Main/Zone2": Will be output when selected as input source of main room or Zone 2 playback
AUX	Main/Zone2	Set the 12V trigger output setting to each input. Setting should be made for each 12V TRIGGER OUT jack. "Off": No output "Main": Will be output when selected as input source of main room playback "Zone2": Will be output when selected as input source of Zone 2 playback "Main/Zone2": Will be output when selected as input source of main room or Zone 2 playback
TV/CD	Main/Zone2	Set the 12V trigger output setting to each input. Setting should be made for each 12V TRIGGER OUT jack. "Off": No output "Main": Will be output when selected as input source of main room playback "Zone2": Will be output when selected as input source of Zone 2 playback "Main/Zone2": Will be output when selected as input source of main room or Zone 2 playback
PHONO	Main/Zone2	Set the 12V trigger output setting to each input. Setting should be made for each 12V TRIGGER OUT jack. "Off": No output "Main": Will be output when selected as input source of main room playback "Zone2": Will be output when selected as input source of Zone 2 playback "Main/Zone2": Will be output when selected as input source of main room or Zone 2 playback

Setting Item	Default Value	Setting Details
TUNER	Main/Zone2	Set the 12V trigger output setting to each input. Setting should be made for each 12V TRIGGER OUT jack. "Off": No output "Main": Will be output when selected as input source of main room playback "Zone2": Will be output when selected as input source of Zone 2 playback "Main/Zone2": Will be output when selected as input source of main room or Zone 2 playback
NET	Main/Zone2	Set the 12V trigger output setting to each input. Setting should be made for each 12V TRIGGER OUT jack. "Off": No output "Main": Will be output when selected as input source of main room playback "Zone2": Will be output when selected as input source of Zone 2 playback "Main/Zone2": Will be output when selected as input source of main room or Zone 2 playback
USB	Main/Zone2	Set the 12V trigger output setting to each input. Setting should be made for each 12V TRIGGER OUT jack. "Off": No output "Main": Will be output when selected as input source of main room playback "Zone2": Will be output when selected as input source of Zone 2 playback "Main/Zone2": Will be output when selected as input source of main room or Zone 2 playback
BLUETOOTH	Main/Zone2	Set the 12V trigger output setting to each input. Setting should be made for each 12V TRIGGER OUT jack. "Off": No output "Main": Will be output when selected as input source of main room playback "Zone2": Will be output when selected as input source of Zone 2 playback "Main/Zone2": Will be output when selected as input source of main room or Zone 2 playback

12V Trigger C Setup

You can enable power link operation when you connect the unit and the external devices equipped with 12V trigger input jack. When the desired input is selected, power link operation will be activated with a control signal of maximum 12 V/25 mA output from the 12V trigger output jack.

Setting Item	Default Value	Setting Details
Delay	2 sec	Set after how many seconds the 12V trigger output will occur in response to the unit's operation. As some devices cause a large current when they turn on, delay the output if such devices are connected. Select a value between "0 sec" to "3 sec".
BD/DVD	Zone2	Set the 12V trigger output setting to each input. Setting should be made for each 12V TRIGGER OUT jack. "Off": No output "Main": Will be output when selected as input source of main room playback "Zone2": Will be output when selected as input source of Zone 2 playback "Main/Zone2": Will be output when selected as input source of main room or Zone 2 playback
CBL/SAT	Zone2	Set the 12V trigger output setting to each input. Setting should be made for each 12V TRIGGER OUT jack. "Off": No output "Main": Will be output when selected as input source of main room playback "Zone2": Will be output when selected as input source of Zone 2 playback "Main/Zone2": Will be output when selected as input source of main room or Zone 2 playback

Setting Item	Default Value	Setting Details
STB/DVR	Zone2	Set the 12V trigger output setting to each input. Setting should be made for each 12V TRIGGER OUT jack. "Off": No output "Main": Will be output when selected as input source of main room playback "Zone2": Will be output when selected as input source of Zone 2 playback "Main/Zone2": Will be output when selected as input source of main room or Zone 2 playback
GAME	Zone2	Set the 12V trigger output setting to each input. Setting should be made for each 12V TRIGGER OUT jack. "Off": No output "Main": Will be output when selected as input source of main room playback "Zone2": Will be output when selected as input source of Zone 2 playback "Main/Zone2": Will be output when selected as input source of main room or Zone 2 playback
PC	Zone2	Set the 12V trigger output setting to each input. Setting should be made for each 12V TRIGGER OUT jack. "Off": No output "Main": Will be output when selected as input source of main room playback "Zone2": Will be output when selected as input source of Zone 2 playback "Main/Zone2": Will be output when selected as input source of main room or Zone 2 playback
AUX	Zone2	Set the 12V trigger output setting to each input. Setting should be made for each 12V TRIGGER OUT jack. "Off": No output "Main": Will be output when selected as input source of main room playback "Zone2": Will be output when selected as input source of Zone 2 playback "Main/Zone2": Will be output when selected as input source of main room or Zone 2 playback

Setting Item	Default Value	Setting Details
TV/CD	Zone2	Set the 12V trigger output setting to each input. Setting should be made for each 12V TRIGGER OUT jack. "Off": No output "Main": Will be output when selected as input source of main room playback "Zone2": Will be output when selected as input source of Zone 2 playback "Main/Zone2": Will be output when selected as input source of main room or Zone 2 playback
PHONO	Zone2	Set the 12V trigger output setting to each input. Setting should be made for each 12V TRIGGER OUT jack. "Off": No output "Main": Will be output when selected as input source of main room playback "Zone2": Will be output when selected as input source of Zone 2 playback "Main/Zone2": Will be output when selected as input source of main room or Zone 2 playback
TUNER	Zone2	Set the 12V trigger output setting to each input. Setting should be made for each 12V TRIGGER OUT jack. "Off": No output "Main": Will be output when selected as input source of main room playback "Zone2": Will be output when selected as input source of Zone 2 playback "Main/Zone2": Will be output when selected as input source of main room or Zone 2 playback
NET	Zone2	Set the 12V trigger output setting to each input. Setting should be made for each 12V TRIGGER OUT jack. "Off": No output "Main": Will be output when selected as input source of main room playback "Zone2": Will be output when selected as input source of Zone 2 playback "Main/Zone2": Will be output when selected as input source of main room or Zone 2 playback

Setting Item	Default Value	Setting Details
USB	Zone2	Set the 12V trigger output setting to each input. Setting should be made for each 12V TRIGGER OUT jack. "Off": No output "Main": Will be output when selected as input source of main room playback "Zone2": Will be output when selected as input source of Zone 2 playback "Main/Zone2": Will be output when selected as input source of main room or Zone 2 playback
BLUETOOTH	Zone2	Set the 12V trigger output setting to each input. Setting should be made for each 12V TRIGGER OUT jack. "Off": No output "Main": Will be output when selected as input source of main room playback "Zone2": Will be output when selected as input source of Zone 2 playback "Main/Zone2": Will be output when selected as input source of main room or Zone 2 playback

7. Hardware Setup

Multi Zone

Setting Item	Default Value	Setting Details
Zone 2 Out	Fixed	Select which of the integrated amplifier in a separate room or this unit should be used to adjust the volume when Zone 2 is active. "Fixed": Adjust on the Integrated amplifier in a separate room "Variable": Adjust on the unit
Zone 2 Maximum Volume	Off	Set the maximum value for Zone 2 to avoid too high volume. Select a value from "Off", "50" to "99".
Zone 2 Power On Volume	Last	Set the Zone 2 volume level of when the unit is turned on. Select a value from "Last" (Volume level when the unit was turned off), "Min", "1" to "99" and "Max". <ul style="list-style-type: none"> You cannot set a higher value than that of "Zone 2 Maximum Volume".

Tuner

Setting Item	Default Value	Setting Details
AM/FM Frequency Step (North American model)	10kHz/200kHz	Select a frequency step depending on your area of residence. Select "10kHz/200kHz" or "9kHz/50kHz". <ul style="list-style-type: none"> When this setting is changed, all radio presets are deleted.
AM Frequency Step (Australian model)	9kHz	Select a frequency step depending on your area of residence. Select "10kHz" or "9kHz". <ul style="list-style-type: none"> When this setting is changed, all radio presets are deleted.

HDMI

Setting Item	Default Value	Setting Details
HDMI CEC (RIHD)	Off	Setting to "On" enables the input selection link and other link functions with HDMI connected CEC compliant device. "On": Use this function "Off": Do not use this function <ul style="list-style-type: none"> Depending on the TV set, a link may need to be configured on the TV. This function is effective only when the device is connected to the HDMI OUT MAIN terminal. Setting to "On" and closing the on-screen menu displays the name of the CEC-compatible components and "RIHD On" on the display. Power consumption in standby mode may increase if "On" is set. (Depending on the TV status, the unit will enter the normal standby mode.) If you operate the Master Volume control of the unit when this setting is set to "On" and you are listening to the audio through the speakers of your TV, audio will be output also from the speakers connected to the unit. If you want to output from only either of them, change the unit or TV settings, or reduce the volume of the unit. If abnormal operation occurs when you set the setting to "On", set it to "Off". When connecting a non-CEC compatible component, or when you are not sure whether it is compatible, set the setting to "Off". When changing this setting, turn off and then on again the power of all connected components.

Setting Item	Default Value	Setting Details
HDMI Through	Off	<p>You can display the video of an HDMI connected player on the TV even if the unit is in standby mode. This setting is effective only for an input selector to which an HDMI jack is assigned in "HDMI Input". It cannot be set to any other input selector unless an HDMI jack is assigned to it.</p> <p>"Off": The setting is disabled. Video of device connected to any jack will not be displayed.</p> <p>"BD/DVD", "CBL/SAT", "STB/DVR", "GAME", "PC", "AUX", "TV/CD", "PHONO": Video of the device connected to the HDMI IN jack assigned to each input will be displayed on the TV.</p> <p>"Last": Video of the device connected to the HDMI IN jack assigned to the input selector that was selected immediately before the unit enters standby mode will be displayed on the TV.</p> <p>"Auto": Video of all the devices connected to the HDMI IN jacks will be output to the TV.</p> <p>"Eco": Video of all the devices connected to the HDMI IN jacks will be output to the TV. If you select this setting when using a CEC-compatible TV, you can reduce the power consumption in standby mode.</p> <ul style="list-style-type: none"> • "Auto" and "Eco" cannot be selected if "HDMI CEC (RIHD)" is set to "Off". • When "HDMI Through" is enabled, the power consumption increases even when the unit is on standby. However, the increase in power consumption is kept to a minimum by automatically entering the HYBRID STANDBY mode, where only the essential circuit is operating. • When changing the setting, turn off and then on again the power of all connected components.

Setting Item	Default Value	Setting Details
Audio TV Out (MAIN)	Off	<p>You can enjoy audio through the speakers of the HDMI connected TV while this unit is on.</p> <p>"On": Use this function</p> <p>"Off": Do not use this function</p> <ul style="list-style-type: none"> • If you select "On", set "HDMI CEC (RIHD)" to "Off." • The setting is fixed to "Auto" if "HDMI CEC (RIHD)" is set to "On". • Listening mode cannot be changed if "Audio TV Out (MAIN)" is set to "On" and audio is being output through the speakers of the TV. • Depending on your TV set or input signal of the component, audio may not output through the speakers of the TV even if this setting is set to "On". In such case, audio is output from the speakers of the unit. • If you operate the Master Volume control of the unit when "Audio TV Out (MAIN)" or "HDMI CEC (RIHD)" is set to "On" and you are listening to the audio through the speakers of your TV, audio will be output from the unit. If you do not want to output audio from the unit, change the unit or TV settings, or reduce the volume of the unit. • "Audio TV Out (MAIN)" is fixed to "Off" if "Monitor Out" is set to "SUB".

Setting Item	Default Value	Setting Details
Audio TV Out (SUB)	Off	<p>You can enjoy audio through the speakers of the HDMI connected TV while this unit is on.</p> <p>"On": Use this function "Off": Do not use this function</p> <ul style="list-style-type: none"> Listening mode cannot be changed while "Audio TV Out (SUB)" is set to "On" and audio is being output through the speakers of the TV. Depending on your TV set or input signal of the component, audio may not output through the speakers of the TV even if this setting is set to "On". In such case, audio is output from the speakers of the unit. If you operate the Master Volume control of the unit when "Audio TV Out (SUB)" is set to "On" and you are listening to the audio through the speakers of your TV, audio will be output from the unit. If you do not want to output audio from the unit, change the unit or TV settings, or reduce the volume of the unit. "Audio TV Out (SUB)" is fixed to "Off" if "Monitor Out" is set to "MAIN".
Audio Return Channel	–	<p>You can enjoy sound of the HDMI connected ARC compatible TV through the speakers connected to the unit. To use this function, set "HDMI CEC (RIHD)" to "On" in advance.</p> <p>"Auto": When enjoying the TV sound through the speakers connected to the unit "Off": When not using the ARC function</p>
Lip Sync	On	<p>This setting automatically corrects any desynchronization between the video and audio signals based on data from the HDMI LipSync compatible TV.</p> <p>"On": Automatic correction will be enabled. "Off": Automatic correction will be disabled.</p>
InstaPrevue		<p>Change the preview display of the video input through HDMI, which will be displayed using "InstaPrevue" in the Home menu.</p> <ul style="list-style-type: none"> Depending on the video source, the preview thumbnails configured in "InstaPrevue" may not be displayed properly.

Setting Item	Default Value	Setting Details
Sub Window	Multi	<p>Set how to display preview thumbnails.</p> <p>"Multi": Displays all the thumbnails of HDMI IN 1, 2, 3, 4 and Front at once. "Single": Displays each thumbnail individually.</p>
Position	Bottom/Lower Right	<p>Set the position to display preview thumbnails.</p> <p>When "Multi" is selected for "Sub Window": Select from "Top", "Bottom", "Left" and "Right". When "Single" is selected for "Sub Window": Select from "Upper Left", "Upper Right", "Lower Left" and "Lower Right".</p>

- If "Monitor Out" is set to "MAIN+SUB" and "Audio TV Out (SUB)" is set to "On"
 - Set the audio output of the connected device to "2ch PCM".
 - If the audio input is via other than HDMI, sound of the TV connected to the HDMI OUT SUB jack will not be output.

Auto Standby

Setting Item	Default Value	Setting Details
Auto Standby	On/Off	<p>This setting places the unit on standby automatically after 20 minutes of inactivity without any video or audio input.</p> <p>"On": The unit will automatically enter standby mode ("ASb" will stay lit). "Off": The unit will not automatically enter standby mode.</p> <ul style="list-style-type: none"> "Auto Standby" is appeared on the display and menu screen 30 seconds before the Auto Standby comes on. "Auto Standby" does not work when Zone 2 is active. Default values vary depending on the regions.
HDMI Through	Off	<p>Enable or disable "Auto Standby" while "HDMI Through" is on.</p> <p>"On": The setting will be enabled. "Off": The setting will be disabled.</p> <ul style="list-style-type: none"> "HDMI Through" cannot be set to "On" if "Auto Standby" is set to "Off".

- When "HDMI Through" is used, the power consumption increases even when the unit is on standby. However, the increase in power consumption is kept to a minimum by automatically entering the HYBRID STANDBY mode, where only the essential circuit is operating.

Network

Make the network setting.

- When LAN is configured with a DHCP, set "DHCP" to "Enable" to configure the setting automatically. ("Enable" is set by default) To assign fixed IP addresses to each component, you must set "DHCP" to "Disable" and assign an address to this unit in "IP Address" as well as set information related to your LAN, such as Subnet Mask and Gateway.

Setting Item	Default Value	Setting Details
Network Standby	Off	You can turn on the power of the unit via network using an application such as Integra/Onkyo Remote. "On": Use this function "Off": Do not use this function <ul style="list-style-type: none"> When "Network Standby" is used, the power consumption increases even when the unit is on standby. However, the increase in power consumption is kept to a minimum by automatically entering the HYBRID STANDBY mode, where only the essential circuit is operating.
Wi-Fi	Off(Wired)	Connect the unit to network via wireless LAN router. "On": Wireless LAN connection "Off(Wired)": Wired LAN connection
Wi-Fi Setup	–	You can configure wireless LAN settings by pressing Enter when "Start" is displayed.
Wi-Fi Status	–	The information of the connected access point will be displayed. "SSID": SSID of the connected access point. "Security": Security method of the connected access point. "Signal": Signal strength of the connected access point. "Status": Status of the connected access point.
MAC Address	–	This is the MAC address of the AV receiver. This value is specific to the component and cannot be changed.

Setting Item	Default Value	Setting Details
DHCP	Enable	"Enable": Auto configuration by DHCP "Disable": Manual configuration without DHCP <ul style="list-style-type: none"> If selecting "Disable", you must set "IP Address", "Subnet Mask", "Gateway", and "DNS Server" manually.
IP Address	–	Displays/Sets the IP address.
Subnet Mask	–	Displays/Sets the subnet mask.
Gateway	–	Displays/Sets the gateway.
DNS Server	–	Displays/Sets the primary DNS server.
Proxy URL	–	Displays/Sets the proxy server URL.
Proxy Port	–	Displays/Sets the proxy server port number when you enter "Proxy URL".
Network Check	–	You can check the network connection. Press Enter when "Start" is displayed.

- Wait for a while if "Network" cannot be selected. It will appear when the network function is started up.

Bluetooth

Setting Item	Default Value	Setting Details
Bluetooth	On	Select whether or not to use the Bluetooth function. "On": Enables connection with a Bluetooth-enabled device by using the Bluetooth function. Select "On" also when making various Bluetooth settings. "Off": When not using the Bluetooth function
Direct Change	On	The input of the unit will automatically be switched to "BLUETOOTH" when connection is made from a Bluetooth-enabled device to the unit. "On": The input will automatically become "BLUETOOTH" when a Bluetooth-enabled device is connected. "Off": The function is disabled. <ul style="list-style-type: none"> If the input is not switched automatically, set to "Off" and change the input manually.

Setting Item	Default Value	Setting Details
Auto Reconnect	On	This function automatically reconnects to the Bluetooth-enabled device connected last when you change the input selector to "BLUETOOTH". "On": Use this function "Off": Do not use this function <ul style="list-style-type: none"> This function may not work depending on your Bluetooth-enabled device.
Wakeup via Bluetooth	Off	This function wakes up the unit on standby by connecting a Bluetooth-enabled device. "On": Use this function "Off": Do not use this function <ul style="list-style-type: none"> Setting to "On" increases the power consumption even when the unit is on standby. However, the increase in power consumption is kept to a minimum by automatically entering the HYBRID STANDBY mode, where only the essential circuit is operating. This setting is fixed to "Off" if "Direct Change" is set to "Off".
Pairing Information	–	When pairing is performed, the information of the previous pairing stored in this unit will be initialized. Pressing Enter when "Clear" is displayed initializes the pairing information stored in this unit. <ul style="list-style-type: none"> This function does not initialize the pairing information on the Bluetooth-enabled device. When pairing the unit again with the device, be sure to clear the pairing information on the Bluetooth-enabled device in advance. For information on how to clear the pairing information, refer to the Bluetooth-enabled device's instruction manual.
Device	–	Displays the name of the Bluetooth-enabled device connected to the unit. <ul style="list-style-type: none"> The name is not displayed when "Status" is "Ready" and "Pairing".

Setting Item	Default Value	Setting Details
Status	–	Displays the status of the Bluetooth-enabled device connected to the unit. "Ready": Not paired "Pairing": Paired "Connected": Successfully connected

- Wait for a while if "Bluetooth" cannot be selected. It will appear when the network function is started up.

Firmware Update

Setting Item	Default Value	Setting Details
Update Notice	Enable	Availability of a firmware update will be notified via network. "Enable": Notify updates "Disable": Do not notify updates
Version	–	The current firmware version will be displayed.
Update via NET	–	Press Enter to select when you want to update the firmware via network. <ul style="list-style-type: none"> You will not be able to select this setting if you do not have Internet access or there is nothing to update.
Update via USB	–	Press Enter to select when you want to update the firmware via USB. <ul style="list-style-type: none"> You will not be able to select this setting if a USB storage device is not connected or there is nothing to update in the USB storage device.

- Wait for a while if "Firmware Update" cannot be selected. It will appear when the network function is started up.

Initial Setup

You can make the initial setup from the setup menu.

- Wait for a while if "Initial Setup" cannot be selected. It will appear when the network function is started up.
- Setting is not possible if "Monitor Out" is set to "SUB".

8.Remote Controller Setup

Setting Item	Default Value	Setting Details
Remote ID	1	<p>Select an ID for the unit's remote controller from "1", "2", and "3" to prevent interference between the unit and other Integra/Onkyo components that are installed in the same room. After changing the ID on the main unit, change the ID on the remote controller accordingly with the following procedure.</p> <ol style="list-style-type: none"> 1. While holding down RCV, press Q Setup for about 3 seconds until the remote indicator stays lit. 2. With the number buttons, press one of 1, 2, and 3. The remote indicator flashes twice.
Remote Mode Setup	–	<p>Input and register the remote controller code of other devices.</p> <ul style="list-style-type: none"> • For registration of the remote control code, refer to "Operating Other Components Using Remote Controller".

9.Lock Setup

Setting Item	Default Value	Setting Details
Setup	Unlocked	<p>The Setup menu will be locked to protect the settings.</p> <p>"Locked": The menu is locked.</p> <p>"Unlocked": The menu is unlocked.</p>

Operating Other Components Using Remote Controller

Functions of Remote Mode Buttons

You can control any other device than this unit by programming a specified remote control code to a Remote Mode button of the remote controller. Register a remote control code to a desired Remote Mode button and press it to enter the remote mode that allows you to operate the corresponding device.

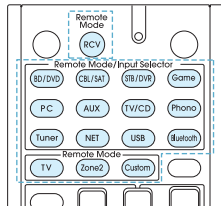

* The RCV and Zone2 buttons cannot be programmed.

Programming Remote Control Codes

For information on the configuration and operation of Integra/Onkyo components with RI jack, refer to "Connecting and Operating Integra/Onkyo RI Components". Furthermore, the following Remote Mode buttons are preprogrammed with remote control codes.

BD/DVD: Integra/Onkyo Blu-ray Disc and DVD player

TV/CD: Integra/Onkyo CD player

STB/DVR: Apple TV

■ Searching in the Setup Menu

You can search a remote control code and register it to a desired Remote Mode button in the unit's Setup menu.

1. Press RCV and then press Home on the remote controller.

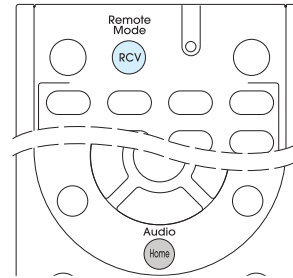

2. Select "Setup" with the cursors and press Enter.
3. With the cursors, select "8.Remote Controller Setup" - "Remote Mode Setup" and press Enter.
4. With the cursors, select the remote mode for which you want to search a remote control code and press Enter to display the category selection screen.
5. Select the target category with the cursors, and then press Enter to display the brand name input screen.
6. Select a character with the cursors and press Enter. Repeat it to enter the first three characters of the brand name.
7. Select "Search" with the cursors and press Enter.
 - After a search is done, the list of possible brand names is displayed. If the brand name list is not displayed, select "Not Listed" with the cursors and press Enter to return to the brand name input screen in step 6.
8. Select the target brand name with the cursors, and then press Enter.
 - When the brand name is specified, the remote control code of the brand and how to register it will be displayed on the TV screen.
9. Follow the guidance displayed on the TV screen.
10. If the component can successfully be operated with its registered remote control code, select "OK" with the cursors and press Enter.
 - Only TV remote control codes can be entered for TV.
 - Program a remote control code in accordance with the input since each button also works as the input selector. (For example, when the CD player is connected to the TV/CD jack, program the remote control code for the CD player to TV/CD.)

- If the component cannot be operated, select "Try Next Code" with the cursors and press Enter to display another code.
- It is possible to operate an MHL-enabled mobile device with the unit's remote controller by registering the code of the MHL-enabled mobile device below to the unit's remote controller. Operation may be unstable or incorrect depending on the mobile device used.
33101 (North American model)
32910 (Australian model)

■ Consulting the Remote Control Code List

Find the remote control code in the remote control code list.

1. Look up the [Remote Control Code List](#) for the corresponding remote control code.
 - The codes in the Remote Control Code List are those known as of the date of publication and may be changed.
 - Only TV remote control codes can be entered for TV.
 - Program a remote control code in accordance with the input since each button also works as the input selector. (For example, when the CD player is connected to the TV/CD jack, program the remote control code for the CD player to TV/CD.)
2. Press Display for 3 or more seconds while holding down the Remote Mode button to which you want to program the remote control code.
 - The remote indicator stays lit in the input mode.

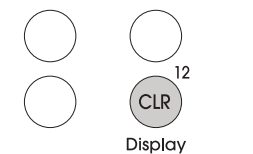

3. With the number buttons, enter the 5-digit remote control code within 30 seconds.

- The registration is complete when the remote indicator flashes twice. The remote indicator flashes once slowly when registering the remote control code fails. Try the registration again.

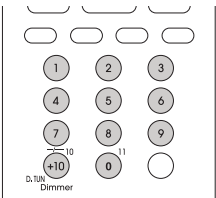

once slowly when registering the remote control code fails. Try the registration again.

- Pressing any other button than a colored button cancels the remap operation.

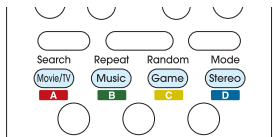

Resetting the Remote Mode Buttons

You can reset the remote control code registered in the Remote Mode button to its default status. This operation can be executed on a single Remote Mode button.

- Press Home for 3 or more seconds while holding down the Remote Mode button you want to reset.
 - The remote indicator stays lit.

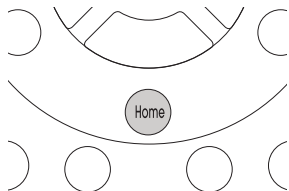

- Within 30 seconds, press the Remote Mode button again.

- Resetting is complete when the remote indicator flashes twice.

To reset all the remote controller settings: While holding down RCV, press and hold down Home until the remote indicator lights (about 3 seconds). Press RCV again within 30 seconds. Reset is complete when the remote indicator flashes twice.

Remapping the Colored Buttons

The colored button assignment on the AV receiver's remote controller can be remapped to match that on the remote controller of the component whose remote control code you programmed to Remote Mode. However, you will not be able to remap the colored buttons if Zone 2 is selected.

- Hold down the Remote Mode button to map and A (Red) simultaneously until the remote indicator stays lit (about 3 seconds).
 - Remapping is possible only for codes included in the categories of the Remote Control Code List such as DVD player and TV.

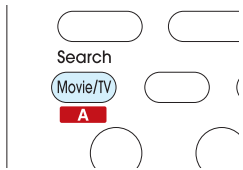

- Within 30 seconds, press the colored buttons from left to right, in the order you want to remap.

- For example, if the colored buttons on the remote controller of the other component are yellow, green, blue, and red from left to right, press the buttons on the AV receiver's remote controller in that order.
- The registration is complete when the remote indicator flashes twice. The remote indicator flashes

TV Operation

Press the Remote Mode button programmed with the remote control code for the relevant AV component to switch the remote controller mode to that for the AV component. Then, operate by using the corresponding buttons. Available buttons vary depending on the product category of the component. Operation may be incorrect or impossible depending on the product.

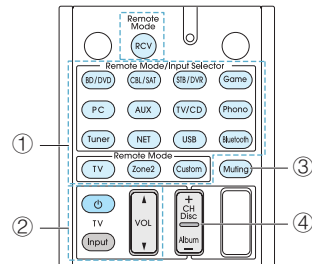

- Remote Mode
- Input, VOL ▲/▼
- Muting
- CH +/-

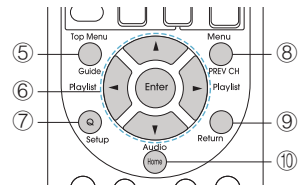

- Guide
- ▲/▼/◀/▶, Enter
- Setup
- PREV CH
- Return
- Audio (*)

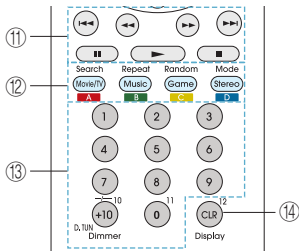

- 11 ▶, ■, ■, ◀, ▶, ◀◀, ▶▶ (*)
- 12 A (Red), B (Green), C (Yellow), D (Blue)
- 13 Number 1 to 9, 0, +10
- 14 CLR, Display

* Not CEC-compatible.

Blu-ray Disc Player/DVD Player/DVD Recorder Operation

Press the Remote Mode button programmed with the remote control code for the relevant AV component to switch the remote controller mode to that for the AV component. Then, operate by using the corresponding buttons. Available buttons vary depending on the product category of the component. Operation may be incorrect or impossible depending on the product.

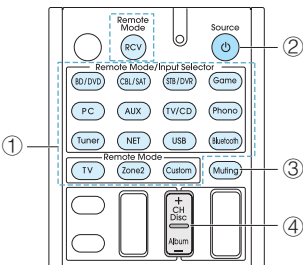

- 1 Remote Mode
- 2 Source
- 3 Muting
- 4 CH +/-, Disc +/-

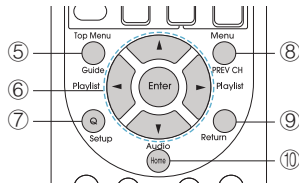

- 5 Top Menu
- 6 ▲/▼/◀▶, Enter
- 7 Setup
- 8 Menu
- 9 Return
- 10 Audio (*)

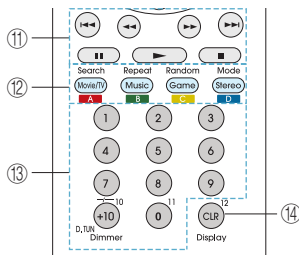

- 11 ▶, ■, ■, ◀, ▶, ◀◀, ▶▶
- 12 A (Red), B (Green), C (Yellow), D (Blue)
- 13 Number 1 to 9, 0, +10 (*)
- 14 CLR, Display

* Not CEC-compatible.

VCR/PVR Operation

Press the Remote Mode button programmed with the remote control code for the relevant AV component to switch the remote controller mode to that for the AV component. Then, operate by using the corresponding buttons. Available buttons vary depending on the product category of the component. Operation may be incorrect or impossible depending on the product.

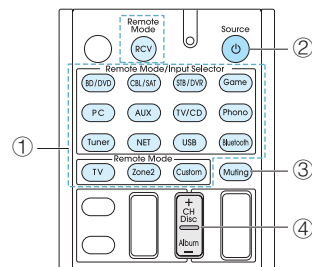

- 1 Remote Mode
- 2 Source
- 3 Muting
- 4 CH +/-

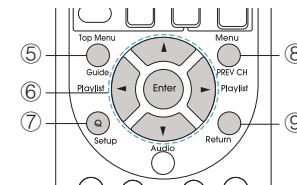

- 5 Guide
- 6 ▲/▼/◀▶, Enter
- 7 Setup
- 8 PREV CH
- 9 Return

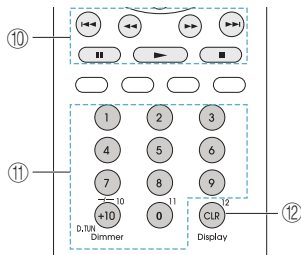

- ⑩ ►, ■, ■, ◀, ►, ◀, ►, ►
- ⑪ Number 1 to 9, 0, +10
- ⑫ CLR, Display

Satellite Receiver/Cable Receiver Operation

Press the Remote Mode button programmed with the remote control code for the relevant AV component to switch the remote controller mode to that for the AV component. Then, operate by using the corresponding buttons. Available buttons vary depending on the product category of the component. Operation may be incorrect or impossible depending on the product.

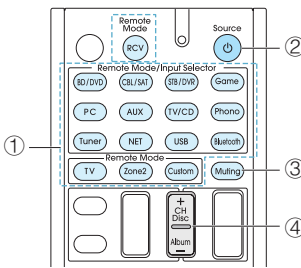

- ① Remote Mode
- ② Source
- ③ Muting
- ④ CH +/-

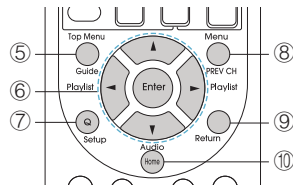

- ⑤ Guide
- ⑥ ▲/▼/◀/▶, Enter
- ⑦ Setup
- ⑧ PREV CH
- ⑨ Return
- ⑩ Audio

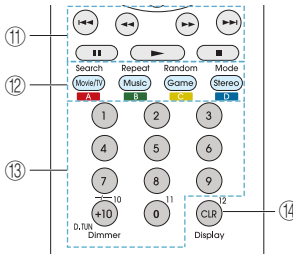

- ⑪ ►, ■, ■, ◀, ►, ◀, ►, ►
- ⑫ A (Red), B (Green), C (Yellow), D (Blue)
- ⑬ Number 1 to 9, 0, +10
- ⑭ CLR, Display

CD Player Operation

Press the Remote Mode button programmed with the remote control code for the relevant AV component to switch the remote controller mode to that for the AV component. Then, operate by using the corresponding buttons. Available buttons vary depending on the product category of the component. Operation may be incorrect or impossible depending on the product.

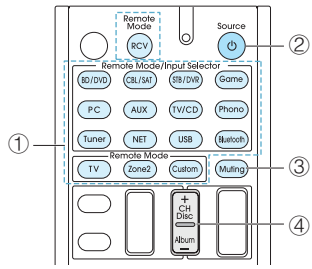

- ① Remote Mode
- ② Source
- ③ Muting
- ④ DISC +/-

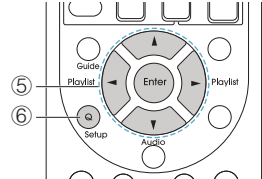

- ⑤ ▲/▼/◀/▶, Enter
- ⑥ Setup

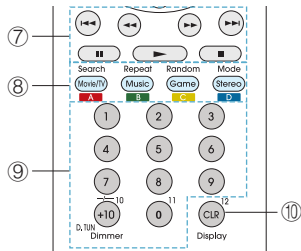

- ⑦ ▶▶, ■, ◀◀, ▶▶, ◀◀, ▶▶
- ⑧ Search, Repeat, Random, Mode
- ⑨ Number 1 to 9, 0, +10
- ⑩ CLR, Display

To Operate CEC-compatible Components

The TV and BD/DVD buttons on the remote controller are preprogrammed with remote control codes for linked operation of some CEC (Consumer Electronics Control)-compatible TV sets and Blu-ray Disk players. By connecting to the unit via HDMI, you may operate them using the AV receiver's remote controller.

- If you cannot operate your CEC-compatible component, program one of the following remote control codes to the TV or BD/DVD button.
 TV: 11807/13100/13500 (CEC-compatible TV)
 BD/DVD: 32910/33101/33501/31612 (CEC-compatible BD/DVD player)

Cassette Tape Deck Operation

Press the Remote Mode button programmed with the remote control code for the relevant AV component to switch the remote controller mode to that for the AV component. Then, operate by using the corresponding buttons. Available buttons vary depending on the product category of the component. Operation may be incorrect or impossible depending on the product.

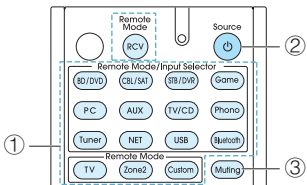

- ① Remote Mode
- ② ⏻ Source
- ③ Muting

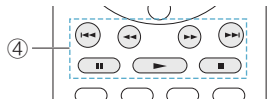

- ④ ▶▶ ◀◀ (Reverse Playback), ■, ◀◀, ▶▶, ◀◀, ▶▶

Advanced Speaker Connection

Bi-Amping

It is possible to connect speakers supporting bi-amping to improve quality of the bass and treble. Up to 5.1 ch will be played in bi-amping.

■ Connections

1. Connect as below using the FRONT terminals and BACK or HEIGHT terminals.

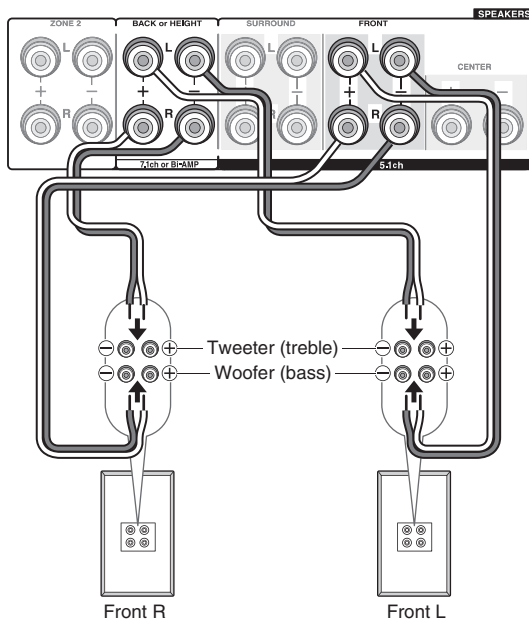

2. Turn the unit on and set "Speaker Setup" to "Bi-Amp".
 - ① After pressing RCV, press Home on the remote controller.

- ② Select "Setup" with the cursors and press Enter.
- ③ With the cursors, select "2.Speaker Setup" - "Speaker Settings" - "Front Speakers Type".
- ④ Select "Bi-Amp" with the cursors.
 - Before bi-amping, be sure to remove the short-circuit connector that connects the tweeter (treble) terminal and the woofer (bass) terminal.
 - Use speakers supporting bi-amping only. For details, refer to the speakers' instruction manual.

Connecting a Power Amplifier

You can connect a power amplifier to the unit and use the unit as a pre-amplifier in order to produce a large volume that cannot be output with the unit only. Connect the speakers to the power amplifier. For details, refer to the power amplifier's instruction manual.

■ Connections

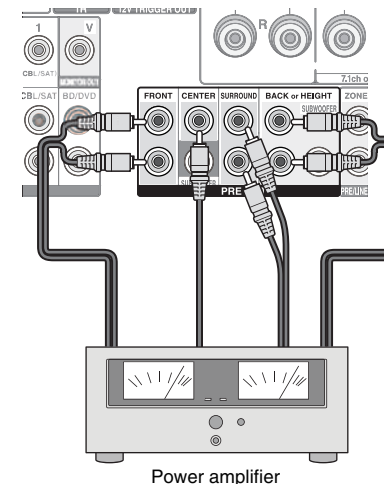

- Set the unconnected channels to "None" in "Speaker Configuration".
 - After pressing RCV, press Home on the remote controller. Select "Setup" with the cursors and press Enter. Then select "2.Speaker Setup" - "Speaker Configuration" and set the unconnected channels to "None".

Connecting and Operating Onkyo RI Components

About RI Function

Connecting an Onkyo component with RI jack such as the separately sold RI Dock to the unit by using an RI cable and an analog audio (RCA) cable enables the following RI functions:

System On/Auto Power On: Starting playback on a component connected via RI when the unit is on standby mode, automatically turns on the unit to select the relevant component as its input source.

Direct Change: When playback is started on a component connected via RI, the unit selects that component as the input source.

Remote Controller Operation: Allows you to operate RI-compatible Onkyo components using the AV receiver's remote controller. Point the remote controller at remote control sensor of the unit. This operation is possible only when the RI remote control code is programmed.

- Some components may not support all RI functions.
- These functions do not work when Zone 2 is turned on.
- For information on the RI functions, also refer to each component's instruction manual.

RI Connection and Setting

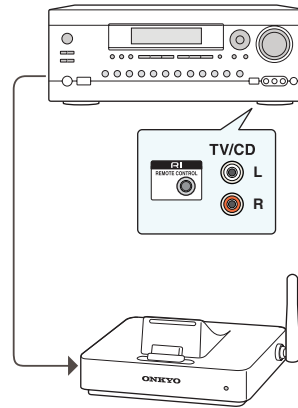

Connect an Onkyo component with RI jack to this unit using an RI cable and an analog audio (RCA) cable. For details, refer to the instruction manual of the component with RI jack. The RI cable can be connected in any order. When there are two RI jacks, both jacks work in the same way and are interchangeable.

To connect the RI Dock or cassette tape deck via RI, you must:

■ Rename the input selector

To make the RI functions work, you must rename the input selectors on the unit. Press TV/CD or Game to display "TV/CD" or "GAME" on the main unit display. Then press and hold TV/CD or Game 3 seconds or more to switch the display to "DOCK" or "TAPE".

■ Program the RI remote control code

Program the remote control code to any Remote Mode button on the remote controller. This will allow you to operate the component by pointing the remote controller at the unit instead of the component.

1. Press Display for 3 or more seconds while holding down the Remote Mode button to which you want to program the remote control code.

- The remote indicator stays lit.
- The RCV, Zone2, and TV buttons cannot be programmed.

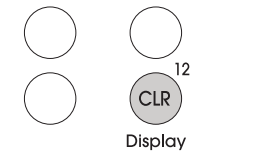

2. With the number buttons, enter the following 5-digit remote control code within 30 seconds.

RI Dock: 81993

Cassette tape deck with RI jack: 42157

- Programming is complete when the remote indicator flashes twice. The remote indicator flashes once slowly when programming the remote control code fails. Try programming again.

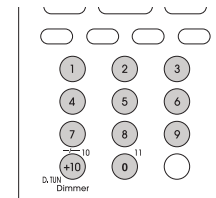

Input selector on the RI Dock: Select "HDD" or "HDD/DOC". For details, refer to the RI Dock's instruction manual.

To operate Onkyo components directly or Onkyo components that are not connected via RI, use the following remote control codes:

Onkyo DVD player: 30627

Onkyo CD player: 71817

RI Dock: 82990

- With some models, operation may be not possible in part or not possible at all.

iPod/iPhone Operation

The RI Dock allows you to use the AV receiver's remote controller to operate and play music on your iPod/iPhone. Moreover, it also allows you to view videos on your iPod/iPhone on the screen of your TV, as well as perform RI operations if connected via RI. This operation is possible only when the RI remote control code is programmed.

Before Performing any Operation: Before performing any operation on your iPod/iPhone, make sure to have it updated to the latest version via iTunes. Certain buttons may not work for some iPod/iPhone models and generations, or RI Dock. For details on the operation, refer to the RI Dock's instruction manual.

Switch the remote controller mode by pressing the Remote Mode button programmed with the remote control code for the iPod/iPhone, and operate by using the corresponding buttons. Point the remote controller at the unit.

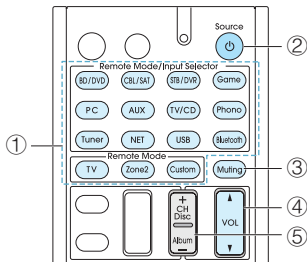

- ① Remote Mode
- ② Source
- ③ Muting
- ④ VOL ▲/▼
- ⑤ Album +/-

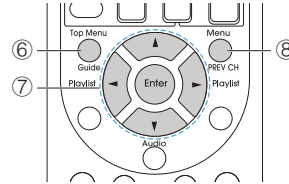

- ⑥ Top Menu
- ⑦ ▲/▼/◀/▶, Enter, Playlist
- ⑧ Menu

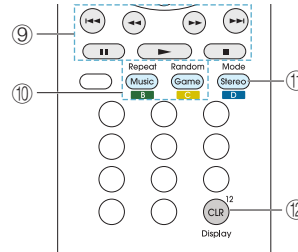

- ⑨ ▶, ||, ■, ◀▶, ▶▶, ◀◀, ▶▶▶
- ⑩ Repeat, Random
- ⑪ Mode
- ⑫ Display

- Pressing Display turns on the backlight for a few seconds.
- Mode allows you to use the Resume function to resume playing from the song that was playing when you removed your iPod/iPhone from the DS-A2 RI Dock.

Control Function between the Unit and External Component

You can enable the control functions between the unit and external devices using the terminals below. Special devices or cable connections are necessary to enable the functions. For more information about preparation, contact the specialized stores.

■ RS232 port

Use the port for connection with a commercially available integrated control system that can enable home automation. Some integrated control systems provide a centralized operation with a single touch panel controller in order to control audio and video home appliances and security devices together. For more information about adopting an integrated control system, contact the specialized stores.

■ IR jack

If you use a multiroom remote control kit such as Xantech and Niles with this jack, you can operate the unit with the remote controller even when you are in a separate room, or operate the unit with the remote controller even if its remote control sensor is difficult to see. You can also connect a device with the unit and operate it with the remote controller. For more information about adopting a multiroom remote control kit, contact the specialized stores.

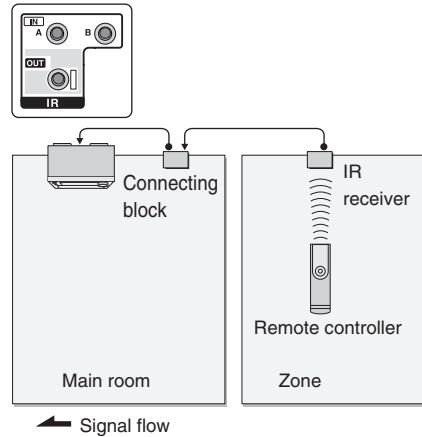

■ 12V trigger output jack

You can enable power link operation when you connect the unit and an external device such as power amplifier equipped with 12V trigger input jack. When the desired input is selected on the unit power link operation will be activated with a control signal of maximum 12 V/150 mA output from the 12V TRIGGER OUT A jack, or maximum 12 V/25 mA output from the 12V TRIGGER OUT B/C jacks. Each input can be set to output a control signal in any case of "Main (playback in the main room)", "Zone2 (playback in Zone 2)" or "Main/Zone2 (playback in the main room/Zone 2)". For connection, use a monaural mini plug cable.

Firmware Update

About Firmware Update

There are two methods for updating the firmware: via network and via USB.

Use the one that best suits your environment.

- For the latest information on updates, visit the Integra website.
- Before updating, make sure that the speaker setup microphone is not connected.
- During an update, do not
 - Disconnect and reconnect any cable, USB storage device, speaker setup microphone or headphones, or perform any operation on the component such as turn off its power
 - Access to this unit from a PC or smartphone using Android application
- The update may take about 20 minutes to complete for either method: via network or via USB.
Furthermore, existing settings are guaranteed regardless of the method used for update.

Disclaimer: The program and accompanying online documentation are furnished to you for use at your own risk.

Onkyo will not be liable and you will have no remedy for damages for any claim of any kind whatsoever concerning your use of the program or the accompanying online documentation, regardless of legal theory, and whether arising in tort or contract.

In no event will Onkyo be liable to you or any third party for any special, indirect, incidental, or consequential damages of any kind, including, but not limited to, compensation, reimbursement or damages on account of the loss of present or prospective profits, loss of data, or for any other reason whatsoever.

Updating the Firmware via Network

Before Start:

- Check that the unit is turned on, and the connection to the Internet is secured.
- Turn off the controller component (PC etc.) connected to the network.
- Stop any playing Internet radio, USB storage device, or server content.
- If the multi-zone function is active, press Off on the main unit to turn it off.
- If "HDMI CEC (RIHD)" is set to "On", set it to "Off" (default value).
 - After pressing RCV, press Home on the remote controller. Select "Setup" with the cursors and press Enter. Then, after selecting "7.Hardware Setup" - "HDMI" and pressing Enter, select "HDMI CEC (RIHD)" to select "Off".

* The description may differ from the on-screen display but that will not change the way to operate or the function.

Update

1. Press RCV and then press Home on the remote controller.

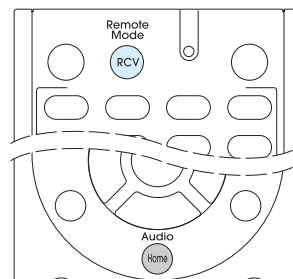

The Home menu is displayed on the TV screen.

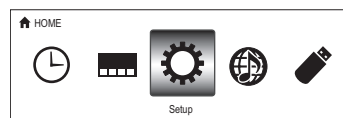

2. With the cursors, select "Setup" - "7.Hardware Setup" - "Firmware Update" - "Update via NET", and then press Enter.
 - If "7.Hardware Setup" is grayed out and cannot be selected, wait for a while until it starts up.
 - You will not be able to select "Update via NET" if there is nothing to update.
3. Press Enter with "Update" selected to start update.
 - During the update, the TV screen may go black depending on the updated program. In that case, check the progress on the display of the unit. The TV screen will remain black until the update is complete and the power is turned on again.
 - "Completed!" is displayed when the update is complete.
4. Press On/Standby on the main unit to turn the unit into standby mode. The process is completed and your firmware is updated to the latest version.
 - Do not use On/Receiver on the remote controller.

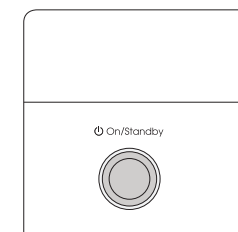

■ If an Error Message is Displayed

Case 1: When an error occurs, "*-* Error!" is appeared on the display of the unit. ("*" represents an alphanumeric character.) Check the following:

Error Code

• *-01, *-10:

Ethernet cable not found. Connect the Ethernet cable properly.

• *-02, *-03, *-04, *-05, *-06, *-11, *-13, *-14, *-16, *-17, *-18, *-20, *-21:

Internet connection error. Check the following:

- Whether the router is turned on
- Whether this unit and router are connected to the network

Try to disconnect and then connect again the power to the unit and router. This may solve the problem. If you are still unable to connect to the Internet, the DNS server or proxy server may be temporarily down. Check the service status with your ISP provider.

• Others:

disconnect then reconnect the AC power cord, from the beginning.

Updating the Firmware via USB

Before Start:

- Prepare a 64 MB or larger USB storage device.
 - Media inserted in a USB card reader may not be used for this function.
 - USB storage devices with security function are not supported.
 - USB hubs and USB devices with hub function are not supported. Do not connect these devices to the unit.
- Delete any data stored on the USB storage device.
- Turn off the controller component (PC etc.) connected to the network.
- Stop any playing Internet radio, USB storage device, or server content.
- If the multi-zone function is active, press Off on the main unit to turn it off.
- If "HDMI CEC (RIHD)" is set to "On", set it to "Off" (default value).
 - After pressing RCV, press Home on the remote controller. Select "Setup" with the cursors and press Enter. Then, after selecting "7.Hardware Setup" - "HDMI" and pressing Enter, select "HDMI CEC (RIHD)" to select "Off".
- * Some USB storage devices may take long to load, may not be loaded correctly, or may not be correctly fed depending on the device or their content.
- * Onkyo will not be liable whatsoever for any loss or damage of data, or storage failure arising from the use of the USB storage device with this AV receiver. Thank you for your understanding.
- * The description may differ from the on-screen display but that will not change the way to operate or the function.

■ Update

1. Connect the USB storage device to your PC.
2. Download the firmware file from the Integra website to your PC and unzip.

Firmware files are named in the following way:
ONKAVR****_*****.zip

Unzip the file on your PC. The number of unzipped files and folders varies depending on the model.
3. Copy all unzipped files and folders to the root folder of the USB storage device.
 - Make sure to copy the unzipped files.

4. Press USB on the remote controller to select "USB".

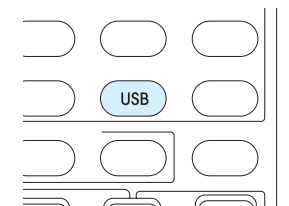

5. Connect the USB storage device to the USB port of the main unit.

- If you connect a USB hard disk drive to the USB port of the unit, we recommend that you use its AC adapter to power it.
- If the USB storage device has been partitioned, each section will be treated as an independent device.

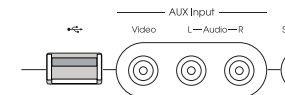

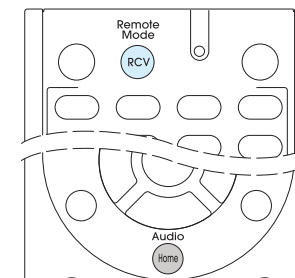

6. Press RCV and then press Home on the remote controller.

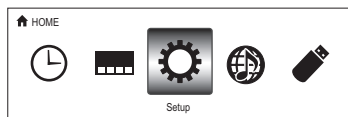

The Home menu is displayed on the TV screen.



7. With the cursors, select "Setup" - "7.Hardware Setup" - "Firmware Update" - "Update via USB", and then press Enter.
 - If "7.Hardware Setup" is grayed out and cannot be selected, wait for a while until it starts up.
 - You will not be able to select "Update via USB" if there is nothing to update.
8. Press Enter with "Update" selected to start update.
 - During the update, the TV screen may go black depending on the updated program. In that case, check the progress on the display of the unit. The TV screen will remain black until the update is complete and the power is turned on again.
 - During the update, do not turn off, or disconnect then reconnect the USB storage device.
 - "Completed!" is displayed when the update is complete.
9. Disconnect the USB storage device from the unit.
10. Press  On/Standby on the main unit to turn the unit into standby mode. The process is completed and your firmware is updated to the latest version.
 - Do not use  Receiver on the remote controller.

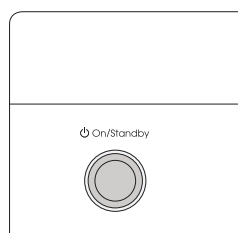

■ If an Error Message is Displayed

Case 1: When an error occurs, "*-*-* Error!" is appeared on the display of the unit. ("*" represents an alphanumeric character.) Check the following:

Error Code

- ***-01, *-10:**
USB storage device not found. Check whether the USB storage device or USB cable is correctly inserted to the USB port of the main unit.
Connect the USB storage device to an external power source if it has its own power supply.
- ***-05, *-13, *-20, *-21:**
The firmware file is not present in the root folder of the USB storage device, or the firmware file is for another model. Retry from the download of the firmware file.
- **Others:**
disconnect then reconnect the AC power cord, from the beginning.

Troubleshooting

Before starting the procedure

Problems may be solved by simply turning the power on/off or disconnecting/connecting the power cord, which is easier than working on the connection, setting and operating procedure. Try the simple measures on both the unit and the connected device. If the problem is that the video or audio is not output or the HDMI linked operation does not work, disconnecting/connecting the HDMI cable may solve it. When reconnecting, be careful not to wind the HDMI cable since if wound the HDMI cable may not fit well. After reconnecting, turn off and on the unit and the connected device.

Resetting the unit

Resetting the unit to the status at the time of shipment may solve the problem. If the measures above do not solve the problem, reset the unit with the following procedure. If you reset the unit status, your preferences will be reset to the defaults. Note them down before starting reset.

How to reset

1. While holding down CBL/SAT on the main unit (note that step 2 must be performed with this button pressed down)
2. Press On/Standby on the unit. "Clear" is appeared on the display and the unit will enter standby mode.

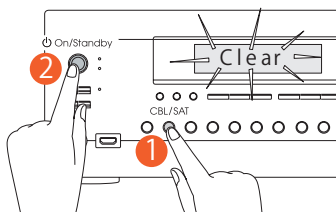

How to reset the remote controller

1. While holding down RCV on the remote controller (note that step 2 must be performed with this button pressed down)
2. Press and hold down Home until the remote indicator stays lit (about 3 seconds). Within 30 seconds, press RCV again.

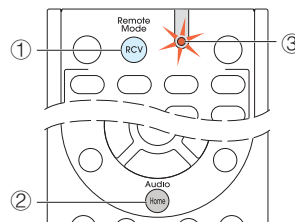

Power

Cannot turn on the unit

- Make sure that the power cord is properly plugged into the wall outlet.
- Unplug the power cord from the wall outlet, wait 5 seconds or more, then plug it in again.

The unit turns off unexpectedly

- The unit will automatically enter standby mode when Auto Standby has been set and launches.

The unit turns off and after restoring the power, it turns off again

- The protection circuit has been activated. Remove the power cord from the wall outlet immediately. Make sure that all speaker cables and input sources are properly connected, and leave the unit with its power cord disconnected for 1 hour. After that, reconnect the power cord and turn the power on. If the unit turns off again, avoid resetting it and unplug the power cord. Then contact your dealer.

Caution: If "CHECK SP WIRE" appears on the display, the speaker cables may be short-circuited.

WARNING: If smoke, smell or abnormal noise is produced by the unit, unplug the power cord from the wall outlet immediately and contact the dealer or Integra Support.

Audio

There is no sound, or it is very quiet

- Make sure that the proper input source is selected.
- Make sure that connecting plugs are pushed in all the way.
- Make sure that the inputs and outputs of all components are connected properly.
- Make sure that the polarity of the speaker cables is correct, and that no bare wires are in contact with the metal part of speaker terminals.
- Make sure that the input source is properly selected.
- Make sure that the speaker cables are not shorting.
- Check the volume. The volume level is adjustable between Min, 1 to 79, Max (80) It is normal that the unit volume level is set up to 40 or around.
- If the MUTING indicator on the display flashes, press Muting on the remote controller to unmute the unit.
- While headphones are connected to the PHONES jack, no sound is output from the speakers.
- If there is no sound from a BD/DVD player connected to an HDMI IN, check the BD/DVD player's output settings, and be sure to select a supported audio format.
- Check the digital audio output setting on the connected component. On some game consoles, such as those that support DVD, the default setting is off.
- With some DVD-Video discs, you need to select an audio output format from a menu.
- If your turntable uses an MC cartridge, you must connect an MC head amp, or an MC transformer.
- Make sure that none of the connecting cables are bent, twisted, or damaged.
- Not all listening modes use all speakers.
- Specify the speaker distances and adjust the individual speaker levels.
- Make sure that the speaker setup microphone is not still connected.
- If the input signal format is set to "PCM" or "DTS", set it to "Off".

Only the front speakers produce sound

- When the Stereo or Mono listening mode is selected, only the front speakers and subwoofer produce sound.
- Make sure the speakers are configured correctly.

■ Only the center speaker produces sound

- If you use the Dolby Pro Logic II listening mode with a mono source, such as an AM radio station or mono TV program, the sound is concentrated in the center speaker.
- Make sure the speakers are configured correctly.

■ The surround speakers produce no sound

- When the T-D (Theater-Dimensional), Stereo or Mono listening mode is selected, the surround speakers produce no sound.
- Depending on the source and current listening mode, not much sound may be produced by the surround speakers. Try selecting another listening mode.
- Make sure the speakers are configured correctly.

■ The center speaker produces no sound

- When the Stereo or Mono listening mode is selected, the center speaker produces no sound.
- Make sure the speakers are configured correctly.

■ The subwoofer produces no sound

- When you play source material that contains no information in the LFE channel, the subwoofer produces no sound.
- Make sure the speakers are configured correctly.

■ There is no sound with a certain signal format

- When listening to Dolby Digital and/or DTS sound, digital connection is necessary.
- Check the digital input terminal setting. If the connection is different from the default, re-setting is necessary.
- Check the digital audio output setting on the connected component. On some game consoles, such as those that support DVD, the default setting is off.

■ Cannot select a desired listening mode

- Depending on the connecting status of the speaker, some listening modes may not be selected. Check the details in "Using the Listening Modes" section.

■ Cannot play 5.1ch

- Make sure the speakers are configured correctly.
- Not all listening modes use all speakers.

■ Cannot get 6.1/7.1 playback

- 6.1/7.1 playback is not possible if surround back speakers and height speakers are not connected.

- Depending on the number of connected speakers, it is not always possible to select all of the listening modes.

■ The speaker volume cannot be set as required

- Check to see if a maximum volume has been set.

■ Noise can be heard

- Using cable ties to bundle analog audio (RCA) cables with power cords, speaker cables, etc. may degrade the audio performance, so refrain from doing it.
- An analog audio (RCA) cable may be picking up interference. Try repositioning your cables.

■ The Late Night function does not work

- Make sure the source material is Dolby Digital, Dolby Digital Plus, or Dolby TrueHD.

■ About DTS signals

- When DTS program material ends and the DTS bitstream stops, the unit remains in DTS listening mode and the dts indicator remains on. This is to prevent noise when you use the pause, fast forward, or fast reverse function on your player. If you switch your player from DTS to PCM, you may not hear any sound because the unit does not switch formats immediately. In such case, you should stop your player for about 3 seconds and then resume playback.
- With some CD and LD players, you will not be able to playback DTS material properly even though your player is connected to a digital input on the unit. This is usually because the DTS bitstream has been processed (e.g., output level, sampling rate, or frequency response changed) and the unit does not recognize it as a genuine DTS signal. In such cases, you may hear noise.
- Playing DTS program material, using the pause, fast forward, or fast reverse function on your player may produce a short audible noise. This is not a malfunction.

■ The beginning of audio received by an HDMI IN cannot be heard

- Since it takes longer to identify the format of an HDMI signal than it does for other digital audio signals, audio output may not start immediately.

Video

■ There is no picture

- Make sure that all video connecting plugs are pushed in all the way.
- Make sure that each video component is properly connected.
- If the TV is connected to the HDMI OUT jack of the unit, set "Monitor Out" to "MAIN" or "SUB" according to the output jack. If the playback source is connected to the video (composite) jack or component video jacks and you want to output the video to the TV via the HDMI OUT jack, set "HDMI Input" to "----".
- If the video source is connected to a component video input, you must assign that input to an input selector, and your TV must be connected to COMPONENT VIDEO OUT terminal.
- If the video source is connected to a composite video input, your TV must be connected to the MONITOR OUT V terminal.
- If the video source is connected to an HDMI input, you must assign that input to an input selector, and your TV must be connected to the HDMI output(s).
- Make sure the switching of input screens is proper at the monitor side such as a TV.
- When the image input from the composite video input terminal does not get displayed, make sure that the component video input terminal is not set to the selected input. If selected, images input from the composite video input terminal cannot be output to this input switching. If only composite video input terminal connection is used, set the component video input terminal to "----".
- Images of a component connected to the composite video input terminal cannot be output by converting on the monitor of a TV or other components connected to COMPONENT VIDEO OUT terminal.
- If the input selector to which the input from the TV connected to the HDMI OUT SUB jack is connected is changed on this unit when "Monitor Out" is set to "MAIN+SUB", or "MAIN" and when outputting to Zone 2, the video from the TV connected to HDMI OUT MAIN stops displaying.
- "Resolution" is effective only for the HDMI OUT MAIN jack if "Monitor Out" is set to "MAIN+SUB".

■ There is no picture from a source connected to an HDMI IN

- Reliable operation with an HDMI-to-DVI adapter is not guaranteed. In addition, video signals from a PC are not supported.
- Check if "Resolution Error" is displayed on the main unit display when video input via HDMI IN jack is not displayed. In this case, the TV does not support the resolution of the video input from the player. Change the setting on the player.
- **The on-screen menus do not appear**
- On your TV, make sure that the video input to which this unit is connected is selected.
- Set "On Screen Display" to "On" in "OSD Setup".
- When the unit is not connected to a TV via HDMI OUT MAIN jack, the setting screen and on-screen menus are displayed only on the connected TV or monitor display.

Tuner

■ Reception is noisy, FM stereo reception is noisy, or the FM STEREO indicator does not light

- Re-check the antenna connection.
- Relocate your antenna.
- Move the unit away from your TV or PC.
- Passing cars and airplanes can cause interference.
- Concrete walls weaken radio signals.
- Listen to the station in mono.
- When listening to an AM station, operating the remote controller may cause noise.
- If nothing improves the reception, install an outdoor antenna.

Remote Controller

■ The remote controller does not work

- Before operating this unit using remote controller, be sure to press RCV.
- Make sure that the batteries are installed with the correct polarity.
- Install new batteries. Do not mix different types of batteries, or old and new batteries.
- Make sure that the remote controller is not too far away

from the unit, and that there is no obstruction between the remote controller and the remote control sensor of the unit.

- Make sure that the unit is not subjected to direct sunshine or inverter-type fluorescent lights. Relocate if necessary.
- If the unit is installed in a rack or cabinet with colored-glass doors or if the doors are closed, the remote controller may not work reliably.
- Make sure you have selected the correct remote controller mode.
- When using the remote controller to control other manufacturers' AV components, some buttons may not work as expected.
- Make sure you have entered the correct remote control code.
- Make sure to set the same ID on both the unit and remote controller.

■ Operating other Onkyo component by using a RI remote control code is not available

- Make sure that the Onkyo component is properly connected with RI cable. When RI cable is used for connection, make sure to connect analog audio (RCA) cable as well. (Connecting only an RI cable will not be enough.)
- Make sure you have selected the correct remote controller mode.
- Make sure that the input display is correctly set.
- Input the RI remote control code again.
- When the RI remote control code is input, point the remote controller at remote control sensor of the unit.

■ Cannot operate Integra/Onkyo components (ones without RI connection) and components of other makers

- Make sure that the connection with other components is correct.
- Input a correct remote control code again. If there are several codes, try each code.
- Make sure that the remote controller mode is correctly selected.
- Operate the remote controller by setting toward the light receiving section of each component.
- Some components may not start the operation.

RI Dock for iPod/iPhone

■ There is no sound

- Make sure your iPod/iPhone is actually playing.
- Make sure your iPod/iPhone is properly inserted in the Dock.
- Make sure the unit is turned on, the correct input source is selected, and the volume is turned up.
- Make sure the plugs are pushed in all the way.
- Try resetting your iPod/iPhone.

■ There is no video

- Make sure that your iPod/iPhone model's TV OUT setting is set to On.
- Make sure the correct input is selected on your TV or the unit.
- Some versions of the iPod/iPhone do not output video.

■ The AV receiver's remote controller does not control my iPod/iPhone

- Make sure your iPod/iPhone is properly inserted in the Dock. If your iPod/iPhone is in a case, it may not connect properly to the Dock. Always remove your iPod/iPhone from the case before inserting it into the Dock.
- The iPod/iPhone cannot be operated while it is displaying the Apple logo.
- Make sure you have selected the correct remote controller mode.
- When you use the AV receiver's remote controller, point it toward this unit.
- Before operating with the remote controller, you may need to play on your iPod/iPhone to make the input selector be recognized.
- Try resetting your iPod/iPhone.
- Depending on your iPod/iPhone model and generation, some buttons may not work as expected.

■ The unit unexpectedly selects my iPod/iPhone as the input source

- Always pause iPod/iPhone playback before selecting a different input source. If playback is not paused, the Direct Change function may select your iPod/iPhone as the input source by mistake during the transition between tracks.

■ iPod/iPhone does not work properly

- Try reconnecting your iPod/iPhone.

Multi-zone Function

■ There is no sound

- With multi-zone function, sound is output only when the signal input source is an external component connected to the analog audio input jacks of the unit, "NET", "USB" or "BLUETOOTH". Multi-zone playback is not possible if the player and the unit are connected via HDMI cable or digital cable. Connect the RCA audio output jacks of the player and the analog audio input jacks of the unit with analog audio (RCA) cable. Also analog audio output setting may be necessary on the player.

Wi-Fi (Wireless LAN) Network

■ Cannot access to Wi-Fi (Wireless LAN) network or sound playback is interrupted and communication does not work

- Try plugging/unplugging the power supply of wireless LAN router and the unit, check the wireless LAN router power-on status, and try reboot of the wireless LAN router.
- The setting of SSID and encryption (WEP, etc.) is not correct. Make sure the network settings of the unit is properly set.
- Connection to an SSID that includes multi-byte characters is not supported. Name the SSID of the wireless LAN router using single-byte alphanumeric characters only and try again.
- Cannot receive radio wave due to a bad connection. Shorten the distance from wireless LAN access point or remove obstacles for a good visibility, and try again. Place the unit away from microwave ovens or other access points. 2.4 GHz band for wireless LAN may not be enough. Connect ETHERNET terminal of the unit and the router via an Ethernet cable after selecting "7.Hardware Setup" - "Network" and changing "Wi-Fi" to "Off(Wired)".

- Place the unit away from the components emitting electromagnetic waves on the 2.4 GHz band (microwave ovens, game consoles, etc.). If this does not solve the problem, stop using other components which emit electromagnetic waves.
- When other wireless LAN devices are used near the unit, several issues such as interrupted playback and communication may occur. You can avoid these issues by changing the channel of your wireless LAN router. For instructions on changing channels, see the instruction manual provided with your wireless LAN router.
- If there is a metallic object near the unit, wireless LAN connection may not be possible as the metal can effect on the radio wave.
- If there is more than one access point in the network, separate each access point.
- It is recommended to place the Wi-Fi router (access point) and the unit in the same room.

■ The connection does not complete even when the automatic setting button is pressed on the wireless LAN router

- The wireless LAN router setting may be switched to Manual. Return the setting to Auto.
- Try the manual set-up. The connection may succeed.

■ On the list of SSID on the TV menu screen, there is no corresponding SSID

- When the wireless LAN router setting is at stealth mode (mode to hide the SSID key) or when ANY connection is off, the SSID is not displayed. Change the setting and try again.

Bluetooth

■ Music playback is unavailable on the unit even after successful Bluetooth connection

- Depending on the characteristics or specifications of your Bluetooth-enabled device, playback on the unit is not guaranteed.
- When the audio volume of your Bluetooth-enabled device is set low, the playback of audio may be unavailable. Volume up the Bluetooth-enabled device.
- Depending on the Bluetooth-enabled device, Send/Receive selector switch may be provided. Select Send mode.

- Even when a music file is playing on the Bluetooth-enabled device, the sound cannot be played if the connection is not established with the unit. Make sure that the unit is connected (this unit is selected as the sound output destination).

■ Sound is interrupted

- Problem may be occurring at the Bluetooth-enabled device. Check the information on a web page.

■ The audio quality is poor after connection with a Bluetooth-enabled device

- The Bluetooth reception is poor. Move the Bluetooth-enabled device closer to the unit or remove any obstacle between the Bluetooth-enabled device and this unit.

■ Cannot connect with this unit

- Try plugging/unplugging the power of the unit and try turning on/off the Bluetooth-enabled device. Re-startup of the Bluetooth-enabled device may be effective.
- The Bluetooth-enabled device does not support the profiles required for this unit.
- The Bluetooth function of the Bluetooth-enabled device is not enabled. Refer to the user manual of the Bluetooth-enabled device for how to enable the function.
- Near components such as microwave oven or cordless phone, which use the radio wave in the 2.4 GHz range, a radio wave interference may occur, which disables the use of this unit.

■ Bluetooth connection cannot be built

- When building a Bluetooth connection between this unit and your Bluetooth-enabled device for the first time, if the connection fails, select "7.Hardware Setup" - "Bluetooth", execute "Clear" in "Pairing Information", turn off and then on again your Bluetooth-enabled device to clear the device name, and build the connection again.
- If there is a metallic object near the unit, Bluetooth connection may not be possible as the metal can effect on the radio wave.
- If the wireless LAN and Bluetooth connections are used at the same time, try to connect the ETHERNET port of the unit and router with the Ethernet cable after selecting "7.Hardware Setup" - "Network" and changing "Wi-Fi" to "Off(Wired)" for a better connection.

■ **The Auto Reconnect function of Bluetooth does not work**

- This may not work with some Bluetooth-enabled devices. In that case, pair the unit and the Bluetooth-enabled device and then play again

NET/USB Function

■ **Cannot access the network server**

- When NET is blinking, the AV receiver is not properly connected to the home network.
- Make sure your network server has been started up.
- Make sure your network server is properly connected to the home network.
- Make sure your network server is correctly set.
- Make sure that the router LAN side port is properly connected to the AV receiver.
- Make sure that the correct IP address is allocated in "7.Hardware Setup" - "Network".

■ **Playback stops while listening to music files on the network server**

- Make sure the network server is compatible with this unit.
- When the PC is serving as the network server, try quitting any application software other than the server software (Windows Media Player 12 etc.).
- If the PC is downloading or copying large files, the playback may be interrupted.

■ **Cannot access the Internet radio**

- Certain network service or contents available through the unit may not be accessible in case the service provider terminates its service.
- If a specific radio station is unavailable for listening, make sure the registered URL is correct, or whether the format distributed from the radio station is supported by the AV receiver.
- When NET is blinking, the AV receiver is not properly connected to the home network.
- Make sure that your modem and router are properly connected, and make sure they are both turned on.
- Make sure that connecting to Internet from other components is possible. If connecting is not possible, turn off all components connected to the network, wait for a while, and then turn on the components again.

- Make sure that the router LAN side port is properly connected to the AV receiver.
- Make sure that the correct IP address is allocated in "7.Hardware Setup" - "Network" on the unit.
- Depending on ISP, setting the proxy server is necessary.
- Make sure that the used router and/or modem is supported by your ISP.

■ **Cannot connect to the AV receiver from a Web browser**

- Make sure that the IP address of the AV receiver is correctly input to the Internet browser.
- When DHCP is used for allocating the IP address, the IP address of this AV receiver may have been changed.
- Make sure that both AV receiver and PC are properly connected to the network.

■ **USB storage device is not displayed**

- Make sure that USB storage device and USB cable are securely plugged to the USB port of this AV receiver.
- Remove the USB storage device from the AV receiver once, and then try re-connecting.
- Performance of the hard disk that receives power from the USB port of the unit is not guaranteed.
- Depending on the type of format, the playback may not be performed normally. Check the type of the file formats that is supported.
- USB storage device with security functions may not be played.

Others

■ **Power consumption in standby mode**

- In the following cases, the power consumption in standby mode may reach up to a maximum of 5 W:
 - When "Network Standby" in "7.Hardware Setup" - "Network" is set to "On".
 - When "HDMI CEC (RIHD)" is set to "On". (Depending on the TV status, the AV receiver will enter normal standby mode.)
 - The "HDMI Through" setting is set to other than "Off".
 - When "Wakeup via Bluetooth" in "7.Hardware Setup" - "Bluetooth" is set to "On".
- The power consumption in standby mode may be larger than the value above while the MHL (Mobile High-definition Link) enabled mobile device connected to the AUX Input HDMI/MHL jack is being charged.

■ **The sound changes when I connect my headphones**

- When a listening mode other than Direct or Mono is selected, connecting a headphone automatically selects Stereo.

■ **How do I change the language of a multiplex source**

- Select "Main" or "Sub" for "Multiplex Input Channel" in "3.Audio Adjust" - "Multiplex/Mono".

■ **The RI functions do not work**

- To use RI, you must make an RI connection and an analog audio (RCA) connection between the component and AV receiver, even if they are connected digitally.
- While Zone 2 is selected, the RI functions do not work.

■ **The functions System On/Auto Power On and Direct Change do not work for components connected via RI**

- These functions do not work when Zone 2 is turned on.

■ **When performing Automatic Speaker Setup, the measurement fails and the message "Ambient noise is too high." is displayed.**

- This can be caused by a malfunction in your speaker unit. Check if the unit produces normal sounds.

■ **The display is dark**

- Make sure that Dimmer function is not working. Press DIMMER button and change the brightness level of the display.

■ **The following settings can be made for the composite video inputs**

- While holding down the input selector button to configure, press Home once at a time until "Video ATT: On" appears on the display. To resume the setup, repeat the above described step until "Video ATT: Off" appears on the display.

This setting is possible for input selectors assigned with one of the video inputs "VIDEO 1" to "VIDEO 3" in "1.Input/Output Assign" - "Composite Video Input". If you have a game console connected to the composite video input, and the picture is not very clear, you can attenuate the gain.

Video ATT: Off: (Default).

Video ATT: On: (Gain is reduced by 2 dB.)

■ The picture on your TV/monitor connected to the HDMI output(s) is unstable

- Try turning the DeepColor function off.
To turn off the DeepColor function, press STB/DVR and \odot On/Standby on the AV receiver simultaneously. While holding down STB/DVR, press \odot On/Standby several times until "Deep Color: Off" appears on the display. To reactivate the DeepColor function, repeat the above described step until "Deep Color: On" appears on the display.

Radio Wave Caution

The AV receiver uses a 2.4 GHz radio wave frequency, which is a band used by other wireless systems as 1 and 2 described below.

1. Devices which use a 2.4 GHz radio wave frequency
 - Cordless phones
 - Cordless facsimiles
 - Microwave ovens
 - Wireless LAN devices (IEEE802.11b/g/n)
 - Wireless AV equipment
 - Wireless controllers for game systems
 - Microwave oven-based health aids
 - Video transmitter
 - Specific type of external monitor and LCD display
2. Less common devices which use a 2.4 GHz radio wave frequency
 - Anti-theft systems
 - Amateur radio stations (HAM)
 - Warehouse logistic management systems
 - Discrimination systems for train or emergency vehicles

If these devices and the AV receiver are used at the same time, the audio may be undesirably stopped or disturbed due to a radio wave interference.

Suggestions for improvement

- Switch off the devices which emit the radio wave.
- Place the interfering devices away from the AV receiver.
- The AV receiver uses radio wave, and a third person can receive the wave on purpose or accidentally. Do not use the communication for important or fatal matters.
- We assume no responsibility whatsoever for any error or damage of network environment or access device

resulting from the use of this apparatus.
Confirm with the provider or access device maker for more information.

Scope of Operation

Use of the AV receiver is limited to home use.
(Transmission distances may be reduced depending on communication environment.)

In the following locations, poor condition or inability to receive radio waves may cause the audio to be interrupted or stopped:

- In reinforced concrete buildings or steel framed or iron framed buildings.
- Near large metallic furniture.
- In a crowd of people or near a building or obstacle.
- In a location exposed to the magnetic field, static electricity or radio wave interference from radio communication equipment using the same frequency band (2.4 GHz) as the AV receiver, such as a 2.4 GHz wireless LAN device (IEEE802.11b/g/n) or microwave oven.
- If you live in a heavily populated residential area (apartment, townhouse, etc.) and if your neighbor's microwave oven is placed near your AV receiver, you may experience radio wave interference. If this occurs, move your AV receiver to a different place.
When the microwave oven is not in use, there will be no radio wave interference.

Radio Wave Reflections

The radio waves received by the AV receiver include the radio wave coming directly from the devices and waves coming from various directions due to reflections by walls, furniture and building (reflected waves). The reflected waves (due to obstacles and reflecting objects) further produce a variety of reflected waves as well as variation in reception condition depending on locations. If the audio cannot be received properly due to this phenomenon, try moving the location of the wireless LAN device a little. Also note that audio may be interrupted due to the reflected waves when a person crosses or approaches the space between the AV receiver and the wireless LAN device.

- We assume no responsibility whatsoever for any damages resulting from the use of this apparatus except in the cases deemed acceptable under the applicable laws and regulations.
- Operation in all environment is not guaranteed for wireless LAN. The communication may not be possible or have desirable communication speed.

Precautions

- Do not use this apparatus near an electronic device handling high-accuracy controls or weak signals. Doing so may cause an accident due to a malfunction of the device.
- Do not use this apparatus in use prohibited location such as an aircraft equipment or a hospital. Doing so may cause an accident due to a malfunction of an electronic device or an electro-medical apparatus. Follow the instructions of the medical facilities.

■ Electronic device which requires cautions

Hearing aid, pace maker, other medical electronic devices, fire alarm, automatic door, and other automatic control device.

When using a pace maker or other medical electronic devices, confirm with the medical electronic device maker or dealer for the effect of the radio wave.

The AV receiver contains a microPC for signal processing and control functions. In very rare situations, severe interference, noise from an external source, or static electricity may cause it to lockup. In the unlikely event that this happens, unplug the power cord from the wall outlet, wait at least 5 seconds, and then plug it back in.

Onkyo is not responsible for damages (such as CD rental fees) due to unsuccessful recordings caused by the unit's malfunction.

Before you record important data, make sure that the material will be recorded correctly.

Before disconnecting the power cord from the wall outlet, set the AV receiver to standby.

Regarding the Video Resolution

See below the video signal types and resolutions that the unit can output when it receives the input signals of the following types and resolutions. The supported resolutions are shown as "Input: Output".

(North American model)

■ HDMI: HDMI

4K: 4K (*1/*3)
 1080p/24: 4K, 1080p/24 (*1)
 2560×1080p: 4K (*2), 2560×1080p (*1)
 1680×720p: 4K (*2), 2560×1080p, 1680×720p (*1)
 1080p: 4K (*3), 2560×1080p, 1080p (*1)
 1080i: 4K (*3), 2560×1080p, 1680×720p, 1080p, 1080i (*1)
 720p: 4K (*3), 2560×1080p, 1680×720p, 1080p, 1080i, 720p (*1)
 480p: 4K (*3), 2560×1080p, 1680×720p, 1080p, 1080i, 720p, 480p (*1)
 480i: 4K (*3), 2560×1080p, 1680×720p, 1080p, 1080i, 720p, 480p, 480i (*1)

■ HDMI: Component

Can not be output.

■ HDMI: Composite

Can not be output.

■ Component: HDMI

480i: 4K (*3), 2560×1080p, 1680×720p, 1080p, 1080i, 720p, 480p, 480i (*1)

■ Component: Component

1080p: 1080p
 1080i: 1080i
 720p: 720p
 480p: 480p
 480i: 480i

■ Composite: HDMI

480i: 4K (*3), 2560×1080p, 1680×720p, 1080p, 1080i, 720p, 480p, 480i (*1)

■ Composite: Composite

480i: 480i

- *1 Resolution supported by HDMI OUT SUB jack
- *2 Supported resolution: [3840×2160 24/30/60 Hz]
- *3 Supported resolution: [3840×2160 24/30/60 Hz], [4096×2160 24/30/60 Hz]

- *1 Resolution supported by HDMI OUT SUB jack
- *2 Supported resolution: [3840×2160 24/25/30/50/60 Hz]
- *3 Supported resolution: [3840×2160 24/25/30/50/60 Hz], [4096×2160 24/25/30/50/60 Hz].

(Australian model)

■ HDMI: HDMI

4K: 4K (*1/*3)
 1080p/24: 4K, 1080p/24 (*1)
 2560×1080p: 4K (*2), 2560×1080p (*1)
 1680×720p: 4K (*2), 2560×1080p, 1680×720p (*1)
 1080p: 4K (*3), 2560×1080p, 1080p (*1)
 1080i: 4K (*3), 2560×1080p, 1680×720p, 1080p, 1080i (*1)
 720p: 4K (*3), 2560×1080p, 1680×720p, 1080p, 1080i, 720p (*1)
 576p: 4K (*3), 2560×1080p, 1680×720p, 1080p, 1080i, 720p, 480p/576p (*1)
 576i: 4K (*3), 2560×1080p, 1680×720p, 1080p, 1080i, 720p, 480p/576p, 480i/576i (*1)

■ HDMI: Component

Can not be output.

■ HDMI: Composite

Can not be output.

■ Component: HDMI

480i/576i: 4K (*3), 2560×1080p, 1680×720p, 1080p, 1080i, 720p, 480p/576p, 480i/576i (*1)

■ Component: Component

1080p: 1080p
 1080i: 1080i
 720p: 720p
 480p/576p: 480p/576p
 480i/576i: 480i/576i

■ Composite: HDMI

480i/576i: 4K (*3), 2560×1080p, 1680×720p, 1080p, 1080i, 720p, 480p/576p, 480i/576i (*1)

■ Composite: Composite

480i/576i: 480i/576i

Reference Information

Linked Operation with CEC-compatible Components

The AV receiver is compatible with the following components (as of January 2014).

TV (Random order):

- Toshiba TV sets
- Sharp TV sets

Players/Recorders (Random order):

- Onkyo and Integra RIHD-compatible players
- Toshiba players and recorders
- Sharp players and recorders (only when used together with Sharp TV sets)

Models other than those mentioned above may have some interoperability if compatible with CEC, which is part of the HDMI Standard, but operation cannot be guaranteed.

Note: For RI functions to work properly, do not connect more RIHD-compatible components than the quantities specified below, to the HDMI jack. RI functions are not guaranteed when more RIHD-compatible components than the below mentioned quantities are connected. Furthermore, do not connect the AV receiver to another AV receiver/AV amplifier via HDMI.

- Blu-ray Disc/DVD players: up to 3.
- Blu-ray Disc/DVD recorders: up to 3.
- Cable TV tuner, terrestrial digital tuner, and satellite broadcasting tuner: up to 4 units.

Checking whether the HDMI Linked Operation Settings Are Enabled

1. Turn on the power of all connected components.
2. Turn off the power of the TV, and confirm that the power of the connected components is turned off automatically with the link operation.
3. Turn on the power of the Blu-ray Disc/DVD player/recorder.
4. Start playback on the Blu-ray Disc/DVD player/recorder, and verify the following:
 - The AV receiver automatically turns on, and selects the input to which the Blu-ray Disc/DVD player/recorder is connected.
 - The TV automatically turns on, and selects the input to which the AV receiver is connected.
5. Following the operating instructions of the TV, select "Use the TV speakers" from the menu screen of the TV, and confirm that the audio is output from the speakers of the TV, and not from the speakers connected to the AV receiver.
6. Select "Use the speakers connected from the AV receiver" from the menu screen of the TV, and confirm that the audio is output from the speakers connected to the AV receiver, and not from the TV speakers.

Note:

- Even if you set to output audio on the TV speakers, audio will be output from the speakers connected to the AV receiver when you adjust the volume or switch the input on the AV receiver. To output audio from the TV speakers, redo the corresponding operations on the TV.
- In case of an RIHD connection with RI and RI audio control compatible components, do not connect the RI cable at the same time.
- On the TV, when you select anything other than the HDMI jack to which the AV receiver is connected, the input on the AV receiver will be switched to "TV/CD".
- The AV receiver will automatically power on in conjunction when it determines it to be necessary. Even if the AV receiver is connected to an RIHD compatible TV or player/recorder, it will not power on if it is not necessary. It may not power on in conjunction when the TV is set to output audio from the TV.

- Linked system functions with the AV receiver may not work depending on the component model connected. In such cases, operate the AV receiver directly.
- When the player/recorder cannot be operated with the remote controller of the AV receiver, the corresponding component may not be programmed to support the remote controller operation of CEC. Program the remote control code of the component maker to the remote controller for using.

About HDMI

HDMI (High Definition Multimedia Interface) is a digital interface standard for connecting TVs, projectors, Blu-ray Disc/DVD players, set-top boxes, and other video components. Until now, several separate video and audio cables have been required to connect AV components. With HDMI, a single cable can carry control signals and digital audio of digital video (2-channel PCM, multichannel digital audio, and multichannel PCM).

The HDMI video stream (i.e., video signal) is compatible with DVI (Digital Visual Interface) (*1), so TVs and displays with a DVI input can be connected by using an HDMI-to-DVI adapter cable. (This may not work with some TVs and displays, resulting in no picture.)

This unit supports HDCP (High-bandwidth Digital Content Protection) (*2), so it can display picture only on HDCP-compatible components.

HDMI of the unit supports the following functions.

Audio Return Channel, 3D, x.v.Color, DeepColor, Lip Sync, 4K (Passthrough), DTS-HD Master Audio, DTS-HD High Resolution Audio, Dolby TrueHD, Dolby Digital Plus, DSD and Multichannel PCM.

Audio Formats Supported by The Unit:

- 2-channel linear PCM (32 - 192 kHz, 16/20/24 bit)
- Multichannel linear PCM (up to 7.1 ch, 32 - 192 kHz, 16/20/24 bit)
- Bitstream (DSD, Dolby Digital, Dolby Digital Plus, Dolby TrueHD, DTS, DTS-HD High Resolution Audio, DTS-HD Master Audio)

Your Blu-ray Disc/DVD player must also support HDMI output of the above audio formats.

About Copyright Protection:

The unit supports Revision 1.4 and Revision 2.2 (HDMI OUT MAIN and HDMI IN3 only) of the HDCP (High-bandwidth Digital Content Protection) (*2), a copy-protection system for digital video signals. Other devices connected to the unit must also support HDCP.

- *1 DVI (Digital Visual Interface): The digital display interface standard set by the DDWG (*3) in 1999.
- *2 HDCP (High-bandwidth Digital Content Protection): The video encryption technology developed by Intel for HDMI/DVI. It is designed to protect video content and requires a HDCP-compatible HDMI/DVI receiver to display the encrypted video.
- *3 DDWG (Digital Display Working Group): Led by Intel, Compaq, Fujitsu, Hewlett Packard, IBM, NEC, and Silicon Image, this open industry group's objective is to address the industry's requirements for a digital connectivity specification for high-performance PC and digital displays.

Note:

- There are some content that can be played only with HDCP Rev. 2.2 compatible devices. To play such content, connect an HDCP Rev.2.2 compatible TV or player to the HDMI OUT MAIN jack or HDMI IN3 jack of the unit.
- The HDMI video stream (i.e., video signal) is compatible with DVI (Digital Visual Interface), so TVs and displays with a DVI input can be connected by using an HDMI-to-DVI adapter cable. (Note that DVI connections only carry video, so you will need to make a separate connection for audio.) However, reliable operation with such an adapter is not guaranteed. In addition, video signals from a PC are not supported.
- The HDMI audio signal (sampling rate, bit length, etc.) may be restricted by the connected source component. If the picture is poor or there is no sound from a component connected via HDMI, check its setup. Refer to the connected component's instruction manual for details.

Home network (LAN)

The connection of several components via cables enabling the mutual communication is called a network.

At households, many families create (generally, the term "build" is used) a network to connect PC and gaming machines to the Internet and to exchange data between PC.

The network established in a relatively narrow area such as one household is called a LAN (Local Area Network). In this manual, a term "home network" (network for a family) is used instead of "LAN," so this LAN becomes more familiar.

By connecting this unit with the network server such as a PC, playing music files in the network server (in the PC) is possible. Moreover, by connecting to the Internet, listening to the Internet radio is also possible.

This unit, PC, and Internet are not directly connected.

When connecting with a PC and/or Internet, several components (network components) are necessary.

Components necessary for establishing a home network (LAN):

Components necessary for the home network (LAN) for using the NET function of this unit are as follows.

■ Router

A router is a device that controls information (data) flow between the unit, PC, and the Internet.

As a network term, the flow of information (data) is called "traffic". The router has a role to control the information flow as the traffic control, between connected components.

- A router with a built-in 100Base-TX switch is recommended.
- In addition, if your router has the DHCP function, facilitating the network setting becomes possible.
- Some routers have a built-in modem, and some Internet Service Providers (ISP) require you to use specific routers.

Please consult your ISP or PC dealer if you are unsure.

■ CAT5 Ethernet cable

The Ethernet cable is a cable that actually connects components that comprise the network. There are straight type and cross type Ethernet cables.

- Use a shielded CAT5 Ethernet cable (straight-type) to connect the unit to your home network.

Consult your cable store for details of Ethernet cable.

■ Network server**(When PC etc./network server is used)**

Component that stores music files and provides the unit with those files at the time of playback.

- Requirements for use with this unit depend on the component that is used as a network server.
- Conditions for pleasant playback of music files on the unit depend on the using network server (PC performance). See instruction manuals of using components.

■ Modem (when Internet radio is used)

Device that connects home network (LAN) and Internet. There are many kinds of modems depending on the forms of Internet connection.

In addition, when connecting to the Internet, it is required to conclude an agreement with a company that provides Internet connection service, called ISP (Internet Service Provider).

Use a modem that is recommended by your ISP company for the Internet connection.

There are some devices that have both router and modem functions.

Within above network components, prepare a router, Ethernet cable, and network server when the NET function "network server" is used.

For enjoying the NET function "Internet radio," it is necessary to use the router, Ethernet cable, and modem (and agreement with ISP).

Server Requirements

■ Server playback

This unit can play digital music files stored on a PC or media server and supports the following technologies:

- Windows Media Player 11
- Windows Media Player 12
- DLNA-certified media server

The network server must be connected to the same network as this unit.

Up to 20,000 folders can be displayed, and folders may be nested up to 16 levels deep.

Note: Depending on the media server, the unit may not recognize it, or may not be able to play its music files.

■ Remote playback

Remote playback is the function that enables this unit to play music files saved in different components by operating the DLNA-compliant controller component and PC in the home network.

- Windows Media Player 12
- DLNA-certified (within DLNA Interoperability Guidelines version 1.5) media server or controller component.

* The setting varies depending on the media server or controller components. Refer to your components' instruction manual for details.

If the operating system of your personal PC is Windows 8/Windows 7, Windows Media Player 12 is already installed. For more information, see the Microsoft web site.

USB Storage Device Requirements

- USB mass storage device class (but not always guaranteed).
- FAT16 or FAT32 file system format.
- If the USB storage device has been partitioned, each section will be treated as an independent device.
- Up to 20,000 folders can be displayed, and folders may be nested up to 16 levels deep.
- USB hubs and USB storage devices with hub functions are not supported. Do not connect these devices to the unit.

Note:

- If the media you connect is not supported, the message "No Storage" will be displayed.
- Sound files that are protected by copyright cannot be played.
- When the USB audio player and this unit are connected, the audio player screen and the screen of the unit may be different. In addition, control functions of the audio player (classifying and sorting music files and adding information, etc.) are not available on this unit.
- Do not connect a PC to the USB port of the unit. Inputting sound to the USB port of the unit from a PC is not possible.
- Media inserted to the USB card reader may not be available in this function.
- Some USB storage devices and its contents may require some time to be read.
- Depending on the USB storage device, proper reading of the contents and proper supply of the power supply may not be possible.
- Onkyo accepts no responsibility whatsoever for the loss or damage to data stored on a USB storage device when that device is used with this unit. We recommend that you back up your important music files beforehand.
- Performance of the hard disk that receive power from the USB port of the unit is not guaranteed.
- If you connect a USB hard disk drive to the USB port of the unit, we recommend that you use its AC adapter to power it.
- When an audio player that are operated with batteries is used, make sure that the batteries have enough remaining power.
- USB storage devices with security functions cannot be played.

Supported Audio Formats

- For server playback and playback from a USB storage device, this unit supports the following music file formats.
- Music files of the following formats that can be played depend on the network server. For example, when using Windows Media Player 12, not all music files in the PC can be played. The music files that can be played are the ones registered to the Windows Media Player 12 library.
- Variable bit-rate (VBR) files are supported. However, playback times may not be displayed correctly.
- This unit supports the gapless playback of the USB storage device in the following conditions. When WAV, FLAC and Apple Lossless files are continuously played back with the same format, sampling frequency, channels and quantization bit rate.
- Remote playback does not support the gapless playback.

Note:

- With remote playback, this unit does not support the following music file formats:
 - FLAC, Ogg Vorbis, DSD and Dolby TrueHD.

■ MP3 (.mp3 or .MP3)

- Supported formats: MPEG-1/MPEG-2 Audio Layer 3
- Supported sampling rates: 8 kHz, 11.025 kHz, 12 kHz, 16 kHz, 22.05 kHz, 24 kHz, 32 kHz, 44.1 kHz, 48 kHz
- Supported bitrates: Between 8 kbps and 320 kbps, and VBR

■ WMA (.wma or .WMA)

WMA stands for Windows Media Audio and is an audio compression technology developed by Microsoft Corporation. Audio can be encoded in WMA format by using Windows Media® Player.

- WMA files must have the copyright option turned off.
- Supported sampling rates: 8 kHz, 11.025 kHz, 16 kHz, 22.05 kHz, 32 kHz, 44.1 kHz, 48 kHz
- Supported bitrates: Between 5 kbps and 320 kbps, and VBR
- WMA Pro/Voice formats are not supported.

■ WMA Lossless (.wma or .WMA)

- Supported sampling rates: 44.1 kHz, 48 kHz, 88.2 kHz, 96 kHz
- Quantization bit: 16 bit, 24 bit

■ WAV (.wav or .WAV)

WAV files contain uncompressed PCM digital audio.

- Supported sampling rates: 8 kHz, 11.025 kHz, 12 kHz, 16 kHz, 22.05 kHz, 24 kHz, 32 kHz, 44.1 kHz, 48 kHz, 64 kHz, 88.2 kHz, 96 kHz, 176.4 kHz and 192 kHz
- Quantization bit: 8 bit, 16 bit, 24 bit
 - * For playback from a USB storage device, sampling rates of 176.4 kHz and 192 kHz are not supported.

■ AAC

(.aac/.m4a/.mp4/.3gp/.3g2/.AAC/.M4A/.MP4/.3GP or .3G2)

- Supported formats: MPEG-2/MPEG-4 Audio
- Supported sampling rates: 8 kHz, 11.025 kHz, 12 kHz, 16 kHz, 22.05 kHz, 24 kHz, 32 kHz, 44.1 kHz, 48 kHz, 64 kHz, 88.2 kHz, 96 kHz
- Supported bitrates: Between 8 kbps and 320 kbps, and VBR

■ FLAC (.flac or .FLAC)

FLAC is a file format for lossless audio data compression.

- Supported sampling rates: 8 kHz, 11.025 kHz, 12 kHz, 16 kHz, 22.05 kHz, 24 kHz, 32 kHz, 44.1 kHz, 48 kHz, 64 kHz, 88.2 kHz, 96 kHz, 176.4 kHz, 192 kHz
- Quantization bit: 8 bit, 16 bit, 24 bit
 - * For playback from a USB storage device, sampling rates of 176.4 kHz and 192 kHz are not supported.

■ Ogg Vorbis (.ogg or .OGG)

- Supported sampling rates: 8 kHz, 11.025 kHz, 16 kHz, 22.05 kHz, 32 kHz, 44.1 kHz, 48 kHz
- Supported bitrates: Between 32 kbps and 500 kbps, and VBR
- Incompatible files cannot be played.

■ LPCM (Linear PCM)

- Supported sampling rates: 44.1 kHz, 48 kHz
- Quantization bit: 16 bit
 - * Only for playback via DLNA.

■ Apple Lossless (.m4a/.mp4/.M4A/.MP4)

- Supported sampling rates: 8 kHz, 11.025 kHz, 12 kHz, 16 kHz, 22.05 kHz, 24 kHz, 32 kHz, 44.1 kHz, 48 kHz, 64 kHz, 88.2 kHz, 96 kHz
- Quantization bit: 16 bit, 24 bit

■ DSD (.dsf or .DSF)

- Supported sampling rates: 2.8224 MHz, 5.6448 MHz
 - * For playback from a USB storage device, sampling rates of 5.6448 MHz is not supported.

■ Dolby TrueHD (.vr/.mlp/.VR/.MLP)

- Supported sampling rates: 48 kHz, 64 kHz, 88.2 kHz, 96 kHz, 176.4 kHz, 192 kHz
 - * For playback from a USB storage device, only sampling rates of 48 kHz is supported.

Remote Control Code List

■ Television (A to E)

A.R. Systems	10037, 10556
Accent	10037
Acoustic Solutions	11667, 11585, 11037
Action	10650
Addison	10653, 11150
AEG	11037
Aiko	10037
Aim	10037
Akai	10037, 12676, 10208, 10714, 10556, 12414, 13183, 10178
Akiba	10037
Akito	10037
Akura	10037, 10714, 11667, 11585, 10171, 11037
Alba	11037, 12676, 10037, 10714, 11585
Alien	11037
Allstar	10037
Amstrad	10037, 10171, 11037
Anam	10037, 10650
Andersson	11585, 12676
Anitech	10037
Ansonic	10037
AOC	11365, 12769, 10178, 10625, 11150
Apex Digital	12397
Ardem	10714, 10037
Arena	10037
Ario	12397
Aristona	10556, 10037
ART	11037
Art Mito	11585

Asberg	10037
Astra	10037
ATD	10698
Atlantic	10037
Audiosonic	10714, 10037
Audioworld	10698
Autovox	12676
Aventura	10171
Axxon	10714
Baird	10208
Barco	10556
Base	10698
Basic Line	10037, 11037, 10556
Baur	10037, 10195
Beaumark	10178
Beijing	10208
Beko	10714, 10037
Bell & Howell	10017
Belson	10698
Belstar	11037
Beon	10037
Berthen	10556
Bestar	10037
Bexa	12493
BGH	12414
Black Diamond	11037
Blaupunkt	10195
Blue Sky	10714, 10037, 11037, 10556, 10625
BPL	10208, 10037
Brandt	10625, 11585, 10714
Brinkmann	10037
Briovega	10037
Britania	12414
Bush	11037, 10037, 10714, 12676, 11667, 10208, 10556, 10698, 11585

Byd:sign	12209
Camper	10037
Carad	11037
Carena	10037
Carrefour	10037
Cascade	10037
Casio	10037
Cathay	10037
CCE	13782, 10037
Celcus	12676, 11585
Celebrity	10000
Centrum	11037
Centurion	10037
Changhong	13434, 12769, 10508
Chimei	12769
Chun Yun	10000, 11150
Chung Hsin	11150
Clarivox	10037
Clatronic	10037, 10714
Clayton	11037
Coby	13478
Commercial Solutions	11447
Condor	10037
Conrowa	10698
Contec	10037
Cosmel	10037
CPTEC	10625
Crown	10037, 10714, 10208, 11037
Crypton	11667
Curtis	12397
Cyberpix	11667
D-Vision	10037, 10556
Daewoo	10037, 10556, 10178, 11150
Dansai	10037, 10208
Dantax	11037, 10714, 12676
Datsura	10208
Dawa	10037

Daytron	10037
De Graaf	10208
Decca	10037
Denver	10037
Desmet	10037
Diamant	10037
Diamond	10698
Digatron	10037
Digihome	11667, 12676
Digiline	10037
Digisonic	11826
Digitor	10698, 10037
Dixi	10037
Drean	10037
DSE	10698
Dual	11667, 10037, 11037, 11585, 12676, 10714
Dumont	10017
Durabrand	10171, 10178, 10714, 11037
Dux	10037
DX Antenna	13817
Dynatron	10037
Dynex	12049
E.S.C.	10037
ECE	10037
Elbe	10037, 10556
Electroband	10000
Electrograph	11755
Elektra	10017
Elfunk	11037
ELG	10037
Elin	10037
Elite	10037
Emerson	11864, 10171, 11394, 10178, 10037, 10714
Envision	11365, 11506
Epson	11379
Erres	10037

ESA	10171
Euroman	10037
Europa	10037
Europhon	10037
Evesham Technology	11667
Excello	11037
Exquisit	10037

■ Television (F to J)

F&U	12676
FairTec	11585
Ferguson	10625, 11037, 10037, 10195, 11585, 12676
Fidelity	10037, 10171
Finlandia	10208
Finlux	11667, 10714, 12676, 10037, 10556
Firstline	10714, 10037, 11037, 10208, 10556
Fisher	10208
Flint	10037
Formenti	10037
Fraba	10037
Freesat	11636
Friac	10037
Frigidaire	11826
Fujitsu	10809
Fujitsu Siemens	10809
Funai	13817, 10171, 11394, 11037, 10714
Gaba	11037
Galaxi	10037
Galaxis	10037
Gateway	11755
GE	11447, 10178, 10625, 11454
GEC	10037

Genesis	10037
Genexxa	10037
GFM	10171, 11864
Gibraltar	10017
Gibson	11826
Gintai	11150
Godrej	11585
GoGen	12676
GoldStar	10178, 10037, 10714, 11150
Goodmans	10037, 11037, 11667, 10714, 11585, 10556, 10625, 12676
Gorenje	11585, 12676
Gradiente	10037
Graetz	10714
Granada	10208, 10037
Grandin	10037, 10714, 11037, 10556
Grundig	10195, 11223, 10556, 10037, 11667, 12676
H-Buster	13620
Haier	13620, 10698, 10037, 10508
Hallmark	10178
Hankook	10178
Hannspree	11826
Hanseatic	10037, 10714, 10625, 10556
Hantarex	10037
Hantor	10037
Harwood	10037
Hauppauge	10037
HB	10714
HCM	10037
Heran	11826
Herosonic	11826
Highline	10037
Hinari	10037, 10208
HiPlus	11826

Hisawa	10714
Hisense	10556, 10508, 10208
Hitachi	11643, 12676, 11576, 11585, 11691, 11037, 11667, 10037, 10150, 10178, 10508, 11150, 12170
Hitachi Fujian	10150
Hitec	10698
Hoher	10714
Horniphon	10037
Hua Tun	11150
Hypson	10037, 10714, 10556, 11037
Hyundai	10698, 12676, 11037
Iberia	10037
ICE	10037
iLo	11394
Imperial	10037
Indiana	10037
Inno Hit	11037, 11585
Innova	10037
Insignia	12049, 10171
Integra	11807, 13100, 13500
Inteq	10017
Interbuy	10037
Interfunk	10037
Internal	10556
Intervision	10037
Irradio	10037
IRT	10698
Isis	12676
Isukai	10037
ITS	10037
ITT	12676, 10208
ITT Nokia	10208
ITV	10037

JCB	10000
Jinfeng	10208
Jinxing	10037, 10556, 10698
JMB	12676, 10556
Jubilee	10556
JVC	11774, 10653, 11601, 12271, 11428, 10508, 10650, 12676

■ Television (K to N)

Kaisui	10037
Karcher	10714
Kathrein	10556
Kendo	11037, 11585, 12676, 10037
Kennex	11037
Kioto	10556
Kiton	10037
KLL	10037
Kneissel	10037, 10556
Kolin	10150, 10037, 11150, 11755
Kolster	10037
Konka	10037, 10714
Konnig	10037
Korpel	10037
Kosmos	10037
Kunlun	10208
Kupperbusch	12676
L&S Electronic	10714
Lavis	11037
Leicon	10037
Lenco	10037, 11037
Leyco	10037

LG	11840, 11860, 11423, 12731, 12182, 12358, 12362, 10178, 12424, 10037, 10714, 10017, 10556, 10698
LiesenKotter	10037
Lifetec	10037, 11037, 10714
Linetech	12676
Linsar	12676, 11667, 11585
Local India Brand	10208
Local Malaysia Brand	10698
Lodos	11037
Loewe	10633
Logik	11037, 10698, 11585
Luma	11037
Lumatron	10037
Lumenio	10037
Lux May	10037
Luxor	11037, 12676, 10208
LXI	10178
Madison	10037
Magnavox	12372, 11454, 11506, 10171, 11365, 11755, 11867
Magnum	10714, 10037
Manesth	10037
Manhattan	10037, 11037
Marantz	10037, 10556
Mark	10037, 10714
Mastro	10698
Masuda	10037
Matsui	10037, 10195, 10208, 11037, 10714, 10556, 11667, 12676
Matsushita	10650

Maxent	11755
Maxess	12493
Meck	10698
Mediator	10037, 10556
Medion	10714, 10037, 11037, 12676, 11667, 10556, 10698, 11585
Megatron	10178
MEI	11037
Melectronic	10037, 10195, 10714
Memorex	10178, 10150, 11037
Mercury	10037
Mermaid	10037
Metronic	10625
Metz	11037, 10195
MGA	10150, 10178
Micromaxx	10037, 10714, 11037
Midland	10017
Mikomi	11585, 11667
Minato	10037
Minerva	10195
Ministry Of Sound	11667
Minoka	10037
Mitsubishi	10150, 11250, 12313, 10178, 10037, 10556, 11150, 11037, 11171
Moree	10037
Morgan's	10037
Moserbaer	11585
MTlogic	10714
Mudan	10208
Multitec	11037, 10037
Multitech	10037
Myryad	10556
NAD	10037, 10178
Naiko	10037

Nakimura	10037
National	10208, 10508
NEC	12461, 10178, 10508, 10653, 11150
Neckermann	10037, 10556
NEI	10037, 11037
Neoka	11826
Netsat	10037
NetTV	11755
Neufunk	10556, 10714, 10037
Nevir	12676
New Sonic	11826
New Tech	10037, 10556
Newave	10178, 11150
Nikkai	10037
Nikkei	10714
Nikko	10178
Nokia	10208
Norcent	11365
Nordmende	10195, 11585, 10037, 10714, 11667
Normerel	10037
Novatron	10037
Novita	11585
NPG	13434

■ Television (O to S)

Oceanic	10208
OK Line	11037
OK.	13434, 12676
Okano	10037
OKI	11667, 12676, 13434, 11585
Omni	10698
Onei	11667
Onida	10653, 12414
Onimax	10714
Onix	10698

Onkyo	11807, 13100, 13500
Onn	11667
Opera	10037, 10714
Optimus	10650
Orava	11037
Orbit	10037
Orion	10037, 10556, 10714, 11037, 12676
Orline	10037
Ormond	11037
Osaki	10037, 10556
Osio	10037
Osume	10037
Otto Versand	10037, 10556, 10195
Pacific	10714, 11037, 10556
Palladium	10037, 10714, 10556
Palsonic	12461, 10698, 10037
Panama	10037
Panasonic	11636, 11291, 11480, 11650, 10650, 13825, 12170, 10037, 10208, 10508
Panavideo	13825
Panavision	10037
Panda	10208, 10508, 10698
Penney	10178
Perdio	10037
Perfekt	10037
Philco	13426, 12414, 10037, 10178

Philips	10037, 12800, 10556, 11887, 11867, 11506, 12372, 12680, 11454, 10171, 11365, 10017, 10000, 10178, 11394
Phocus	10714
Phoenix	10037
Phonola	10037, 10556
Pioneer	11457, 10037, 10698, 11636, 12171
PJ	11506
Plantron	10037
Playsonic	10714, 10037
Polaroid	12676, 11826
Powerpoint	10037, 10698
Prima	12461
Prinston	11037
Pro Vision	10037, 10556, 10714
Profitronic	10037
Proline	10625, 10037, 11037, 12676
Proscan	11447
Prosonic	10714, 12676, 10037, 11585, 11667
Protech	10037, 11037
Proton	10178
Pulsar	10017
Pye	10037, 10556
Qingdao	10208
Quadro	11667
Quasar	11291, 10650
Quelle	10037, 11037, 10195
R-Line	10037
Radiola	10037, 10556
Radiomarelli	10037

RadioShack	10037, 10178
Radiotone	10037, 11037
RCA	11447, 12746, 10625, 12434, 12932, 12187, 10000, 10178, 10618, 11454, 13426
Realistic	10178
Recor	10037
Rectiligne	10037
Red Star	10037
Reflex	10037, 11037
Relisys	11585
Relon	11826
Remotec	10037, 10171
Reoc	10714
Revox	10037
RFT	10037
Roadstar	11037, 10037, 10714
Rowa	10698, 10037
Runco	10017
Saba	10625, 10714, 12676
Sagem	10618
Saivod	11037, 10037
Salora	10208
Sampo	11755, 10171, 10178, 10650
Samsung	12051, 11632, 10618, 10037, 10556, 10178, 10208, 11150
Sansui	10037, 10714
Sanyo	10208, 11142, 11585, 12676, 12461, 11974, 12769, 10508, 11037, 11150, 11365, 11667
SBR	10037, 10556

Schaub Lorenz	10714, 12676, 11667
Schneider	10037, 10556, 10714, 11037, 11585, 12676
Schontech	11037
Scotch	10178
Scott	10178
Sears	10171, 10178
Seelver	11037
SEG	11037, 10037, 13434
SEI	10037
Sei-Sinudyne	10037
Semp Toshiba	13793
Sencor	10714
Senzu	12493
Serie Dorada	10178
Shanghai	10208
Sharp	11659, 12360, 10818, 11393, 12676, 10650, 11165, 11423
Sheng Chia	11150
Shintoshi	10037
Shivaki	10178, 10037
Siam	10037
Siemens	10195, 10037
Siera	10556, 10037
Silva	10037
Silva Schneider	10037
SilverCrest	12676, 11037
Sinudyne	10037
SKY	10037
Skyworth	12769, 10037, 10698
Solavox	10037
Soniko	10037
Soniq	12493
Sonitron	10208
Sonneclair	10037
Sonoko	10037

Sonorol	10208
Sontec	10037
Sony	12778, 11825, 10810, 10000, 11651, 11505, 11167
Soundesign	10178
Soundwave	10037, 11037
Sowa	10178, 11150
Soyea	10698
Soyo	11826
Squareview	10171
SR Standard	10037, 11037
Starlite	10037
STI	13793
Strato	10037
Sunny	10037
Sunstar	10037
Sunstech	12676
Sunwood	10037
Supersonic	10208
SuperTech	10037, 10556
Supra	10178
Supreme	10000
Svasa	10208
Sylvania	10171, 11864, 11394
Symphonic	10171, 11394
Synco	11755, 10000, 10178, 11826
Sysline	10037

■ Television (T to Z)

Tacico	10178, 11150
Tai Yi	11150
Talent	10178
Tashiko	10650, 11150
Tatung	10037, 11150
TCL	12434, 13183, 13426, 12414, 10698
TCM	10714
Teac	10037, 11037, 10698, 10714, 11755, 10171, 10178
Tec	10037
Tech Line	10037, 11585
Technica	11037
Technics	10556, 10650
Technika	11667, 12676
TechniSat	10556
Technisson	10714
Techno	11585
Technosonic	10556, 10625
Techwood	11667, 11037, 12676
Tecnimagen	10556
Teco	10178, 10653
Tedelex	10208
Teknika	10150
TELE System	11585
Telecor	10037
Telefunken	10625, 12676, 12414, 10698, 11585, 10037, 10714, 11667
Telefusion	10037
Telegazi	10037
Telemeister	10037
Telesonic	10037
Telestar	10037, 10556
Teletech	10037, 11037
Television	10037

Tennessee	10037
Tensai	10037, 11037
Terris	11667
Tesla	11037, 10037, 10556, 10714
Tevion	10714, 11037, 10037, 10556, 11585, 11667
Thomson	10625, 11447, 10037
Thorn	10037
TMK	10178
TNCi	10017
Tokai	10037, 11037
Tokaido	11037
Topline	11037
Toshiba	11508, 11524, 11656, 12676, 10508, 13570, 10650, 11037, 10195, 10618, 11150, 11169
TRANS-continentals	10037, 10556, 11037
Transonic	10037, 10698
Triad	10556
Triumph	10037, 10556
TVTEXT 95	10556
Uher	10037
Ultravox	10037
Unic Line	10037
Uniden	12122, 12676, 11667
United	10714, 11037, 10037, 10556
Universal	10037, 10714
Universum	10037, 11037, 10195, 10618
Univox	10037
V7 Videoseven	11755
Vestel	11037, 10037, 11585, 11667

Vexa	10037
Victor	11428, 10650, 10653
Videocon	10508, 10037
VideoSystem	10037
Vidtech	10178
Viewsonic	11755, 12049, 11365
Vision	11826, 10037
VIZIO	11758, 13758, 12209
Vortec	10037
Voxson	10037, 10178, 11667
VU	11365
Walker	12676, 11667, 11585
Waltham	10037, 11037
Wards	10017, 10000, 10178
Watson	11037, 10037, 10714
Wega	10037
Welltech	10714
Weltstar	11037
Westinghouse	11712, 11826, 11755, 12397
Westwood	11585
Wharfedale	11667, 10037, 10556
White Westinghouse	10037
Wilson	10556
Windsor	11037
Windy Sam	10556
Wintel	10714
Wyse	11365
Xiahua	10698
Xiron	11037
XLogic	10698
Xoceco	10037, 12461
Xrypton	10037
Yamaha	11576, 10650

Yamishi	10037
Yokan	10037
Yoko	10037
YU-MA-TU	10037
Zenith	10017, 10178, 11423, 12731, 11365, 12358, 12362
Zepto	11585
Zonda	10698

■ TV DVD Combination

Akai	12676, 32966
Alba	12676, 32966
Black Diamond	11037, 30713
Blue Sky	11037, 30713
Bush	12676, 10698, 11037, 30713, 32966
Centrum	11037, 30713
Crown	11037, 30713
Dual	11037, 30713
Dynex	12049
Elfunk	11037, 30713
Emerson	11864, 11394, 30675
Ferguson	11037, 30713
Funai	11394, 30675
Goodmans	11037, 12676, 30713, 32966
Grandin	30713
Grundig	30539
Hitachi	12676, 11037, 30713, 32966
Insignia	12049
JVC	12271, 11774
LG	11423
Linsar	12676, 32966
Logik	11037, 30713
Luxor	11037, 30713
Magnavox	12372

Matsui	11037, 12676, 30713
Medion	12676, 32966
Mitsubishi	34004
OK.	13434
OKI	12676, 32966
Orava	11037, 30713
Panasonic	12170
Philips	10556, 11454, 11394, 12372, 30539
Polaroid	12676, 32966
Powerpoint	10698
Prosonic	12676, 32966
RCA	12187, 12746, 12932, 11447
Samsung	12051
Sanyo	12676
SEG	11037, 30713
Sharp	10818, 12360, 12676, 32966
Soniq	12493
Sony	12778
Sylvania	11864, 11394, 10171, 30675, 30630
Teac	10698
Technica	11037, 30713
Telefunken	10698
Teletech	11037, 30713
Thomson	10625, 30551
Toshiba	11524, 12676, 32966
United	11037, 30713
Universum	30713
Vestel	11037
Viewsonic	12049
Weltstar	11037, 30713
Westinghouse	11712
Xiron	11037, 30713

■ DVD

3D LAB	30539
Accurian	30675
Acoustic Solutions	30730, 30713
AEG	30675, 30770, 31233
Aiwa	30533
Akai	32966, 31233, 30675, 30770
Akura	31233
Alba	32966, 30713, 30730, 30539
Amitech	30770
Amstrad	30713, 30770, 32139
AMW	30872
Ansonic	30831
Aristona	30539, 30646
ASDA	32213
Audix	30713
Autovox	30713
Awa	30730, 30872
Axion	30730
Basic Line	30713
Bel Canto Design	31571
Belson	32139
Best Buy	32139
Black Diamond	30713
Blu:sens	31233
Blue Parade	30571
Blue Sky	30713
Brainwave	30770
Brandt	30551, 30503
Bush	30713, 30730, 30831, 32966
Byd:sign	30872
CCE	30730
Celcus	32966
Centrum	30713, 30675
Changhong	30627
Cinea	30831

Cineral	30730
Cinetec	30713, 30872
Classic	30730
Clatronic	30675, 31233
Clayton	30713
Coby	30730
Codex	31233
Continental Edison	30831, 30872
Craig	30831
Crown	30713, 30770
Cybercom	30831
Daenyx	30872
Daewoo	30770, 30872
Dansai	30770
Dantax	30713, 30539, 32966
Datsun	31233
Daytek	30872
Dayton Audio	30872
DCE	30831
Decca	30770
Denon	31634, 32258, 32748, 30490, 33851
Dewo	31634
Digihome	30713, 32966
DigiLogic	30713
DiK	30831
Disney	30675, 30831
DK Digital	30831
Dragon	30831
DSE	30675
Dual	30831, 30713, 30730, 32966
Durabrand	30675, 30713, 30831
Dynex	32596
E:max	30770, 31233
ECC	30730
Elfunk	30713
Elin	30770

Elite	32854
Elta	30770, 31233
Eltax	31233
Emerson	30675, 32213
EuroLine	30675, 31233
Ferguson	30713, 32966
Finlux	32966, 30770, 30741
Firstline	30713
Funai	30675
G-Hanz	32213
G-HanzS	32213
GE	30522
GFM	30675
Go Video	31044, 30741
GoldStar	30741
Goodmans	30713, 30730, 32966
GPX	30741
Gran Prix	30831
Grandin	30713, 31233
Grundig	30539, 30551, 30713, 32966
Grunkel	30770, 30831
GVG	30770
H & B	30713, 31233
Hanseatic	30741
Harman/Kardon	30582
HE	30730
Hello Kitty	30831
Henss	30713
Hitachi	32966, 30573, 30713, 31664
Hoher	30713, 30831
Home Electronics	30730, 30770
Humax	30646
HYD	31233
Hyundai	32966
Inno Hit	30713
Insignia	32596, 30675, 30741

Integra	32147, 30627, 31769, 30503, 31612, 30571, 31634
Irradio	31233, 30646
ITT	31233
JDB	30730
JMB	32966
JVC	30623, 31602, 30503, 30539, 32966
Kansas Technologies	31233
Kendo	30713, 30831
Kennex	30713, 30770
Kenwood	30490
Kihiro	30770
Kupperbusch	32966
Leiker	30872
Lenco	30713, 30770
Lexicon	32545
LG	30741, 31602, 31233
Lifetec	30831
Linetech	32966
Linsar	32966
Lodos	30713
Loewe	30741, 30539
Logik	30713
Lumatron	30713, 30741
Lunatron	30741
Luxman	30573
Luxor	30713, 32966
Magnavox	30675, 30503, 30646, 30539, 31354, 30713
Manhattan	30713
Marantz	30539, 32414, 33444
Mark	30713
Marquant	30770
Matsui	30713, 32966
Maxim	30713, 30872

MBO	30730
MDS	30713
Mecotek	30770
Medion	30831, 32966, 30741, 30630
Memorex	30831, 32213
Metz	30713, 30571
Micromedia	30503, 30539
Micromega	30539
Microsoft	31708, 32083, 30522
Microstar	30831
Minax	30713
Minoka	30770
Mitsubishi	34004, 30713
Mizuda	30770
Mustek	30730
Mystral	30831
NAD	30741
Naiko	30770
NEC	30741, 31602
Nevir	30831, 30770
Nisato	31233
Noblex	31233
Norcent	30872
Nordmende	30831
OK.	32966
OKI	32966
Onkyo	30627, 32147, 31612, 31769, 30503, 30571, 31634
Oppo	32545, 30575
Orava	30713
Orbit	30872
Orion	30713, 31233
Ormond	30713
Pacific	30831, 30713
Packard Bell	30831
Palladium	30713

Panasonic	30490, 31579, 31641, 32710, 33641, 33862, 32523
Philco	30675
Philips	32056, 30539, 31354, 32789, 32434, 30646, 31340, 30503, 30675, 32084
Pioneer	31571, 30631, 30571, 32442, 32854, 30142
Polaroid	32966
Polk Audio	30539
Portland	30770
Powerpoint	30872
Presidian	30675
Prinz	30831
Prism	30831
Pro Vision	30730
Proline	32966
Proscan	30522
Proson	30713
Prosonic	32966
Pye	30539, 30646
Radionette	30741
Radiotone	30713
RCA	30522, 32213, 30571, 31769
REC	30490
Red	32213
Red Star	30770
Richmond	31233
Roadstar	30713, 30730
Ronin	30872
Rotel	30623
Rowa	30872
Saba	30551
Saivod	30831
Salora	30741

Samsung	30199, 30573, 33195, 31635, 32369, 32489, 32329, 30490, 31044
Sanyo	32966, 30713, 31233
ScanMagic	30730
Schaub Lorenz	30770
Schneider	30539, 30831, 30646, 30713
Schontech	30713
Scott	31233
SEG	30713, 30872
Semp	30503
Semp Toshiba	30503
Sharp	30630, 32250, 30713, 32966, 30675
Sherwood	30741, 30770
Shinsonic	30533
Sigmathek	32139
Silva Schneider	30831, 30741
Skantic	30713, 30539
Skymaster	30730
SM Electronic	30730
Smart	30713
Sonashi	30831
Soniq	30831
Sony	31633, 31516, 30533, 31033, 31070, 30864, 32861, 31536, 32180
Sound Color	31233
Soundwave	30713
Spectra	30872
SR Standard	30831
Strong	30713
Sunkai	30770
Sunstech	30831, 32139, 32966

Supratech	32139
Sylvania	30675, 30630
Symphonic	30675
Sytech	30831
Tandberg	30713
Targa	30741
Tascam	31818
Tatung	30770
TBoston	32139
Tchibo	30741
TCM	30741
Teac	30571, 30675, 30741, 31818, 32139, 34004
Technica	30713
Technics	30490
Technika	30770, 30831
Technosonic	30730
Techwood	30713, 32966
Telefunken	30551, 32966
Teletch	30713
Tensai	30770
Theta Digital	30571
Thomson	30551, 30522, 30831
Tokai	31233
Toshiba	30503, 32705, 32277, 31769, 33157, 32966, 32551
TRANS-continentals	30831, 30872, 31233
Tranasonic	30730
Trevi	30831
TVE	30713
United	30713, 30675, 30730, 31233
Universum	30713, 30741
Urban Concepts	30503
Venturer	31769
Vestel	30713
VIZIO	32563

Voxson	30831, 30730
Waitec	30730, 31233
Walker	32966
Waltham	30713
Welkin	30831
Wellington	30713
Weltstar	30713
Wharfedale	30713
Wilson	31233, 30831
Windsor	30713
Windy Sam	30573
Woxter	32139
X-View	31233
Xbox	31708, 32083, 30522
Xiron	30713
XMS	30770
Yamada	30872, 32139
Yamaha	30539, 30817, 30490, 32298, 31354, 30646
Yamakawa	30872
Yukai	30730
Zenith	30741, 30503

■ Blu-ray Disc

Denon	32258, 32748, 33851
Elite	32854
Funai	30675
Insignia	32596, 30675
Integra	32147, 32900, 32910, 33100, 33101, 33500, 33501
Lexicon	32545
LG	31602, 30741
Magnavox	30675
Marantz	32414, 33444
Mitsubishi	34004

Onkyo	32147, 32900, 33101, 33501, 32910, 33100, 33500
Oppo	32545
Panasonic	31641, 33641, 33862, 32523, 32710
Philips	32789, 32434, 32084
Pioneer	32442, 32854, 30142
Samsung	30199, 33195
Sharp	32250
Sony	31516, 32180
Sylvania	30675
Tascam	31818, 34004
Toshiba	32705, 33157, 32551
VIZIO	32563
Yamaha	32298

■ DVD-R

Accurian	30675
Aristona	30646
Denon	30490
Emerson	30675
Funai	30675
Go Video	30741
GPX	30741
Hitachi	31664
Humax	30646
Irradio	30646
LG	30741
Loewe	30741
Magnavox	30675, 30646
Medion	30741
Panasonic	30490, 31579, 32710, 32523
Philips	30646, 31340
Pioneer	30631

Pye	30646
RCA	30522
Samsung	31635, 30490, 32489
Schneider	30646
Sharp	30630, 30675
Sony	32861, 31070, 31516, 31033, 31536, 32180, 31633
Sylvania	30675
Targa	30741
Thomson	30551
Toshiba	32277, 32551
Yamaha	30646
Zenith	30741

■ VCR

DirecTV	20739
Humax	20739
Panasonic	20616
Philips	20739
RCN	20739
ReplayTV	20616
Sonic Blue	20616
Sony	20636
TiVo	20739, 20636

■ Cable Set Top Box (A to E)

3 Rivers Telephone Cooperative	01376
Accelplus	01376, 01877, 01982
Access Cable Television	01376, 01877, 01982
Access Communications	01376, 01877
Ace Communications	02586
ACTV Cablevision	01376, 01877, 01982
Adams Cable TV	01376

ADB	02586, 01920, 01481, 01998, 02437, 03028
Advanced Broadband	01376, 01877, 01982
Advanced Telemedia	01376, 01877, 01982
Airwave Networks	01376, 01982
Akado	02043
Alabama Broadband	01376
Alcom	02437
Algona Municipal Utilities	01376, 01877, 01982
All West Communications	01376
Alleghany Cablevision	01376, 01877, 01982
Allegiance Communications	01376
Alliance Communications	01376
Allied Telesis	01376, 01877, 01982
Almega Cable	01376, 01877, 01982
Alpine Cable	01376, 01877, 01982
Alta Utilities	01877
Alternative Cable	01376, 01877, 01982
Altibox	02437
Altitude Communications	01376
Americable International	01877
American Broadband	01376, 01877, 01982
American Entertainment Network	01376, 01877, 01982
American Telecasting	01376, 01877, 01982
Amherst Telephone	01376, 01877, 01982

Amino	01615, 01481, 01898, 01998, 03028
Anne Arundel Broadband	01376
Antietam Cable	01376, 01877, 01982
Arc One	01376, 01877, 01982
Arctic Cooperatives	01376, 01877, 01982
Argent Communications	01376, 01877, 01982
Arialink Broadband	01376, 01877, 01982
Arkwest	01481, 01998, 03028
Arledge Electronics	01376
Armstrong	01376, 01877
Arris	02187
Arvig Communication Systems	01376, 01982, 01998, 02345
Ashland Home Net	01376, 01877, 01982
Askivision Systems	01376, 01877, 01982
Astound Broadband	01376, 01877
AT&T	00858
ATC Communications	01376
Atlantic Broadband	01877, 01376
ATMC	01376, 01982, 01998, 03028
Atwood Cable	01376, 01877, 01982
Aurora Cable TV	01376, 01877, 01982
Ayrshire Communications	01376, 01877, 01982
B & C Cablevision	01376, 01877, 01982
B & L Technologies	01376, 01877, 01982
Bailey Cable TV	01376, 01877, 01982

Baja Broadband	01376
Baldwin County Internet	01376, 01877, 01982
Baldwin Telecom	01877
Ballard Rural Telephone Cooperative	02586
Barbourville Utility Commission	01376, 01877, 01982
Bardstown Cable	01376, 01877, 01982
Bascom Communications	01376, 01877, 01982
Base Cablevision	01376, 01877, 01982
Bay Cablevision	01376, 01877, 01982
Bay City Cablevision	01376, 01877, 01982
Bay Country Communications	01376, 01877, 01982
Bay Creek Communications	01376
Bayland Communications	02586
Bayou Cable	01376, 01877, 01982
Beamspeed	01376, 01877, 01982
Beaver Creek Telephone	01877, 01982
Beaver Valley Cable	01376, 01877, 01982
Beck's Cable Systems	01376, 01877, 01982
Bee Line Cable	01376
Beeline	03028
BELD Broadband	01376, 01877, 01982
Belgacom TV	02132
Belhaven Cable TV	01376, 01877, 01982
Bell	01998
Bell Aliant	01998
Bell Fibe TV	01998

Bellaire Cable	01376, 01877, 01982
Bellevue Cable	01376, 01877, 01982
Bend Broadband	01376, 02187
Bentleyville Cable	01376, 01877, 01982
Benton Cooperative Telephone	01376, 01877, 01982
Beresford Cablevision	01376, 01877, 01982
Berkshire Cable Corp	01376, 01877, 01982
Beulah Cable TV	01376, 01877, 01982
Bevcomm	01615, 01898
Beyond Communications	01376, 01877, 01982
Big Sandy Broadband	01376, 01877, 01982
Biltmore Communications	01877, 01982
Blakely Cable Television	01376, 01877, 01982
Bledsoe Telephone Cooperative	01481, 01998, 03028
Bloomingtondale Communications	01481, 01998, 03028
Blue Mountain TV Cable	01376, 01877, 01982
Blue Ridge Communications	01877
Blue Sky Cable	01376, 01877, 01982
Blue Valley Telecommunications	01898
Bobcaygeon Cable	01376, 01877, 01982
Booher Brothers Cable	01376, 01877, 01982
Bouygues Telecom	03007
Bowen Cablevision	01376, 01877, 01982
Boycom Cablevision	01376

Branch Cable	01376, 01877, 01982
Brandenburg Telecom	01481, 01998, 03028
Brandywine Cablevision	01376, 01877, 01982
Bresnan	01376, 01877
Briand et Moreau Cable	01376, 01877, 01982
Bright Green Communications	01376, 01877, 01982
Bright House	01877, 01376
Bristol Tennessee Essential Services	01877, 01998
Bristol Virginia Utilities	01376, 01877, 01982
British American	01376, 01877, 01982
Broadstar Communications	01376, 01877, 01982
Broadstripe	01376
Brockway Television	01376, 01877, 01982
Broken Bow Cable TV	01376, 01877, 01982
Brooks Bay Cable	01376, 01877, 01982
Brownwood TV Cable Service	01376, 01877, 01982
Bryan Municipal Utilities	01376, 01877, 01982
BT	02294
BTC Broadband	02586
Buckeye Cable System	01877, 01376, 02187
Bulldog Cable	01376, 01877, 01982
Bulloch Telephone Cooperative	01376, 01877, 01982
Burlington Telecom	01481, 01615
Butler Bremer Mutual Telephone	01898
Byron Cable TV	01376, 01877, 01982

C & W Cable	01376, 01877, 01982
C.L. Davis Cable Services	01376, 01877, 01982
Cable & Communications	01376
Cable America	01376, 01877
Cable Axiom Digitel	01376
Cable Communications of Willsboro	01376, 01877, 01982
Cable Cooperative	01376, 01877, 01982
Cable Development Corporation	01376, 01877, 01982
Cable Management Assocication	01376, 01877, 01982
Cable Montana	01376, 01877, 01982
Cable Nebraska	01376, 01877, 01982
Cable Of The Carolinas	01376, 01877, 01982
Cable One	01376, 01877
Cable Plus	01376, 01877, 01982
Cable Suite	01376
Cable Tech Cable TV	01376, 01877, 01982
Cable TV of Camrose	01376
Cable TV of East Alabama	01376, 01877, 01982
Cable TV of Slave Lake	01376, 01877, 01982
Cable TV of St. Paul	01376, 01877, 01982
Cable Vision Services	01877
Cablecom	01582
Cablecom Mexico	01376
Cablemas	01376, 01877
Cablenet	01376, 01877, 01982
CableSouth Media	01376, 01877, 01982

Cableview Communications	01376, 01877, 01982
Cablevision	01877, 01376
Cablevision du Nord	01376
Cablevision of Marion County	01376
Cablevision T.R.P.	01376, 01877, 01982
Cabovis	02436
Caiway	02015, 0660
CalNeva Broadband	01376, 01877, 01982
CalTel Connections	02586
Cameron Communications	01376, 01877, 01982
CAMS Cable	01376, 01877, 01982
Canby Telcom	01481
Cannon Valley Cablevision	01481, 01998, 03028
Caprock TV	01376, 01877, 01982
Carnegie Cable	01376, 01877, 01982
Carolina Mountain Cable	01376, 01877, 01982
Carr Communications	01376, 01877, 01982
Carrell Communications	01376, 01877, 01982
CAS Cable	01376
Cascade Communications	01376, 01877, 01982
Casey Cable	01376, 01877, 01982
Caspian Community TV	01376, 01877, 01982
Cass Cable	01376
Castle Cable Service	01376, 01877, 01982
Catalina Cable	01376, 01877, 01982
Catawba Services	01376, 01877, 01982

CBN	01376, 01877, 01982
CBPU Cable	01376, 01877, 01982
CCAP	01877
CDE Lightband	00858, 01615, 02586
Cedar Falls Utilities	01376
Celect Communications	01376, 01877, 01982
Cencom	01376, 01877, 01982
CentraCom Interactive	01376, 01877, 01982
Central Texas Communications	01376, 01877, 01982
Central Valley Cable	01376, 01877, 01982
Centre TV Cable	01376, 01877, 01982
Centrovision	01376, 01877, 01982
Century Communications	01376, 01877, 01982
Century Telephone	01376, 01877, 01982
CenturyLink	01998
CenturyTel TeleVideo	01376, 01877, 01982
Chambers Cable	01376
Champion Broadband	01376, 01877, 01982
Chaparral Cablevision	01376, 01877, 01982
Chariton Valley Communications	01376, 01877, 01982
Charter	01376, 01877, 02187
Chatmoss Cablevision	01376, 01877, 01982
Chequamegon Telephone Cooperative	01898, 01615
Chesnee Communications	01376, 01877, 01982

Chester Telephone	01376
Chinook Progressive Club TV	01376, 01877, 01982
Chippewa Valley Cable	01376, 01877, 01982
Choice Cable TV	01376, 01877, 01982
Choice Communications	01376, 01877, 01982
Choice Television	01376, 01877, 01982
ChoiceCable	01376
Christy Cablevision	01376, 01877, 01982
CimTel	01376
Cincinnati Bell	01877, 01376
Circle Bar Cable Television	01376, 01877, 01982
Cisco	01877, 01982, 00858, 02589, 03028, 02132, 02345, 01582, 01883, 02378, 02401, 03265
Citizens Cable	01376
Citizens Cable TV	01376
Citizens Cablevision	01481
Citizens Mutual Telephone	01376, 01877, 01982
Citizens Telecom	01376, 01877, 01982
Citizens Telephone	02586
City Cablevision	01376, 01877, 01982
City of Barnesville Cable	01376, 01877, 01982
City of Baxter Springs Cable	01376, 01877, 01982
City of Hawarden Cable	01376, 01877, 01982
City of Norway Cable	01376, 01877, 01982
City of Quitman Cable	01376, 01877, 01982

City Of Salisaw	01376
City of Sumas TV Cable System	01376, 01877, 01982
City West	01376
Citycable	03477
Clarence Telephone	01376, 01877, 01982
Claro	01376
Clear Creek Communications	01376
Clearview Cable	01376, 01877, 01982
Clearview Partners	01376, 01877, 01982
Clearview TV Cable	01376, 01877, 01982
Clearvision Cable TV	01376, 01877, 01982
Click Network	01376
ClickOne	01376, 01877, 01982
Clinton Cable	01376, 01877, 01982
CLT Communications	01376, 01877, 01982
ClubInternet	02132
CMA Communications	01376
CNS Television	01376, 01877, 01982
Coast Cable Communications	01376
Coast Cablevision	01376, 01877, 01982
Coast Communications	01376
Coastal Link	01376
Coaxial Cable TV	01376, 01877, 01982
Cobridge	01376
Cobridge Communications	01376
Cogeco	01376, 01877, 01982
Colane Cable TV	01376, 01877, 01982

Colfax Highline Cable	01376, 01877, 01982
Collinsville Cable	01376, 01877, 01982
Colonial Cablevision	01376, 01877, 01982
ColtonTel	02378
Columbia Power and Water	01376, 01877
Columbus Telephone	01376
Com Hem	00660, 02015
Com-Link	01376, 01877, 01982
Comcast	01376, 01982, 01877, 02187
Communication Services	01376, 01877, 01982
Communicomm	01376, 01877, 01982
Community Antenna Service	01376, 01877, 01982
Community Antenna System	01376, 01877, 01982
Community Cable & Broadband	01376
Community Cable Service	01376, 01877, 01982
Community Communications	01376, 01877, 01982
Community Telecom	01376, 01877, 01982
Community Television	01376, 01877
Compas Cable	01376, 01877, 01982
Complete Communication Services	01376, 01877, 01982
Comserv Ltd	01376, 01877, 01982
ComSouth	01376, 01877, 01982
ComSpan Communications	01481, 01898

Comstar Cable TV	01376, 01877, 01982
Consolidated Cable	01376, 01877, 01982
Consolidated Communications	01376
Conuma Cable Systems	01376, 01877, 01982
Conway Corporation Cable TV	01376, 01877, 01982
Conxxus	01376, 01877, 01982
Coon Creek Telephone	01376
Coon Rapids Municipal Utilities	01376, 01877, 01982
Coop CSCF	01376
Cooperative Television Godahl	01376, 01877, 01982
CoopTel	00858, 01615, 01898
Coosa Cable	01376
Copper Mountain Metropolitan	01376, 01877, 01982
Country Cable	01376, 01877, 01982
Country Cable TV	01376, 01877, 01982
Country Cablevision	01376
Country Cablevision Ltd.	01376
Cowley Telecable	01376, 01877, 01982
Cox	01877, 01376
Craig Cable TV	01376, 01877, 01982
Craw-Kan Telephone Cooperative	02586
Crestview Cable	01376, 01877, 01982
Cross Country TV	01376, 01877, 01982
Crosslake Communications	01376, 01877, 01982

Crow Cable TV	01376, 01877, 01982
CRRS-TV	01376
CRST Telephone Authority	01481, 01998, 03028
Crystal Cable TV	01376, 01877, 01982
CSI Cable	01376, 01877, 01982
CT & R Cable	01376, 01877, 01982
CTC	01376
Cunningham Telephone & Cable	01376
Curtis Cable TV	01376, 01877, 01982
CUTV	01376, 01877, 01982
CWA Cable	01376, 01877, 01982
D & D Cable Systems	01376, 01877, 01982
D & P Communications	01376
Daeryung	01877
Dairyland Cable Systems	01376, 01877, 01982
Dakota Central Telecommunications	02345
Dalton Cable Television	01877, 01982
Darty Box	02436
Davis Communications	01376, 01877, 01982
Dawson City Television	01376, 01877, 01982
DCA Cablevision	01376, 01877, 01982
DDD Cablevision	01376, 01877, 01982
Dean Hill Cable	01376, 01877, 01982
Dean's Cablevision	01376, 01877, 01982

Decca Cable	01376, 01877, 01982
Deffner Cable TV	01376, 01877, 01982
Delhi Telephone	01376, 01877, 01982
Delta	02015, 00660
Delta Cable	01376
Demopolis CATV	01376, 01877, 01982
Denali TV	01376, 01877, 01982
Dery Telecom	01376
Deutsche Telekom	02132
Dickey Rural Networks	01376, 01877, 01982
Digeo	02187
Diode Communications	01376, 01877, 01982
Diverse Communications	01898, 01982
Dixie Cable TV	01376, 01877, 01982
Dixon Telephone	01376, 01877, 01982
DMS Cable	01376, 01877, 01982
Downsville Community Antenna	01376, 01877, 01982
Doylestown Cable TV	01376, 01877, 01982
Drummond Cable TV	01376, 01877, 01982
DTC	01376, 01877, 01982
Du	02401
Dumont Telephone	01376, 01877, 01982
Duncan Cable TV	01376, 01877, 01982
Eagle Broadband	01481, 01998, 03028

Eagle Cablevision	01376, 01877, 01982
Eagle Communications	01376, 02187
Eagle Valley Telephone	01481, 01998, 03028
EagleVision Wireless TV Services	01376, 01877, 01982
East Arkansas Video	01376
East Cleveland Cable	01376, 01877, 01982
East Texas Cable	01376, 01877, 01982
Eastern Cable	01376, 01877, 01982
EastLink	01376
Easton Cable	01877
EasyTEL	01481, 01998, 03028
Eatel	01877
Echostar	03452
Electron Enterprises	01376, 01877, 01982
Elk River Cable TV	01376, 01877, 01982
Elkhart TV Cable	01376, 01877, 01982
Emery Telcom Video	01376, 01877, 01982
Emily Coop Telephone	01481, 01615
Enhanced Telecommunications	01376
EnTouch	01376
EPB of Chattanooga	00858
Escape Broadband	01376, 01877, 01982
Eston CATV Cooperative	01376, 01877, 01982
ETAN Industries	01376, 01877, 01982
Etex	02586
Execulink	01376
Eyecom	01376, 01877, 01982

■ Cable Set Top Box (F to J)

F & B Telephone	02586
FairPoint Communications	01376, 01877, 01982
Falls Earth Station	01376, 01877, 01982
FamilyView Cablevision	01376, 01877, 01982
Fannettsburg Cable TV	01376, 01877, 01982
Farmer & Merchant Mutual	01376, 01877, 01982
Farmer's Telephone Cooperative	01998, 03028
Farmers Independent Telephone	01376, 01877, 01982
Farmers Mutual Telephone	01376, 01877, 01982
Fayetteville Electric System	01877
Federated Telephone	01376
Fenton Cablevision	01376, 01877, 01982
FiberCast Cable Communications	01376, 01877, 01982
FiberNet Monticello	01376, 01877, 01982
Fibrant	01376, 01877, 01982
Fidelity Communications	01376
First Cable Of Missouri	01376, 01877, 01982
FirstMile	01376, 01877, 01982
Flint Cable TV	01376, 01877, 01982
Florida Cable	01376
Foothills Rural Telephone Cooperative	01877
Forsyth CableNet	01376, 01877, 01982

Fort Jennings Communications	02586
Fort Towson Cable	01376, 01877, 01982
Foster Communications	01376, 01877, 01982
Frank Howard TV Cable	01376, 01877, 01982
Frankfort Plant Board Cable	01376
Freebox	01976
FTC	01877, 01982, 01376
Full Channel TV	01376, 01877, 01982
Full Choice Communications	01376, 01877, 01982
Fusion Broadband	01376, 01877, 01982
Futuristic Cablevision	01376, 01877, 01982
Galaxy American Communication	01376, 01877, 01982
Galaxy Cable	01376, 01877, 01982
Gardonville Cooperative Telephone	01998
Gatehouse Networks	01376, 01877, 01982
Gauthier Cablevision & Electric	01376, 01877, 01982
GCI	01877
General Communications	01376
Genext	01376, 01877, 01982
Geraldine Cable TV	01376, 01877, 01982
Get Real Cable	01376, 01877, 01982
GEUS	01376, 01877, 01982
Giant Communications	01376, 01877, 01982

Giles-Craig Communications	01376, 01877, 01982
Gilmer Cable Television	01376, 01877, 01982
Glasgow Electric Plant Board	01376, 01877, 01982
Glass Antenna Systems	01376, 01877, 01982
Glenwood Telecommunications	01376
Glide Cablevision	01376, 01877, 01982
Globalcom	01376, 01877, 01982
Golden Belt Telephone	02586
Golden Communications	01376, 01877, 01982
Golden Rain Foundation	01376, 01877, 01982
Golden Valley Cable	01376, 01877, 01982
Golden West Telecommunications	01376, 01877, 01982
Goldfield Communications	01376, 01877, 01982
Gorham Communications	01481
Gowrie Cablevision	01376, 01877, 01982
Grafton Cable Communications	01376, 01877, 01982
Grand River Cable	01376, 01877, 01982
Grande Communications	01877, 01376
Great Plains Communications	01376
Green Hills Communications	01376, 01877, 01982
Greene County Cable TV	01376, 01877, 01982
Greenlight Community Broadband	01376, 01877, 01982

Gridley Cable	01376, 01877, 01982
Griswold Cooperative Telephone	01481, 01998, 03028
Grove Cable	01376, 01877, 01982
Grundy Center Utilities GTI	01376, 01877, 01481, 01998, 03028
Guadalupe Valley	01877
Haefele TV	01376, 01877, 01982
Haines Cable TV	01376, 01877, 01982
Hall Beach Cooperative	01376, 01877, 01982
Hamilton County Cable TV	01877, 01982, 01376
Hancel	01376, 01877, 01982
Hargray	01376, 01877, 01982
Harlan Community TV	01376
Harlan Municipal Utilities	01376
Harmony Cable TV	01376, 01877, 01982
Harris Broadband	01376
Harrisonville Telephone	02586
Harron Metrocast	01376, 01877
Hart Cable	01376, 01877, 01982
Hart Electric	01376, 01877, 01982
Hartelco	01376, 01877, 01982
Hastings Cable Vision	01376, 01877, 01982
Hathw@y	02043
Hawaiian Telcom	03028
HBC	01376, 01877, 01982

HBL Communications	01376, 01877, 01982
HCS	01376, 01877, 01982
Healthcare Cable Systems	01376, 01877, 01982
Heart of Iowa Communications	01376, 01877, 01982
Heartland Cable	01376, 01877, 01982
Heartland Wireless Communications	01376, 01877, 01982
Heck's TV & Cable	01376, 01877, 01982
Henderson Telephone	01376, 01877, 01982
Hermosa Cablevision	01376, 01877, 01982
Herr Cable	01376, 01877, 01982
HFU Television	01376, 01877, 01982
Hiawatha Broadband	01376, 01877, 01982
HickoryTech	01898
High Plains Cablevision	01376, 01877, 01982
Highland	01376, 01877, 01982
Hill Top Communications	01376, 01877, 01982
Hinton CATV	01376, 01877, 01982
HLM Cable Corp	01376, 01877, 01982
HomeTel	01376
Hometown Cable	01376, 01877, 01982
Hometown Utilicom	01376, 01877, 01982
Hood Canal Cablevision	01376
Hoonah Community Television	01376, 01877, 01982

Hooper Telephone	01376, 01877, 01982
Horizon Cable TV	01376, 02586
Horizon Telecom	02586
Horry Telephone Cooperative	01376, 01877, 01982
Hospers Telephone	01376, 01877, 01982
Hotwire	02586
Houston Cable	01376, 01877, 01982
Hrvatski Telekom	02132
HTC Communications	01481, 01998, 03028
HTC Services	01376, 01877, 01982
Humax	00660, 02620, 02043, 02165
HunTel Systems	01376
Huxley Communications	01376, 01877, 01982
Hydaburg Cable TV	01376, 01877, 01982
HYDE County Cablevision	01376, 01877, 01982
i-CAN	02437
I-Speed	01376, 01877, 01982
ICE Cable Holdings	01376
ICS Communications	01376, 01877, 01982
Illini Cablevision Of Illinois	01376, 01877, 01982
ImOn Communications	01877
Indco Cable TV	01376, 01877, 01982
Independence Telecom Utility	01376, 01982
Independent Cable Systems of Idaho	01376, 01877, 01982
Indeideo	01376, 01877, 01982
Index Cable TV	01376, 01877, 01982

Innovative Cable TV	01376
Innovative Systems	01898
Inotel	02437
Inside Connect Cable	01376
Insight	01376, 01877
Integra Telecom	02345
Inter Mountain Cable	01877
Inter-County Cable	01376, 01877, 01982
Interstate Cablevision	01481, 01998, 03028
Intertech Private Cable	01376, 01877, 01982
InviTV	02437
Iron River Cooperative TV	01376, 01877, 01982
Irvine Community TV	01376, 01877, 01982
ITV-3	01376, 01877, 01982, 03028
J & L Cable	01376, 01877, 01982
J & N Cable	01376, 01877, 01982
Jack McClanahan Cable TV	01376, 01877, 01982
Jackson Energy Authority	01376, 01877, 01982
Jaguar Communications	01376, 01877, 01982
James Cable Partners	01376, 01877, 01982
James Valley Cooperative Telephone	02586
Jayroc Cablevision	01376, 01877, 01982
Jefferson County Cable	01376, 01877, 01982
Jefferson Telecom	01376, 01877, 01982
Jeffersonville Cable TV	01376, 01877, 01982
Jet Broadband	01376

Johnston County Cable	01376, 01877, 01982
Journeyvision Cable	01376, 01877, 01982
JP PTT	01615

■ Cable Set Top Box (K to N)

K-Communications	01376, 01877, 01982
Kabel Deutschland	02165
Kalida Telephone	01376, 01877, 01982
Kalona Cooperative Telephone	02586
Kaplan Telephone	02586
Karban TV Systems	01376, 01877, 01982
KAS Cable TV	01376, 01877, 01982
Kaslo Cable	01376, 01877, 01982
KBS Cable TV	01376
Keene Valley Video	01376, 01877, 01982
Kelley Communications	01376, 01877, 01982
Kennebec Telephone	01376, 01877, 01982
Kennedy Cablevision	01376, 01877, 01982
Kentucky Ridge Country Communications	01376, 01877, 01982
Keta Cable	01376, 01877, 01982
KFW Communications	01376, 01877, 01982
Kincardine Cable TV	01376
Kings Bay Communications	01376, 01877, 01982
Kiss	02132
KLIP	01376, 01877, 01982

KM Telecom	01481
Knology	01877, 01376
KoolConnect	01481
Koomiut Cooperative	01376, 01877, 01982
KPN	02952, 02437
Kraus Electronic Systems	01376, 01877, 01982
Kudzu Cable TV	01376, 01877, 01982
Kugluktuk Cooperative	01376, 01877, 01982
Kuhn Communications	01376, 01877
L & J Cable	01376, 01877, 01982
La Harpe Communications	01376, 01877, 01982
La Harpe Video and Data Services	01376, 01877
Lafayette Utilities System	01376
Laguna Serrano Cable	01376, 01877, 01982
Lake Cable	01376, 01877, 01982
Lakeland Cablevision	01376, 01481, 01877, 01982, 01998
Lakeland Telecom	01481, 01998, 03028
Lakeview Cable	01376, 01877, 01982
Lamont Digital Systems	01376, 01877, 01982
Lang	01376, 01877, 01982
Laurel Highland	01376, 01877, 01982, 02187
LB Cable	01376, 01877, 01982
Lehigh Valley Cooperative Telephone	01376, 01877, 01982
Lemonweir Valley Telephone	01481, 01998, 03028

Lexcom Cable Services	01376, 01877, 01982
Liberty Cablevision	01376
Liberty Communications	01481, 02586
Limestone Cablevision	01376, 01877, 01982
Lincoln Cable Television	01376
Lincolntown	01376
Lindsey Communications	01376, 01877, 01982
LISCO	01376, 01877, 01982
Litestream Holdings	01376, 01877, 01982
LNE Telco	01376, 01877, 01982
Localtel	01376, 01877, 01982
Lockesburg Cablevision	01376, 01877
Lodgenet Entertainment	01376, 01877, 01982
Lone Pine Cable TV	01376, 01877, 01982
Longview Communications	01376, 01877, 01982
Lonsdale Video Ventures	01481, 01998, 03028
Loretel Cablevision	01376, 01877, 01982
Loretel Systems	01376
Lost Island Cable TV	01376, 01877, 01982
Lumos Networks	01998, 03028
Lycom Communications	01376, 01877, 01982
M-Tek Systems	01376, 01877, 01982
M.T.C. Cable	01376, 01877, 01982
Maddock Cable TV	01376, 01877, 01982

Madison Communications	01376, 01982
Madison County Cable	01376, 01877, 01982
Magio Sat	02132
Magnet	01615
Mahaska Communications	01376, 01877, 01982
Mainstreet Communications	01376, 01877, 01982
Maitland Cable TV	01376, 01877, 01982
Mallard Cable	01376, 01877, 01982
Manawa Telecom	02586
Manning Municipal Utilities	01376, 01877, 01982
Manti Telecom	01481, 01998, 03028
Marco Island Cable	01376, 01877, 01982
Markdale Cable TV	01376
Marne & Elk Horn Telephone	01376, 01877, 01982
Marquette-Adams Telephone	01376, 01877, 01982
Martelle Communications Cooperative	01376, 01877, 01982
Mascon Cable	01376
Masset-Haida TV Society	01376, 01877, 01982
Massillon Cable	01376
Matanuska Telephone Association	01481, 02586
Matrix Cablevision	01376, 01877, 01982
Mattawamkeag Cablevision	01376, 01877, 01982
McDonough Telephone Cooperative	01376, 01877, 01982
McKee TV Enterprises	01376, 01877, 01982

McNabb Cable	01376, 01877, 01982
MCV Broadband	01877
Media One	01376, 01877, 01982
Mediacom	01376, 01877, 01982
Mediapolis Telephone	01376, 01982
Mediastream	01376
Megacable	01376
Meo	02401
Merrimac Communications	01376, 01877, 01982
Metlakatla Indian Community TV	01376, 01877
MetroCast Cablevision	01376, 01982, 01877
MetroNet	01877, 0858
Metropolitan Cable	01376, 01877, 01982
MGS Cablevision	01376, 01877, 01982
MHTC	01481, 01998, 03028
Mi-Connection	01877
Microwave Satellite Technologies	01481, 01998, 03028
Mid Century Telecom	01481, 01615
Mid Missouri Broadband & Cable	01376, 01877, 01982
Mid Missouri Telephone	01376, 01877, 01982
Mid-Coast Cablevision	01376, 01877, 01982
Mid-Hudson Cable	01376
Mid-Rivers Communications	01376
Mid-South Cablevision	01376, 01877, 01982
Midamerican Cable Systems	01376, 01877, 01982
Midcontinent Communications	01376, 01877, 01982

Midstate Communications	01376, 01877, 01982
Midtel Cable TV	01376, 01877, 01982
Milcom Cable	01376, 01877, 01982
Milford Cable TV	01376, 01877, 01982
Milk River Cable Club	01376, 01877, 01982
Millennium Telecom	01481, 01998, 03028
Millheim TV Transmission	01376, 01877, 01982
Millington CATV	01376, 01877, 01982
Minburn Communications	01481, 01998, 03028
Minerva Valley Cable	01376, 01877, 01982
MINET	01877
MLGC Cable TV	01376, 01877, 01982
MM&G Enterprises	01481, 01998, 03028
MMDS Wireless East	01376, 01877, 01982
Mobius Communications	01376, 01877, 01982
Monroe Cablevision	01376, 01877, 01982
Monroe Utilities	01376, 01877, 01982
Montana Opticom	01376, 01877, 01982
Moosehead Enterprises	01376, 01877, 01982
Morris Broadband	01376
Morristown Utility Systems	01877
Mosaic Telecom	01376, 02586

Motorola	01376, 02437, 02378, 01998, 00858, 02952, 01562, 01982, 02401
Moultrie Telecommunications	01376, 01877, 01982
Mountain Shadows Cable TV	01376, 01877, 01982
Mountain Telecommunications	01376, 01877, 01982
Mountain Zone TV	01376, 01877, 01982
Movistar	03288
Moxi	02187
Mt. Baker Cable	01376, 01877, 01982
MTC	01376, 01877, 01982
MTC Technologies	01376, 01982
MTS	01998
Multiband Cable	01376, 01877, 01982
Municipality Cable Operator	01376, 01877, 01982
Murphy Cable	01376, 01877
Murray Electric System	01376, 01877, 01982
Muscatine Power & Water	01376
N.W. Communications	01376, 01877, 01982
National Cable	01376, 01877, 01982
Naujat Cooperative	01376, 01877, 01982
NDTC	01481, 01998, 03028
Nebraska Central Telecom	01376, 01877, 01982
NEIT	01376, 01877, 01982
Nelson County Cablevision	01376, 01877, 01982

Nelsonville TV Cable	01376, 01877, 01982
Nemont Communications	01376, 01877
NET	01883
New Century Communication	01376, 01877, 01982
New Day Broadband	01376, 01877, 01982
New England Cable	01376, 01877, 01982
New Jersey Broadband	01376, 01877, 01982
New Knoxville Cable Systems	01376, 01877, 01982
New North Networks	01376, 01877, 01982
New Paris Quality Cablevision	01376, 01877, 01982
New Visions Communications	01376, 01877, 01982
New Windsor Cable TV	01376, 01877, 01982
Newcastle Cablevision	01376, 01877, 01982
Newpath Communications	01877, 01982
NewWave Communications	01376, 02187
NexHorizon Communications	01376, 01877, 01982
Nexicom Communications	01376, 01877, 01982
Nextgen Communications	01376, 01877
Niagara Community TV Cooperative	01376, 01877, 01982
Nimpkish Valley Muncunations	01376, 01877, 01982
Nittany Media	01376
Nor-Cal Cable Systems	01376, 01877, 01982
Nortex Communications	01376, 01877, 01982

North American Communications	01376, 01877, 01982
North Central Telephone	02345
North Crossroads Communications	01376, 01877, 01982
North Dakota Telephone	02586
North Star Cablevision	01376, 01877, 01982
North State Communications	00858
North Texas Broadband	01376, 01877, 01982
North Yellowstone Cable TV	01376, 01877, 01982
Northern Cable Holdings	01376, 01877, 01982
Northern Lakes Cable TV	01376, 01877, 01982
Northland Communications	01376
Northside TV	01376, 01877, 01982
Northstar Broadband	01376, 01982
Northwest Communications	01376, 01877, 01982
Northwest Community	01877
Northwest Iowa Telephone	01877
Northwest Telephone Cooperative	01376, 01877, 01982
NorthwesTel	01376
Norvado	02586
Norwood Light Broadband	01376
Nova Cable Management	01376, 01877, 01982
Nova Cablevision	01376, 01877, 01982
Novus	01376, 01877
NPG Cable	01376
Nsight	02345, 02586

NTC Cable Services	01376, 01877, 01982
nTelos	01998
NTL	01060
NTS Communications	01376, 01877, 01982
NU Telecom	01998, 03028
NuLink	01877, 01376, 01982
Numericable	02436
Nushagak Cooperative	01376, 01877, 01982

■ Cable Set Top Box (O to S)

Oak Cable Systems Of Iowa	01376, 01877, 01982
Oak Hill Cablevision	01376, 01877, 01982
Oasis Communications	01376, 01877, 01982
Oi TV	03452, 03454
Omni III Cable TV	01376, 01877, 01982
Oneida Cablevision	01376, 01877, 01982
OneLink	01376, 01877, 01982
OneSource Communications	01376
Ono	01562
Open IPTV	01615
Opp Cablevision	01376, 01877, 01982
Optimum	01877
Optimus Clix	02437
Optus	01060
Orange	02407
Orbitel Communications	01376
Oregon Cable Group	01376, 01877, 01982
Orion Cablesystems	01376, 01877, 01982

OTEC Communications	02586
Our Cable	01376, 01877, 01982
Overton County Cable	01376, 01877, 01982
Oxford Networks	01376, 01877, 01982
Pace	01877, 01060, 02620, 01982, 01582, 01376, 01883, 02401, 03454
Packerland Broadband	01376
Paleajook Cooperative	01376, 01877, 01982
Palmer Mutual Telephone	01376, 01877, 01982
Palmetto Rural Telephone Cooperative	00858
Panasonic	01982
Pangnirtung Cooperative	01376, 01877, 01982
Panhandle Telephone	01376
Panora Telecommunications	01481
Paragould Light & Water	01376, 01877, 01982
Parish Communications	01376, 01877, 01982
Park Region Mutual Telephone	01481, 01998, 02345, 03028
Park TV & Electronics	01376, 01877, 01982
Partner Communications	01376, 01877, 01982
Pathway Com-Tel	01376, 01877, 01982
Patterson Cable TV	01376, 01877, 01982
Paul Bunyan Communications	02586
PBT Cable Services	01376, 01877, 01982

PC One Cable	01376, 01877, 01982
PDQ Cable TV	01376, 01877, 01982
PEC Cablevision	01376, 01877, 01982
Pegasus Communications	01376, 01877, 01982
Peoples CATV	01376, 01877, 01982
Persona Communications	01376, 01877, 01982
Philippi Communications	01376, 01877, 01982
Philips	01582, 02294
Phoenix	01376
Phoenix Cable	01376, 01877, 01982
Phonoscope Communications	01376, 01877, 01982
Pickwick Cablevision	01376, 01877, 01982
Piedmont Cable Services	01376, 01877, 01982
Pine Bluff Cable	01376
Pine Island Telephone	01481, 01998, 03028
Pine River Cable	01376, 01877, 01982
Pine Tree Cablevision	01376, 01877, 01982
Pineland Telephone Cooperative	01481, 01615, 01898, 02586
Pinpoint Communications	01376, 01877, 01982
Pioneer	01877
Pioneer Cable	01376, 01877, 01982
Pioneer Communications	01376, 01877, 01982
Pioneer Long Distance	01898, 01615
Pitcairn Community Cable TV	01376, 01877, 01982

Plantation Cable System	01376, 01877, 01982
Pleasant Vision	01376, 01877, 01982
Polar Communications	02586
Polaris Cable	01376, 01877, 01982
Ponderosa Cablevision	01376, 01877, 01982
Poplar Bluff Municipal Utilities	01481, 01998, 03028
Portal Cablevision	01376, 01877, 01982
Portugal Telecom	02401
Post Cablevision	01376, 01877, 01982
Premier Communications	01376
Premiere	02620
Price County Telephone	01481, 01998, 03028
Prime Cable Corporation	01376, 01877, 01982
Prime Time Cable	01376, 01877, 01982
Princetown Cable	01376, 01877, 01982
Private Cable Systems	01376, 01877, 01982
Private Network Cable Systems	01376, 01877, 01982
Project Mutual Telephone	01481, 01998, 03028
Project Services	01376, 01877, 01982
PSC	01481, 01998, 03028
PTCI	01376
PVT Networks	01376, 01877, 01982
Quality Cable TV	01376, 01877, 01982
Quality One Technologies	01481, 01998, 03028

Quinter Cable	01376, 01877, 01982
Qwerty.TV	01898
R & R Cable	01376
Raftview Communications	01376, 01877, 01982
Rainbow Cable	01376, 01877, 01982
Rainbow Communications	01376, 01877, 01982
Rainbow Lake Cable TV	01376, 01877, 01982
Rainier Connect	01376, 01877, 01982
Ramapo Cable	01376, 01877, 01982
Rancho Murieta Association	01376
Randolph Telephone	02586
Rapid Communications	01376, 01877, 01982
RC Communications	01376, 01877, 01982
RCN	01376
Reach Broadband	01376, 01877, 01982
Readlyn Telephone	02586
Rebeltec Communications	01376, 01877, 01982
Red River Cable	01376, 01877, 01982
Reds Cable TV	01376, 01877, 01982
Regional Cable TV	01376, 01877, 01982
Reinbeck Telecommunications	01376, 01877, 01982
Reservation Telephone	01376, 01998, 02345
Reserve Long Distance	01376, 01877, 01982
Resnet Communications	01376, 01877, 01982
Resort Cable	01376

Reveille Broadband	01376, 01877, 01982
Reynolds Cable	01376, 01877, 01982
RGA Cablle	01376, 01877, 01982
Ridgewood Cablevision	01376, 01877, 01982
Ringgold Telephone	01376, 01877, 01982
Rio Virgin Telephone	01376, 01877, 01982
Riondel Community Cable Society	01376, 01877, 01982
Ripley Video Cable	01376, 01877, 01982
Ritter Cable	01376, 01877, 01982
River Road Cable	01376, 01877, 01982
River Valley Cable TV	01376, 01877, 01982
River Valley Telecommunications	01481, 01998, 03028
Riverside Cablevision	01376, 01877, 01982
Riviera Cable TV	01376, 01877, 01982
Robins Cable TV	01376, 01877, 01982
Rock Port Cablevision	01376, 01877, 01982
Rocky Mountain Cable Systems	01376, 01877, 01982
Rogers	01877, 01376
Roome Telecommunications	01376, 01877, 01982
Royal Telephone	01376, 01877, 01982
RTC	01376, 01877, 01982
RTEC Communications	01376, 01877, 01982

Runestone Telcom	01376, 01877, 01982
Rural Route Video	01376, 01877, 01982
Rural Telephone Company	01376
RuralWest	01376, 01877, 01982
Russellville Electric Plant Board	02586
S & K TV Systems	01376, 01877, 01982
S & T Communications	01376, 01877, 01982
S-GO Video	01877, 01982
S.Bryer Cable TV	01376, 01877, 01982
Sagem	02407, 02436, 03288
Sagemcom	02407, 02436, 03007
Sallisaw Municipal Authority	01376, 01877, 01982
Samsung	02407, 02015, 01877, 03477, 01060, 01987, 02589, 03265
San Bruno Municipal Cable TV	01376, 01877, 01982
San Carlos Cablevision	01376, 01877, 01982
San Juan Cable	01376, 01877, 01982
San Simeon Community Cable	01376, 01877, 01982
Santel Comm Cooperative	01376, 01877, 01982
Sasktel	01998
Satellite Cable Services	01376, 01877, 01982
Satview Broadband	01376, 01877, 01982
Saugeen Telecable	01376, 01877, 01982

Savage Communications	01376, 01877, 01982
Sayward Valley Communications	01376, 01877, 01982
Schindler Cable TV	01376, 01877, 01982
SCI Cable	01376, 01877, 01982
Scientific Atlanta	01877, 01982, 00858, 01987, 02401, 02436, 02345, 03028
Scio Cablevision	01376, 01877, 01982
Scott Telecom And Electronics	01376, 01877, 01982
Scottsboro Cable TV	01376, 01877, 01982
Sea Island	01877
Seaside Cable TV	01376, 01877, 01982
Seaview Communications	01376, 01877, 01982
SecureVision	01376, 01877, 01982
Semo Communications	01376, 01877, 01982
Senior TV	01376, 01877, 01982
Service Electric	01376, 01877, 01982
Service One Cable	01376, 01877, 01982
Shannon Vision	01376, 01877, 01982
Shaw	01376, 01877, 02187
Shawano Municipal Utilities	01376, 01877, 01982
Shellsburg Cablevision	01376, 01877, 01982
Shen-Heights TV	01376, 01877, 01982

Shenandoah Cable	01376, 01877, 01982
Shenandoah Telecommunications	01376, 01877, 01982
Shentel	01376, 01877, 01982
Sherburne Cable	01376, 01877, 01982
Sherman Cablevision	01376, 01877, 01982
Shrewsbury Electric & Cable	01376, 01877
Silver Star Communications	01481, 01998, 03028
Simpson Country Cable TV	01376, 01877, 01982
SingTel	01998
Siskiyou Cablevision	01376, 01877, 01982
Sister Lakes Cable	01376, 01877, 01982
Sjoberg's Cable TV	01376
Skisat	01376, 01877, 01982
SKT	01376, 01877, 01982
SKY	02620
Sky Angel	01376, 01877, 01982
Sky Cablevision	01376, 01877, 01982
SKY Deutschland	02620
Skyline Cable	02586
SkyPix	01481, 01998, 03028
Sleepy Eye Telephone	02345
Small Town Cable	01376, 01877, 01982
Smile Content	02437
Smithville	02586
Sogetel	01998
Somerfield Cable TV	01376, 01877, 01982
Source Cable	01376

South Benton Cablevision	01376, 01877, 01982
South Central Communications	01376, 01877, 01982
South Holt Cablevision	01376, 01877, 01982
South Slope Communications	01376, 01877, 01982
Southeast Cable TV	01376, 01877, 01982
Southern Cayuga County Cable	01376, 01877, 01982
Southern Coastal Cable	01376, 01877, 01982
Southern Kansas Telephone	01376
Southern Plains Cable	01376, 01877, 01982
Southern Vermont Cable	01376, 01982
Southey Cable	01376, 01877, 01982
Southside TV	01376, 01877, 01982
Southwest MN Broadband	01376, 01877, 01982
Southwestern Bell Video Services	01376, 01877, 01982
Spanish Fork	01376, 01877, 01982
Spencer Municipal Utilities	01376, 01877, 01982
Spillway Cablevision	01376, 01877, 01982
Spirit Broadband	01376, 01877, 01982
Spring Creek Cable	01376, 01877, 01982
Springcom	01376, 01877, 01982
Springfield Cablevision	01376, 01877, 01982
Springville Cable	01376, 01877, 01982

St. George Island Cable	01376, 01877, 01982
St. John Cable	01376, 01877, 01982
Stanley Cablevision	01376, 01877, 01982
Stanton Telecom	01376, 01877, 01982
Star Cablevision	01376, 01877, 01982
Starkville Cablevision	01376, 01877, 01982
Starlight Communications	01376, 01877, 01982
Starview Cable of Delaware	01376, 01877, 01982
Starvision	01376, 01877, 01982
Starwest	01376, 01877, 01982
Stellar Communications	01376, 01877, 01982
Stellar Private Cable Systems	01376, 01877, 01982
Stofa	02015
Stowe Cablevision	01376, 01877, 01982
Strategic Technologies	01376, 01877, 01982
Stubbs Communications	01376, 01877, 01982
Suddenlink	01877, 01376
Summit Broadband	01376, 01877, 01982
Summit Communications	01376, 01877, 01982
Sumner Cable TV	01376, 01877, 01982
Sun Country Cable	01376
Sunrise Communications	01376, 01877, 01982
Supercanal	01376
Superior Cable & Data	01376, 01877, 01982

Supervision Cable TV	01376, 01877, 01982
SureWest	01481, 01998, 02586
Surry Telephone	02586
SWAT Cooperative	01481, 01998, 03028
Sweetwater Cable TV	01376, 01877, 01982
Swisher Telephone	02345

■ Cable Set Top Box (T to Z)

T-Home	02132
TA Communications	01376, 01877, 01982
Taloga Cable	01376, 01877, 01982
TAT Cablevision	01376, 01877, 01982
Tbaytel	03028
TCSI Huntsville	01376, 01877, 01982
TCT	01376, 01877, 01982
TDS	01376, 01877, 01982
TDS Telecom	03028
Technicolor	01982
Tekstar Cablevision	01376, 01877, 01982
Tel-Star Cablevision	01376, 01877, 01982
Tele-Media	01376, 01877, 01982
Tele-Services	01376, 01877, 01982
Tele2	00660
Telecentro	01376
Telecom Cable	01376, 01877, 01982
Teledistribution Amos	01376
Telefonica	03288, 03028
Telenet	01920, 03477

Telepak Networks	01376, 01877, 01982
TelePartners	01376, 01877, 01982
Telerent Leasing Corporation	01376, 01877, 01982
Telestar Systems	01376, 01877, 01982
Telewest	01987
Telmex	01376
Telsat Systems	01376, 01877, 01982
Telus	03028
Templeton Telephone	01376, 01877, 01982
TeNeT	01898
Tesco Cable TV	01376, 01877, 01982
Texas Mid-Gulf Cablevision	01376
Thames Valley Communications	01376, 01877, 01982
The Community Agency	01376
The Town of Mountain Village Cable	01376, 01877, 01982
Thomson	01582, 01982, 03007, 02407
Three River Digital Cable	01376, 01877, 01982
Throckmorton Cablevision	01376, 01877, 01982
TiftNet	01376, 01877, 01982
Time Warner	01877, 01376, 02187
Tip-Top Communications	01376, 01877, 01982
TiVo	03265
Tobacco Valley Communications	01376, 01877, 01982
Tongue River Cable TV	01376, 01877, 01982
Total Cable Service	01376

Touchet Valley Television	01376, 01877, 01982
TP	02407
Trans-Video	01376, 01877, 01982
Trappers Loop Communications	01376, 01877, 01982
Trenton Cable	01376, 01877, 01982
Tri-County Cable TV	01376
TrioTel Communications	01376, 01877, 01982
Troy Cablevision	01376
Trust Cable TV	01376, 01877, 01982
TruVista	01376, 01877, 01982
Tudjaat Cooperative	01376, 01877, 01982
Tulalip Broadband	01376, 01877, 01982
Tullahoma Utilities	02586
Tulugak Cooperative	01376, 01877, 01982
Turquoise Turtle TV	01376, 01877, 01982
TV Cable	01376
TV Cable Company of Andalusia	01376
TV Cable of Winamac	01376, 01877, 01982
TV Northeast	01481, 01998, 03028
TV Service	01376, 01877, 01982
TVB	01615
TVC	01376, 01877, 01982
TVision	01376, 01877, 01982
TVMAX	01376, 01877, 01982
TVS Cable	01376, 01877, 01982

Twin Valley Communications	02586
Two Creeks Cable	01376, 01877, 01982
Ucluelet Video	01376, 01877, 01982
Uintah Basin Electronic Telecom	01376, 01877, 01982
UMBC	01376, 01877, 01982
Union Telephone	01376, 01877, 01982
Unitah-Strata Networks	01376
United Communications Association	01376
United States Gypsum	01376, 01877, 01982
United Telephone	01376, 02586
Unitymedia	03477
Universal Cablevision	01376, 01877, 01982
Universal Satellite Cable	01376, 01877, 01982
UPC	01582, 03477, 00660, 01060
UPC Cablecom	01582, 03477
Upper Peninsula Communications	01376, 01877, 01982
US Online	01376, 01877, 01982
US Sonet	01376, 01877, 01982
USA Cablesystems	01376, 01877, 01982
USA Companies	01376, 01877, 01982
Utica Cablevision	01376, 01877, 01982
Utilities Board City of Foley	01376
Utility Systems Development	01376, 01877, 01982

Uwharrie Communications	02586
Valley Cable & Satellite Communications	01376, 01877, 01982
Valley Cable TV	01376, 01877, 01982
Valparaiso Communications	01376
Venture Communications Cooperative	01481, 01998, 03028
Venus Telephone Cooperative	01376, 01898
Veracity Communications	01376, 01877, 01982
Verizon	02378
Vernon Telephone Cooperative	02586
Vicksburg Video	01376
Videotron	01877
Vidia Communications	01376, 01877, 01982
Vidion Cable	01376, 01877, 01982
Viken Fibernett	02437
Viola Communications	01376, 01877, 01982
Virgin Media	01987, 01060, 03265
Vision Communications	01376
VisionComm	01376, 01877, 01982
Vital Communications	01376, 01877, 01982
Vivo	03288
Vodafone	02401
Vogtmann Engineering	01376, 01877, 01982
Volcano Vision	01376
W.D.B. Communications	01376, 01877, 01982
Wabash Independent Networks	01376, 01877, 01982

Wadsworth Cable TV	01376
Waitsfield Cable	01376
Walnut Communications	01376, 01982
Walnut Grove Cable TV	01376, 01877, 01982
Ward Communications	01376, 01877, 01982
Warwick Valley Telephone	01376, 01877, 01982
Washington County Rural Telephone Cooperative	01376, 01877, 01982
Watch TV	01481, 01998, 03028
Waterville Cable TV	01376, 01877, 01982
Watson Cable	01376, 01877, 01982
Wave Broadband	01376
Wavevision	01376, 01877, 01982
WCTA	01376, 01877, 01982
WEHCO Video	01376
Weiss Lake Cable	01376, 01877
West Alabama TV Cable	01376, 01877, 01982
West Carolina Telephone	03028
West Central Telephone	01376, 01877, 01982
West Lake Cablevision	01376, 01877, 01982
West River Cable Television	01376, 01877, 01982
WesTel Systems	01376, 01877, 01982
Western Broadband	01376, 01877, 01982
Western Cable Service	01376, 01877, 01982
Western Iowa Telephone	01877

Western Telephone Company	01376, 01877, 01982
Western Wisconsin Communications	01376, 02586
Westman Communications	01376, 02187
Westphalia Broadband	02586
Wetherell Satellite Cable TV	01376, 01877, 01982
WFL Cable Television	01376, 01877, 01982
White County Video	01376
WideOpenWest	01376, 01877, 02187
Wikstrom Systems	01376, 01877, 01982
Wilco Electronic Systems	01376, 01877, 01982
Wilkes Telecommunications	01481, 01998, 03028
Willamette Broadband	01376
Windbreak Cable TV	01376, 01877, 01982
Windjammer Cable	01376, 01877
Windom Communications	01877
Windstream	01376, 01982
Winslow Communications	01376, 01877, 01982
Wire Tele-View	01376, 01877, 01982
Wireless One	01376, 01877, 01982
Wittenberg Telephone	01376, 01877, 01982
Wood County Telephone	01376, 01877, 01982
Woodsfield Municipal Cable	01376, 01877, 01982
Worth Cable TV	01376, 01877, 01982
WT Services	01376, 01877, 01982

WTC Communications	01376, 01877, 01982
WTCl Cable	01376, 01877, 01982
Wyandotte Municipal	01376, 01982
Yadkin Valley Telecom	02345
Ycom Networks	01376, 01877, 01982
Yelcot Video Group	01376, 01877, 01982
Yelo	01376
Ygnition	01376, 01877, 01982
Zampelli Electronics	01376, 01877, 01982
Ziggo	02589, 02015, 00660, 02401
Zito Media	01376, 01982
Zoom Media	01376, 01877, 01982

■ Satellite Set top Box

@sat	01300
Acoustic Solutions	01284
ADB	00887
AEG	02738, 02813
Agora	01284
Airis	02813
Airtel	02248
Akira	02738
Alba	01284, 02034
Altech UEC	02059
Amstrad	00847, 01662, 01175, 01693, 02467
AMTC	02738, 02813
Arledge Electronics	00775
Arnion	01300
ASDA	01284
AssCom	00853
Astro	01100, 02026
Aurora	00879

Austar	00879
Auvisio	02738, 02813
Avanit	01631
Axil	02738
Ballard Rural Telephone Cooperative	00775
Bell	00775
Bell Satellite TV	00775
Biostek	02738
Black Diamond	01284
Boca	02026, 02813
Boshmann	01631
Boxer	02443, 01692
BskyB	01175, 00847, 01662
Bulltech	02738
Bush	02376, 01284, 02034, 02813
Cablecom	01195, 01197
Caiway	02443, 00253
Canal Digitaal	00853, 02957
Canal Digital	00853
Canal+	00853, 02657, 01195, 01197
CanalSat	00853, 02657
Century	00856
CGV	02034
Chess	02026
Signal	02835
City of Cawker City Cable	00775
CityCom	01176
Claro	03787, 03790
Clatronic	02738
Com Hem	01176, 01915
Comag	02026, 02813
Coship	03787, 03790
Country Vision Cable	00775, 00869
Croner	02813
Crown	01284
Cyfra+	00853, 01409

Cyfrowy Polsat	00253, 0853, 01409
D-box	01114
DASAN	03321
Delta	02443
Denver	02738
Deutsche Telekom	01195, 01197
Dgtec	01631
Dicra	02738
Digi	02026
Digiality	02813
Digihome	01284, 02034
DigiLogic	01284, 02034
DigiQuest	01300, 02738, 01631
DigitAlb	01195, 01197
DigitalBox	01631, 01100
Digiwave	01631
DirecTV	01377, 00099
Dish Network	00775
Dishpro	00775
DishTV	01300
DMT	03321
DMTech	02738
DRE	01176
Dream Multimedia	01237, 01652, 01923
DSE	02813
DSTV	00879
DTK Deutsche Telekom	01195, 01197
Dual	02034
Durabrand	01284, 02034
Dyon	02738, 02813
Echostar	00775, 00853, 01409
Edision	01631
Elta	02738
Energy Sistem	01631, 02813
Etisalat	02443
Evesham Technology	02034

Finlux	02034
FinnSat	01195, 01197
Fortec Star	01631
Foxtel	01356, 00879, 01176
Freesat	01692, 02376
Freesat+	02443
Frontier Communications	00775
Fuji Onkyo	01631
Galaxis	00853, 00879
General Instrument	00869
General Satellite	01176
Globo	02026, 02957
GoGen	02738
GOI	00775
Gold Box	00853
Gold Vision	01631
Goodmans	01284, 02376, 02034
Gradiente	00887, 00856, 00099
Grococ	01409
Grundig	00847, 02376, 02034, 01284, 00853, 00879
Hanseatic	01100
HD+	02443
HDT	03321
Hirschmann	02026
Hitachi	02034, 01284
Hornet	01300
HTS	00775
Huawei	03787
Hughes Network Systems	01377
Humax	01176, 02443, 01808, 01915, 02408, 01377, 03321, 01989, 02616
ibox	01652

ID Digital	01176
Illusion	01631
Imagin	01195, 01197
Imperial	01195, 01197
Indovision	01989, 00856, 00887
iNETBOX	01652, 01237
Innova	00099
IQ	02813
ISkyB	00887
JVC	00775, 01284
Kabel Deutschland	01195, 01197
KabelBW	01195, 01197, 01915
KabelNoord	00253, 02443
Kaon	01300
Kenwood	00853
Koenig	01631
KT	03321
Lava	01631
LG	03321
Linsar	01284
Lodos	01284
Logik	01284, 02034
LogiSat	02026, 02813
Luxor	02034
Macab	00853
Majestic	02738
Manhattan	01300
Maplin	02034
Marusys	03543
Mascom	02738
Matsui	01284
Maximum	02813
Mediabox	00853
MediaSat	00853
Mediascape	02835
Medion	02026
Mega TV	03321
MegaSat	02034, 02813, 01631, 02738

Metronic	02738, 01631
Micro	02813
Micro electronic	02813
Milestone Communications	00775
Mitsai	02738
Morgan's	02026
Motorola	00869, 00856, 03469
Movistar	01409
Multichoice	00879, 02059, 02060
Murphy	02034
Mysat	02738
NET	01409
Netsat	00099, 00887
Next Level	00869
Nokia	00853
NPG	01631
NTV Plus	01692, 02443
Olleh TV	03321
Olleh-Skylife	03321
Onn	02034, 01284
Opticum	02957
Optus	00879, 01356
Orbitech	01100, 01195, 01197
Orton	02957
Pace	00847, 01356, 00887, 01175, 01693, 00853, 01662, 02467, 02657, 03469, 01377, 02059, 02060, 02211, 03787, 03790, 02620
Pacific	01284
Palcom	01409
Palsonic	02813
Panasat	00879
Panasonic	00847

Philips	00099, 00853, 01114, 02619, 00856, 00887, 02211, 03469
Pioneer	00853
PLDT	02835
Premiere	01114, 01195, 01197
Primacom	01176, 01195, 01197
Pro Basic	00853
Proline	01284
Qook TV	03321
Qook-SkyLife	03321
Qwest	01377
RadioShack	00869
Raduga TV	02957
RiksTV	01692
Roadstar	00853
SAB	01300, 01631
Sagem	01692, 01114
Sagemcom	01692
Samsung	03063, 00253, 01377, 01989, 02467, 00853, 03321, 01662, 01693, 03834
Sat Control	01300
SAT+	01409
Satellite Operations	00775
Satplus	01100
SatyCon	01631
Schaub Lorenz	02034
Schwaiger	01631, 02813, 02957
Schwaiger CS	01631
Scott	02738
SEG	01284, 02034
Shark	01631
Sharp	02034
Shaw Direct	00869
Sherwood	01409

Shinelco	02738
Sigmathek	02738, 02813
SilverCrest	02026
SKY	00856, 00847, 01662, 00887, 01175, 02619, 01693, 00099, 01114, 01377, 01915, 02467, 03469
Sky Brasil	00856, 00887, 01377, 02619
SKY Deutschland	02443, 01114, 01915, 02620
SKY Italia	01693, 02467, 00853, 01356
SKY Mexico	00856, 02619, 00887, 01377, 03469
SKY New Zealand	02211
SKY PerfecTV!	02616
SkyCable	01631
SkyLife	03321
Skylink	02443, 02957
Skymaster	01409
Skyplus	02026, 01175
SkySat	01100
Skyworth	01631, 02835
SL	02026
SM Electronic	01409
Smart	01631
Sony	00847, 00853
Star	00887
Star Choice	00869
Stream System	01300
Strong	01409, 00879, 02813, 01300, 00853, 01284
Sunny	01300
Sunstech	02738
Supernova	00887
T-Mobile	02443

TATA Sky	03575
TDS Telecom	00775
Teac	02813
Technicolor	03469
Technika	01284, 02034
TechniSat	01195, 01197, 01100, 02813
Techwood	01284, 02034
tekComm	02738
TELE System	01409, 02738, 02813
Tele2	01195, 01197
Telefonica	01692, 01409
Telestar	01100, 01197, 01195
Televés	01300
Televiow Communications	00775
Televisa	00887
Telsey	02738
Telstra	01356
Telus	00775
Tevion	01409, 02026, 02813
Thomson	00847, 01175, 00853, 01662, 02619, 03469
TNT SAT	01692, 01195, 01197
Toshiba	01284
TrekStor	02738
Triangle Communication System	00775
Triax	00853, 01631
Tricolor TV	01176
True Visions	02408
TV Vlaanderen	00853
TVA Digital	01692, 01409
TVB	01989
UEC	00879, 01356

United Satellite America	00775
United States Wireless	00775
Unitymedia	01915
Unixbox	01652
USA Wireless Satellite TV	00775
Vectra	01195, 01197
Vestel	01284, 02034
Via Embratel	03787
Viasat	01197, 0253, 01195
VisionNet	01631
Viva	00856
Vivo	01409
Voom	00869
VTC	03834
Vu+	03543
Walker	02034, 01284
Wharfedale	02034
Windstream	00775
Wisi	02957
World Satellite Cable Systems	00775
Woxter	02813, 02738
Xoro	02813
Xtreme	01300
Yes	00887, 01631
Zehnder	02034, 03469
Zenith	00856, 00253
Ziggo	02443
Zircon	02957

■ Video - Accessory

A.C.Ryan	02709, 03350
ABS	01272
Acer	01272
Alienware	01272
Apple	02615
Boxee	03693
Claritas	01272

CyberPower	01272
D-Link	03693
Daily Media	01272
Dell	01272
Digitech	02260
Elonex	01272
Eminent	02260
Emtec	02709
Fantec	02709
Fujitsu Siemens	01272
Gateway	01272
Hewlett Packard	01272
hFX	01272
Howard Computers	01272
Hush	01272
iBUYPOWER	01272
iconBIT	02709, 03350
ISTAR	02260
Linksys	01272
Mede8er	02709
Media Center PC	01272
Microsoft	01272, 01805
Mind	01272
NiveusMedia	01272
Northgate	01272
Packard Bell	01272
Philips	01272
PopBox	02260
Popcorn Hour	02260
Ricavision	01272
Roku	03061
Sony	02713, 01272
Stack 9	01272
Systemax	01272
Tagar Systems	01272
Toshiba	01272
Touch	01272
Trust	01272
VIA Technologies	01272
Viewsonic	01272
Voodoo	01272

Western Digital	02558
Woxter	02709
Xbox	01805, 01272
ZT Group	01272

■ CD

Advantage	70032
AH!	70157
Aiwa	70157
Arcam	70157
Atoll Electronique	70157
Audio Research	70157
Audiolab	70157
Audiomeca	70157
Audioton	70157
AVI	70157
Balanced Audio Technology	70157
Cairn	70157
California Audio Labs	70029, 70303
Cambridge	70157
Cambridge Audio	70157
Carver	70157
CCE	70157
Cyrus	70157
Denon	70766
DKK	70000
DMX Electronics	70157
Dynaco	70157
Genexxa	70032, 70000
Goldmund	70157
Grundig	70157
Harman/Kardon	70157
Hitachi	70032
Integra	71817
JVC	70072
Kenwood	70157, 70036
Krell	70157
Linn	70157
Loewe	70157
Magnavox	70157

Marantz	70157, 70029
Matsui	70157
MCS	70029
Memorex	70032
Meridian	70157
Micromega	70157
Miro	70000
Mission	70157
Myryad	70157
NAD	70721, 70000
Naim	70157
NSM	70157
Onkyo	71817
Optimus	70032, 70000
Panasonic	70303, 70029
Philips	70157
Pioneer	70032
Polk Audio	70157
Primare	70157
Proton	70157
QED	70157
Quad	70157
Quasar	70029
Radiola	70157
RCA	70032
Restek	70157
Revox	70157
Rotel	70157
SAE	70157
Sansui	70157
SAST	70157
Siemens	70157
Silsonic	70036
Simaudio	70157
Sonic Frontiers	70157
Sony	70000, 70490
Sylvania	70157
TAG McLaren	70157
Tandy	70032
Tascam	73095, 73511, 73533

Teac	73531, 73532, 73551
Technics	70303, 70029
Thorens	70157
Thule Audio	70157
Universum	70157
Victor	70072
Wards	70032, 70000, 70157
Yamaha	70036, 70032, 70490
Zonda	70157

■ Cassette Deck

Aiwa	40029
Arcam	40076
Audiolab	40029, 40229
Carver	40029
Denon	40076
Grundig	40029
Harman/Kardon	40029
Inkel	40070
JVC	40244
Kenwood	40070
Magnavox	40029
Marantz	40029
Myryad	40029
Onkyo	42157
Optimus	40027
Panasonic	40229
Philips	40029, 40229
Pioneer	40027
Polk Audio	40029
Radiola	40029
RCA	40027
Revox	40029
Sansui	40029
Sony	40243, 40170
Tascam	73095
Technics	40229
Thorens	40029

Victor	40244
Wards	40027, 40029
Yamaha	40097

■ Audio - Accessory

Apple	81115
Jamo	82228
Onkyo	81993, 82351, 82990
Polk Audio	82228

■ Receiver

Integra	52503
Onkyo	52503

■ Cable PVR Combination

Access Communications	01376, 01877
Adams Cable TV	01376
ADB	01920
Armstrong	01376, 01877
Arris	02187
Atlantic Broadband	01877
ATMC	01376
Bend Broadband	02187
Blue Ridge Communications	01877
Bright House	01877, 01376
Buckeye Cable System	01376, 01877, 02187
Cable Axion Digitel	01376
Cable One	01376, 01877
Cablecom	01582
Cablevision	01877, 01376
Cablevision du Nord	01376
CCAP	01877
Charter	01376, 01877, 02187
Cincinnati Bell	01877, 01376

Cisco	01877, 02589, 01982, 01582, 01883, 02401, 03265
Citycable	03477
Cogeco	01376, 01877, 01982
Comcast	01376, 01877, 01982, 02187
Cox	01877, 01376
Darty Box	02436
Digeo	02187
Freebox	01976
Grande Communications	01877, 01376
Humax	02620, 02165
ImOn Communications	01877
Insight	01376, 01877
Inter Mountain Cable	01877
Kabel Deutschland	02165
Knology	01877
Mediacom	01376, 01877
MetroCast Cablevision	01877
Midcontinent Communications	01376, 01877
Motorola	01376
Moxi	02187
NET	01883
NorthwesTel	01376
Novus	01376, 01877
Numericable	02436
Pace	01877, 02620, 01582, 01883
Panasonic	01982
Philips	01582
Pioneer	01877
RCN	01376
Rogers	01877, 01376
Sagem	02436
Samsung	03477, 01877, 01987, 02589, 03265

Scientific Atlanta	01877, 01982, 01987, 02436, 02401
Service Electric	01376, 01877
Shaw	01376, 01877, 02187
SKY	02620
SKY Deutschland	02620
Source Cable	01376
Suddenlink	01877, 01376
Telenet	01920, 03477
Telewest	01987
Thomson	01582
Time Warner	01877, 01376, 02187
TiVo	03265
Unitymedia	03477
UPC	01582, 03477
UPC Cablecom	01582, 03477
Videotron	01877
Virgin Media	01987, 03265
Wave Broadband	01376
Western Iowa Telephone	01877
Westman Communications	01376, 02187
WideOpenWest	01877, 01376, 02187
Ziggo	02589

■ IPTV

ADB	02586, 01481, 01998, 03028
Alcom	02437
Altibox	02437
Amino	01615, 01481, 01898, 01998, 03028
Arkwest	01481, 01998
Arvig Communication Systems	01998, 02345

AT&T	00858
ATMC	01998, 03028
Ballard Rural Telephone Cooperative	02586
Bayland Communications	02586
Bell	01998
Bell Aliant	01998
Bell Fibe TV	01998
Bledsoe Telephone Cooperative	01481, 01998
Bloomington Communications	01481, 01998, 03028
Blue Valley Telecommunications	01898
Bouygues Telecom	03007
Brandenburg Telecom	01481, 01998
BT	02294
BTC Broadband	02586
Burlington Telecom	01481, 01615
Cabovis	02436
CalTel Connections	02586
Canby Telcom	01481
Cannon Valley Cablevision	01481, 01998
CenturyLink	01998
Cisco	00858, 03028, 02345, 02378
ClubInternet	02132
CoopTel	00858, 01615, 01898
CRST Telephone Authority	01481, 01998
Dakota Central Telecommunications	02345
Dalton Cable Television	01877, 01982
Delta Cable	01376
Diverse Communications	01898
Du	02401
Eagle Broadband	01481, 01998

Eagle Valley Telephone	01481, 01998
EasyTEL	01481, 01998, 03028
Echostar	03452
Etex	02586
Farmer's Telephone Cooperative	01998, 03028
Golden Belt Telephone	02586
Gorham Communications	01481
Griswold Cooperative Telephone	01481, 01998
GTI	01481, 01998, 03028
Harrisonville Telephone	02586
Hathw@y	02043
Horizon Cable TV	02586
Hotwire	02586
HTC Communications	01481, 01998
Innovative Systems	01898
Inotel	02437
Integra Telecom	02345
Interstate Cablevision	01481, 01998
JP PTT	01615
Kiss	02132
KM Telecom	01481
KoolConnect	01481
KPN	02952, 02437
Lakeland Cablevision	01481, 01998
Lemonweir Valley Telephone	01481, 01998
Liberty Communications	02586
Lonsdale Video Ventures	01481, 01998
Lumos Networks	01998, 03028
Manawa Telecom	02586
Manti Telecom	01481, 01998
Matanuska Telephone Association	01481, 02586
Meo	02401

MHTC	01481, 01998
Microwave Satellite Technologies	01481, 01998
Millennium Telecom	01481, 01998
Minburn Communications	01481, 01998, 03028
MM&G Enterprises	01481, 01998
Motorola	02378, 01998, 02437, 0858, 02952, 01376
Movistar	03288
MTS	01998
NDTC	01481, 01998, 03028
North Central Telephone	02345
North Dakota Telephone	02586
North State Communications	00858
Norvado	02586
Nsight	02345, 02586
NU Telecom	01998, 03028
Oi TV	03452, 03454
Open IPTV	01615
Optimus Clix	02437
Orange	02407
OTEC Communications	02586
Pace	02401, 03454
Panora Telecommunications	01481
Paul Bunyan Communications	02586
Pine Island Telephone	01481, 01998
Polar Communications	02586
Poplar Bluff Municipal Utilities	01481, 01998
Portugal Telecom	02401
Price County Telephone	01481, 01998

Project Mutual Telephone	01481, 01998
PSC	01998
Quality One Technologies	01481, 01998
Qwerty.TV	01898
Randolph Telephone	02586
Readlyn Telephone	02586
Reservation Telephone	01998, 02345
River Valley Telecommunications	01481, 01998
S-GO Video	01877
Sagem	02407, 03288
Sagemcom	02407
Samsung	02407
Sasktel	01998
Scientific Atlanta	00858, 02345, 03028
Silver Star Communications	01481, 01998, 03028
SingTel	01998
SKY Deutschland	02620
Skyline Cable	02586
SkyPix	01481, 01998
Smile Content	02437
Smithville	02586
Sogetel	01998
SureWest	01481, 01998, 02586
Surry Telephone	02586
SWAT Cooperative	01481, 01998, 03028
T-Home	02132
Telefonica	03288, 03028
Telus	03028
TeNeT	01898
Thomson	03007, 02407
TV Northeast	01481, 01998
TVB	01615
Twin Valley Communications	02586
United Telephone	02586

Venture Communications Cooperative	01998
Verizon	02378
Viken Fibernett	02437
Vivo	03288
Watch TV	01481, 01998
West Carolina Telephone	03028
Western Wisconsin Communications	02586
Westphalia Broadband	02586
Wilkes Telecommunications	01481, 01998
Yadkin Valley Telecom	02345

■ IPTV PVR Combination

ADB	02437
Altibox	02437
Amino	01615, 01898
AT&T	00858
ATMC	03028
Beeline	03028
Belgacom TV	02132
Bell	01998
Bell Aliant	01998
Bell Fibe TV	01998
Bouygues Telecom	03007
BT	02294
Cabovis	02436
CenturyLink	01998
Cisco	00858, 03028, 02132, 02345, 02378
ClubInternet	02132
Deutsche Telekom	02132
Du	02401
Echostar	03452
Freebox	01976
i-CAN	02437
Innovative Systems	01898

InviTV	02437
Kiss	02132
KPN	02952, 02437
Lumos Networks	01998
Magio Sat	02132
Magnet	01615
Meo	02401
Motorola	02437, 02378, 00858, 01998, 02952, 02401
MTS	01998
Numericable	02436
Oi TV	03452, 03454
Orange	02407
Pace	02401, 03454
Philips	02294
Portugal Telecom	02401
Sagem	02407, 03288
Sagemcom	02436, 02407, 03007
Samsung	02407
Sasktel	01998
Scientific Atlanta	00858, 02345, 02401, 03028
SKY Deutschland	02620
SureWest	01998
T-Home	02132
Telefonica	03028, 03288
Telus	03028
Thomson	03007
Verizon	02378
Vodafone	02401

■ PVR

DirecTV	20739
Humax	20739
Panasonic	20616
Philips	20739
RCN	20739
ReplayTV	20616
Sonic Blue	20616

Sony	20636
TiVo	20739, 20636

Integra®

Integra Division of

Onkyo U.S.A. Corporation

18 park Way, Upper Saddle River, N.J. 07458, U.S.A.

Tel: 800-225-1946, 201-818-9200 Fax: 201-785-2650

<http://www.integrahometheater.com>

Integra Division of

Onkyo Europe Electronics GmbH

Liegnitzerstrasse 6, 82194 Groebenzell, GERMANY

Tel: +49-8142-4401-0 Fax: +49-8142-4208-213

<http://www.integra.eu>

Integra Division of

Onkyo China PRC

1301, 555 Tower, No.555 West NanJin Road, Jin an, Shanghai,

China 200041, Tel: 86-21-52131366 Fax: 86-21-52130396

<http://www.integra.com.cn>

Integra Division of

Onkyo Corporation

Kitahama Chuo Bldg, 2-2-22 Kitahama, Chuo-ku, OSAKA 541-0041, JAPAN

Tel: 072-831-8023 Fax: 072-831-8163

<http://www.integraworldwide.com>

SN 29401777PDF_EN

(C) Copyright 2014 Onkyo Corporation Japan. All rights reserved.

D1404-0



* 2 9 4 0 1 7 7 7 *